



Safety light curtains and light grids



Prevent unsafe access to dangerous machinery or work areas

- Type 2 and Type 4 safety light curtains and grids according to IEC 61496
- Compact 28 x 30 mm housing profile for less intrusive mounting
- Up to 60 meter sensing range
- Light curtains offer protected heights of 160 mm to 1510 mm in intervals of 150 mm
- Light grids available in 2-, 3- and 4-beam versions

Curtains and grids help to protect plant personnel

ifm's safety light curtains and grids consist of an emitter and receiver pair that create a multi-beam barrier of infrared light in front of, or around, a hazardous area. When any of the beams are blocked by intrusion in the sensing field, the light curtain sends a signal to the machine's e-stop.

The compact, low-profile safety light curtains and grids can provide hand protection, body protection and body parts protection and are available in a Type 2 or Type 4 safety rating according to IEC 61496.

Single light grid used with mirror



ifm's active / passive light grids lower installation costs by reducing the amount of wiring required. The transmitter and receiver are contained in one housing (active element) and are used with a reflecting mirror (passive element). All electrical connections are made to the active element. This is very useful for applications where it is difficult to wire both sides of a light grid such as conveyors.

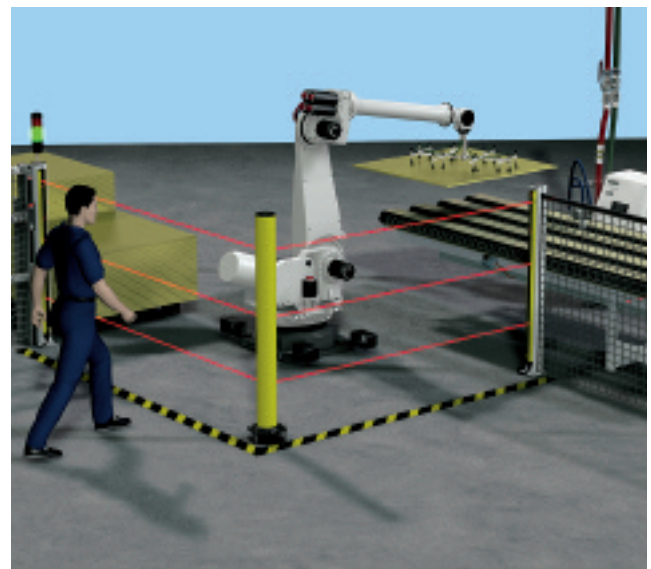

Light grids (shown here in a 3-beam version) protect the perimeter or boundary defined by a machine, robot or other equipment.

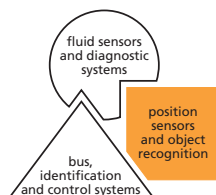

Compact housing, robust design

Front view

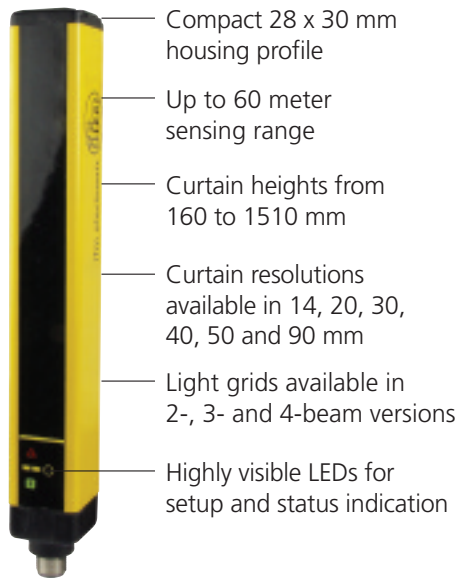

Back view

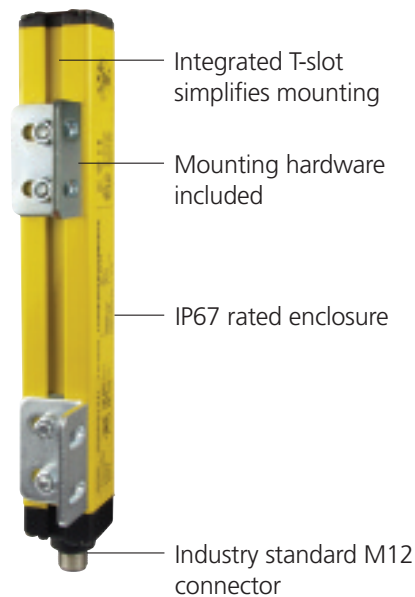

Applying safety light curtains and grids in the plant



Light curtains provide point of operation – hand protection

Light curtains can protect an operator from the hazards associated with material positioning on mechanical and hydraulic power presses, molding presses, stamping, forming, and automated assembly machines.



Light curtains offer perimeter guarding – body protection

To safeguard a larger area in a plant, light curtains can be placed horizontally along the floor to detect foot traffic of plant personnel. ifm's light curtains are designed to detect when an operator or passerby penetrates the perimeter of a hazardous zone. The perimeter safety light curtains will initiate a stop signal to the machine control.



Light grids provide access prevention – body protection

Light grids protect the perimeter or boundary defined by a machine, robot or other equipment. ifm's light grids can be used to detect the presence of personnel and signal the machine controller to stop while personnel are present within the area. If the area is to be protected from several sides, corner mirrors can be used.



Selection chart for safety light curtains



Safety light curtains for finger protection

		Type 4 / SIL 3 / PL e	
Resolution	Protected area height	Part no. (pair)	List price (USD)
Protected area width: 0...3 m / 1...6 m			
14 mm	160 mm	OY 001S	\$1358.00
	310 mm	OY 002S	\$1695.00
	460 mm	OY 003S	\$2032.00
	610 mm	OY 004S	\$2374.00
	760 mm	OY 005S	\$2715.00
	910 mm	OY 006S	\$3058.00
	1060 mm	OY 007S	\$3404.00
	1210 mm	OY 008S	\$3756.00
	1360 mm	OY 009S	\$4093.00
	1510 mm	OY 010S	\$4686.00



Safety light curtains for hand protection

		Type 2 / SIL 2 / PL d		Type 4 / SIL 3 / PL e	
Resolution	Protected area height	Part no. (pair)	List price (USD)	Part no. (pair)	List price (USD)
Protected area width: 0...4 m / 3...12 m					
30 mm	160 mm	OY 031S	\$608.00	OY 041S	\$1103.00
	310 mm	OY 032S	\$742.00	OY 042S	\$1329.00
	460 mm	OY 033S	\$876.00	OY 043S	\$1535.00
	610 mm	OY 034S	\$1010.00	OY 044S	\$1751.00
	760 mm	OY 035S	\$1133.00	OY 045S	\$1957.00
	910 mm	OY 036S	\$1339.00	OY 046S	\$2266.00
	1060 mm	OY 037S	\$1597.00	OY 047S	\$2524.00
	1210 mm	OY 038S	\$1854.00	OY 048S	\$2781.00
	1360 mm	OY 039S	\$2060.00	OY 049S	\$2987.00
	1510 mm	OY 040S	\$2266.00	OY 050S	\$3296.00
40 mm	160 mm	OY 051S	\$588.00	OY 061S	\$1036.00
	310 mm	OY 052S	\$711.00	OY 062S	\$1242.00
	460 mm	OY 053S	\$824.00	OY 063S	\$1422.00
	610 mm	OY 054S	\$927.00	OY 064S	\$1602.00
	760 mm	OY 055S	\$1030.00	OY 065S	\$1777.00
	910 mm	OY 056S	\$1216.00	OY 066S	\$2040.00
	1060 mm	OY 057S	\$1458.00	OY 067S	\$2261.00
	1210 mm	OY 058S	\$1700.00	OY 068S	\$2483.00
	1360 mm	OY 059S	\$1880.00	OY 069S	\$2658.00
	1510 mm	OY 060S	\$2060.00	OY 070S	\$2957.00
Protected area width: 0...10 m / 3...20 m					
20 mm	160 mm	–	–	OY 221S	\$1241.00
	310 mm	–	–	OY 222S	\$1547.00
	460 mm	–	–	OY 223S	\$1848.00
	610 mm	–	–	OY 224S	\$2149.00
	760 mm	–	–	OY 225S	\$2455.00
	910 mm	–	–	OY 226S	\$2762.00
	1060 mm	–	–	OY 227S	\$3073.00
	1210 mm	–	–	OY 228S	\$3384.00
	1360 mm	–	–	OY 229S	\$3685.00
	1510 mm	–	–	OY 230S	\$4220.00
30 mm	160 mm	–	–	OY 241S	\$1199.00
	310 mm	–	–	OY 242S	\$1424.00
	460 mm	–	–	OY 243S	\$1644.00
	610 mm	–	–	OY 244S	\$1869.00
	760 mm	–	–	OY 245S	\$2093.00
	910 mm	–	–	OY 246S	\$2317.00
	1060 mm	–	–	OY 247S	\$2547.00
	1210 mm	–	–	OY 248S	\$2783.00
	1360 mm	–	–	OY 249S	\$3001.00
	1510 mm	–	–	OY 250S	\$3465.00
40 mm	160 mm	–	–	OY 261S	\$1124.00
	310 mm	–	–	OY 262S	\$1343.00
	460 mm	–	–	OY 263S	\$1526.00
	610 mm	–	–	OY 264S	\$1710.00
	760 mm	–	–	OY 265S	\$1894.00
	910 mm	–	–	OY 266S	\$2077.00
	1060 mm	–	–	OY 267S	\$2272.00
	1210 mm	–	–	OY 268S	\$2460.00
	1360 mm	–	–	OY 269S	\$2645.00
	1510 mm	–	–	OY 270S	\$3067.00

The difference between safety light curtains and grids

Light curtains: Several beams of light spaced closely together (14 to 90 mm apart). Select light curtains for preventing unsafe access to dangerous machinery and work areas.

Light grids: A few beams of light (2, 3 and 4) spaced far apart (300 to 500 mm). Select light grids for perimeter guarding to prevent access to larger work areas.

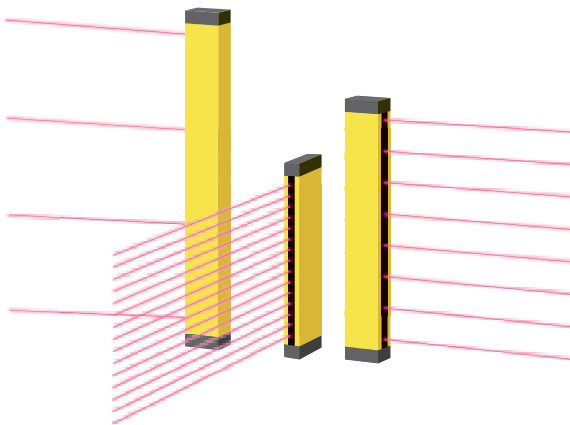



Selection chart for safety light curtains



Selection chart for safety light grids



Safety light curtains for body, body parts protection

Resolution	Protected area height	Type 2/SIL 2/PL d		Type 4/SIL 3/PL e	
		Part no. (pair)	List price (USD)	Part no. (pair)	List price (USD)
Protected area width: 0...4 m / 3...12 m					
50 mm	310 mm	OY 072S	\$691.00	OY 082S	\$1180.00
	460 mm	OY 073S	\$794.00	OY 083S	\$1350.00
	610 mm	OY 074S	\$897.00	OY 084S	\$1515.00
	760 mm	OY 075S	\$1010.00	OY 085S	\$1669.00
	910 mm	OY 076S	\$1185.00	OY 086S	\$1916.00
	1060 mm	OY 077S	\$1427.00	OY 087S	\$2122.00
	1210 mm	OY 078S	\$1669.00	OY 088S	\$2328.00
	1360 mm	OY 079S	\$1854.00	OY 089S	\$2478.00
90 mm	1510 mm	OY 080S	\$2035.00	OY 090S	\$2776.00
	610 mm	OY 094S	\$866.00	OY 104S	\$1401.00
	760 mm	OY 095S	\$969.00	OY 105S	\$1494.00
	910 mm	OY 096S	\$1154.00	OY 106S	\$1710.00
	1060 mm	OY 097S	\$1396.00	OY 107S	\$1885.00
	1210 mm	OY 098S	\$1638.00	OY 108S	\$2066.00
	1360 mm	OY 099S	\$1818.00	OY 109S	\$2189.00
	1510 mm	OY 100S	\$1999.00	OY 110S	\$2452.00
Protected area width: 0...10 m / 3...20 m					
50 mm	310 mm	-	-	OY 282S	\$1281.00
	460 mm	-	-	OY 283S	\$1445.00
	610 mm	-	-	OY 284S	\$1613.00
	760 mm	-	-	OY 285S	\$1781.00
	910 mm	-	-	OY 286S	\$1945.00
	1060 mm	-	-	OY 287S	\$2123.00
	1210 mm	-	-	OY 288S	\$2297.00
	1360 mm	-	-	OY 289S	\$2460.00
90 mm	1510 mm	-	-	OY 290S	\$2859.00
	610 mm	-	-	OY 204S	\$1465.00
	760 mm	-	-	OY 205S	\$1598.00
	910 mm	-	-	OY 206S	\$1735.00
	1060 mm	-	-	OY 207S	\$1873.00
	1210 mm	-	-	OY 208S	\$2027.00
	1360 mm	-	-	OY 209S	\$2159.00
	1510 mm	-	-	OY 210S	\$2521.00



Safety light grids for body protection

Number of beams	Distance between beams	Height	Type 2/SIL 2/PL d		Type 4/SIL 3/PL e	
			Part no. (pair)	List price (USD)	Part no. (pair)	List price (USD)
Protected area width: 0...4 m / 3...12 m						
2	500 mm	653 mm	OY 111S	\$716.00	OY 114S	\$1020.00
3	400 mm	953 mm	OY 112S	\$768.00	OY 115S	\$1185.00
4	300 mm	1053 mm	OY 113S	\$861.00	OY 116S	\$1391.00
Protected area width: 0...10 m / 3...20 m						
2	500 mm	653 mm	-	-	OY 120S	\$1082.00
3	400 mm	953 mm	-	-	OY 121S	\$1247.00
4	300 mm	1053 mm	-	-	OY 122S	\$1448.00
Protected area width: 8...30 m / 18...60 m						
2	510 mm		-	-	OY 951S	\$1266.00
3	810 mm		-	-	OY 952S	\$1431.00
4	910 mm		-	-	OY 953S	\$1632.00



Single light grids used with mirror

Number of beams	Protected area height	Protected area width	Type 4/SIL 3/PL e	
			Part no. (pair)	List price (USD)
Reflective				
2	510 mm	6 m	OY 901S*	\$760.00
3	810 mm	6 m	OY 902S*	\$1192.00
4	910 mm	6 m	OY 903S*	\$1324.00

* Must be used with corner mirror



Selection chart for mirrors and floor stands

Corner mirrors

Length	Use with		Part no.	List price (USD)
	light curtain	light grid		
250 mm	160 mm	N/A	EY 1001	\$258.00
400 mm	310 mm	N/A	EY 1002	\$294.00
540 mm	460 mm	N/A	EY 1003	\$325.00
715 mm	610 mm	2-beam	EY 1004	\$361.00
885 mm	760 mm	N/A	EY 1005	\$402.00
1060 mm	910 mm	3-beam	EY 1006	\$449.00
1230 mm	1060 mm	4-beam	EY 1007	\$495.00
1400 mm	1210 mm	N/A	EY 1008	\$541.00
1450 mm	1360 mm	N/A	EY 1009	\$588.00
1600 mm	1510 mm	N/A	EY 1010	\$773.00

Corner mirrors with integrated bases for easy mounting and simplified alignment

Type	Description	Part no.	List price (USD)
	For safety light curtains ≤ 460 mm and 2-beam safety light grids	EY 1011*	\$443.00
	For safety light curtains ≤ 1060 mm and 3 & 4-beam safety light grids	EY 1013*	\$541.00
	For safety light curtains ≤ 1360 mm	EY 1014*	\$675.00
	For safety light curtains ≤ 1510 mm	EY 1015*	\$1061.00
	Base unit	EY 2005	\$184.00

Floor stands for light curtains and grids with 28 x 30 mm profile

Type	Description	Part no.	List price (USD)
	For safety light curtains ≤ 760 mm and 2-beam safety light grids	EY 2001*	\$270.00
	For safety light curtains ≤ 1060 mm and 3 & 4-beam safety grids	EY 2002*	\$297.00
	For safety light curtains ≤ 1360 mm	EY 2003*	\$354.00
	For safety light curtains ≤ 1510 mm	EY 2004*	\$624.00
	Base unit	EY 2005	\$184.00

* Must be used with EY 2005 base unit.

Technical Specs – Light curtain and light grid

Operating voltage:	19.2...28.8 VDC
Current rating:	2 x 400 mA (OY9xxS: 2 x 500 mA)
Current consumption:	Transmitter 42 mA; Receiver 83 mA (OY90xS: 250 mA) (OY95xS: transmitter 125 mA, receiver 250 mA)
Safety outputs (OSSDs):	2 x PNP
Operating temperature:	+14...131 °F (-10...55 °C)
Protection:	IP 67 (OY9xxS: IP 65)
Connection:	M12; Transmitter: 5-pin; Receiver: 8-pin
Max. cable length:	100 m
Safety category:	
IEC 61496-1: 2004	Type 2 / Type 4
IEC 61496-2: 2006	Type 2 / Type 4
IEC 61508: 1998	SIL 2 / SIL 3
ISO 13849-1: 2006	PL d / PL e

Light curtain and light grid dimensions (mm)

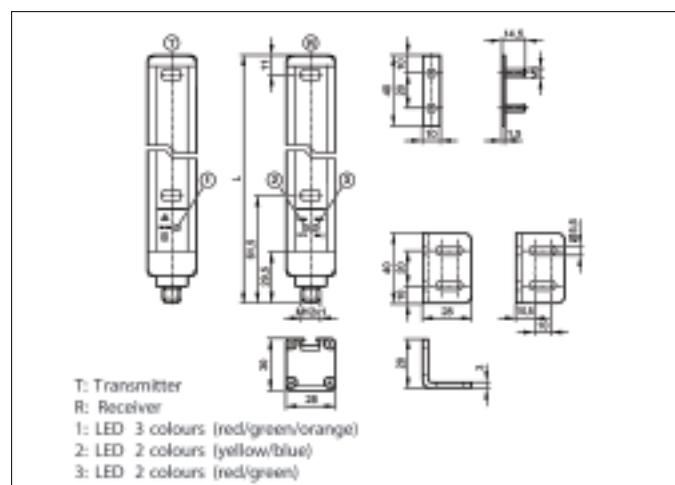

Light grid dimensions for OY9xxS (mm)

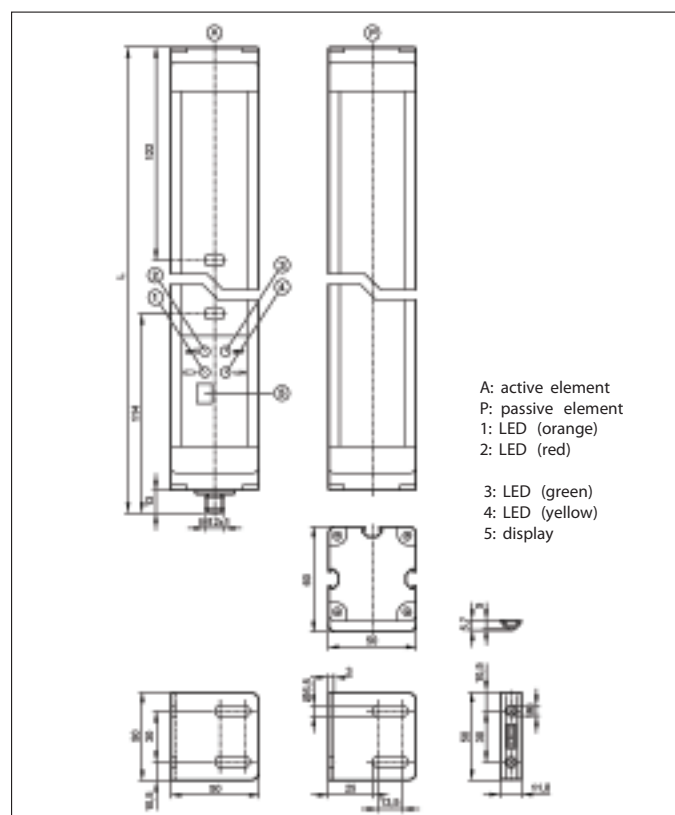











Safety relays

ifm offers two types of safety relays that interface with light curtains and grids. The safety relay G1501S provides different connection possibilities for safety light curtains and grids, fail-safe inductive sensors or other ESPEs. The safety relay G2001S is available for external muting applications with light curtains and grids. The safety relays meet the highest requirement with SIL 3 (IEC 61508).







Relay selection

Type	Description	Part no.	List price (USD)
	Safety relay, multifunctional, 2 safe N.O. relay outputs	G1501S	\$166.00
	Safety relay, multifunctional, 3 safe N.O. relay outputs, without time delay 2 safe N.O. relay outputs, with time delay	G1502S	\$268.00
	Safety relay, multifunctional, 2 safe N.O. solid state PNP outputs	G1503S	\$155.00
	Safety relay, 2 relay outputs, muting function	G2001S	\$474.00





Optional accessories

Type	Description	Part no.	List price (USD)
	Vibration damper for mounting, set of 4 pcs., rubber, galvanized metal	EY 3001	\$37.00
	Vibration damper for mounting, set of 6 pcs., rubber, galvanized metal	EY 3002	\$57.00
	Adjustable brackets, set of 4 (for light curtains ≤ 1060 mm)	EY 3004	\$36.00
	Adjustable brackets, set of 6 (for light curtains ≥ 1210 mm)	EY 3005	\$49.00
	Rotatable breaker ± 90°, set of 4	EY 3011	\$129.00

Cordsets for transmitters

Type	Description	Part no.	List price (USD)
	Socket, M12, 2 m, 5-pin, PUR	EVC 070	\$14.00
	Socket, M12, 5 m, 5-pin, PUR	EVC 071	\$17.00
	Socket, M12, 10 m, 5-pin, PUR	EVC 072	\$22.00
	Socket, M12, 2 m, 5-pin, PUR	EVC 073	\$14.00
	Socket, M12, 5 m, 5-pin, PUR	EVC 074	\$17.00
	Socket, M12, 10 m, 5-pin, PUR	EVC 075	\$22.00

Cordsets for receivers

	Socket, M12, 5 m, 8-pin, PUR	E 12166	\$46.00
	Socket, M12, 10 m, 8-pin, PUR	E 12167	\$58.00
	Socket, M12, 5 m, 8-pin, PUR	E 12168	\$46.00
	Socket, M12, 10 m, 8-pin, PUR	E 12169	\$58.00