



ASCE Charles Pankow Foundation Architectural Engineering Student Competition
Team Registration Number **05-2013**

Our team submitted designs in the following categories:

Building Integration Design
Structural Systems
Mechanical Systems
Lighting/Electrical Systems
Innovative Construction Management and Construction Methods

Executive Summary

This report details the lighting/electrical system of our team's elementary school design for submission in the 2013 ASCE Charles Pankow Foundation Architectural Engineering Student Competition. The elementary school was designed through an integrated approach, which allowed factors affecting the lighting/electrical system to be addressed by the entire project team.

The lighting/electrical design can be summarized by the following statements:

- Combined heat and power (CHP) is utilized with four (4) 65 kW on-site natural gas microturbines, totaling 260 kW peak electric power and 1,100 MBH of peak collectable waste heat.
- School is designed to apply for LEED Gold under LEED 2009 for Schools New Construction and Major Renovations. Energy models predict that the building uses 29% less energy than the ASHRAE 90.1 2007 Appendix G Baseline model and is anticipated to receive an EnergyStar Rating of 85.
- Lighting design that is cost effective and easy to maintain while still remaining visually interesting and comfortable as a school and as a community center.
- Reliable power system with available off-grid electric generation (microturbines) for the safe and effective function of the building as a natural disaster shelter.
- Multi-tiered 24/7 security system to prevent possible threats to school children and aid the building staff in maintaining a safe environment for the community.

Table of Contents

Lighting/Electrical Narrative

Building a Better Community	2
Lighting Design	3
Electrical Design	9
Fire Alarm Design	13
Telecom Design	14
Codes and Standards	15

Supporting Documentation

Daylighting Analysis	16
Lighting Analysis	19
Controls	24
Electrical Load Tabulation	25
SKM Electrical System Analysis	26
Electrical Equipment	29
Lighting Fixture Schedule	31
Lighting Equipment	32
Drawings Legend	34

Drawings

Mech/Elec Integration Overview	E1
Basement Lighting Plan	E2
1 st Floor Lighting Plan	E3
2 nd Floor Lighting Plan	E4
3 rd Floor Lighting Plan	E5
Basement Power Plan	E6
1 st Floor Power Plan	E7
2 nd Floor Power Plan	E8
3 rd Floor Power Plan	E9
Riser Diagrams	E10

Building a Better Community

In 2011, *The New York Times* ranked Reading as the poorest city in the United States on the basis of having the largest percentage of its population living in poverty. This affects not just the wellbeing of the people living in Reading but also the future by not having proper educational experiences during their childhood.

The mission of the Charles Pankow Foundation is “to advance innovations in building design and construction, so as to provide the public with buildings of improved quality, efficiency, and value”. The 2013 ASCE Charles Pankow Foundation Student Competition forwards this mission by challenging students to use an integrated design method to create a high-performance elementary school located in the urban setting of Reading, Pennsylvania.

Project Goals

Using an integrated design, we as a group formed these three core values. Our team's core values would then be the basis of what drove decision making throughout the design process.

1. Build a better Reading community through construction and implementation of the school program
 - Select lighting/electrical systems that will aid in the enhancement of the school as a center for learning as well as a multi-purpose community facility
 - Create a safe secure building and site for such activities
2. Design the elementary school to high-performance standards
 - Low maintenance system that is highly efficient and environmentally conscious
 - Lighting design to stimulate curiosity amongst the students
3. Utilize an integrated design approach to maximize quality, efficiency, and value of the final built product
 - Flexible design that acknowledges future uses and expansion
 - Integration among construction, structural, mechanical, & lighting/electrical disciplines for superior project delivery
 - BIM based design for better analysis and engineering of systems

Lighting Design

Concept

Elementary schools are the first institutions where children receive their academic learning. Using light to demonstrate playfulness throughout the building will align to children's fascinations. People are naturally drawn to more complex objects and brighter light. Through the incorporation of shapes, hidden light sources, and varying light intensities, this design will invoke curiosity and stimulate deeper thinking outside the classroom to complement their education. By creating visually interesting and comfortable spaces, it will encourage children to attend classes. By student's increase in attendance, it will help develop critical thinking skills and further boost grades which could potentially help Reading receive more aid from the government, thus helping the community grow.

Typical Classroom

Classrooms today are the prominent areas where students' minds are molded to be productive members of society. Through the incorporation of radiant cooling drop panels simulating dropped ceilings, flat surfaces were provided to reflect light. Pendant fixtures centered underneath the panel were selected to uniformly illuminate the classroom to IES recommendations.

	Horizontal Illuminance	Avg/Min	LPD
Target	30 FC	2.5	1.4
Design	27.82 FC	2.44:1	0.83

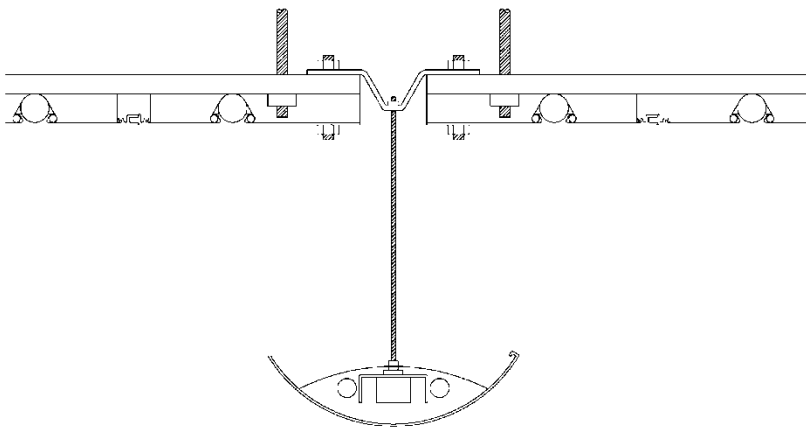

Figure 1: Mounting Details

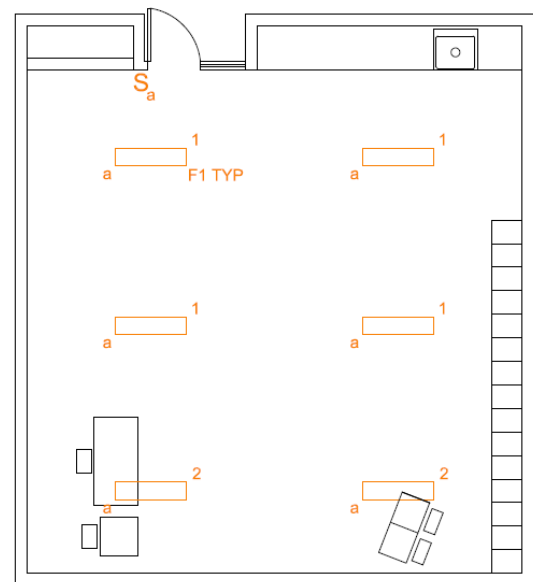

Figure 2: Example of Typical Classroom RCP.
1 denotes Non Dimmed Zone, 2 denotes Dimmed Zone

A distance of 8.5' AFF, 1.5' below the radiant cooling panels, was chosen to negate hot spots, see Figure 1 for mounting details. For more information regarding constructability refer to the construction's report drawings, CM-003. An efficient semi-indirect pendant was chosen to provide indirect lighting. Indirect lighting provides more uniform ambient light in the classroom, no casted shadows, and no glare sources to create a more comfortable learning environment for the students.

The fixture selected implements T5HOs due to their high luminous efficacy, long lamp life, ability to dim, and efficiency of delivering lumens to the work plane. Additionally, programmed rapid start ballasts connected to both lights were chosen to reduce the number of ballasts and preserve the cathodes which will improve the lumen maintenance as the fixtures will be controlled with an occupancy sensor (See Controls). Some of the pendants found in the classroom will be on emergency circuits to provide the necessary illumination to allow students to safely evacuate the school.

Daylighting

An important feature of the classroom is the ability to incorporate natural daylight into the learning environment. A highly transmissive window (75%) with a SHGC of 0.29 was selected to maintain a view to the exterior and maximize the amount of “free” light to come into the space. Having the ability to dim the lights with increasing daylight penetration allows for more uniform lighting, and energy savings. This contributes to decreasing the life cycle cost of the building and creating a more comfortable learning environment.

Direct sunlight is not typically desirable as it increases the temperature of the rooms which increases the mechanical load and creates glare source. The effects from daylight can be disruptive to the learning environment. Incorporation of overhangs on the south façade decreases the amount of direct sunlight that reaches the windows during part of the heating season, see Figures 3 and 4. Additionally, the overhangs extend 3’ beyond the windows to block low angle sun from penetrating underneath the overhang during early mornings or late afternoons.

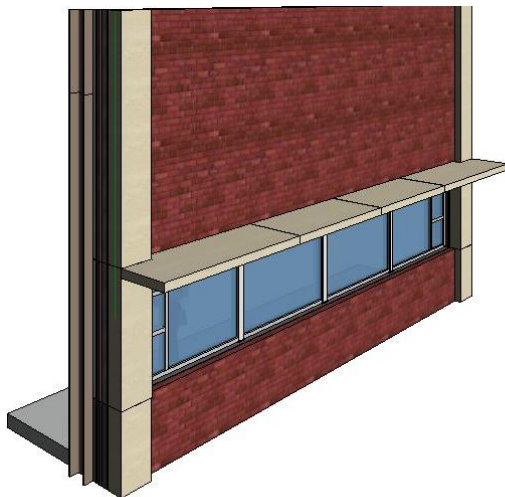

Figure 3: 3D Perspective South Façade Prefabricated Section

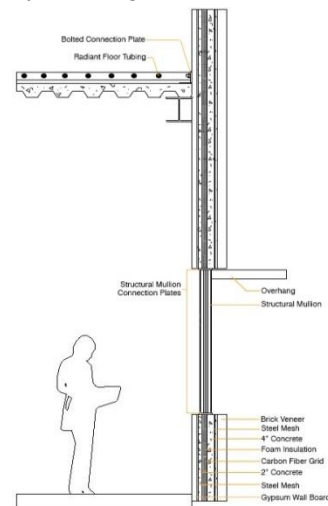

Figure 4: Section South Exterior Facade

During the times where the overhangs do not protect against direct sunlight or when the teacher would like a darker room to create higher contrast, shades can be pulled down to decrease the contribution of daylight in the space. This provides the teacher with flexibility to control the lighting in the room to enhance the learning demonstrations. A darker shade was selected to minimize the sun as a glare source but still allow for a visual connection to the exterior. For a more in-depth analysis, refer to pages 16 to 18 of the supporting documents.

Controls

The ability for a teacher to control the light in the space is critical to the learning environment. The design creates flexibility for the teacher to enhance the learning environment. For more information, refer to page 24 for the wiring configuration. The first row of fixtures closest to the window will be dimmable. A closed loop proportion algorithm was selected to provide smooth transition of the dimming lights. Occupants will not notice the change in light levels as the lights will dim proportionally with increasing daylight to maintain the desired illuminance in the

classroom, providing greater visual comfort. Additionally, the teacher will also have the ability to dim the fixtures at their own discretion. This will override the photocell allowing for continuous dimming throughout the classroom.

The spaces are large enough to require two passive infrared occupancy sensors to turn off the lights within 15 minutes of people leaving the space. This will decrease the electricity bill for the school and increase lamp life thus improving lumen maintenance. One of the occupancy sensors is placed by the whiteboard to detect any movement within the classroom as soon as someone enters the space and the second one is located along the backwall. The lights will turn on to 50% light output upon entering the space and the occupants will have the ability to switch the lights to full output if desired. The transition of the light levels in the corridor to the classroom with ample daylight could negate the need for lights to be at maximum output thus allowing for additional energy savings.

Circulation Areas

Corridors in elementary schools serve multiple purposes. They are not just circulation space but areas where students can showcase their classwork that is available to be seen by other students, teachers, and the community for night time art exhibits. The acknowledgement of students work to the public encourages students to develop their creativity.

The Reading School District Strategic Plan acknowledges that bullying is a major issue in their schools. Using light to illuminate the surfaces of the corridors creates a feeling that the space is bigger than it actually is. A bigger space gives the perception that visibility is increased, allowing the teaching staff to see more activity that occurs during high traffic times. The design creates a feeling of safety. The ability to allow students to feel safe in the corridors helps focus their attention to achieving learning objectives. Another advantage of using higher light levels is that the adaptation difference as the light levels are more similar to the classroom light levels, see pages 19 to 21 for verification of light levels. This will help avoid the corridors feeling dim and smaller.

	Horizontal Illuminance	Max/Min
Target	15 FC	3:1
Design (1 st Floor)	16.37 FC	2.65:1
Design (2 nd Floor)	18.19 FC	1.91:1
Design (3 rd Floor)	16.64 FC	1.68:1

At the center of the designed building is a main lobby on each floor. At these points, shapes are created within the ceiling through coves, see Figures 5-7. These are points to create visual interest as the definition of the building alters. Students will have the ability to recognize the changes and discover the source of light. The indirect lighting creates uniform ambient light which contributes to the perception of easy visibility amongst the students. The diffuse light also provides minimal shadows. The fixtures hidden through coves also allow for easy maintenance since they can be easily reached. The coves are also designed tall enough to block the light sources to not be seen from view to avoid glare sources and encourage curiosity amongst the students.



Figure 5: 1st Floor Lobby Rendering

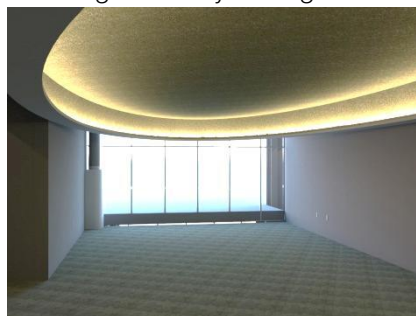

Figure 6: 2nd Floor Lobby Rendering

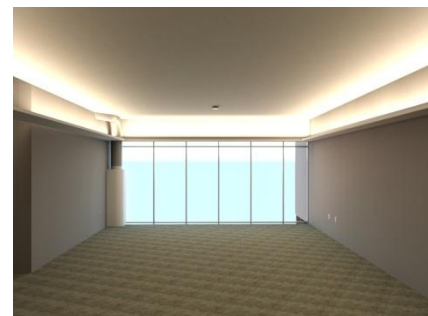

Figure 7: 3rd Floor Lobby Rendering

Multi-Purpose/Gym

At this Reading Elementary School, the gym serves as a cafeteria and auditorium and is lit accordingly.

	Horizontal Illuminance	Max/Min	LPD
Target	50 FC	3:1	1.4
Design	47.04 FC	2.78:1	0.92

Since multiple different sporting events can occur in this gym during physical education classes or community activities, the room is lit uniformly. Basketball, kickball, wiffleball, and other activities are multi-directional aerial sports and the design illuminates the room properly to allow individuals to see each other as well as the ball in the air. The design allows spectators to see all action that occurs in the space.

High-bay fluorescents are used to evenly illuminate the space. They have a direct distribution to emit light onto the floor surface. They are mounted to the underside of the truss for easier conduit runs to power the fixtures, see Figure 8. This allows for quicker installation which saves the school money on initial cost. Additionally, the design provides a cost effective, clean, visually pleasing design for occupants within the space. Since multiple aerial sports occur within the gym, there is a chance that the fixtures could be struck by an object. To avoid the fixtures or lamps breaking, an impact resistant acrylic lens was chosen to protect the lamps and fixture.



Figure 8: Gym Rendering

The high bay fluorescent fixtures specifically implement T5HOs. They have high luminous efficacy, great optical control, and ability to dim. Using T5HOs in the gym also reduces the different number of lamp types, which creates easier service for the maintenance team. Additionally, mounting to the bottom of the structure creates a more sturdy connection as the fixture will not move or swing as the maintenance team relamps the fixture and allows for power lines to run above the bottom cord of the truss.

Emergency

During typical emergencies, some of the fixtures will be on emergency circuits in accordance with (site code) to meet the minimum illuminance necessary for people to exit the building within a 90 minute period. The gym is designed to act as a shelter in case of a natural disaster for people living in the surrounding area. Some of the fixtures in the gym will be connected to a separate emergency circuit in order to provide comfortable uniform light, see page 22, while people are taking refuge in this space, see Sheet E4.

	Min Horizontal Illuminance	Max/Min	Avg/Min
Target	4 FC	10:1	2:1
Design	5.3 FC	3:17	2:1

Daylighting

Since the gym could be a potential shelter if necessary, clerestory windows are added to the north side. The area of the windows was determined to take advantage of diffused light and avoid glare. The window sizes were chosen to allow for a connection to the exterior and not cause any distractions or injury during sporting events due to visual uncertainty.

The sky on the north side could still potentially be a glare source when a presentation or assembly is occurring in the gym. A darker space could be desired. Manually operated shades controlled remotely can lower to decrease the daylight penetrating into the space.

Controls

The first column of fixtures closest to the windows will be circuited on a dimmed zone. A closed loop constant proportion algorithm was selected to provide smooth transition of the dimming lights as more daylighting enters the space. Occupants will not notice the change in light levels as the lights will dim proportionally with increasing daylight to maintain the desired illuminance in the gym providing uniform light across the space.

Additionally, the highbay fluorescents are specified with an occupancy sensor attached to each fixture allowing for a cost effective design. This infrared occupancy sensor was selected to turn off the lights within 15 minutes of people leaving the space. It will detect people entering the space quicker than an ultrasonic occupancy sensor due to the size of the gym. The implementation of a photosensor and occupancy sensor will decrease the electricity bill for the school and increase lamp life thus improving lumen maintenance.

Theatrical Design

As previously mentioned, the gym can serve as an assembly space or for plays as well. Ceiling mounted downlights are implemented over the stage. A row of fixtures are placed in front of the curtain for functions where the full stage is not required. Additionally, wall sconces will be placed along the walls to provide ambient light for the audience. The sconces will be mounted above the required mounting height for ADA compliancy as well as protected in a cage.

Exterior

Site lighting will be designed in compliance with IES recommendations as specified with the Pennsylvania Lighting Ordinance. The fixtures are specified with a full cutoff as to limit urban sky glow. As the pool is open during the night after school hours, safety is a major issue. The design permits safe traveling from the parking lot to the building. Additionally, to avoid promotion of trespassers around the facility at night, the fixtures will be dimmed down to 50% light output after 11:00 pm. The mounting height will be no greater than 20' above the finished grade as well to limit light trespass.

Natatorium

The Reading Community requested the designers to look into the possibility of adding a six lane, twenty-five meter wide pool accessible to the community into the design. The design constructed the pool underneath the gym as the most cost effective and integrated solution; more detail can be seen on page 5 of the construction report. The inclusion of the pool provides the community with another public space and has the ability to be used as a learning tool to teach students at a young age how to swim.

A major concern with implementing the pool underneath the gym is to avoid a cave-like feeling. Clerestory windows are added along the west side to maintain a connection with the exterior for a comfortable environment, see Figures 9 and 10. Additionally, the minimum pool height as suggested by the Olympic Swimming Guidelines was designed to reduce the cost of excavation. By doing so, this creates a short, wide space. Indirect light fixtures to illuminate the ceiling from the sides of the pool were chosen to make the space feel taller and uniformly illuminate the pool with diffuse light. The light-truss is hung below the structure and does not interfere with the mechanical ducts. The use of the light truss was implemented as it can be custom tailored to any design and successfully achieves the design goals. It provides flexibility for more light sources to be added easily at a later date if desired but currently the design is in accordance with recommendations with IES for a type 3 pool, see page 23 for verification of light levels.

	Horizontal Illuminance	Max/Min	LPD
Target Pool	30 FC	3:1	1.4
Design Pool	34.23 FC	1.43:1	0.53
Target Deck	10 FC	4:1	-
Design Deck	24.87 FC	3:1	-

Additionally, the indirect lighting from the light-truss prevents glare sources allowing a lifeguard to easily see directly to the bottom of the pool in case of an emergency. Maintenance cost is drastically reduced as there are no fixtures over the pool. The pool will not need to be drained, decreasing the time it takes to relamp fixtures. The light-truss is ordered pre-wired and pre-aimed reducing time of installation which in turn reduces initial cost of construction.



Figure 9: Outdoor Garden Rendering



Figure 10: Pool Rendering

The light-truss is specified using T5HOs. They have high luminous efficacy, and great optical control. Using T5HOs in the pool also reduce the different number of lamp types which creates easier service for the maintenance team. The indirect fixture in the light truss is protected from any objects that may strike it from activities that occur in the pool.

Electrical Design

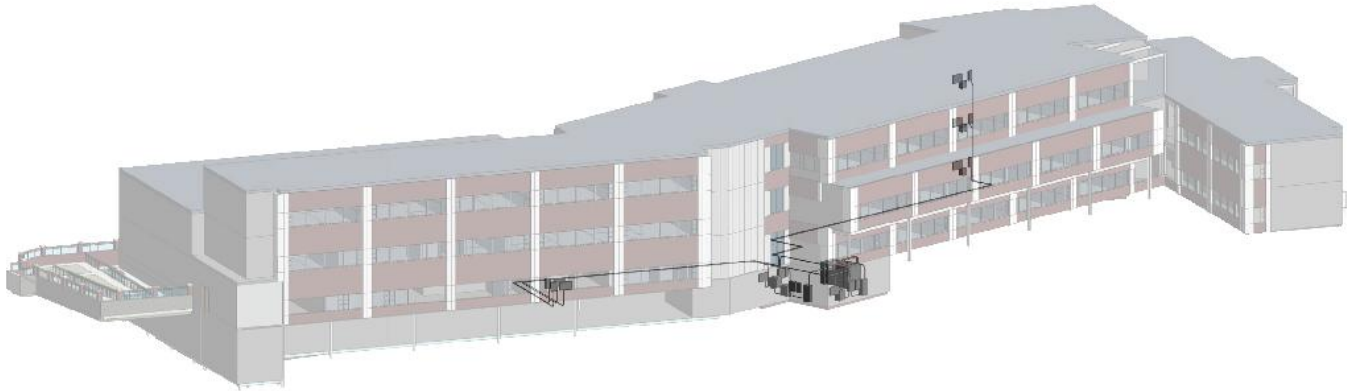

Figure 11: 3D Representation of Electrical System within Building

Distribution

The school's electrical system will consist of three-phase 480/277V power and three-phase 208/120V power. The incoming utility feed is assumed to be three-phase 4,160 Volt. This incoming feed enters the building from the Park Avenue side of the building running parallel with the natural gas, water, and telecommunications utilities. The service terminates in the building's main electrical room which is centrally located in the basement level. At the unit substation which consists of a main service breaker-disconnect, a 750 kVA delta-wye transformer, secondary breaker, and secondary switchgear distribution section, the main service is stepped down from a three-phase 4,160V delta to a 480/277V wye configuration. From here the system splits into the building's three main power branches – life safety, emergency, and normal. The life safety branch will carry all loads deemed necessary for the protection of human life. The emergency branch will carry all loads that are necessary for safe and reliable operation of the school as an emergency natural disaster shelter. Supplying standby power for the life safety and emergency branches will come from four Capstone 65kW natural gas microturbines, which will be discussed later in this document. Please see the attached electrical riser diagram for a more detailed organization of the electrical system. The preliminary sizing for all equipment was based on a tabulation that can be found on page 25 of the supporting documents and also details of this equipment can be seen on pages 29-30.

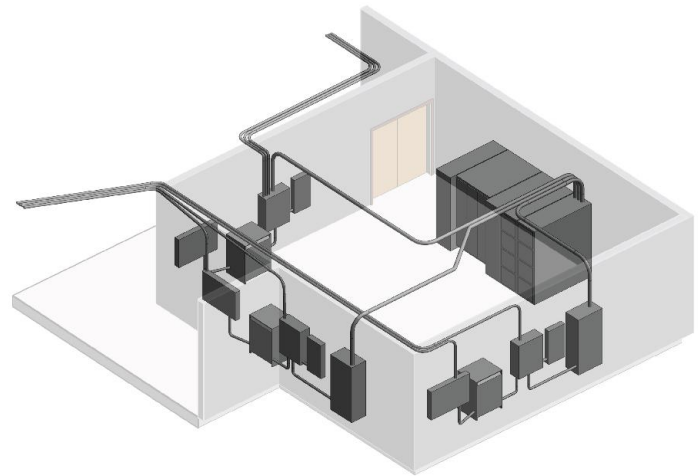

Figure 12: BIM Model of Main Electrical Room

Equipment Layout

As mentioned before, the unit substation will be located in the building's main electrical room in the basement level. Also, this room will house the main distribution panels for each of the three power branches – life safety, emergency, and normal. The automatic transfer switches for the life safety and emergency branches will be located here as well. Finally, each branch will be provided with a 480/277V lighting panel, transformer, and 208/120V double-tub receptacle panel in the main electrical room.

On floors 1, 2, and 3, the normal power branch will have a dedicated closet that will hold a 480/277V lighting panel, a 45 kVA transformer, and 208/120V double-tub receptacle panel. For these closets it was calculated to be more cost effective to transform power in the closets beside the panels as compared

to housing a larger single transformer in the main electrical room. Also by doing this, it significantly lowers the available fault current to the 208/120V receptacle panels making it a safer design.

On the 1st floor, a closet beside the kitchen and gym area will provide space for a 480/277V lighting panel and 208/120V receptacle panel for the life safety and emergency branches.

For exact locations of these spaces and equipment, please see the attached electrical drawings.

Cogeneration

In part of a collaborative effort with the mechanical engineers, the school will be outfitted with four Capstone 65kW natural gas microturbines to reduce the amount of electricity consumed from the Reading, PA electric grid. The waste heat created from these microturbines will be utilized in mechanical processes producing an overall system efficiency of 80-90%, whereas the typical efficiency of an electric utility system is around 30%. The use of combined heat and power (CHP) from the microturbine will reduce the operating costs of the school during cogenerating hours and is much cleaner on the environment. The scale of that cost reduction is dependent on ambient running conditions, microturbine part-load efficiencies, and schedule of operation.



Figure 15: Image of Parallel Capstone Microturbines

Also as mentioned before, the microturbines will act as the building's source for emergency backup power. The microturbines also have the ability to run on low pressure gases. On-site, an existing underground concrete vault will house a propane storage tank to act as an emergency fuel source should the natural gas utility be compromised. The tank will store enough fuel to power the microturbines for 72 hours.

Heating Load Integration

Cogeneration is viable in our school design because the school has some significant year-round heating loads used for heating the pool and supply air reheat. A more detailed breakdown of how the waste heat is utilized can be found in the Mechanical report.

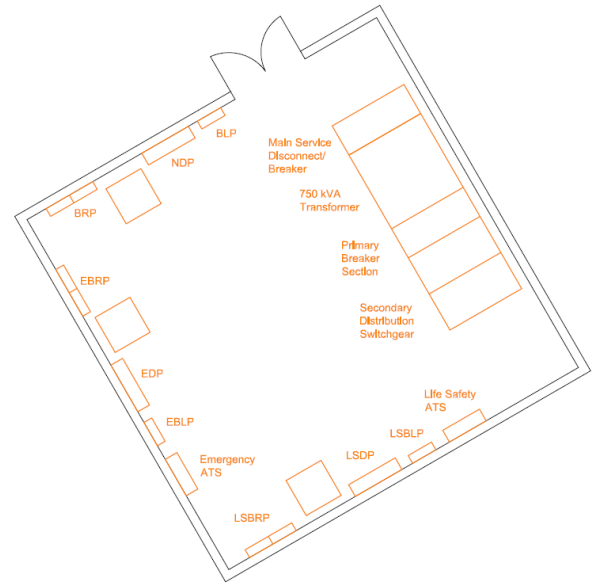

Figure 14: Main Electrical Room Layout

Calculating Cost Savings

Microturbine Efficiency and Capacity

Manufacturer catalogs claim the microturbine can get up to 85% efficient with the collection of waste heat (See the Capstone Microturbine product sheet in Mechanical Supporting Documentation for information on this product). However, this efficiency seems rather high for typical conditions. Our design team calculated our own assumed microturbine efficiency for determining energy savings:

Table: Assumed Microturbine Efficiency

Process	Efficiency (% of Energy Input)	Notes
Electric Production	29%	Per Capstone Microturbine product sheet
Collectable Waste Heat	36%	After electric conversion, our design team estimates we will be able to recover half of the heat from the exhaust gas (without installing a very large heat exchanger)
Total	65%	Assumed efficiency for energy savings calculations

Assumption of this overall microturbine efficiency results in the following cogeneration plant capacity.

Table: Elementary School Cogeneration Plant Capacity at Full Load

Natural Gas Input (MBH)	Electric Power Generation (kW)	Collectible Waste Heat (MBH)
3068	260	1,100

Operation and Cost-Savings

The team created an hourly demand load model for a typical day in every month of the year, modeling both building electric demand and heating demand. The model was made in Microsoft Excel. From that model, microturbine operation was assessed to determine a preliminary schedule and run-times for each of the four microturbines in the plant. Graphical representation of the model is sampled below, and graphs for all months are included in the Mechanical Supporting Documentation. It was estimated that \$50,000 worth of energy savings per year were reasonably achievable with this system. Also, should any excess electricity be produced, it can be sold back to the utility grid. In the state of Pennsylvania, there are many grants and incentives that the district could apply for to help pay for this system. Without any government assistance, the team calculated that the units could be paid off in 10 years. More analysis of the cogeneration life-cycle costs can be found in the Mechanical and Construction reports.

Legend:

Blue = Electric demand

Red = Building heating demand

Green = Electric generation from microturbine

Purple = Waste heat from microturbine

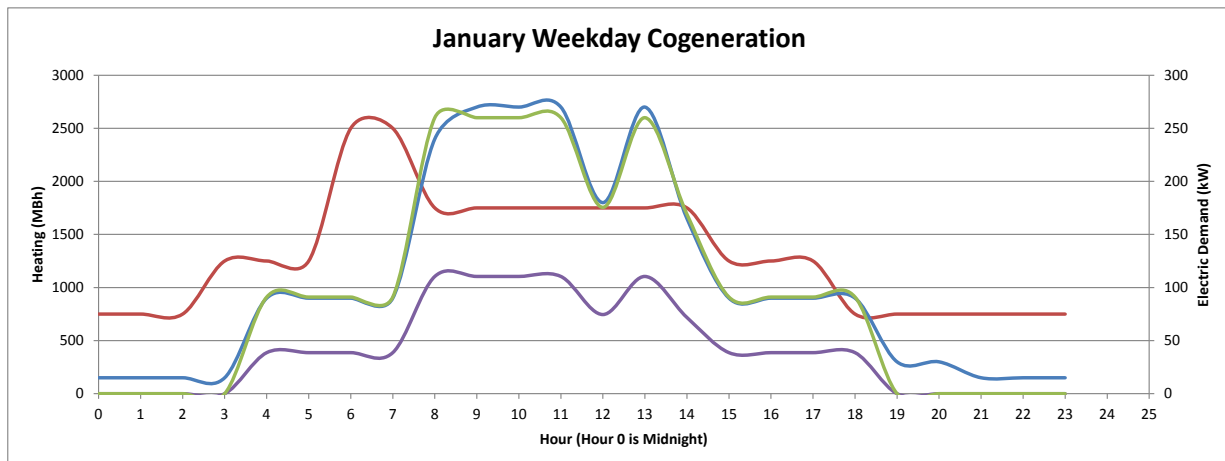

Figure 16: Predicted School Electric and Heat Loads Matched with Microturbine Operation

Typical Classroom Power

The power layout of a typical classroom will be convenient and allow for the emerging growth of technology in the educational setting. The front teaching area will hold a SmartBoard with an integrated projector as well as standard white boards straddling both sides of the Smart Board. A duplex receptacle and data outlet will be provided at 90" AFF for this unit. Three duplex receptacles will be mounted below the teaching boards at 18" AFF for use by the instructor. Shallow depth floor boxes coordinated with the underfloor radiant heating system will provide power/data connections for the instructor's desk and also the two student computers near the back of the room. A GFCI receptacle will be located 6" above the counter at the sink as required by the National Electric Code. A duplex receptacle at 18" AFF will be located at the back of the room along with a multioutlet raceway system that will act as a charging station in anticipation of the various technologies that could be brought into the classroom. All receptacles in classrooms will be specified as tamper-resistant for the safety of students.

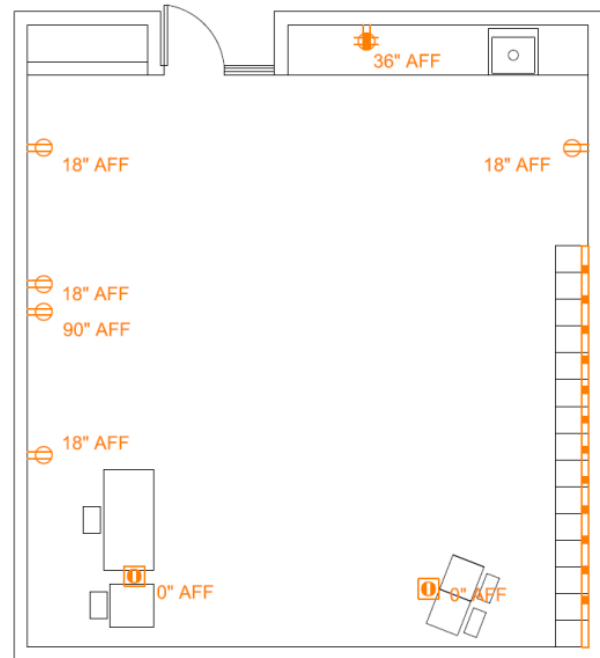

Figure 17: Classroom Power Layout



Figure 18: View Looking Towards Front of Classroom



Figure 19: View Looking at Back of Classroom

Emergency Power

As mentioned before, the elementary school will serve as a natural disaster shelter for the surrounding community. The multi-purpose gym space will serve as the primary refuge space for local citizens. This was designed structurally, mechanically, and electrically to serve and house up to 200 people. Also, the school kitchen will be designated as part of the shelter space to help provide food to shelter occupants. All lighting and electrical loads between these spaces will be served from the emergency branch of the building's power system. To reiterate, this branch is backed up by the building's four 65kW microturbines so that in the case of electric utility failure, power can be generated on-site to serve these loads as well as life safety loads. In the case of the natural gas utility also failing, the cogen system will be backed up by underground storage tank containing propane. Enough fuel will be stored to run the system for a minimum of 72 hours.



Fire Alarm Design

The fire alarm system implemented for the school will follow the NEC 2011 and NFPA 72 standards for the design and installation of detection and signaling equipment. The system will be connected to the building network as well as the local municipality network to quickly notify fire departments of any events that should arise. See the attached fire alarm riser diagram and electrical floor plans for a detailed view of the fire alarm system.

Major Equipment Locations

The main fire alarm control panel (FACP) will be located in the main electrical room in the basement level. Floors 1, 2, and 3 will be allotted a terminal cabinet (FATC) in the telecom room of each floor due to the central building location and close proximity to the building backbone data system. An annunciator panel will be located in the front entrance vestibule to provide system feedback to fire-fighting crews.

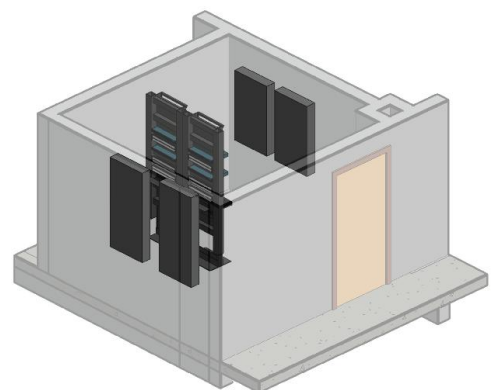

Figure 20: BIM model of Typical Telecom Room

Device Locations

In accordance with NFPA standards, smoke detection devices will be placed in hallways, mechanical/electrical/telecom rooms, and in the mechanical system at proper distances and coverage areas. Other devices such as manual pull stations will be placed at each stairwell and building egress point. Notification devices such as speaker/strobe combination units will be placed in each classroom and throughout the school with the sizing of such according to code.

Telecom Design

The telecommunications system provided will follow the NEC 2011 and ANSI/TIA/EIA standards for installation and design. For a further detailed view of the telecommunications system, please see the attached telecom riser diagram and electrical floor plans.

Major Equipment Locations

Floors 1, 2, and 3 will each provide a 12' x 12' room dedicated to telecommunications. These rooms were chosen because of their central location within the building and the distance limitations of the horizontal cabling. The 1st floor telecom room will house the main distribution frame with intermediate distribution frames being located in the 2nd and 3rd floor rooms. Also housed in these rooms will be the fire alarm terminal cabinets as mentioned before and also the security data gathering panels (SDGP) which will feed the school security system.

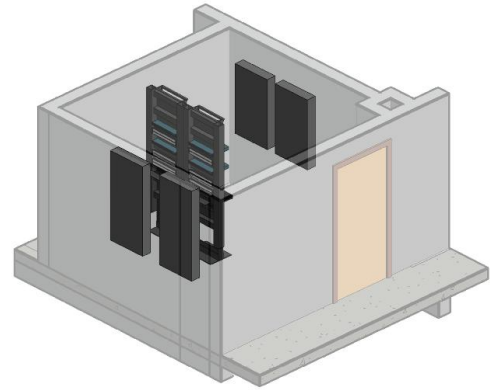

Figure 21: BIM model of Typical Telecom Room

Device Locations

All horizontal cabling in the school shall be Category 6 (CAT6) throughout. The horizontal cabling will exit the telecom room through rigid steel conduit and then traverse to the nearest cable tray where it will travel to its respective device.

Typical Classroom

Each classroom will have data outlets located in each of the three floor boxes to supply data to the student computers, instructor computer, and the instructor voice-over IP (VoIP) handset. Also a data connection will be provided for the classroom Smart Board so it may be connected to the building network as well. A wireless access point integrated into the radiant cooled dropped ceiling panels will be available in each classroom for connectivity of future wireless learning devices. Lastly, a pendant mounted four speaker surround sound system will be connected to be used locally by the instructor or by school officials on an entire building level.

Building

Data outlets and wireless access points will be provided accordingly throughout the rest of the building to specific spaces. The building will also incorporate a monitored security system consisting of card readers, door contacts, cameras, motion sensors, and silent alarms, which will be integrated into the whole building network as well as being connected to the local municipality as is the fire alarm system.

Security

For a detailed analysis of how the aforementioned devices work within our team's security strategies, please see the team's Integration report.

Codes and Standards

Electrical Codes

ASHRAE 2007 90.1

National Electric Code 2011

NFPA 72 – National Fire Alarm and Signaling Code

NFPA 101 – Life Safety Code

NFPA 110 – Standard for Emergency and Standby Power Systems

ANSI/TIA/EIA – Standards for Building Telecommunications

Lighting Standards and References

IES Lighting Handbook 10th Edition

ASHRAE 2007 90.1

Reading School District Strategic Plan

PPG Glazing SOLARBAN 60 (2) STARPHIRE + STARPHIRE

Tips for Daylighting With Windows by the Lawrence Berkeley National Laboratory

Pennsylvania Lighting Ordinance

Daylighting Analysis

Typical Angled First Floor South Classroom (Daylight plus Lighting and Shades)

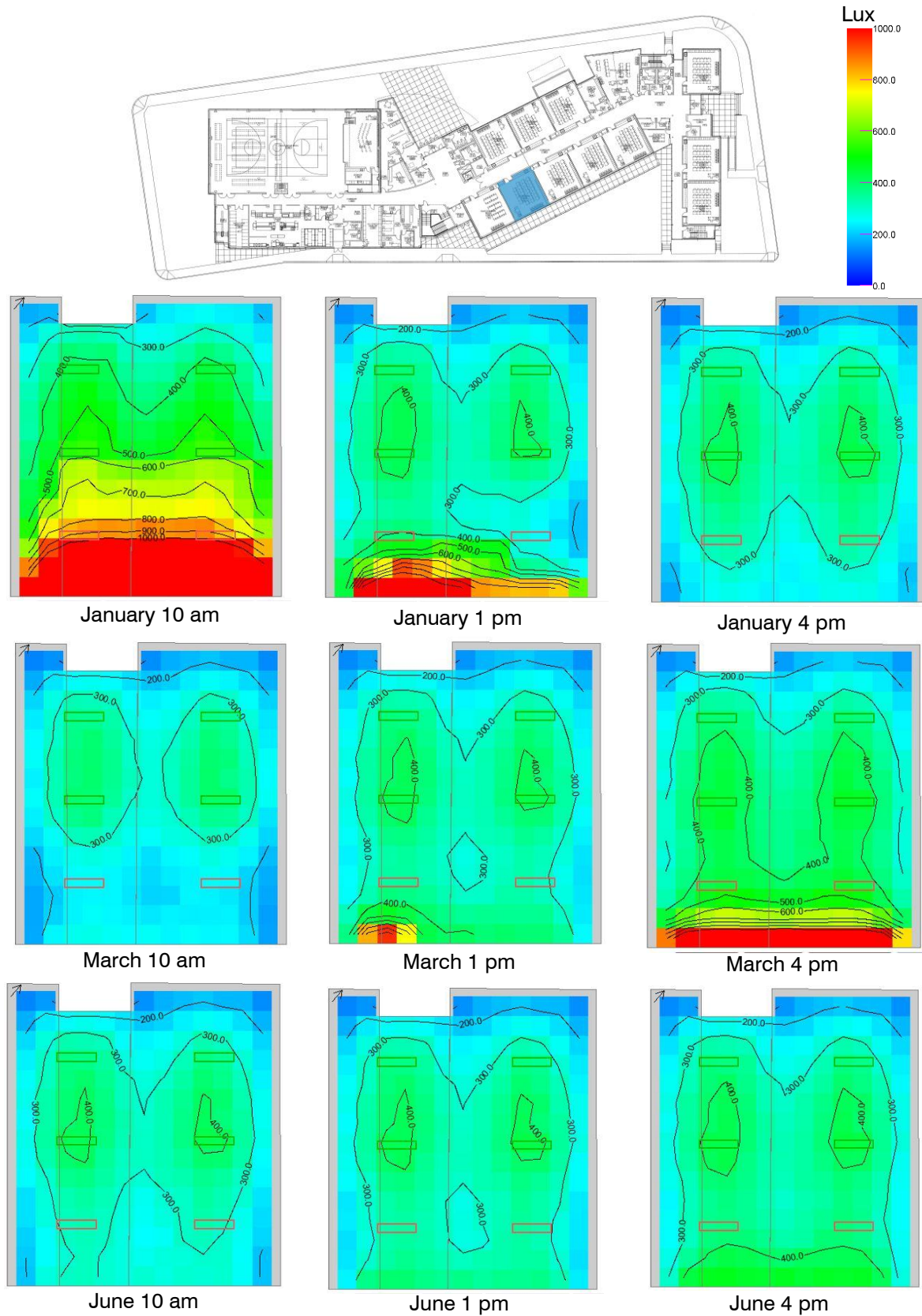

Daylighting Analysis

Typical Angled Second Floor South Classroom (Daylight plus Lighting and Shades)

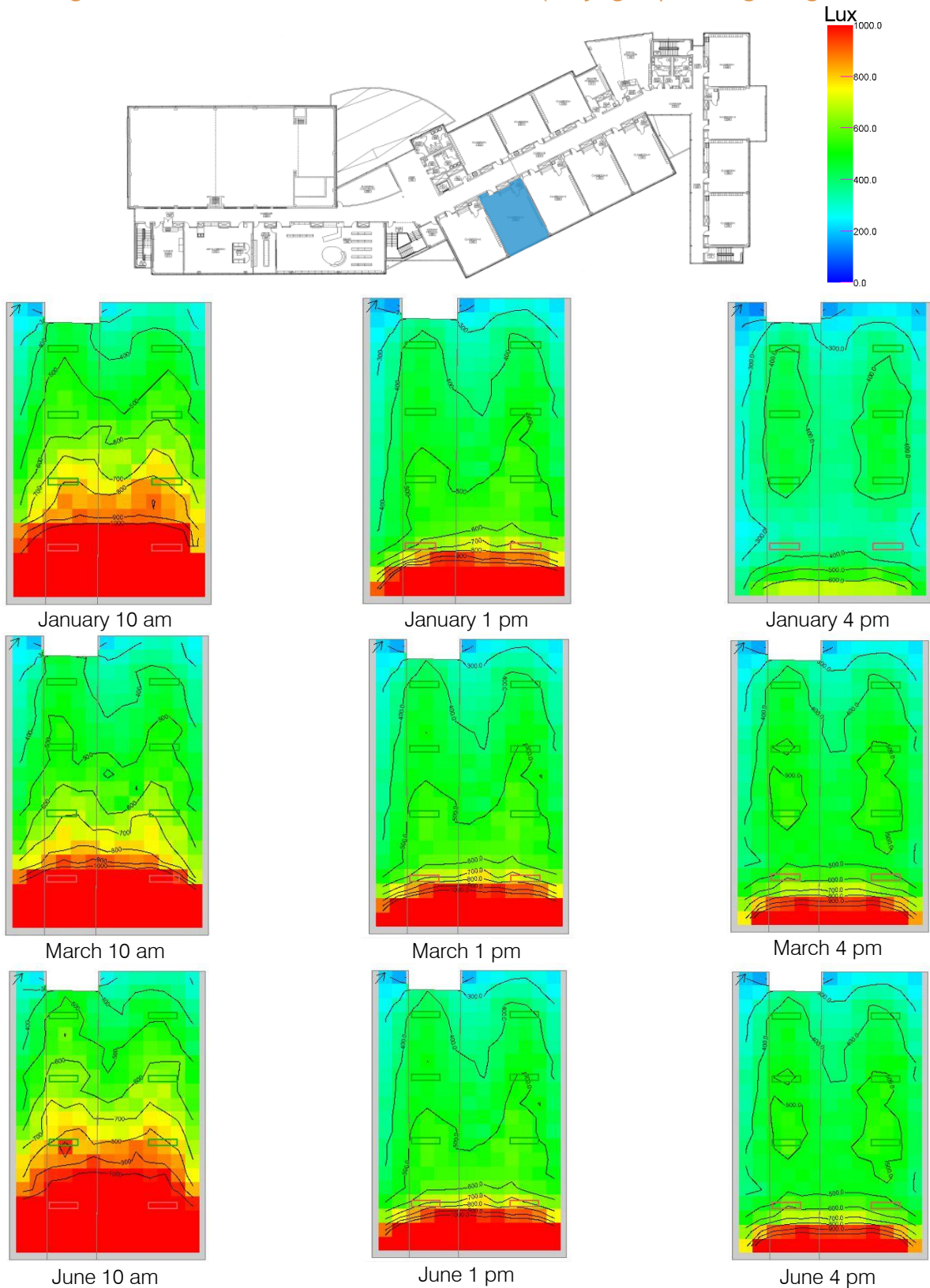

Daylighting Analysis

Energy Savings per Classroom

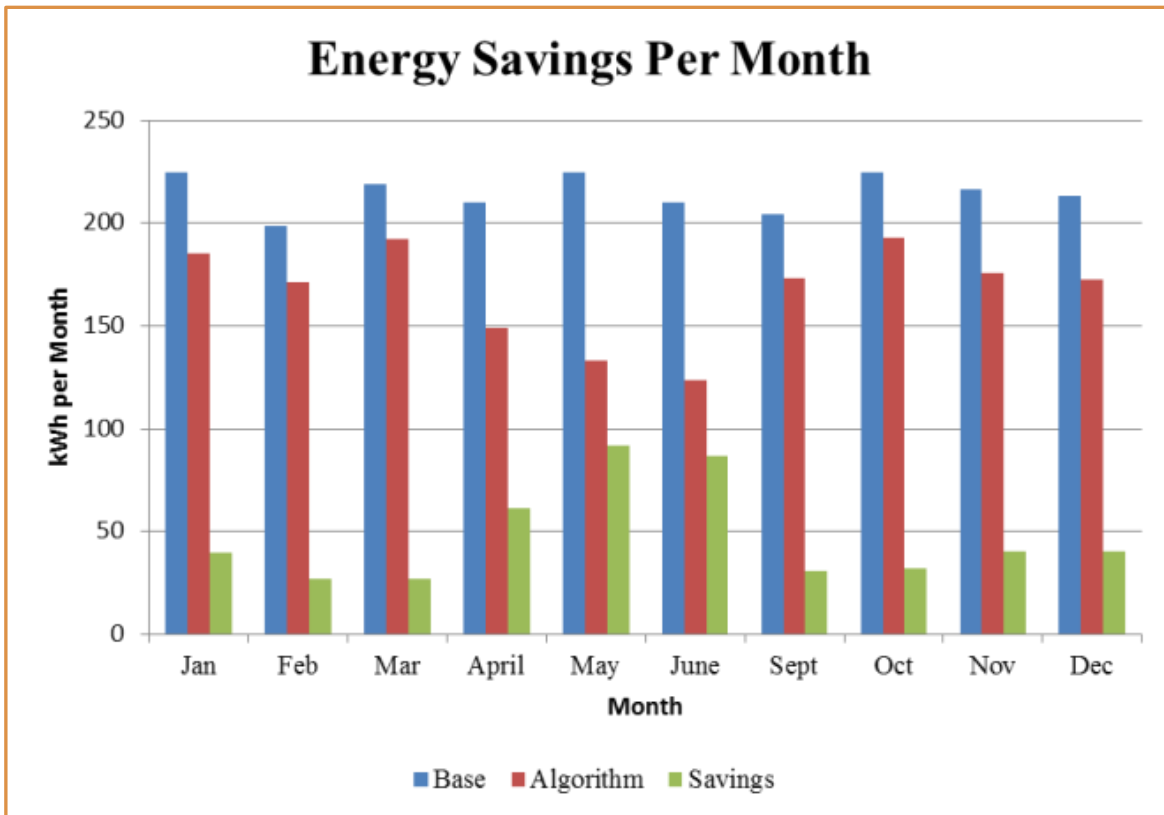

Example of Preliminary Solar Study for South Facing Classroom with an overhang:
 A 3' overhang overhang at the top of a 5' window, would protect the window from direct sun during the year highlighted in blue. The portion highlighted in green is when shades may need to be pulled down in order to not have the sun disturb the learning environment within the classroom. The white region is when the south facing façade would not receive any direct sunlight.

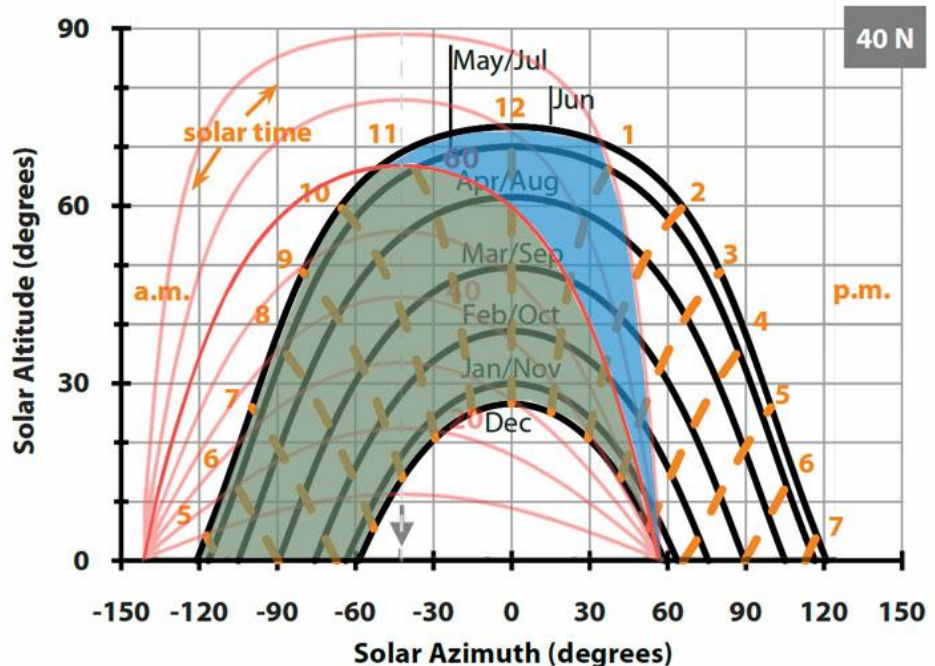

Lighting Analysis

First Floor AGI32 Verification of Illuminance Levels (FC)



Lighting Analysis

Second Floor AGI32 Verification of Illuminance Levels (FC)

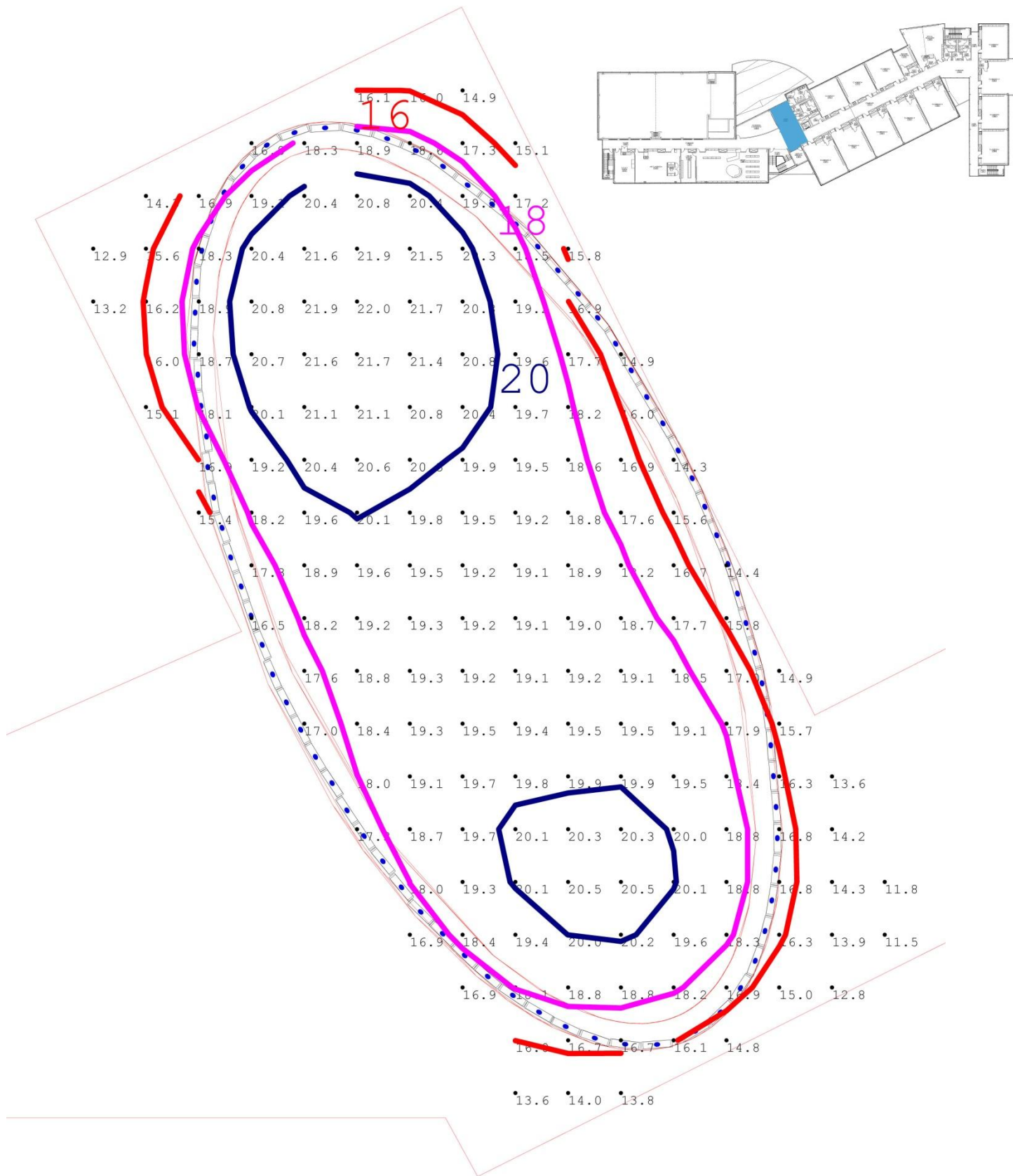

Lighting Analysis

Third Floor AGI32 Verification of Illuminance Levels (FC)

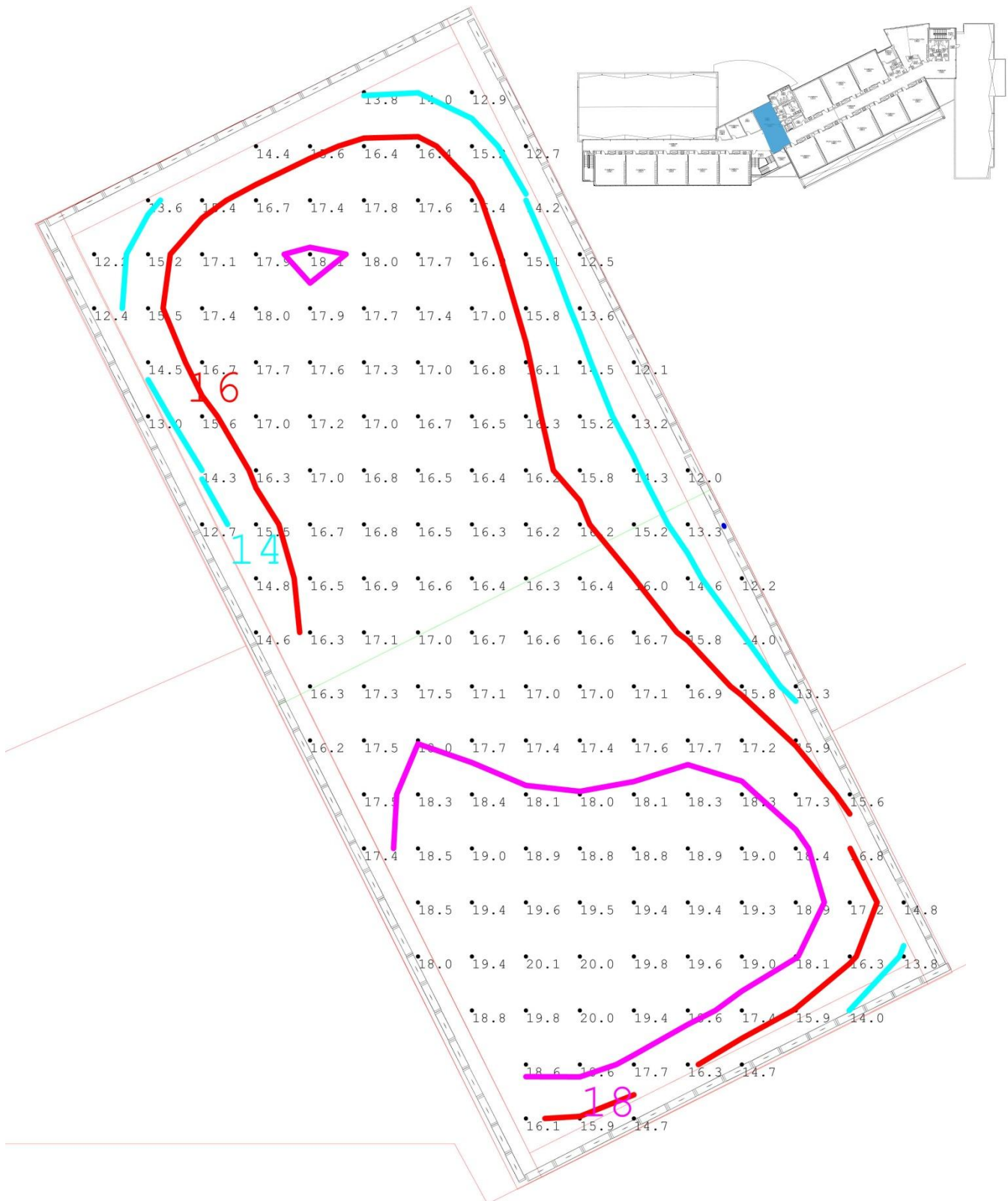

Lighting Analysis

Gym AGI32 Verification of Illuminance Levels (FC)

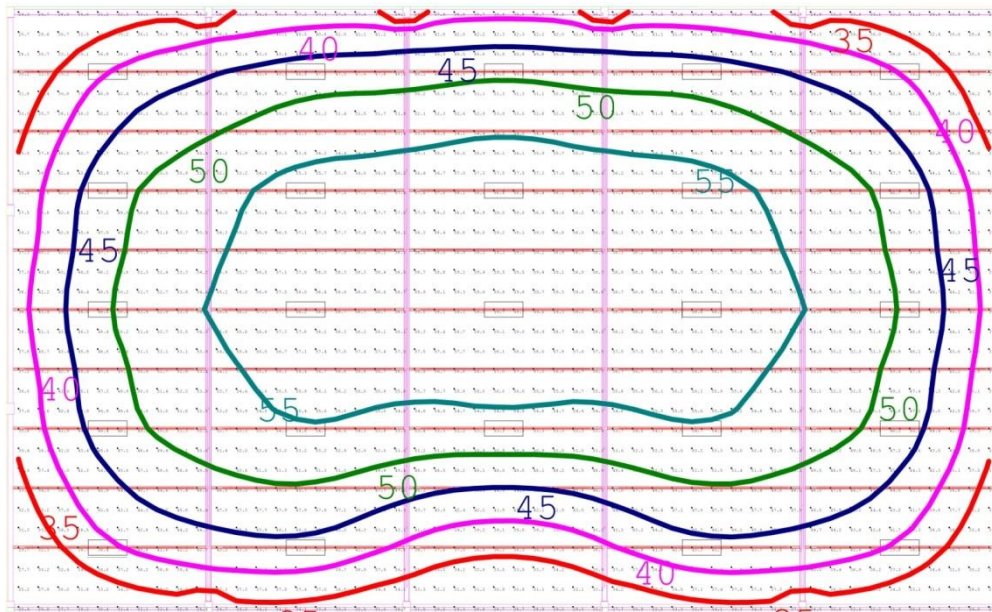

Normal Lighting

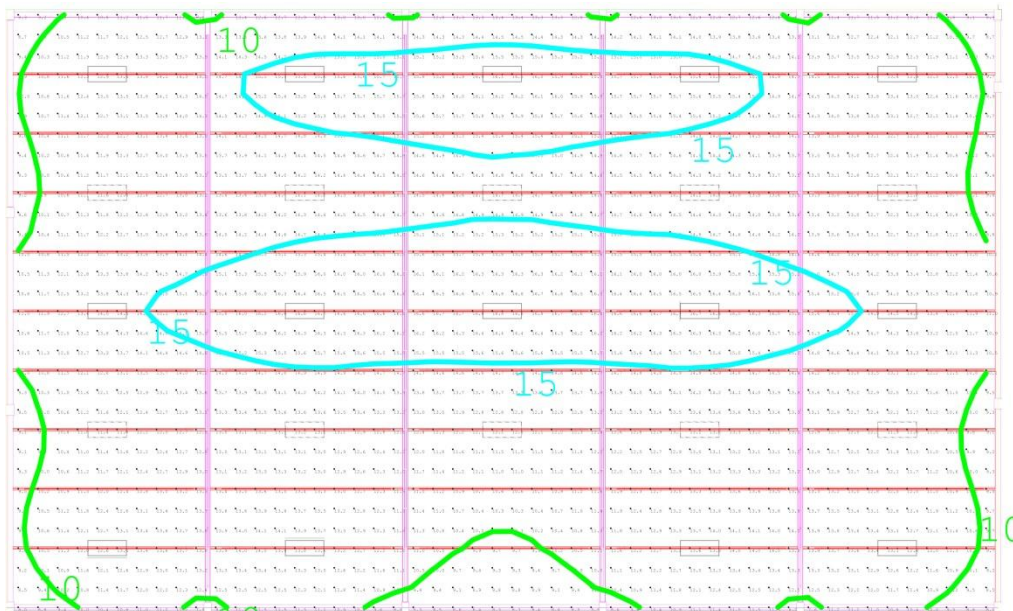

Life Safety Lighting



Lighting Analysis

Pool AGI32 Verification of Illuminance Levels (FC)

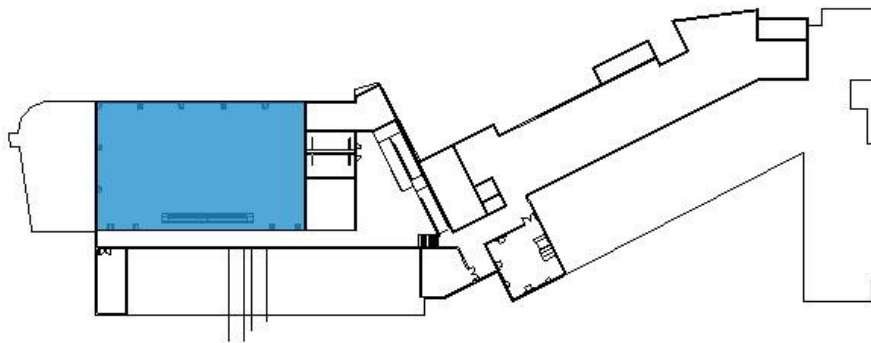
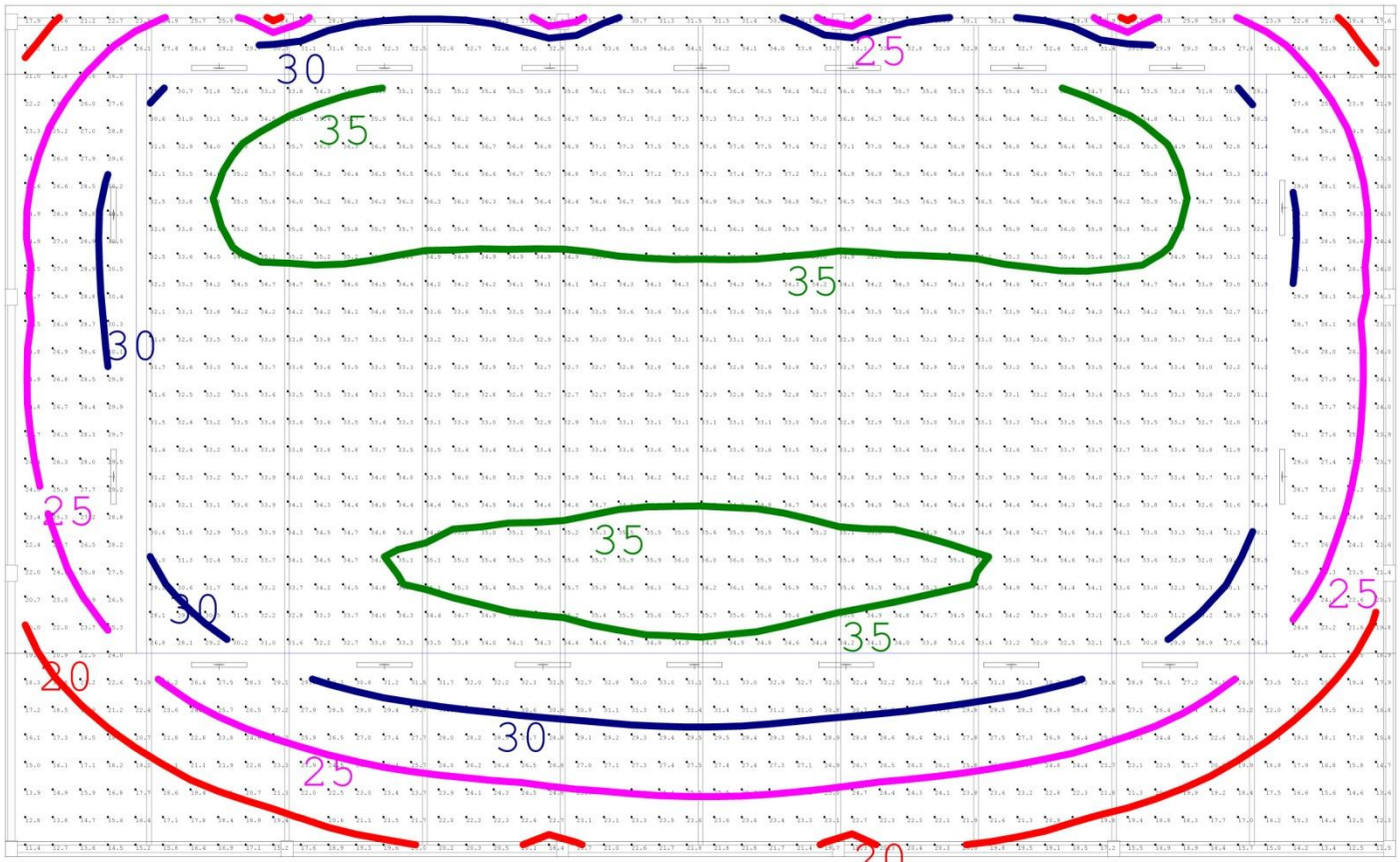

Classroom Control Wiring Diagram

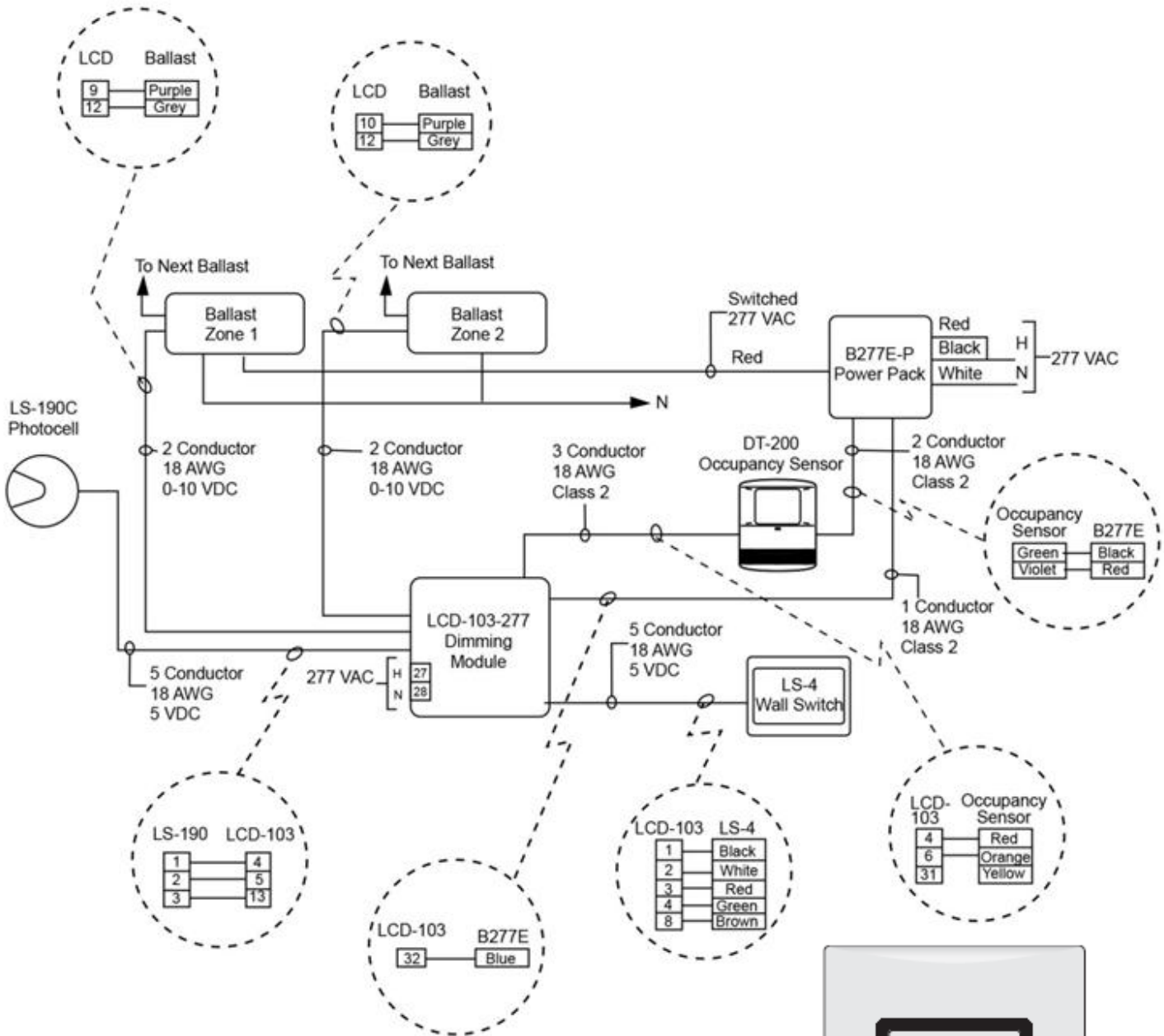

Wattstopper LCD-203 Dimming Controller with a LS-5C Wall-Switch.

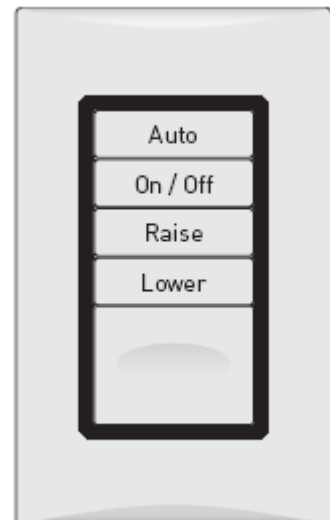

LS-5C Wall Switch

Electrical Load Tabulation

Mechanical Equipment Load (kW)

Main Chiller	151.62
Secondary Chiller	63.23
Central Main Supply Fan A	16.41
Central Main Supply Fan B	16.41
Central Main Return Fan A	5.22
Central Main Return Fan B	5.22
East Main Supply Fan	6.71
East Main Return Fan	2.24
Community Main Supply Fan	5.97
Community Main Return Fan	1.49
Pool Main Supply Fan	5.97
Pool Main Return Fan	1.49

Lighting - 1.2 Watts/SF Load (kW)

Basement	24
First Floor	42
Second Floor	32.4
Third Floor	25.2

Receptacles - 1.0 Watts/SF Load (kW)

Basement	20
First Floor	35
Second Floor	27
Third Floor	21

Misc. Power/Future Growth -

2.0 Watts/SF Load (kW)

Basement	40
First Floor	70
Second Floor	54
Third Floor	42

Total Load: 715 kW

SKM Electrical System Analysis

Fault Current Analysis

Bus	Voltage	Fault Current (A)	kAIC Rating	Protected
BLP	480	15,830	22	YES
BRP	208	5,240	10	YES
EBLP	480	15,380	22	YES
EBRP	208	5,120	10	YES
ELP1	480	8,610	10	YES
EDP	480	16,310	22	YES
ERP1	208	2,800	10	YES
LSDP	480	7,870	10	YES
LP1	480	8,300	10	YES
LP2	480	7,850	10	YES
LP3	480	7,430	10	YES
LSBLP	480	7,450	10	YES
LSBRP	208	4,390	10	YES
LSLP1	480	5,420	10	YES
LSRP1	208	2,770	10	YES
NDP	480	16,730	22	YES
RP1	208	4,560	10	YES
RP2	208	4,490	10	YES
RP3	208	4,420	10	YES
UNIT SUBSTATION	480	17,200	22	YES

SKM Electrical System Analysis

Arc Flash Studies

	Bus Name	Protective Device Name	Bus KV	Bus Bolted Fault (kA)	Bus Arcing Fault (kA)	Prot Dev Bolted Fault (kA)	Prot Dev Arcing Fault (kA)	Trip/ Delay Time (sec.)	Breaker Opening Time/Tot (sec.)	Ground	Equip Type	Gap (mm)	Arc Flash Boundary (in)	Working Distance (in)	Incident Energy (cal/cm2)	PPE Level	Label#	Cable Length From Trip Device (ft)
1	BLP	MCB	0.48	15.83	9.71	15.83	9.71	0.008	0.000	Yes	PNL	25	7	18	0.25	Category 0	# 0001	10.00
2	BRP	MCB	0.208	5.24	2.76	5.24	2.76	0.017	0.000	Yes	PNL	25	5	18	0.14	Category 0	# 0002	
3	EBLP	Substation MCB	0.48	15.38	9.47	13.31	8.20	0.06	0.000	Yes	PNL	25	24	18	1.9	Category 1	# 0001	25.00
4	EBRP	Substation MCB	0.208	5.12	2.72	4.43	2.35	2	0.000	Yes	PNL	25	88	18	16	Category 3 (N9)	# 0002	35.00
5	ELP1	Substation MCB	0.48	8.61	5.77	7.46	5.00	0.06	0.000	Yes	PNL	25	17	18	1.1	Category 0	# 0003	165.00
6	EMERGENCY DP	Substation MCB	0.48	16.31	9.96	14.12	8.62	0.06	0.000	Yes	PNL	25	25	18	2.0	Category 1	# 0004	15.00
7	ERP1	Substation MCB	0.208	2.80	1.78	2.42	1.54	2	0.000	Yes	PNL	25	67	18	10	Category 3 (N9)	# 0005	185.00
8	LIFE SAFETY DP	MCB	0.48	7.87	5.34	7.83	5.32	0.017	0.000	Yes	PNL	25	7	18	0.28	Category 0	# 0006	15.00
9	LP1	Substation MCB	0.48	8.30	5.60	7.18	4.84	0.06	0.000	Yes	PNL	25	17	18	1.1	Category 0	# 0007	220.00
10	LP2	Substation MCB	0.48	7.85	5.33	6.79	4.61	0.06	0.000	Yes	PNL	25	16	18	1.0	Category 0	# 0008	240.00
11	LP3	Substation MCB	0.48	7.43	5.09	6.43	4.40	0.06	0.000	Yes	PNL	25	16	18	0.96	Category 0	# 0009	260.00
12	LSBLP	LIFE SAFETY MCB	0.48	7.45	5.10	7.45	5.10	0.017	0.000	Yes	PNL	25	7	18	0.27	Category 0	# 0010	25.00
13	LSBRP	LIFE SAFETY MCB	0.208	4.39	2.44	4.39	2.44	0.017	0.000	Yes	PNL	25	5	18	0.13	Category 0	# 0011	30.00
14	LSLP1	LIFE SAFETY MCB	0.48	5.42	3.89	5.42	3.89	0.017	0.000	Yes	PNL	25	6	18	0.20	Category 0	# 0012	165.00
15	LSRP1	LIFE SAFETY MCB	0.208	2.77	1.50	2.77	1.50	0.03	0.000	Yes	PNL	25	5	18	0.13	Category 0 (N3)	# 0013	180.00
16	NORMAL DP	Substation MCB	0.48	16.73	10.18	15.20	9.25	0.06	0.000	Yes	PNL	25	25	18	2.0	Category 1	# 0014	20.00
17	RP1	Substation MCB	0.208	4.56	2.50	3.94	2.17	2	0.000	Yes	PNL	25	83	18	15	Category 3 (N9)	# 0015	230.00
18	RP2	Substation MCB	0.208	4.49	2.48	3.88	2.14	2	0.000	Yes	PNL	25	83	18	15	Category 3 (N9)	# 0016	250.00
19	RP3	Substation MCB	0.208	4.42	2.45	3.83	2.12	2	0.000	Yes	PNL	25	82	18	14	Category 3 (N9)	# 0017	270.00
20	UNIT SUBSTATION	Substation MCB	0.48	17.20	10.42	14.93	9.04	0.06	0.000	Yes	PNL	25	25	18	2.1	Category 1	# 0018	

SKM Electrical System Analysis

Protective Device Coordination

Example of coordination among protective devices upstream from the “Community” Main Supply Fan so if a fault should occur at this equipment, the Community Main Supply Fan MCB should trip first, then the Life Safety DP MCB, and finally the Unit Substation MCB. This coordination prevents the unnecessary loss of power to other branches and panels within the school’s electrical system.

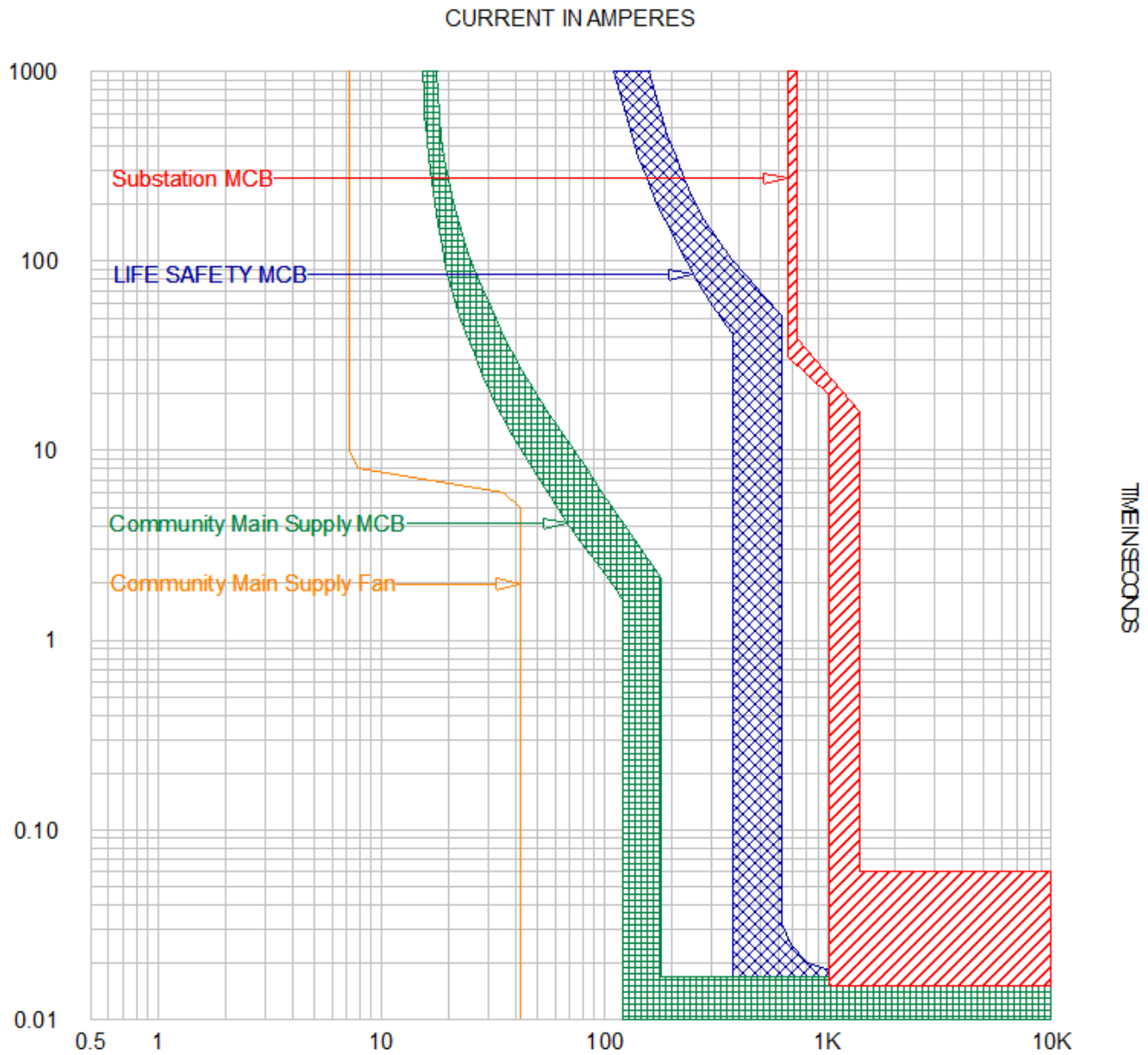

Electrical Equipment

Square D Model III Package Unit Substation

Compact Construction. Efficient Performance.

Whether renovating or completing new construction, Schneider Electric's Square D® Model III Package Unit Substations offer space-saving, compact design and efficient performance in one, complete module. Data centers and buildings tight on electrical room space and in need of powerful performance trust Square D Model III Package Unit Substations to house HVL/cc™ primary disconnect switches, medium voltage dry-type transformers, and I-Line® distribution sections. The streamlined build allows for fast, easy installation in tight spaces.

**Key Features & Benefits**

- **Compact Design** — fits easily through standard doorways and tight spaces. The Model III offers the smallest footprint in the industry measuring 48 in. deep, 62.75–74.75 in. wide and 90 in. tall with a total weight of less than 8,000 pounds.
- **Efficient Performance** — contributes to LEED® certification with reduced power losses and better voltage regulation.
- **Continued Service** — isolates outages faster with substations located at each load area.
- **Easy Expansion** — add new load areas without affecting the substation.
- **Efficient Design** — install front accessible units against a wall or in a corner without de-rating.
- **Industry Standards** — rest assured each transformer has been built to all UL® safety requirements with the UL label of approval on each substation.



Electrical Equipment

Square D Premium 30 Energy Efficient Transformers

30% more efficient **and** meets NEMA Premium Efficiency Program Standards



Schneider Electric's Premium 30 Energy Efficient Transformers are designed to exceed minimum efficiency program standards — giving you optimum performance and superior quality you expect from Square D® products.

Incorporate these NEMA Premium program-approved, low voltage transformers to reduce energy consumption and contribute to LEED® certifications in commercial, industrial or institutional facilities.

Typical Applications

Any building striving for improved energy use including buildings working toward LEED certification.

- Commercial and Industrial Buildings
- Educational Campuses
- Government Facilities
- Healthcare Facilities

Square D® Premium 30 Energy Efficient Transformers

- Distribution Transformers
 - Three-phase 15 kVA to 1000 kVA
- Non-Linear Transformers
 - K-9 and K-13 options
 - Three-phase 15 kVA to 750 kVA
- Harmonic Mitigating Transformers
 - 0° and 30° Phase Shift
 - Three-phase 15 kVA to 750 kVA



by Schneider Electric

Fixture Schedule

Fixture Type	Fixture Manufacturer	Product Number	Lamp Type	Number of Lamps	Ballast	Watts	Mounting	Comments
A-1	Mark Architectural Lighting	EC1-4-CGPF-2TSHO-EBPR-277-IND	54W TSHO 3500K CRI 85	2	GE GE254MVP590-F	117	Suspended	See Architectural Drawings for placement and locations. Mount 8.5' AFF.
A-2	Mark Architectural Lighting	EC1-4-CGPF-2TSHO-ED8-277-IND	54W TSHO 3500K CRI 85	2	Sylvania QTP 2x54T5HO/UNV	125	Suspended	Fixtures installed in classrooms. Mount 8.5' AFF. See Construction details for installation
B	HE Williams	CVL-FE-8-24TT-EBCV1-277V	24W T4 Double Blax 2G11 Base 3500K CRI 82	1	GE GEC218-MVPS-3W	26	Surface Mounted	Fixtures come prewired. See Lighting Sections and Plans for Mounting details.
C	Cooper	HBE-4-54T5-M-A-277-LS835-EBT2-MS	54W TSHO 3500K CRI 85	4	GE GE254MVP590-F	234	Surface Mounted	Fixtures mounted in gym connected to bottom of joist.
D	HE Williams	PVC90-126T-WHT-CS-UNV	32W GX24q-3 3500K CRI 82	1	Philips REB-2526-MI-LS-DIM	35	Surface Mounted	Fixtures Mounted to ceiling in gym above stage
F	SPI Lighting	Lightruss-10817-FT-F54-PT101	54W TSHO 3500K CRI 85	3	Sylvania QTP 1x54T5HO/UNV QTP 2x54T5HO/UNV	180	Truss	Fixtures mounted in truss. Light truss is delivered prepackaged and prewired.
G	Lithonia	LP6FN-26TRT-609-277	26W T4 GX24q-3 3500K CRI 82	1	GE GEC218-MVPS-3W	28	Recessed	See Architectural Drawings for placement and locations.
H	Cooper	IAF-254T5-UNV-EB81-LJ	54W T5 3500K CRI 85	2	Sylvania QTP 2x54T5/UNV	117	Surface Mounted	Industrial fixture to be used in janitorial and electrical/telecom closets
J	Lithonia	2RT55-28T5-MVOLT-GEB95-LPM835P	28W T5 3500K CRI 85	2	Sylvania QTP 2x28T5/UNV	63	Recessed	Industrial fixture to be used in kitchen.
K	Cooper	IAF-228T5-UNV-EB81-LJ	28W T5 3500K CRI 85	2	Sylvania QTP 2x28T5/UNV	63	Surface Mounted	Industrial fixture to be used in janitorial and electrical/telecom closets

Light Truss

Lightruss®

Durable construction that lasts.

Attention to detail.

Truss Sections

- A Truss Tubes**
- Three metal tubes held in a triangular configuration by bulkheads.
 - Size 1: (3) 1.125" diameter steel tubes, available in section lengths up to 8'.
 - Size 2: (3) extruded 1.5" diameter aluminum tubes, available in section lengths up to 10'.
- B Wireway**
- Delivered pre-wired and factory assembled.
- C Auxiliary Wireways**
- Provision for multiple circuits and/or switching, please consult factory for multiple circuiting of size 1 Lightruss.
 - UL listed (US and Canada) for damp locations (Not recommended for exterior use).
- D Bulkhead**
- Cast aluminum.
 - Provides vertical support of truss.
 - Point of attachment and adjustment for stainless steel cable or stem supports.
 - Splice compartment.

Mounting

- E Cable**
- Corrosion- and heat-resistant Inconel® aircraft suspension cable.
- F Stem**
- Power feed: 5/8" OD stainless steel stem, painted – specify color.
- G Canopy**
- 30° swivel and white plastic canopy.
 - Canopy twist locks into position with no exposed fasteners.
 - Inner steel support bracket attaches to 4" octagonal box.
- Wall Mount**
- Recessed outlet box.
 - Overhead suspension required for runs of 8' or more (size 1) and 10' or more (size 2).

Light Modules

- H Module Components**
- Each light module houses lamp(s), optical assembly and ballast.
 - Light modules are made from 0.25" extruded aluminum side panels and 0.25" cast aluminum end caps.
 - Stainless steel set screws secure module to truss tubes.
 - All light modules are pre-wired, pre-focused and pre-assembled into the Lightruss system to simplify installation.
 - Light modules and Lightruss sections are individually packed and labeled to coordinate with the installation drawings.

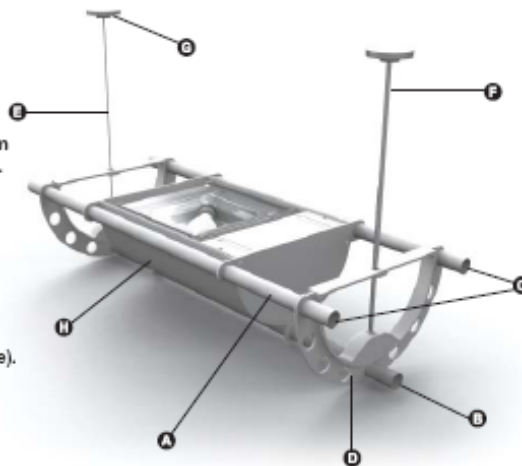

G Canopy Detail



D Splice Compartment



B Wireway Detail



Optics

Forward Throw

- HID and tungsten halogen modules utilize a segmented 95% reflective, specular aluminum reflector with an impact and heat-resistant, tempered glass lens.

Asymmetric and Symmetric

- HID and tungsten halogen modules utilize a brightened and anodized, hydroformed, aluminum reflector with an impact and heat resistant tempered glass lens.

Symmetric Fluorescent

- Modules have die-formed aluminum, 92% reflective superwhite reflector.

Integral Ballasts

HID

- HID Power Tray™ is supplied with a quick-connect plug.
- HID ballasts are (EISA) Energy Independence and Security Act compliant.
- Thermally protected.
- Class "B" sound rating.
- Silicone cushions are used in HID ballast mounting to minimize ballast noise and vibration in the system.
- Visit www.specspi.com/resources or contact factory for specific ballast information.

Fluorescent

- HPF electronic ballast with low harmonic distortion (<20%).
- Thermally protected.
- Minimum starting temperature is 0°F.
- Class "A" sound rating.

Finishes

Powder Coat Paint

- Standard finish is thermoset polyester powder coat. All metal surfaces go through a 5-stage pretreatment process prior to powder coat application.
- Consult factory if natatorium (non-corrosive) finish is required.

Standard Options

DM	Dimming (Fluorescent only)
EMI	Integral Emergency
EPT	Encapsulated Core and Coil Power Tray™
F	Fusing (Factory installed)
LD	Acrylic Prismatic Diffuser Lens
LL	Downlight Louvers (For modules aimed in a direct orientation)
Q	Standby Quartz Lighting
QEM	Quartz Emergency Light Circuit

LD Option



LL Option



See Technical Information on page 300 for further details.

Light Truss

Lightruss FAQs**Q Is Lightruss easy to install?**

A Yes! You'll save approximately 25 to 30% in time and money versus independently hung fixtures. See page 35 for an installation estimate breakdown.

Q How is Lightruss installed, wired and mounted?

A The completely assembled, wired and focused sections need only to be unpacked, lamped, ballasted, positioned and mounted as predetermined. Our HID multi-tap Power Tray™ with quick-connect plugs allow for fast installation, maintenance access and replacement. The bulkheads provide vertical support where stems and cables can attach at the splice compartment. Lightruss sections are joined at the end of each tube with an expansion bracket that provides positive locking action.

Q How many fixtures can be fed per power feed?

A Size 2 Lightruss accommodates 12 gauge wiring and can service 8 dual 400W fixtures per power feed. Size 1 Lightruss accommodates 16 gauge wiring and can service 8 single 400W fixtures per power feed. All three tubes are UL listed as raceways and can house two circuits per tube. (All numbers assume a 277 volt, 20 amp system.)

Q How do I specify Lightruss?

A A custom number is assigned (i.e. LT 12345) to the entire bill of materials, order, drawings and carton labels. Then our Lightruss team will work with you to design the system. When you approve the layout, we will build the system and send it to the job site for installation. For a detailed example of the Lightruss specification process, see page 36.

Q How do I determine which light module is needed?

A The desired light levels determine light module selection and spacing. Our Lightruss team will assist in determining the appropriate combination of modules and lampings for your application.

**Q Can Lightruss come in any length?**

A Composed of sections between 12 and 120 inches, Lightruss systems can be supplied in any length.

Q Why is Lightruss such a good choice for natatoriums?

A Our lighting system installs over the pool deck, lowering maintenance costs. Indirect lighting eliminates water surface glare, allowing lifeguards to see directly to the bottom of the pool. Standard size 2 Lightruss system's all aluminum components are anodized and powder coated with a 2 mil thickness polyester powder coat paint for a non-corrosive finish and all hardware is suitable for natatorium environments. Consult factory for size 1 Lightruss in a natatorium application.

Q Are Lightruss systems built with high-quality components?

A Yes! Lightruss was carefully designed and all details were considered. Machine tolerances on all components are held to within +/- .030" and silicone cushions ensure quiet system operation.

Q How are security equipment, auxiliary lighting and other accessories integrated into Lightruss systems?

A The three-tube system can serve as independent wire raceways for multiple circuits, track lighting or incorporation of additional needs such as security cameras, sound systems or signage. Empty modules can serve as a place to conceal speakers and additional equipment.











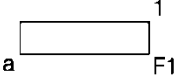













Q Can I specify specific circuitry schemes?

A Yes! We can work with the engineer to incorporate different light levels with different wiring schematics (i.e. 3 phase or phase to phase).

Q Are Lightruss light modules enclosed?

A HID and quartz light modules are supplied with a removable, tempered glass lens. A lens option is available for fluorescent modules.

Drawings Legend

<u>Power</u>		<u>Lighting</u>	
	DUPLEX RECEPTACLE MOUNTED 18" AFF UNLESS OTHERWISE NOTED		FLUORESCENT LIGHTING FIXTURE LOWER CASE LETTER INDICATES SWITCHING UPPER CASE LETTER INDICATES TYPE NUMBER INDICATES DIMMED/NON-DIMMED ZONE IF APPLICABLE
	GFCI RECEPTACLE MOUNTED 6" ABOVE COUNTER TOP UNLESS OTHERWISE NOTED		LOW VOLTAGE OCCUPANCY SENSOR
	FLOOR BOX CONTAINING DOUBLE DUPLEX RECEPTACLE AND TEL-DATA OUTLET. TO BE COORDINATED IN SLAB WITH RADIANT HEATING TUBING		LOW VOLTAGE PHOTOCELL
	TAMPER-PROOF PLUGMOLD RACEWAY WITH OUTLETS EVERY 16 INCHES		SINGLE POLE WALL SWITCH LOWER CASE LETTER INDICATES ZONE
	CLOCK OUTLET		SINGLE POLE WALL SWITCH WITH INTEGRAL OCCUPANCY SENSOR FOR OFFICE SPACES
	SINGLE TUB 42 POLE PANEL		WATTSTOPPER LIGHTSAVER LS-5C WALL SWITCH FOR CLASSROOMS
	DOUBLE TUB 84 POLE PANEL		
	DISTRIBUTION PANEL		
	AUTOMATIC TRANSFER SWITCH		
	TRANSFORMER		
<u>Telecom</u>			
	TERMINATION POINT		
	WALL MOUNTED DATA OUTLET		
	CEILING MOUNTED DATA OUTLET		
	FLOOR MOUNTED DATA OUTLET		
	HORIZONTAL CAT 6 CABLING		
	CABLE TRAY		
	CONDUIT		
<u>Fire Alarm</u>			
	FIRE ALARM HORN AND STROBE COMBINATION		
	FIRE ALARM MANUAL PULL STATION		
	AREA SMOKE DETECTOR		

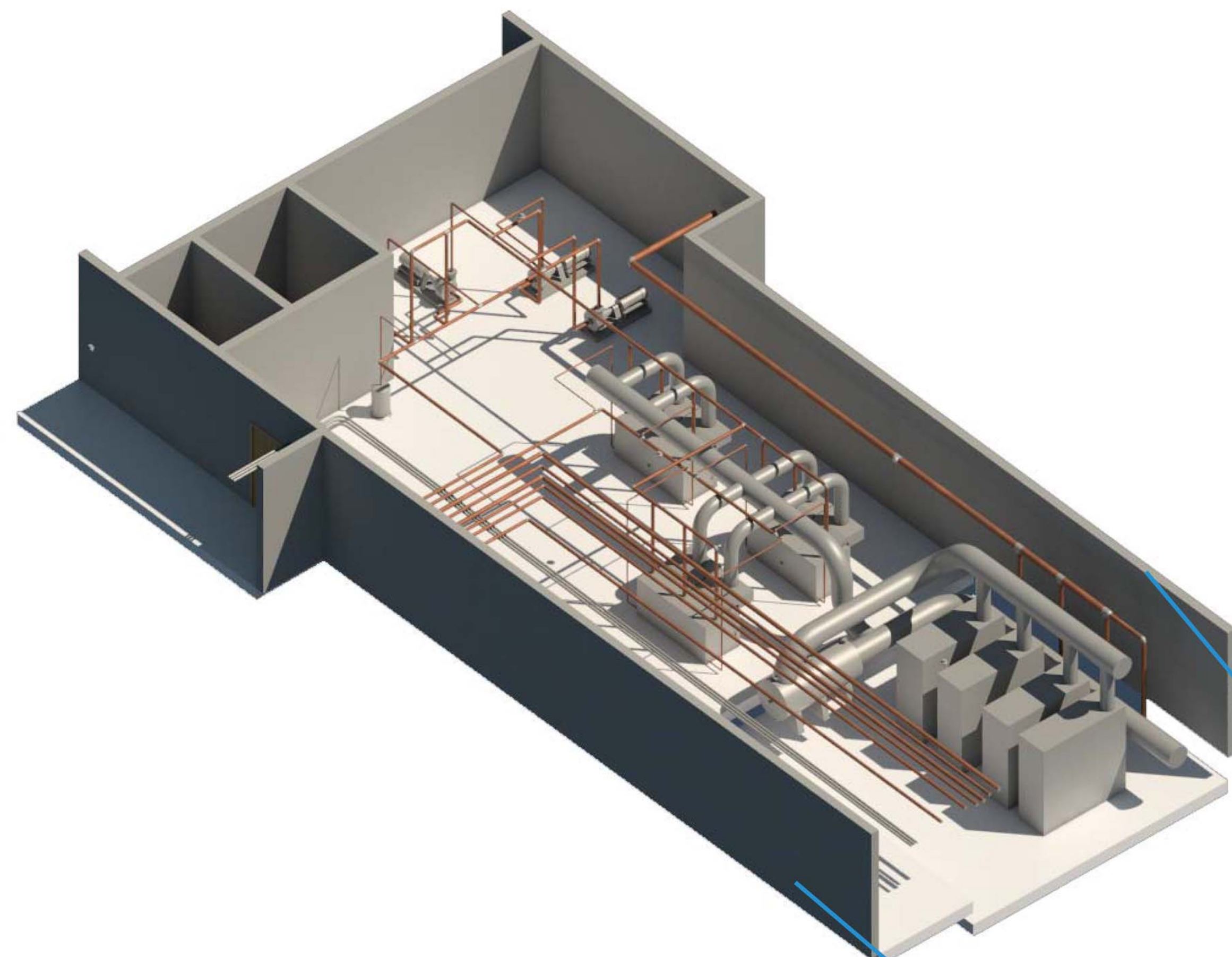

Heating and CHP Equipment



Cooling Equipment

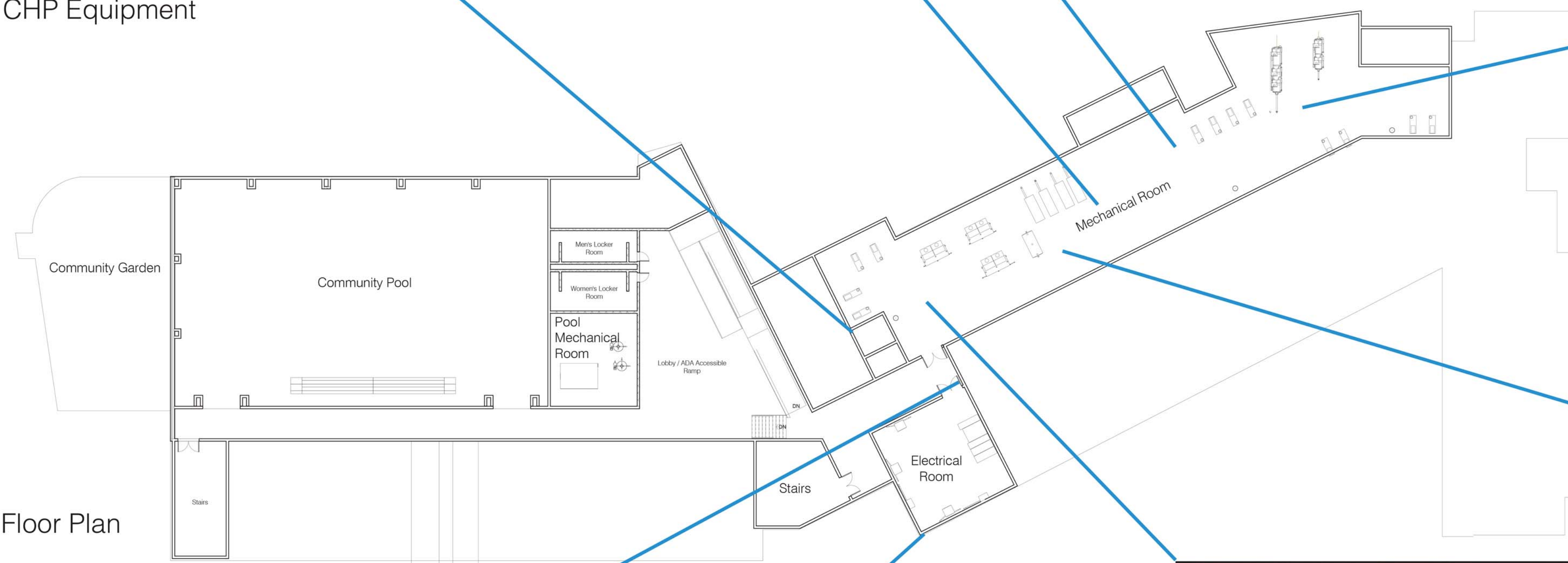

Basement Floor Plan

MECHANICAL & ELECTRICAL ROOMS:
 The mechanical and electrical rooms were deemed to be "critical" spaces for engineering disciplines in terms of clash detection and organization. Thus, the mechanical and electrical rooms were fully modeled in REVIT down to piping. Electrical loads for mechanical equipment were transferred via the REVIT model, and were kept up to date to accurately manage the building loads at any given time.

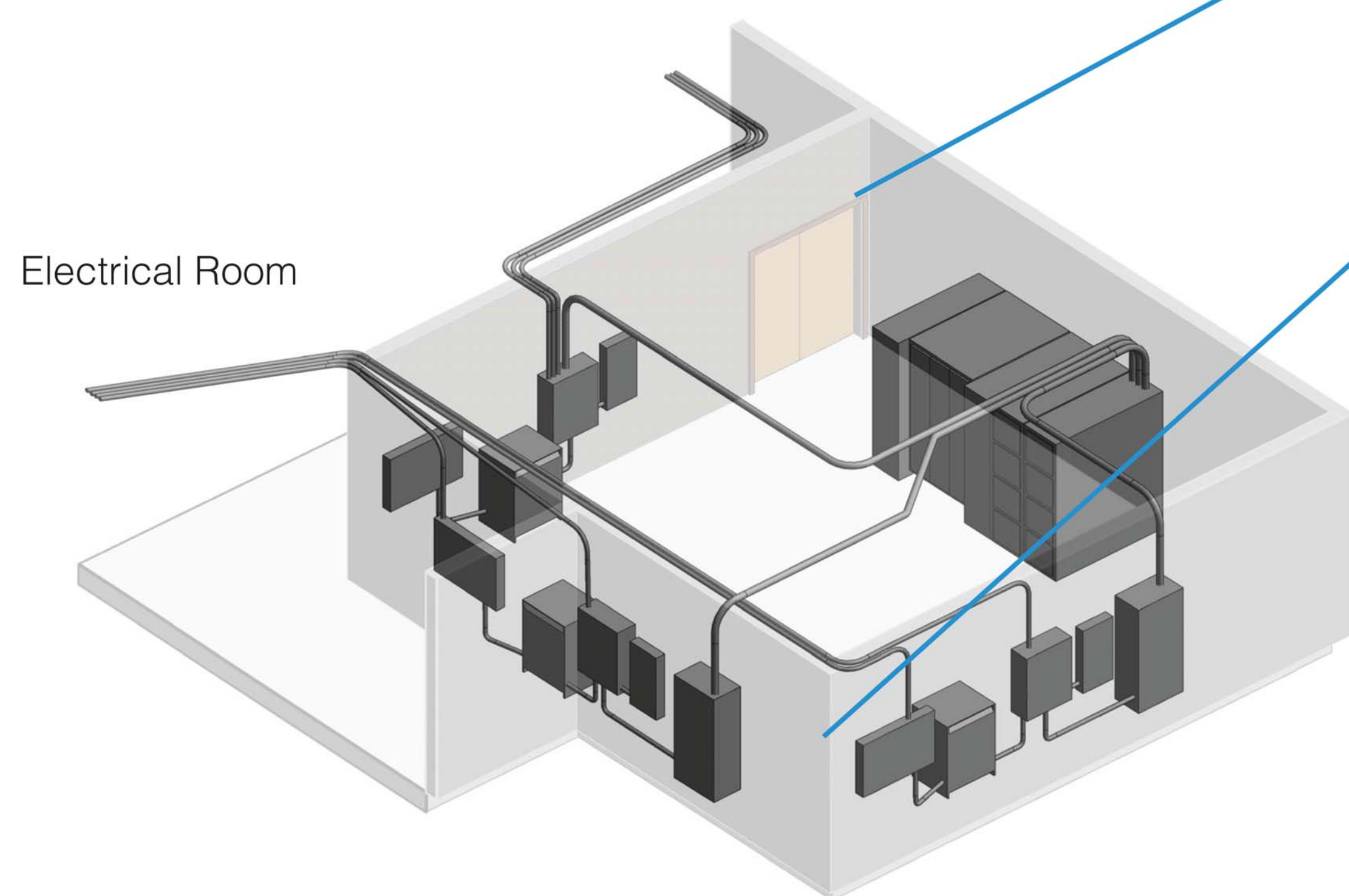

Electrical Room



Heating Equipment

ASCE Charles Pankow Foundation
 Architectural Engineering
 Student Competition

Team Number 05-2013

No.	Description	Date
1	Competition Submission Drawings	2/22/12

Mech/Elec
 Integration Overview

Date Issue Date

E1

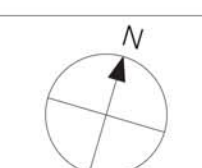

Scale

BASEMENT LIGHTING PLAN:

Prominent spaces in the basement include the community pool area and associated locker rooms, the community lobby area which leads to the pool, and the main mechanical/electrical rooms which house the building's unique cogeneration system. Refer back to the Lighting/Electrical Narrative for more in-depth analysis and renderings of these spaces and also refer to the Integration Narrative and Drawings for a look at how the team collaborated and designed the lighting systems with other engineering disciplines to create maximum project value.

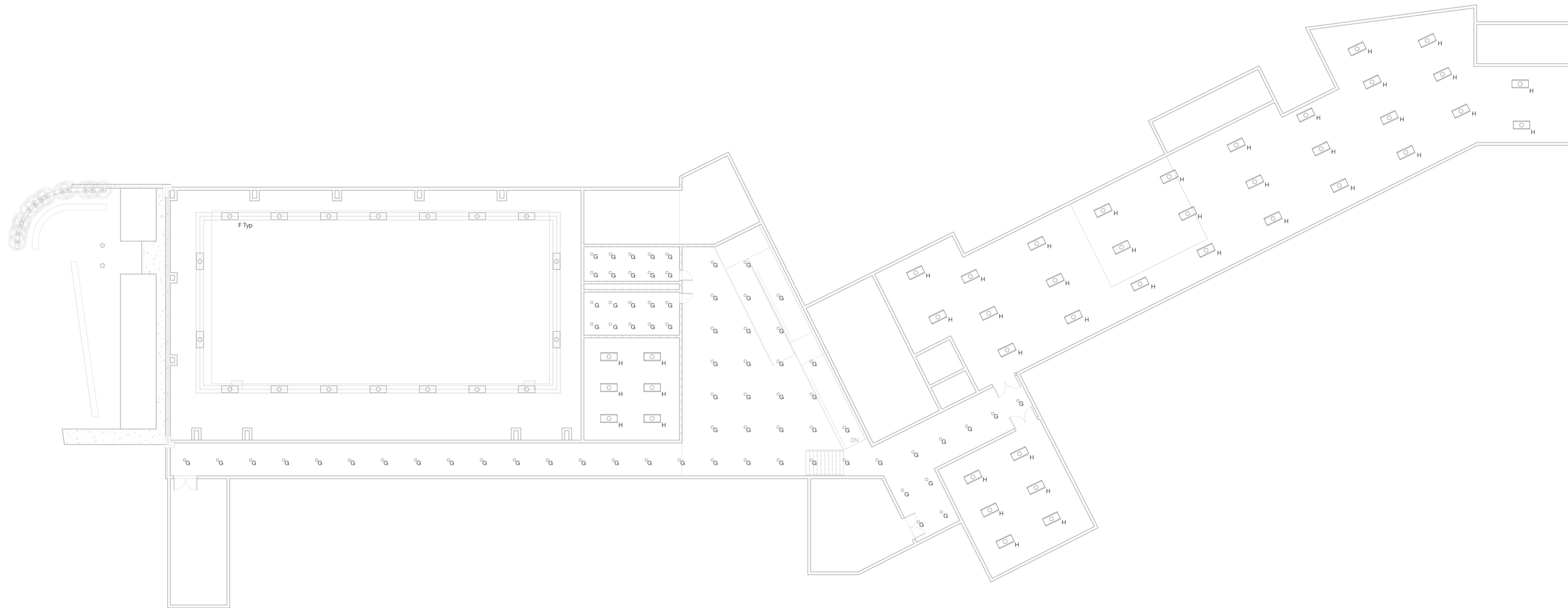

1 Basement Lighting
3/32" = 1'-0"

ASCE Charles Pankow Foundation
Architectural Engineering
Student Competition

Team Number 05-2013

No.	Description	Date
1	Competition Submission Drawings	2/22/12

**Basement Lighting
Plan**

Date Issue Date

E2

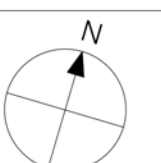

Scale 3/32" = 1'-0"

FIRST FLOOR LIGHTING PLAN:

Prominent spaces on the first floor include the multi-purpose gymnasium space and school kitchen area, which as mentioned before will also be utilized when the school functions as a natural disaster shelter. This floor also houses school administrative offices, 12 student classrooms, and a 24 hour community clinic. Refer back to the Lighting/Electrical Narrative for more in-depth analysis and renderings of these spaces and also refer to the Integration Narrative and Drawings for a look at how the team collaborated and designed the lighting systems with other engineering disciplines to create maximum project value.



1 First Floor Lighting
1" = 12'-6"

ASCE Charles Pankow Foundation
Architectural Engineering
Student Competition

Team Number 05-2013

No.	Description	Date
1	Competition Submission Drawings	2/22/12

1st Floor Lighting
Plan

Date Issue Date

E3

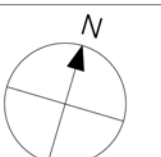

Scale 1" = 12'-6"

SECOND FLOOR LIGHTING PLAN:

Prominent spaces on the second floor include the school library, art room, and large conference room. This floor also houses 13 student classrooms. Refer back to the Lighting/Electrical Narrative for more in-depth analysis and renderings of these spaces and also refer to the Integration Narrative and Drawings for a look at how the team collaborated and designed the lighting systems with other engineering disciplines to create maximum project value.

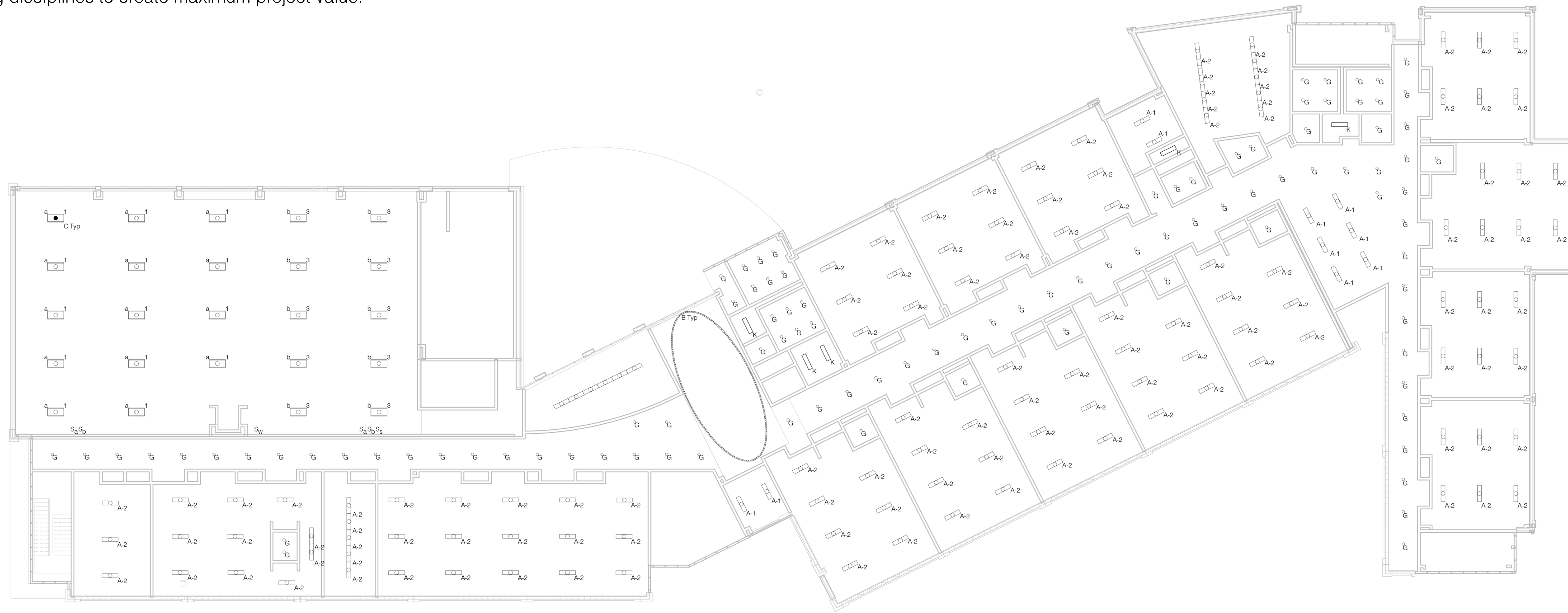

1 Second Floor Lighting
1" = 12'-0"

ASCE Charles Pankow Foundation
Architectural Engineering
Student Competition

Team Number 05-2013

No.	Description	Date
1	Competition Submission Drawings	2/22/12

2nd Floor Lighting
Plan

Date Issue Date

E4

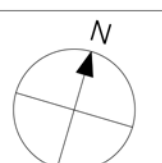

Scale 1" = 12'-0"

THIRD FLOOR LIGHTING PLAN:

The third floor is primarily dedicated to student classrooms with a total of 13. The third floor also features the buildings outdoor green roof area. Refer back to the Lighting/Electrical Narrative for more in-depth analysis and renderings of these spaces and also refer to the Integration Narrative and Drawings for a look at how the team collaborated and designed the lighting systems with other engineering disciplines to create maximum project value.



1 Third Floor Lighting
3/32" = 1'-0"

ASCE Charles Pankow Foundation
Architectural Engineering
Student Competition

Team Number 05-2013

No.	Description	Date
1	Competition Submission Drawings	2/22/12

3rd Floor Lighting
Plan

Date Issue Date

E5

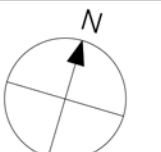

Scale 3/32" = 1'-0"

BASEMENT ELECTRICAL PLAN:

Prominent spaces in the basement include the community pool area and associated locker rooms, the community lobby area which leads to the pool, and the main mechanical/electrical rooms which house the building's unique cogeneration system. Refer back to the Lighting/Electrical Narrative for more in-depth analysis and renderings of these spaces and also refer to the Integration Narrative and Drawings for a look at how the team collaborated and designed the electrical systems with other engineering disciplines to create maximum project value.

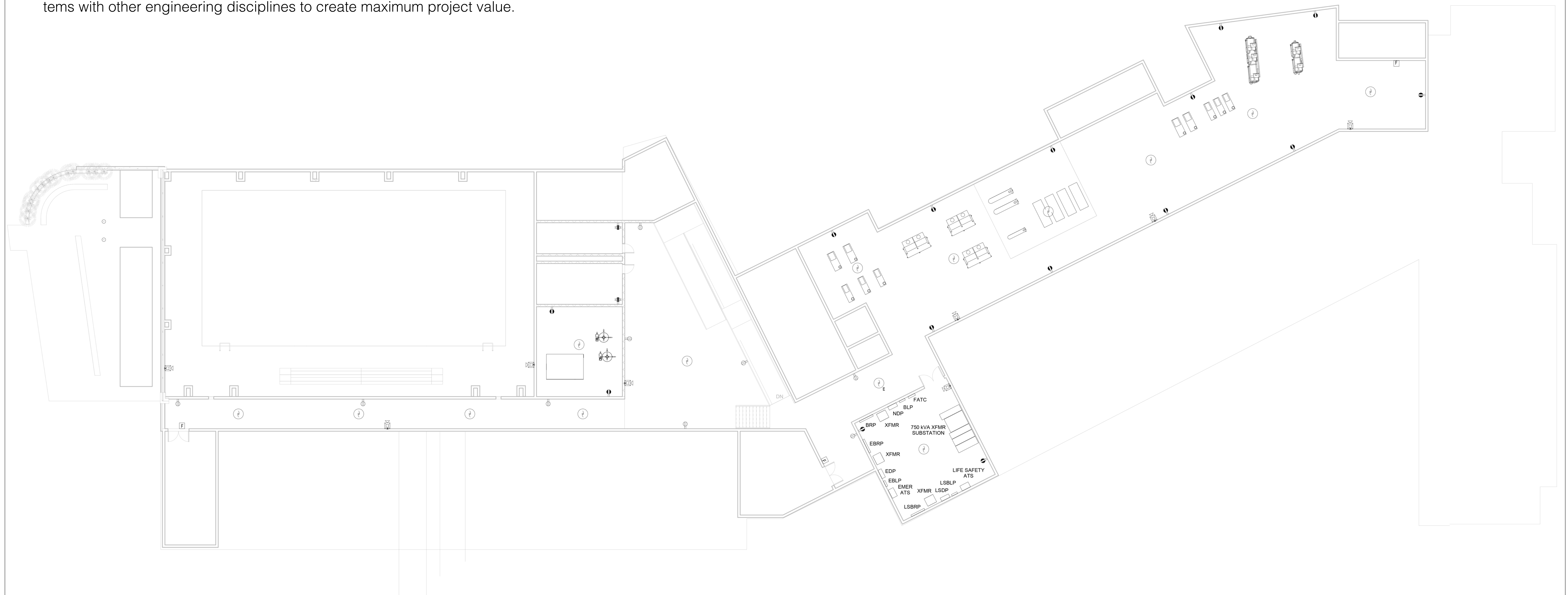

1 Basement Power
3/32" = 1'-0"

ASCE Charles Pankow Foundation
Architectural Engineering
Student Competition

Team Number 05-2013

No.	Description	Date
1	Competition Submission Drawings	2/22/12

**Basement Power
Plan**

Date Issue Date

E6

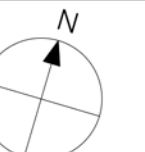

Scale 3/32" = 1'-0"

FIRST FLOOR ELECTRICAL PLAN:

Prominent spaces on the first floor include the multi-purpose gymnasium space and school kitchen area, which as mentioned before will also be utilized when the school functions as a natural disaster shelter. This floor also houses school administrative offices, 12 student classrooms, and a 24 hour community clinic. Refer back to the Lighting/Electrical Narrative for more in-depth analysis and renderings of these spaces and also refer to the Integration Narrative and Drawings for a look at how the team collaborated and designed the electrical systems with other engineering disciplines to create maximum project value.



1 First Floor Power
1" = 12'-6"

ASCE Charles Pankow Foundation
Architectural Engineering
Student Competition

Team Number 05-2013

No.	Description	Date
1	Competition Submission Drawings	2/22/12

1st Floor Power
Plan

Date Issue Date

E7

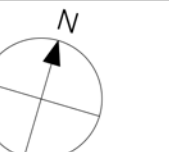

Scale 1" = 12'-6"

SECOND FLOOR ELECTRICAL PLAN:

Prominent spaces on the second floor include the school library, art room, and large conference room. This floor also houses 13 student classrooms. Refer back to the Lighting/Electrical Narrative for more in-depth analysis and renderings of these spaces and also refer to the Integration Narrative and Drawings for a look at how the team collaborated and designed the electrical systems with other engineering disciplines to create maximum project value.



① Second Floor Power
1" = 12'-6"

ASCE Charles Pankow Foundation
Architectural Engineering
Student Competition

Team Number 05-2013

No.	Description	Date
1	Competition Submission Drawings	2/22/12

2nd Floor Power
Plan

Date Issue Date

E8

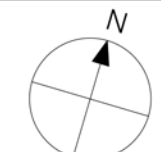

Scale 1" = 12'-6"

THIRD FLOOR ELECTRICAL PLAN:

The third floor is primarily dedicated to student classrooms with a total of 13. The third floor also features the buildings outdoor green roof area. Refer back to the Lighting/Electrical Narrative for more in-depth analysis and renderings of these spaces and also refer to the Integration Narrative and Drawings for a look at how the team collaborated and designed the electrical systems with other engineering disciplines to create maximum project value.



① Third Floor Power
3/32" = 1'-0"

ASCE Charles Pankow Foundation
Architectural Engineering
Student Competition

Team Number 05-2013

No.	Description	Date
1	Competition Submission Drawings	2/22/12

3rd Floor Power
Plan

Date Issue Date

E9

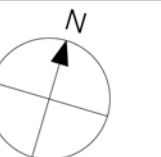

Scale 3/32" = 1'-0"

Electrical Riser

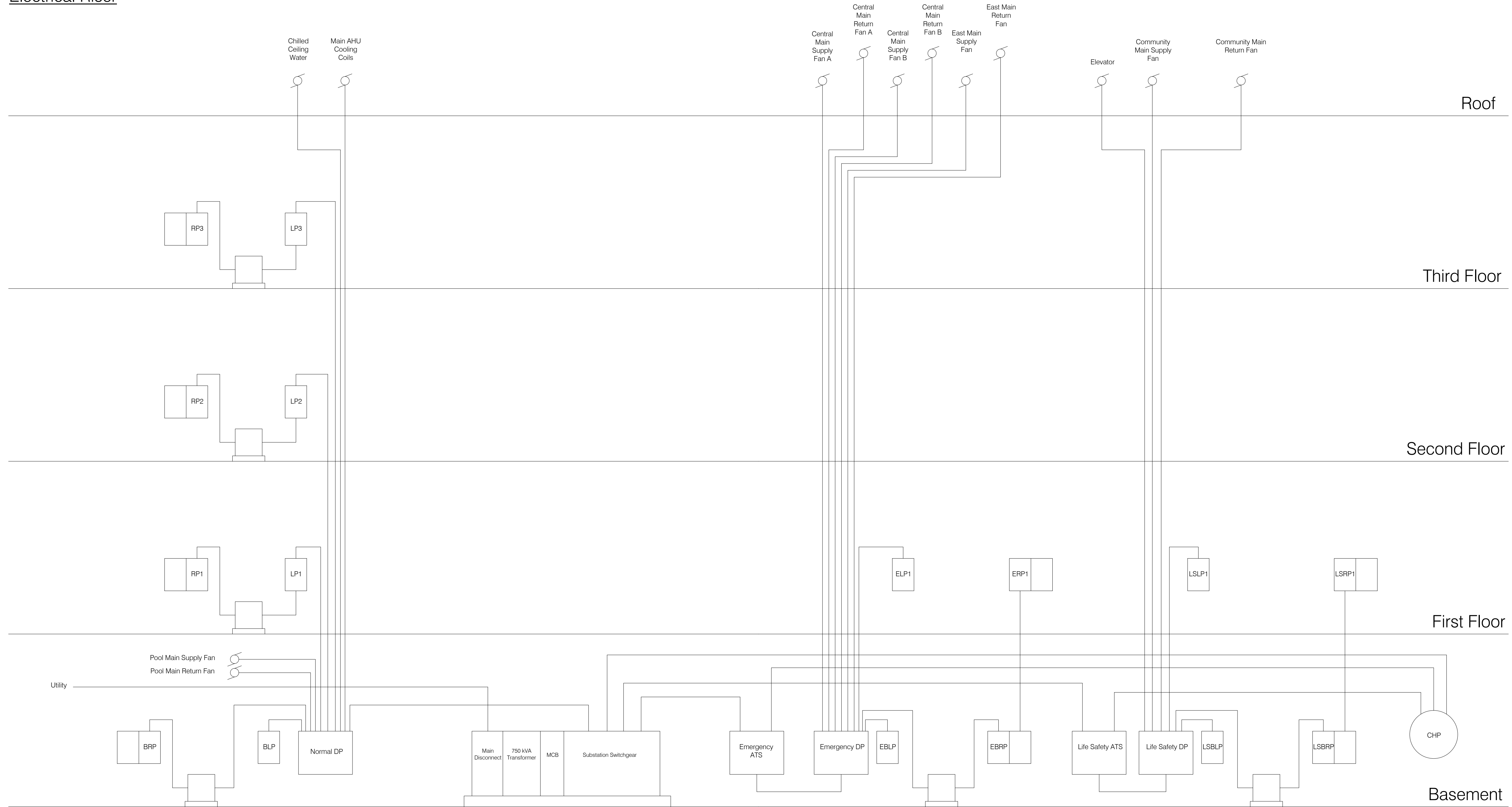

Fire Alarm Riser

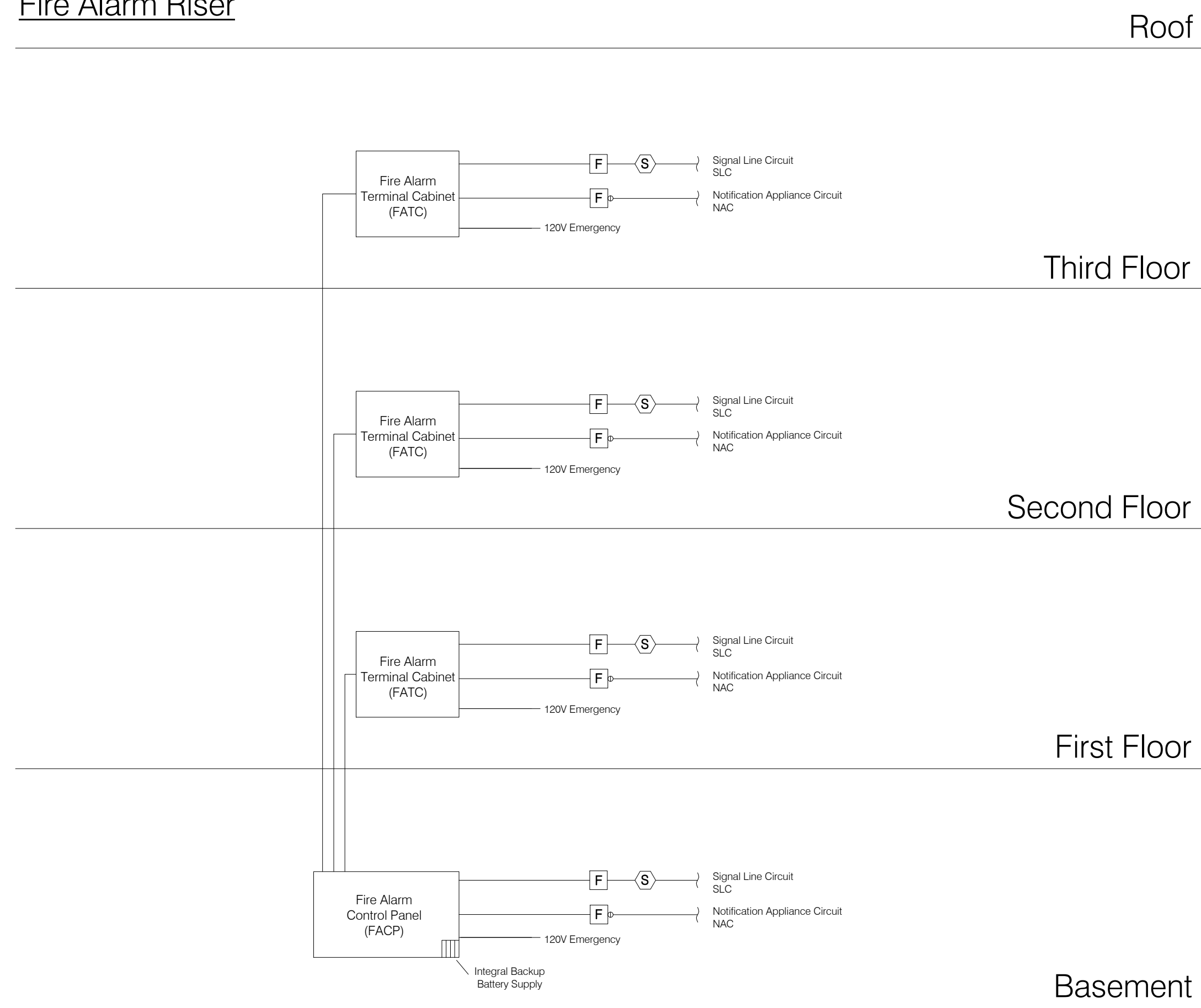

Telecom Riser

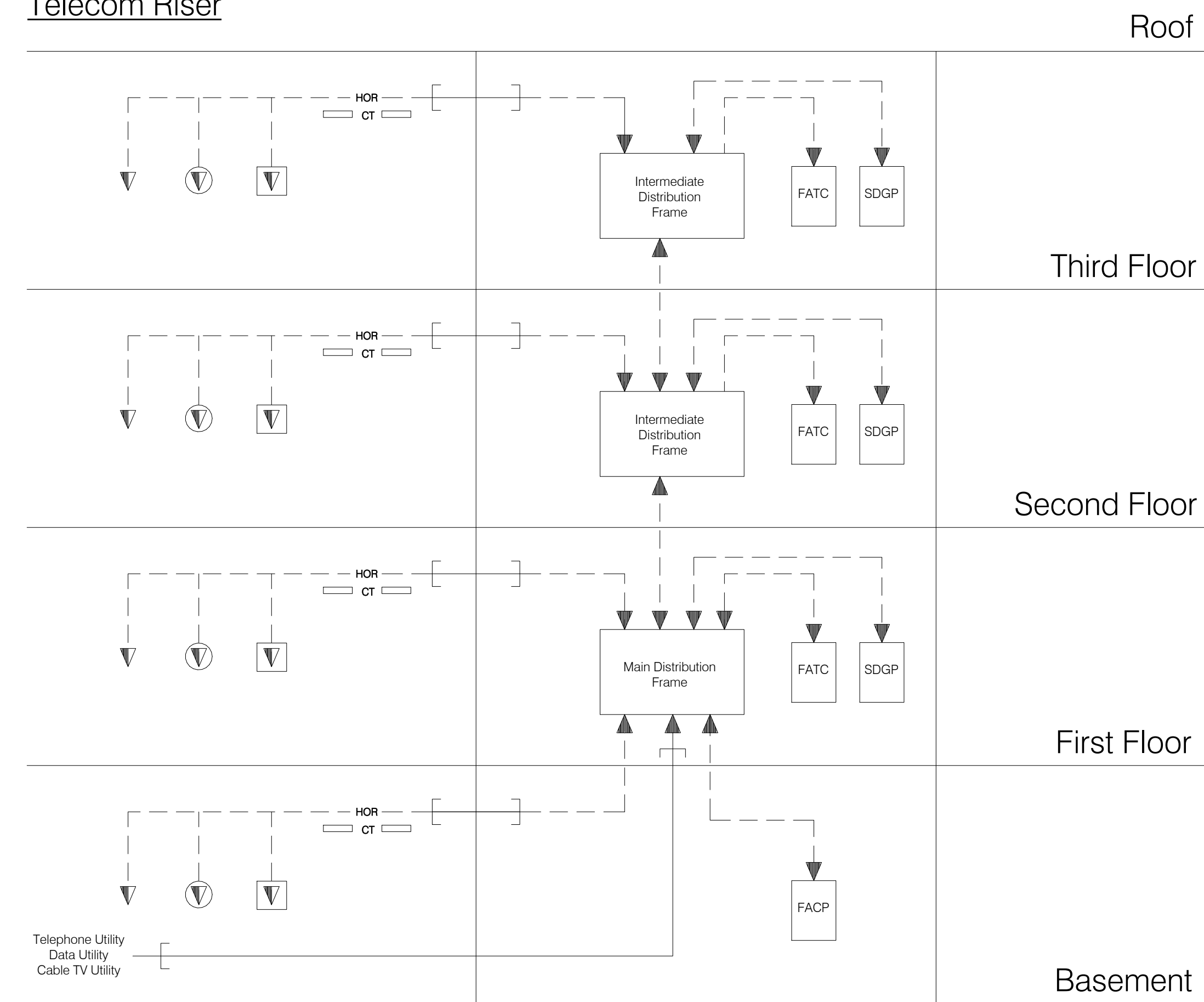

ASCE Charles Pankow Foundation
Architectural Engineering
Student Competition

Team Number 05-2013

No.	Description	Date
1	Competition Submission Drawings	2/22/12

Riser Diagrams

Date Issue Date

E10

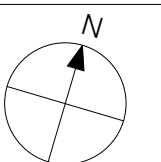

Scale