

Lighting Solutions

HIGH INTENSITY SCENE LIGHTING



FRC

A Safe Fleet Brand

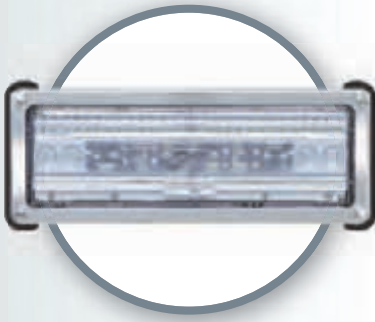

LED OVERVIEW 4 - 5

LED SCENE LIGHTING

Spectra	6
Spectra Surface Mount	7
Spectra MAX	8
Spectra MAX Surface Mount	8
Spectra MAX-S	9
Spectra MS	10
Spectra Slim Profile 900 / 950	11
CrestLight	12 - 13
Evolution II	14 - 15

HALOGEN SCENE LIGHTING

Optimum	16
Focus	17
Magnafire	18 - 19

LAMPHEAD GUIDE 20 - 21

TELESCOPIC POLES

TwistLock	22 - 23
KwikRaze	24 - 25

RECESSED & SURFACE MOUNTS

Spectra / Spectra Max	26
Spectra 900 / 950	26
Evolution II	26
Optimum	26
Focus	26
Magnafire	27
KwikStrike	28

LIGHTING MOUNTS

Portable 29
 TwistLock Tripods 30 - 31
 Non-Telescopic 32 - 33
 Brow 34 - 35

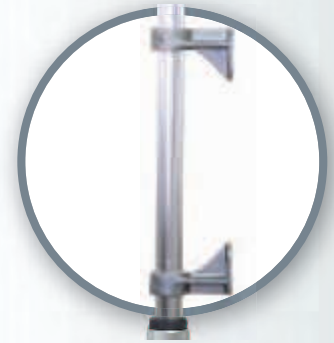

LIGHTING OPTIONS 36 - 37



SPECIALIZED LIGHTING

SoBrite 38 - 39
 WorkPro 40
 VantagePoint 41
 Collins Dynamics FX 42
 DuroLumen 43
 Sunstrip 44
 Firefly 45



TECHNICAL SPECIFICATIONS

Telescopic Poles 46 - 47
 Tripods / Brackets / Mounts 48 - 49
 KwikStrike / VantagePoint / Crestlight 49
 Optimum Lampheads 50
 Focus / Evolution II Lampheads 51
 Spectra Series Lampheads 52
 Sunstrip / Firefly / SoBrite 52
 Magnafire / Collins / WorkPro 53



ORDERING INSTRUCTIONS 54 - 55



MORE Light LESS Power

LEDs Produce More Light

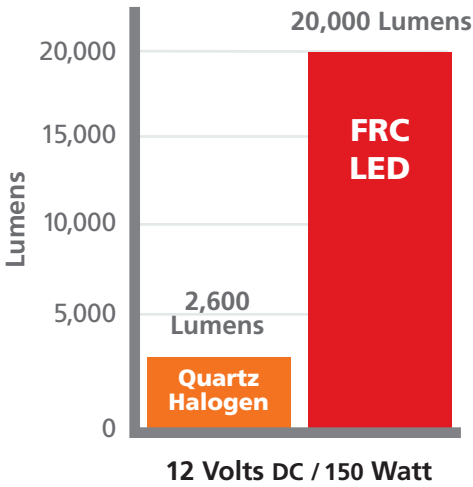

A quartz halogen bulb utilizes 8% of the energy supplied to produce light. By comparison, LEDs use 40% of the supplied energy to produce light.

LEDs Are More Efficient

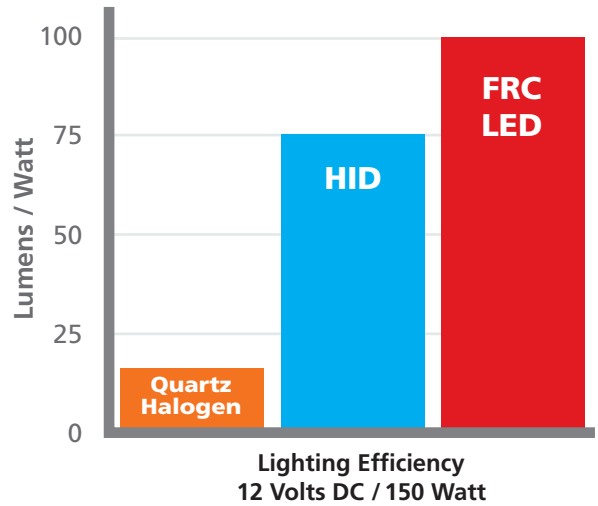

LEDs produce more than 5 times the amount of light as an incandescent bulb while consuming the same amount of power.

Actual side-by-side comparison of Halogen vs LED lighting



MORE Efficient LONGER Life

Different types of light sources that use the same amount of power (watts) can have very different luminous efficacy (lumens / watt) and therefore different lighting efficiency.

LEDs Outlast Traditional Bulbs

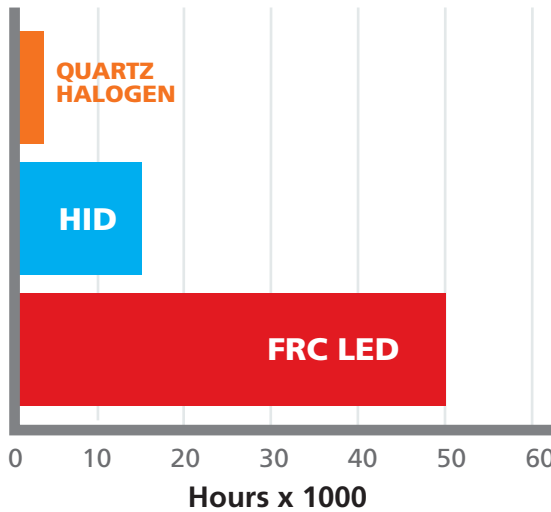

- The typical operational life of an LED is 50,000 hours compared to the average life of an incandescent bulb, which is approximately 2,000 hours.
- LEDs can operate well past the lifetime of the average apparatus.
- Because of their inherent solid state design without filaments, LEDs are much more rugged than incandescent bulbs and can better withstand shock and vibrations.

LED lighting is whiter, brighter, and will outlast traditional bulbs.



Fire Research LED lampheads are designed to operate in a range that is as close to natural daylight as possible.

Closer to Natural Daylight

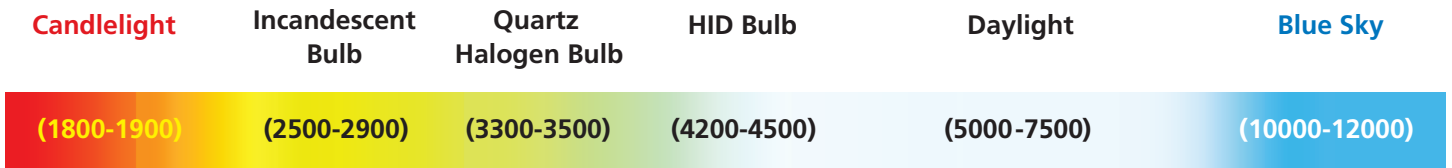

Color Temperature (measured in Kelvins)



All FRC LED Lampheads are rated 5500 - 7000K. As close to natural daylight as a light can get.

Visible light has a color temperature scale from 1800 to 12,000 Kelvins (K). As you can see, a candle burns at around 1800K and a blue sky is at 10,000K. Daylight is between 5000K and 6500K. Different types of light sources emit a different color of light. The color of the light is measured in Kelvins and is not a measure of brightness.



SPECTRA



20,000 Lumens of Bright Light

"SURE GRIP" HANDLE STAYS COOL TO THE TOUCH WHEN HOLDING LAMPHEAD

FLOOD LEDs (TOP & BOTTOM ROWS) ILLUMINATE THE WORK AREA

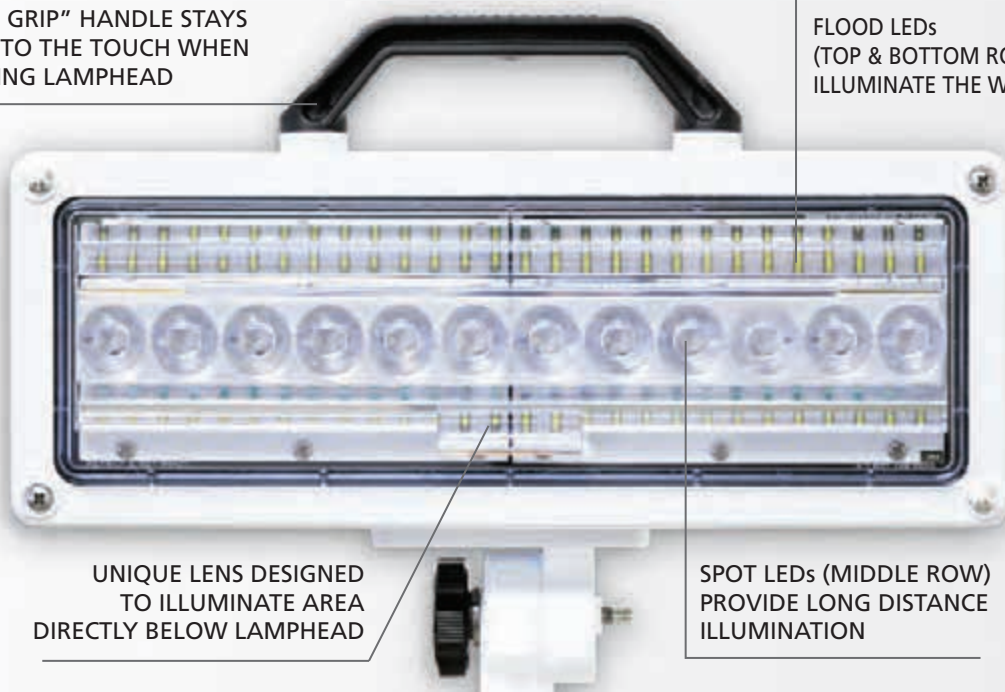

UNIQUE LENS DESIGNED TO ILLUMINATE AREA DIRECTLY BELOW LAMPHEAD

SPOT LEDs (MIDDLE ROW) PROVIDE LONG DISTANCE ILLUMINATION

Shown with standard white bezel-

black & chrome also available

- Slimmest LED Profile in the Industry
- Instant-On at Full Intensity
- Available in 15,000 or 20,000 Lumens
- Innovative Cooling Fins Provide Higher Efficiency
- Available on FRC Pole, Brow, Fixed or Surface Mounts
- Unique Combination of Flood / Spot LEDs
- Longer LED Life Rated at 50,000 Hours
- Five Year LED Lighting Warranty



Puts All Light Directly on the Work Area & Scene Beyond

Three rows of LEDs - Top and bottom rows are flood LEDs designed to light up the work area. The middle row of focused spot LEDs provide long distance illumination.

SPECTRA's unique lens design provides a smooth and uniform flood and spot combination bringing firefighters the widest light pattern for improved work area visibility as well as illuminating objects at a farther distance.



SPECTRA's advanced lens design and arrangement of powerful LEDs deliver bright LED light where its needed



SPECTRA Surface Mount



15,000 Lumens of Bright Light

RUBBER GASKET
PROTECTS VEHICLE
SURFACE

SPOT LEDs PROVIDE
LONG DISTANCE ILLUMINATION

ROW OF FLOOD LEDs (TOP & BOTTOM)
ILLUMINATE THE WORK AREA

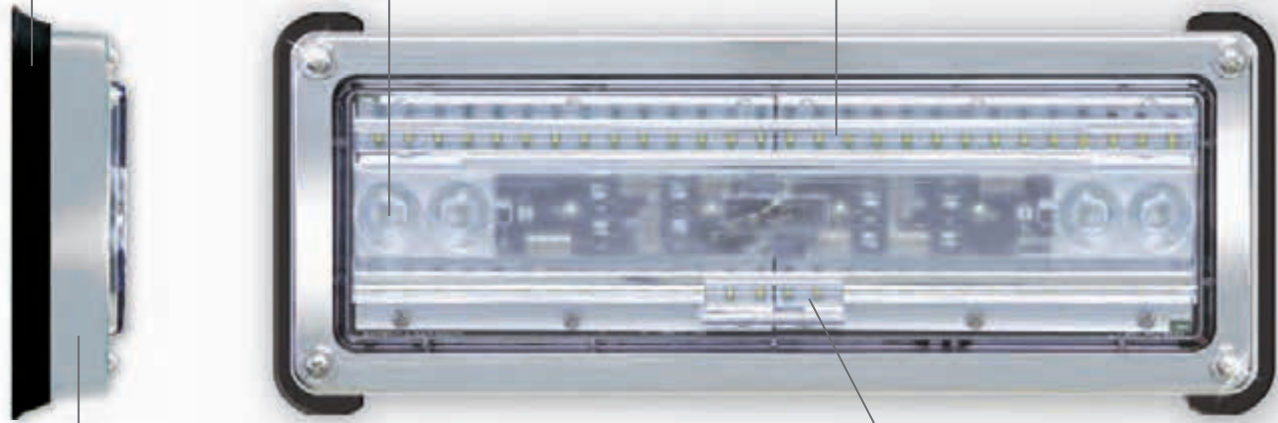

SLIMMEST PROFILE SURFACE MOUNT - ONLY 1 3/4"

UNIQUE LENS DESIGNED
TO ILLUMINATE AREA
DIRECTLY BELOW LAMPHEAD

Shown with standard chrome bezel - white and black also available



SPECTRA surface mount has an extremely low profile extending less than 1-3/4" from the panel.



- **Surface Mount LED Lamphead Generates a Combined Flood & Spot Light Pattern**
- **Slim Body Design Depth of Only 1 3/4" Keeps Lamphead Closer to Vehicle**
- **Surface Mount is Easier and Faster to Install**
- **Available in 12/24 VDC or 120/240 VAC**

AC surface mount model SPA260 requires 6 3/8" w x 4 11/16" h cut-out

SPECTRA MAX



The Brightest LED Scene Light Available

"SURE GRIP" HANDLE STAYS COOL TO THE TOUCH WHEN HOLDING LAMP HEAD

2 ROWS OF INTENSE FLOOD LEDs PROVIDE THE ULTIMATE IN SCENE & WORK AREA ILLUMINATION

CENTER ROW OF BRIGHT SPOT LEDs OFFER LONG DISTANCE ILLUMINATION

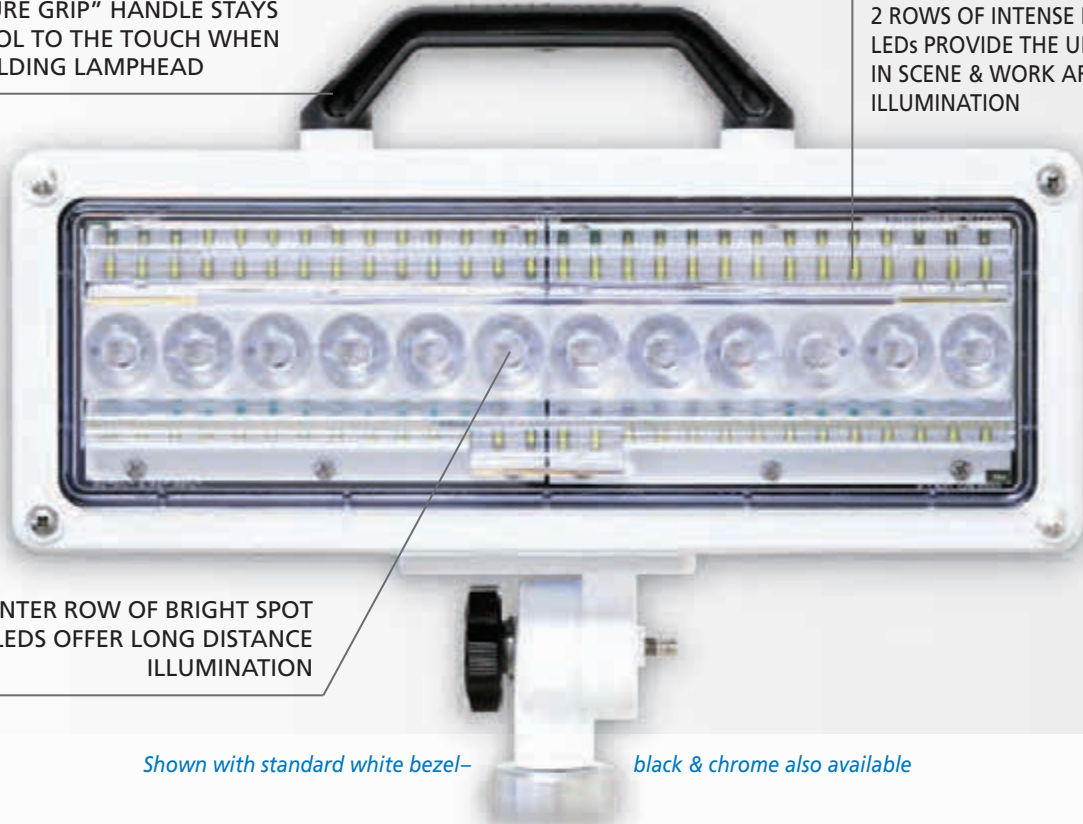

Shown with standard white bezel-

black & chrome also available

28,000 Lumens of Ultrabright Light

- Available in 12/24 VDC or 120/240 VAC
- Choose Pole, Brow, Fixed or Surface Mounts

The Brightest Surface Mounted LED Lamphead Available



SPECTRA-MAX Surface Mount

- 20,000 Lumens of ultrabright light to improve vehicle performance



SPECTRA **MAX-S**



Maximum Spot & Flood Light Capability

"SURE GRIP" HANDLE STAYS COOL TO THE TOUCH WHEN HOLDING LAMPHEAD

3 ROWS OF POWERFUL SPOT LEDs ILLUMINATE OBJECTS FARTHER AWAY

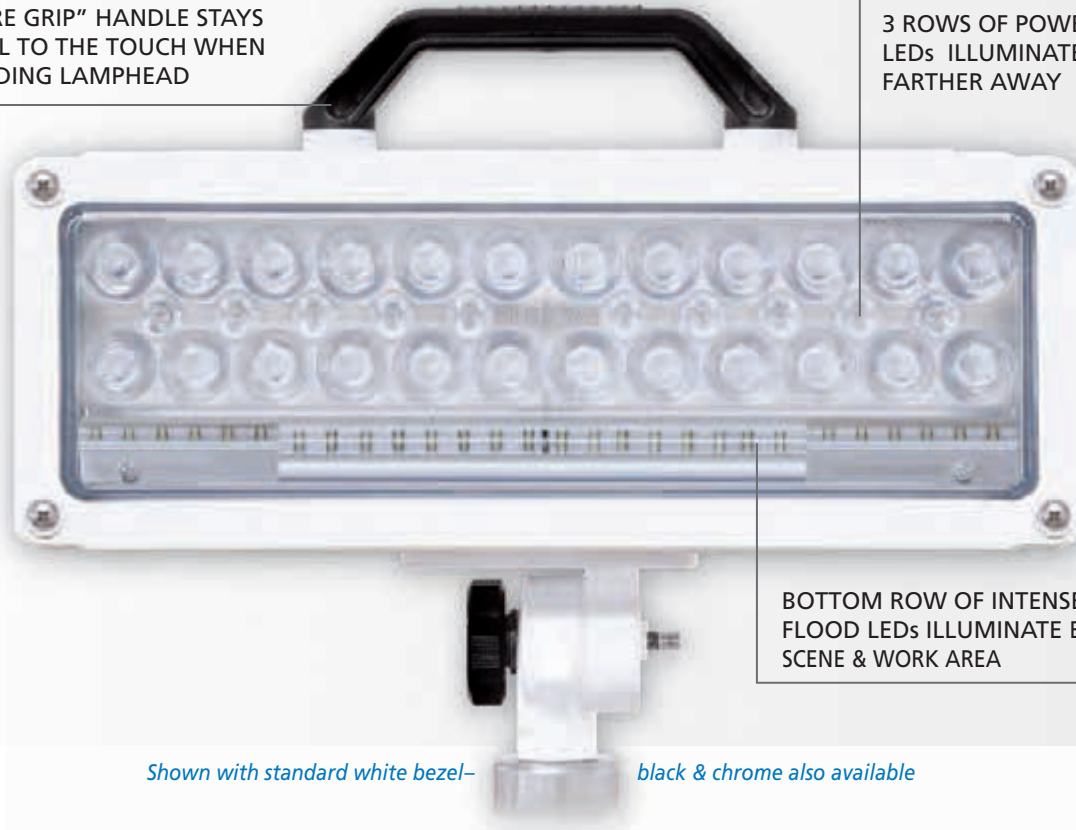

BOTTOM ROW OF INTENSE FLOOD LEDs ILLUMINATE ENTIRE SCENE & WORK AREA

Shown with standard white bezel—

black & chrome also available

28,000 Lumens of Bright Spot / Flood Light

- SPECTRA MAX-S combines a flood light with an intense long-distance spotlight to let you see objects farther away
- Select Spot (14,000 Lumens) or Flood (14,000 Lumens) Light Patterns or 28,000 Lumens Spot/Flood Combination
- Available in 12/24 VDC or 120/240 VAC
- Choose Pole, Brow, or Fixed Mounts



SPECTRA MAX Series Lampheads deliver maximum scene & work area visibility

SPECTRA **MS**



Slim, Compact & Powerful

SURE-GRIP
MOLDED HANDLE

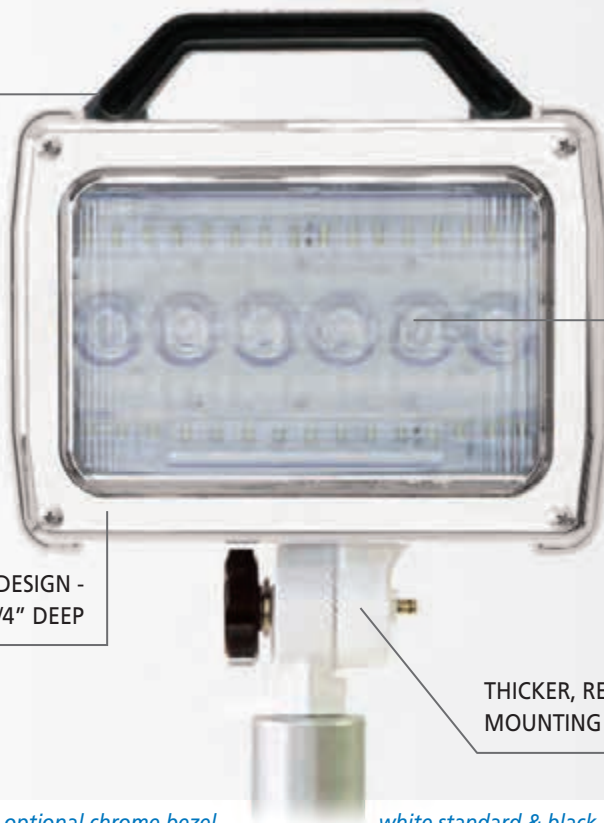

POWERFUL SPOT/FLOOD
LEDs DELIVER MORE
LIGHT ECONOMICALLY
& EFFICIENTLY

COMPACT LAMPHEAD DESIGN -
ONLY 8 3/4" WIDE BY 3 1/4" DEEP

THICKER, REINFORCED
MOUNTING KNUCKLE

Shown with optional chrome bezel-

white standard & black also available

14,000 Lumens **of Bright Light**

- SPECTRA MS combines spot & flood LEDs for a uniform light pattern
- Compact & Powerful - Measures just 8 3/4" wide by 3 1/4" deep
- Efficient - More LED Light Using Less Power
- Economical LED solution for Upgrading Your Vehicle
- Available in 12/24 VDC or 120/240 VAC
- Choose Pole, Brow, or Fixed Mounts



SPECTRA Slim Profile



Designed for Ambulance & Emergency Response Vehicles

SPECTRA 950 Perimeter Illumination

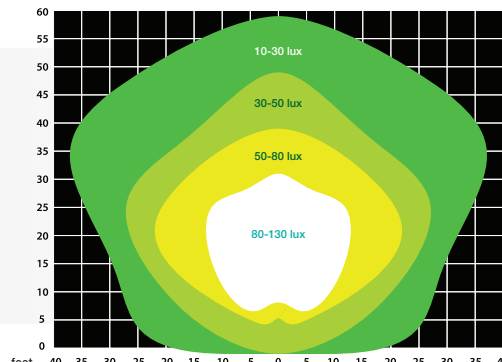
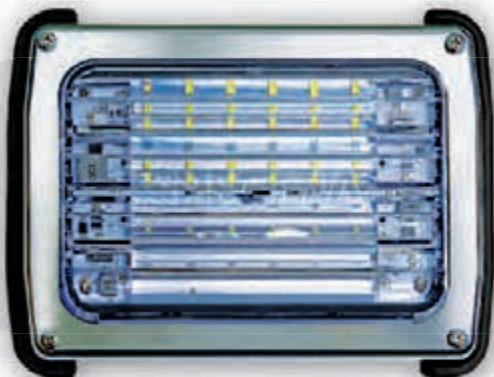

Unique SPA950 pattern at 8' height aimed horizontal (0° inclination)

SLIM PROFILE SURFACE MOUNT LESS THAN 2" • COMPACT SIZE 9" x 6 3/4"

- 5,000 Lumens of light projects 170° illuminating underneath and across to light up the body of vehicle and immediate work area
- Complex single lens optic design engineered for unmatched performance
- Easy installation, no panel cut-out. Rubber gasket protects vehicle surface
- Operating hours: 50,000+

SPECTRA 900 Scene Illumination



- Ultra-Bright 7,000 Lumen LED scene lighting using 24 white LEDs
- Innovative lens redirects the light along the vehicle and directly onto the scene
- Easy installation, no panel cut-out
- Heat sink design offers greater light output
- Rubber gasket protects vehicle surface

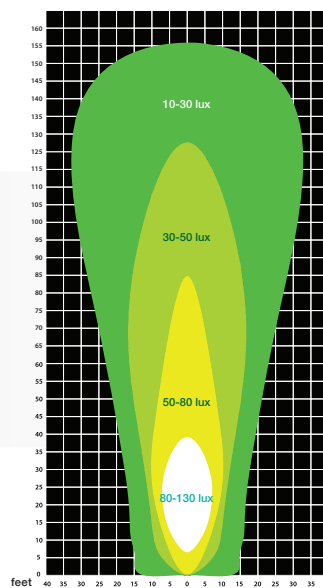

Unique SPA900 pattern at 8' height aimed horizontal (0° inclination)

SLIM PROFILE SURFACE MOUNT LESS THAN 2" • COMPACT SIZE 9" x 6 3/4"

SPECTRA 950 / 900 Shown with standard chrome bezel – black & white also available



The Best Brow Light for the Job



SLIMMEST BROW LIGHT AVAILABLE AT LESS THAN 2"

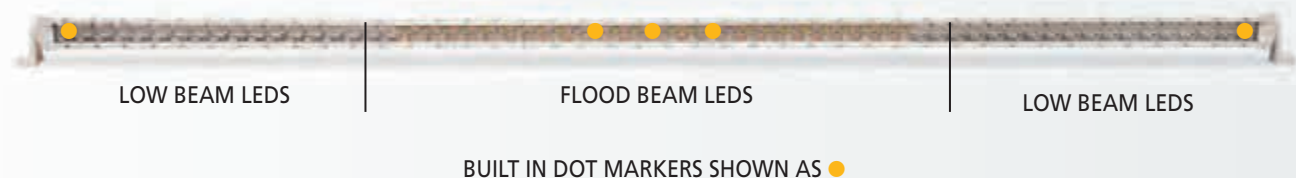

LOW BEAM LEDS

FLOOD BEAM LEDS

LOW BEAM LEDS

BUILT IN DOT MARKERS SHOWN AS ●

Lowest Profile Brow Mount Scene Light

- Lowest profile scene light in the industry at just under 2"
- Only brow lighting in the industry with individual low beam optic LED's
- Built in DOT marker light
- Independent control for the marker, flood and low beam LEDs
- Ideal for working vehicle scenes
- Will not blind passing traffic or emergency personnel on the opposite side of the scene



Exclusive low-beam lens directs flood light out and downward.

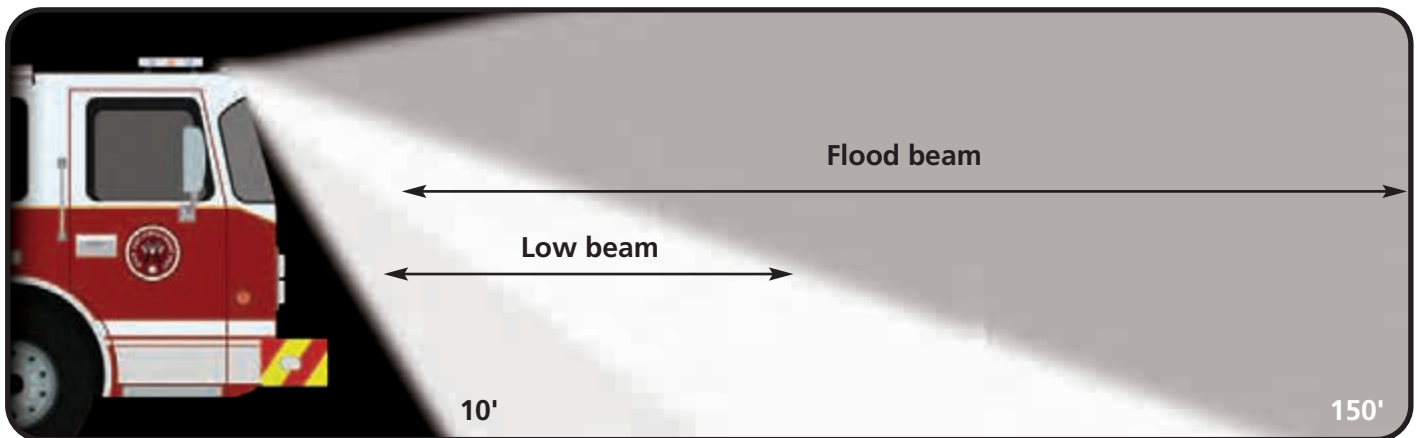

Low beam light projection on a typical 8' high apparatus will provide forward coverage up to 150' and side coverage to 60' wide.



Choose the model that's best for you.

CLA100 - A68	• 71.6" long	- white narrow flood, white low beam, amber DOT marker	17,800 Lumens
CLA100 - A62	• 65.2" long	- white narrow flood, white low beam, amber DOT marker	16,100 Lumens
CLA100 - A49	• 42.5" long	- white narrow flood, white low beam, amber DOT marker	12,500 Lumens
CLA100 - A14	• 17.5" long	- white low beam	2,600 Lumens

Length measurements include mounting brackets

EVOLUTION II

The Cost Effective, Affordable LED Solution.
Ideal for Upgrading Your Existing Fleet

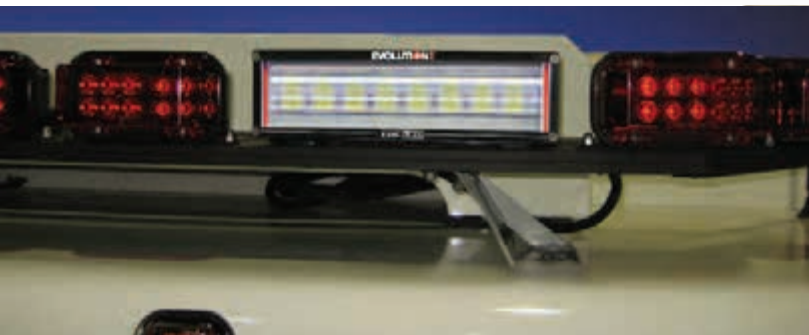

EVOLUTION II lampheads easily mount to emergency warning lightbars.

20,000 Lumens of Bright Light



- Brighter Light - More than 20,000 Lumens of UltraBright LED Light
- Whiter Light – Closest Thing to Natural Sunlight
- Uniform High Quality White Light with the Widest Light Pattern
- Long Operating Hours – Rated at 50,000 Hours
- Parabolic Reflector & Lens Designed to Direct All the Light Onto the Scene
- Lamphead Can Be Used With 12 or 24 Volt DC systems (13/6.5 amps)
- Full Brightness at Power On - Instant Restarts

EVOLUTION II MS is compact with an ultrabright light output of 11,000 lumens.

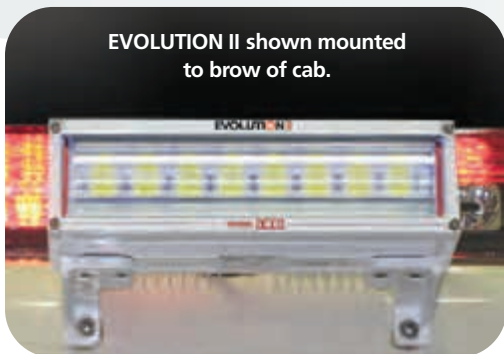

Evolution II fits all mounts. Easily upgrades your existing vehicles.



Advanced Lens Design **See All the Action Further Away!**

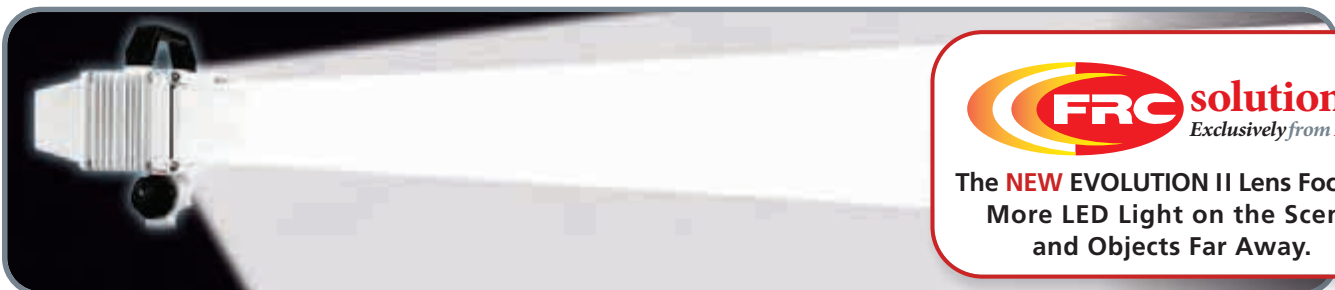

FRC solutions.
Exclusively from FRC

The **NEW** EVOLUTION II Lens Focuses More LED Light on the Scene and Objects Far Away.



SURE-GRIP
MOLDED HANDLE

TOUGH
ALUMINUM
HOUSING

SOCKET HEAD
SCREWS FOR
GREATER
SERVICEABILITY
DURING THE LIFE OF
THE PRODUCT

LARGE, ROUND KNOB MAKES
OPERATION WITH A GLOVED
HAND EASIER

LARGE CURVED LENS FOR
MAXIMUM LIGHT
TRANSMISSION AND GREATER
HEAT DISSIPATION

PRODUCES A WIDE UNIFORM 150° HORIZONTAL
BEAM TO LIGHT THE AREA

A Revolutionary Design

The **OPTIMUM** is a revolutionary lamphead that puts more light on the scene without the need for an increase in power. The **OPTIMUM** lamphead provides the maximum transfer of light from the bulb to the scene.

Setting the Trend

The **OPTIMUM** uses a uniquely designed, vacuum deposit, polished reflector to maximize light emission. **OPTIMUM's** large curved front lens and exclusive "head down" shape produce a uniform beam that lights up an area 100° vertically by 150° horizontally.

ADVANCED TECHNOLOGY

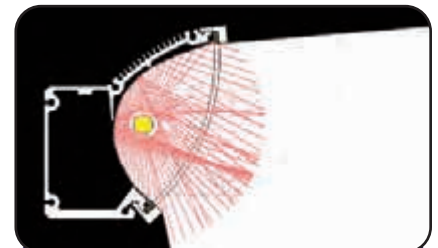

*A cross section of an **OPTIMUM** lamphead showing its unique reflector that directs 100% of the light onto the work and action areas.*

FOCUS[®] Versatile Low Profile Lamphead

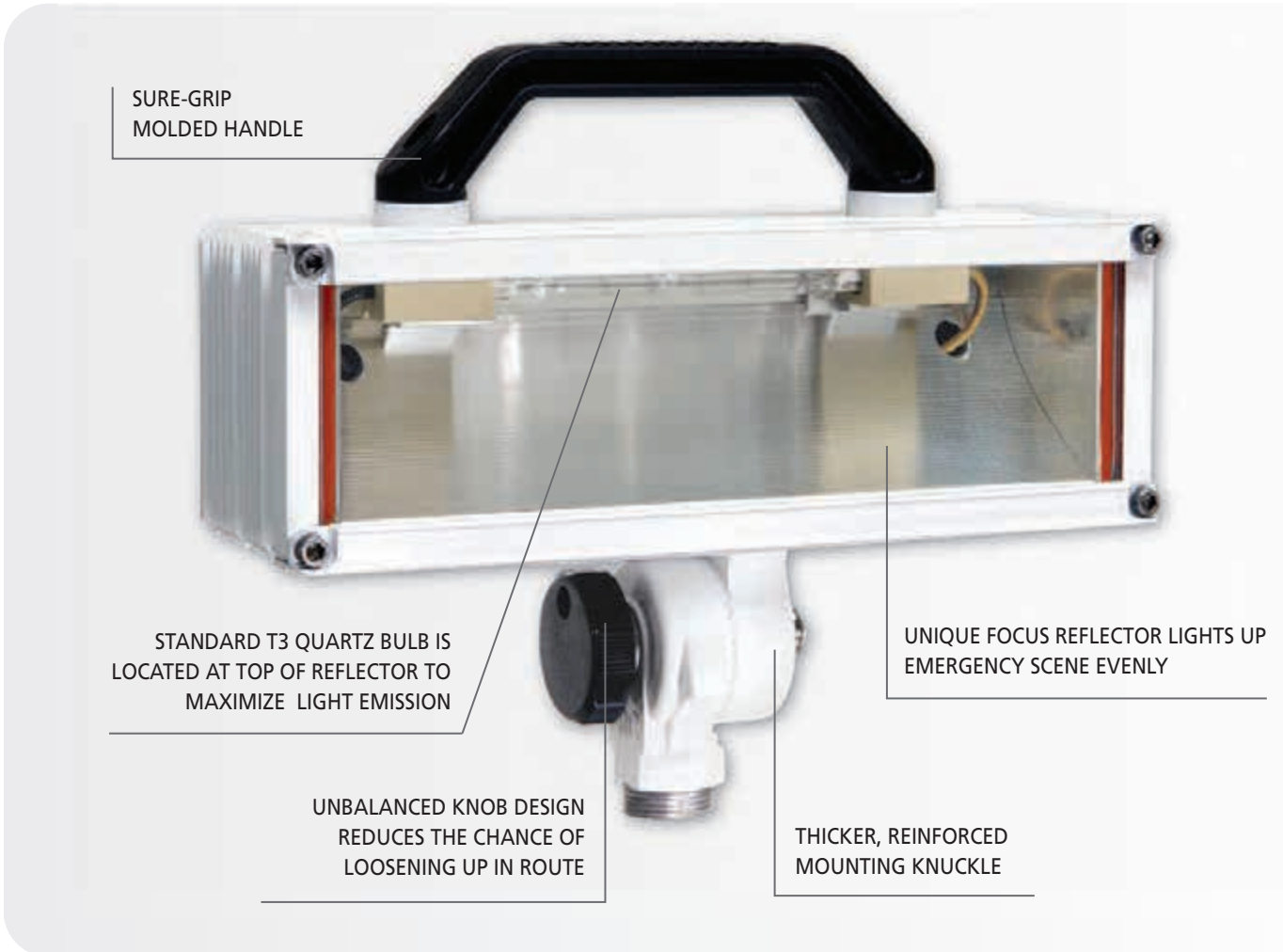

Don't Waste Precious Light

The high intensity FOCUS lamphead uses a uniquely designed patented reflector to eliminate wasted light. It is designed to focus 100% of the light produced into the area where it is needed. Built tough, the compact design allows it to be mounted in places that traditional lighting fixtures do not fit.



The Low Profile FOCUS lamphead provides many mounting choices.

- Telescopic Pole
- Recessed
- Fixed
- Portable
- Brow
- Under Aerial

ADVANCED TECHNOLOGY

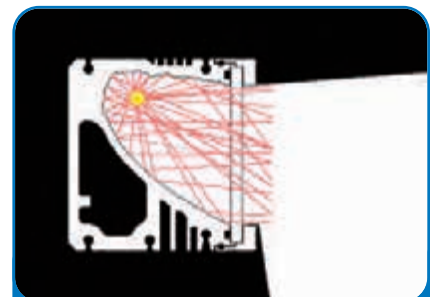

A cross section of the FOCUS lamphead showing its unique reflector surfaces that redirect light waves for even, bright scene lighting where it's most needed.

MAGNAFiRE



ROUNDED PARABOLIC
CORNERS INCREASE
EFFICIENCY OF LAMP

ONE-PIECE LENS ASSEMBLY
FOR QUICK BULB OR
REFLECTOR REPLACEMENT

MIRROR-POLISHED REFLECTOR HAS INCREASED
VERTICAL SURFACE AREA FOR MAXIMUM LIGHT



The **Magnafire** floodlight incorporates all of the features necessary for today's public safety professionals: High-intensity light output, compact design, and durability. Its mirror-polished reflector has increased vertical surface area and rounded parabolic corners for optimum efficiency. The result is a BRIGHT, SMOOTH floodlight beam pattern that lets you put light where you need it.

Economical and Reliable

Magnafire 5000



Magnafire 3000



Strength and Simplicity

Magnafire lamphead housing, switch box, swivel knuckle, and lens frame are made from die-cast aluminum rather than extruded parts. This rugged die-cast construction ensures years of reliable service.





Service Made Easy

The one-piece lens assembly allows for easy field replacement of the bulb, lens, and reflector.

BULBS ● Quartz Halogen ■ Light Emitting Diode (LED)

SPECTRA SERIES

12V•24V  IP68	■ Q15	12/24V	13.9/6.9A	15,000 Lumens
	■ Q20	12/24V	18.3/9.2A	20,000 Lumens
120V  IP68	■ K15*	120 V	1.4A	15,000 Lumens
	■ K20	120 V	1.8A	20,000 Lumens
240V  IP68	■ J15*	240 V	0.7A	15,000 Lumens
	■ J20	240 V	0.9A	20,000 Lumens



* Surface mount SPECTRA models only



SPECTRA

SPECTRA LED Lampheads output an impressive 20,000 lumens of super bright LED light. The advanced lens and arrangement of LEDs generate a unique combination flood and spot light pattern.

SPECTRA MAX SERIES

12V•24V IP68 	■ Q20*	12/24V	13.8/6.9A	20,000 Lumens
	■ Q28	12/24V	19.2/9.6A	28,000 Lumens
120V  IP68	■ K20*	120 V	1.4A	20,000 Lumens
	■ K28	120 V	2.8A	28,000 Lumens
240V  IP68	■ J20*	240 V	0.7A	20,000 Lumens
	■ J28	240 V	1.4A	28,000 Lumens



* Surface mount SPECTRA MAX models only



SPECTRA MAX

SPECTRA MAX Lampheads deliver 28,000 lumens of ultrabright LED light in a uniform light pattern providing maximum scene & work area visibility.

SPECTRA MAX-S SERIES



12V•24V IP68 	■ A28	12/24V	20.8/10.4A	28,000 Lumens
120V  IP68	■ B28	120 V	2.8A	28,000 Lumens
240V  IP68	■ C28	240 V	1.4A	28,000 Lumens



SPECTRA MAX-S

SPECTRA MAX-S Lampheads output 28,000 lumens of ultrabright LED light. The lamphead combines a flood light with an intense long distance spotlight to let you see objects farther away.

SPECTRA MS SERIES



12V•24V IP68 	■ R14	12/24V	10.8/5.4A	14,000 Lumens
120V  IP68	■ T14	120 V	1.4A	14,000 Lumens
240V  IP68	■ U14	240 V	0.7A	14,000 Lumens



SPECTRA MS

SPECTRA MS LED Lampheads are slim, compact, and provide an efficient 14,000 lumens of bright LED light.

SPECTRA 900/950 SERIES

SPECTRA 900 Scene Illumination				
12V•24V 	■ Q70	12/24 V	6.0/3A	7,000 Lumens
SPECTRA 950 Perimeter Illumination				
12V•24V 	■ Q50	12/24 V	5.0/2.5A	5,000 Lumens



SPECTRA 900/950

SPECTRA 900 LED was designed specifically to focus all light directly on the scene.

SPECTRA 950 LED casts light underneath and across to illuminate vehicle and work area.

Both lights are easy to install with NO PANEL CUT OUT required.

CRESTLIGHT

CrestLight low profile LED scene lights provide the flexibility to offer the proper light for the job. The CrestLight is a combination of three different lights, white narrow flood, white low beam, and amber DOT markers.



CRESTLIGHT SERIES

12V•24V

■	A14	12/24 V	4.2/2.1A	2,600 Lumens
■	A49	12/24 V	13.7/6.8A	12,500 Lumens
■	A62	12/24 V	17.5/8.7A	16,100 Lumens
■	A68	12/24 V	19.5/9.7A	17,800 Lumens

EVOLUTION II

EVOLUTION II low profile LED lampheads generate up to 20,000 lumens of ultra bright white light. The unique LED arrays and lens produce more usable light in a compact lamphead.



EVOLUTION II SERIES

12V•24V

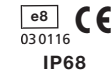

■	V11	12/24 V	7.5/3.75A	11,000 Lumens
■	V15*	12/24 V	11.0/5.5A	15,000 Lumens
■	V20	12/24 V	13.0/6.5A	20,000 Lumens

* Recessed EVOLUTION II model only

MAGNAFIRE

The **MagnaFire lampheads** incorporate all of the features necessary for today's public safety professionals: High-intensity light output, compact design, and durability. Its mirror-polished reflector has increased vertical surface area and rounded parabolic corners for maximum efficiency.



Magnafire 3000 SERIES

120V



●	KR-35	500W	120V	4.2A	10,500 Lumens
●	KR-36	750W	120V	6.3A	20,600 Lumens

240V



●	KR-37	750W	240V	3.2A	16,100 Lumens
●	KR-3B	1000W	240V	4.2A	21,500 Lumens
●	KR-3D	1500W	240V	6.3A	35,800 Lumens

Magnafire 5000 SERIES

120V



●	KR-55	500W	120V	4.2A	10,500 Lumens
●	KR-56	750W	120V	6.3A	20,600 Lumens

240V



●	KR-57	750W	240V	3.2A	16,100 Lumens
---	-------	------	------	------	---------------

FOCUS

FOCUS Low Profile Lampheads were the first lampheads to introduce the concept of re-directing light with fifty parabolic curved and aimed surfaces. The innovative design directs light where it is needed.



FOCUS SERIES

12V•24V
CE

●	D15	150W	12V	12.5A	2,600 Lumens
●	D30	300W	12V	25.0A	5,200 Lumens
●	H30	300W	24V	12.5A	5,000 Lumens

120V



●	S30	300W	120V	2.5A	5,900 Lumens
●	S50	500W	120V	4.2A	10,500 Lumens
●	S75	750W	120V	6.3A	19,600 Lumens
●	M10	1000W	120V	8.3A	22,000 Lumens

240V



●	S72	750W	240V	3.1A	16,100 Lumens
●	M12	1000W	240V	4.2A	22,000 Lumens
●	M15	1500W	240V	6.25A	35,000 Lumens

OPTIMUM

OPTIMUM Lampheads utilize a super-efficient design to offer a maximum transfer of light from bulb to scene.



OPTIMUM SERIES

120V



●	S30	300W	120V	2.5A	5,900 Lumens
●	S50	500W	120V	4.2A	10,500 Lumens
●	S75	750W	120V	6.3A	19,600 Lumens
●	M10	1000W	120V	8.3A	22,000 Lumens

240V



●	S72	750W	240V	3.1A	16,100 Lumens
●	M12	1000W	240V	4.2A	22,000 Lumens
●	M15	1500W	240V	6.25A	35,000 Lumens

TWISTLOCK Telescopic Poles



- All FRC telescopic poles are made of anodized aluminum for maintenance free performance and longer service life.
- All extension poles rotate 360°
- All extension poles have the exclusive twist lock mechanism to secure the pole in position.
- All standard extension poles have a four foot retractable cord extending from the bottom for direct wiring.
- All outer tubes have a grooved surface.
- All pole mounted lampheads have a pivot in the mounting arm with a knurled knob to adjust the angle of elevation.



Model 510

Top Mount, Pull Up Telescopic Pole

- 3.25" round mounting flange is standard
- 2.5" square flange is available on the 510C and 510E (see insets)

OPTIONS:

- CL (custom length pole)
- SW (raised pole switch and indicator)
- TW (wire out of the top of the pole)

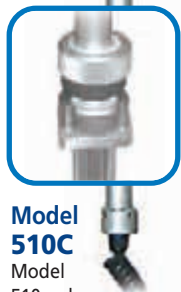

Model 510C

Model 510 pole with a Square Flange Option



Model 510E

Model 510 pole with a Square Flange Option for mounting in a 3" extrusion



Model 512

Thru The Roof, Push Up Telescopic Pole

- Extension pole has a knurled aluminum push-up handle
- A round, "no drip" mounting flange is provided

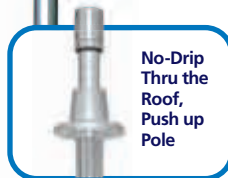

No-Drip Thru the Roof, Push up Pole

OPTIONS:

- CL (custom length pole)
- SW (raised pole switch and indicator)
- TW (wire out of the top of the pole)
- SR (steady rest bottom bracket)



Model 530

Side Mount, Push Up Telescopic Pole

- Extension pole has a knurled aluminum push-up handle
- Outer tube is grooved aluminum extrusion and qualifies as an NFPA compliant handrail
- Standard outer tube (shown) is 20". Choosing an optional 10" outer tube allows for a 40" extension

OPTIONS:

- CL (custom length pole)
- SW (raised pole switch and indicator)
- TW (wire out of the top of the pole)
- SR (steady rest bottom bracket)
- ST (10" outer tube)



Patented Safety Twist Lock

- Easy to use and can be operated in either direction.
- It can not jam or be over tightened.
- There is no protruding handle to snag gear or straps on.
- Knurled surface for a firm grip.
- The locking mechanism has no metal to metal contact. This spares the anodized aluminum poles from unnecessary wear and tear.





Model 540
Side Mount, Pull Up Telescopic Pole

- An internal brake slows the extension pole during lowering
- Outer tube is grooved aluminum extrusion and qualifies as an NFPA compliant handrail

OPTIONS:

- CL (custom length pole)
- SW (raised pole switch and indicator)
- TW (wire out of the top of the pole)



Model 542
Side Mount, Pull Up Telescopic Pole

- Outer tube is grooved aluminum extrusion and qualifies as an NFPA compliant handrail
- Standard outer tube (shown) is 20". Choosing an optional 10" outer tube allows for a 43" extension

OPTIONS:

- CL (custom length pole)
- SW (raised pole switch and indicator)
- TW (wire out of the top of the pole)
- ST (10" outer tube)

All FRC pole brackets are adjustable along the pole.

Side Mount Brackets

Supplied as Pair



- A**
The 2.75" side mount brackets are standard on poles with SPECTRA, and OPTIMUM lampheads (excluding HID).



- H**
The 3.5" brackets are standard on poles with EVOLUTION II and FOCUS lampheads.



- B**
Side mount brackets with a 5" offset. Standard on poles used with OPTIMUM HID lampheads.

- C**
Side mount brackets with a 7" offset.

Optional Mounts



- SR**
Optional Steady Rest
Steady Rest bracket provides added bottom support for "inside pole" when it is in the retracted (down) position. Bracket can be used with 512 and 530 push-up poles.



- F**
Optional Flush Mount
Flush mount brackets allow poles to securely mount flush to a surface. Total width is 3.875". Supplied as pair.



Grooved Grab Handle

- FRC's exclusive GRAB-HANDLE is a standard feature on all 530, 540 and 542 telescopic poles.
- It provides a secure grip when wearing heavy gloves.
- The grab handle qualifies as an NFPA compliant handrail.

KWIKRAZE Telescopic Poles



Single Bolt Mounting

- Machined from solid billet aluminum for strength and durability
- Enhanced appearance with bright dip anodized finish
- Compact design reduces mounting surface area by 80% to allow for more versatile applications
- Each set of brackets can hold over 1200 lbs.

Model 200	Model 300	Model 400
<p>Side Mount, Pull Up Telescopic Pole</p> <ul style="list-style-type: none"> • 48" inner telescoping pole, 58" outer pole • Concealed coil cord 	<p>Thru Body, Pull Up Telescopic Pole</p> <ul style="list-style-type: none"> • 48" inner telescoping pole, 58" outer pole • Concealed coil cord 	<p>Thru Body, Push Up Telescopic Pole</p> <ul style="list-style-type: none"> • 48" inner telescoping pole, 12" outer pole • Concealed coil cord
<p>OPTIONS:</p> <ul style="list-style-type: none"> -I (raised pole switch and indicator) -NCW (non-concealed wire) 	<p>OPTIONS:</p> <ul style="list-style-type: none"> -I (raised pole switch and indicator) -NCW (non-concealed wire) 	<p>OPTIONS:</p> <ul style="list-style-type: none"> -I (raised pole switch and indicator) -NCW (non-concealed wire) -R (lower receiver bracket)



Optional Mounts

-R
Lower Receiver Bracket
 Provides additional support when mounting push-up poles.



-WxP
Bracket Mounting Plate

- Makes bolting equipment to light-gauge body walls stronger
- Hardware and gasket included
- Adds 1/2" to any offset bracket



x = length in inches

Model 500
Side Mount, Push Up Telescopic Pole

- 67.5" inner telescoping pole, 24" outer pole
- Concealed coil cord

OPTIONS:

- I (raised pole switch and indicator)
- NCW (non-concealed wire)
- R (lower receiver bracket)

Model 900
Economy Thru Body, Pull Up Telescopic Pole

- 48" inner telescoping pole
- Concealed coil cord

OPTIONS:

- I (raised pole switch and indicator)
- NCW (non-concealed wire)

Model 1100
Remote Side Mount, Push Up Telescopic Pole

- 67.5" inner telescoping pole, 24" outer pole
- Not available with concealed wire or switch

OPTIONS:

- I (raised pole switch and indicator)

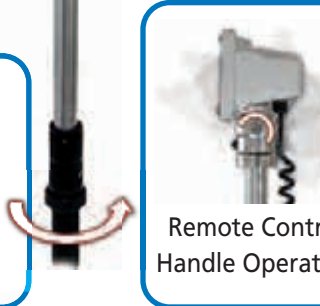
Side Mount Brackets
 Supplied as Pair

- Water-Tight Locking Collar
- W1** Flush Mount 1.5" Offset
- W2** 2" Offset Bracket
- W4** 4" Offset Bracket
- W7P** 7" Offset Bracket with plate



Two-Piece Side Mount Brackets
 Allows poles to be easily installed & removed from the truck for service without removing the brackets from the truck.



SPECTRA SERIES

Models **SPA260** • **SPA900** • **SPA950**

Lowest Profile LED Surface Mount



- LEDs Generate a unique Combined Flood & Spot Light Pattern
- Available in 15,000 Lumens Spectra and 20,000 Lumens Spectra Max
- Available in 12/24 VDC or 120/240 VAC

AC surface mount model SPA260 requires a 6 3/8" w x 4 11/16" h cut-out

SURFACE MOUNTS AVAILABLE FOR **SPECTRA** Q15, K15, J15 & **SPECTRA MAX** Q20, K20, & J20

Slim Profile LED Surface Mounts



SPECTRA 900

- Ideal Scene light for Ambulance and Emergency Response Vehicles
 - Ultra-Bright 7,000 Lumens of Light
- Easy installation, requires no panel cutout. Slim profile less than 2" deep*

SURFACE MOUNTS AVAILABLE FOR **SPECTRA 900** Q70



SPECTRA 950

- Ideal Perimeter light for Ambulance and Emergency Response Vehicles
 - Ultra-Bright 5,000 Lumens of Light
- Easy installation, requires no panel cutout. Slim profile less than 2" deep*

SURFACE MOUNTS AVAILABLE FOR **SPECTRA 950** Q50

Model **FCA210**



EVOLUTION II RECESSED

Generates **15,000 Lumens** of Bright Light
Recess requires only 2" of depth

Models **OPA200** • **OPA250**



RECESSED LIGHTS AVAILABLE FOR
OPTIMUM S30, S50, S75, S72, M10, M12, M15

Model **FCA200**



FOCUS®

RECESSED LIGHTS AVAILABLE FOR
FOCUS D15, D30, H30, S30, S50, S75, S72, M10, M12

MAGNAFIRE

Model KR-1800 2.5" Recessed Mount

- Polished aluminum housing with Magnafire light fixture positioned at 0° horizontal angle
- Magnafire 3000 requires 14.25" x 5" cutout for in-body mounting (Recessed depth is 2.5")

Model KR-1900 2.5" Recessed Mount

- Polished aluminum housing with Magnafire light fixture positioned at 10° downward angle
- Magnafire 3000 requires 14.25" x 5" cutout for in-body mounting (Recessed depth is 2.5")

Models KR-2100/2800 2" Recessed Mount

- Polished aluminum housing with Magnafire light fixture positioned at 10° downward angle
- Housing designed to protect the light fixture
- Magnafire 3000 requires 13.5" x 4.5" cutout for in-body mounting (Recessed depth is 2")
- Magnafire 5000 requires 10" x 5" cutout for in-body mounting (Recessed depth is only 2")

Models KR-2200/2900 5.5" Flush Recessed Mount

- Polished aluminum housing with Magnafire light fixture positioned at 0° horizontal angle
- Magnafire 3000 requires 14.375" x 7.125" cutout for in-body mounting (Recessed depth is 5")
- Magnafire 5000 requires 10.5 x 7.5" cutout for in-body mounting (Recessed depth is 5")

Models KR-2300/3100 5.5" Flush Recessed Mount

- Polished aluminum housing with Magnafire light fixture positioned at 10° downward angle
- Magnafire 3000 requires 14.375" x 7.125" cutout for in-body mounting (Recessed depth is 5.5")
- Magnafire 5000 requires 10.5" x 7.5" cutout for in-body mounting (Recessed depth is 5.5")

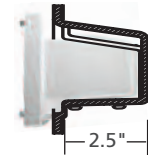

KR-1800

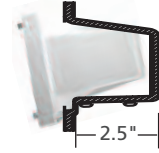

KR-1900

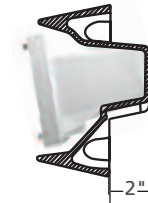

KR-2100 & 2800



KR-2200 & 2900



KR-2300 & 3100



KR-1900 Series Mount



KR-2100 Series Mount



KR-2200 Series Mount

Magnafire 3000® Light Heads

Part #	Recessed Depth	Light Angle Position	KR-36 750w 120v	KR-37 750w 240v
KR-1800	2.5"	0° horizontal	KR-1836	KR-1837
KR-1900	2.5"	10° downward	KR-1936	KR-1937
KR-2100	2"	10° downward	KR-2136	KR-2137
KR-2200	5.5"	0° horizontal	KR-2236	KR-2237
KR-2300	5.5"	10° downward	KR-2336	KR-2337

Magnafire 5000® Light Heads

Part #	Recessed Depth	Light Angle Position	KR-55 500w 120v	KR-56 750w 120v	KR-57 750w 240v
KR-2800	2"	10° downward	KR-2855	KR-2856	KR-2857
KR-2900	5"	0° horizontal	KR-2955	KR-2956	KR-2957
KR-3100	5"	10° downward	KR-3155	KR-3156	KR-3157



KWIKSTRIKE

BODY & PERIMETER LIGHTS

Model **KR-4000**

This super bright flush mounted light draws only 3 amps. The 35 Watt 12V Xenon HID option features instant on & hot re-strike and is 4x brighter than halogen scene lights. Reflector options include a horizontal flood beam or a downward angle flood beam.

- 12v HID or 120v Halogen available
- 35 watt, 12v HID Model features instant "on" and hot restrike
- Flush Mount Fixture (1.875" deep) recesses cleanly in standard 2" truck wall
- Easy front access to ballast and lamp



Part as shown: KR-4035X-D-L

Available in chrome (standard) or white finish (optional)



Downward Angle Flood

Horizontal Flood



Flush Mount Fixture



Perimeter Light with White Finish (Optional)



Perimeter Light Surface Mount Casting (Optional) (KR-4000-SMC)

Part #	Watts	Volts	Amps	Lamp	Lamp Lumen Rating	Lamp Life
KR-4035X - _ - _	35	12	3.5	Xenon HID	3200	3000 hrs
KR-4100H - _ - _	100	120	.9	Halogen	1900	1000 hrs
KR-4150H - _ - _	150	120	1.3	Halogen	2400	2000 hrs
KR-4250H - _ - _	250	120	2.1	Halogen	5000	2000 hrs

- Horizontal and Downward angle flood beam patterns available (suffix -H- for Horizontal 12-15° beam or -D- for Downward 20-65° beam)
- Reflector is available on left or right side (suffix -R- for Right Side Reflector or -L- for Left Side Reflector)
- Chrome finish is standard. Also available in white paint finish (add suffix -W to part number).

Portable Base Model **KR-700**

- Grab-and-run versatility
- Cast aluminum portable base
- Available with any AC light fixtures
- LED lampheads provide more light per watt than traditional quartz halogen fixtures



-HD Hold Down Assembly



Lamphead with portable base easily stores in most vehicle compartments or storage areas



Wire guard comes standard for Optimum, Focus and Magnafire lampheads

Shown with Magnafire 5000 lamphead



Portable Demountable - **DM Option**

- Combines the benefits of a telescoping pole and a 700 Series portable light
- Hold-down assembly fastens light to permanently-mounted baseplate (-HD)
- Mounted on any of the telescoping poles including the SB-800 Series shown on the previous page
- On/off switch standard
- Add suffix -DM to complete pole mount
- Also available without pole

UltraBright Spectra Tripod

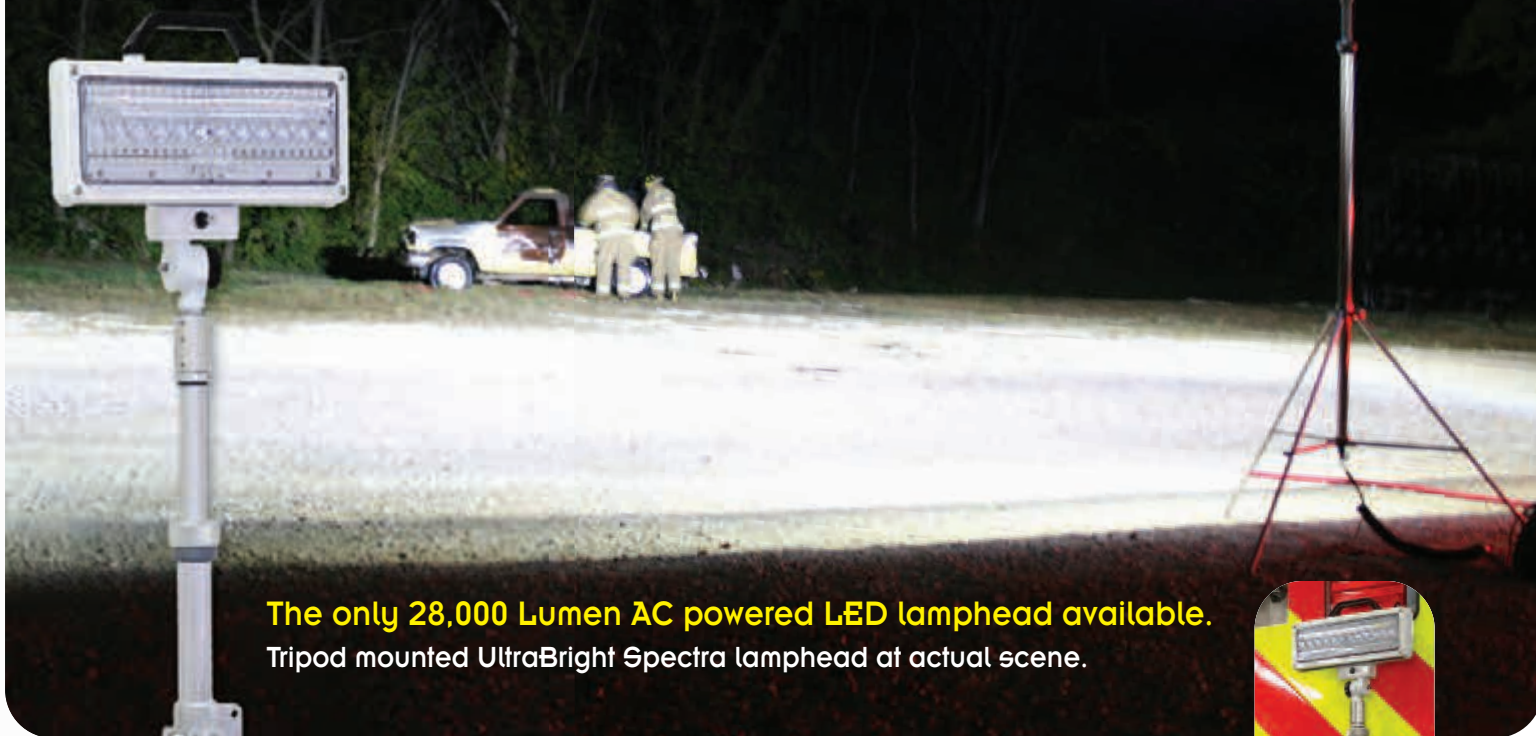

The only 28,000 Lumen AC powered LED lamphead available.
 Tripod mounted UltraBright Spectra lamphead at actual scene.

FRC Tripods are Available with the Following Lampheads:

- SPECTRA: J20, K20
- SPECTRA MAX: J28, K28
- SPECTRA MAX-S: B28, C28
- SPECTRA MS: T14, U14
- OPTIMUM: S30, S50, S75, S72, M10, M12, M15
- FOCUS: S30, S50, S75, S72, M10, M12, M15

SPECTRA tripod shown mounted with FRC QUICK RELEASE brackets on emergency vehicle.



Optional Quick Release Tripod Brackets



-603 for SPECTRA / OPTIMUM



-6F3 for FOCUS

- The 603 bracket sets consist of a small triangular bracket for the feet and a QUICK RELEASE spring loaded dead-bolt lock to hold the tripod at its midpoint
- The brackets can be used on the exterior of a vehicle or in a compartment
- The 6F3 has spacers needed for FOCUS lampheads

Twist Lock Telescopic Tripods

The Industry's Finest Tripods with the Best Features :

- **Twist Lock** – FRC's unique locking ring operates from either direction. It is simply the best way to deploy a light with the gloved hand!
- **Air Cushioned pole release** – This innovation allows the pole to lower slowly, when released, on a cushion of air. This helps to prevent pinched fingers and damage to the bulb.
- **Ease of set-up** – FRC tripods are designed to deploy all three legs at the same time, allowing the unit to be set up quickly and easily at an incident.
- **Lightweight anodized aluminum poles** – The standard tripod weighs just 16 pounds!
- **Extends up to 12 feet!** – Fire Research tripods are designed to permit "overextension" of its legs so the tripod's lamphead can reach this incredible height.
- **Cammed knobs** – The pole tightening knob will not unscrew or come off due to vibration.
- **Anti-chatter legs** – Rubber covers at the bottom of the legs ensure a quiet ride.
- **Small footprint** – When closed the unit sets into an incredibly small lower bracket allowing ease of mounting just about anywhere!
- **Truck mountable** – All tripods are truck mountable, allowing them to be used as telescoping lights on the vehicle and off!
- **Wire Guard** – As shown is standard.

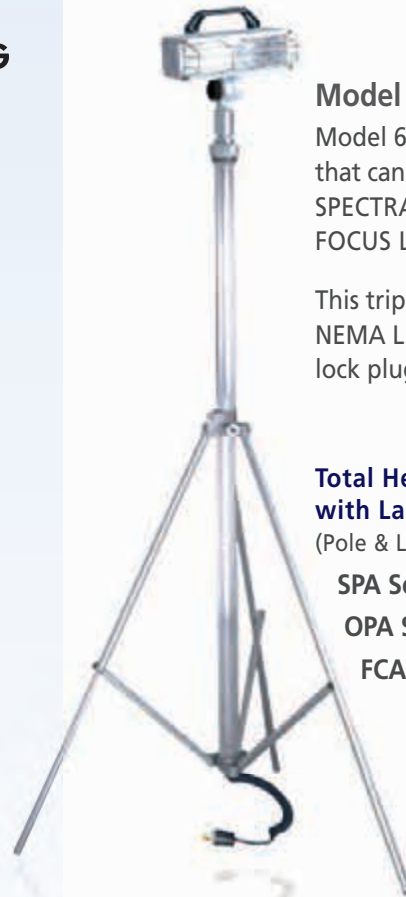

Model 600

Model 600 is a standard tripod that can be used with either SPECTRA, OPTIMUM, or FOCUS Lampheads.

This tripod is supplied with a NEMA L5-15 three prong twist lock plug.

Total Height of Model 600 with Lamphead

(Pole & Legs Retracted)

SPA Series = 72" high

OPA Series = 69" high

FCA Series = 69" high



Model 656

Smaller tripod, overall length (with lamphead) is 14" smaller than Model 600.

Model 642

Smallest tripod, overall length (with lamphead) is 27" smaller than Model 600.



- Similar to the 603, the dual bracket consists of a small triangular bracket for the feet and a DUAL QUICK RELEASE spring loaded dead-bolt lock to hold the tripod at its midpoint. The lock can be released from either side.

-603D for SPECTRA / OPTIMUM

-6F3D for FOCUS

Fixed Top Mount

Model 570

More than a simple top mounted base, the 570 allows for a full 450° of rotation. This means that light coverage can be a full circle, plus another quarter turn which ensures no blind spots. The 570 base has a built-in stop to prevent the internal wiring from binding.

A built-in friction mechanism ensures the light will not rotate when the vehicle is in motion.



Fixed Side Mount

Model 580

The 580 side mounted, fixed pedestal light allows the lamphead to rotate 450° and has a self adjusting friction brake to prevent arbitrary rotation.

The pedestal has a round mounting base attached to a side mount bracket.

*SPECTRA & OPTIMUM lampheads use a 2.75" bracket.
EVOLUTION II & FOCUS lampheads use a 3.5" bracket.
OPTIMUM HID lampheads use a 5" bracket.*



EVOLUTION II with fixed top mount (above) and SPECTRA (right) shown



FOCUS with fixed side mount (above) and SPECTRA (right) shown

Under Aerial

Model 300

The 300 adjustable aerial mounting brackets allow the EVOLUTION II and FOCUS lamphead to be mounted under an aerial bucket or platform. Aim the light forward or directly downward. Commonly set at 30° downward as shown.



Required Clearance

- Aimed Directly Forward - 4"
- Aimed At 30° Downward - 6.5"
- Aimed At 45° Downward - 6.75"
- Aimed Straight Down - 7.5"

Fixed Top Mount



Model **KR-SB-600**

The KR-SB-600 fixed top mount includes a two-piece locking collar and is designed to allow for easy 360 degree rotation.

- Also available with clamping lever (*KR-SB-600-L*)

Low-Profile Permanent Mount



Model **KR-1300**

The KR-1300 low-profile permanent mount includes a 3 1/8" square base plate that allows for 358 degree horizontal rotation and 180 degree vertical adjustment of the lamphead.

- Magnafire lampheads only



Fixed Side Mount

Model **KR-SB-600-W4**

The KR-SB-600-W4 fixed side mount includes a two-piece locking collar and a 4" offset mounting bracket with four hole mount plate.

- 180° horizontal rotation and 90° vertical tilt *with Magnafire 5000 lamphead*
- 100° horizontal rotation and 90° vertical tilt *with Magnafire 3000 lamphead*

Platform / Aerial Mount

Model **KR-1400**

The KR-1400 is a permanently mounted bracket with a 90 degree range of light angle adjustment and is designed for vertical and horizontal installation.

- Magnafire lampheads only
- On/Off switch not available



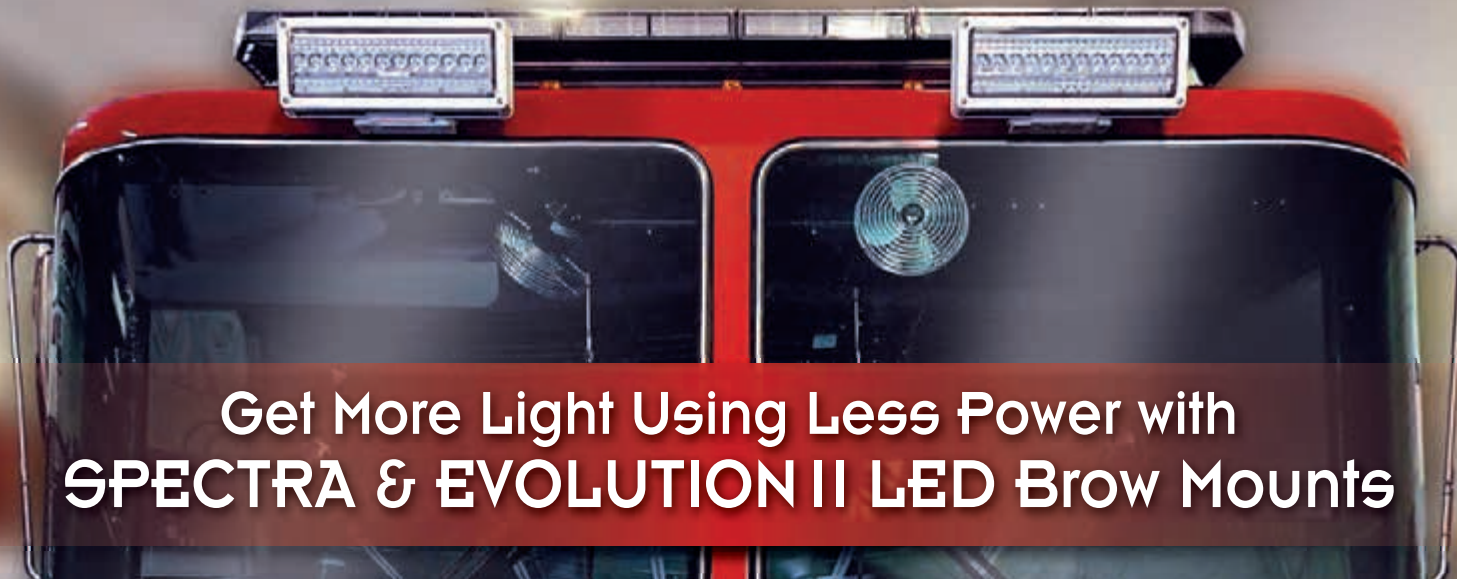

Get More Light Using Less Power with **SPECTRA & EVOLUTION II LED Brow Mounts**

Highly Efficient LEDs Provide Five-Times More Light than Halogen Bulbs

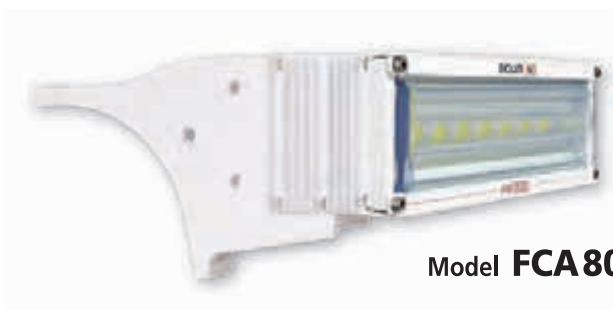

Model **FCA 800**

Turn Night into Day

Arrive at a Nighttime Scene & Power-up Your New SPECTRA or EVOLUTION II Brow Mounted LED Lamphoods for the Brightest Light.

Perfect for new and existing vehicles.



Model **SPA 800**
CONTOUR BROW MOUNT



Model **SPA 850**
FLAT MOUNT

Brow Lights are Available with the Following Lamphoods:

SPECTRA: Q15, Q20, J20, K20

SPECTRA MAX: Q28, J28, K28

SPECTRA MAX-S: A28, B28, C28

SPECTRA MS: R14, T14, U14

EVOLUTION II: V11, V20

OPTIMUM: S30, S50, S75, S72, M10, M12, M15

FOCUS: D15, D30, H30, S30, S50, S75, S72, M10, M12, M15

Contour, Universal & Flat Mounting

Perfect for Mounting on Roof of Cab



Brow Lighting Features

- UltraBright Illumination
- Light Up the Scene Quickly Upon Arrival
- Very Low Profile
- Available for SPECTRA SERIES, EVOLUTION II, OPTIMUM, FOCUS & MAGNAFIRE



Universal Mount

DESIGNED TO MOUNT ON ANY CAB

Universal Mounting Bracket Easily Installs on All Apparatus

Flat Mount **DESIGNED TO MOUNT ON ANY FLAT SURFACE**



SPECTRA

EVOLUTION II

OPTIMUM

FOCUS®

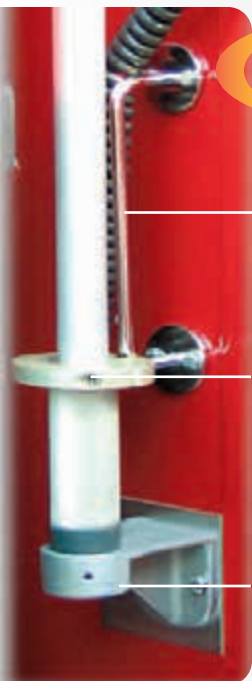

Guide Rail

Guide Collar

Steady Rest Bracket

Available with 3.5" or 5" brackets.



No Scratch Guide & Rubber Bumpers Prevents Scratching & Denting

The No-Scratch option combines a guide collar and guide rail assembly, a steady-rest bracket, and two rubber bumpers on the lamphead (FOCUS & EVOLUTION II only) to prevent scratching and denting of apparatus body surfaces. The complete No-Scratch option is available on 530 side mount, bottom raise, telescopic pole.

When the pole is raised the guide collar disengages from the guide rail and the lamphead is free to rotate 360°. As the pole is lowered the guide collar engages the guide rail. The guide collar and rail prevents the pole from being lowered if the lamphead is not correctly aligned.

Rubber Bumpers

are available as an option on most FOCUS & EVOLUTION II lampheads

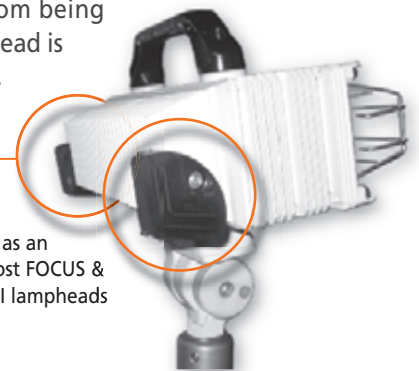

Rubber Bumpers

Raised Pole Indicator & Switch

In order to alert the vehicle operator that an extendable pole is raised, FRC offers a switch and indicator option for all permanently mounted telescopic poles. The parts associated with this option will differ depending upon the type of pole in question.

Note: To retrofit this option the type of pole being used needs to be specified when ordering.

If retrofitting this option on a 530 push-up pole the steady rest lower bracket is required.



-NS

Patented No-Scratch Option

Ordered with the 530 pole by adding the suffix -NS to the part number. **-NS Option includes:**

- (2) Rubber Bumpers (FOCUS & EVOLUTION II only)
- (1) Guide Collar & Guide Rail
- (1) Steady Rest Bracket

FC-NS31K

The Rubber Bumpers can be ordered separately and installed on all standard FOCUS lampheads.

FC-NS31K Kit includes:

- (2) Rubber Bumpers
- (2) 1/8" Rivets with Backing Plates

FC-NSK

The No-Scratch option can be retrofitted on existing 530 poles.

FC-NSK Kit includes:

- (1) FC-NS31K Kit
- (1) Guide Collar & Guide Rail Assembly

Note: It is recommended that the Steady-Rest bracket be installed with the No-Scratch retrofit kit.

Order FC-NSK-SR



Wire Guard

When retrofitting a wire guard on an OPTIMUM or FOCUS lamphead not originally fitted with one order the OP150-S/FC150-S or OP150-M/FC150-M kit.

Wire Guards are not available on Model 200, 230, and 250 recessed mounts.



WIRE
EXIT
TOP OF
POLE

**Wire Exits from Top of Pole
Non-concealed Wire**

For most permanently mounted lampheads the power cord exits through the bottom of a pole assembly. Specifying this option will bring the power cord out of the top of the pole or lamphead.



AC Plugs

- P1 Nema 5-15 Straight (household type) plug
- P2 Nema L5-20 3-Prong twist lock plug
- P3 Nema L5-15 3-Prong twist lock plug

On/Off Lamphead Switch

On SPECTRA, EVOLUTION II, OPTIMUM, FOCUS and MAGNAFIRE lampheads a switchbox is provided underneath the lamphead.



ON/OFF LAMPHEAD SWITCH



Dual Lampheads

Two (2) lampheads. Bar accommodates all lampheads (unless they are wider than 12") and many poles and mounts.

Custom Length Pole

FRC telescopic poles can be shipped pre-cut to a custom length. Total length will include pole and lamphead.

(Some restrictions apply)



SOBRITE *the new concept light*



Compact, Ultrabright LED Light

Rugged Lightweight & Powerful

- 7,000 lumens of intense LED light
- Built tough for long life in the harshest environments
- Versatile design offers multiple mounting options
- Ideal LED upgrade for your existing vehicles
- 12 / 24 VDC - 5/2.5 Amps



Shown with standard yoke mount (model SRA100)



Shown with fixed mount (model SRA110) and optional black housing

Mounts almost anywhere



SoBrite LED easily retrofits to existing Collins Dynamics® FX and Unity AG-L mounting bases.

Three Models, Three Light Patterns

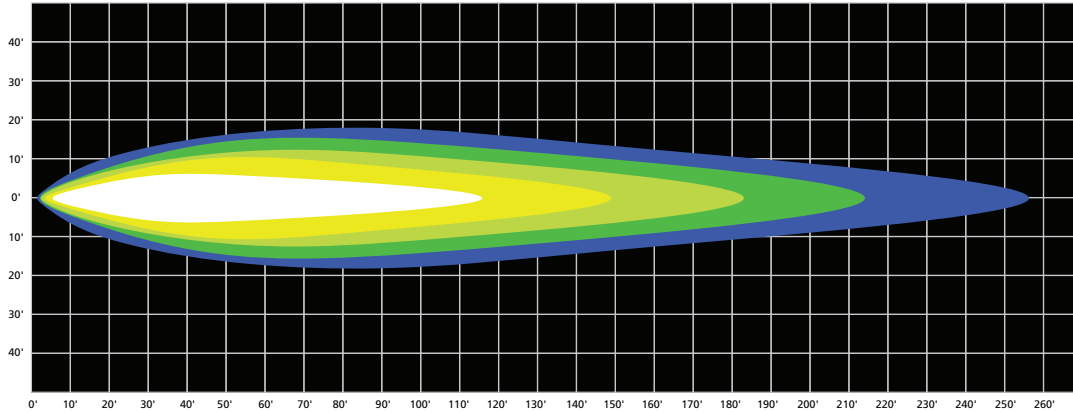

Model SRA100-07A

Spot Pattern:

A focused and concentrated long range light beam for illuminating objects in the distance.

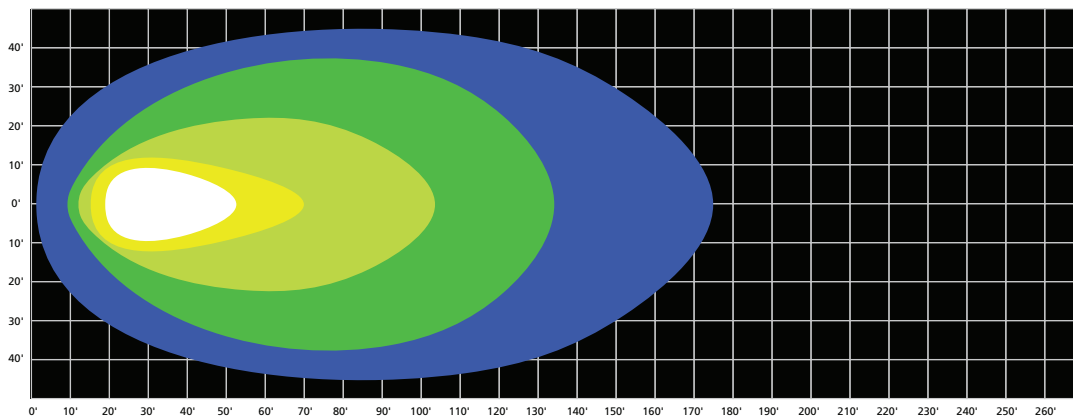

Model SRA100-07B

Flood Pattern:

Widest pattern of light that is perfect for evenly illuminating the work area.

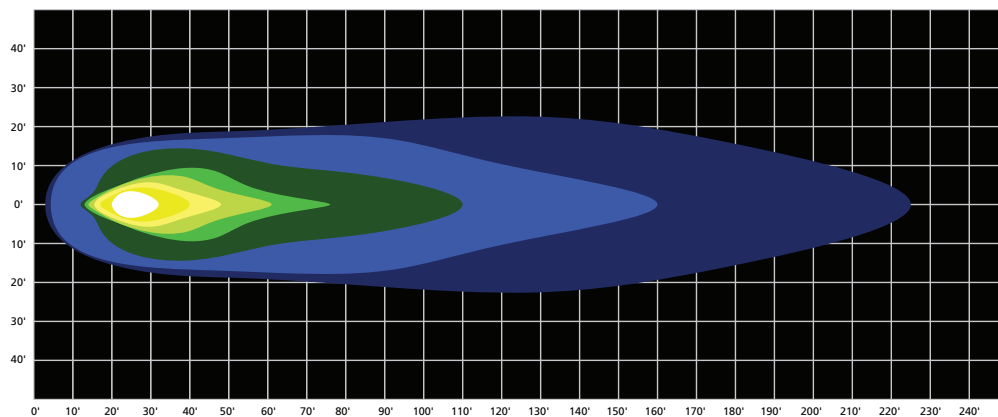

Model SRA100-07C

Trapezoid Pattern:

Wider than a spot and longer than a flood, this light pattern is ideal as a general-purpose work light. Ideal for mounting on front of vehicle for increased visibility while driving.

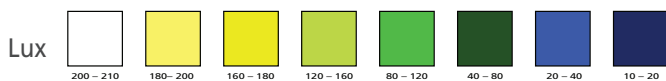



Work Area, **Ultrabright** LED Light Series

Rugged Compact, Versatile & Powerful

- Delivers outstanding light output
- Built tough for long life in the harshest environments
- Robust cast aluminum housings with polycarbonate lens
- Protected against shock, RFI/EMI interference, voltage surges, UV and reverse polarity
- IP67 or IP68 compliant against dust & water ingress
- Extremely affordable
- Many model sizes / available in black or white



All models available in Spot or Flood



model LED330



model LED310



model LED350



model LED300

Part No.	Description w/mounting bracket
LED300-A01	LED, SPOT, 12/24 VDC, 20W, Square 3"x 3 3/32", 1800 Lumens
LED300-B01	LED, FLOOD, 12/24 VDC, 20W, Square 3"x 3 3/32", 1800 Lumens
LED310-A03	LED, SPOT, 12/24 VDC, 35W, Round 5 5/8", 3500 Lumens
LED310-B03	LED, FLOOD, 12/24 VDC, 35W, Round 5 5/8", 3500 Lumens
LED320-A03	LED, SPOT, 12/24 VDC, 35W, Square 5 1/2", 3500 Lumens
LED320-B03	LED, FLOOD, 12/24 VDC, 35W, Square 5 1/2", 3500 Lumens
LED330-A01	LED, SPOT, 12/24 VDC, 26W, Square 5 1/2", 1800 Lumens
LED330-B01	LED, FLOOD, 12/24 VDC, 35W, Square 5 1/2", 1800 Lumens
LED340-A07	LED, SPOT, 12/24 VDC, 78W, Round 7 1/2", 7200 Lumens
LED340-B07	LED, FLOOD, 12/24 VDC, 78W, Round 7 1/2", 7200 Lumens
LED350-A07	LED, RECESSED, 12/24 VDC, 18W, 7 11/16"x 2 7/16", 1620 Lumens

VantagePoint



Remote Control, **Ultrabright** LED Light

Rotatable, Lightweight & Powerful

- 16 LED lights provide 7,000 Lumens of brightness
- Lightweight, die-cast magnesium housing
 - Verticle tilt 70° and 45° downward
 - 360° horizontal rotation
- Two hand-held remote controllers supplied with each unit
- Versatile design offers multiple mounting options
- Ideal LED upgrade for your existing vehicles
- connects to any 12/24 VDC power source



model LED400
A06-W (white)

model LED400
A06-B (black)



Flashing Alert warns motorists or pedestrians of potential hazards ahead

Hand-held Remote Control

- Easily control direction and height of beam
- Pan left or right
- Flashing alert signal
- Quick battery replacement
- Mounting brackets provided



COLLINS

DYNAMICS

Halogen FX Series

The Collins-Dynamics brand of spotlights have been a recognized leader for over 25 years.



The Collins Dynamics spotlight incorporates a unique spun aluminum reflector that is polished and vacuum metalized. This process creates a high-quality mirror-like finish that emits a consistent beam focus that produces 30% more light output than sealed beam lamps.

Single and dual-stage reflectors provide high-intensity halogen spot, flood and enhanced flood beam patterns. The body is constructed of black anodized aluminum with a chrome plated reflector housing, and an aluminum switch box; switches are standard. All models are standard 12 volt and, if specified, offered with 24 volt lamps.

FX-6 Enhanced flood light

Enhanced flood pattern decklight with 7" single stage 40° reflector. Uses 100 watt H-1 lamp. Draws 7.8 amps.

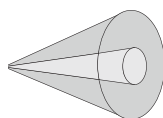

FX-6 Beam pattern
300,000 cp spot
125,000 cp flood

FX-9 Selectable spot/flood light

Select spot or flood pattern with 7" dual stage reflector. Uses two 100 watt H-2 lamps. Draws 7.8 amps on spot or flood.

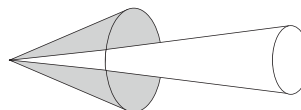

FX-9 Beam pattern
500,000 cp spot
50,000 cp flood

FX-12 Selectable spot/flood light

Select spot or flood pattern with 7" dual stage reflector. Uses 100 watt H-2 spot and 55 watt H-2 flood lamps. Draws 7.8 amps on spot, 4.2 on flood.

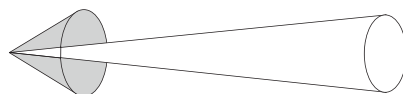

FX-12 Beam pattern
750,000 cp spot
5,000 cp flood

Part No.	Watts	Volts	Amps	Lamp	Lamp Lumen Rating	Lamp Life
CD-FX-6	100	12	7.8	H-1	2,800	150 hrs
CD-FX-9	100/100	12	7.8	H-2	3,000	100 hrs
CD-FX-12	100/55	12	7.8	H-2	3,000	100 hrs
CD-FX-HID-1	35	12	3.5	Xenon HID	3,300	3,000 hrs

Handheld Spotlights

FRC offers a full-line of powerful portable and handheld spot and flood scene lights. All are constructed of rugged weatherproof materials to provide reliable high-intensity light output and performance.

Part No.

Description

- CD-CL-HID-1 Spotlight, FX-HID, 35 Watts, 12 Volts, HID, 9' Power Cord
- CD-CL-12 Spotlight, Handheld, CL-12, available with Momentary Switch (CD-CL-12-M)
- CD-MAGNUM Spotlight head, CD-12 Magnum



DuroLumen

High Performance LED Interior Lighting

The power you need, the savings you want.

- Reverse polarity and over/under voltage protected
- Easy retrofit – fits Grote and TruckLite hole patterns: 3.5" x 16" x 1"
- Recessed housing – Nearly flush mount pan fits tight along walls and ceilings



DuroLumen LED Interior Lighting

Part No.	Description	Voltage	Amps	Lumens
R03696	Surface mount. White/White offers high or low beam intensity switching (user supplied switch)	9–16 VDC	2.5 high 1.25 low	2,800 high 1,400 low
R03694	Surface mount. White only	9–16 VDC	1.25 low	1,400
R03695	Recessed mount. Red/White offers high or low beam intensity switching (user supplied switch)	9–16 VDC	1.25 low	1,400 white 500 red
R03850	Recessed mount. White/White offers high or low beam intensity switching (user supplied switch)	9–16 VDC	2.5 high 1.25 low	2,800 high 1,400 low
R03848	Surface mount. White only	9–16 VDC	1.25 low	1,400
R03849	Recessed mount. Red/White offers high or low beam intensity switching (user supplied switch)	9–16 VDC	1.25 low	1,400 white 500 red

SUNSTRIP



UltraBright White LED Light for Compartments, Panels, Under Body Applications, Walkways & Stairwells

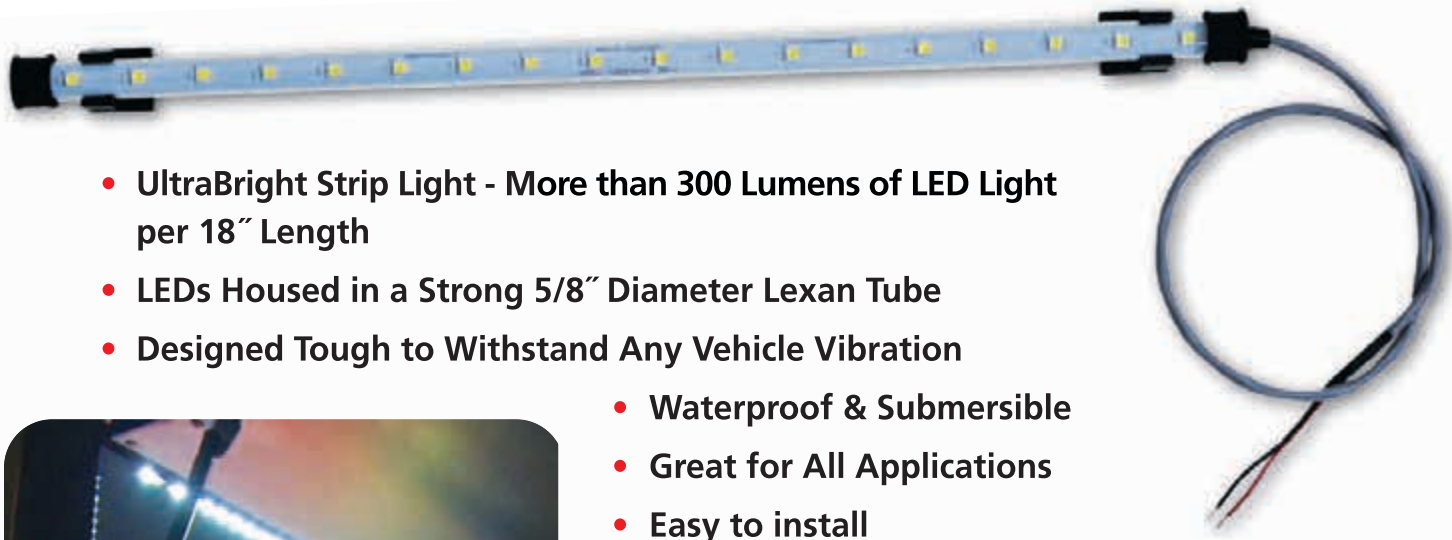

- UltraBright Strip Light - More than 300 Lumens of LED Light per 18" Length
- LEDs Housed in a Strong 5/8" Diameter Lexan Tube
- Designed Tough to Withstand Any Vehicle Vibration

- Waterproof & Submersible
- Great for All Applications
- Easy to install
- Long Operating Hours – Rated at 50,000 Hours

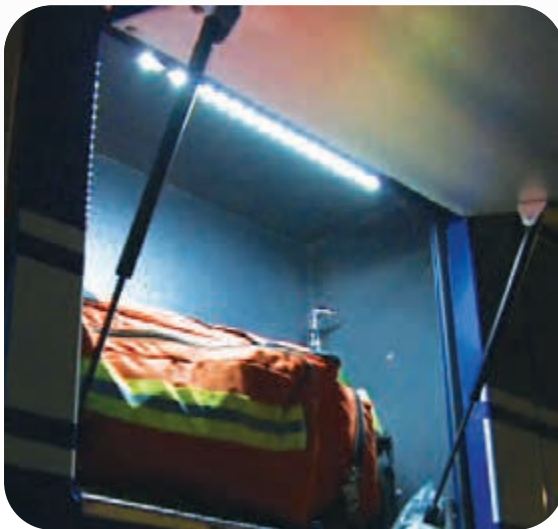

Available in 9" length increments from 9" to 63"

Ordering Info

Part No.	Tube Length*	Lumens	Current @ 12V
LED200 - A09	9"	150	0.17 amps
LED200 - A18	18"	300	0.35 amps
LED200 - A27	27"	450	0.52 amps
LED200 - A36	36"	600	0.70 amps
LED200 - A45	45"	750	0.87 amps
LED200 - A54	54"	900	1.05 amps
LED200 - A63	63"	1050	1.22 amps

*Add 2" for end caps & wire clearance
 Mounting clips supplied • 24V also available

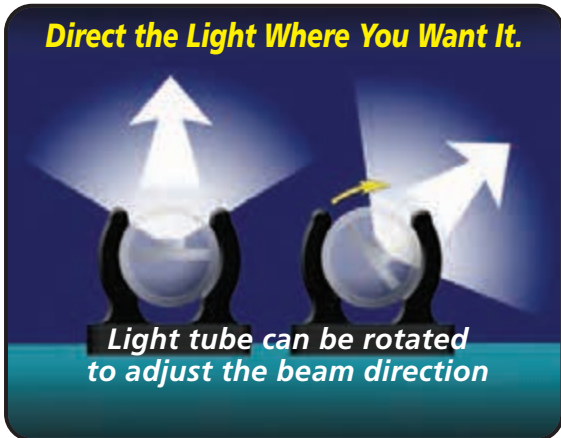

FIREFLY



Most Compact UltraBright White LED Light for Compartments, Panels, & Under Body Applications

- Small and Compact - Four (4) White, Long Life LEDs
- UltraBright 650 Lumens Light Output
- Mounts in Any Orientation & On Any Flat Surface
- 12 VDC-0.8 Amps / 24 VDC-0.4 Amps
- Low Power Consumption Saves Energy
- Instant on at Full Intensity
- Can be Used in Compartments, on Panels, and for Ground or Surface Lighting

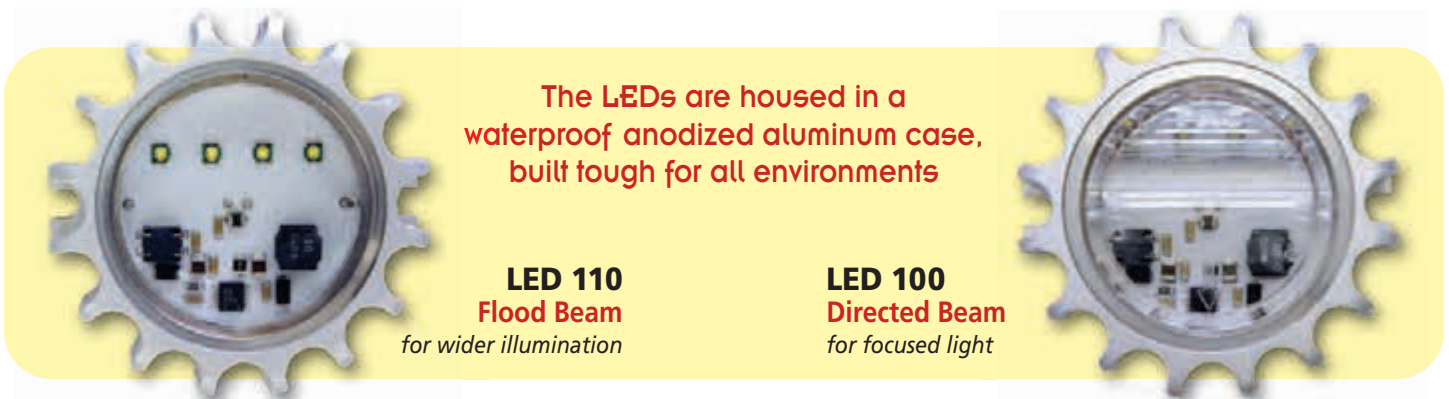

The LEDs are housed in a waterproof anodized aluminum case, built tough for all environments

LED 110
Flood Beam
for wider illumination

LED 100
Directed Beam
for focused light

LED110 - Q01 Work Light perfect for under vehicle

LED100 - Q01 Compartment Light with glare reducing lens

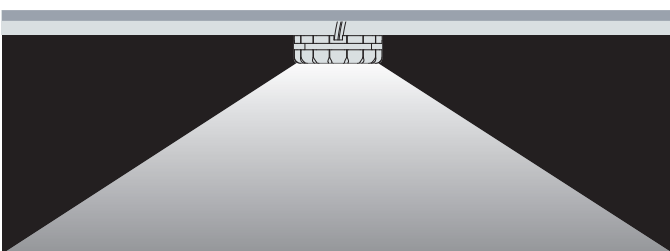
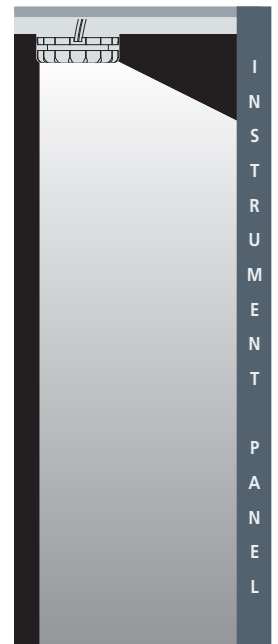

TWIST-LOCK Top Mount Poles

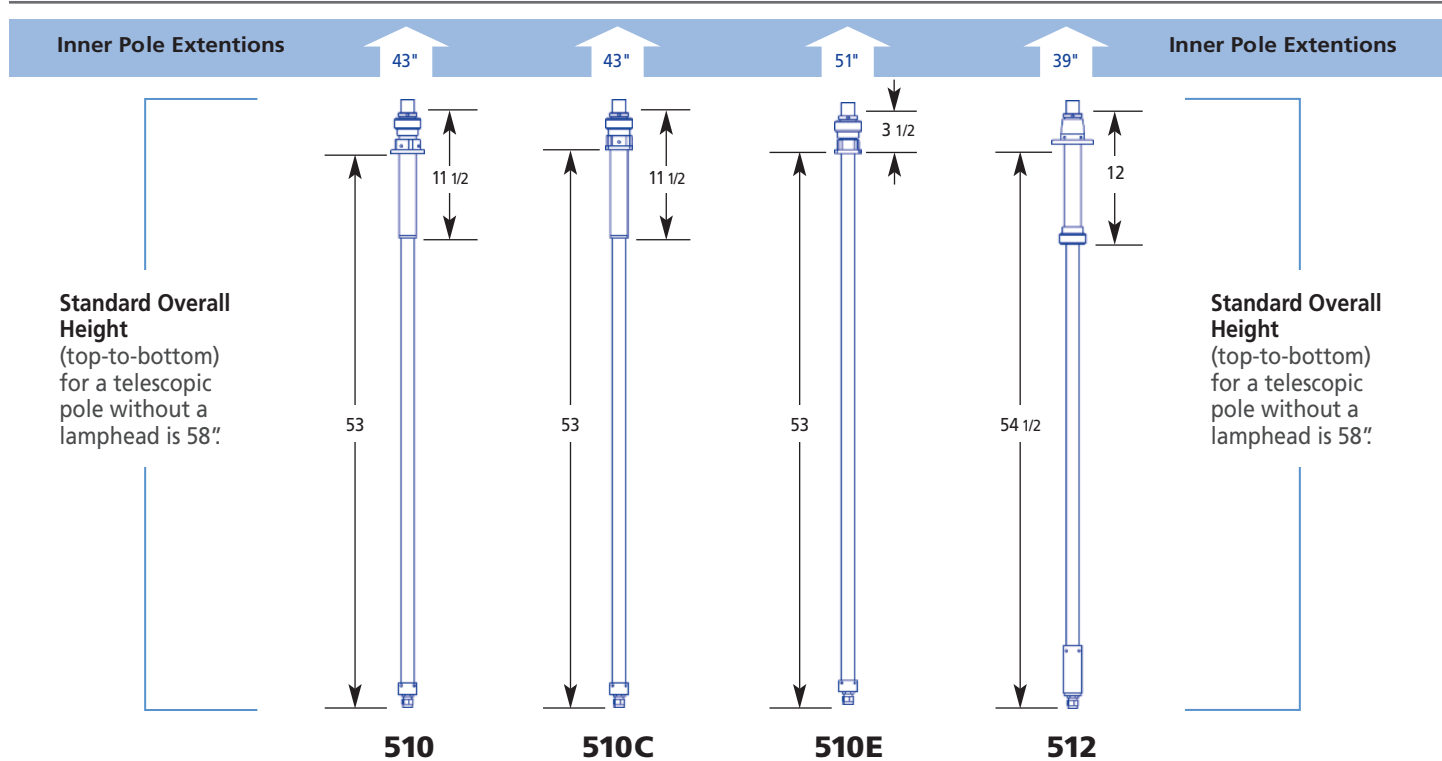

TWIST-LOCK Side Mount Poles

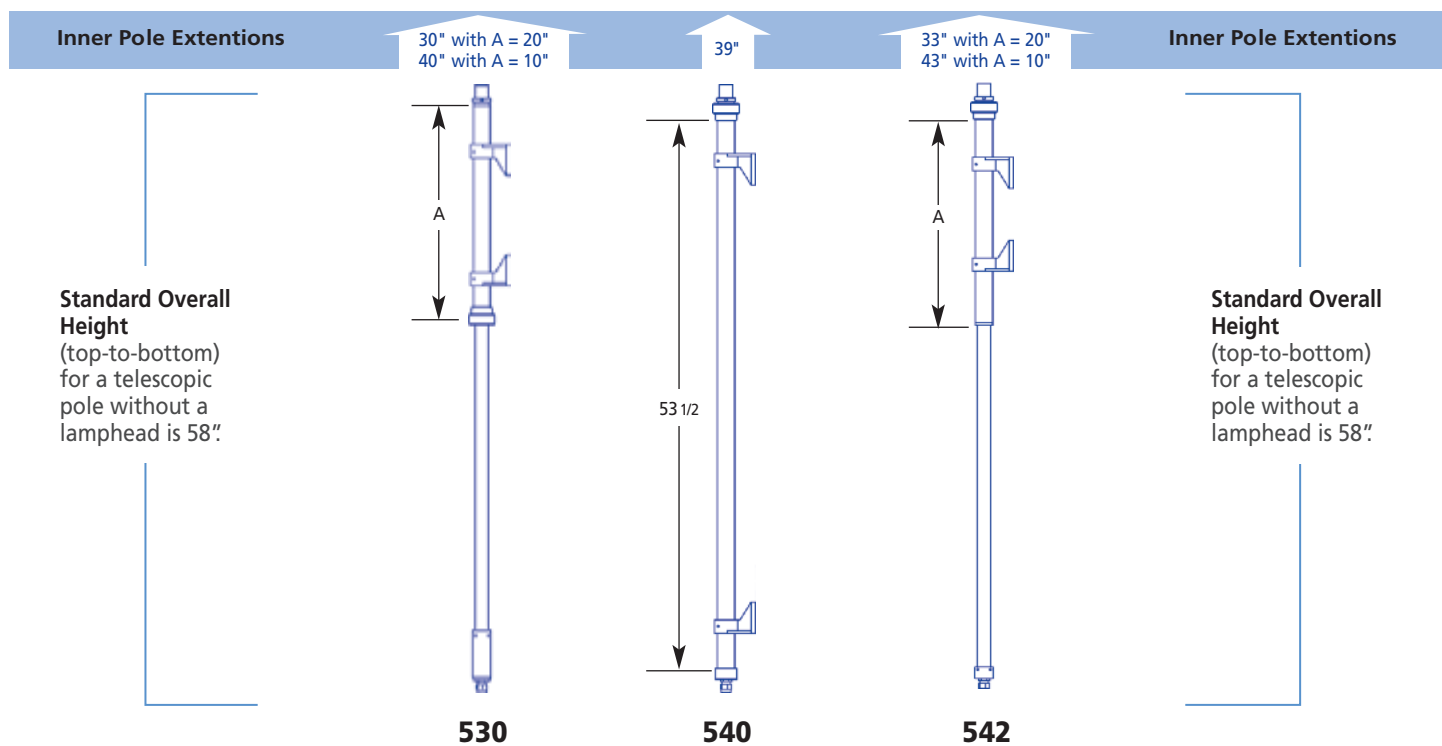

KWIK-RAZE Top Mount Poles

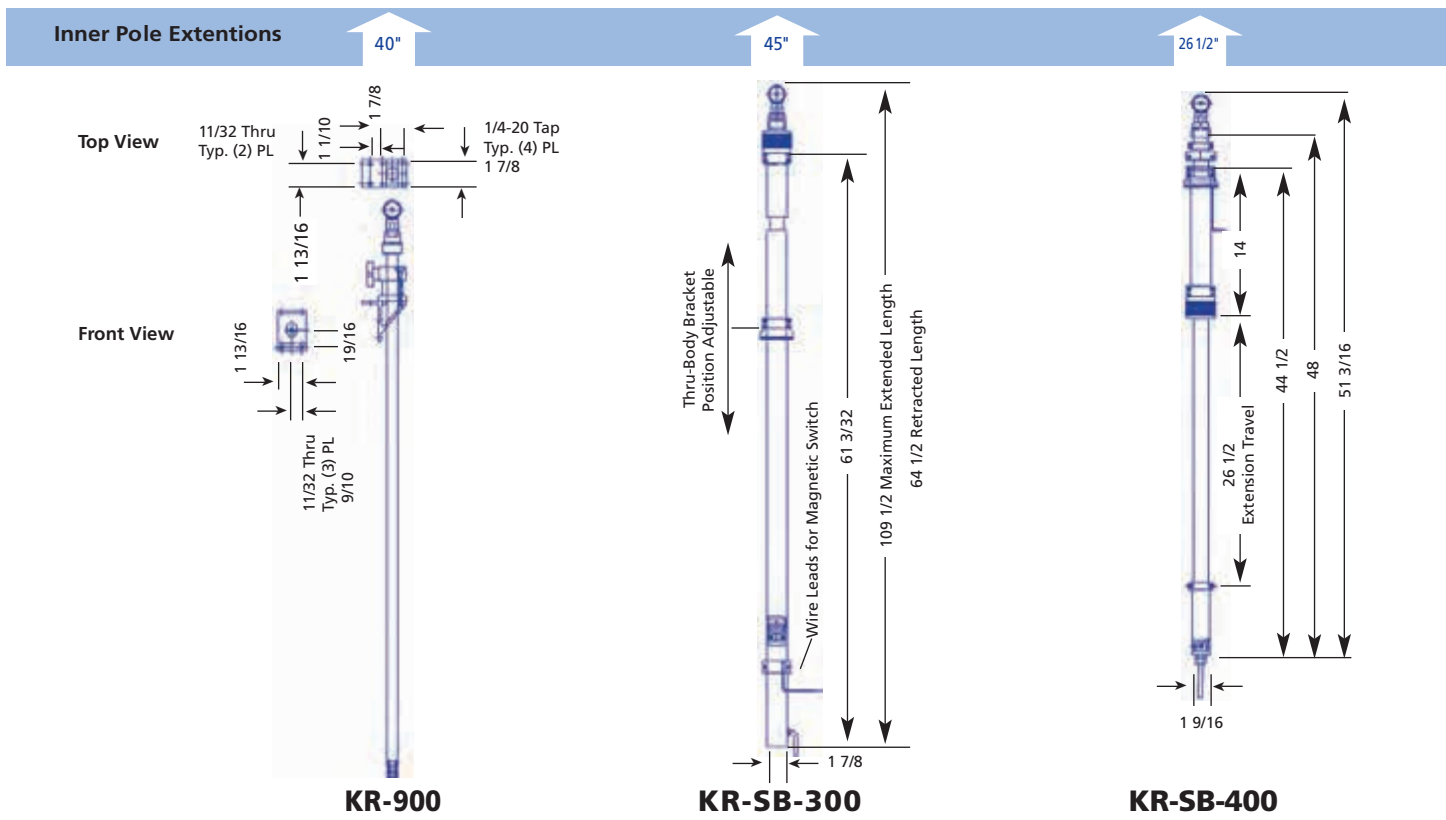

KWIK-RAZE Side Mount Poles

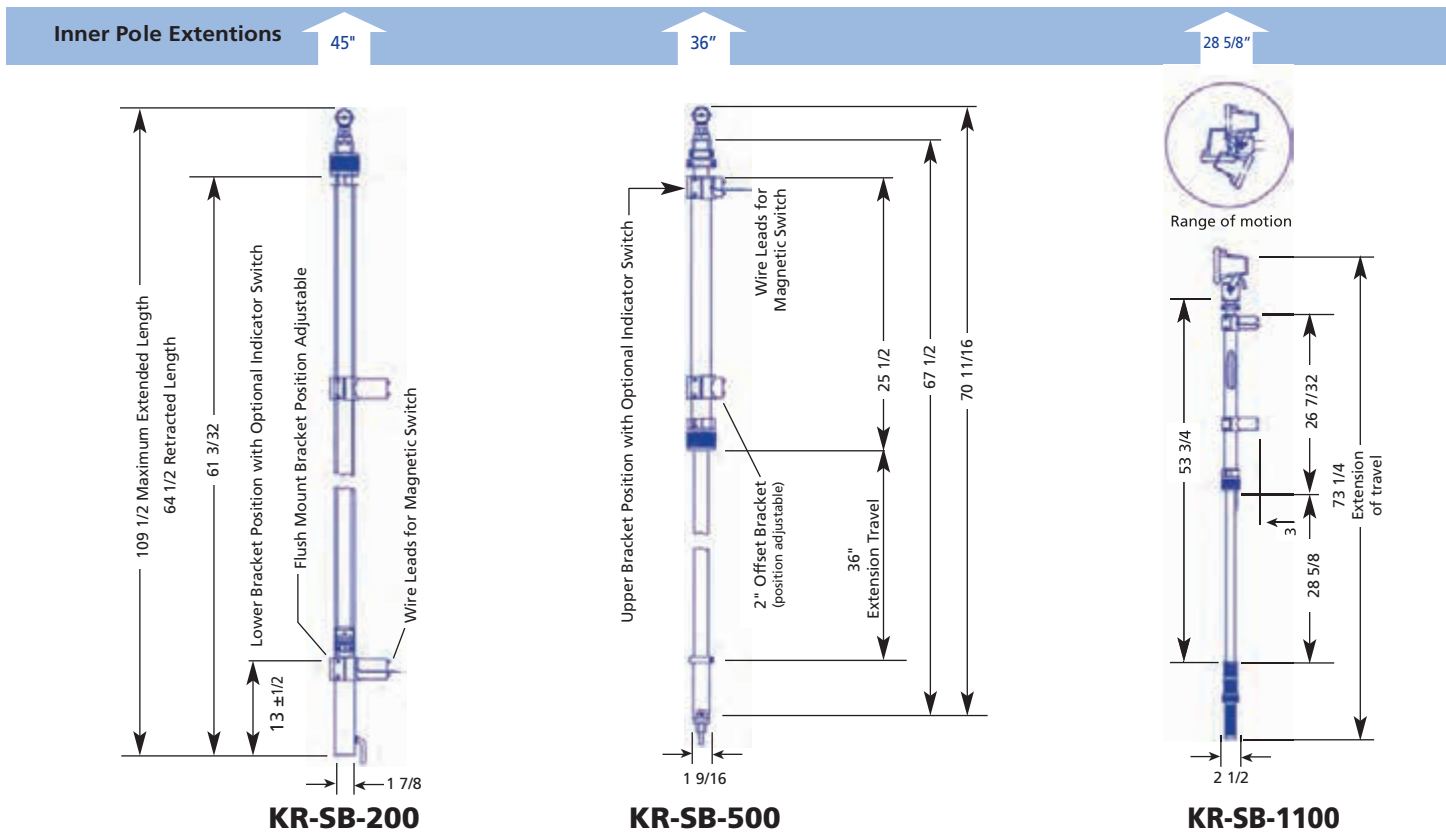

Lamphead Height Dimensions

	All SPECTRA	All FOCUS & EVOLUTION II	All OPTIMUM
Lamphead	12 7/16	10 3/8	10 3/8
With ON/OFF Switch	13 7/16	11 3/8	11 3/8
With Wire Guard	N/A	10 3/8	10 3/8
With Top Wire	13 7/16	11 3/8	11 3/8

SPECTRA SERIES

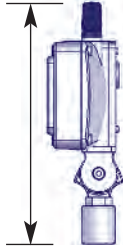

FOCUS & EVOLUTION II

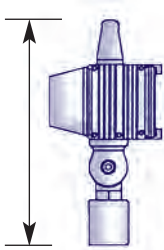

OPTIMUM

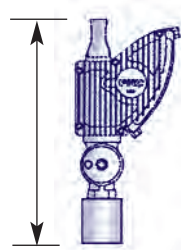

NOTE: Lamphead to pole adapter (LT100) is included in lamphead dimensions. When adding the lamphead height to a standard pole height (58") subtract 1 1/4" to obtain overall dimension.

TWIST-LOCK Tripod Pole Dimensions

	600	656	642
A	59	45 1/4	31 3/4
B	99	73 1/2	48 3/8
C	75 1/8	61 1/2	44 3/4
D	115 1/8	89 3/4	61 3/8
E	43 1/2	43 1/2	30 1/2

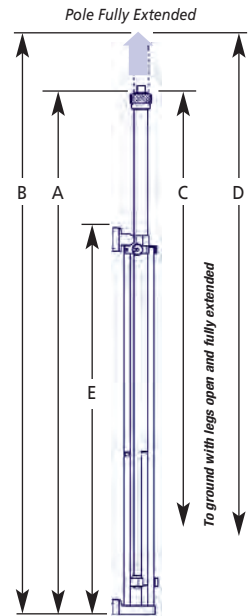

NOTE: The tripod comes with the power cord exiting from the bottom of the pole. For the power cord to exit from the top of the pole add the -TW option. When the -TW option is installed add 1" to the lamphead dimension and on a standard pole add 8" to dimensions B and D.

Tripod shown from side view with quick release truck mount bracket set

Side Mount Bracket Dimensions

All Dimensions In Inches

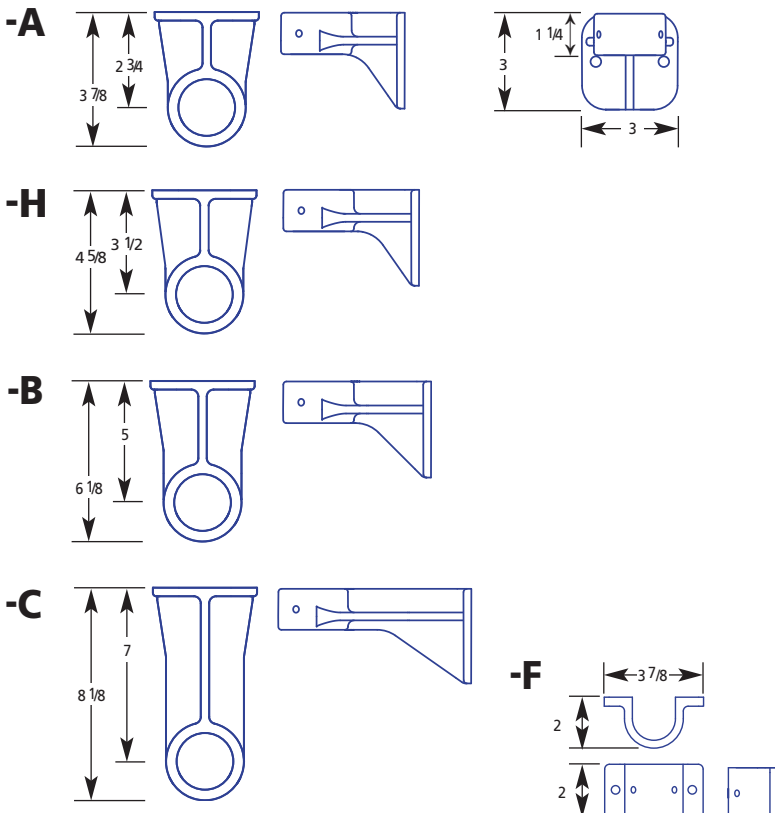

Tripod Bracket Dimensions

All Dimensions In Inches

* FOCUS Lampheads Require the included 7/8" spacer.

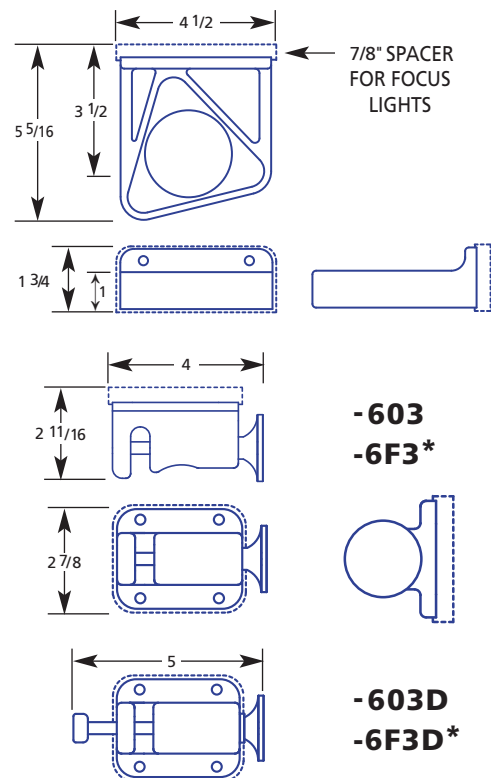

Dimensions • KWIK-RAZE • VANTAGE POINT • CRESTLIGHT

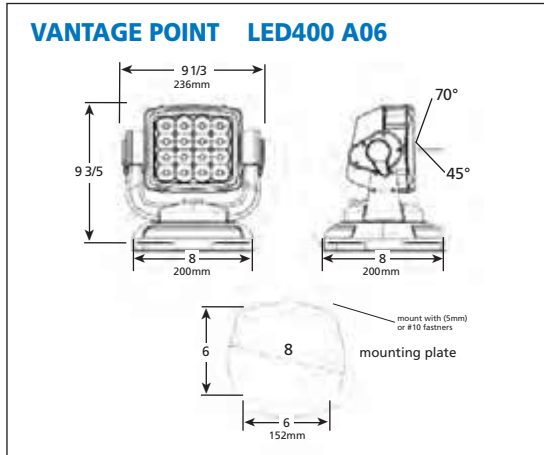
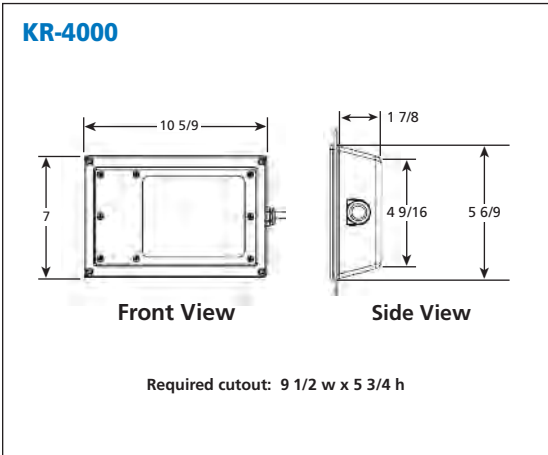
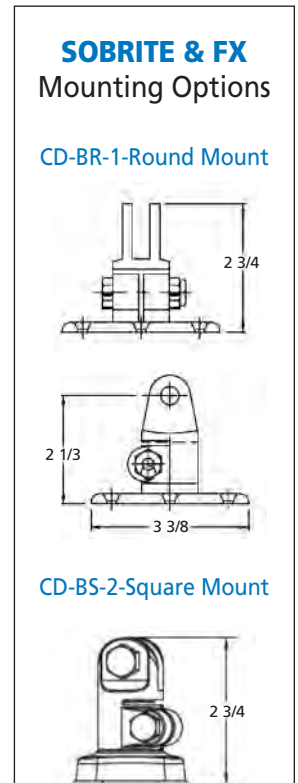
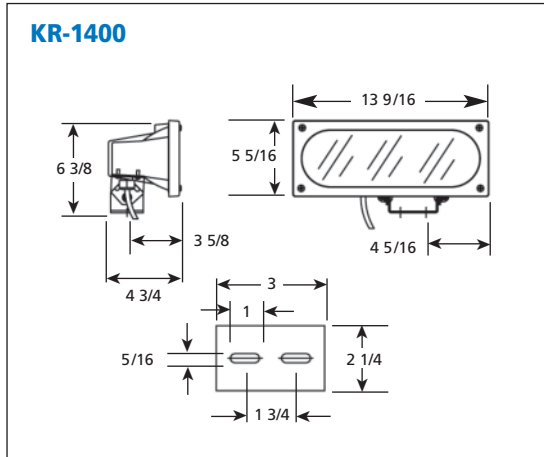
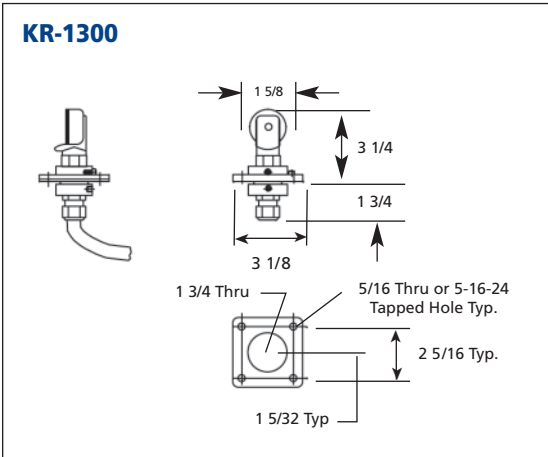
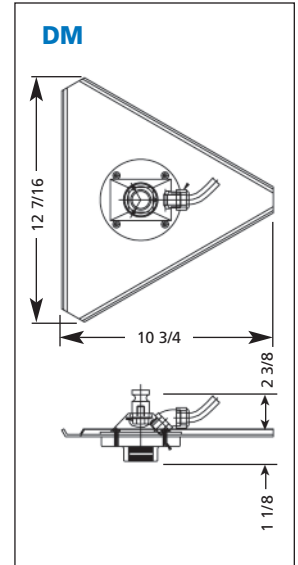
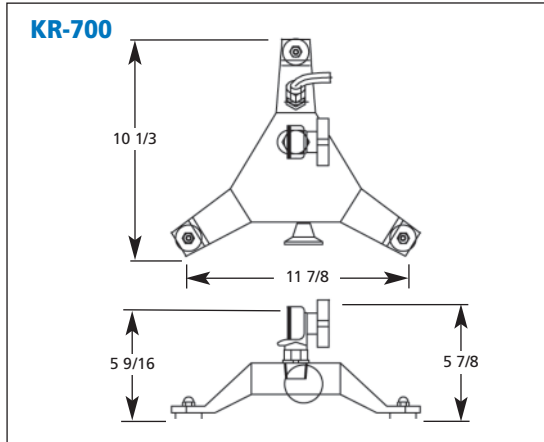
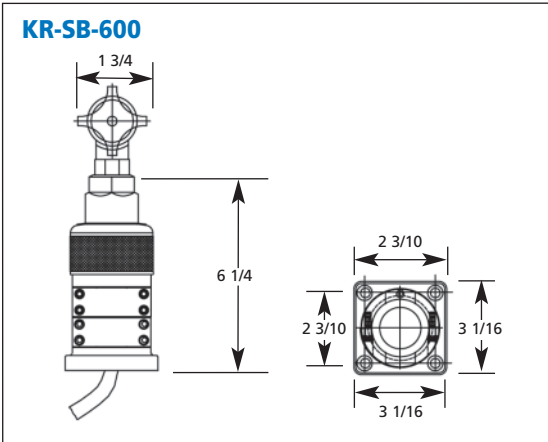

CRESTLIGHT

Model	Width w/bracket	Mounting Holes	Height w/bracket	Height wo/bracket	Depth	LEDs
CLA100-A14	17 1/2	16 9/16	3	1 13/16	3 5/16	12
CLA100-A49	52 1/2	51 5/8	3	1 13/16	3 5/16	45
CLA100-A62	65 1/4	64 3/8	3	1 13/16	3 5/16	57
CLA100-A68	71 5/8	70 3/4	3	1 13/16	3 5/16	63

CLA100-A68 63 LEDs total

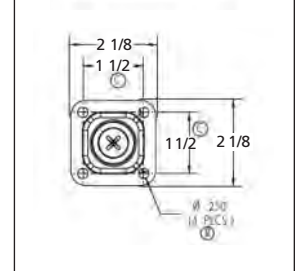

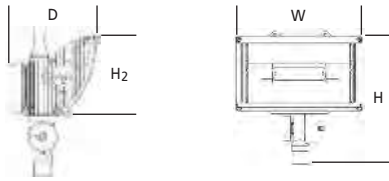

OPA100, OPA500, OPA600, OPA700

Model	W	D	H	H ₂
S30, S50, S75, S72	8 11/16	4 3/4	9 1/16	5 3/8
M10, M12, M15	14 1/16	4 3/4	9 1/16	5 3/8

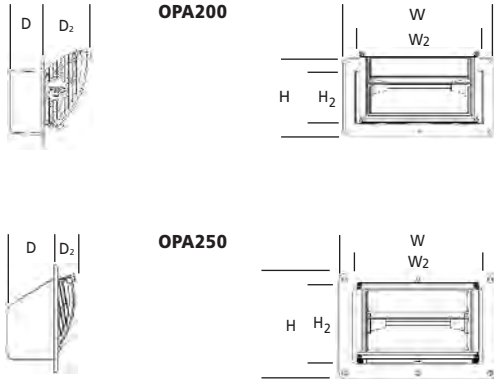

OPA200, OPA230, OPA250

Model	W	D	H	W ₂	D ₂	H ₂
OPA200						
S30, S50, S75, S72	11	2	5 5/8	9 3/4	3 1/8	4 1/4
M10, M12, M15	17 1/2	2	5 5/8	16 1/8	3 1/8	4 1/4
OPA250						
S30, S50, S75, S72	11 3/16	4 1/8	7 1/2	9 9/16	1 3/4	5 3/4
M10, M12, M15	16 9/16	3 1/4	7 1/2	15	1 3/4	5 3/4

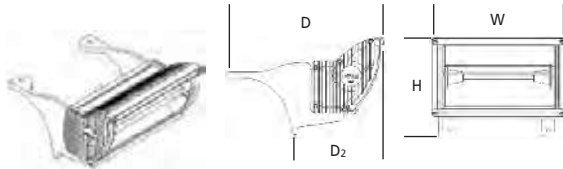

OPA800

Model	W	D	H	D ₂ Max
S30, S50, S75, S72, M10, M12, M15	8 11/16	10 7/16	6 7/16	7 1/2

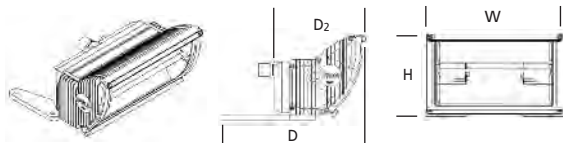

OPA850

Model	W	D	H	D ₂
S30, S50, S75, S72, M10, M12, M15	9	8 5/8	5 5/16	4 3/4

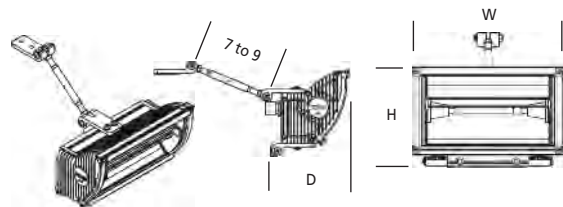

OPA830

Model	W	D	H
S30, S50, S75, S72, M10, M12, M15	8 11/16	5 7/16	5 7/8

FCA100, FCA500, FCA600, FCA700

Model	W	D	H	H ₂
D15, H30, S30, S50, S75, S72	10	5	9	3 5/16
D30	11 1/2	5 3/16	9	3 5/16
M10, M12, M15	15	5	9	3 5/16
V11	7 5/8	5 3/16	9	3 5/16
V20	11 1/2	5 3/16	9	3 5/16

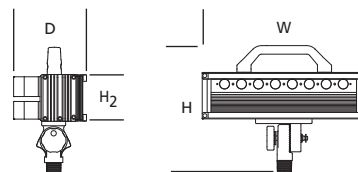

FCA200, FCA210

Model	W	D	H	W ₂	D ₂	H ₂
FCA200						
D15, H30, S30, S50	11	2	5 5/8	9 3/4	1 15/16	4 1/4
D30, M10, M12	17 1/2	2	5 5/8	15 7/8	1 15/16	4 1/4
FCA210						
S75, S72	13 7/8	2	5 7/8	12 1/2	1 15/16	4 1/2
V15	13 7/8	2	5 7/8	12 1/2	1 15/16	4 1/2

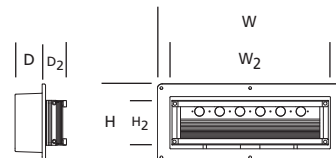

FCA300

Model	W	D	H	D ₂
D15, D30, H30, S30, S50, S75, S72	11 1/2	6 1/2	3 7/8	5
M10, M12, M15	15	6 1/2	3 7/8	5
V20	11 1/2	6 1/2	3 7/8	5

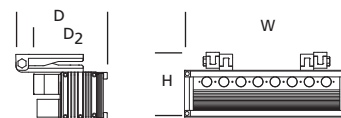

FCA800

Model	W	D	H	D ₂ Max
D15, D30, H30, S30, S50, S75, S72	11 1/2	9 5/16	4 3/4	5 5/16
M10, M12, M15	15	9 5/16	4 3/4	5 5/16
V11	7 5/8	9 5/16	4 3/4	5 5/16
V20	11 1/2	9 5/16	4 3/4	5 5/16

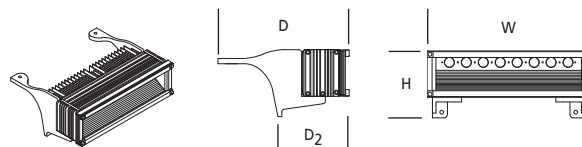

FCA850

Model	W	D	H	D ₂
D15, H30, S30, S50, S75, S72	12	7 1/2	3 5/8	5
D30	12	7 1/2	3 5/8	5 3/16
M10, M12, M15	15 1/2	7 1/2	3 5/8	5 3/16
V11	8 1/8	7 1/2	3 5/8	5 3/16
V20	12	7 1/2	3 5/8	5 3/16

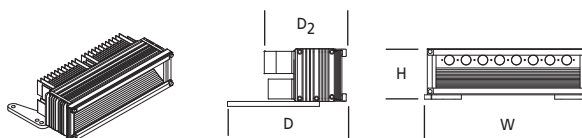

FCA830

Model	W	D	H
D15, D30, H30, S50, S72	11 1/2	5 3/16	4 5/8
M10, M12, M15	15	5 3/16	4 5/8
V20	11 1/2	5 3/16	4 5/8

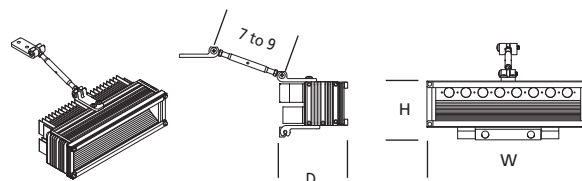

INDICATES EVOLUTION II LED MODEL

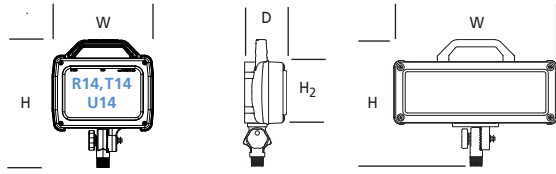

SPA100, SPA500, SPA600, SPA700

Model	W	D	H	H ₂
Q15, Q20, Q28, K20, K28, J20, J28, A28, B28, C28	14	3 3/4	11	5 3/8
R14, T14, U14	8 3/4	3 1/4	11	6 1/2

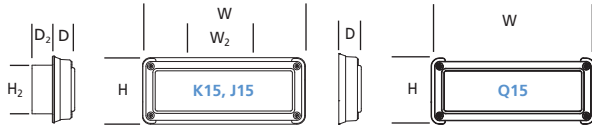

SPA260

Model	W	D	H	W ₂	D ₂	H ₂
Q15, Q20	14 1/2	1 3/4	5 7/8	-	-	-
K15, K20, J15, J20	14 1/2	1 3/4	6	6 3/8	1 13/16	4 11/16

AC surface mount requires a cut-out

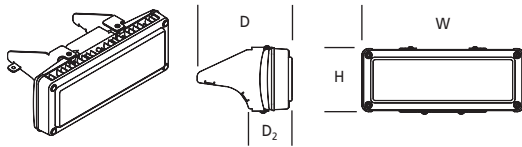

SPA800

* Measurement varies depending upon cab model

Model	W	D	H	D ₂ Max
Q15, Q20, Q28, K20, K28, J20, J28, A28, B28, C28	14	*	5 7/8	*
R14, T14, U14	8 3/4	*	6 1/2	*

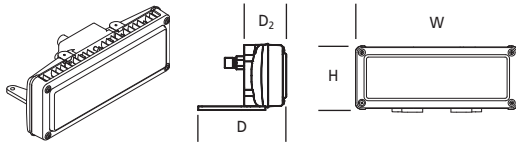

SPA850

Model	W	D	H	D ₂
Q15, Q20, Q28, K20, K28, J20, J28, A28, B28, C28	14	7 5/8	5 3/4	3 5/8
R14, T14, U14	8 3/4	7 1/2	6 3/4	3 1/4

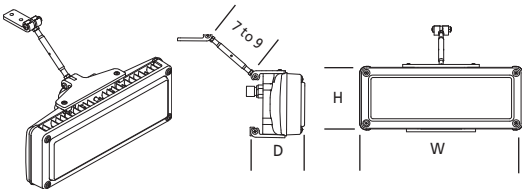

SPA830

Model	W	D	H
Q15, Q20, Q28, K20, K28, J20, J28, A28, B28, C28	14	4 3/4	6
R14, T14, U14	8 3/4	4 3/16	6 1/2

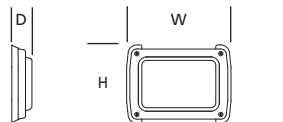

SPA900, SPA902, SPA950

Model	W	D	H
Q50	9	1 13/16	6 3/4
Q70	9	1 3/4	6 3/4

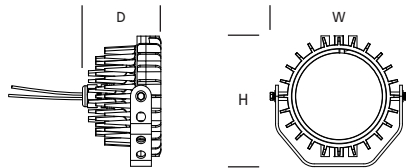

SRA100

Model	W	D	H
07A	6 1/4	3 3/4	5 15/16

LED100, LED110

Model	W	D
Q01	2 5/8	3/4

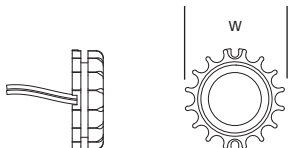

LED200, LED201

Model	W	D	H
A09	10 1/8	1 1/16	1
A18	19 1/8	1 1/16	1
A27	28 1/8	1 1/16	1
A36	37 1/8	1 1/16	1
A45	46 1/8	1 1/16	1
A54	55 1/8	1 1/16	1
A63	64 1/8	1 1/16	1

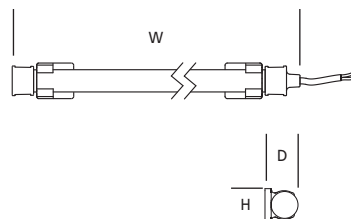

MAGNAFIRE 3000 Lighthouse - KR-3x

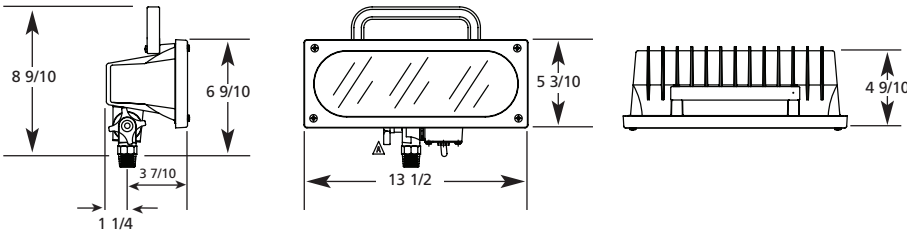

KR-3x-2

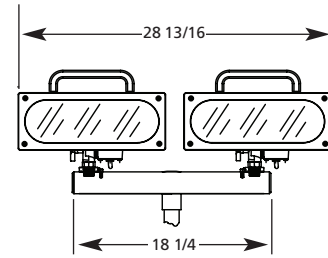

MAGNAFIRE 5000 Lighthouse - KR-5x

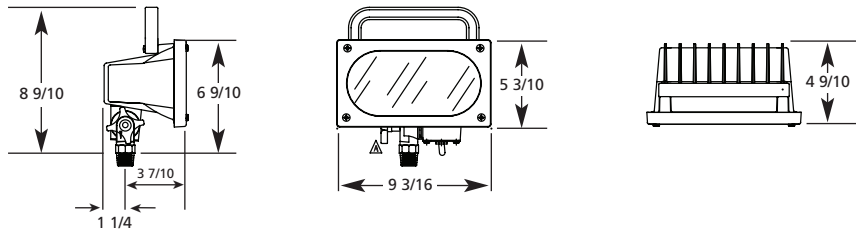

KR-5x-2

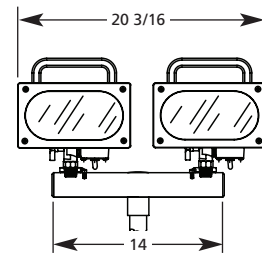

FX Lighthouse - CD-FX-6,-9,-12

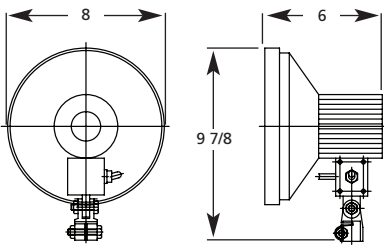

KR-06-2, KR-09-2, KR-12-2

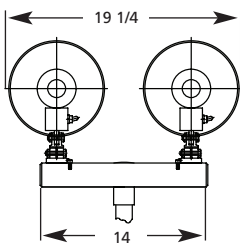

CD-FX-HID-1

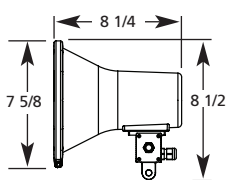

CD-CL-HID-1

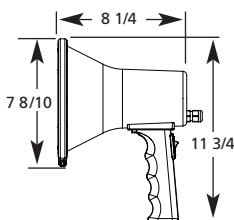

WORKPRO LED-3xx SERIES

LED 300

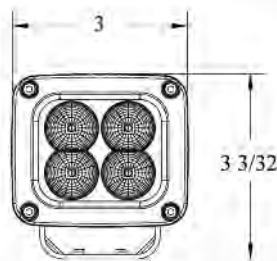

LED 310

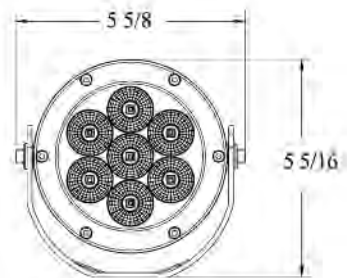

LED 320/330

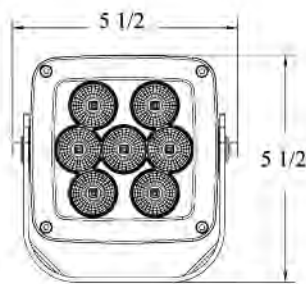

LED 340

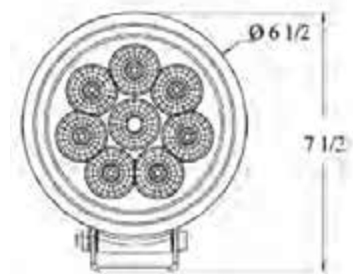

LED 350

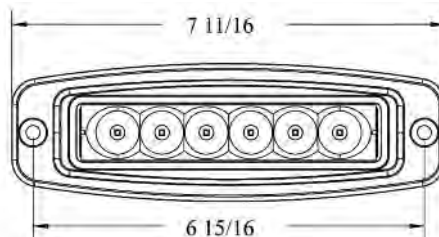

3 Simple Steps

Follow the three steps shown below to get your final product number. Need help? Call us.

1

Choose a Pole Style or Mount

Poles

- KR-SB-200
- KR-SB-300
- KR-SB-400
- KR-SB-500
- KR-900
- KB-SB-1100

Fixed Mounts

- KR-SB-600
- KR-SB-600-W
- KR-700
- KR-1300
- KR-1400
- KR-1800
- KR-1900
- KR-2100
- KR-2200
- KR-2300
- KR-2800
- KR-2900
- KR-3100

Brow Mount

- KR-1500



2

Choose a Lamphhead

Magnafire 3000

- 35
- 36
- 37
- 3B
- 3D

Magnafire 5000

- 55
- 56
- 57

Collins Dynamics FX

- HID-1
- 06
- 09
- 12



3

Choose Options

- GG wire guard
- DM portable demountable
- GR12 grab rail 12"
- GR18 grab rail 18"
- GR24 grab rail 24"
- R lower receiver support
- HD hold down assembly

Electrical

- S on/off switch
- I raised pole indicator & switch
- NCW non-concealed wire

Brackets

- W1
- W2
- W4
- W7
- W1P
- W2P
- W4P
- W7P
- TM
- TM-7



KR-SB-436-S =

KR-SB-4

+

-36

+

-S



4 Simple Steps

Follow the four steps shown below to get your final product number. Need help? Call us.

1

Indicate the
Light Prefix

SPA

for SPECTRA

FCA

for EVOLUTION II

OPA

for OPTIMUM

FCA

for FOCUS

SRA

for SoBRITE



SPA

2

Choose a
**Pole Style
or Mount**

Poles

- 510
- 510C
- 510E
- 512
- 530
- 540
- 542

Tripods

- 600
- 642
- 656

**Fixed
Mounts**

- 100
- 110
- 200
- 210
- 250
- 260
- 300
- 300U
- 570
- 580
- KR700
- 900
- 950

**Brow
Mounts**

- 800
- 830
- 850
-
-
-

530



3

Choose a
Lamphead

- Q15
- Q20
- Q28
- Q50
- Q70
- K15
- K20
- K28
- J15
- J20
- J28
- A28
- B28
- C28
- R14
- T14
- U14
- 07A
- 07B
- 07C
- V11
- V15
- V20
- S30
- S50
- S72
- S75
- M10
- M12
- M15
- D15
- D30



-K20

4

Choose
Options

- F flush mount bracket
- SR steady rest bracket
- CL custom length pole
- G wire guard
- NS no-scratch guide kit
- RB rubber bumpers
- ST 10" outer tube

Electrical

- ON on/off switch
- SW raised pole indicator & switch
- TW wire exits top of pole

Brackets

- A
- B
- C
- H
- 603
- 6F3



-ON



= SPA530-K20-ON



Learn more on-line or request our FoamPro and FRC full line catalogs of foam proportioning, instruments, controls, displays, accessories and video systems

FRC

A Safe Fleet Brand

26 Southern Blvd. Nesconset, NY 11767 • Tel : 631.724.8888 • Fax : 631.360.9727

1.800.645.0074

fireresearch.com • foampro.com



Active Member and Supporter



facebook.com
/ fire.research.corp

