



Lights & Electrical

Federal Lighting Requirements for Trailers..... J-2-J-4

Peterson Lights:

- LED Clearance/Marker Lights.....J-5
- LED TaillightsJ-6
- ID Bar Lights J-6 - J-7
- Incandescent Clearance/MarkerJ-7-J-10
- Pedestal Mount Stop/Turn/Tail J-10
- Stud Mount Stop/Turn/Tail J-11
- Flush Mount Stop/Turn/Tail J-11
- Multi-Function Taillights J-11
- Trailer Light Kit..... J-12
- Flush Mount Rectangular
- Combo Taillight J-12
- Sealed Side Marker/Turn Light J-12
- Flush Mount Sealed Stop/Turn/Tail.. J-12
- Flush Mount Sealed Turn Signal Light.. J-13
- Surface Mount Sealed
- Low Profile Taillight..... J-13
- Sealed License Plate Light..... J-13
- VIBAR License Light..... J-13
- Backup Lights J-14
- Tractor Utility Light J-14-J-15
- Dome Light w/Switch..... J-15
- Interior & Compartment Light..... J-15
- Aluminum Oval Reflector J-15

Optronics Lights:

- LED ID Bar Lights J-16
- LED Clearance/Marker Lights.... J-16-J-17
- LED Waterproof Stop/Turn/Tail Lights J-17
- LED Round Clearance/Marker Lights J-17
- LED Stop/Turn/Tail Lights J-18

- “Fleet Count” LED Lights..... J-19
- LED Backup Lights J-19
- LED Utility Lights..... J-20
- Stop/Turn/Tail Lights..... J-20
- Waterproof Stop/Turn/Tail Light J-20
- Clearance/Marker Lights.....J-21-J-22
- Backup Light..... J-22
- ID Bar Light J-22
- Taillight Kits J-22
- License Lights..... J-23
- Utility/Tractor Light J-23
- Weatherproof Light w/Switch J-23

Bargman Lights:

- ID Bar Light J-24
- Interior Light w/Switch..... J-24
- Porch & Utility Light J-24
- Fender Mount Combo Clearance/Side Marker Light J-14
- Wesbar Marine Lights..... J-25
- Auxiliary Towing Light Kit..... J-25
- Reflectors..... J-25-J-26
- Conspicuity Reflector..... J-26
- 3M Conspicuity Tape J-26
- Reflexite Conspicuity Tape.....J-27
- Redline Packaged Lights.....J-28 - J-29

StarLights:

- RV Motion Sensor Light J-30
- LED Bulbs J-30
- Replacement Bulbs..... J-31
- Taillight Guards J-31
- Lighting Accessories J-31
- Primary Wire..... J-32
- Bonded Parallel Primary Wire J-32

- Jacketed Duplex Brake Wire..... J-32
- Insulated Lighting Cable..... J-33
- Terminal Kit..... J-33
- Quick Disconnects..... J-33
- Ring Terminals..... J-34
- Spade Terminals..... J-34
- Butt Connectors..... J-34
- Heat Shrink Connectors J-34
- Bullet Connectors..... J-34
- Wire Nut..... J-34
- Quick Splices..... J-35
- Cable Ties..... J-35
- Wire Grommets J-35
- Wire Loom J-35
- Wire Loom Clamp..... J-35-J-36
- Wire Clips J-36
- Electrical Tape..... J-36
- Terminal Pliers J-36
- Circuit Testers..... J-36
- Fuses & Fuse Holders J-37
- Circuit Breakers..... J-37
- Turn Signal Flashers..... J-38
- Push-Pull Switch J-38
- Trailer Connectors J-38 - J-41
- Quick Fix Flat 4 Pole Connectors.....J-42
- Trailer Harnesses & Trailer Cords.. J-42-J-43
- Vehicle-to-Trailer Wiring Systems.. J-44-J-45
- Junction Box J-46
- Taillight Converters J-46
- Battery & Accessories J-47
- Trailer Connector Adapters..... J-48
- 4-Way Flat Tester with Display..... J-48
- Connector Brackets..... J-48

TECHNICAL & REFERENCE FEDERAL LIGHTING REQUIREMENTS FOR TRAILERS

IMPORTANT NOTE: Every lamp, reflex reflector, and conspicuity treatment must be permanently attached in the location specified below and must comply with all applicable requirements prescribed for it by FMVSS/CMVSS 108. The face of any device on the front/rear and sides should be, respectively perpendicular and parallel to the vehicle's centerline, unless it is photometrically certified at installation angle. No part of the vehicle shall prevent any device from meeting its prescribed requirements unless an auxiliary device meeting all prescribed requirements is installed.

IN CANADA: Manufacturers and importers of vehicles must have the proper certification test records demonstrating compliance of lighting components with all prescribed requirements.

BASIC EQUIPMENT REQUIRED ON ALL TRAILERS

DESCRIPTION				MANDATORY REQUIREMENTS			
Area	Equipment	SAE Lens Coding	Functional Purpose	Quantity	Color	Location	Height mm(in.) from the ground
1	Tail Lamps	(T)	Indicate vehicle's presence and width	Minimum 2	Red	On the rear - symmetrical as far apart as practicable	380-1830 (15-72)
	Stop Lamps	(S)	Indicate braking	Minimum 2	Red	On the rear - symmetrical as far apart as practicable	380-1830 (15-72)
	Rear Turn Signal Lamps	(I)	Indicate direction of turn	Minimum 2	Red or Yellow	On the rear - symmetrical as far apart as practicable	380-2110 (15-83)
	Rear Reflex Reflectors	(A)	Indicate vehicle's presence and width	Minimum 2	Red	On the rear - symmetrical as far apart as practicable facing rearward	380-1530 (15-60)
2	License Plate Lamp(s)	(L)	Illuminates license plate	Minimum 1	White	On the rear - above or at the sides of license plate	No requirement
3	Rear Side Marker Lamps <small>*photometrically certified at installation angle</small>	(P2, PC* or P3, PC2*)	Front and rear side marker lamps / side reflex reflectors indicate vehicle's presence and length	Minimum 2	Red	Each side at rear as far back as practicable	380-1530 (15-60) no max. for veh. under 2032mm (80") wide
	Rear Side Reflex Reflectors	(A)		Minimum 2	Red	Each side at rear as far back as practicable facing sideward	380-1530 (15-60)
4	a Front Side Marker Lamps <small>*photometrically certified at installation angle</small>	(P2, PC* or P3, PC2*)	Front and rear side marker lamps / side reflex reflectors indicate vehicle's presence and length	Minimum 2	Yellow	Each side at front as far forward as practicable	380 (15) minimum
	b Front Side Reflex Reflectors	(A)		Minimum 2	Yellow	Each side at front as far forward as practicable facing sideward	380-1530 (15-60)

ADDITIONAL EQUIPMENT FOR TRAILERS EXCEEDING THE FOLLOWING PARAMETERS

Length 9.1m (30 ft.) or longer

DESCRIPTION				MANDATORY REQUIREMENTS			
Area	Equipment	SAE Lens Coding	Functional Purpose	Quantity	Color	Location	Height mm(in.) from the ground
5	a Intermediate Side Marker Lamps <small>*photometrically certified at installation angle</small>	(P2, P3, PC* or PC2*)	Indicate presence of a long vehicle	Minimum 2	Amber	Each side near center facing sideward	380 (15) minimum
	b Intermediate Side Reflex Reflectors	(A)	Indicate presence of a long vehicle	Minimum 2	Amber	Each side near center facing sideward	380-1530 (15-60)

Width 2032mm (80 in.) or wider

DESCRIPTION				MANDATORY REQUIREMENTS			
Area	Equipment	SAE Lens Coding	Functional Purpose	Quantity	Color	Location	Height
6	Rear Clearance Lamps <small>*photometrically certified at installation angle</small>	(P2, PC* or P3, PC2*)	Show vehicle's width MAY NOT be combined with tail lamps	Minimum 2	Red	At widest point - symmetrical on the rear or near the rear facing rearward	As high as practicable may be lower only if ID lamps are at the top
7	Rear (identification (ID) Lamps	(P2 or P3)	Indicate presence of a wide vehicle	Exactly 3	Red	On the rear - center horizontally spaced 150mm (6 in.) to 300mm (12 in.) apart facing rearward	At the top - may be lower if floor header narrower than 25mm
8	Front Clearance Lamps <small>*photometrically certified at installation angle</small>	(P2, PC* or P3, PC2*)	Show vehicle's width	Minimum 2	Yellow	At widest point - symmetrical on the front or near the front facing forward	As high as practicable

Width 2032mm (80 in.) or wider AND GVWR 4536 kg (10,000 lb.) or more

DESCRIPTION		MANDATORY REQUIREMENTS					
Area	Conspicuity Treatment	DOT Coding	Quantity	Color	Location	Height	Options
9	Rear Upper Body Markings	DOT-C DOT-C2 DOT-C3 DOT-C4	Exactly 2 pairs of 300mm long strips	White	On the rear upper corners facing rearward	At the top	Reflex reflectors may not be required if they are replaced in their required location with conspicuity treatment. Optional in Canada: Rear lower body and side conspicuity treatment may also be solid white, solid yellow, or white and yellow.
10	Bumper Bar Marking		Continuous	Red/White	On the rear bumper bar's horizontal element full width - facing rearward	No requirement	
11	Rear Lower Body Marking		Continuous	Red/White (see options)	On the rear full width of the vehicle facing rearward	As horizontal as practicable and as close as practicable to the range of 375 to 1525mm from the ground	
12	Side Marking		(see location)	Red/White (see options)	Each side - facing sideward continuous, or evenly spaced over minimum of 50% of length starts and ends as close to the front and rear of the vehicle as practicable	As horizontal as practicable and as close as practicable to the range of 375 to 1525mm from the ground	

NOTE: The edge of red conspicuity tape shall not be closer than 75 mm to the edge of any amber lamp and the edge of white conspicuity tape shall not be closer than 75 mm to the edge of any lamp

TECHNICAL REFERENCE

FEDERAL LIGHTING REQUIREMENTS FOR TRAILERS

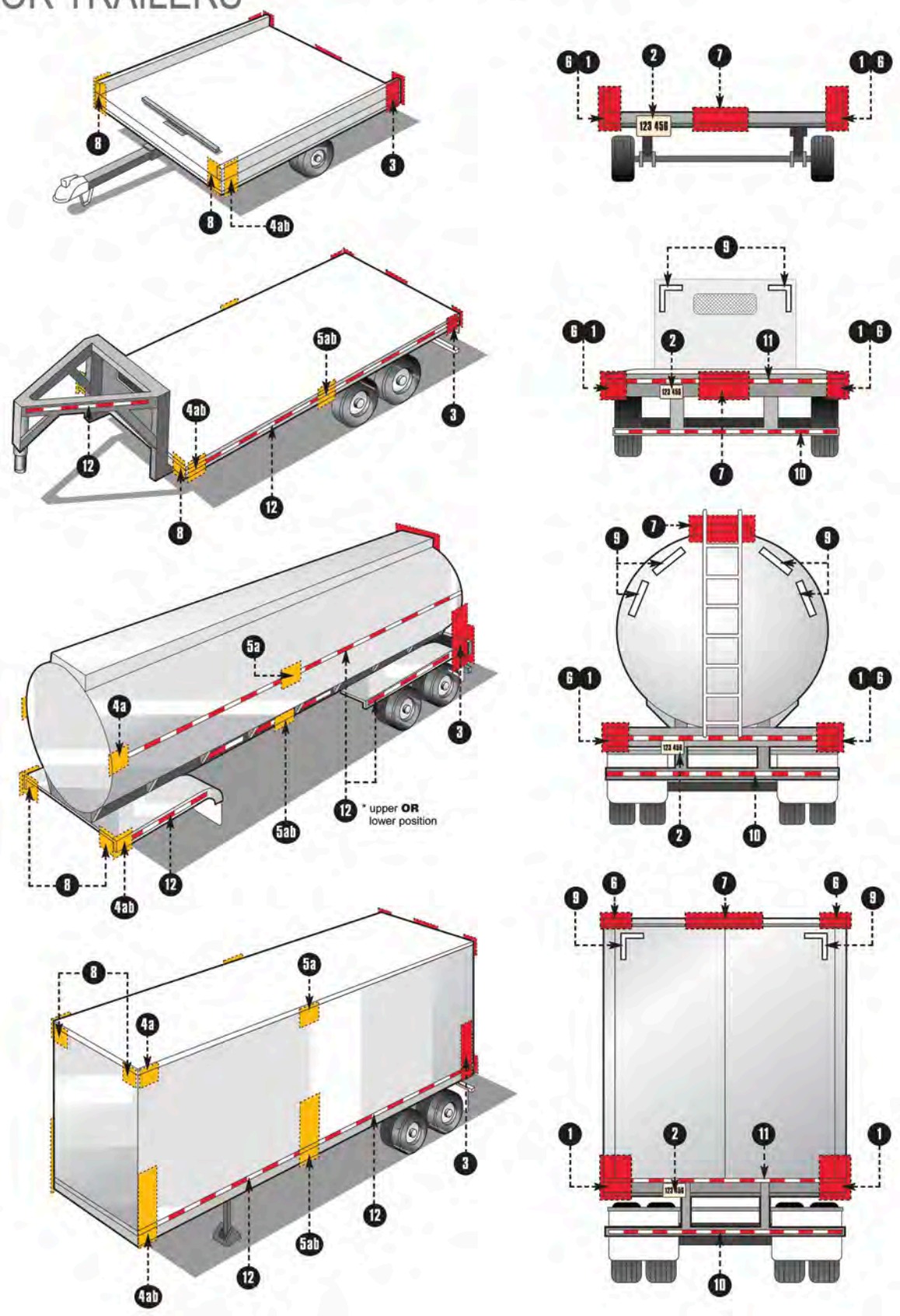

LIGHTS & ELECTRICAL

TECHNICAL REFERENCE

FEDERAL LIGHTING REQUIREMENTS FOR TRAILERS

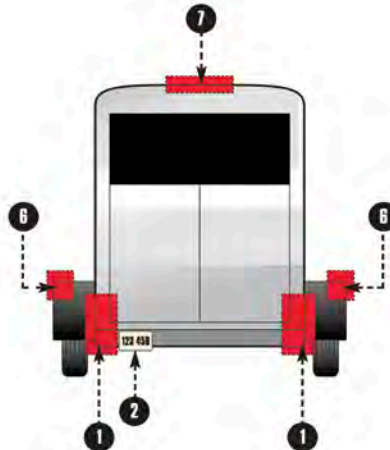
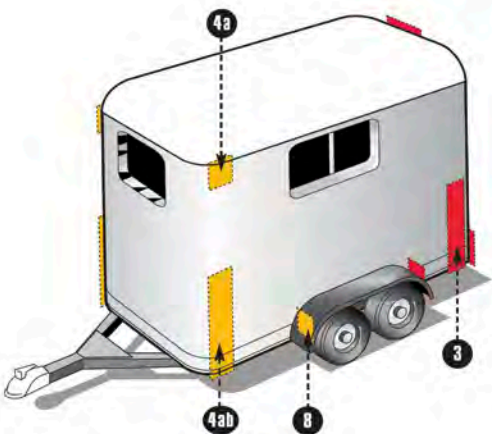
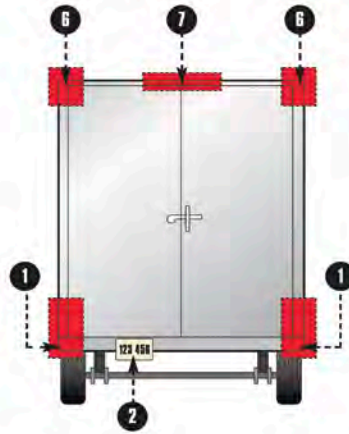
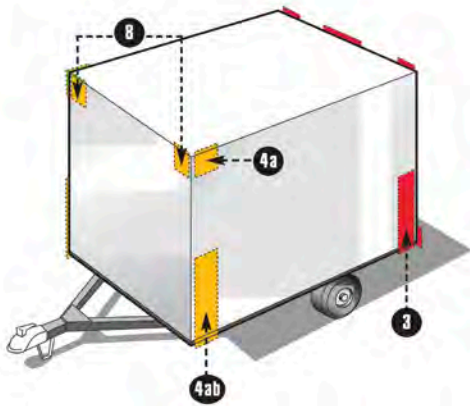
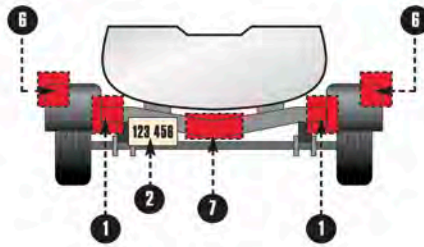
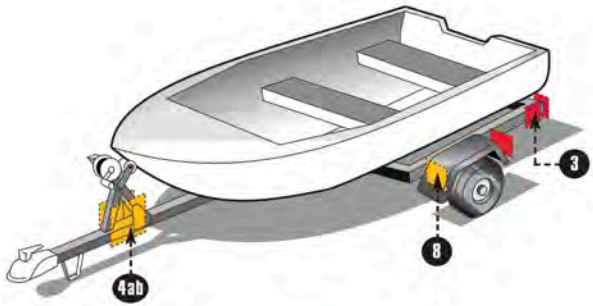
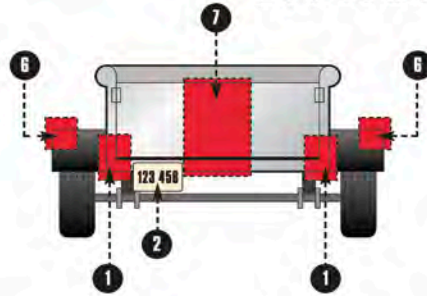
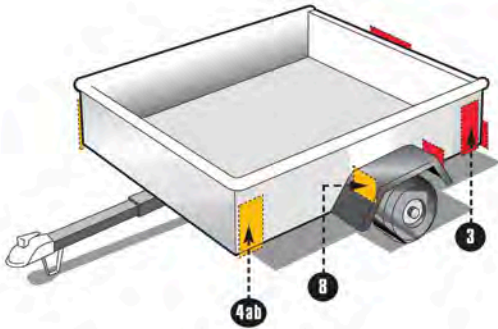



LED Clearance/Marker Lights

This sealed 2-diode LED light functions as a clearance or side marker light. Operates from 9-16 volts. Hard-wired design eliminates lamp-plug failure point. Mounts on 3" centers. Available in amber or red.

PART NO.	REF. NO.	DESCRIPTION
169R	421506	LIGHT LED THIN-LINE CLR/MARKER RED HARD-WIRED
B169-18	421507	BASE BLACK FOR 169 LED LIGHT
169A	421509	LIGHT LED THIN-LINE CLR/MARKER AMBER HARD-WIRED
M171A	421565	LED AMBER CLR/MRKR DOT W/GROMMET, 1 DIODE 3/4"
M171R	421566	LED RED CLR/MRKR DOT W/GROMMET, 1 DIODE 3/4"



169A

B169-18

M171R

M171A

LED 2-Diode Clearance/Marker Lights

This sealed 2-diode LED light functions as clearance or side marker light. Operates from 9-16 volts. Hard-wired with separate lead and ground wires for mounting to all surfaces. Mounts on 1 15/16" centers. 100,000-hour rated life. Available in amber or red.

PART NO.	REF. NO.	DESCRIPTION
168R	421530	LIGHT LED 2-DIODE CLR/MARKER RED HARD-WIRED
168A	421532	LIGHT LED 2-DIODE CLR/MARKER AMBER HARD-WIRED
B168-18	421535	BASE, BLACK, FOR 168 LED LIGHT
B168-10	421537	BRACKET, CHROME, FOR 168 LED LIGHT



168R

B168-18

168A

B168-10

2" Round LED Clearance/Marker Lights

This round, 2" sealed LED light functions as clearance, side marker, or identification light. Features sealed lens and housing. Operates from 9-16 volts and accepts industry standard 2 prong plug. Available in amber or red.

PART NO.	REF. NO.	DESCRIPTION
164R	421513	PIRANHA LED 2" ROUND CLEARANCE/SIDE MARKER RED
164A	421516	PIRANHA LED 2" ROUND CLEARANCE/SIDE MARKER AMBER
24174R	421514	LIGHT LED 2" ROUND CLEARANCE/SIDE MARKER RED
24174A	421517	LIGHT LED 2" ROUND CLEARANCE/SIDE MARKER AMBER
166-18K	421518	GROMMET & PIGTAIL FOR 2" ROUND LED FLUSH MOUNT



164R & 164A



166-18K

2 1/2" Round LED Clearance/Marker Lights

Clearance, side marker, or identification light versatility in a 2 1/2" round LED light; featuring sealed lens and housing. Operates from 9-16 volts. Accepts industry standard 2 prong plug. Available in amber or red.

PART NO.	REF. NO.	DESCRIPTION
162R	421520	PIRANHA LED 2-1/2" RND CLEARANCE/SIDE MARKER RED
24172R	421521	LED 2-1/2" RND CLEARANCE/SIDE MARKER RED
162A	421524	PIRANHA LED 2-1/2" RND CLEARANCE/SIDE MARKER AMBER
24172A	421525	LED 2-1/2" RND CLEARANCE/SIDE MARKER AMBER
163-18K	421526	GRMMT/PIGTAIL FOR 2 1/2" RND LED RECESS MOUNT
162-18K	421528	GRMMT/PIGTAIL FOR 2 1/2" RND LED FLUSH MOUNT



162R & 162A



162-18K

163-18K

LIGHTS & ELECTRICAL

LED Taillights

Round or oval, 7-diode LED stop, turn, and tail light meets FMVSS 108 in any 360 degree position. Operates from 9-16 volts.



420R-3

M417R-5



M420R-5K w/grommet



B417-49



M420R-5

PART NO.	REF. NO.	DESCRIPTION
420R-3	421495	LIGHT LED OVAL 7-DIODE STOP/TURN/TAIL W/PIGTAIL
421-18	421501	RUBBER GRMGT FOR SEALED OVAL STOP/TURN/TAIL LIGHT
LED-RT	421555	LED 4" ROUND, 7-DIODE, STOP/TURN/TAIL
426-18	421556	RUBBER GROMMET FOR SEALED 4" ROUND STP/TRN/TAIL
B417-49	421560	PIGTAIL FOR 4" RND LED & 10-DIODE OVAL LED LIGHT
M417R-5	435801	4" RND RED LED STOP/TURN /TAIL LIGHT HARD WIRED
M417R-5K	435805	4"RND RED LED STP/TRN/TL LGHT KIT HARD WRD W/GRMT
M420R-5	435806	6" OVAL RED LED STOP/TUR /TAIL LIGHT HARD WIRED
M420R-5K	435807	6" OVL RD LED STP/TRN/TL LGHT KIT HRD WRD W/GRMGT

Identification Mini-Light Bar

The 107 Series light bar has three mini-lights and contains #193 (12v) 15,000 hour heavy-duty bulbs. The 150 Series Bar features #2250 sealed lights for boat trailer use.



107-3R

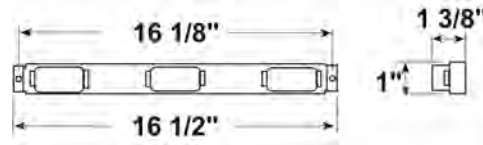

150-3R Sealed Marine Lights

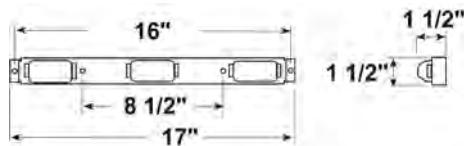

PART NO.	REF. NO.	DESCRIPTION	MNTG. BAR
107WA	422400	AMBER REPLACEMENT LENS	
107WR	422600	RED REPLACEMENT LENS	
107-3A	427800	AMBER LIGHT BAR	WHITE FINISH
107-3R	428000	RED LIGHT BAR	WHITE FINISH
150-3R	428100	RED SEALED LIGHTS	BLACK MOLDING
107-15A	443400	AMBER REPLACEMENT LENS	
107-15R	443600	RED REPLACEMENT LENS	
M150R	446600	RED REPL SEALED BEAM FOR 2636R & 150-3R	

LIGHTS & ELECTRICAL

VIBAR Identification Light Bar

This unit has three "Champion" lights with acrylic lenses that snap and seal into Lexan housings. The exclusive VIBAR sockets minimize premature bulb failure. The mounting bar is constructed of heavy gauge aluminum. It contains #193 (12v) 15,000 hour heavy-duty bulbs.



104-3R

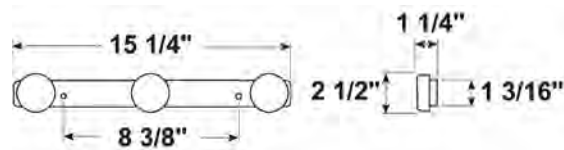

PART NO.	REF. NO.	DESCRIPTION	MNTG. BAR
104R	421800	RED REPLACEMENT LIGHT	
104-3R	427600	RED ID LIGHT BAR	ALUMINUM
100-15R	443200	RED REPLACEMENT LENS	



Thin-Line Identification Light Bar

This unit has three heavy-duty acrylic Thin-Line lenses that firmly snap into molded "O" rings on a sturdy black-finish steel bar. Attaches with two easy-access mounting holes. Only 2" wide, this unit contains #194 (12v) 2,500 hour heavy-duty bulbs.

PART NO.	REF. NO.	DESCRIPTION
136-3R	428200	RED W/BLACK STEEL BRKT
136-3A	428400	AMBER W/BLACK STEEL BRKT
136-15A	448800	LENS, AMBER FOR 45253 & 49063
136-15R	449000	LENS, RED FOR 45252 & 49062



136-3R

Rectangular Clearance or Side Marker Light/Reflector Single Stud Mount

This Side Marker or Clearance Light also acts as a Class A Reflector. Mounts with a single 1/4" diameter stud and features a patented VIBAR socket which extends bulb life. It contains a #194 (12v) 2,500 hour heavy-duty bulb.

PART NO.	REF. NO.	DESCRIPTION
114A	423200	AMBER LIGHT
114R	423400	RED LIGHT
55-15A	442600	AMBER REPLACEMENT LENS
114-15A	442700	LENS, CLEARANCE LIGHT, AMBER, NEW 114/115A
55-15R	442800	RED REPLACEMENT LENS
114-15R	442900	LENS, CLEARANCE LIGHT, RED, NEW 114/115R

114A & 114R

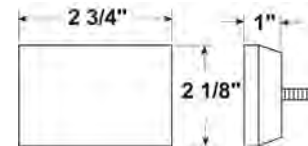
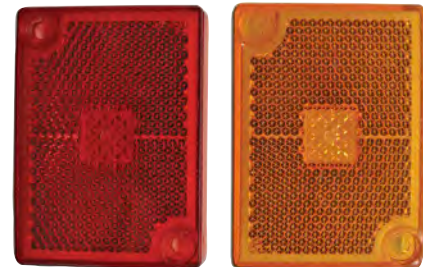

Rectangular Clearance or Side Marker Light/Reflector Surface Mount

This Side Marker or Clearance Light also acts as a Class A Reflector. Mounts with two screws without disassembly. The rugged molded housing protects the recessed lens from rocks and gravel. All the metal parts are stainless steel, so the light will not corrode. It contains a #194 (12v) 2,500 hour heavy-duty bulb.

PART NO.	REF. NO.	DESCRIPTION	HOUSING
115A	423600	AMBER LIGHT	BLACK MOLDING
115R	423800	RED LIGHT	BLACK MOLDING
55-15A	442600	AMBER REPLACEMENT LENS	
55-15R	442800	RED REPLACEMENT LENS	



115A

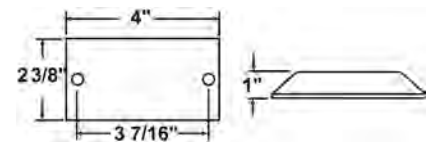

Rectangular Clearance or Side Marker Light

This deluxe, high-styled Clearance or Side Marker Light features chrome plating. A heavy molded vinyl mounting pad seals the back of the light. Requires a one inch diameter socket mounting hole. Stainless steel lens screws are included. It contains #194 (12v) 2,500 hour heavy-duty bulb.

PART NO.	REF. NO.	DESCRIPTION	HOUSING
126A	424800	AMBER LIGHT	CHROME MOLDING
126R	425000	RED LIGHT	CHROME MOLDING



126R

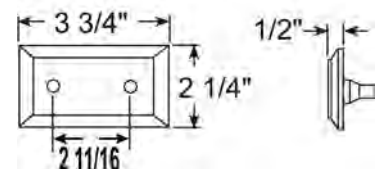

Rectangular Two Bulb Clearance or Side Marker Light



138A

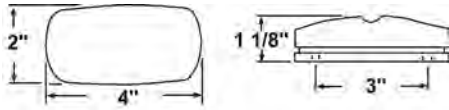

This popular style Clearance or Side Marker Light has a molded plastic base containing two VIBAR sockets for prolonged bulb life. All metal parts are tinned brass. It contains #193 (12v) 15,000 hour heavy-duty bulbs.

PART NO.	REF. NO.	DESCRIPTION
138A	425600	AMBER LIGHT
138R	425800	RED LIGHT
138-15A	446000	AMBER REPLACEMENT LENS
138-15R	446200	RED REPLACEMENT LENS

Steel Armored Clearance and Side Marker Light



119R

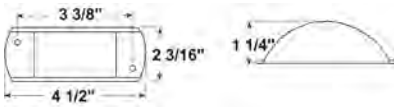

The acrylic lens is guarded by a 14 gauge bright plated steel housing, can be spot-welded to trailer rails and mounts without disassembly. The patented VIBAR socket minimizes premature bulb failure. Contains a #168 (12v) 2,500 hour heavy-duty bulb.

PART NO.	REF. NO.	DESCRIPTION	HOUSING
119A	424000	AMBER LIGHT	CHROME-PLATED STEEL
119R	424200	RED LIGHT	CHROME-PLATED STEEL
119-15A	444200	AMBER REPLACEMENT LENS	
119-15R	444400	RED REPLACEMENT LENS	

Vanguard II Armored Clearance and Side Marker Light

122XA



122A

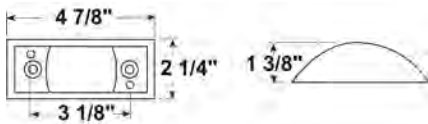

These armored lights are available with a standard grey or chrome plated molded nylon or aluminum housings that resists rust and corrosion. The patented VIBAR socket minimizes premature bulb failure. The pass-through mounting holes permit installation without disassembly and its flat back eliminates the need for a socket hole. Comes with a Lexide Mounting Gasket. Contains a #193 (12v) 15,000 hour heavy-duty bulb.

PART NO.	REF. NO.	DESCRIPTION	HOUSING
122A	424300	AMBER LIGHT	GREY MOLDING
122R	424350	RED LIGHT	GREY MOLDING
122XA	424400	AMBER LIGHT	CHROME MOLDING
122XR	424600	RED LIGHT	CHROME MOLDING
124A	424650	AMBER LIGHT	ALUMINUM MOLDING
124R	424700	RED LIGHT	ALUMINIUM MOLDING
124-15A	444600	AMBER REPLACEMENT LENS	
124-15R	444800	RED REPLACEMENT LENS	

Thin-Line Clearance or Side Marker Light



M136A



M136R

This oblong light in a non-corrosive, shock-absorbing molded housing is designed for narrow rails and channels where 2" wide lights will not fit. Featuring a cellulose sponge mounting pad, it measures 3 1/2" x 1 1/8" high with two 13/64" mounting holes on 2 3/4" centers and contains a #194 (12v) 2,500 hour heavy-duty bulb.

PART NO.	REF. NO.	DESCRIPTION
M136R	427200	RED LIGHT
M136A	427400	AMBER LIGHT
136-15A	448800	AMBER REPLACEMENT LENS
136-15R	449000	RED REPLACEMENT LENS



Sealed Clearance or Side Marker Light

The Lexan sealed lights are ideal for applications where small, attractive, waterproof clearance or marker lights are desired. The 2250 and 2636 series measure 2 1/4" x 1 1/4" x 3/4". The 2637 series measures 3 13/16" x 1 1/4" x 7/8" and comes with two bulbs.

PART NO.	REF. NO.	DESCRIPTION	HOUSING
2250A	435200	AMBER LIGHT	CHROME PLATED MOLDED PLASTIC
2250R	435400	RED LIGHT	CHROME PLATED MOLDED PLASTIC
2636A	435500	AMBER LIGHT	RUBBER GROMMET
2636R	435505	RED LIGHT	RUBBER GROMMET
2637A	435510	AMBER LIGHT	BLACK MOLDED PLASTIC
2637R	435515	RED LIGHT	BLACK MOLDED PLASTIC
M150R	446600	RED REP'L	SEALD BEAM FOR 2636R & 150-3R



Mini Clearance and Side Marker Light

This light is unbelievably compact, yet packed with quality features. The acrylic lens locks into the base and is highly resistant to being knocked out. It contains a #193 (12v) 15,000 hour heavy-duty bulb.

PART NO.	REF. NO.	DESCRIPTION	HOUSING
107WA	422400	AMBER LIGHT	WHITE MOLDING
107WR	422600	RED LIGHT	WHITE MOLDING
107-15A	443400	AMBER REPLACEMENT LENS	
107-15R	443600	RED REPLACEMENT LENS	



Oblong Clearance or Side Marker Light/Reflector

This Light and Class A Reflector combination features "cross-optics" for a brilliant signal and patented VIBAR sockets to prolong bulb life. Contains one or two #193 (12v) 15,000 hour heavy-duty bulbs.

PART NO.	REF. NO.	DESCRIPTION
108WA	422800	AMBER LIGHT W/ 1 BULB
108WR	423000	RED LIGHT W/ 1 BULB
106A	422000	AMBER LIGHT W/ 2 BULBS
106R	422100	RED LIGHT W/ 2 BULBS
108-15A	443800	AMBER REPLACEMENT LENS
108-15R	444000	RED REPLACEMENT LENS

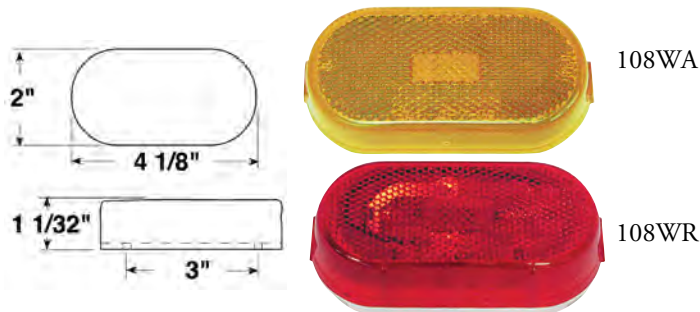

Oblong Two Bulb Clearance and Side Marker Light

This Two Bulb Light features two VIBAR sockets for prolonged bulb life. The acrylic lens snaps and seals into the housing. It contains two #193 (12v) 15,000 hour heavy-duty bulbs.

PART NO.	REF. NO.	DESCRIPTION
135A	425200	AMBER LIGHT
135R	425400	RED LIGHT
134-15A	445600	AMBER REPLACEMENT LENS
134-15R	445800	RED REPLACEMENT LENS

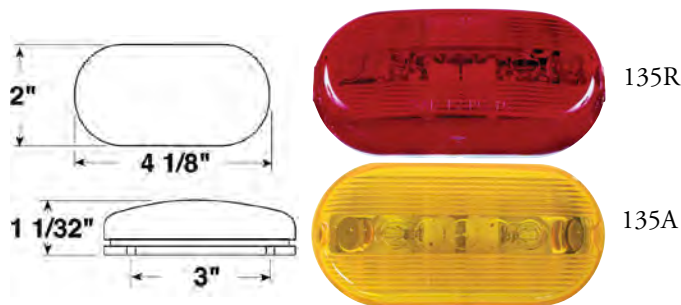

Round Sealed Clearance and Side Marker Light

The 2 1/2" Round Lights have Lexan lenses and housings sonically welded into sealed, single units. 143 Series has a built-in Class A Reflector in the lens. 2 1/2" Round Lights require a 142-18K or 143-18K Mounting Kit.

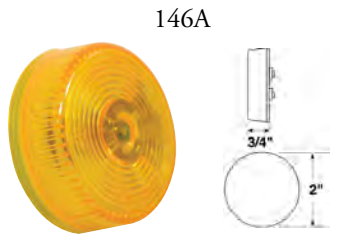

The 2" Round Lights utilize standard lenses, and are used for mounting in areas with limited space and require 146-18K Mounting Kits. Mounting Kits contain a grommet, plug and grounding screw. They also contain one #193 (12v) 15,000 hour heavy-duty bulb.

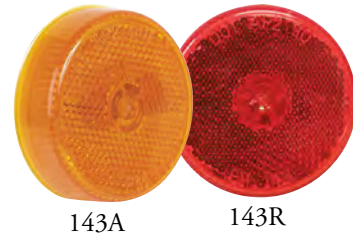

PART NO.	REF. NO.	DESCRIPTION	HOUSING
142A	425850	AMBER, 2 1/2" ROUND	STANDARD LENS
142R	425900	RED, 2 1/2" ROUND	STANDARD LENS
143A	426000	AMBER, 2 1/2" ROUND	REFLECTOR LENS
143R	426200	RED, 2 1/2" ROUND	REFLECTOR LENS
142-49	426600	REPL. PLUG FOR 142, 143 & 146 SERIES LIGHTS	
142-18K	426800	MTG KIT FOR FLUSH 2 1/2" RND LGHT, REQUIRES A 2-25/32" HOLE	
143-18K	427000	MTG KIT FOR RECESSED 2 1/2" RND LIGHT, REQUIRES A 3" HOLE	
146A	427100	AMBER, 2" ROUND	STANDARD LENS
146R	427110	RED, 2" ROUND	STANDARD LENS
146-18K	427125	MTG KIT FOR FLUSH 2" RND LGHT, REQUIRES A 2 5/16" HOLE	

"Champion" Round Clearance and Side Marker Light

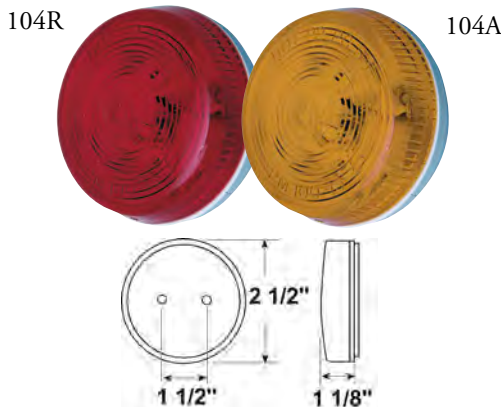

"Champion" Lights feature Lexan housings and VIBAR sockets to extend bulb life. The acrylic lens snaps and seals into the housing. A flat back eliminates the need for a socket hole. They contain one #193 (12v) 15,000 hour heavy-duty bulb.

PART NO.	REF. NO.	DESCRIPTION
104A	421600	AMBER LIGHT
104R	421800	RED LIGHT
100-15A	443000	AMBER REPLACEMENT LENS
100-15R	443200	RED REPLACEMENT LENS

Pedestal Mount Stop, Turn and Tail Light



This durable light has a black 4 1/8" ABS housing with a snap-on red lens that functions as a stop, turn and tail light. Two lead wires exit through 1/2" diameter hollow stud. It contains a #1157 bulb.

PART NO.	REF. NO.	DESCRIPTION	HOUSING	LENS
313-2	429005	RED LIGHT	BLACK POLY	
338-15R	448725	RED REPLACEMENT LENS		STANDARD
338-15A	448730	AMBER REPLACEMENT LENS		STANDARD



Stud Mount Stop, Turn and Tail Light

Stud Mount Three Function Lights perform as stop, turn and tail lights. Four Function Light performs all the same functions, plus a license illuminator. Both feature wrap-over-lens retained by two screws onto a black plastic housing making the light dust resistant. 1/4" studs include mounting hardware. Contains a #1157 bulb. Part #445 is standard on trucks such as Peterbilt, Mack, White and Jeep.



445

PART NO.	REF. NO.	DESCRIPTION	FUNCTION	HOUSING
428S	431800	RED LIGHT	3	BLACK PLASTIC
428W	432000	RED LIGHT	4	BLACK PLASTIC
445	432500	RED LIGHT	4	BLACK PLASTIC
420-15R	448400	RED REPL LENS FOR 428 SERIES LIGHTS		
413-07	451000	REPL PLUG FOR 428 SERIES LIGHTS		

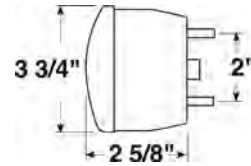

428S

Flush Mount Stop, Turn and Tail Light

These Flush Mount Lights provide stop, turn and tail light functions. Choose from a steel housing with black enamel finish or a 304 stainless steel housing with satin finish. Steel housing lights come with either brass or VIBAR bulb sockets. All three types come with regular, or reflex reflector optics around the periphery of the lens. All six lights feature a snap ring retaining wire to secure the lens and a #1157 (12v) bulb.



413S

425-3

PART NO.	REF. NO.	DESCRIPTION	SOCKET	HOUSING	LENS
413-3	429600	RED LIGHT	BRASS	POLY	REFLECTIVE
413	429650	RED LIGHT	BRASS	POLY	STANDARD
413S-3	429800	RED LIGHT	BRASS	STAINLESS STEEL	REFLECTIVE
413S	429850	RED LIGHT	BRASS	STAINLESS STEEL	STANDARD
425-3	430000	RED LIGHT	VIBAR	MILD STEEL	REFLECTIVE
425	430050	RED LIGHT	VIBAR	MILD STEEL	STANDARD
410-15R	447600	LIGHT, TAIL LENS, RED FOR 413, 413S & 425			
410-21	447800	REPL RETAINER RING FOR 413 & 425 SERIES LIGHTS			
414-15C	448000	CLEAR REPLACEMENT LENS			
415-15R	448200	RED REPLACEMENT LENS			
413-07	451000	REPL PLUG FOR 413 & 425 SERIES LIGHTS			

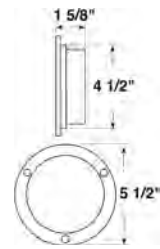

Rectangular Multi-Function Combination Taillight

This Multi-Function Rear Light has a corrosion resistant molded housing and bronze contacts. No plug is required; simply insert the wire ends for a secure connection. Right Hand Light functions as a stop, turn, tail, rear reflex, side marker and side reflex. Rear Left Hand Light performs the same, plus has a license illuminator. 440 series lights contain a #1157 and a #1895 bulb. 444 series lights contain a #1157 and a #193 bulb.

440

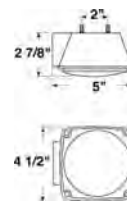

444

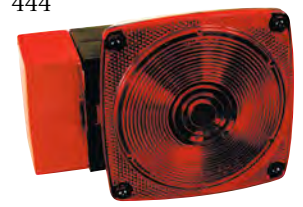
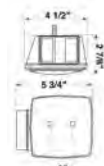

PART NO.	REF. NO.	DESCRIPTION	FUNCTION	SIDE	APPLICATION
440	432200	RED LIGHT	6	RIGHT HAND	UNDER 80" WIDE TRAILERS
440L	432400	RED LIGHT	7	LEFT HAND	UNDER 80" WIDE TRAILERS
444	432450	RED LIGHT	7	RIGHT HAND	OVER 80" WIDE TRAILERS
444L	432475	RED LIGHT	8	LEFT HAND	OVER 80" WIDE TRAILERS
55-15R	442800	RED REPL SIDE MARKER LENS FOR 440 SERIES LIGHTS			
440-15R	448600	RED REPL LENS FOR 440 & 444 SERIES LIGHTS			
56-15R	448700	RED REPL SIDE LENS FOR 444 SERIES LIGHTS			

LIGHTS & ELECTRICAL

Trailer Light Kit

Kits feature the 440 Combination Rear Light with special electrical connections that eliminate external wiring splices. Wiring harnesses simply plug into the back of the lights. The Kits provide all legal lighting and reflective equipment for any trailer less than 80" wide.

Front side marker lights have built-in reflectors and mount with a single stud. Kits include a four wire split harness, frame clips, flexible plastic license bracket and wire nuts.



PART NO.	REF. NO.	DESCRIPTION	WIRING HARNESS
540	432600	TRAILER LIGHT KIT	20 FT LONG
545	432800	TRAILER LIGHT KIT	25 FT LONG

Sealed Side Marker/Turn Signal Light



Lexan housing and lenses are sonic welded to provide a permanent seal. Meets SAE recommended practice for side turn signals, while providing marker and reflector functions. Includes grommet and plug. Often used with mounting bracket #421-09.

PART NO.	REF. NO.	DESCRIPTION	HOUSING
352KA	436650	AMBER LIGHT KIT	WHITE MOLDED PLASTIC

Flush Mount Sealed Stop, Turn and Tail Light

LIGHTS & ELECTRICAL



427KR

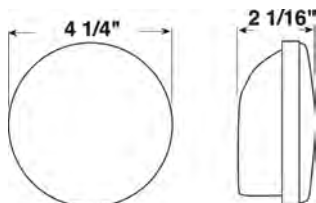

These Flush Mount Sealed Lights feature a Lexan housing and lens that's permanently sealed by a fusion bonding process. The bulb floats in a VIBAR socket for extended life. The exclusive wire connection port offers maximum corrosion protection when used with the plug and mounting grommet provided. Kit contains the grommet and plug necessary for installation.

PART NO.	REF. NO.	DESCRIPTION	TYPE
426-18	421556	REPL RUBBER GROMMET	
426KA	435600	AMBER LIGHT KIT	STANDARD
426KR	435800	RED LIGHT KIT	STANDARD
426R	435810	REPL RED SEALED BEAM FOR 426KR	
427KR	436000	RED LIGHT KIT	REFLECTIVE
431-491	436400	REPL PLUG FOR 426 & 427 SERIES LIGHTS	



Flush Mount Sealed Turn Signal Light

This unit is completely sealed in a Lexan housing and lens, and the bulb is shock mounted to protect it from wear and tear. This advanced design virtually eliminates rust, corrosion, filament fracture and installation or removal problems. Light is ideal for narrow widths. It is legal in either horizontal or vertical mount. The kit contains the grommet, plug and grounding screw necessary for installation.



421KR



PART NO.	REF. NO.	DESCRIPTION
421-18	421501	REPL RUBBER GROMMET
421KA	436625	AMBER LIGHT KIT
421KR	436800	RED LIGHT KIT
421R	436808	REPL RED SEALED BEAM FOR 421KR

Surface Mount Sealed Low Profile Taillight

Hermetically sealed to protect the bulb and electrical contacts from damage by water or corrosion. Right Hand Light performs as a stop, turn and tail light, rear and side reflector, side marker and rear clearance. Left Hand Light performs the same, plus has a license illuminator.



456

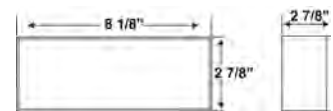

PART NO.	REF. NO.	DESCRIPTION	FUNCTION	SIDE
456L	436810	RED LIGHT	8	LEFT HAND
456	436812	RED LIGHT	7	RIGHT HAND

Sealed License Plate Light

This all Lexan sealed License Illumination Light meets all federal specifications when properly mounted. Comes with plug.

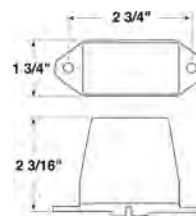

439K



PART NO.	REF. NO.	DESCRIPTION
142-49	426600	REPL PLUG FOR 439K SERIES LIGHT
439K	435100	LICENSE LIGHT KIT
439	435105	REPL SEALED LICENSE PLATE LIGHT ONLY

VIBAR License Light

This light features Lexan housing retained with a steel screw and a VIBAR socket to extend the bulb life. All internal parts are stainless steel or brass. The 436B includes a heavy gauge black steel bracket for license attachment. Contains a #168 bulb.



436B

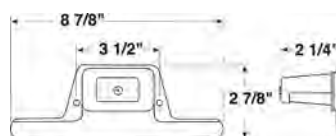

PART NO.	REF. NO.	DESCRIPTION
436	434400	VIBAR LICENSE LIGHT
436B	434600	LICENSE LIGHT W/BKT

Backup Lights

Backup Light with a stainless steel housing utilizes the standard 4 1/4" clear lens (#414-15C), held in place by a retainer ring. The sealed backup lights feature a clear Lexan lens and VIBAR socket. Kit comes with a plug and mounting grommet.

Part 411SC contains a #1156 bulb.



411SC



415K



416K

PART NO.	REF. NO.	DESCRIPTION	HOUSING
411SC	429870	CLEAR BACKUP LIGHT	STAINLESS STEEL
415K	436200	CLEAR BACKUP LIGHT KIT	SEALED (GROMMET)
416K	436600	CLEAR BACKUP LIGHT KIT	SEALED (GROMMET)
414-15C	448000	CLEAR REPL LENS FOR 411SC	

Rectangular Backup Light



This popular design has a tough Lexan lens featuring pillow optics for maximum light dispersion. It measures 4 9/16" x 2 1/2" x 1 3/4" high. Contains a #1141 bulb.

PART NO.	REF. NO.	DESCRIPTION	TYPE
393C	433800	CLEAR BACKUP LIGHT	SURFACE MOUNT

Tractor Utility Lights

LIGHTS & ELECTRICAL



The 507-12 Tractor Light has a 3,000 candle power trapezoidal beam pattern. It is mounted in a black rubber housing for increased shock resistance. A 5/16" mounting stud and swiveling bracket permit installation on horizontal, vertical or slanted surfaces. The horizontal adjustment is 360 degrees, vertical adjustment 90 degrees forward and 90 degrees back.

Overall diameter is 4 3/4", installed height 5 7/8", depth 2 3/4". It contains a par 36, 12 volt sealed beam.

PART NO.	REF. NO.	DESCRIPTION	HOUSING
507-12	434010	CLEAR TRACTOR OR UTILITY LIGHT	BLACK RUBBER



Utility Light

The 517 Mini Halogen Light features black plastic housing, low rectangular profile with swivel mounting 2 3/8" stud, and stainless steel external hardware for corrosion-free service. Loading light for truck beds, van-type trailers, etc.



PART NO.	REF. NO.	DESCRIPTION	HOUSING
517	434150	CLEAR HALOGEN UTILITY LIGHT	BLACK PLASTIC

Dome Light with Switch

A rugged polypropylene housing and a tough, flexible high density lens combine to make this unit ideal for bright general illumination. The lens is virtually indestructible...it will give and flex rather than shatter or crack.

The light is operated by a push-type on/off switch. Grounds through mounting screws. The lens diameter is 4 13/16", housing diameter is 6 5/16" and height is 2". It contains a #1141 bulb.



390S

PART NO.	REF. NO.	DESCRIPTION	HOUSING
389S	433075	WHITE DOME LIGHT	ALUMINUM
390S	433200	WHITE DOME LIGHT	WHITE

Interior and Compartment Light

This durable surface mount light measures 4 9/16" x 2 1/2" x 1 3/4" high. Features a Lexan lens, a long-life, all-nylon on/off push switch and is supplied with ground wires for mounting on non-metallic surfaces. It contains a #1141 bulb.



PART NO.	REF. NO.	DESCRIPTION
391	433600	CLEAR INTERIOR & COMPARTMENT LIGHT

Aluminum Oval Reflector

This is a rustproof Reflector with a 3" diameter acrylic lens.

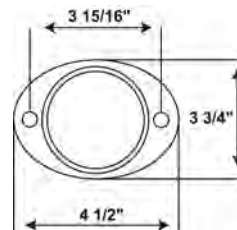

PART NO.	REF. NO.	DESCRIPTION	HOUSING
B472A	437000	AMBER REFLECTOR	ALUMINUM
B472R	437200	RED REFLECTOR	ALUMINUM



LED Identification Bar Lights

The 3-light ID bars with LED technology offer an improved appearance to any trailer. MCL-97RB has a stainless steel bar for marine applications. Lifetime warranty.

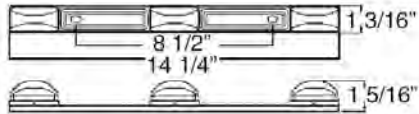

PART NO.	REF. NO.	DESCRIPTION
MCL-97RB	451237	3-LIGHT STAINLESS STEEL - RED
MCL-93RB	451790	BLACK POLY SEALED 3-PC RED 50" WIRE

LED Clearance/Marker Lights

For the complete LED look, add these clearance and marker lights, available in "thin-line" and "mini" styles. Lifetime warranty.



MCL-90RB

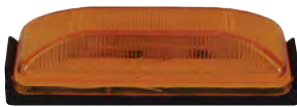

MCL-67AB



MCL-13AB



MCL-65RB



MCL-91RB

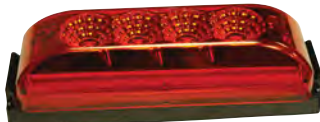

MCL-63RBK



AL-91RB

AL-91AB



AL-91OB



MCL-36AB



AL-191AB



MCL-17AB



MCL-63RB

PART NO.	REF. NO.	DESCRIPTION
MCL-13AB	451600	MINI LED SEALED CLR/MARKER LIGHT, AMBER
MCL-13RB	451602	MINI LED SEALED CLR/MARKER LIGHT, RED
MCL-17RB	451606	MIRO-FLEX MINI STAR LED OBLONG RED MARKER LIGHT
MCL-17AB	451608	MIRO-FLEX MINI STAR LED OBLONG AMB MARKER LIGHT
MCL-36AB	451650	MINI SEALED LED CLRANCE /MARKER LIGHT AMBER
MCL-36RB	451651	MINI SEALED LED CLEARANC /MARKER LIGHT RED
MCL-63AB	451730	MIRO-FLEX THIN LINE LED SEALED MARKER LIGHT AMB
MCL-65AB	451731	LED CLR/MARKER THIN-LINE, SEALED AMBER
MCL-63RB	451734	MIRO-FLEX THIN LINE LED SEALED MARKER LIGHT RED
MCL-65RB	451735	LED CLR/MARKER THIN-LINE, SEALED RED
MCL-67AB	451750	LED KIT CLR/MRKR THIN LINE AMBER W/BASE & PLUG
MCL-67RB	451754	LED KIT CLR/MRKR THIN LINE RED W/BASE & PLUG
A-91OB	451769	CHROME BASE, OPEN BACK FOR 91 SERIES CLR/MKR LIGHT
MCL-90RB	451770	MINI LED MARKER LIGHT CHROME COVER - RED
MCL-90AB	451771	MINI LED MARKER LIGHT CHROME COVER - AMBER
AL-91AB	451773	REPLACEMENT LIGHT, FITS MCL-91AB
AL-191AB	451774	MIRO-FLEX MINI THIN LINE SLD LED MRKR LGHT AMBER
AL-91RB	451778	REPLACEMENT LIGHT, FITS MCL-91RB
AL-191RB	451779	MIRO-FLEX MINI THIN LED SEALED MRKR LIGHT RED

LIGHT KITS

PART NO.	REF. NO.	DESCRIPTION
MCL-63ABKC	451122	MIRO-FLEX THNLNE LED AMR SIDE MRKR LGT KIT, CHROME
MCL-63RBKC	451123	MIRO-FLEX THNLN LED RED SIDE MRKR LGT KIT, CHOME
MCL-91AB	451772	LED KIT CLR/MARKER MINI, AMBER CHROME BASE & PLUG
AL-91ABK	451775	MINI LED AMBR MRKR LGHT KIT W/ GRMMT & PGTL
AL-91RBK	451776	MINI LED RED MRKR LIGHT KIT W/GRMMT & PGTL
MCL-91RB	451777	LED KIT CLR/MARKER MINI, RED CHROME BASE & PLUG
AL-191ABK	451781	MIRO-FLEX MINI THNLN AMB MRKR LGHT KIT W/BASE&PLG
AL-191RBK	451782	MIRO-FLEX MINI THNLN RED MRKR LGHT KIT W/BASE&PLG
MCL-63ABK	451784	MIRO-FLEX THNLN AMB LED MRKR LGHT KIT W/BASE&PLG
MCL-63RBK	451785	MIRO-FLEX THNLN RED LED MRKR LGHT KIT W/BASE&PLG



LED Fender Mount Clearance/Marker Light

This LED fender mount clearance/marker light takes the place of two separate lights. The bi-colored lens functions both as a forward facing amber clearance, and rearward facing red marker. Lifetime warranty.

PART NO.	REF. NO.	DESCRIPTION
MCL-65ARB	451736	DUAL LED AMBER/RED FNDR MT, PC RATED THINLINE
MCL-67ARB	451760	CLEARANCE LIGHT RED/AMBER, LED FENDER MOUNT



MCL-65ARB

LED Waterproof Stop/Turn/Tail Lights

These waterproof LED taillights are perfect for marine applications. Available in 6 and 7 function, with a lifetime warranty.

PART NO.	REF. NO.	DESCRIPTION
STL-16RB	451866	LED 6-FUNCTION RECTNGLR, WATERPROOF TAIL SS HDWE
STL-17RB	451870	LED 7-FUNCTION RECTNGLR, WATERPROOF TAIL SS HDWE



LED Round Clearance/Marker Lights

These 2" & 2-1/2" LED marker lights are sealed against the environment, and will replace any similar incandescent light. Pigtails and grommets are also available. Lifetime warranty.



A-46PB

MCL-11AKB

MCL-11RKB



MCL-50RB

MCL-50AB

PART NO.	REF. NO.	DESCRIPTION
A-46PB	451109	PIGTAIL, 2-WIRE, FOR, 2" & 2-1/2" CLR/MARKER
A-54GK	451115	GROMMET, PIGTAIL, SCREW, FOR FLUSH MOUNT 2" RND
A-55GK	451118	GROMMET, PIGTAIL, SCREW, FOR FLUSH MNT 2-1/2" RND
A-57GK	451121	GROMMET, PIGTAIL, SCREW, FOR RECESSED MT 2-1/2" RND
MCL-11RKB	451596	LED UNI-LITE W/GROMMET RED
MCL-11AKB	451598	LED UNI-LITE W/GROMMET AMBER
MCL-50AB	451695	MIRO-FLEX 2" RND AMB LED SEALED MARKER LIGHT
MCL-55AB	451700	LED CLR/MARKER 2" ROUND, SEALED AMBER
MCL-50RB	451703	MIRO-FLEX 2" RND RED LED SEALED MARKER LIGHT
MCL-55RB	451705	LED CLR/MARKER 2" ROUND, SEALED, RED
MCL-57AB	451720	LED CLR/MARKER 2 1/2" ROUND, SEALED AMBER
MCL-57RB	451724	LED CLR/MARKER 2 1/2" ROUND, SEALED RED



MCL-55RB

MCL-55AB



MCL-57RB

MCL-57RB

LIGHT KITS

PART NO.	REF. NO.	DESCRIPTION
MCL-55ABK	451699	2" LED AMBER LIGHT KIT W/GRMMT & PIGTAIL
MCL-55RBK	451704	2" RED LED LIGHT KIT W/GRMMT & PIGTAIL
MCL-57ABK	451719	2 1/2" RND AMBR LED LGT KIT FLSH MNT W/GRMT & PIGTAIL
MCL-57RBK	451723	2 1/2" RND RED LED LGT KIT FLSH MNT W/GRMT & PIGTAIL
MCL-50ABK	451806	MIRO-FLEX 2" RND AMBR LED CLRC/MKR KIT W/GRMT&PGT
MCL-50RBK	451808	MIRO-FLEX 2" RND RED LED CLRC/MKR KIT W/GRMT&PGT

LIGHTS & ELECTRICAL



LED Stop/Turn/Tail Lights

These 6 and 7 function stop/turn/tail lights make a great addition to any trailer. Available in several configurations; with pigtails, grommets, and chrome dress up rings. Lifetime warranty.

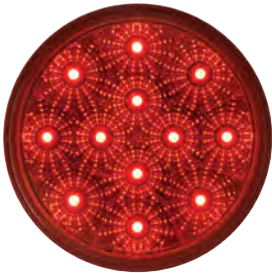

STL-23RB



STL-43RB



STL-78RB & AB

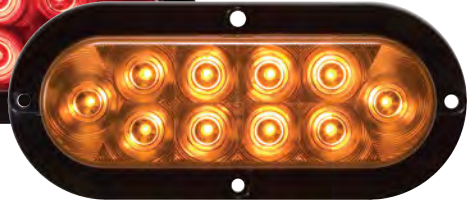

STL-22RB



STL-72RB



STL-79RB



STL-8RB



STL-76RB



A-47PB



A-45GB

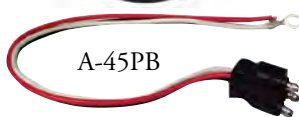

A-45PB



A-70GB



A-78CB

PART NO.	REF. NO.	DESCRIPTION
A-45GB	451103	GROMMET FOR 4" ROUND, LIGHT
A-70GBD	451106	GROMMET FOR 6" OVAL, LIGHT
A-45PB	451112	PIGTAIL, 3-WIRE, STR, FOR STOP/TURN/TAIL LITE
A-47PB	451117	PIGTAIL, RIGHT ANGLE 3-WIRE STOP/TURN/TAIL
STL-23RB	451828	MIRO-FLEX 4" RND RED LED STOP/TURN/TAIL LIGHT
STL-43RB	451830	LED 4" ROUND SEALED RED, STOP/TURN/TAIL 10-DIODE
STL-22AB	451833	MIRO-FLEX 6" OVL AMBER LED PARK/REAR TURN SIGNAL
STL-22RB	451834	MIRO-FLEX 6" OVL RED LED STOP/TURN/TAIL LIGHT
STL-72AB	451836	6" OVAL SLD LED AMBER PRK REAR TURN LIGHT 10 DIODE
STL-72RB	451837	LED 6" OVAL SEALED RED, STOP/TURN/TAIL 10-DIODE
STL-78AB	451841	LED 6" OVAL SLD AMBER PRK TURN, 10-DIODE SURFC MNT
STL-78RB	451842	LED 6" OVAL SEALED RED, S/T/T 10-DIODE SURFC MNT
STL-79RB	451843	THIN LINE SEALED LED STOP/TURN/TAIL
A-78CB	451845	RING CHROME DRESS-UP, FOR STL-78RB
STL-76RB	451848	LED THINLINE REPLACEABLE, LENS S/T/T SURFACE MNT
STL-8RB	451855	LED 6-FUNCTION STUD MNT, UNIVRSAL TAILLIGHT
STL-9RB	451859	LED 7-FUNCTION STUD MNT, UNIVRSAL TAIL W/ILLMNT

LIGHT KITS

PART NO.	REF. NO.	DESCRIPTION
STL-23RBK	451800	MIRO-FLEX 4" RND RED LED STOP/TRN/TL KIT W/GMT&PGT
STL-22RBK	451802	MIRO-FLEX 6" OVL RED STOP/TRN/TL KIT W/GRMMT&PGTL
STL-22ABK	451804	MIRO-FLEX 6" OVL AMB LED PK/TRN/TL KIT W/GMMT&PGT
STL-43RBK	451829	4" RND LED STOP/TURN/TAIL W/GRMMT & PIGTAIL
STL-72ABK	451835	6" OVAL AMBR LED PARK/REAR/TURN W/GRMMT & PGTL
STL-72RBK	451838	6" RED LED OVAL STOP/TURN/TAIL W/GRMMT & PGTL

"Fleet Count" LED Lights



- LED's are brighter than conventional lights
- LED's consume 90% less energy
- 100% maintenance free
- Lifetime LED Warranty



STL-13RB



STL-12RB

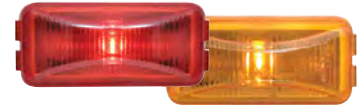

AL-90RB & AB



MCL-61RB & AB



MCL-56RB & AB



MCL-527RB & AB

PART NO.	REF. NO.	DESCRIPTION
STL-12RB	451505	6 DIODE LED S/T/T 6" OVAL RED
STL-13RB	451506	7 DIODE 4" RND S/T/T RED
STL-12RBK	451507	6 DIODE 6" OVL S/T/T RD LGHT KIT W/GRMT & PGTL
STL-13RBK	451508	7 DIODE 4" RND S/T/T RED LGHT KIT W/GRMT & PGTL
AL-90AB	451510	MINI 1 DIODE SEALED AMBER LED LIGHT
AL-90RB	451511	MINI 1 DIODE SEALED RED LED LIGHT
AL-90ABK	451512	MINI 1 DIODE SEALED AMBER LGHT KIT W/GRMT & PGTL
AL-90RBK	451513	MINI 1 DIODE SEALED RED LGT KIT W/GRMT & PGTL
MCL-61AB	451514	2 DIODE LED THINLINE AMBER LIGHT
MCL-61RB	451515	2 DIODE LED THINLINE RED LIGHT
MCL-61ABK	451516	2 DIODE LED AMBER THINLINE KIT W/BASE & PLUG
MCL-61RBK	451517	2 DIODE THINLN RED LED LGHT KIT W/BASE & PLUG
MCL-56AB	451518	1 DIODE LED 2" RND AMBER LIGHT
MCL-56RB	451519	1 DIODE LED 2" RND RED LIGHT
MCL-56ABK	451520	1 DIODE 2" RND AMBER LGHT KIT W/GRMT & PGTL
MCL-56RBK	451521	1 DIODE 2" RND RED LGHT KIT W/GRMT&PGTL
MCL-527AB	451522	2 DIODE LED 2.5" RND AMBER LIGHT
MCL-527RB	451523	2 DIODE LED 2.5" RND RED LIGHT
MCL-527ABK	451524	2 DIODE 2.5" RD AMBER LGHT KIT W/GRMT & PGTL
MCL-527RBK	451525	2 DIODE 2.5" RD RED LGHT KIT W/GRMT & PGTL

LED Backup Lights

The BUL-11CB meets DOT FMVSS 108 requirements in any 360 degree position. These LED back-up lights have 10 diodes and a .260 amp draw at 12.8 volts. They come sonically sealed; waterproof lens and housing in a single unit, with all-weather molded plastic housing and durable lens protection against corrosion. Accepts industry standard 2-prong plug for easy retrofit of incandescent lights and are Certified for back-up light function when installed as pair in 2-lamp system.



BUL-10CB



BUL-11CB



A-45CB

PART NO.	REF. NO.	DESCRIPTION
A-45CB	451124	PIGTAIL, STRAIGHT 2-WIRE FOR BACK-UP LIGHT
BUL-10CB	451137	6" OVL SEALED LED BACKUP LIGHT, 10 DIODE
BUL-11CB	451138	4" RND SEALED LED BACKUP LIGHT, 10 DIODE
BUL-11CBK	451139	4" RND SEALED LED BKUP LGHT KIT W/GRMT & PGTL, 10 DIODE
BUL-10CBK	451140	6" OVL SLD LED BKUP LGHT KIT W/GRMT & PGTL, 10 DIODE



LED Utility Lights



BUL-43CB

These sealed, flush mount, clear LED Utility Lights have 10 super diodes for bright, dependable performance. The BUL-43CB features a sonically sealed, waterproof lens and housing in a single unit. The BUL-72CB features a polycarbonate lens sonically welded to housing for durability. Both have all-weather molded plastic housing and durable lens protection against corrosion. They accept industry standard 2-prong plug for easy retrofit of incandescent lights. (Not certified for back-up light function.)



BUL-72CB

PART NO.	REF. NO.	DESCRIPTION
BUL-43CB	451130	4" RND SEALED CLEAR LED LIGHT 10 DIODE
BUL-43CBK	451131	4" RND LED CLEAR UTILITY LIGHT W/GRMMT & PIGTAIL
BUL-72CB	451795	6" OVAL LED CLEAR UTILITY RECESSED LIGHT
BUL-72CBK	451796	6" OVAL CLR UTILITY LGHT KIT W/GROMMET & PIGTAIL

Stop/Turn/Tail Lights

These 3 to 8 function stop/turn/tail lights make a great addition to any trailer. Available in several configurations; with pigtails and grommets. Three year warranty.

ST-24RB



ST-2RB



ST-74AB



ST-77AB



ST-8RB



ST-44RB



ST-70RB



PART NO.	REF. NO.	DESCRIPTION
A-45GB	451103	GROMMET FOR 4" ROUND, LIGHT
A-70GBD	451106	GROMMET FOR 6" OVAL, LIGHT
A-45PB	451112	PIGTAIL, 3-WIRE, STR, FOR STOP/TURN/TAIL LITE
ST-24RB	451260	TAIL, 3-FUNCTION, STUD MNT 4 3/8" ROUND
ST-2RB	451266	TAIL, 7-FUNCTION, STUD MNT OVER 80"
ST-3RB	451271	TAIL, 8-FUNCTION, STD MNT OVER 80"
ST-8RB	451276	TAIL, 6-FUNCTION, STUD MNT UNDER 80"
ST-9RB	451279	TAIL, 7-FUNCTION, STUD MNT UNDER 80"
ST-44AB	451288	KIT, TAIL 4" RND, SEALED AMBER W/GRMT&PGTL
ST-44RB	451292	KIT, TAIL 4" RND, SEALED RED W/GRMMT&PIGTL
ST-45RB	451299	TAIL, 4" RND, SEALED, RED
ST-70RB	451307	TAIL, 6" OVAL, SEALED, RED
ST-74AB	451320	KIT, TAIL 6" OVAL, SEALED AMBER W/GRMT&PGTL
ST-74RB	451327	KIT, TAIL 6" OVAL, SEALED RED W/GRMMT&PIGTL
ST-77AB	451329	OVAL AMBER SEALED SIDE MARKER/TURN SIGNAL W/GROMMET & PLUG

LIGHTS & ELECTRICAL

Waterproof Stop/Turn/Tail Light

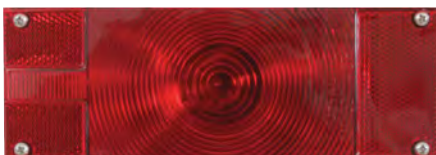

These waterproof taillights are perfect for marine applications. Available in 6 and 7 function, with a 3 year warranty.

PART NO.	REF. NO.	DESCRIPTION
ST-16RB	451281	LIGHT 7-FUNCTION COMBO, TAIL WATERPROOF SS HDWE
ST-17RB	451284	LIGHT 8-FUNCTION COMBO, TAIL WATERPROOF SS HDWE

Clearance/Marker Light

The MC-67AB/RB incandescent clearance/marker lights are complete with a black mounting bracket. Available in amber and red, with a 3-year warranty.



MC-67RB & AB

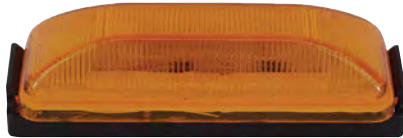

A-91AB & RB



A-67CB



A-91GB

PART NO.	REF. NO.	DESCRIPTION
A-67CB	451102	1 WIRE PLUG & MOLDED ABS CHROME BRACKET
A-91GB	451119	BLK GROMMET FOR A-91AB & A-91RB LIGHTS
A-91AB	451204	SEALED RECTANGULAR MRKR/ CLR LIGHT PC-RATED AMBER
A-91RB	451205	SEALED RECTANGULAR MRKR/ CLR LIGHT PC-RATED RED
MC-67AB	451220	LIGHT KIT 2-BULB CLR/MARKER, BLK BKT, 6" WIRE, AMBER
MC-67RB	451223	LIGHT KIT 2-BULB CLR/MARKER, BLK BKT, 6" WIRE, RED
A-65PB	451737	MOLDED ABS BLACK BRACKET 1 WIRE FIT MC/63/65/67

Fender Mount Clearance/Marker Lights

This fender mount clearance/marker light takes the place of two separate lights. The bi-colored lens functions both as a forward facing amber clearance, and rearward facing red marker. Three year warranty.



MC-67ARB



BA-44FNL & FNR

PART NO.	REF. NO.	DESCRIPTION
MC-67ARB	451230	CLEARANCE LIGHT RED/AMBER, FENDER MOUNT
BA-44FNL	451231	LEFT SIDE PRE-WIRED FEND LIGHT ASSMBLY
BA-44FNR	451232	RIGHT SIDE PRE-WIRED LIGHT ASSMBLY
REPLACEMENT LIGHTS FOR BA-44FNR & BA-44FNL		
MC-44RB	451200	RECT. CLEARANCE/MARKER LIGHT, WHT BASE, 2WIRE RED
MC-44AB	451201	RECT. CLEARANCE/MARKER LIGHT, WHT BASE, 2WIRE AMB



MC-44AB & RB



Round Clearance/Marker Light

These 2" & 2-1/2" marker lights are sealed against the environment. Pigtails and grommets are also available. Three year warranty.

PART NO.	REF. NO.	DESCRIPTION
A-46PB	451109	PIGTAIL, 2-WIRE, FOR, 2" & 2-1/2" CLR/MARKER
A-54GK	451115	GROMMET, PIGTAIL, SCREW, FOR FLUSH MOUNT 2" RND
A-55GK	451118	GROMMET, PIGTAIL, SCREW, FOR RECESS MNT 2-1/2" RND
A-57GK	451121	GROMMET, PIGTAIL, SCREW, FOR FLSH MT 2-1/2" RND
MC-53ABD	451192	LIGHT, CLR/MARKER SEALED, 2" ROUND AMBER
MC-53RBD	451195	LIGHT, CLR/MARKER SEALED, 2" ROUND RED
MC-57AB	451206	LIGHT, CLR/MARKER SEALED, 2-1/2" RND REFLEX AMBER
MC-57RB	451209	LIGHT, CLR/MARKER SEALED, 2-1/2" RND REFLEX RED



MC-57AB



MC-57RB

Oval Clearance/Marker Light

MC-31AB



Available in amber or red, both with reflex. Three year warranty.

PART NO.	REF. NO.	DESCRIPTION
MC-31AB	451180	LIGHT KIT CLR/MARKER OVAL BLK BASE W/REFLEX AMBER
MC-31RB	451183	LIGHT KIT CLR/MARKER OVAL BLK BASE W/REFLEX RED

Stud Mount Clearance/Marker Light

MC-36AB



This side clearance/marker light also acts as a reflector. Mounts on a single 1/4" stud. Available in amber or red. Three year warranty.

PART NO.	REF. NO.	DESCRIPTION
MC-36AB	451186	STUD MNT, SQ BLK BASE REFLEX AMBER
MC-36RB	451189	STUD MNT, SQ BLK BASE REFLEX RED

Backup Light



BU-74CB



BU-44CB

Available in 6" oval or 4 1/4" round, both are recess mount. Both lights come complete with mounting grommet and pigtail. Three year warranty.

PART NO.	REF. NO.	DESCRIPTION
BU-44CB	451125	4 1/4" ROUND, W/GROMMET & PIGTAIL
BU-70CB	451127	CLEAR 6" OVAL BACK-UP SEALED LIGHT
BU-74CB	451128	6" OVAL, W/GROMMET & PIGTAIL

Identification Bar Light

MC-93RB



MC-99RB



While ID bar lights are required on over 80" trailers, they also dress up any trailer. Available in amber and red, with a 3-year warranty.

PART NO.	REF. NO.	DESCRIPTION
MC-93RB	451234	BLACK, POLY BASE RED
MC-99AB	451239	WHITE, METAL BASE, AMBER
MC-99RB	451242	WHITE, METAL BASE, RED

Taillight Kits

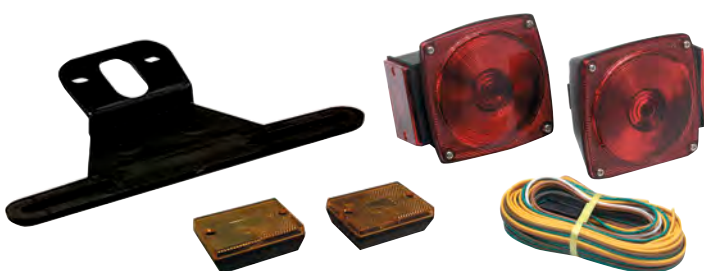

These taillight kits include the popular ST-8RB and ST-9RB lights, 2 MC-36AB marker lights, license plate bracket, and 4-wire harness. Available in 20' or 25' harness lengths. Three year warranty.

PART NO.	REF. NO.	DESCRIPTION
TL-27BK	451400	UNDER 80", 20FT WIRE HARNESS
TL-29BK	451403	UNDER 80", 25FT WIRE HARNESS

License Lights



LP-52CB



LP-51CB

LP-31CB



These are surface mount license plate lights. Also available is the LP-52CB, which comes with the license plate mounting bracket.

PART NO.	REF. NO.	DESCRIPTION
LP-31CB	451156	LIGHT, MINI CHROME LICENSE PLATE W/SCREWS
LP-51CB	451159	LIGHT, LICENSE GRAY HOUSING
LP-52CB	451162	LIGHT, LICENSE GRAY HOUSING W/BLK STEEL BKT

Snap-in License / Utility Light

This chrome plated steel light snaps in a 1 1/4" diameter hole. Ideal for courtesy lights, instrument lights and license lights. Two units required for legal license illumination.

It contains a #193 bulb in a twist-in socket.



PART NO.	REF. NO.	DESCRIPTION
LP-11CB	434700	SNAP-IN LICENSE LIGHT

Utility / Tractor Light

This 5" Utility/Tractor light has a shock proof rubber housing and #4411 sealed beam bulb.

It comes with a 6" lead and ground wires, adjustable plated steel bracket, and 5/16" universal mounting post.



PART NO.	REF. NO.	DESCRIPTION
TL-10CB	451500	TRACTOR OR UTILITY LIGHT, 5", SEALED RUBBER HOUSING BKT

LIGHTS & ELECTRICAL

Weatherproof Light with Switch

This weatherproof utility light is great for both open and enclosed trailers. Comes complete with switch.



PART NO.	REF. NO.	DESCRIPTION
IL-21CB	451135	LIGHT, INT/EXT RECTANGULAR, WEATHERPROOF W/SWITCH

I.D. Bar Light

This unit has a unique design with all three ID light bulbs recessed inside shrouds, to produce an over-all effect of one lens with three individual light sources.



PART NO.	REF. NO.	DESCRIPTION	MNTG. BAR
IDL99-111	428850	RED LIGHT BAR W/SPOTLIGHTS	WHITE POLY

Interior Light with Switch

Single or Double Interior Lights with black rocker switches are designed for surface mounting. Feature high output, clear acrylic optic lens and two wire construction (supply and ground). IL93-113 measures 6 1/2" x 4 7/16" x 1 3/4", IL93-213 measures 11 1/2" x 4 7/16" x 1 3/4".



IL93-113



IL93-213

PART NO.	REF. NO.	DESCRIPTION	TYPE	HOUSING
IL93-113	433300	CLEAR INTERIOR LIGHT	SINGLE	POLAR WHITE
IL93-213	433310	CLEAR INTERIOR LIGHT	DOUBLE	POLAR WHITE

Porch and Utility Light



Compact exterior light with black rocker switch is designed for surface mounting. Features clear snap-in lens and two wire construction (supply and ground). Measures 5 5/16" x 3 1/2" x 2".

PART NO.	REF. NO.	DESCRIPTION	HOUSING
UPL78-517	433065	CLEAR PORCH OR UTILITY LIGHT	COLONIAL WHITE

Combination Clearance/Side Marker Light - Fender Mount



This Clearance/Side Marker Light does the job of two lights. The Lexan lens is held in place by two stainless steel screws which mount the light onto a fender. Measures 3 11/16" X 1 5/16" X 1 1/2" (w/ 1/2" depth). Includes 25" long 2-wire pigtail.

PART NO.	REF. NO.	DESCRIPTION	HOUSING
FL40-0004	427500	AMBER/RED FENDER LIGHT	BLACK PLASTIC

Wesbar Marine Lights

Sealed capsule protects bulbs from corrosion and thermo shock failure. Best-selling, most reliable “waterproof” design available in the industry. Meets all DOT-108 lighting requirements for trailers 80” wide or wider, when properly mounted.



3504

PART NO.	REF. NO.	DESCRIPTION
3504	436830	TAILLIGHT, RED 8-FUNCTN, LEFT HAND SEALED
3554	436835	TAILLIGHT, RED 7-FUNCTN, RIGHT HAND SEALED
3336	436840	REPLACEMENT TAIL LENS RED FOR 3504 & 3554 (1 PAIR/PKG)
3348	436842	REPLACEMENT LIGHT CAPSULE, FITS 3504 & 3554

Auxiliary Towing Light Kit

Safe towing made easier! Consists of two magnetic mounting taillights, a wire harness and a flat 4-way connector. The light kit works great for RV’s towing vehicles, tow trucks hauling cars, for transporting portable compressors or other equipment at night, trailers with electrical problems, or any time taillights are needed in a temporary towing situation.



PART NO.	REF. NO.	DESCRIPTION	WIRING HARNESS
ATL20A	432900	MAGNETIC MNT TOW LIGHT KIT	20 FT LONG

Center Mount Reflector

These hermetically sealed reflectors mount with a single screw through a center hole.



B476A

B477R

PART NO.	REF. NO.	DESCRIPTION	DIAMETER
B476A	437800	AMBER REFLECTOR	3 1/4"
B476R	438000	RED REFLECTOR	3 1/4"
B477A	438200	AMBER REFLECTOR	2 3/8"
B477R	438400	RED REFLECTOR	2 3/8"

Rectangular Reflector

Choose from attractive self-mount reflectors with or without chrome trim or a standard style reflector that mounts with 2 screws.



B487R

PART NO.	REF. NO.	DESCRIPTION	SIZE	MNTG. TYPE
B483A	439210	AMBER REFLECTOR	1 3/8" X 3 1/8"	ADHESIVE BACKING
B483R	439220	RED REFLECTOR	1 3/8" X 3 1/8"	ADHESIVE BACKING
B484A	439400	AMBER, CHROME PLATED BEVEL	7/16" X 1 11/16"	ADHESIVE BACKING
B484R	439600	RED, CHROME PLATED BEVEL	7/16" X 1 11/16"	ADHESIVE BACKING
B487A	439800	AMBER	4 1/4" X 1 5/16"	ADHESIVE BACKING & MTG HOLES
B487R	440000	RED	4 1/4" X 1 5/16"	ADHESIVE BACKING & MTG HOLES

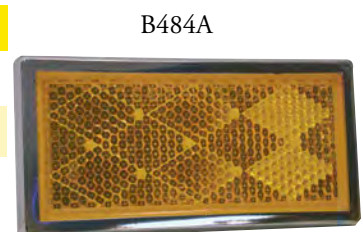

B484A

Quick Mount Reflector



B481R

An adhesive backing permanently mounts these reflectors to any clean, flat surface.

PART NO.	REF. NO.	DESCRIPTION	DIAMETER
B475A	437400	AMBER REFLECTOR	3 1/4"
B475R	437600	RED REFLECTOR	3 1/4"
B481A	439000	AMBER REFLECTOR	2 3/8"
B481R	439200	RED REFLECTOR	2 3/8"

Oblong Quick Mount Reflector

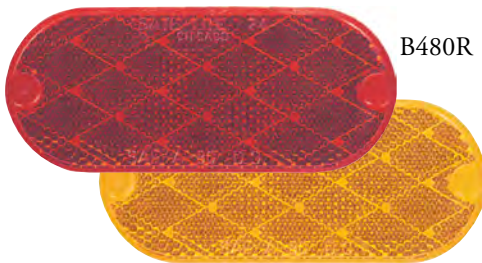

B480R

B480A

An adhesive backing permanently mounts this reflector to any clean, flat surface. The reflector is hermetically sealed acrylic.

PART NO.	REF. NO.	DESCRIPTION	SIZE
B480A	438600	AMBER REFLECTOR	4 3/8" X 1 7/8"
B480R	438800	RED REFLECTOR	4 3/8" X 1 7/8"

Micropismatic Reflectors



Featuring state-of-the-art technology that provides 47,000 micropisms per square inch. These reflectors provide a 50% wider angle of reflectivity, compared to conventional reflectors. Strong adhesive back.

PART NO.	REF. NO.	DESCRIPTION	SIZE
B489A	440200	AMBER RECTANGULAR REFLECTOR	2 3/4" X 1 3/4"
B489R	440400	RED RECTANGULAR REFLECTOR	2 3/4" X 1 3/4"
B490A	440600	AMBER ROUND REFLECTOR	2 7/8" DIA
B490R	440800	RED ROUND REFLECTOR	2 7/8" DIA
B491A	441000	AMBER RECTANGULAR REFLECTOR	4 5/16" X 1 13/16"
B491R	441200	RED RECTANGULAR REFLECTOR	4 5/16" X 1 13/16"

Conspicuity Reflector

Self adhesive 1" conspicuity reflectors comply with NHTSA requirements, when applied to meet the 2" width requirement. An attractive alternative to 2" conspicuity tape.



PART NO.	REF. NO.	DESCRIPTION	COLOR	SIZE
280BC	441310	CONSPICUITY REFLECTOR	WHITE	1" X 12"
280RC	441315	CONSPICUITY REFLECTOR	RED	1" X 12"

LIGHTS & ELECTRICAL



Conspicuity Tape



PART NO.	REF. NO.	DESCRIPTION
29804	441340	3M 983 CONSPIC TAPE 2" WHITE 150' RL
67639	441342	3M CONSPIC TAPE 2" X 12" WHITE KISSCUT 150' RL
29868	441350	3M 983 CONSPIC TAPE 2" X 11"RED/7"WHITE 150' RL
31568	441360	3M 983 CONSPIC TAPE 2" X 6"RED/6"WHITE 150' RL
67641	441362	3M 983 CONPIC TAPE 2" X 6" RED/6"WHITE KSSCT 150'RL
29845	441371	3M 983 CONSPIC TAPE 2" X 11"RED/7"WHITE STRIP
67636	441373	3M 983 CONSPIC TAPE 2" X 11"RED/7"WHT KSSCT150'RL
6398*	441375	3M CONSPIC KIT 2" X 11"RED/7"WHITE & 12" WHITE

* The 6398 Kit will mark one trailer up to 48 ft.

Conspicuity Tape



OEM PREFERRED PREMIUM V82

10 YEAR WARRANTY

- Highest nighttime reflectivity in the industry
- Exceeds minimum requirements by 200%
- Can be riveted through
- No edge sealing required
- Impact resistant
- Single layer construction
- Thin and flexible for easy application
- Withstands high pressure washing and resists edge lift
- OEM preferred
- Reflective Technology: Prismatic
- Roll Size: 2" x 150'
- Certified for: 49CFR 571.108, ASTM D4956 (Type V), CCMTA, FMVSS 108, LS300C, Transport Canada
- Certified for: DOT-C2
- Product Construction: Polyester, 3 mil PSA
- Base Material: Metalized polyester
- Colors: 11"Red/7"White, 6"Red/6"White, White
- Backing: Pressure sensitive adhesive

RETROFIT GRADE DAYBRIGHT V92

5 YEAR WARRANTY

- Daytime white appearance
- Highest nighttime reflectivity in the industry
- Can be riveted through
- No edge sealing required
- Impact resistant
- Single layer construction
- Thin and flexible for easy application
- Withstands high pressure washing and resists edge lift
- OEM preferred
- Reflective Technology: Prismatic
- Roll Size: 2" x 150'
- Certified for: 49CFR 571.108, ASTM D4956 (Type V), CCMTA, FMVSS 108, LS300C, Transport Canada
- Certified for: DOT-C2
- Product Construction: Polyester, 3 mil PSA
- Base Material: Metalized polyester
- Colors: 11"Red/7"White, 6"Red/6"White. White
- Backing: Pressure sensitive adhesive

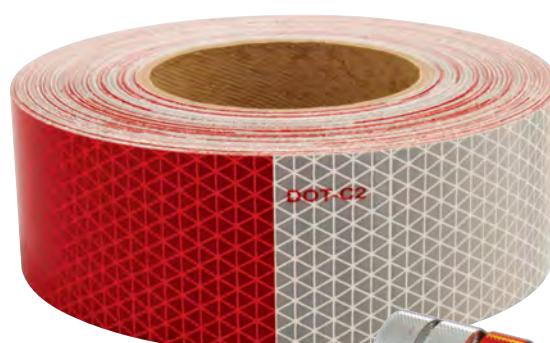

PART NO.	REF. NO.	DESCRIPTION
V825449	441351	V82 SOLID WHT 10YR CONSPC TAPE 2"X150' RL
V825449KC	441353	V82 SOLID WHT 10YR CONSP TAPE 2"X150' RL KISSCT
V825549	441354	V82 11"RED X 7" WHITE CONSPC TAPE 2"X150'RL
V825649	441355	V82 6"RD6"X6"WHT 10Y CONSPC TAPE 2"X150' RL
V825649KC	441356	V82 6"RD6"X6"WHT 10Y CONSPC TAPE 2"X150' RL KISSCT
V825549-18	441357	V82 2"X18"STRIP 11"RD7" WHT CONSPC TAPE
V825549KC	441358	V82 11"REDX7"WHT CONSPC TAPE 2"X150' KISSCT 10YR
5449	441363	REFLEXITE WHITE CONSPIC TAPE 150FT ROLL
5649	441376	V92 CONSPC TP 2"X6"RED/6"WHT 150' RL
5449KC	441377	V92 CONSPC TP 2"X12"X150' RL WHT KISSCT
5649KC	441378	V92 CONSPC TP 2"X6"RED/6" WHT 150'KISSCT
5549KC	441379	V92 CONSPC TP 2"X7"WHT/11"RED 150'KISSCT

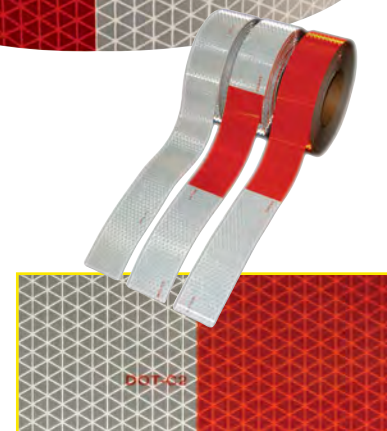

LIGHTS & ELECTRICAL

Packaged Lights

Clearance/Marker Lights



PART NO.	REF. NO.	DESCRIPTION
LT01-100	451187	CLR/MKR, AMBER SEALED
LT01-105	451188	CLR/MKR, RED SEALED
LT01-020	451193	CLR/MKR, SEALED 2" ROUND AMBER
LT01-025	451194	CLR/MKR, SEALED 2" ROUND RED
LT01-030	451207	CLR/MKR, SEALED 2.5" AMBER ROUND W/RFLCT LENS
LT01-035	451208	CLR/MKR, SEALED 2.5" RED ROUND W/RFLCT LENS
LT01-050	451210	CLR/MKR, AMBER W/ RFLCT STUD MNT SQ BLK BASE
LT01-060	451211	CLR/MKR, RECTANGULAR W/RFLCT STUD MNT SQ BLK
LT01-115	451212	CLR/MKR, AMBER SEALED 2-BULB
LT01-120	451213	CLR/MKR, RED SEALED 2-BULB
LT01-200	451214	CLR/MKR, AMBER DUAL BULB BLACK BASE
LT01-210	451215	CLR/MKR, RED DUAL BULB BLACK BASE
LT01-220	451216	CLR/MKR, OVAL W/RFL WHT BASE ONE-BULB AMBER
LT01-230	451217	CLR/MKR, OVAL W/RFL WHT BASE ONE-BULB RED

ID Bar Light



PART NO.	REF. NO.	DESCRIPTION
LT01-300	451240	ID BAR 3-PIECE WHT BAR 50" WIRE RED

LED Clearance/Marker Lights



PART NO.	REF. NO.	DESCRIPTION
LT02-020	451701	LED CLR/MARKER, AMBER, ROUND 2" SEALED
LT02-025	451702	LED CLR/MARKER, RED, ROUND 2" SEALED
LT02-030	451721	LED CLR/MARKER, AMBER, ROUND 2.5" SEALED
LT02-035	451722	LED CLR/MARKER, RED, ROUND 2.5" SEALED
LT02-100	451732	LED CLR/MARKER, AMBER, THIN LINE SEALED
LT02-105	451733	LED CLR/MARKER, RED, THIN LINE SEALED

LIGHTS & ELECTRICAL

Stop/Turn/Tail Lights



PART NO.	REF. NO.	DESCRIPTION
LT03-100	451277	TAIL LIGHT UNV STUD-MNT 6-FUNCTION W/O ILLMIN QUICK CONNECT
LT03-105	451278	TAIL LIGHT UNV STUD-MNT 7-FUNCTION W/ILLMIN QUICK CONNECT
LT03-125	451263	STOP/TURN/TAIL FLUSH MNT 4.5 BLK STEEL
LT03-135	451264	STOP/TURN/TAIL 6" OVAL SEALED 3-FUNCTION
LT03-190	451265	STOP/TURN/TAIL RED 4.25 SEALED PC HOUSING

Packaged Lights

LED Stop/Turn/Tail Lights

PART NO.	REF. NO.	DESCRIPTION
LT04-125	451831	LED STOP/TURN/TAIL, 4" ROUND SEALED RED 10 SUP
LT04-135	451832	LED STOP/TURN/TAIL, 6" OVAL SEALED RECESSED MNT RED 10 DIODE
LT04-100	451856	LED TAIL LIGHT UNV UNDER 80" STUD MNT 6-FUNCTION
LT04-105	451857	LED TAIL LIGHT UNV UNDER 80" STUD MNT 7-FUNCTION



Utility Lights

PART NO.	REF. NO.	DESCRIPTION
LT05-100	451136	UTILITY LIGHT RECT WEATHER PROOF INT/EXT LT W/SWITCH
LT05-125	451501	UTILITY/TRACTOR LIGHT 5" RUBBER HOUSING PLATED BK
LT05-200	451151	LIC PLATE BKT, ANGLED RUST-PROOF BLK POLYMER
LT05-300	451152	UTILITY LIGHT SNAP-IN DASH LT LIC PLATE, UTILITY CHROME



Pigtails & Grommets

PART NO.	REF. NO.	DESCRIPTION
LT06-300	451104	GROMMET, RING, RUBBER FITS LT03-190
LT06-305	451105	GROMMET, RING, FLUSH-MNT RUBBER, FITS 2" RND MRKR
LT06-310	451107	GROMMET, RING, 2 1/2" OPEN BACK FLUSH-MNT, RUBBER
LT06-315	451108	GROMMET, RING, RUBBER FITS LT03-135
LT06-100	451110	PIGTAIL, 2-WIRE STD LT01 & LT03-020/025/030/035 6"L
LT06-200	451111	PLUG & BASE ABS BKT 1-WIRE LT01-120/125 02-100/105
LT06-110	451113	PIGTAIL, 2-WIRE STRAIGHT FOR BU-45170CB
LT06-105	451114	PIGTAIL, 3-WIRE STRAIGHT FOR LT03-190 & LT03-135



Reflectors

PART NO.	REF. NO.	DESCRIPTION
LT07-100	451250	RECTANGULAR, SELF-ADHESIVE, AMBER (2 PER PKG)
LT07-105	451251	RECTANGULAR, SELF-ADHESIVE RED (2 PER PKG)
LT07-120	451252	OBLONG, ADHESIVE MOUNT & SCREWS, AMBER (2 PER PKG)
LT07-125	451253	OBLONG, ADHESIVE MOUNT & SCREWS, RED (2 PER PKG)



LIGHTS &
ELECTRICAL

Light Kits

PART NO.	REF. NO.	DESCRIPTION
LT-KIT	451410	INCAND/SUBM TLR LT KIT TAIL, SIDEMKR, HRN, LP BKT
LT-LEDKIT	451890	LED TRAILER LIGHT KIT TAIL, SIDEMKR, HRN, LP BKT



RV Motion Sensor Light

The world's only 12 volt motion light!



SL-1000

The motion sensor won't be triggered by small animals or blowing debris. It has dual PIR sensors to sense movement and a micro-chip to differentiate between large and small thermal masses.

Made from tough, polycarbonate plastics, it has a battery monitoring system for external monitoring. It can be adjusted from 5 feet to 25 feet, alerting you from the outside of your coach if your batteries are low. It comes standard with a 200LMS LED bulb with a day/night auto shut-off and energy efficient technology (draws less than 250 MA when illuminated), helping you to get safely back to your rig at night. Put through 6 years of factory and field tests, the SL-1000 can survive a Category 2 hurricane.

LED Bulbs

Keep your lights on 90% longer while camping - no more melted lenses!

Very bright light illuminates camping area like never before. Lasts for 60K hours, runs cool and draws 90% less power than incandescent bulbs. They are also water resistant and rotate at the base. Now you can direct the light to where you need it, with the **brightest 12 volt single contact LED bulb on the market!**



REV150

REV200

REV300

Never change a bulb again!

Factory and field tests show the longevity, temperature, amp draw and illumination time.



REVLR

The REVLR increases the load to LED bulbs allowing the light to blink at standard rate.

(The LED taillights that blink rapidly will work normally after installation.)



REV1156

REV1157

REV194

Last for 60K hours, run cool, and draw 90% less power than incandescent bulbs. Increase your safety; LED's light immediately when the brake is depressed, alerting others that you are stopping sooner.

PART NO.	REF. NO.	DESCRIPTION
SL-1000	433070	12 VOLT MOTION SENSOR LED LIGHT, WHITE
REV1156	450300	1156 LED REPLACEMENT BULB, 2 PACK
REV150	450301	150 LUMEN LED BULB, WHITE BASE
REV200	450302	200 LUMEN LED BULB, WHITE BASE
REV300	450303	300 LUMEN LED BULB, WHITE BASE
REV1157	450305	1157 LED REPLACEMENT BULB, 2 PACK
REVLR	450306	REVOLUTION LOAD RESISTOR
REV194	450307	194 LED REPLACEMENT BULB 2 PACK

Bulbs

These long life 12-volt Bulbs are replacement bulbs for our Clearance, Combination, License and Utility/Interior Lights. Ten per box.

PART NO.	REF. NO.	DESCRIPTION
67	449800	SINGLE FILAMENT BULB USED IN MOST LICENSE PLATE LIGHTS
193	449900	SINGLE FILAMENT PUSH-IN TYPE BULB, HEAVY DUTY VERSION OF 194
194	450000	SINGLE FILAMENT PUSH-IN TYPE BULB USED IN MANY CLEARANCE LIGHTS
1141	450200	SINGLE FILAMENT BULB USED FOR MANY UTILITY & INTERIOR LIGHTS
1157	450400	DOUBLE FILAMENT BULB USED IN STOP, TURN & COMBINATION LIGHTS
1895	450600	SINGLE FILAMENT BULB USED IN MOST CLEARANCE LIGHTS



Taillight Guards

Metal light guards provide added protection for various kinds of lights. Mounts with two screws (not included).

PART NO.	REF. NO.	DESCRIPTION
LG428NP	442451	UNPAINTED STEEL FOR 428 TAIL LIGHT
LG440NP	442459	UNPAINTED STEEL FOR 440 TAIL LIGHT
CMC-007	442470	METAL LIGHT BOX, 6" OVL 2" CLRNC/SIDE MRKR LIGHT



LG440NP



CMC-007

Lighting Accessories

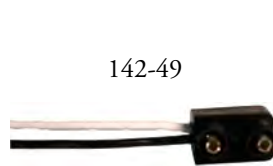

142-49



BK-45BB

510-9



428-09



PART NO.	REF. NO.	DESCRIPTION	MATERIAL	APPLICATION
142-49	426600	REPLACEMENT PLUG	2-WIRE	142, 143, 146 & 439K SERIES
431-491	436400	REPLACEMENT PLUG	3-WIRE	426 & 427 SERIES
428-09	441400	LICENSE BRACKET	ZINC PLATED STEEL	ALL PETERSON TAILLIGHTS
440-09	441600	LICENSE BRACKET	BLACK PLASTIC	ALL PETERSON TAILLIGHTS
BLP1	441650	LICENSE PLATE BEZEL W/O LIGHT, BLACK		
BLPL1	441675	LICENSE PLATE BEZEL W/ LIGHT, BLACK		
510-9	441800	TAILLIGHT BRACKET	BLACK STEEL	ALL PETERSON TAILLIGHTS
BK-45BB	442210	TAILLIGHT BRACKET	BLACK STEEL	ALL 4" ROUND LIGHTS
BK-70BB	442250	TAILLIGHT BRACKET	BLACK STEEL	ALL 6" OVAL LIGHTS
TLB-1	442300	TAILLIGHT BRACKET	12GA STEEL	2-STUD MNT TAILLIGHTS
106-09	442400	METAL GUARD FOR CLEARANCE LIGHTS, CHROME		
CMC-012	442410	BRACKET FOR CLEARANCE LIGHT, METAL		2" ROUND LIGHT
410-21	447800	REPLACEMENT RETAINING SNAP-RING		425 & 413 SERIES
413-07	451000	REPLACEMENT PIGTAIL	2-10" WIRES	410-2, 428 & 413 SERIES
A-49PB	451120	RIGHT ANGLE PIGTAIL	2-PRONG	
LP-10SB	451150	LICENSE BRACKET	BLACK POLYMER	
LP15SB	451153	LICENSE BRACKET	STEEL ZINC PLATED	



TLB-1



BLPL1



BLP1: w/o light



431-491



106-09

Primary Wire

Standard copper Primary Wire is widely used in the trailer and automotive industries for original equipment and replacement wiring. The General Purpose Thermo-Plastic (GPT) Insulation is highly resistant to acids, gasoline, oil, grease and most industrial solvents. Meets SAE J1128 Specifications. For use with 60 volts or less; under 176°F (80°C).

10 GAUGE		
COLOR	100 FT ROLL	
	PART NO.	REF. NO.
BLUE	10-1-100BE	456400
BLACK	10-1-100BK	456600
RED	10-1-100RD	456800



14 GAUGE				
COLOR	100 FT ROLL		500 FT ROLL	
	PART NO.	REF. NO.	PART NO.	REF. NO.
BLUE	14-1-100BE	454200	14-1-500BE	458400
BLACK	14-1-100BK	454400	14-1-500BK	458600
BROWN	14-1-100BN	454600	14-1-500BN	458800
GREEN	14-1-100GN	454800	14-1-500GN	459000
RED	14-1-100RD	455000	14-1-500RD	459200
WHITE	14-1-100WE	455200	14-1-500WE	459400
YELLOW	14-1-100YW	455400	14-1-500YW	459600

12 GAUGE				
COLOR	100 FT ROLL		500 FT ROLL	
	PART NO.	REF. NO.	PART NO.	REF. NO.
BLUE	12-1-100BE	455600	12-1-500BE	459800
BLACK	12-1-100BK	455800	12-1-500BK	460000
RED	12-1-100RD	456000	12-1-500RD	460200
WHITE	12-1-100WE	456200	12-1-500WE	460400

16 GAUGE				
COLOR	100 FT ROLL		500 FT ROLL	
	PART NO.	REF. NO.	PART NO.	REF. NO.
BLUE	16-1-100BE	452800	16-1-500BE	457000
BLACK	16-1-100BK	453000	16-1-500BK	457200
BROWN	16-1-100BN	453200	16-1-500BN	457400
GREEN	16-1-100GN	453400	16-1-500GN	457600
RED	16-1-100RD	453600	16-1-500RD	457800
WHITE	16-1-100WE	453800	16-1-500WE	458000
YELLOW	16-1-100YW	454000	16-1-500YW	458200

Bonded Parallel Primary Wire

Parallel Primary Wire has two, three or four parallel conductors bonded together by Thermo-Plastic insulation, in flat ribbon configuration. Each conductor is independently color coded for easy identification. Meets SAE J1128 Specifications, for use with 60 volts or less; under 176° F (80°C).

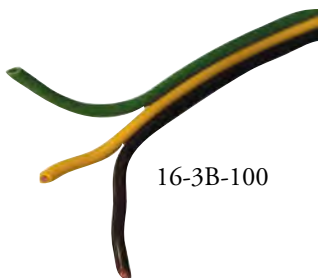

16-3B-100

PART NO.	REF. NO.	GAUGE	CONDUCTOR	ROLL LENGTH	COLORS
18-3B-100	460550	18	3	100 FT	YELLOW, BROWN, GREEN
18-3B-500	460600	18	3	500 FT	YELLOW, BROWN, GREEN
18-3B-2500	460650	18	3	2,500 FT	YELLOW, BROWN, GREEN
16-2B-100	460750	16	2	100 FT	RED, BLACK
16-2B-500	460800	16	2	500 FT	RED, BLACK
16-3B-100	460950	16	3	100 FT	YELLOW, BROWN, GREEN
16-3B-500	461000	16	3	500 FT	YELLOW, BROWN, GREEN
16-3B-2500	461100	16	3	2,500 FT	YELLOW, BROWN, GREEN
16-4B-100	461150	16	4	100 FT	YELLOW, BROWN, GREEN, WHITE
16-4B-500	461200	16	4	500 FT	YELLOW, BROWN, GREEN, WHITE
16-4B-1000	461210	16	4	1,000 FT	YELLOW, BROWN, GREEN, WHITE

LIGHTS & ELECTRICAL

Jacketed Duplex Brake Wire

Duplex Brake Wire is made with two plastic insulated primary wires laid parallel and covered with a high quality plastic jacket, protecting the insulated conductors. Each conductor is color coded for easy identification. Meets SAE J1128 Specifications, for use with 60 volts or less; under 221° F (105°C).



14-2-100

PART NO.	REF. NO.	GAUGE	CONDUCTOR	ROLL LENGTH	COLORS
14-2-100	461350	14	2	100 FT	BLACK & WHITE
14-2-500	461400	14	2	500 FT	BLACK & WHITE
12-2-500	461600	12	2	500 FT	BLACK & WHITE

Insulated Trailer Lighting Cable

Trailer Cable is manufactured to SAE and ATA specifications. This multiconductor stranded copper wire maintains flexibility, even though each conductor is insulated with a heavy vinyl covering. To provide an additional safety factor, the entire cable is enclosed in a black vinyl jacket; to reduce road hazards from moisture, solvents, grease, oil, gasoline, abrasion, chemicals and weather. Conductors meet SAE J1128 Specifications, for use with 60 volts or less; under 176° F (80°C).

PART NO.	REF. NO.	GAUGE	CONDUCTOR	ROLL LENGTH	COLORS
164C500	461800	16	4	500 FT	BROWN, GREEN, RED, YELLOW
166C500	462000	16	6	500 FT	BLUE, BLACK, BROWN, GREEN, RED, YELLOW
144C500	462200	14	4	500 FT	BROWN, GREEN, RED, YELLOW
146C500	462400	14	6	500 FT	BLUE, BLACK, BROWN, GREEN, RED, YELLOW
127C500	462425	(6) 12GA (1) 10GA	7	500 FT	BLUE, BLACK, BROWN, GREEN, RED, YELLOW, WHITE

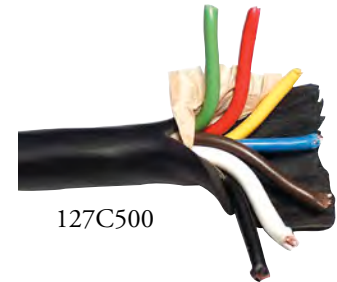

Terminal Kit

Terminal Kit contains 14 different types of terminals (650 total) and one pair of terminal pliers for crimping terminals and cutting or stripping wire. Comes enclosed in a rust and acid resistant compartmentalized steel box. Consult the chart below for specifications of the terminals included.

DESCRIPTION	GAUGE	STUD SIZE	COLOR	QTY. IN KIT
RING TERMINAL	22-18	8	RED	50
RING TERMINAL	22-18	5-6	RED	50
RING TERMINAL	16-14	10	BLUE	50
RING TERMINAL	16-14	8	BLUE	50
RING TERMINAL	16-14	5-6	BLUE	50
RING TERMINAL	12-10	10	YELLOW	25
SPADE TERMINAL	22-18	8	RED	50
SPADE TERMINAL	22-18	6	RED	50
SPADE TERMINAL	16-14	10	BLUE	50
SPADE TERMINAL	16-14	8	BLUE	50
FEMALE DISCONNECT	16-14	.250"	BLUE	50
BUTT SPLICE	22-18	N/A	RED	50
BUTT SPLICE	16-14	N/A	BLUE	50
BUTT SPLICE	12-10	N/A	YELLOW	25
WIRE CABLE TIE	5 3/4" LONG		WHITE	100
WIRE CABLE TIE	7 1/2" LONG		WHITE	100
WIRE MARKER TAPE DISPENSER				1
TERMINAL PLIERS				1



PART NO.	REF. NO.	DESCRIPTION
TK430	470600	TERMINAL KIT

LIGHTS & ELECTRICAL

Quick Disconnects

The "male" and "female" Quick Disconnects enable a fast connection or disconnection of wires. They simply crimp onto wires and plug into each other. The vinyl insulation is color coded.

PART NO.	REF. NO.	TYPE	GAUGE	COLOR	PKG QTY	STUD SIZE
44-9200A	469400	FEMALE	16-14	BLUE	100	.250"
44-9210A	469600	MALE	16-14	BLUE	100	.250"

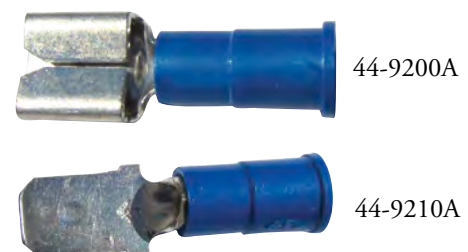

Ring Terminals

Ring Terminals are used for all types of electrical work where wires need fastening. The vinyl insulation sleeves are color coded.



PART NO.	REF. NO.	GAUGE	STUD SIZE	COLOR	PKG. QTY.
44-5210A	467600	16-14	#10	BLUE	100
44-5220A	467800	16-14	1/4"	BLUE	100
44-5230A	468000	16-14	3/8"	BLUE	100
44-5310A	468200	12-10	#10	YELLOW	100
44-5338A	468400	12-10	3/8"	YELLOW	100
44-5356A	468600	12-10	5/16"	YELLOW	100

Spade Terminals

Spade Terminals are used for fastening wire in all kinds of electrical work. The vinyl insulation sleeves are color coded.



PART NO.	REF. NO.	GAUGE	STUD SIZE	COLOR	PKG. QTY.
44-6210A	469000	16-14	10	BLUE	100

Butt Connectors

Butt Connectors are used to connect two wires together in-line. The plastic insulation eliminates taping and makes a neat, permanent job. Crimp with standard crimping and stripping pliers. The insulation is color coded.



PART NO.	REF. NO.	GAUGE	PKG. COLOR	PKG. QTY.
44-2100A	466600	22-18	RED	100
44-2200A	466800	16-14	BLUE	100
44-2300A	467000	12-10	YELLOW	100

Heat Shrink Connectors

These Heat Shrink Butt Connectors perform the same basic function as the regular butt connectors, but also give added protection. By heating the plastic housing, the connector creates a seal from the environment, and helps hold the wires in place. Optimal heating temperature is 230 degrees Fahrenheit, operating temperature is -40° to +230° Fahrenheit. Available in three popular sizes.



PART NO.	REF. NO.	DESCRIPTION
12340C	467050	HEAT SHRINK CONNECTOR, 10-12 GAUGE BUTT CNCTR
16340C	467100	HEAT SHRINK CONNECTOR, 14-16 GAUGE BUTT CNCTR
18340C	467150	HEAT SHRINK CONNECTOR, 18-20 GAUGE BUTT CNCTR

Bullet Connectors

Wire is pushed into the insulated Female Bullet and crimped on with a pair of pliers. Male Bullet terminal crimps on to a second wire end. An electrical line is quickly connected or disconnected by snapping the two together or apart.



PART NO.	REF. NO.	DESCRIPTION	GAUGE	STUD SIZE	COLOR	PKG. QTY.
44-4220A	467200	MALE BULLET	16-14	.157	BLUE	100
44-4221A	467400	FEMALE BULLET	16-14	.157	BLUE	100

Wire Nut



Wire Nuts connect wires by inserting all the ends and twisting. They come in standard yellow color and accept a minimum of two 18-gauge wires and a maximum of two 10 gauge wires.

PART NO.	REF. NO.	DESCRIPTION	GAUGE	COLOR	PKG. QTY.
212	466400	WIRE NUT	MIN (2) 18 - MAX (2) 10	YELLOW	100

Quick Splices

Quick Splices strip, connect and insulate with just one squeeze of ordinary pliers. They make wire cutting, stripping, taping, soldering and splicing a thing of the past. Just insert the wire into the case and press the metal grip down with pliers, then close the case cover. Made of high impact plastic, Quick Splices are resistant to grease, moisture, oil and heat.

PART NO.	REF. NO.	DESCRIPTION	GAUGE	COLOR	PKG. QTY.
560	465800	QUICK SPLICE W/STOP	18-14	BLUE	100
564	466000	QUICK SPLICE W/O STOP	18-14	BEIGE	100
804C	466050	QUICK SPLICE W/STOP, W/CORROSION RESIST GEL	18-14	BLUE	500
314	466100	QUICK SPLICE 3-WAY, WEATHER RESIST GREASE FILLED	22-14	CLEAR	1,000
562	466200	QUICK SPLICE W/STOP	12-10	YELLOW	100



Cable Ties

Cable Ties are a quick and easy way to mount or bundle wires together, and are made of heavy-duty weather-resistant nylon.

PART NO.	REF. NO.	DESCRIPTION	A	B	C	PKG QTY
1182	465000	CABLE TIE	7"	5 1/2"	3/16"	100
1189	465400	CABLE TIE	14"	12 1/2"	3/16"	100

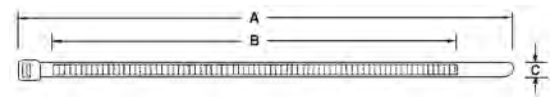

Wire Grommets

PART NO.	REF. NO.	DESCRIPTION	I.D.	MNTG. HOLE
5000	462860	GROMMET	1/8"	3/16"
5008	462865	GROMMET	3/8"	1/2"
5018	462870	GROMMET	3/4"	1"

Nylon Grommets can be used where wiring passes through frame members or side panels, protecting the wire jacket from rough edges and eliminating "shorts". Simply push the grommet into the correct hole size and it will lock itself into place.



Convolutd Wire Loom

Convolutd Loom holds wires in position and provides protection against corrosion and crushing. It is slit for easy insertion, yet the slit stays closed when the wire is bent or twisted. Made of flexible black polyethylene.

PART NO.	REF. NO.	DESCRIPTION	I.D.	PKG. QTY.
PCT0375	462825	CONVOLUTED LOOM	3/8"	1200 FT
PCT0500	462850	CONVOLUTED LOOM	1/2"	900 FT



Woven Cotton Wire Loom

Cotton Loom is a nonmetallic, flexible conduit used to cover wires, cables, air and hydraulic brake tubing, fuel lines and control rods. Loom is fire retardant, moisture proof and will not kink. Made of woven cotton and covered with black bituminous coating.

PART NO.	REF. NO.	DESCRIPTION	I.D.	PKG. QTY.
WCL0250	462600	COTTON LOOM	1/4"	100 FT
WCL0500	462800	COTTON LOOM	1/2"	100 FT



Nylon Wire Loom Clamp

This durable, weather resistant Nylon Clamp is used to mount wire looms to a frame or panel surface.

PART NO.	REF. NO.	DESCRIPTION	I.D.	PKG. QTY.
NO250	463000	NYLON LOOM CLAMP	1/4"	100
NO375	463200	NYLON LOOM CLAMP	3/8"	100



Metal Wire Loom Clamp



Heavy-duty Wire Loom Clamp is made of plated steel with a rubber sleeve that protects the loom and cable, and holds it securely to a frame or panel surface.

PART NO.	REF. NO.	DESCRIPTION	I.D.	PKG. QTY.
A0250	463400	METAL LOOM CLAMP	1/4"	100
A0375	463600	METAL LOOM CLAMP	3/8"	100
A0500	463800	METAL LOOM CLAMP	1/2"	100
A0750	464000	METAL LOOM CLAMP	3/4"	100
A1000	464200	METAL LOOM CLAMP	1"	100
A1500	464400	METAL LOOM CLAMP	1 1/2"	100

Spring Steel Wire Clips



592

Wire Frame Clips are made of spring steel with black enamel finish. These Clips are used to secure one or more wires to the frame or panel surface.

PART NO.	REF. NO.	DESCRIPTION	I.D.	PKG. QTY.
592	464600	WIRE CLIP	3/8"	100
594	464800	WIRE CLIP	1/4"	100

Electrical Tape



This Electrical Tape is flame-retardant and weather resistant. It is UL approved 7 mil. thick, 3/4" wide and is sold in 60' long rolls. Manufactured by 3M.

PART NO.	REF. NO.	DESCRIPTION	SIZE
133	465600	ELECTRICAL TAPE	3/4" X 60 FT ROLL

Heavy Duty Terminal Pliers

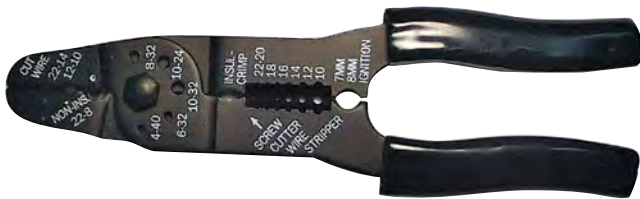

This general purpose tool is used for cutting, crimping and stripping wire. Strips wire 10 - 22 gauge, crimps terminals 10 - 22 gauge.

PART NO.	REF. NO.	DESCRIPTION
TP425	492200	HEAVY DUTY TERMINAL PLIERS

Circuit Testers

Used to locate shorts, broken wires and other problems. To use, attach the clip to the ground and probe with the tester point, or with part number QCT12, hook the wire and finger activate the tester prong. The handle glows when a live wire is found. The Tekonsha Trailer Tester with charger and replaceable battery, tests all trailer circuits for both LED and incandescent lighted trailers.

LIGHTS & ELECTRICAL



ECT8901



8010



QCT12

PART NO.	REF. NO.	DESCRIPTION
QCT12	491800	"QUICKEE" 6 & 12 VOLT TESTER
ECT8901	491805	6 & 12 VOLT TESTER
8010	491810	TEKONSHA TRAILER TESTER, CHECKS TRAILER CIRCUITRY

Fuse Holders

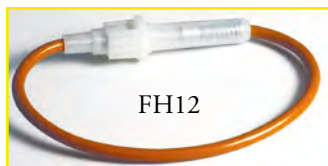

FH12



FH-MINI



FH20ATC

Fuse holders provide circuit protection of wiring, instruments, light switches, etc. Available for mini, maxi, ATO/ATC, and glass tube fuses.

PART NO.	REF. NO.	DESCRIPTION
FH12	472800	TUBE TYPE, W/8" LOOP OF 14 GAUGE WIRE & 20 AMP FUSE
FH20ATC	473000	BLADE TYPE, W/8" LOOP OF 12 GAUGE WIRE & 20 AMP FUSE
FH-MINI	473100	FUSE HOLDER - MINI FUSE 16 GAUGE UP TO 20 AMP
FH-MAXI	473150	FUSE HOLDER - MAXI FUSE 8 GAUGE UP TO 60 AMP



FH-MAXI

Fuses

"Mini" & "Maxi" blade-type fuses are used in most late model cars and trucks. Consult your manufacturer's guide to see which is recommended for your vehicle. SFE & ATO/ATC fuses available for older & specialty applications.



MAX30 MAX40 MAX50 MAX60

PART NO.	REF. NO.	DESCRIPTION
ATO-ATC20	471600	PLUG-IN BLADE FUSE, 20AMP RATING
ATO-ATC25	471800	PLUG-IN BLADE FUSE, 25AMP RATING
ATO-ATC30	472000	PLUG-IN BLADE FUSE, 30AMP RATING
MIN05	472200	MINI FUSE 5AMP
MIN10	472210	MINI FUSE 10AMP
MIN15	472220	MINI FUSE 15AMP
MIN20	472230	MINI FUSE 20AMP
MIN25	472240	MINI FUSE 25 AMP
MIN30	472250	MINI FUSE 30AMP
MAX20	472300	"MAXI" FUSE 20AMP
MAX30	472310	"MAXI" FUSE 30AMP
MAX40	472320	"MAXI" FUSE 40AMP
MAX50	472330	"MAXI" FUSE 50AMP
MAX60	472340	"MAXI" FUSE 60AMP



ATO-ATC20 ATO-ATC25 ATO-ATC30



MIN05 MIN10 MIN15
MIN20 MIN25 MIN30

Circuit Breakers

Circuit Breakers convert automotive fuse systems to an automatic reset circuit without rewiring the fuse panel. They are recommended for automotive, RV, air conditioners, battery chargers, brake controllers and other applications requiring over-current protection.

Circuit Breakers have a non-corrosive molded cover, nuts, washers and mounting bracket.

PART NO.	REF. NO.	DESCRIPTION	AMP RATING
RA2-15	470800	CIRCUIT BREAKER	15
RA2-20	471000	CIRCUIT BREAKER	20
RA2-30	471200	CIRCUIT BREAKER	30
RA2-40	471400	CIRCUIT BREAKER	40



RA2-15

Turn Signal Flashers / Heavy Duty Flasher



TF536/552



PM5000

Replacement Turn Signal Flashers for 12 volt, 2 terminal flashers. Replace the original flasher to eliminate the rapid flashing of turn signals due to increased amperage draw from trailer lights. The 51206 lasts up to 10 times longer than the thermal flasher.

PART NO.	REF. NO.	DESCRIPTION	TERMINALS	VOLTS
TF536/552	473850	THERMAL FLASHER, 1-6 LAMP	2	12
PM5000	473870	HEAVY-DUTY SOLID STATE FLASHER		
51206	473900	ELECTRICAL-MECHANICAL FLASHER	2	12

Toggle Switches



34-576



5543

Heavy-duty Toggle Switches are ideal for automotive, truck, farm tractor, off the road and RV applications. Switches feature a chrome knurled face nut and bat handle.

PART NO.	REF. NO.	CIRCUITRY	TERMINAL	TYPE	VOLTS	AMPS	STEM DIA.
34-576	483400	ON-ON	6	SCREW	12	20	15/32"
34-212	483600	ON-OFF	2	SCREW	12	50	15/32"
5543	483800	ON-OFF	2	SCREW	12	10	*

* Part #5543 mounts flush in a 2" hole.

Push-Pull Switches



This universal all brass heavy-duty Push-Pull Switch has a number of applications, including lights, heaters, wipers, etc., for automotive, truck, marine and farm vehicles. Switches feature a polished chrome face nut and knob, with a brass back nut and washer.

PART NO.	REF. NO.	CIRCUITRY	TERMINAL	TYPE	VOLTS	AMPS	STEM DIA.	STEM LENGTH
33-402	484200	ON-OFF	2	SCREW	6V	25A	3/8"	1 1/4"

4 Pole Chrome Trailer Connector



11-409



11-410

This popular 4-way chrome plated zinc die cast connector features a spring-loaded cover, high-impact insulators and split brass contacts. 12-24 volts, 20 amps.

PART NO.	REF. NO.	DESCRIPTION
11-409	475600	TRAILER END CONNECTOR, 4 POLE
11-410	475800	VEHICLE END CONNECTOR, 4 POLE

4 Pole Zinc Die Cast Trailer Connector

This 4-way Die Cast Trailer Connector is used on agricultural and utility trailers without electric brakes. It features concealed terminals, stainless steel cover spring and finger grips for positive pull. This unit is dust and water resistant, and is interchangeable with other brands of connectors.



S402



S403

PART NO.	REF. NO.	DESCRIPTION
S402	476000	VEHICLE END CONNECTOR, 4 POLE
S403	476200	TRAILER END CONNECTOR, 4 POLE
S613	478410	REPL ZINC SCREW FOR S403
S614	478415	REPL ZINC SCREW FOR S402
S615	478420	REPL BRASS TERMINAL SCREW FOR S402 & S403

5 Pole Chrome Trailer Connector

This popular 5-way chrome plated zinc die cast connector is used on small trailers where an extra circuit is needed. It features a spring-loaded cover, high-impact insulators and split brass contacts. 12-24 volts, 15 amps.

PART NO.	REF. NO.	DESCRIPTION
11-501	476400	TRAILER END CONNECTOR, 5 POLE
11-502	476600	VEHICLE END CONNECTOR, 5 POLE



11-501



11-502

6 Pole Die Cast Trailer Connectors

6-way Aluminum Die Cast Trailer Connectors are ideal for horse, farm and utility trailers. They feature a concealed terminal socket design, a stainless steel cover spring and a unique cable clamp, that gives more support and helps save installation time. They are dust and water resistant, and interchangeable with other brands of connectors.



PART NO.	REF. NO.	DESCRIPTION
S602	476800	VEHICLE END CONNECTOR, HEAVY DUTY, 6 POLE
S603	477000	TRAILER END CONNECTOR, HEAVY DUTY, 6 POLE
609	477400	VEHICLE END CONNECTOR, 6 POLE
604	477600	TRAILER END CONNECTOR, 6 POLE
S613	478410	REPLACEMENT ZINC SCREW FOR S603
S614	478415	REPLACEMENT ZINC SCREW FOR S602
S615	478420	REPL BRASS TERMINAL SCREW FOR S602 & S603



609

604

S603

S602

Typical Wiring Diagram for 6-way Round Connectors

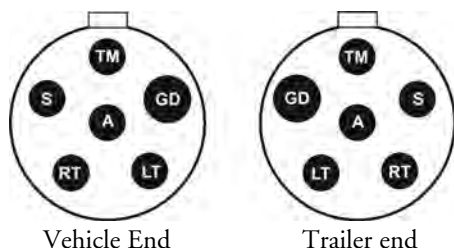

Vehicle End

Trailer end

S*	Brakes	Blue	A*	Accessory	Red
GD	Ground	Black	LT	Left Turn	Yellow
TM	Taillights	Brown	RT	Right Turn	Green

*Caution: Some manufacturers use "S" for Accessory and "A" for Brakes.

Note: Locate wires by function only. Color coding is not standard among all manufacturers.

7 Pole Plastic RV / Trailer Connectors

This Thermo-plastic 7-way RV Connector has brass contacts to prevent corrosion. The built-in cable clamp prevents wear on 7-way cable. It is interchangeable with other 7-way RV connectors. 12 volts, 30 amps.

PART NO.	REF. NO.	DESCRIPTION
12-707	478025	VEHICLE END CONNECTOR, 7 POLE
12-706	478050	TRAILER END CONNECTOR, 7 POLE



12-707



12-706

7 Pole Pin-Type Zinc Die Cast Trailer Connectors

This Zinc Die Cast 7-way Connector is designed for heavy-duty usage. Excellent for semi and utility trailers. The built-in slant of the socket rids the housing interior of accumulated moisture. Floating pins in the plug and socket allow for easy alignment and maximum contact. The Connector accepts the widest range of wire gauges from 14 gauge to 8 gauge ground wire and is interchangeable with other major brands. 6-28 volts, 40 amps.

11-700



11-720

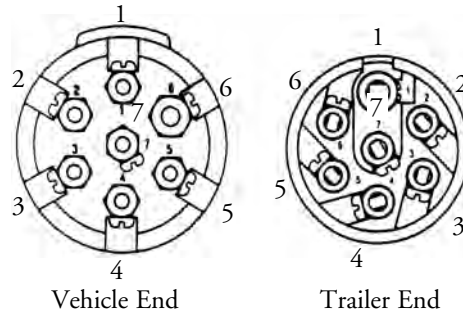

PART NO.	REF. NO.	DESCRIPTION
11-700	477800	TRAILER END, 7 POLE
11-763	477810	CABLE GUARD FOR 11-700
11-720	478000	VEHICLE END, 7 POLE

Typical Wiring Diagram for 7-Pole Pin-Type Connectors

1 Ground	White	7 Auxiliary	Blue
2 Marker & Clearance	Black	6 3 Bar Marker & Tail	Brown
3 Left Turn	Yellow	5 Right Turn	Green
4 Stop	Red		

Note: Locate wires by function only. Color coding is not standard among all manufacturers.

7 Pole RV / Trailer Connectors



12-703



12-702

This Connector is used on most RV travel trailers. The heavy-duty plating is for maximum weather and corrosion resistance. This connector features a stainless steel cover spring and a unique safety latch that prevents damage from accidental pull-away. It has the latest design, self-wiping pressure contacts and vinyl insert to keep out dirt. It is interchangeable with other 7-way RV connectors. 12 volts, 30 amps.

PART NO.	REF. NO.	DESCRIPTION
12-703	478200	VEHICLE END, 7 POLE
12-702	478400	TRAILER END, 7 POLE

Typical Wiring Diagram for 7-Pole RV Connectors

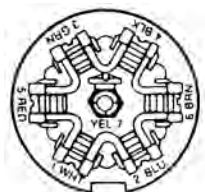

Vehicle End

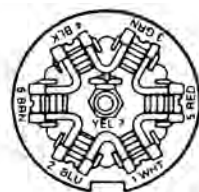

Trailer end

1 Ground	White
2 Electric Brakes	Blue
3 Tail Running Lights	Green
4 Battery	Black
5 LH Stop & Turn	Red
6 RH Stop & Turn	Brown
7 Auxiliary	Yellow

Note: Locate wires by function only. Color coding is not standard among all manufacturers.

LIGHTS & ELECTRICAL

Packaged Trailer Connectors



The Most Popular Connectors for Pegboard Display in your Sales Showroom!



PART NO.	REF. NO.	DESCRIPTION	CODES
TA01-020	474050	4-POLE FLAT, VEHICLE & TRAILER ENDS, W/48" WIRE	A
TA01-025	474060	4-POLE FLAT, TRAILER END, 12" WIRES	A
TA01-100	474080	6-POLE ZINC DIE CAST, VEHICLE END	A
TA01-110	474090	6-POLE ZINC DIE CAST, TRAILER END	A
TA01-120	474100	7-POLE PLASTIC RV TYPE, VEHICLE END	A
TA01-125	474110	7-POLE PLASTIC RV TYPE, TRAILER END	B

Popularity Codes: (A = Most popular item) (B = Fast Moving) (C = Medium) (D = Slow)

EZ Connectors

FINALLY! A WATER-PROOF, CORROSION-FREE TRAILER PLUG!

What is it really costing you when you have an electrical plug failure? Between vehicle downtime, shop labor, replacement parts, and a possible ticket or accident, can you afford for your trailer to sit idle, or better yet, risk the lives of you and your family, or your load because of a mediocre electrical trailer connection?

EZ Connector saves you time and money while keeping you and your load safely on the road. EZ Connector's patented, corrosion-free design along with superior face-to-face spring-loaded brass contacts ensures a reliable trouble-free connection. Your lights and brakes will work every time, regardless of the conditions!



ez.connector



MADE IN THE USA



EZR7-01 & EZR7-03

EZR7-02 & EZR7-04



EZR7-12



EZR7-51



EZR7-52



EZR7-54



EZR7-56

PART NO.	REF. NO.	DESCRIPTION
EZR7-01	474800	COMPLETE BUMPER HARD WIRED
EZR7-02	474801	BUMPER T-CNCTR 98-11 FORD & CHEVY, 09-11 DODGE
EZR7-02D	474802	BUMPER T-CNCTR 95-08 DODGE
EZR7-03	474803	COMPLETE 5TH WHEEL HARD-WIRED
EZR7-04	474804	5TH WHL T-CNCTR 99-11 FORD & CHEVY, 95-08 DODGE
EZR7-04D	474805	5TH WHL T-CNCTR 95-08 DODGE
EZR7-05	474806	BUMPER SIDE HARD WIRED
EZR7-06	474807	BUMPER VEHICLE SIDE T-CNCTR 99-11 FORD/CHEVY, 09-11 DODGE
EZR7-06D	474808	BUMPER VEHICLE SIDE T-CNCTR 95-08 DODGE
EZR7-07	474809	BUMPER TRLR SIDE
EZR7-08	474810	5TH WHEEL HARD-WIRED VEHICLE SIDE
EZR7-09	474811	5TH WHL T-CNCTR 99-11 FRD/CHVY, 09-11 DODGE VEH END
EZR7-09D	474812	5TH WHL T-CNCTR 95-08 DODGE VEHICLE END
EZR7-10	474813	5TH WHEEL TRAILER SIDE ONLY
EZR7-11	474814	DUMMY PLUGS
EZR7-51	474815	EZ FEMALE TO 7-WAY RV MALE
EZR7-52	474816	EZ MALE TO 7-WAY RV FEMALE
EZR7-12	474817	PLUG HOLDER
R7-102C	474818	CLAMP DOWN COUNTER TOP DISPLAY
EZR7-54	474819	MALE TO 4-FLAT FEMALE
EZR7-56	474820	MALE TO 6-WAY ROUND FEMALE

LIGHTS & ELECTRICAL

Quick Fix Flat 4 Pole Connectors



These connectors save time and money! Just set the wires into the prongs, and snap the retaining clip into place. No exposed wires or corrosion!

PART NO.	REF. NO.	DESCRIPTION
20031	474700	QUICK FIX/FLAT 4-WAY CONNECTOR TRAILER END
20030	474701	QUICK FIX/FLAT 4-WAY CONNECTOR VEHICLE END

2 Pole Molded Rubber Trailer Harness



This Trailer Connector is used to hook up accessories. Includes a plug on both ends.

PART NO.	REF. NO.	DESCRIPTION	POLE	WIRE LENGTH	GAUGE
42	474200	ACCESSORY HARNESS	2	12"	18

4 Pole Molded Rubber Trailer Split Wiring Harness Kits



425YH

Used to wire stop, turn and tail lights on boat and utility trailers. Complete harness includes the tow vehicle plug, and a "wishbone" type 4-conductor harness designed to split at the trailer tongue and run down each side of the trailer. The polarized flat connectors with color coded 18 gauge wires meet SAE specifications.



PART NO.	REF. NO.	DESCRIPTION
3430Y	475450	4 POLE TRLR & VEHICLE 18GA 30'
425YH	475500	4 POLE TRAILER END 18GA 25'
430YH	475550	4 POLE TRAILER END 18GA 30'

4 & 5 Pole Molded Rubber Trailer Harness

Commonly known as the "Flat 4-way" plug, this style Trailer Connector is most widely used for boat and utility trailers without electric brakes. The 5 pole has an added 16-gauge red wire as a fifth terminal for brake solenoid or other auxiliary use. Commonly used on newer boat trailers.



44P

PART NO.	REF. NO.	DESCRIPTION
44P	474400	4 POLE TRAILER END 18GA 12"
45P	474403	5 POLE TRAILER END 18/16 GA 12"
44S	474600	4 POLE VEHICLE END 18GA 48"
45S	474603	5 POLE VEHICLE END 18/16 GA 48"
I-5P	474650	4 FLAT TRK/TRLR ENDS, 72" 1 PC

6 Pole Molded Rubber Trailer Harness



46S

This 6 Pole Molded Rubber Trailer Connector has color-coded wires for simple installation and is polarized to ensure a proper connection. The molded case offers all-around weather protection. This Connector is used on most tent trailers.

PART NO.	REF. NO.	DESCRIPTION
46P	475000	6 POLE TRAILER END 18GA 12"
46S	475200	6 POLE VEHICLE END 18GA 48"

6 & 7 Pole Molded Trailer Cords

These 6-way and 7-way Molded Trailer Cords have encapsulated terminals and wires to form a single weather-tight, noncorrosive assembly. This feature keeps the moisture out and allows for a more secure connection.

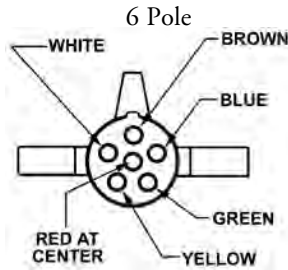

- White Ground
- Blue/Black. . Electric Brake
- Green Right, Stop & Turn
- Red Auxiliary
- Brown Tail & License
- Yellow Left, Stop & Turn

PART NO.	REF. NO.	DESCRIPTION
TC61-104	475570	6-POLE ROUND MOLDED TRLR END 4'
TC61-108	475580	6-POLE ROUND MOLDED TRLR END 8'

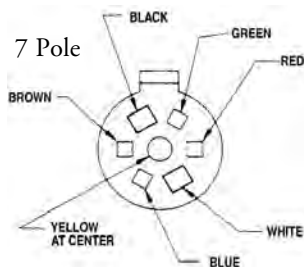

- White . . Ground
- Blue . . . Electric Brake
- Green . . Tail & License
- Black . . Battery Charge
- Red . . . Left, Stop & Turn
- Brown . . Right, Stop & Turn
- Yellow . . Auxiliary

PART NO.	REF. NO.	DESCRIPTION
TC67-003	475590	TRAILER HARNESS 7-POLE RV TYPE TRAILER END 8'
5187410	475595	5TH WHEEL 7-WAY W/90° PLUG, 99-11 CHEVY/GMC/FORD & 2010 DODGE HARNESS
5197411	475596	5TH WHEEL 7-WAY W/90° PLUG, 00-09 DODGE RAM FULL SIZE P/U
5097412	475598	5TH WHL 7WAY W/90 DEG PLUG 07-10 TOYOTA TUNDRA



6 & 7 Pole Vehicle Cord

The sealed Vehicle End Connector with cable features encapsulated terminals and wires to fight corrosion and ensure a quality connection. The connector is made of high strength thermo-plastic for a very attractive look. Matching metal vehicle connector brackets also available.

- White . . Ground
- Blue. . . Electric Brake
- Green . . Tail & License
- Black . . Battery Charge
- Red . . . Left, Stop & Turn
- Brown . . Right, Stop & Turn
- Yellow . . Auxiliary

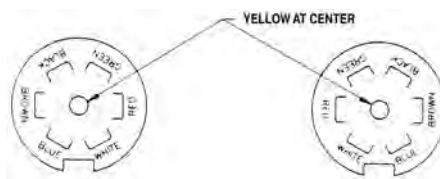

PART NO.	REF. NO.	DESCRIPTION
TC68-004	475553	6-POLE ROUND MOLDED VEHICLE END 4'
TC68-007	475555	6-POLE ROUND MOLDED VEHICLE END 7'
TC78-004	475560	7-POLE RV TYPE VEHICLE END 4'
TC78-007	475565	7-POLE RV TYPE VEHICLE END 7'

Vehicle-to-Trailer Wiring Systems



The quick and easy way to wire trailer lights! No more stripping, splicing or taping. Takes the work out of wiring a trailer to any car, truck or van; domestic or import! For connecting Camping Trailers, Boat Trailers, Horse / Stock Trailers **OR ANY TRAILER!**

The diagram to the right shows how the "T" connector works on trucks that have a plug-in taillight connection... usually located just behind the rear bumper. **All you do is unplug that connector, plug the "T" connector into the circuit and into the trailer. THE WIRING IS NOW COMPLETE. IT'S THAT SIMPLE!**

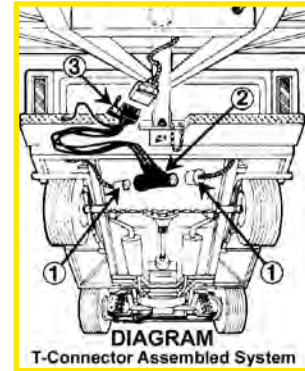

2 Part Wiring System

How It Works: Most pickups have a molded connector that joins the wiring harness on the truck bed to the main wiring harness of the frame. This connector is located just behind the rear bumper.

1. Simply pull apart this connector
2. Insert the "T" connector
3. Plug it back together
4. Now plug in the harness that matches the connector on your trailer

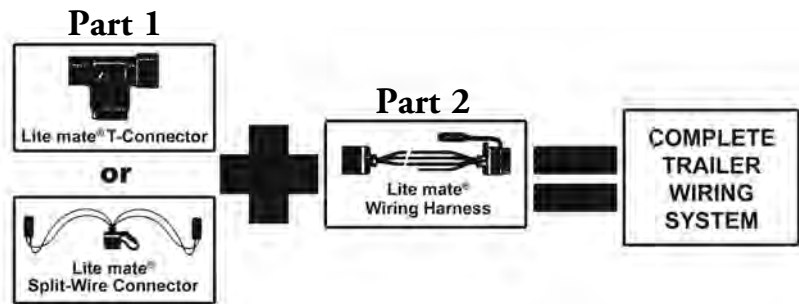

How to Select a Trailer Wiring System:

1. Choose the Application that fits your vehicle.
2. Select the Wiring Harness that matches your trailer from the list below.



4, 6 & 7 WAY HARNESSSES		
PART NO.	REF. NO.	FITS
37175	478610	MULTI-TOW 6 & 4-WAY VEHICLE PLUG
40965	478613	MULTI-TOW 6 & 4-WAY PLUG FOR 99-11 FORD/GM W/OEM 7-WAY
37185	478615	MULTI-TOW 4 & 7-WAY VEHICLE PLUG
40955	478618	MULTI-TOW 7RV & 4-WAY PLUG FOR 99-09 FORD/GM W/OEM 7-WAY
22715	480400	WIRING HARNESS W/FLAT 4-WAY PLUG
42145	481168	MULTI-TOW 7RV & 4-WAY FOR 00-08 CHRYSLER/DODGE/JEEP
3065	481475	ADAPTER PLUG, CONVERTS FLAT 4-WAY TO 6-WAY ROUND
3074	481500	ADAPTER PLUG, CONVERTS FLAT 4-WAY TO 7-WAY ROUND
48470	481510	MULTI-TOW 3 IN 1, 7-WAY, 5 & 4-WIRE FLAT VEHICLE SIDE CONNECTOR
40999	481511	MULTI-TOW 7RV W/5 & 4-WAY FLAT, W/OEM 7-WAY FORD,CHEV,DODG

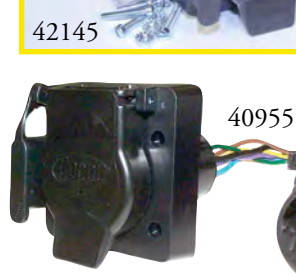

LIGHTS & ELECTRICAL

Vehicle-to-Trailer Wiring Systems

Vehicle-to-Trailer Wiring Systems One-Step: One-Piece Hook-up!

- Plug-In Simple Vehicle-To-Trailer Wiring!
- Designed For Installers & Do-It-Yourselfers.
- Quick & Easy! No Cutting! No Splicing!
- One Piece: T-Connector, 42” wire, & Flat 4-Way Assembly
- Extensions & Harnesses available with 4-way, 6-way & 7-way connectors
- Models to fit most popular vehicles

PART NO.	REF. NO.	FITS	CHEVY/GMC
41135	481632	98-04 S10/S15 SONOMA	ISUZU HOMBRE 98-01
41145	481636	99-02 CHEVY/GMC SILVERADO/SIERRA	
41345	481640	03-09 CHEVY/GMC EXPRESS/SAVANA VANS	
41165	481642	04-09 CHEVY/GMC COLORADO/CANYON	
41155	481646	00-11 CHEVY2500/3500, 03-11 1500 NEW STYLE	
41125	481648	88-98 CHEVY PICKUP OLD BODY 99-00 SURB92-99	
41225	481652	95-02 BLAZER JIMMY 95-01 99-01 ENVOY	



41155

PART NO.	REF. NO.	FITS	FORD
40125	481112	87-96 FULL SIZE FORD PICKUP, ALL F250HD	87-97
40215	481114	93-99 RANGER/MAZDA PU,INC CONV	
40155	481118	99-01 FORD F-250/350 SUPERDUTY	
40165	481120	02-04 FORD F250 HD, F350	
40185	481124	05-08 FORD F150 TRUCKS	
40915	481126	95-01 EXPLORER 96-01 MNTNEER 98-99 RANGER W/TOWPK	
40145	481130	97-04 F-150/250 LD	



40915

PART NO.	REF. NO.	FITS	DODGE, CHRYSLER, JEEP
42135	481170	02-06 DODGE RAM 1500,03-06 2500/3500	
42115	481174	95-03 DODGE DAKOTA,95-02 RAM 2500 & 3500	
42215	481178	96-00 CHRYSLER MINIVANS,98-03 DURANGO	
42535	481180	99-04 JEEP GRAND CHEROKEE	
42615	481184	98-04 JEEP WRANGLER	



42535

PART NO.	REF. NO.	FITS	IMPORTS
43355	481158	05-11 TOYOTA TACOMA & 94-98 T-100	
43315	481160	84-95 TOYOTA PICKUPS, (EXCEPT T-100) TACOMA 95-04	

Junction Boxes



The 7-Pole Junction Box provides a fast, simplified way of connecting wires from the trailer connector to the trailer wiring. It is an excellent area for trouble shooting, by offering a single connection point.



The junction box is made of heavy duty plastic and includes fitted grommets making it weather proof and corrosion resistant. It can also be used as a 6-pole junction box as the box contains extra grommets for 6-conductor cable.

PART NO.	REF. NO.	DESCRIPTION
JB10-170	483020	JUNCTION BOX, 6 OR 7 POLE

Taillight Converters



TLC510



Some of today's domestic and import vehicles have a new "3-wire" taillight system utilizing separate electrical circuits for turn signals and brake lights. This can cause a wiring problem when towing a trailer or being towed by a vehicle that has the conventional two-wire system.

The Power Converter draws power for trailer lights directly from the battery protecting sensitive vehicle electronic systems.



TLC513

PART NO.	REF. NO.	DESCRIPTION
TLC510	473500	3-WIRE TO 2-WIRE CONVERTER FOR TRAILER TOWING, HAS BUILT-IN 4-WAY FLAT TRAILER CONNECTOR
TLC513	473515	POWER CONVERTER W/MOLDED FLAT 4-WAY, FITS MOST LATE MODELS

Battery & Accessories

The 12 volt, AGM (Absorbed Glass Mat) battery is great for most high amperage draw applications. From hydraulic hoists, to power jacks, to electric winches, this battery will have you covered. The battery charger is great for any application that requires repeated recharging of a battery. The charger is a 3 stage, fully automatic charger, so you can plug it in and forget about it. Two LED lights on the front of the charger let you know exactly what the charger is doing.

With these accessories, you can mount your battery with peace of mind. Choose the battery box to keep your battery completely out of the elements, or the battery tray with crossbar and J-hooks. The battery box comes complete with a 2 piece box, and a strap to hold on the lid. The box will keep your battery out of the elements, which prevents premature terminal and wire corrosion, as well as keeping it out of sight. The battery tray will allow you to mount the battery on any flat surface, wherever you need it.



PART NO.	REF. NO.	DESCRIPTION
UB12750H	485105	12V BATTERY, AGM GROUP 24, 75 AH
2611-1-B	485200	BATTERY CHRGR-10AMP,12v ON-BOARD AGM COMPAT 110v
3009	485250	BATTERY BOX W/LID GROUP 24, PLASTIC
253	485255	BATTERY TRAY, GROUP 24 BLACK PLASTIC
250	485260	BATTERY HOLD DOWN BKT 6-7/8" WIDE CROSSBAR
242	485265	BATTERY HOLD-DOWN BOLTS 10" J-HOOKS

LIGHTS & ELECTRICAL

Trailer Connector Adapters



For towing trailers with 4-flat, 5-flat, or 6-round plugs, using a 6-round or 7-RV socket. Simply install the adapter between the trailer cord and tow vehicle plug.



ADP624



ADP724RV



ADP725RV



ADP726RV



ADP627RV



ADP764RV



47570

PART NO.	REF. NO.	DESCRIPTION
ADP624	478490	CONVERTS 6-WAY ROUND RECEPTACLE TO FLAT 4-WAY PLUG
ADP627RV	478495	CONVERTS 6-WAY ROUND TO 7-WAY RV
ADP724RV	478500	CONVERTS 7-WAY RV RECEPTACLE TO FLAT 4-WAY PLUG
ADP725RV	478525	CONVERTS 7-WAY RV TO 5-FLAT
ADP726RV	478550	CONVERTS 7-WAY RV RECEPTACLE TO 6-WAY ROUND PLUG
ADP764RV	478555	CONVERTS 7-WAY RV RECEPTACLE TO 6-WAY & 4-WAY
47570	478609	ENDURANCE ADPTR 7RV TO 6-WAY RND, 5 & 4-WAY FLAT W/QCK CHANGE CENTER PIN TO AUX/BRAKE



4-way Flat Tester with Display



If you have a sales counter, then you should be selling the flat-lite tester. This 4-way flat tester features LEDs that display stop and turn functions. When used as a dustcap the flat-lite provides continuous monitoring of the trailer light functions while keeping dirt and road spray out of the vehicle connector.

Sold in "fish bowl" displays of 50 pieces, the flat-lite will make a great impulse addition to your sales counter.

PART NO.	REF. NO.	DESCRIPTION
48678	479700	4-WAY FLAT TESTER W/LEDS FISHBOWL DISPLAY (50 PCS)

Connector Brackets

The Steel Connector Brackets mount on the vehicle to secure the vehicle connector in place.

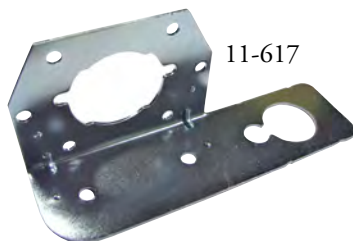

11-617



11-771

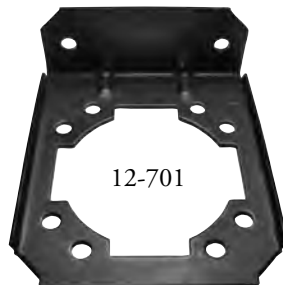

12-701



70985

PART NO.	REF. NO.	DESCRIPTION
11-617	482000	CHROME BKT FOR CONNECTORS S602, S402
11-771	482200	CHROME BKT FOR CONNECTOR 11-720
12-701	482400	BLK BKT FOR CNCTR 12-703, 12-707, TC78-004, TC78-007
70985	482600	CHROME BKT FOR "KNOCKOUT" CNCTR K04448