

Network Attached Storage

LinkStation 500

User Manual

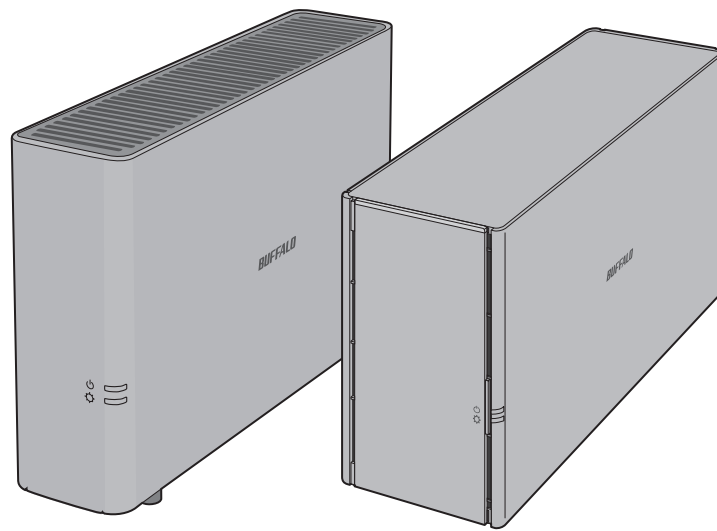

Please make sure to read this manual before using and follow the procedures. If you have any inquiries about the product, contact the number on the warranty statement or the packing box. Do not discard this manual, the warranty statement, or the packing box.

Americas: www.buffaloamericas.com

Europe: www.buffalo-technology.com

Asia Pacific: www.buffalo-asia.com

Contents

Chapter 1 Getting Started	7
Diagrams.....	7
Accessing Shared Folders	8
Accessing from a Computer	8
Accessing from a Mobile Device	9
Turning the LinkStation On and Off	9
Restarting from Settings	9
Chapter 2 Configuration	12
Opening Settings	12
Opening from a Computer	12
Opening from a Mobile Device	14
Resetting Administrator Password.....	15
Navigating the Main Menu.....	15
The Home Screen	16
Launcher	16
Customizing the Home Screen.....	17
Adding New Shortcuts.....	17
Deleting Shortcuts.....	17
Restoring Shortcuts	17
Arranging and Sorting Icons.....	17
Changing Icons.....	17
Launcher Options	18
Display Options.....	18
Wallpaper Options.....	19
Changing Display Languages	20

Chapter 3 My LinkStation	23
Adding Folders	24
Uploading and Downloading Files	26
Uploading from a Computer	26
Downloading Files to a Computer	27
Sharing Files and Folders Using Shared Links	27
Chapter 4 Media Player	30
Creating Playlists	31
Adding Media Files	32
Playing Files.....	33
Chapter 5 Disk Manager	35
RAID Arrays.....	35
Working with RAID Arrays	35
Using JBOD	35
Changing RAID Mode	38
Expanding RAID Array Capacity	40
Adding an External Hard Drive	41
Dismounting an External Drive.....	42
Dismounting Using the Eject Button.....	42
Dismounting Using Disk Manager.....	42
Formatting Drives	43
Hard Drive Replacement	45
Step 1 - Replacing a Hard Drive	46
Step 2 - Rebuilding the RAID Array.....	48

Chapter 6 System Information	52
Server Info	52
System Log.....	53
Chapter 7 Services	55
Folder Setup	55
Adding Shared Folders	55
Recycle Bin.....	57
Configuring Access Restrictions	57
Samba	58
AFP	59
FTP.....	60
DLNA Server	61
Playing Files on the DLNA Client Device	63
iTunes	63
Downloader	65
Enabling Downloader Service	65
Opening the Download Manager	66
Downloading Files	68
WebAccess	70
Configuring WebAccess.....	70
Accessing Remotely	71
Direct Copy	72
Chapter 8 System.....	73
Users.....	73
Creating Users	73

Changing Passwords	75
Deleting Users	76
Groups.....	76
Creating Groups.....	76
Deleting Groups.....	78
Network	78
Changing the Hostname	78
Changing the IP Address	79
Wake-on-LAN	80
System Language	82
Changing System Languages.....	82
Changing FTP Client Character Encoding	82
Date & Time.....	83
Changing Date and Time	83
Changing Time Zone.....	85
Power Management.....	87
Drive Spin Down	87
Sleep Mode.....	89
UPS Sync	90
Firmware	92
Online Update	92
Manual Update.....	92
Backup	94
Backing Up from LinkStation.....	94
Backing Up Your Mac with Time Machine	100
Reset.....	104
Initializing from Settings	104
Initializing with the Function Button	106

Chapter 9 Configuring from Mobile Devices.....	107
Settings That Can Be Changed from Your Mobile Device	107
Managing User Accounts.....	107
Creating Users	107
Changing Passwords	109
Deleting Users.....	110
Changing the RAID Mode	110
Configuring WebAccess	111
Configuring DLNA Server	117
Managing USB Devices	117
Dismounting USB Drives	117
Starting Direct Copy	118
Configuring UPS Sync.....	119
Chapter 10 Utilities.....	120
NAS Navigator2 for Windows.....	120
Changing the IP Address	122
NAS Navigator2 for macOS	123
Changing the IP Address	125
NovaBACKUP	126
Chapter 11 Appendix	127
When the Power LED Blinks.....	127
White.....	127
Red	127
Amber	128
Default Settings	128

Specifications 129

Chapter 12 Regulatory Compliance Information... 130

For Customers in the United States 130

For Customers in Europe 131

Chapter 1 Getting Started

Diagrams

LS510D

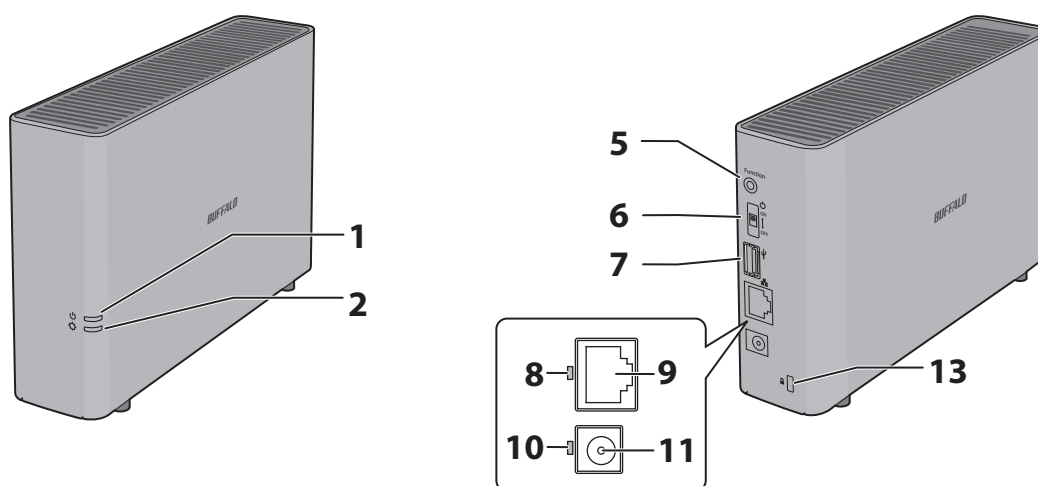

LS520D, LS520DE

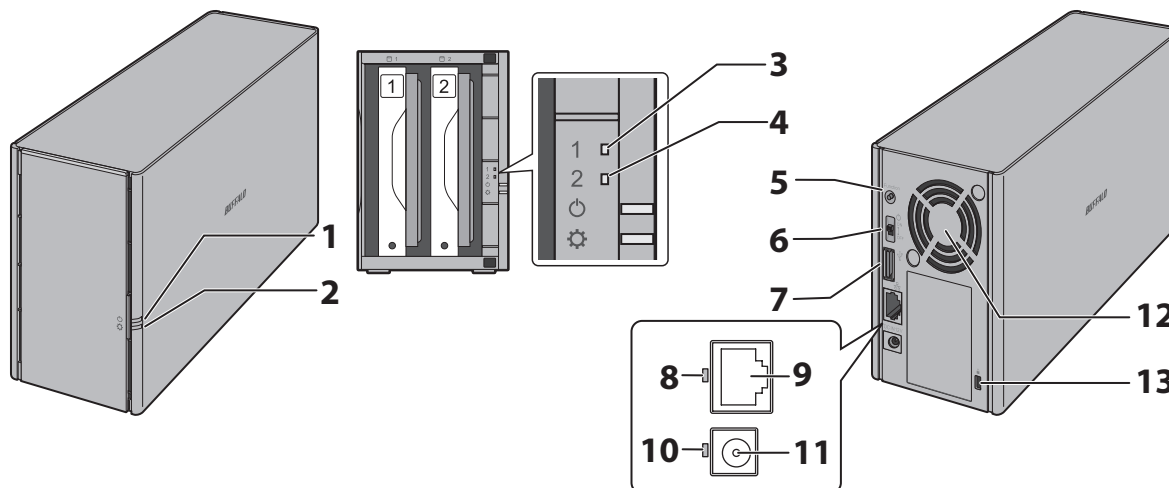

1 Power LED (🔌)

- The white power LED will light up while the LinkStation is on.
- The white power LED blinks while booting or shutting down.
- The red power LED blinks when an error occurs.
- If there is a status message, the power LED blinks amber.
- If there is new firmware available, the power LED glows amber.

2 Function LED (⚙️)

This LED glows white while the USB device is connected, and blinks white dismounting USB devices and during Direct Copy.

3 Drive 1 Error LED

If there is an error on drive 1, this LED will light.

4 Drive 2 Error LED

If there is an error on drive 2, this LED will light.

5 Function Button

Use this button for Direct Copy and initializing settings.

6 Power Switch (🔌)

Move the switch up and down to power on and off.

7 USB 3.0 Port (🔌)

Compatible Buffalo USB 3.0 hard drives and USB flash drives can be connected. USB hubs are not supported.

8 Link and Activity LED

This LED shows network activity. It blinks green when the LinkStation is accessed over the network.

9 LAN Port (🔌)

Connect to a router, hub, or switch on your Ethernet network with the included Ethernet cable.

10 Power Status LED

The LED glows green when the power cable is connected.

11 Power Connector

Use the included power cable to connect to a surge protector or outlet.

12 Fan

Spins to prevent overheating inside. Do not block the fan.

13 Anti-Theft Security Slot (🔒)

Use this slot to secure your LinkStation with a cable lock (not included).

Accessing Shared Folders

Accessing from a Computer



1 Double-click the  icon to start NAS Navigator2.

2 In NAS Navigator2, double-click your LinkStation's icon.

3 The Explorer will open with a list of shared folders. For macOS, the LinkStation is mounted as a drive icon on the desktop or it is displayed in the sidebar of the Finder.

Accessing from a Mobile Device

To access shared folders from a mobile device with the following procedure, you must configure WebAccess settings first. To configure WebAccess, see the "WebAccess" section in chapter 6.

- 1 Open SmartPhone Navigator.
- 2 Tap your LinkStation from the NAS list.
- 3 Tap *Browse*.

Note: Alternatively, you can access shared folders from the WebAccess app. Open the application and tap your LinkStation in the NAS list.

Turning the LinkStation On and Off

Move the power switch on the back of the LinkStation to the "on" position to turn it on. To turn it off, move the switch to the "off" position and wait for the unit to fully shut down before unplugging it. Never unplug the AC adapter without properly shutting down the LinkStation first.

When all the LEDs on the front of the LinkStation turn off, the shutdown process is complete.

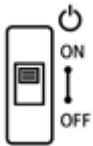

Restarting from Settings

You can also restart the LinkStation remotely from Settings. To restarting from Settings, follow the procedure below.

- 1 Double-click the  icon to start NAS Navigator2.
- 2 Right-click on your LinkStation's icon and choose *Settings*. For macOS, click your LinkStation's icon while holding down the control key, then select *Settings*.

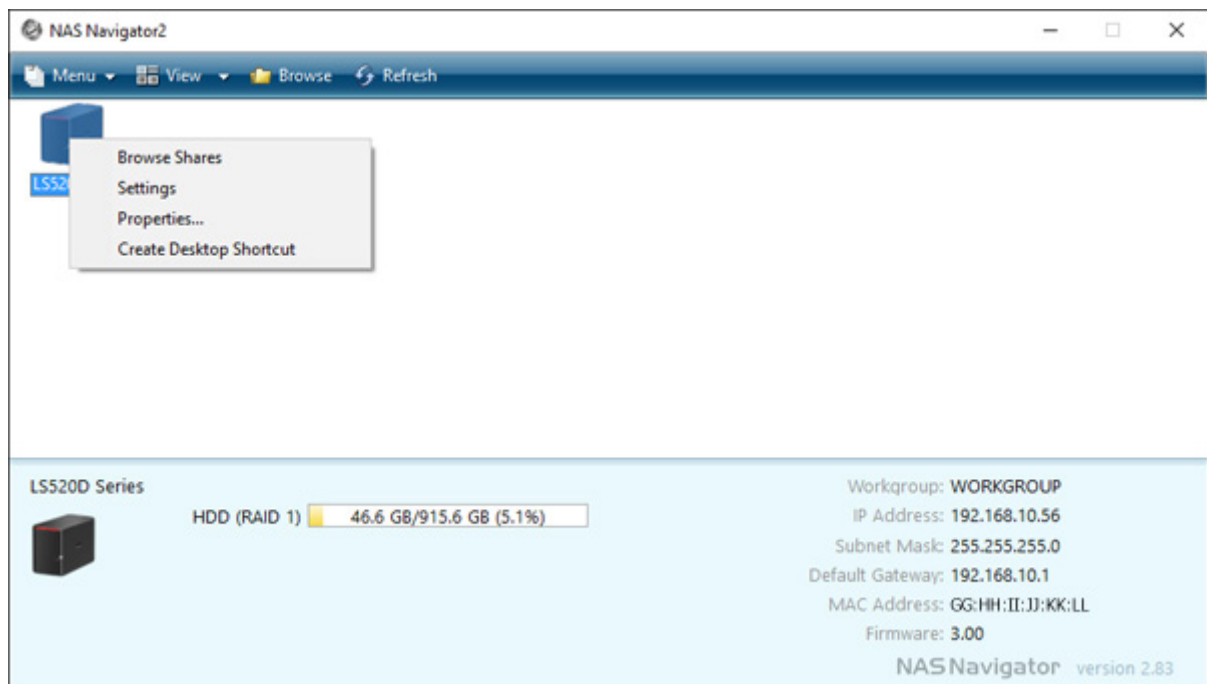

3 Enter a username and password, then press the Enter key or click *Log In*.

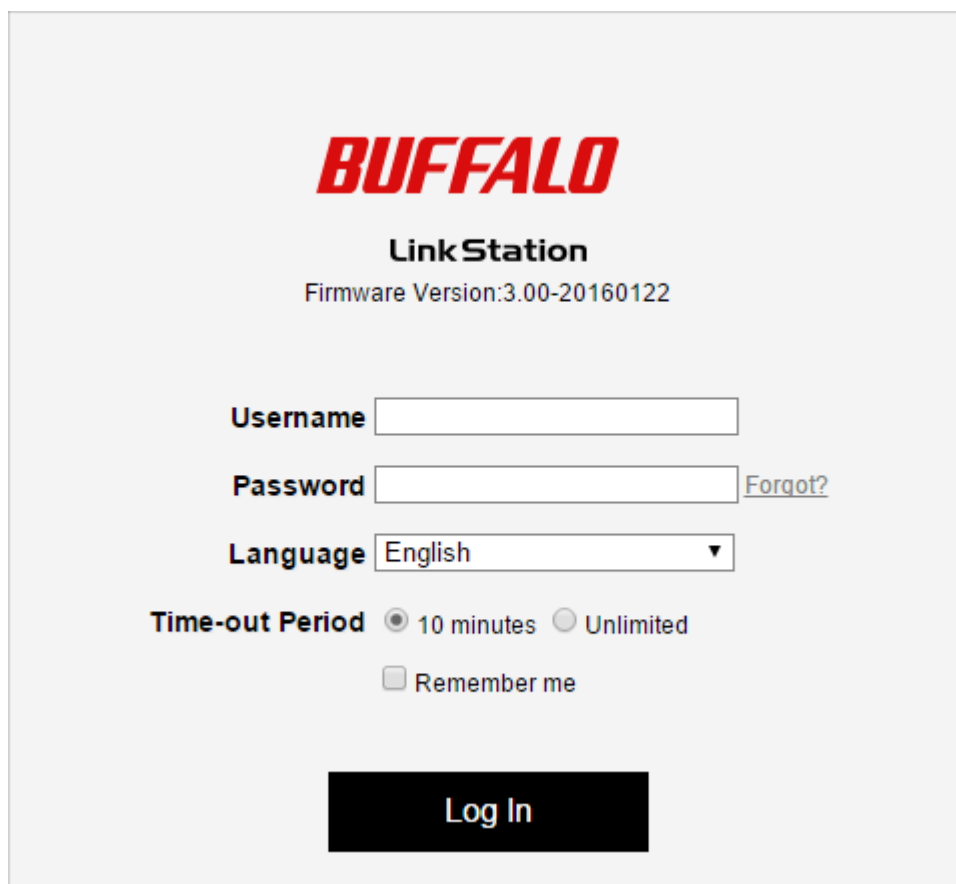

The image shows the Buffalo LinkStation login interface. At the top, the Buffalo logo is displayed in red, followed by the text "LinkStation" and "Firmware Version:3.00-20160122". Below this, there are three input fields: "Username" with an empty text box, "Password" with an empty text box and a "Forgot?" link to its right, and "Language" with a dropdown menu currently set to "English". Underneath the language field, there is a "Time-out Period" section with two radio buttons: "10 minutes" (which is selected) and "Unlimited". Below the radio buttons is a checkbox labeled "Remember me" which is currently unchecked. At the bottom center, there is a large black button with the text "Log In" in white.

4 Settings will open.



5 Click  at the top-left of Settings and choose *Restart*.

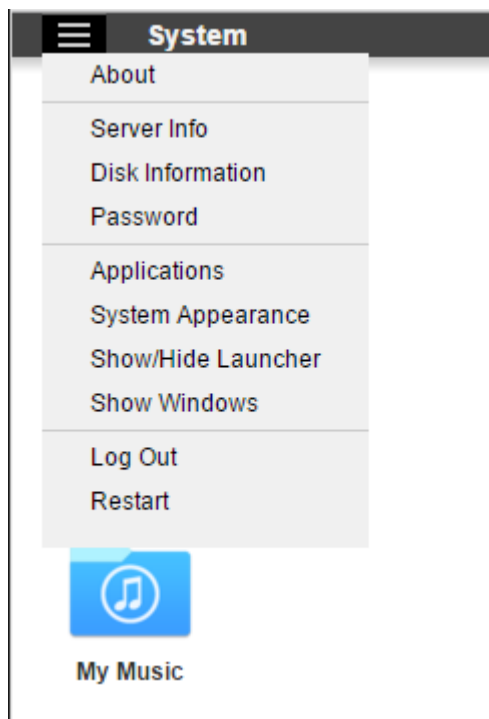

6 Click *Restart* again.

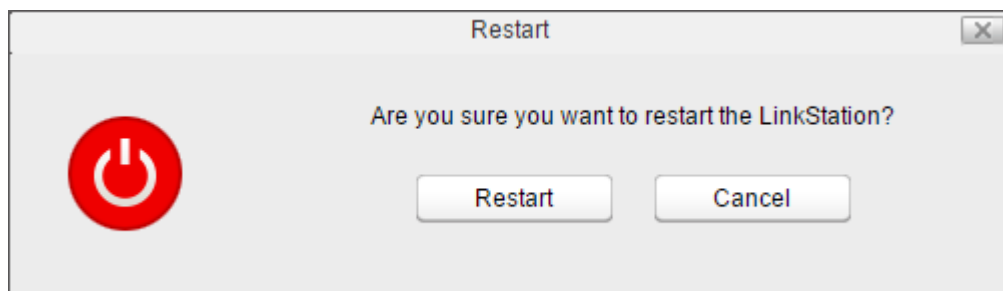

When the power LED stops flashing and glows white, the restart process is complete.

Chapter 2 Configuration

Configure and manage your LinkStation using the Settings interface, accessible from a browser window. Open the interface using the procedure below or type the LinkStation's IP address in the URL field of your browser.

Opening Settings

Opening from a Computer

Note: Microsoft Edge, Firefox, Google Chrome, Internet Explorer 9 or later, Safari 8 or later are supported. If you have difficulty viewing Settings, check the following:

If you have a proxy server enabled in the browser settings, disable the proxy server.

1 Double-click the  icon to start NAS Navigator2.

2 Right-click on your LinkStation's icon and click *Settings*. For macOS, click your LinkStation's icon while holding down the control key, then click *Settings*.

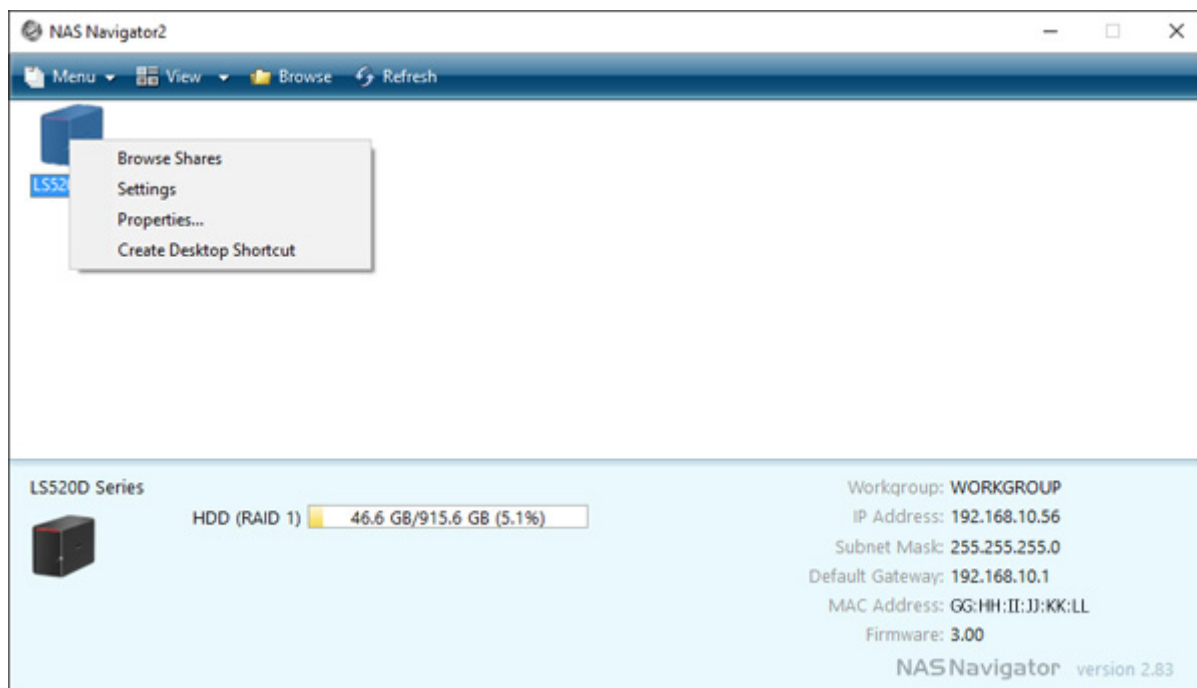

3 Enter a username and password, then press the Enter key or click *Log In*.

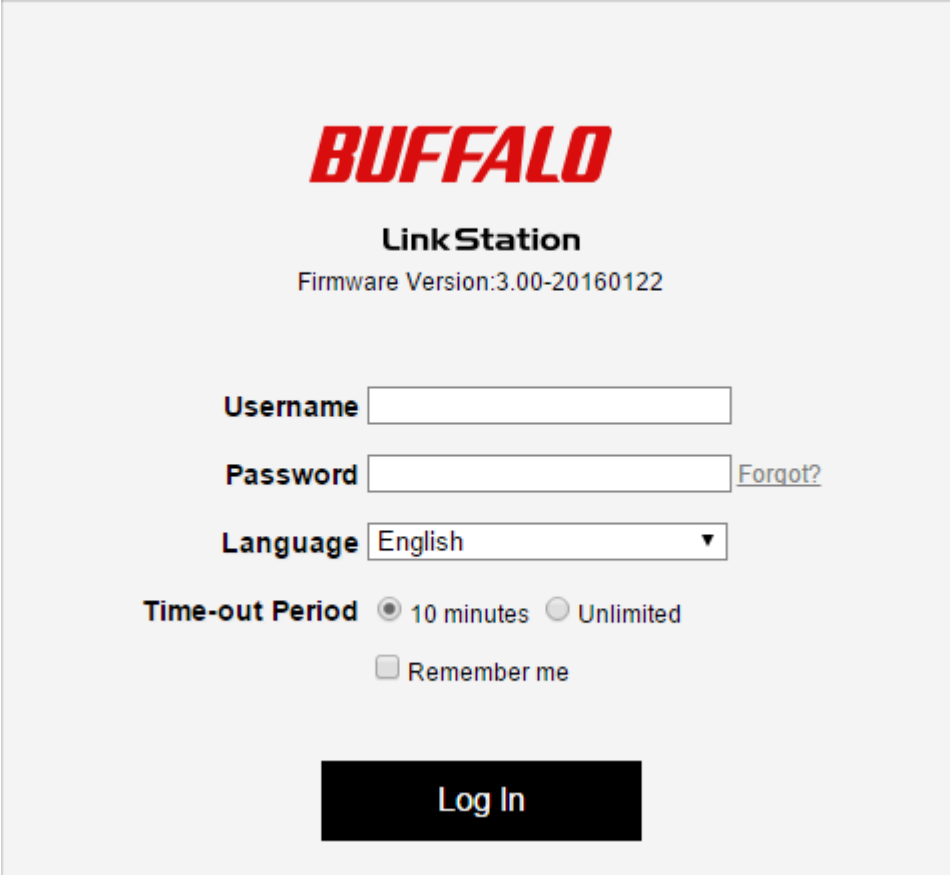

The image shows the Buffalo LinkStation login interface. At the top, the Buffalo logo is displayed in red, followed by the text "LinkStation" and "Firmware Version:3.00-20160122". Below this, there are three input fields: "Username" with an empty text box, "Password" with an empty text box and a "Forgot?" link to its right, and "Language" with a dropdown menu currently set to "English". Underneath the language field, there is a "Time-out Period" section with two radio buttons: "10 minutes" (which is selected) and "Unlimited". Below the radio buttons is a checkbox labeled "Remember me" which is currently unchecked. At the bottom center, there is a large black button with the text "Log In" in white.

4 Settings will open.

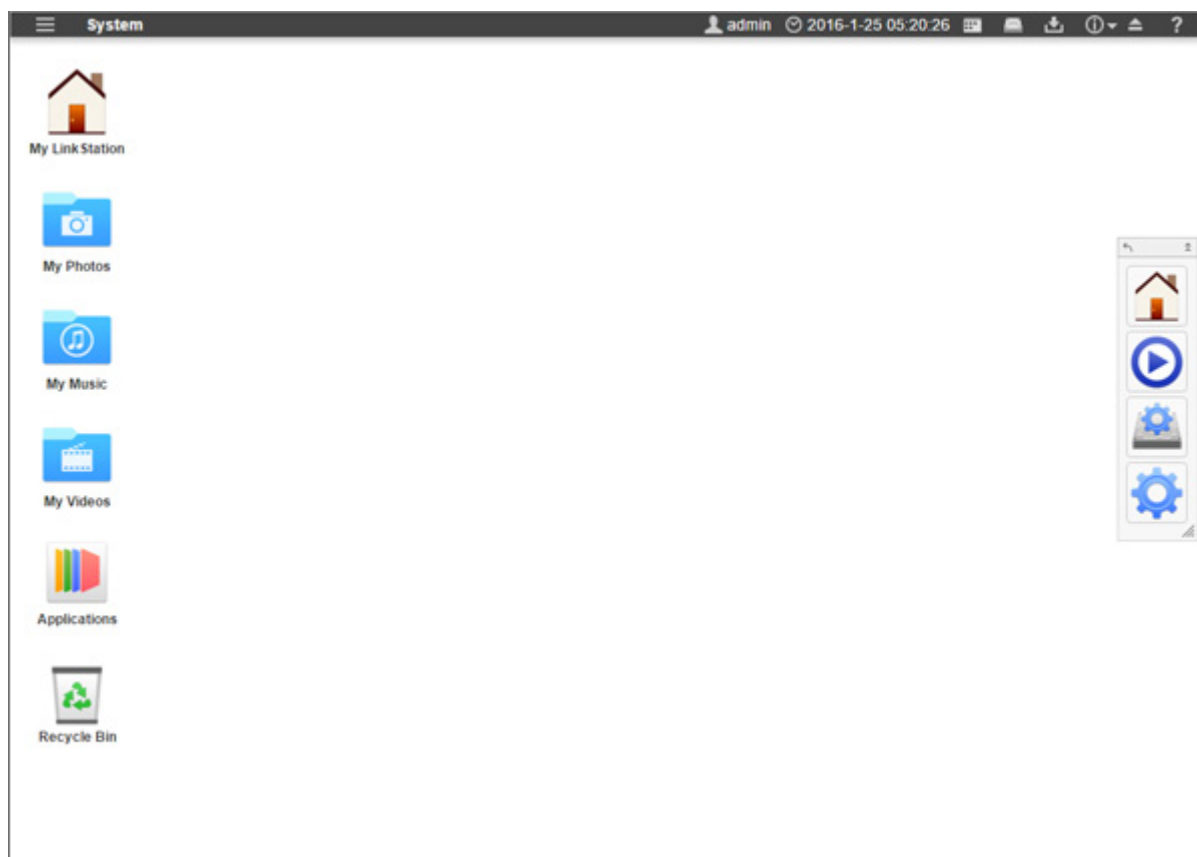

Notes:

- To log out from Settings, close the browser.
- If the time-out period is set to "10 minutes", you will be logged out of Settings after 10 minutes of inactivity.

Opening from a Mobile Device

You can access your LinkStation's Settings from your iOS or Android device. Download and install "SmartPhone Navigator" from the App Store or Google Play.

Notes:

- If you have an older version of SmartPhone Navigator installed on your device, update to the latest version. Your icons and software may be slightly different from the examples in this manual.
- You must be logged in as the "admin" user to change settings.
- Mobile devices that support mobile-optimized Settings display are listed below:
iPhone, iPad, and iPod touch*
Android smartphones and tablets**
* iOS 7.0 or later
** Android 4.1 or later

1 Open SmartPhone Navigator on your mobile device.



2 Tap *Open Settings*.

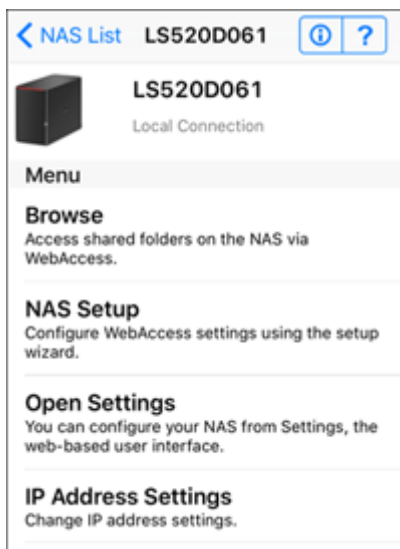

3 Settings will be displayed.



Notes:

- The first time you go through setup, you'll be given a chance to change the default password, create a user, select the RAID mode, and correct the time zone settings.
- If you tap any buttons, you will need to enter a username and password.

Resetting Administrator Password

If you forget the admin password and cannot log in to Settings, you can initialize it with the function button. Follow the procedure below to initialize the password.

- 1** Turn off the LinkStation.
- 2** Turn the LinkStation on while holding down the function button until the power LED flashes amber.
- 3** Initialization will start. Do not power down the LinkStation while the power LED is blinking.
- 4** When the power LED glows a steady white, initialization is finished.

Navigating the Main Menu

When you log in to Settings, you will see the following screen first.



The Home Screen

The home screen acts like a typical computer desktop. Default shortcuts are listed below:



Item	Description
My LinkStation	Accesses all stored files and folders and all LinkStation functions, including creating new folders.
My Photos	Shortcuts of folders that are in My LinkStation.
My Music	
My Videos	
Applications	Contains programs built in to the LinkStation, as well as default shortcuts to system settings.
Recycle Bin	Stores deleted files. If a file is accidentally deleted, you can restore it from this folder. To empty the recycle bin, right-click the recycle bin icon, then click <i>Clear</i> . Note: The recycle bin will only store files deleted from Settings.

Launcher

The launcher provides instant access to applications and settings of your choice. Even with other windows open in the LinkStation, the launcher will always stay on top for easy access. You can adjust the launcher size, screen position, orientation, or even hide it completely, depending on what is convenient for you.

Default launcher shortcuts are listed below:

Item	Description
 My LinkStation	The same as My LinkStation.

Item	Description
 Media Player	Plays audio or video files stored in the LinkStation.
 Disk Manager	Manages internal and external drives connected to the LinkStation.
 System Settings	Configures optional advanced settings.

Customizing the Home Screen

You can customize the home screen desktop to your specifications.

Adding New Shortcuts

To add a new desktop shortcut for an application, drag the application from the "Applications" folder to the desktop. To add a desktop shortcut for a file or folder, drag the file or folder from its location to the desktop.

Deleting Shortcuts

To delete a shortcut, you can either right-click on the shortcut and click *Delete*. Alternatively, you can drag and drop the shortcut into the recycle bin, then click *OK* from the dialog window.

Restoring Shortcuts

To restore desktop shortcuts to the default ones, right-click anywhere on the desktop and click *Restore Desktop Icons*.

Arranging and Sorting Icons

To re-arrange the icons, simply drag them to your preferred location on the desktop. To sort desktop shortcuts, right-click anywhere on the desktop and click *Sort Desktop Icons*. All the shortcuts will be re-arranged starting from the top-left corner.

Changing Icons

You can change replace an icon image with an image file on your LinkStation.

- 1 Right-click on a shortcut icon and click *Change Icon*.

2 Click *Change* and select the image you want.

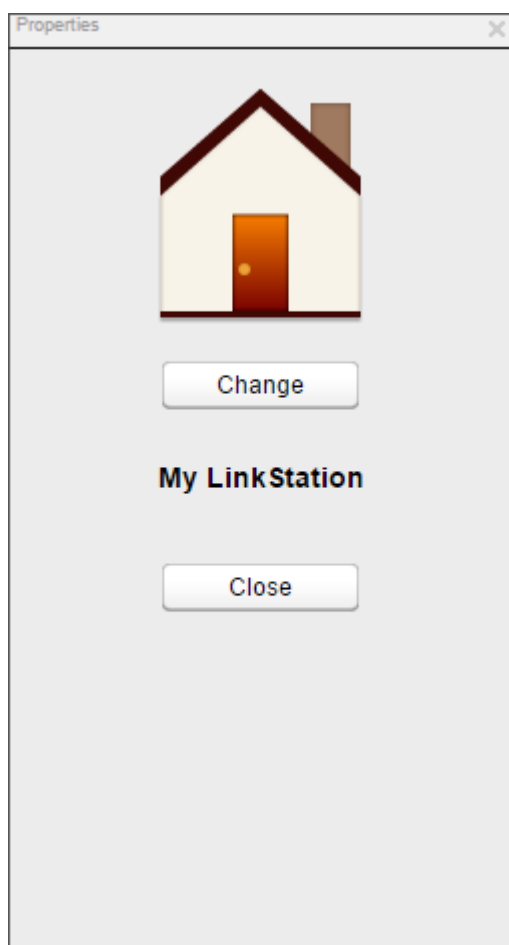

3 Click *Close*.

Launcher Options

You can remove or restore launcher shortcuts just as you would with desktop shortcuts.

In addition to removing applications, you can also change the location and size of the launcher.

- Click and drag on the launcher to re-position.
- Click on the double arrows in the gray handle to minimize the launcher.
- Click on the single arrow in the gray handle to flip the orientation from vertical to horizontal or vice versa.
- Click and drag the triangle in the corner of the launcher to resize it.

Display Options

Right-click anywhere on the desktop and click *Display Options*. You can adjust the sliders to change the item display sizes. To revert back to the factory default setting, click *Reset*.

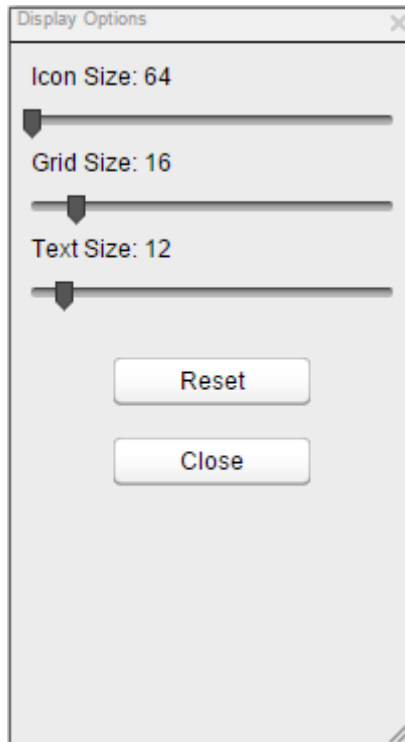

- Icon Size: Toggle between icon display sizes.
- Grid Size: Toggle between icon grid display sizes.
- Text Size: Toggle between text display sizes.

Wallpaper Options

You can replace the default wallpaper to match your own personal preferences. You can set any image stored on the LinkStation as the wallpaper. You can also enable the slideshow function to cycle through your images and display a new image at a preset interval.

- 1 Right-click on the background and click *System Appearance*.

- 2** Click the *Wallpaper* tab, then *Open*. Select the folder where your images are stored, or click *View system wallpapers* to view stock images included on your LinkStation. Click on the image you want to set as your wallpaper.



- 3** From the "Position" drop-down list, select how the image will be displayed.
- Stretch: Stretch the wallpaper to desktop size.
 - Center: Places the wallpaper in the center of the desktop.
 - Tile: Displays the wallpaper in a tile-like pattern.
 - Fill: Make the wallpaper fill the desktop and cut any overflow.
 - Fit: Make the wallpaper fit the desktop without overflow.
- 4** If you enable "Slideshow", you can set an interval in seconds to cycle through images in the selected folder as the background.
- 5** If you don't want to use an image as the wallpaper, you can set the background as a solid color and enable the "No Image" option.

Changing Display Languages

You can change the display language before or after you log in to Settings.

Changing from Login Page

Open Settings and select the language from the drop-down list. The display language will be changed.

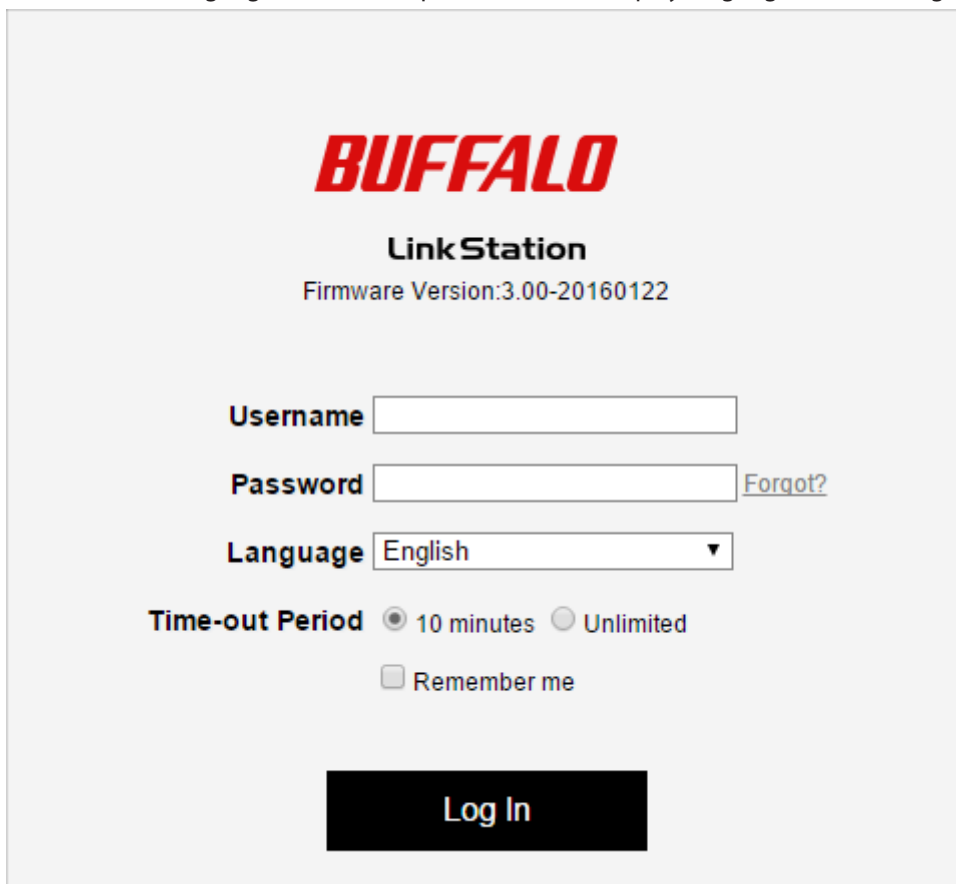

The screenshot shows the Buffalo LinkStation login interface. At the top, the Buffalo logo is displayed in red, followed by the text "LinkStation" and "Firmware Version:3.00-20160122". Below this, there are three input fields: "Username" with an empty text box, "Password" with an empty text box and a "Forgot?" link to its right, and "Language" with a dropdown menu currently showing "English". Underneath the language field, there are radio buttons for "Time-out Period" with options "10 minutes" (selected) and "Unlimited", and a checkbox for "Remember me" which is currently unchecked. At the bottom center, there is a black "Log In" button.

Changing from Desktop

- 1 Right-click anywhere on the desktop and click *System Appearance*.

2 Click the *Language* tab and select the desired display language from the list.

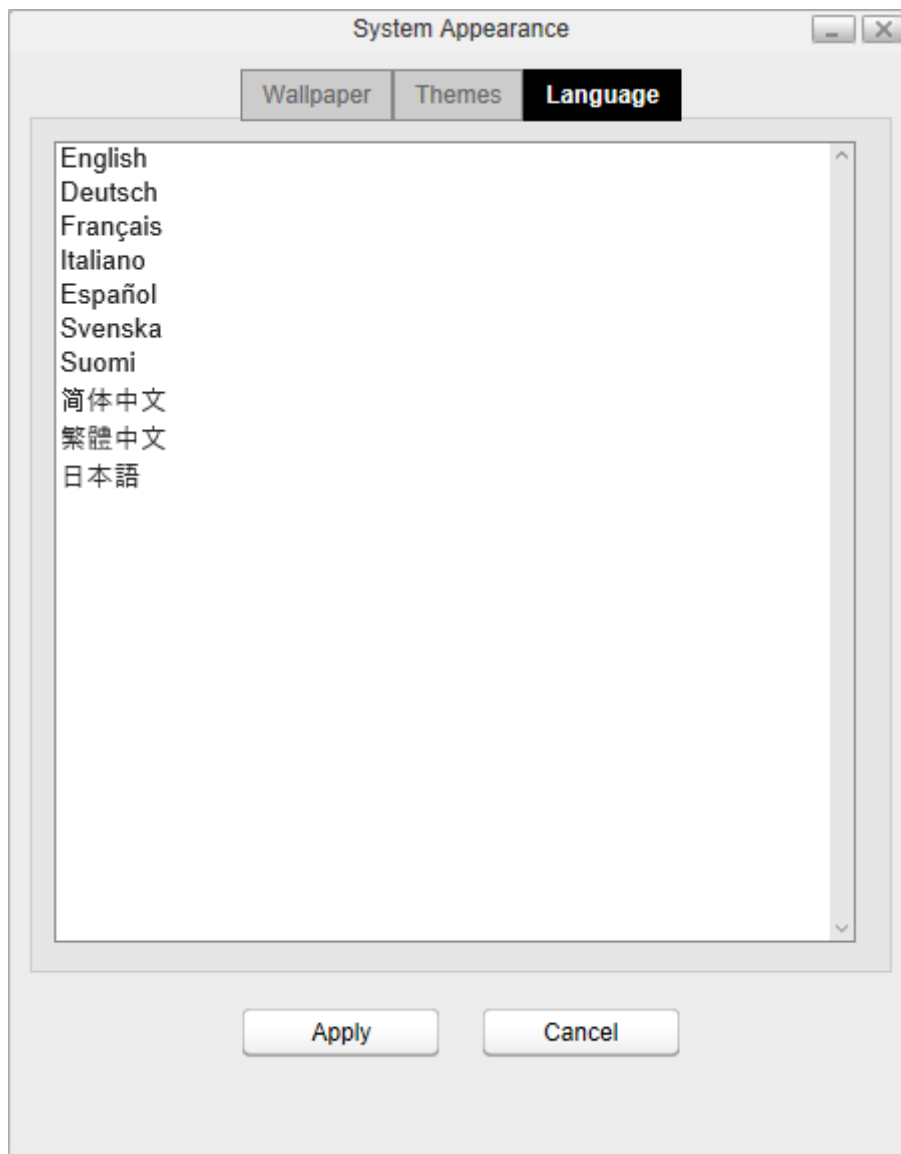

3 Click *Apply*.

Chapter 3 My LinkStation

My LinkStation is an application that manages files and folders stored on the LinkStation. To open My LinkStation,



double-click the icon from the home screen.

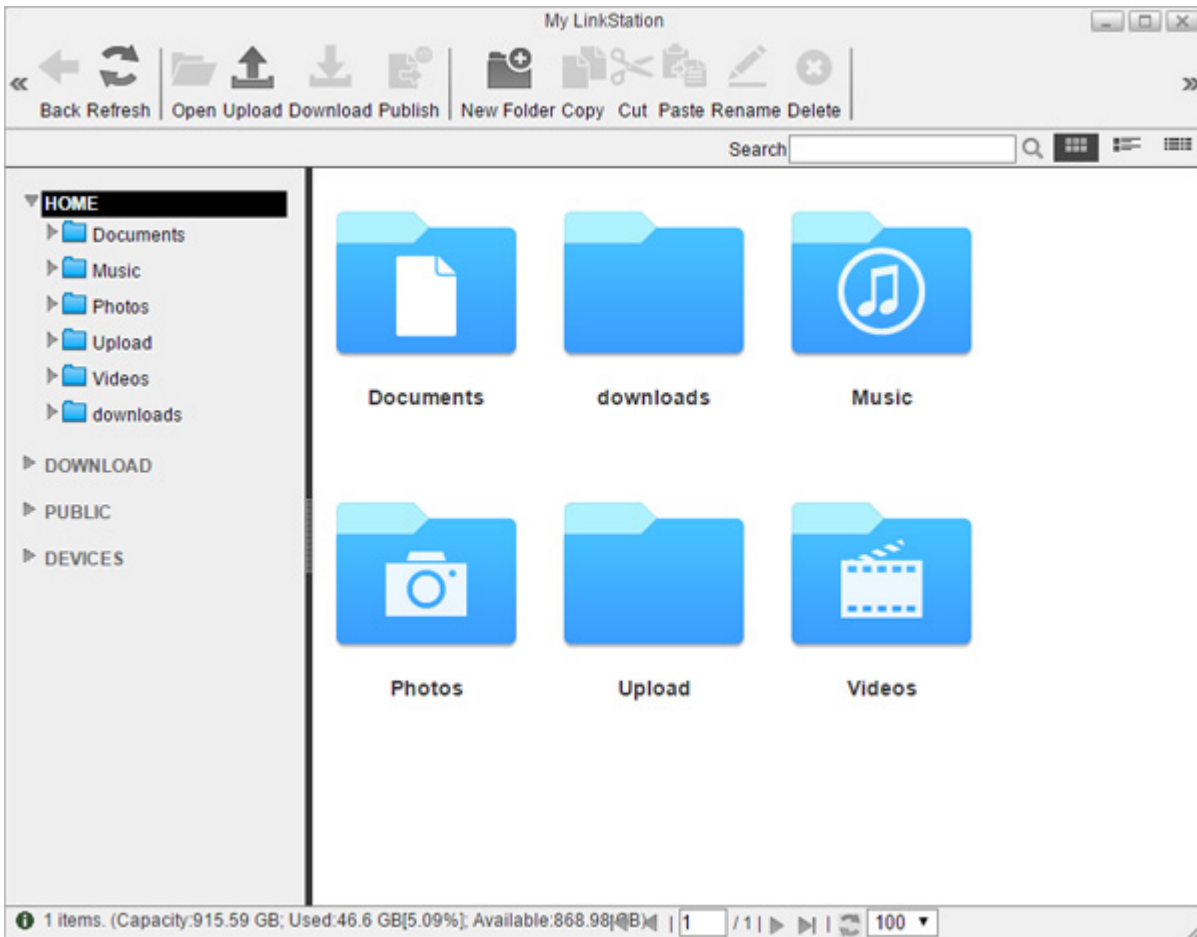









In the My LinkStation window, the following tabs will be displayed on the left as a directory:

- HOME: This shows subfolders in the user area that will be automatically created when creating a user. If you log in to Settings as the administrator, this will display all folders in the "admin" folder.
- DOWNLOADS: This is a folder that stores downloaded files.
- PUBLIC: This is a folder that any user can access.
- DEVICES: All shared and subfolders that are created in the LinkStation will be displayed.

Note: "DOWNLOADS" and "DEVICES" folders can only be accessed by the administrator user.

Icons	Name	Descriptions
	Back	Return to the previous screen.
	Refresh	Refresh the screen.
	Open	Open a file or folder.

Icons	Name	Descriptions
	Upload	Upload a file from your local computer to the LinkStation.
	Downloads	Download a selected file to your local computer.
	Publish	Share the selected folders or files with a link.
	New Folder	Create a new folder.
	Copy	Create a copy of the selected file or folder, either on the current directory or another that is available to the user.
	Cut	Cut the selected file or folder.
	Paste	Paste the cut file or folder to the new location.
	Rename	Change the name of a file or folder.
	Delete	Delete the selected file or folder.

Adding Folders

- 1 Select a shared folder to add a subfolder from the directory list at the left.

2 Click *New Folder*.

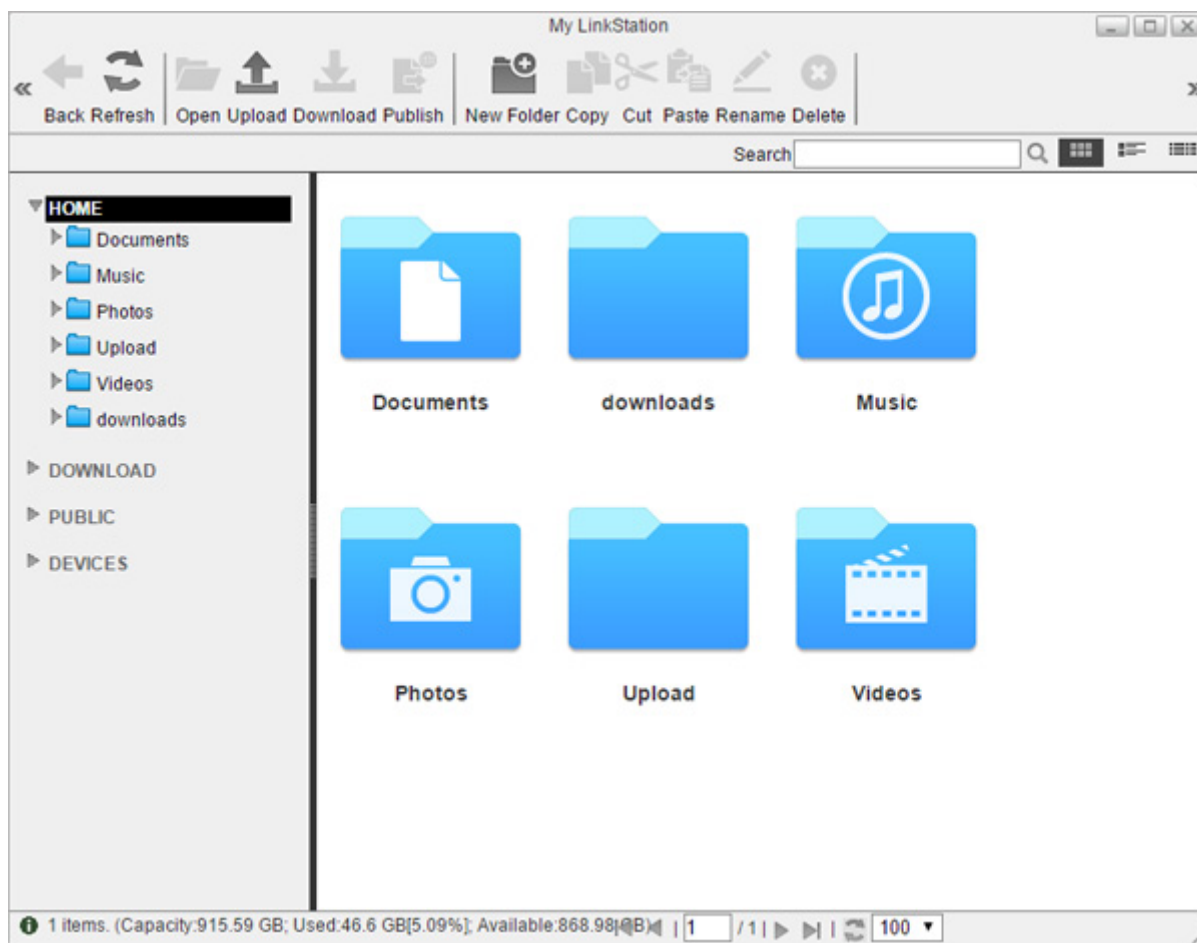

3 Enter a desired folder name and click *OK*.

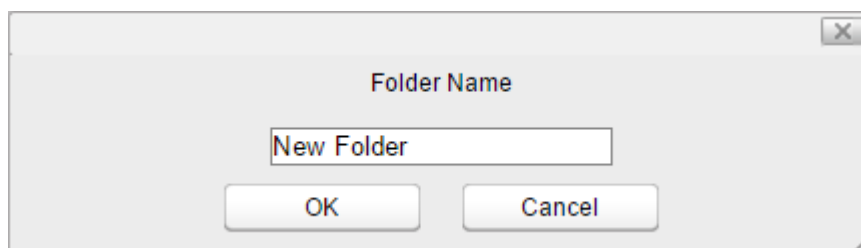

The folder will be created in the selected shared folder.

Uploading and Downloading Files

Uploading from a Computer

1 Select a folder to upload a file to and click *Upload*.

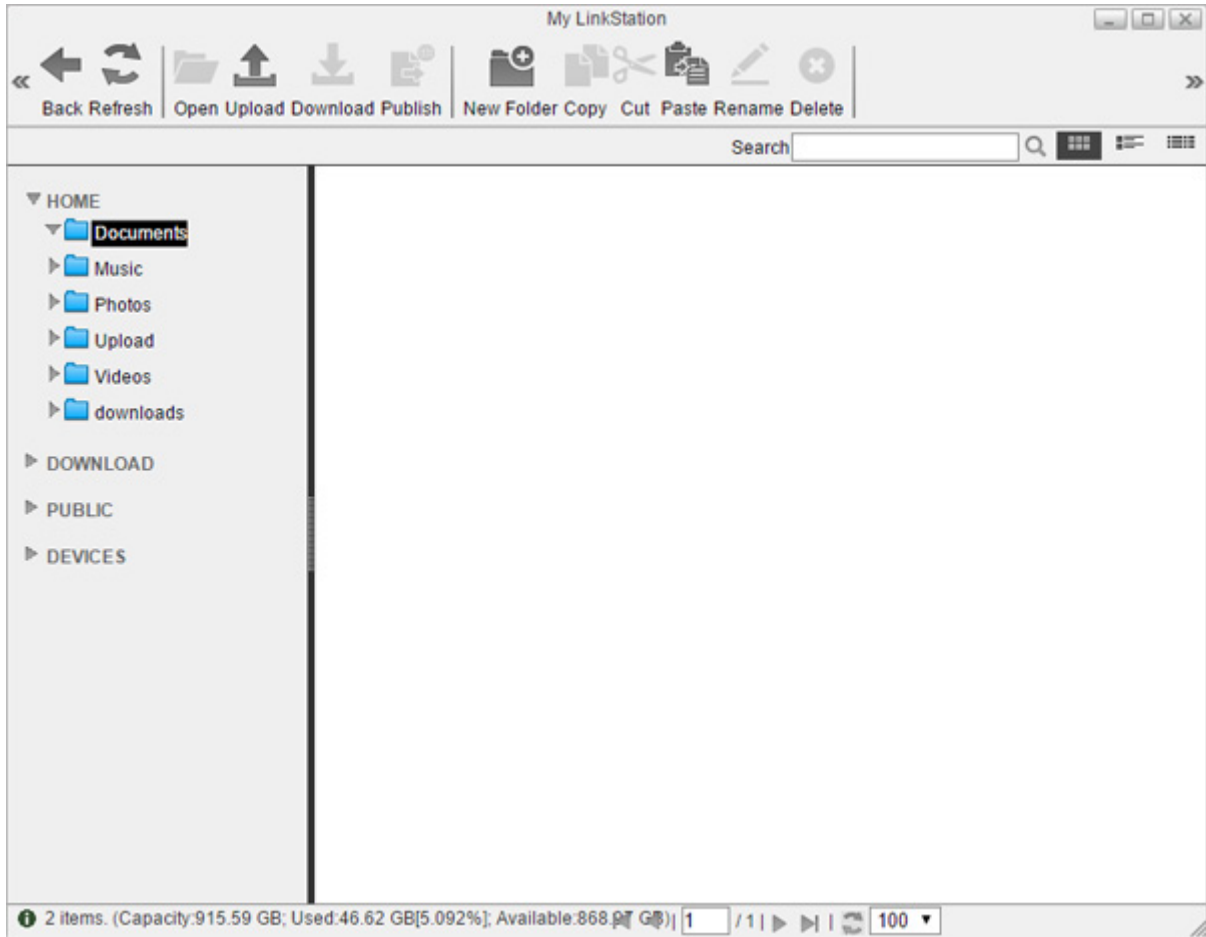

2 Click *Add* and select a file.

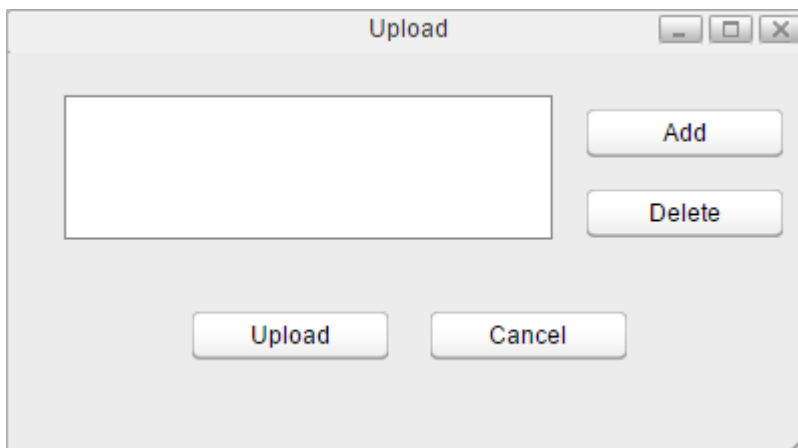

3 The selected file is added to the list. Click *Upload*.

The file will be uploaded to the LinkStation.

Downloading Files to a Computer

Select a file to download to your computer and click *Download*. The selected file will be downloaded to your computer.

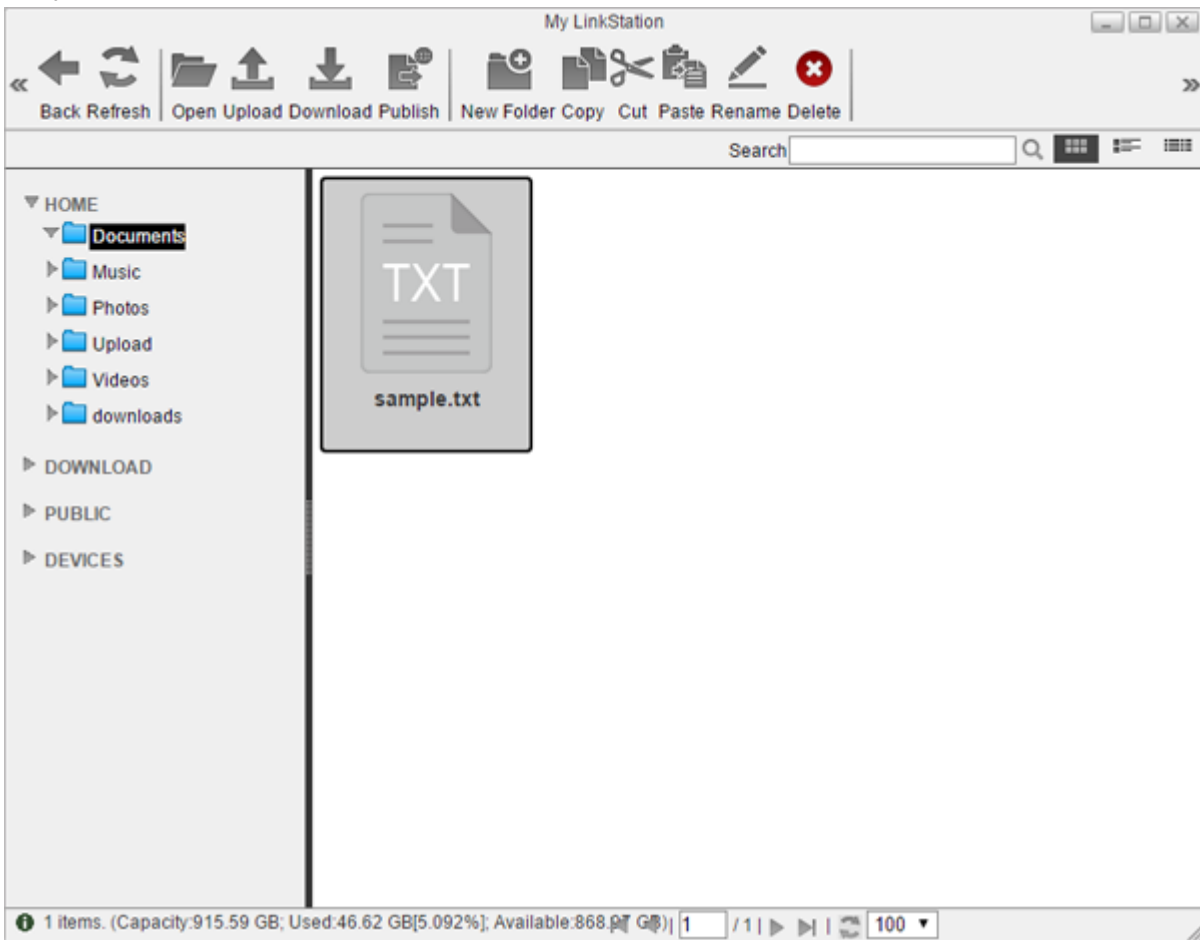

Sharing Files and Folders Using Shared Links

You can create a temporary shared link to share files or folders with other users on the local network or via the Internet. To enable the access from outside the network, you should configure WebAccess settings before creating the shared link. For more detailed information about WebAccess, refer to the "WebAccess" section in chapter 7.

1 Select a folder or file from the main window and click *Publish*.

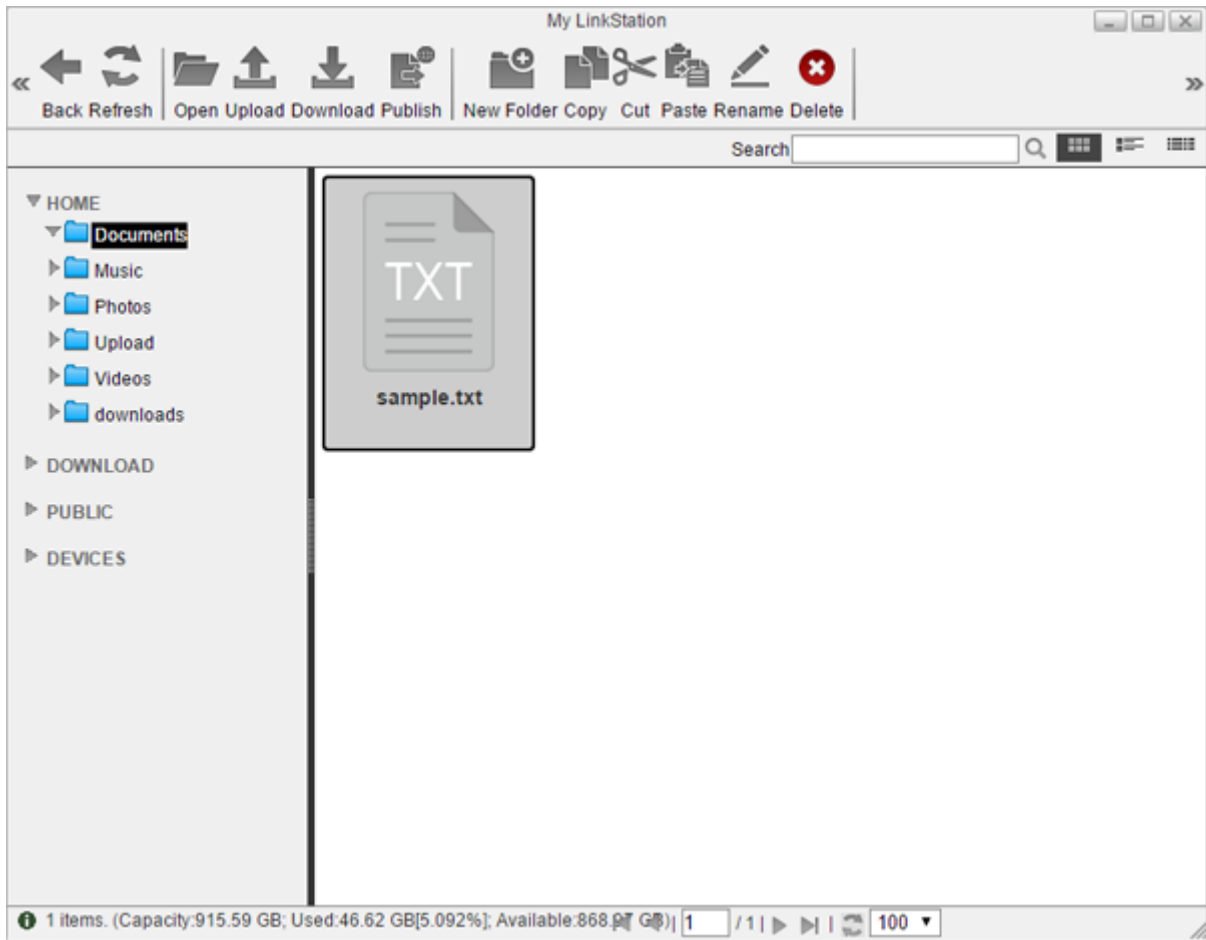

2 Click *Share*. The temporary shared link will be generated.

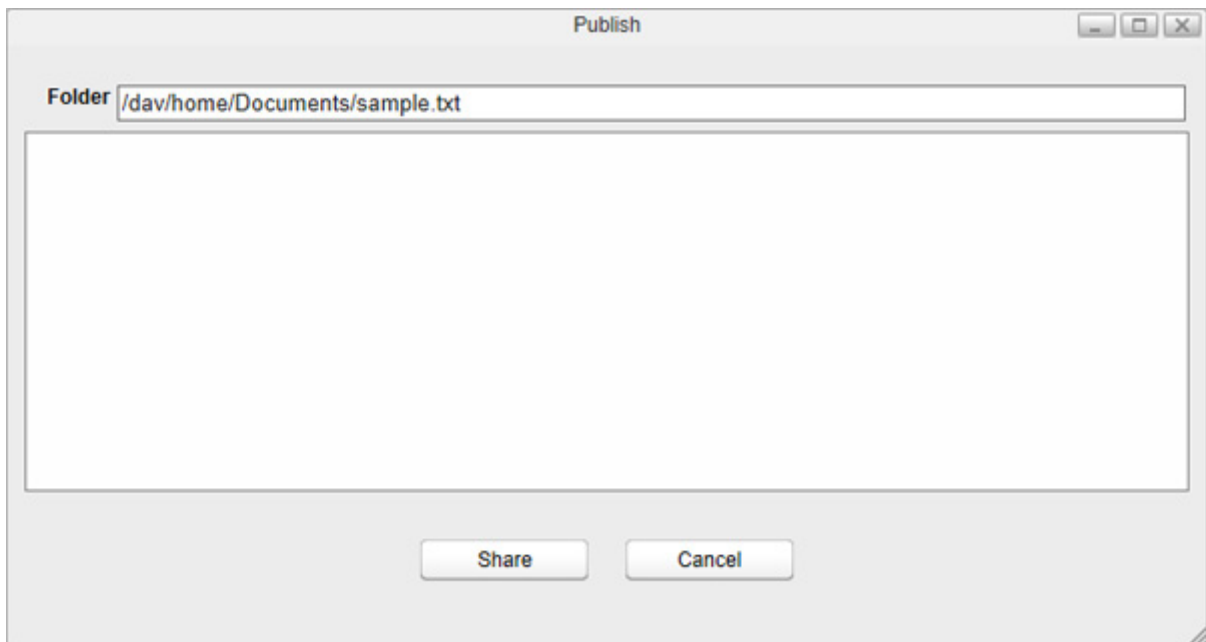

3 You can send the link by copying and pasting it into an email or messaging application.

The expiry date is set as to a month from the date when the link is generated. To change the date, click *Edit* and specify a date. After you finish editing, click *OK* to apply changes.

Notes:

- No other folder or file on the LinkStation can be accessed from the shared link.

- Expired links cannot be accessed.

Chapter 4 Media Player

Media Player is an application that can play media files on the LinkStation and create original playlists with the



media files. To open Media Player, click the icon from the home screen.

Icons	Name	Descriptions
	Refresh	Refresh the screen.
	Show Player	Displays the media player.
	Previous	Return to the previous media file.
	Play	Opens the media player and play media files in the playlist.
	Next	Skip to the next media file.
	Add List	Add a new playlist.
	Rename List	Change the name of a playlist.
	Delete List	Delete a selected playlist.
	Add Items	Add a media file to the playlist.
	Copy	Create a copy of the selected media file, either on the current directory or another that is available to the user.
	Cut	Cut the selected media file.
	Paste	Paste the cut media file to the new location.
	Delete	Delete the selected media file.

Creating Playlists

1 Select "PLAYLISTS" at the left of the window and click *Add List*.

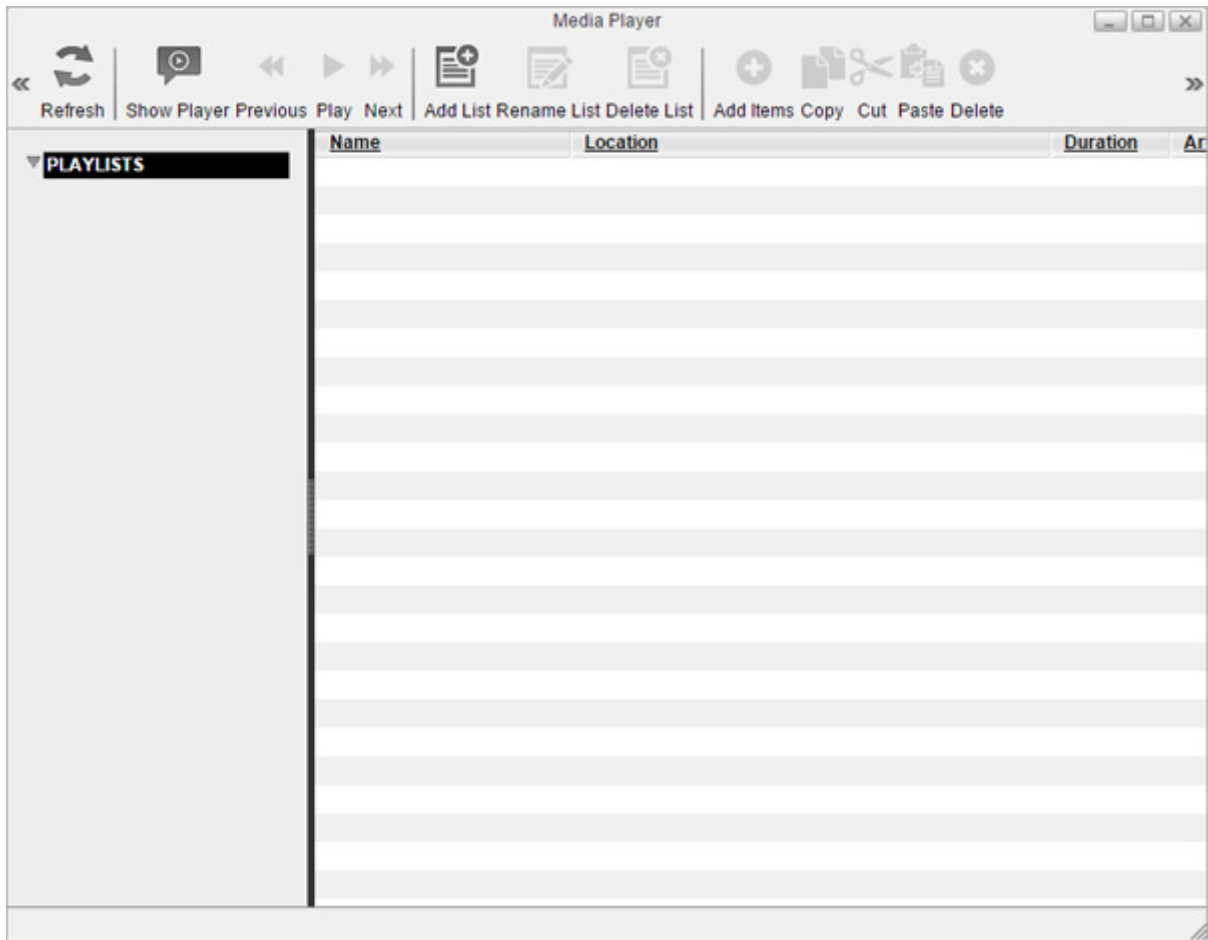

2 Enter a desired playlist name and click *OK*.

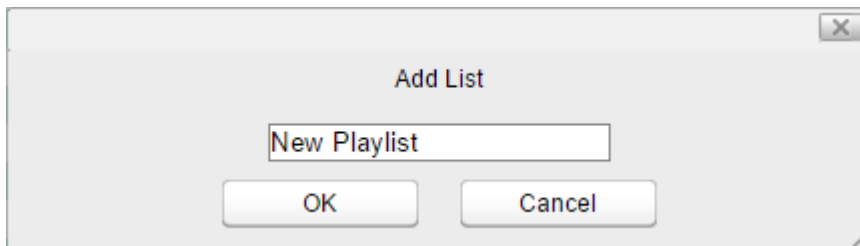

New playlist will be created.

Adding Media Files

1 Select the playlist at the left of the window and click *Add Items*.

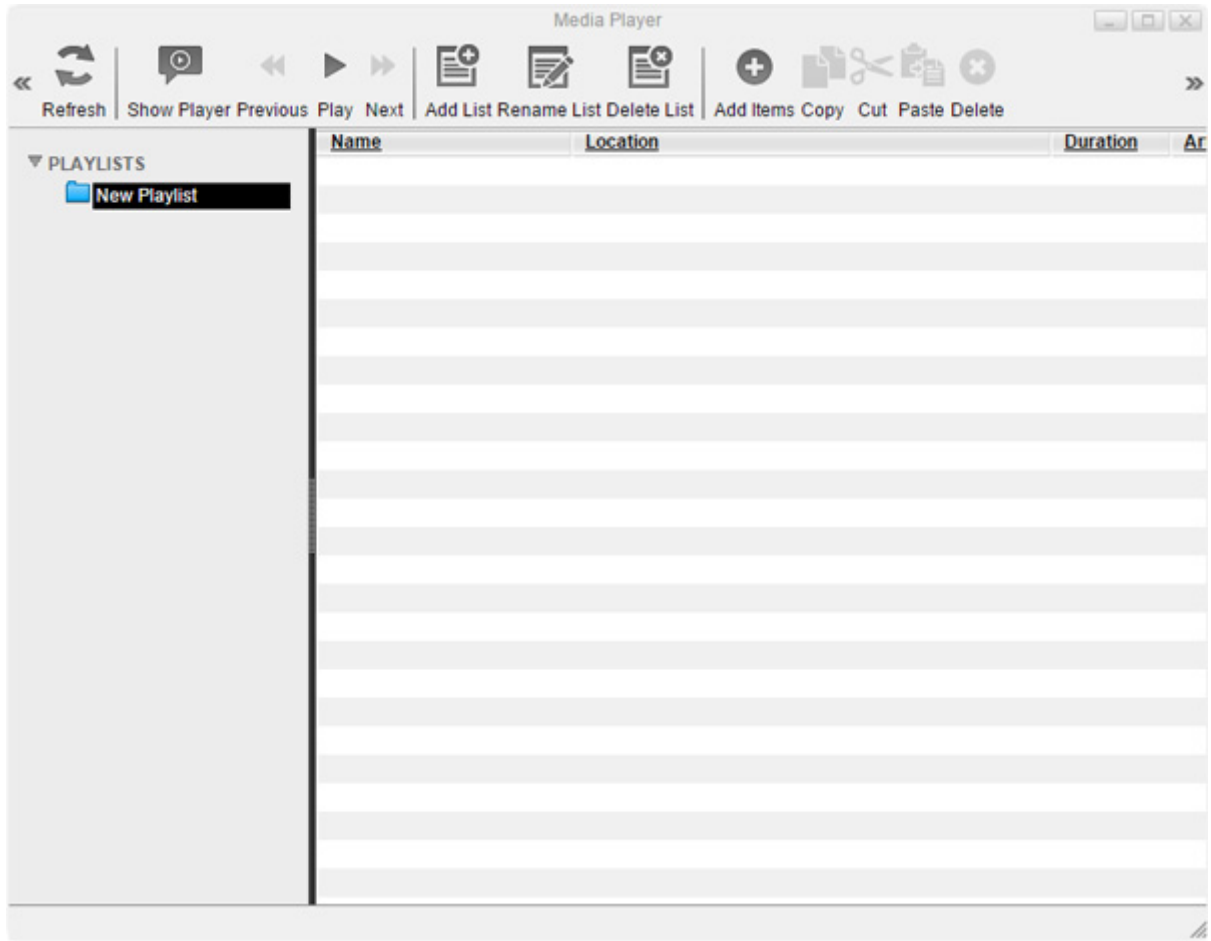

2 The dialog box will open. Select a media file to add and click *Open*.

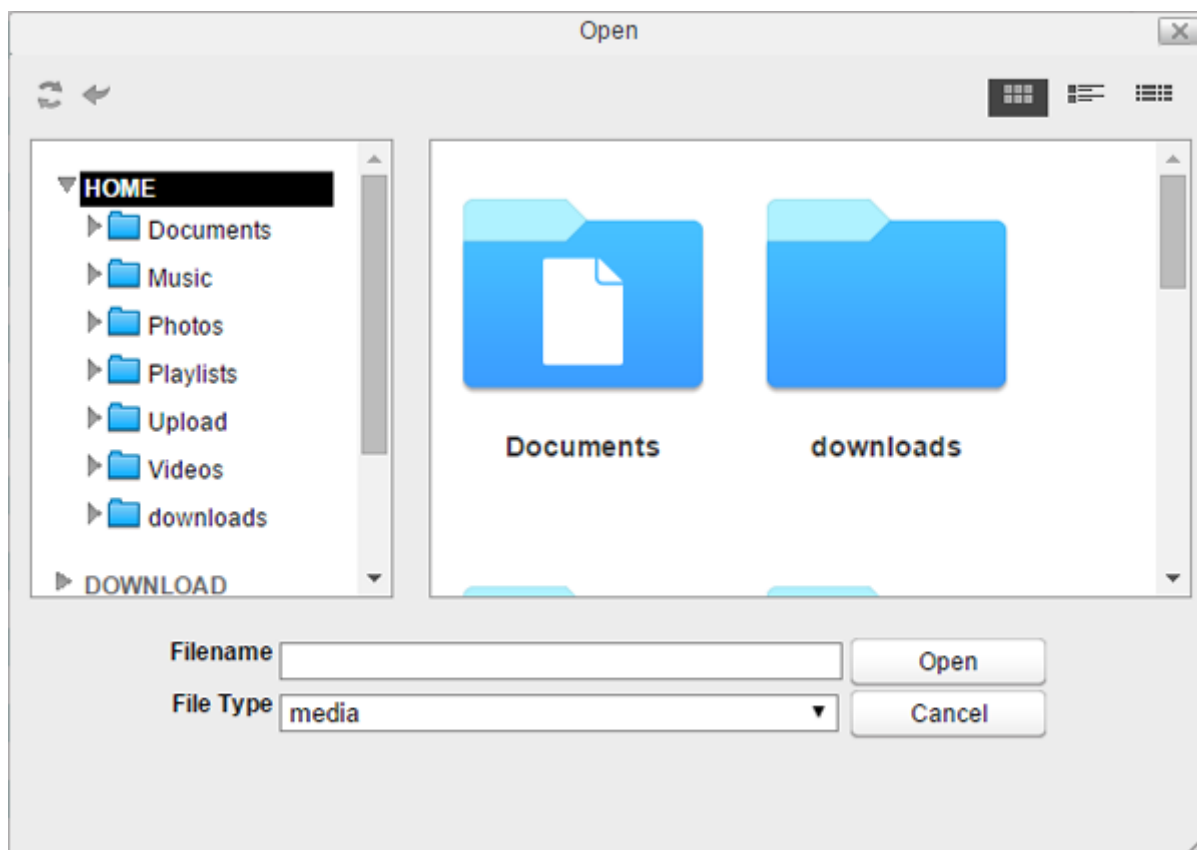

The media file is now added to the playlist.

Playing Files

Media Player supports MP3 or MP4 file playback on the browser. Some specific MP4 files may not be compatible. Other file types will be downloaded to the desired location in your computer.

1 Select the playlist at the left of the window and click *Play*.

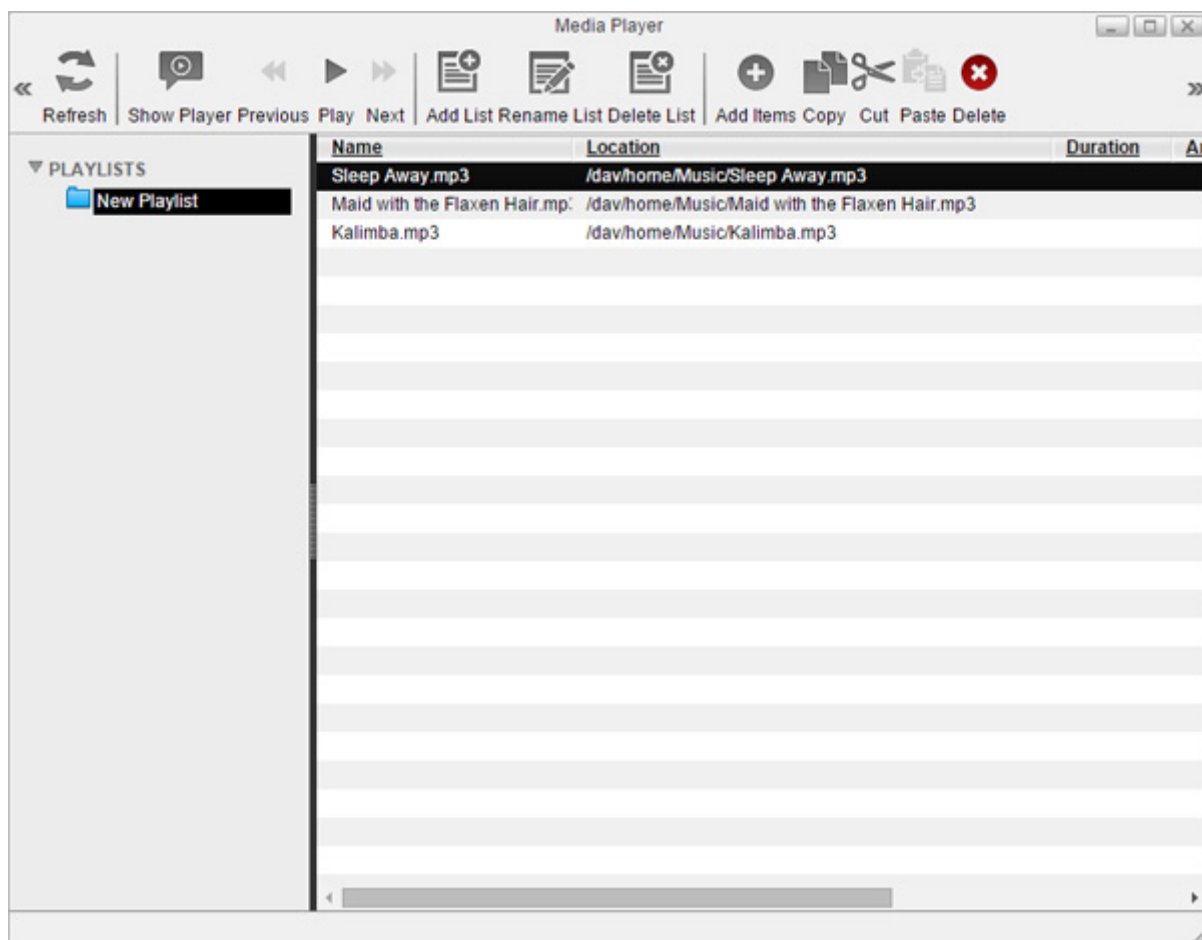

2 Media Player will open and start playing media files. To return to the playlist, click *Show Player*.

Chapter 5 Disk Manager

Disk Manager is an application that manages RAID arrays and internal or external drives. To open Disk Manager, click



the icon from the home screen.

RAID Arrays

The default RAID mode for LS520D is RAID 1.

RAID 1

Combines 2 drives from hard drives into a mirrored RAID array. The available space in the array is the capacity of a single drive. Identical data is written to each drive. If a drive becomes damaged, data can be recovered by replacing the damaged drive. As long as one drive in the array remains undamaged, all data in the array can be recovered.

RAID 0

Combines 2 drives into a single RAID array. The available space is the total capacity of all drives used. This simple RAID mode offers faster performance than RAID modes that include parity. If a single drive in the array fails, then all data in the array is lost.

Linear

Combines all drives from hard drives into a single virtual drive. For this virtual drive, data will be written onto the first drive, then to the next drive when the first drive becomes full, and so on. The available space is the total capacity of all drives used. Linear mode offers no redundancy. If any drive becomes damaged, data on the drive will be lost.

JBOD

This mode uses the hard drives inside the LinkStation as individual drives. The available space is the total of all drives in the LinkStation. If any drive becomes damaged, then the data on that drive is lost.

Working with RAID Arrays

Note: If you change the RAID mode, all data on the array is deleted. This is true for every procedure in this chapter. Always back up any important data before performing actions that affect your RAID array.

Using JBOD

With JBOD, each hard drive in the LinkStation is addressed separately. To put drives from an array into JBOD mode, follow the procedure below.

1 In Disk Manager, click the *RAID* tab.

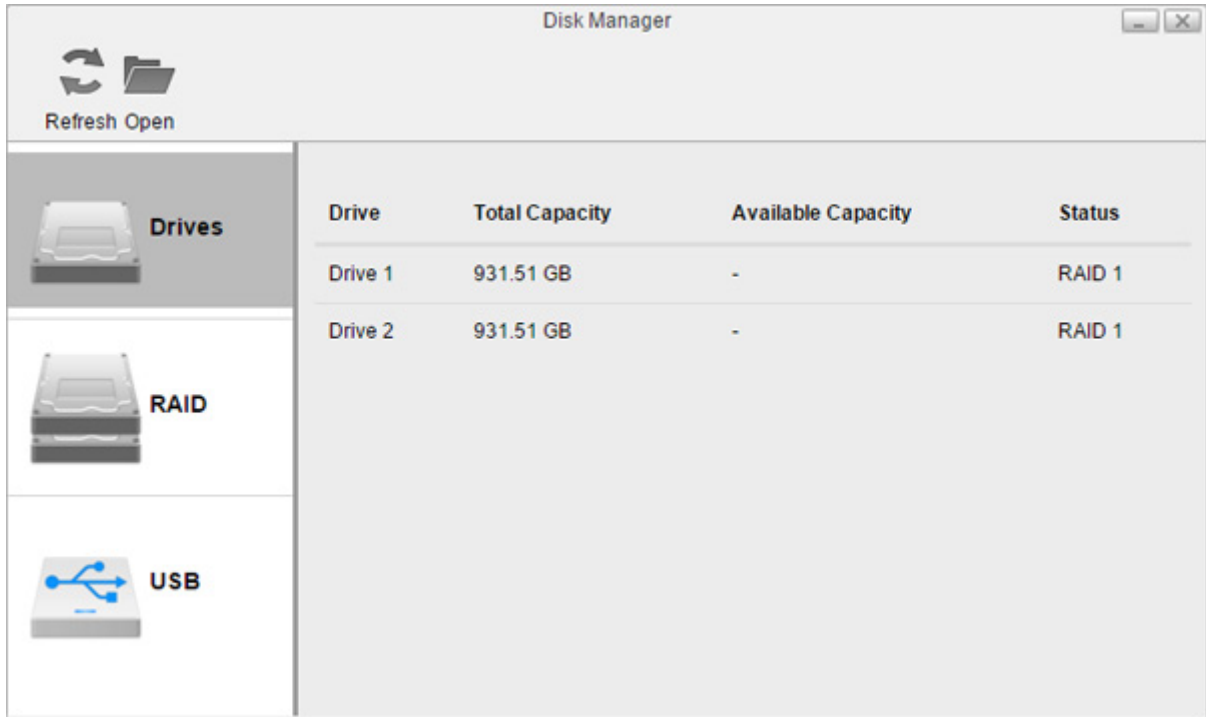

2 Click the array to delete.

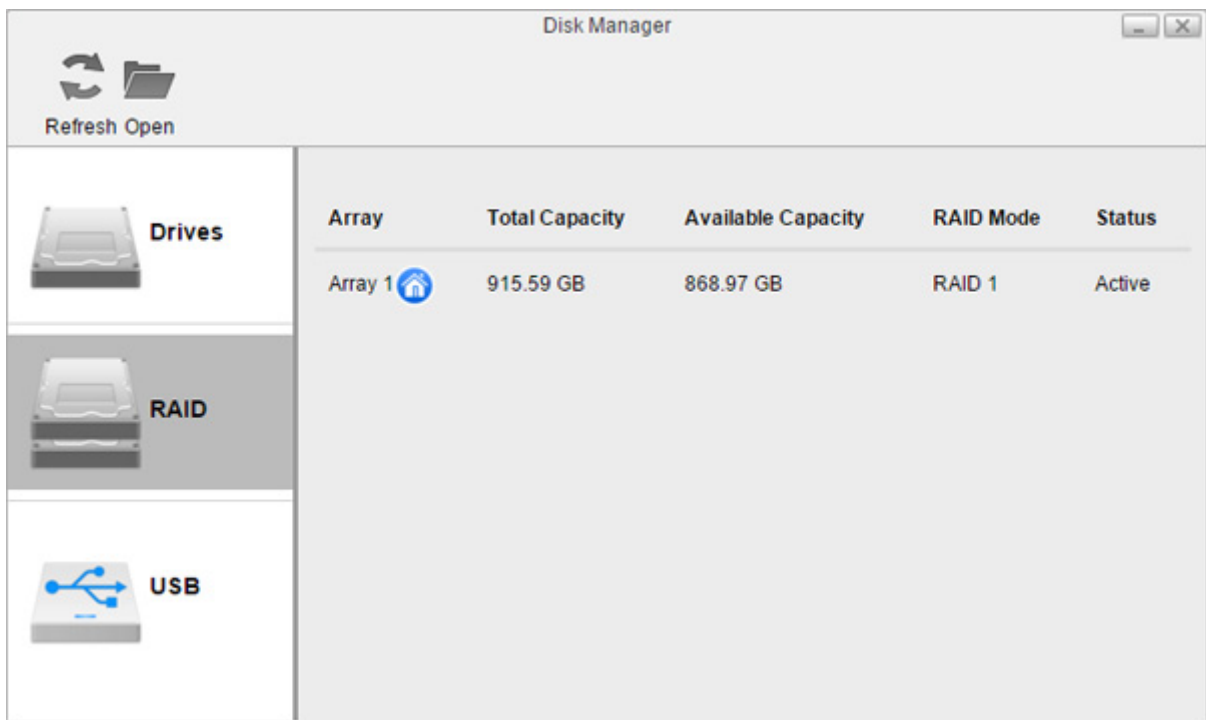

3 Click *Delete*.



4 Two different warnings will be displayed. Read them carefully and click *Yes* for both.

5 From the *Drives* tab, select the drive and click *Format*.

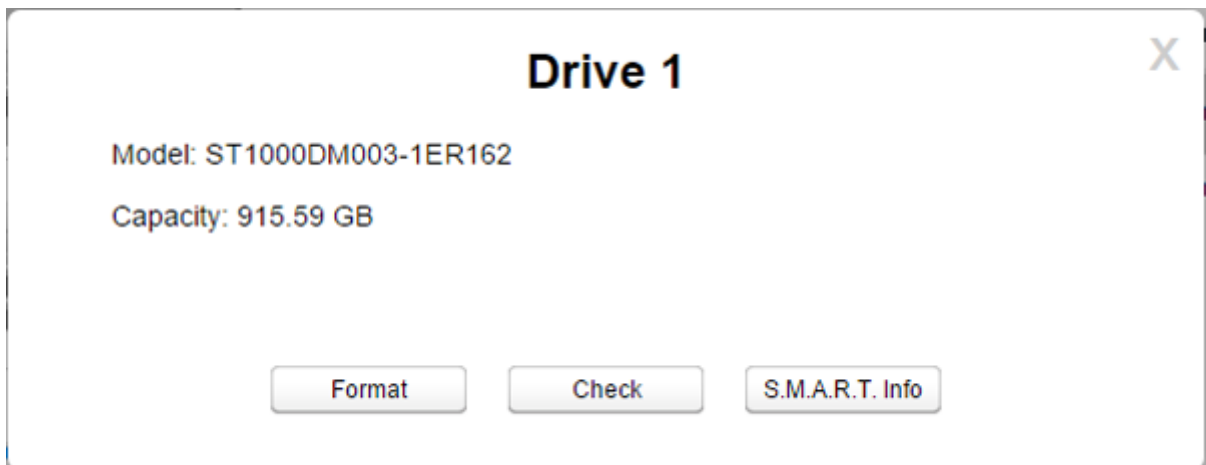

6 Select the file system from the drop-down menu and click *Format*.

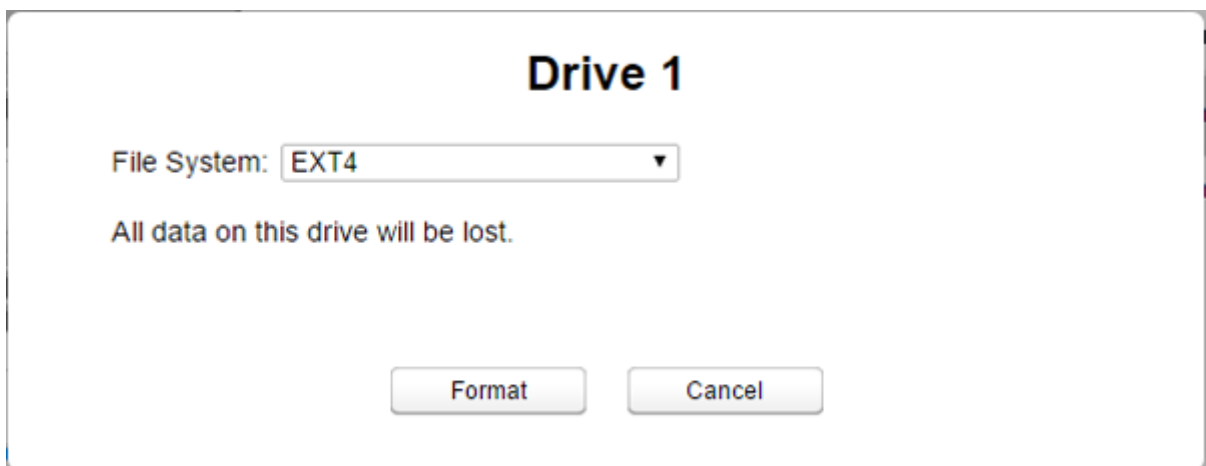

7 When the format is finished, click *OK*, then *Close*.

8 To format another drive, repeat steps 5 to 7.

Once JBOD is configured, the default shared folders will automatically be created only on the drive that is initially formatted. Create shared folders on the other drives, referring to the "Folder Setup" section in chapter 7 for the procedure.

Changing RAID Mode

To change the RAID mode, first delete the current RAID array. Follow the procedure below.

Note: You can also configure the RAID settings, including changing the RAID mode, using the initial setup wizard, but you will lose all settings on the LinkStation.

To launch the initial setup wizard, initialize the LinkStation settings from *System Settings - Reset*, then follow the procedure on the screen to finish changing the RAID mode.

1 In Disk Manager, click the *RAID* tab.

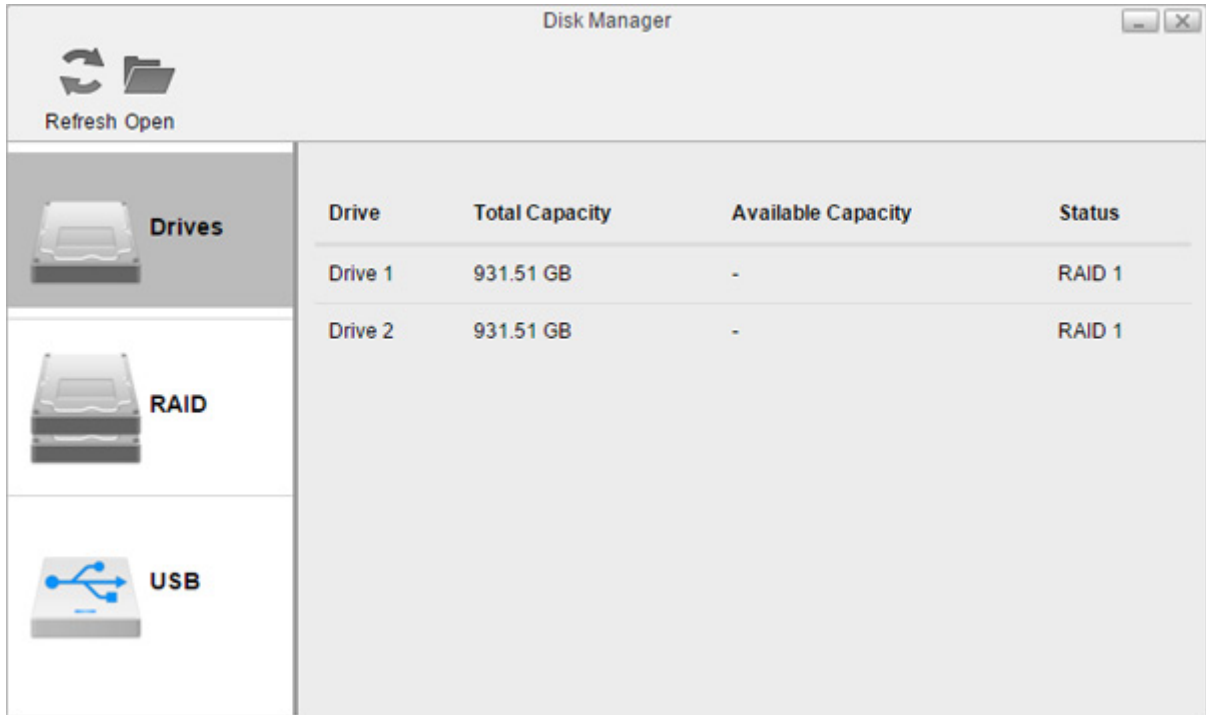

2 Click the array to delete. If no array is listed, the array has already been deleted. Skip to step 5.

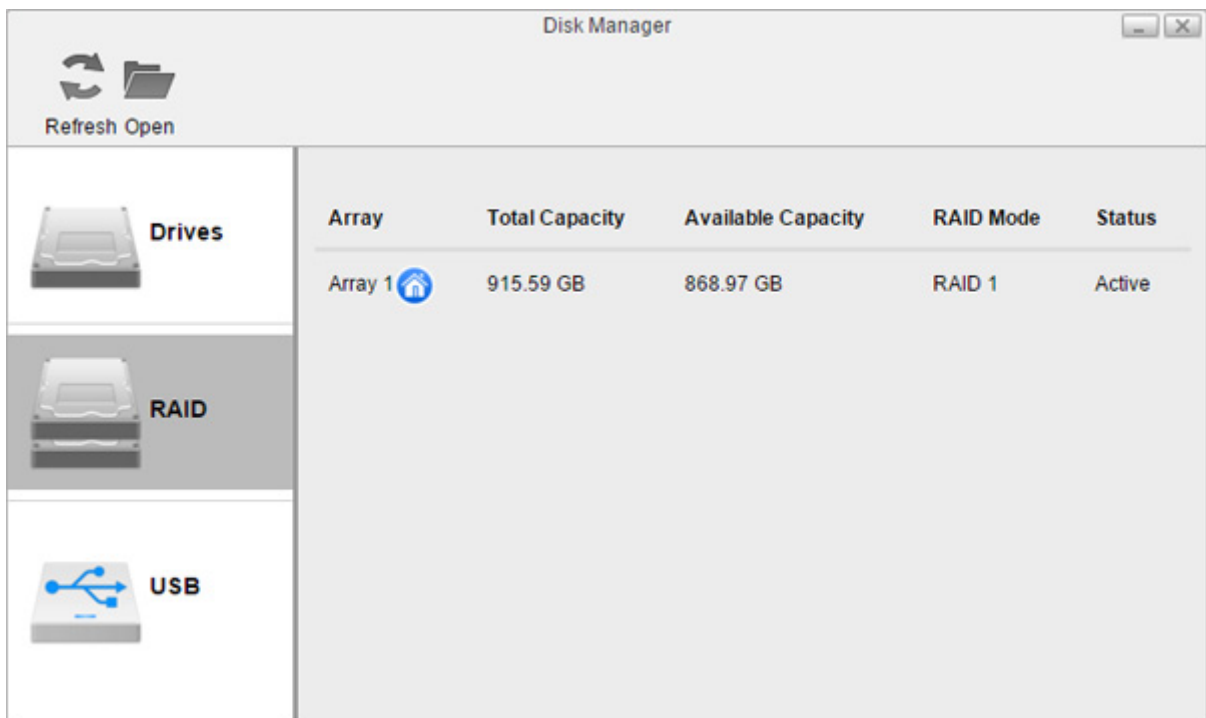

3 Click *Delete*.



4 Two different warnings will be displayed. Read them carefully and click Yes for both.

5 Click *Create RAID Array*.

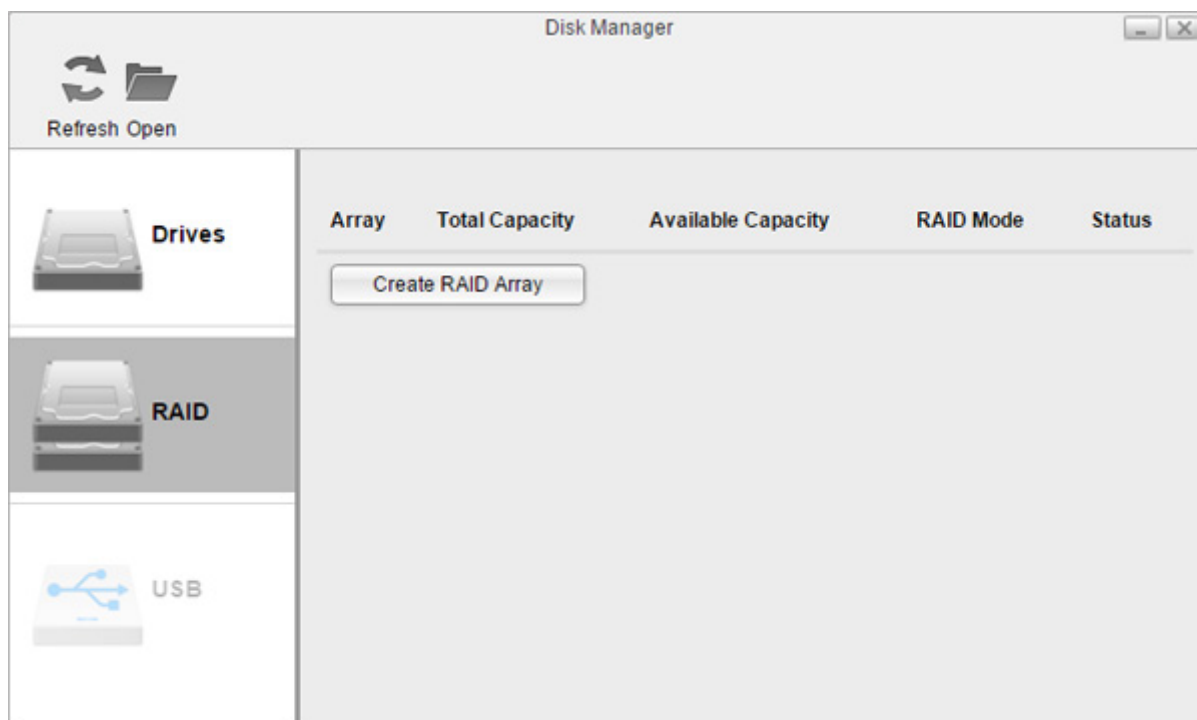

6 Select a RAID mode and click *Next*.

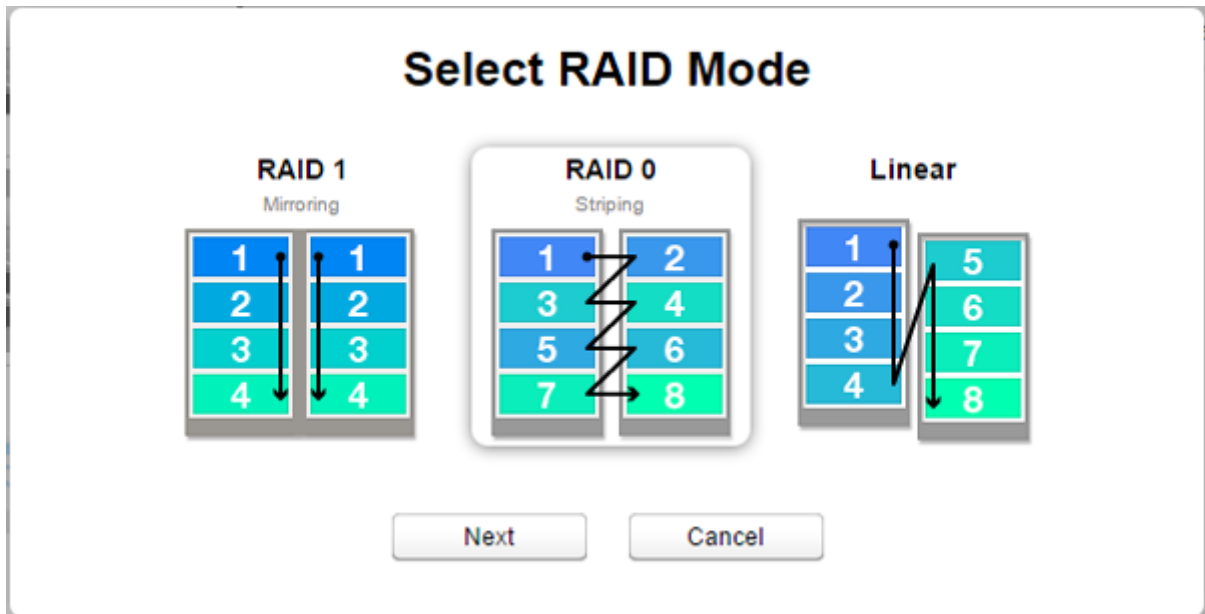

7 Click *Yes*.

8 RAID array creation will start. Wait until it's done. When it's finished, click *OK*, then *Close*.

Once the RAID array is configured, create shared folders on the array to use them. Refer to the "Folder Setup" section in chapter 7 for the procedure.

Expanding RAID Array Capacity

If the hard drives in your LinkStation are in a RAID 1 array with two drives or they are in degraded mode, you can expand the RAID array capacity without erasing the data on the drives. To expand the capacity, you should have two new drives with capacity larger than the remaining drive.

1 Shut down the LinkStation and remove one of the drives. Do not remove both drives at the same time.

2 Insert a new drive (larger capacity than remaining drive) and turn on the LinkStation.

3 When the power LED glows white or blinks amber, hold down the function button on the back of the LinkStation for 5 seconds.

4 The LinkStation will start rebuilding the RAID array. After a few minutes, the I18 message will be displayed in NAS Navigator2. Wait until the drive finishes rebuilding; the I18 message will be extinguished.

5 After the RAID array is rebuilt, shut down the LinkStation again and remove another drive.

6 Insert another new drive and turn it on.

7 When the power LED blinks amber, hold down the function button on the back of the LinkStation for 5 seconds.

8 The LinkStation will start rebuilding the RAID array again. Wait until the I18 message is extinguished like step 4 above.

9 After the I18 message disappears, open Settings and click *Disk Manager*.

10 Click the *RAID* tab and the RAID array to make the capacity larger.

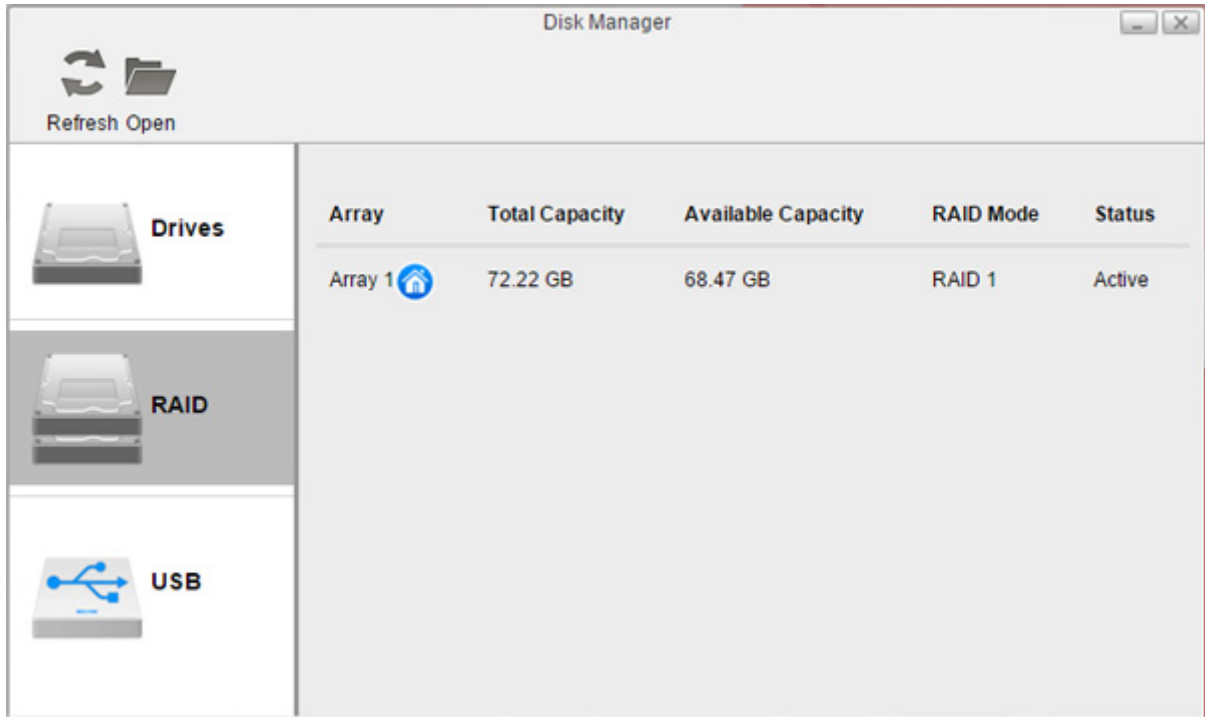

11 Click *Expand*.



12 Read the warning message carefully and click *Yes*.

13 The RAID array will be rebuilt and its capacity will expand. The power LED will blink amber and I18 and I46 messages will be displayed. Wait until those messages disappear and the power LED returns to a steady white.

Adding an External Hard Drive

The LinkStation includes a USB port and you can connect an external drive or USB storage device to this port. For external drives, Buffalo USB drives are recommended. The following file systems for external drives are supported: ext2, ext3, ext4, FAT32, exFAT, NTFS, HFS Plus

Connect only one device to a USB port. Some external drives with automatic power-on doesn't turn on automatically when connected to the LinkStation. Use their manual switch to turn them on. Be sure to connect only one bus-powered drive at a time. If there is insufficient bus power for your USB drive, connect its AC adapter.

Note: This LinkStation will not recognize USB drives that are larger than 16 TB. Use only USB drives that are 16 TB or less.

Dismounting an External Drive

If the LinkStation is powered on, dismount an external drive before unplugging it. You may dismount the external drive from Settings. If the LinkStation is off, then the external drive is already dismounted and may be unplugged safely.

Dismounting Using the Eject Button

- 1 Click the  icon at the upper right corner of the home screen toolbar.
- 2 Select the device to dismount and click *Eject*.

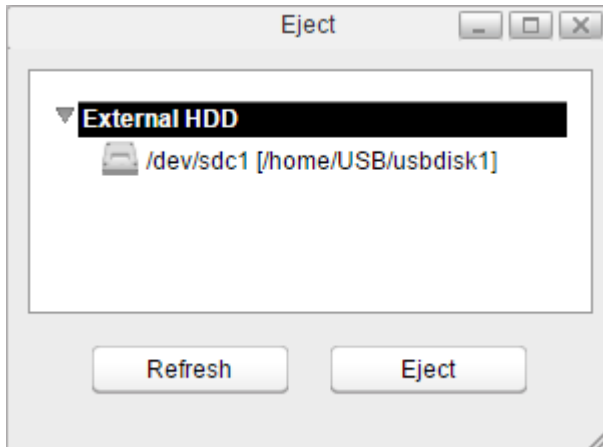

- 3 The external drive will be dismounted.

Once the drive is dismounted, unplug it from the LinkStation.

Dismounting Using Disk Manager

- 1 In Disk Manager, click the *USB* tab.

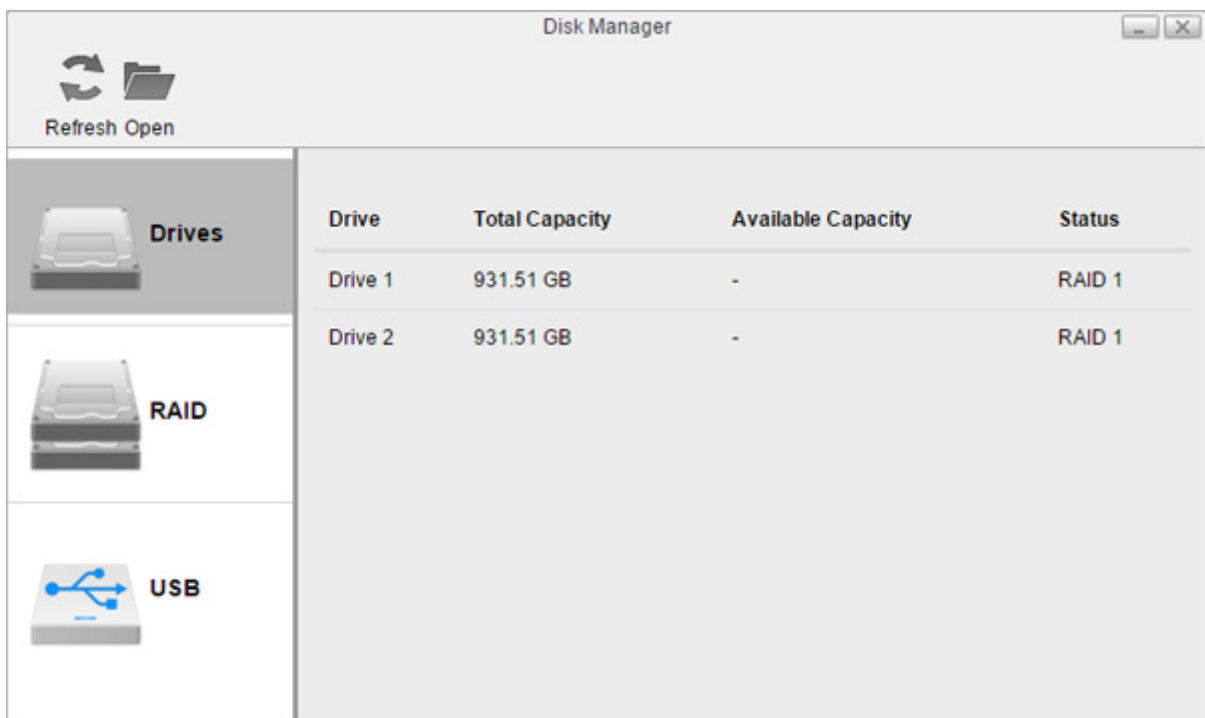

2 The drive information will be displayed. Click the external drive to be dismounted.

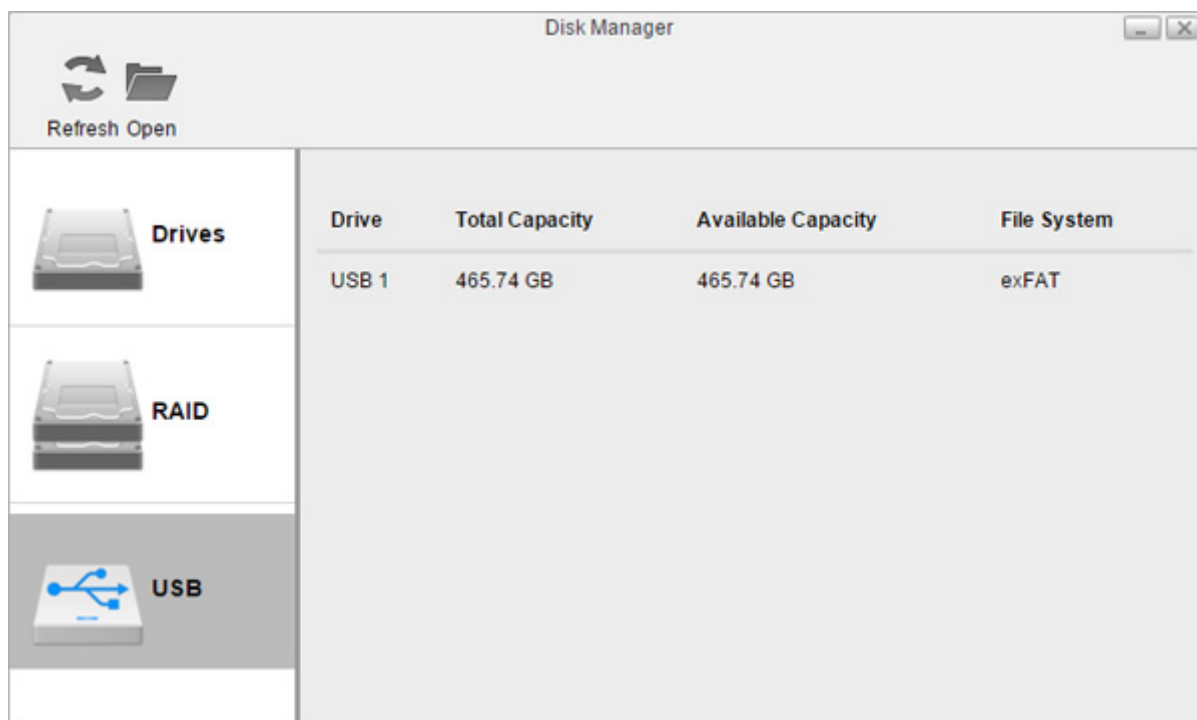

3 Click *Eject*.

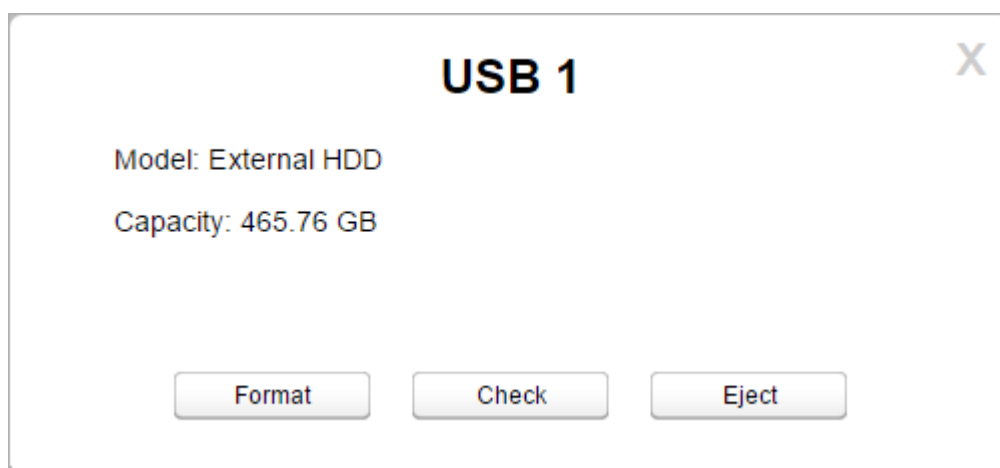

4 The external drive will be dismounted.

Once the drive is dismounted, unplug it from the LinkStation.

Formatting Drives

Note: Since the firmware version 3.00, the hard drive that used to be used on the different LS500 series is necessary to format when it's inserted.

- 1 In Disk Manager, click the *RAID* tab, or the *Drives* tab if no RAID array is configured, to format an internal drive or the *USB* tab to format an external drive.

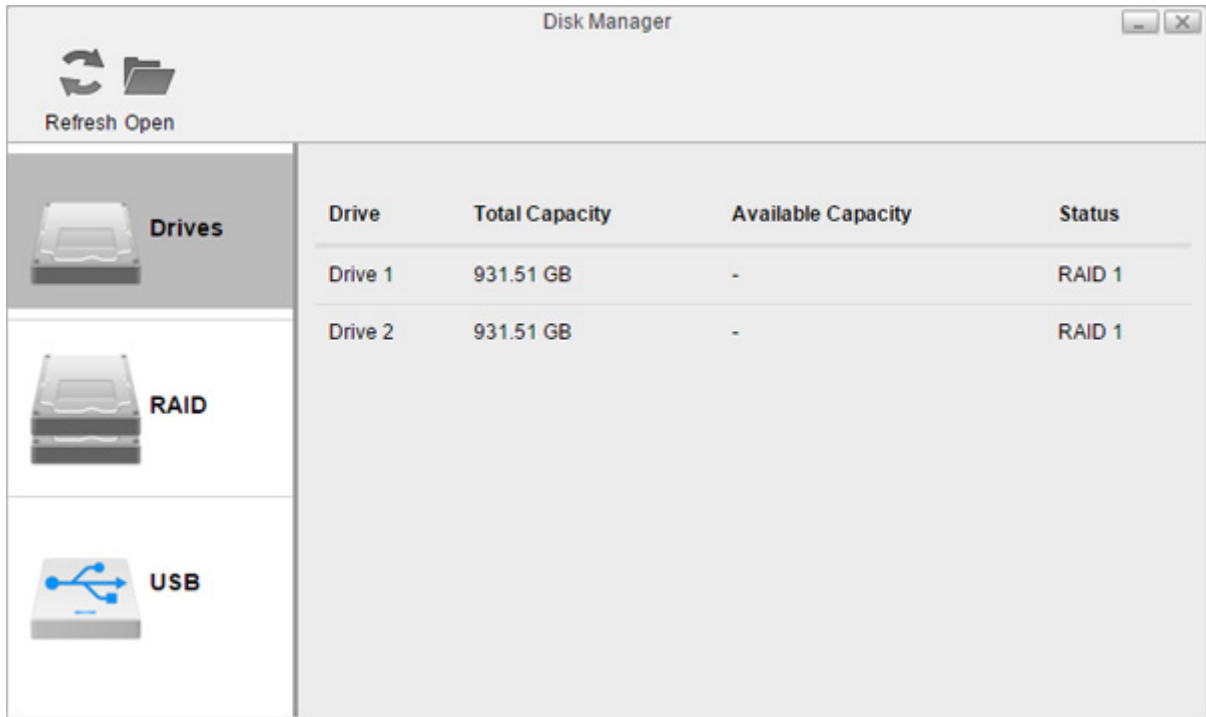

- 2 Click the array or drive to format.

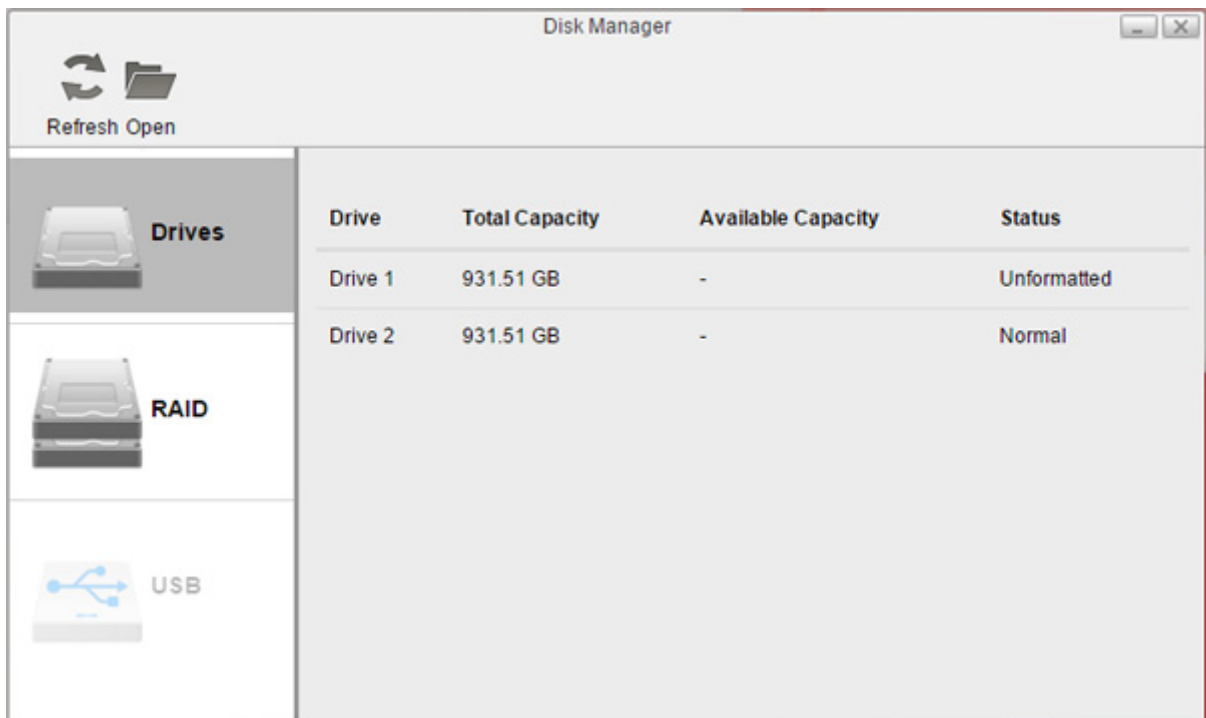

3 Click *Format*.

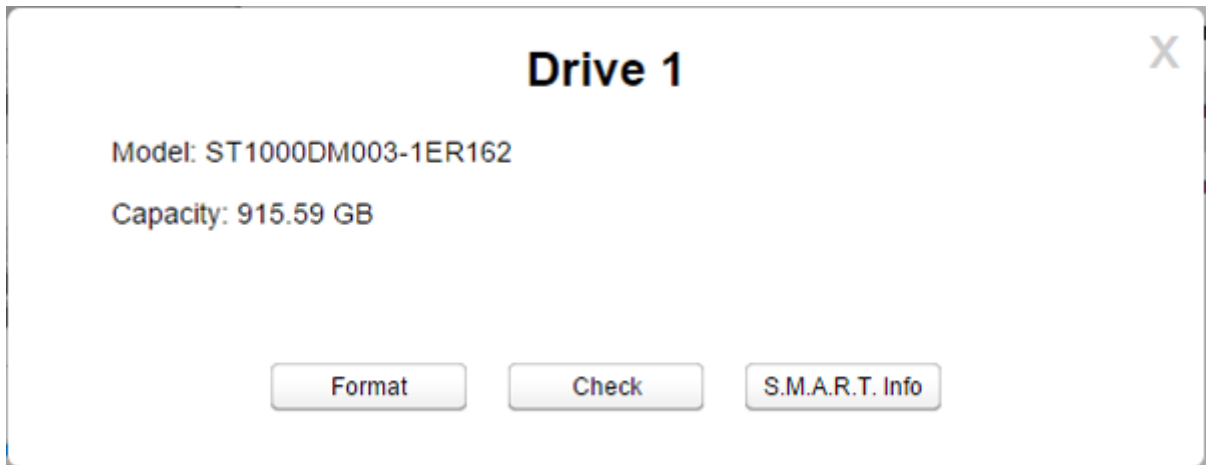

4 Select a file system from the drop-down list and click *Format*.

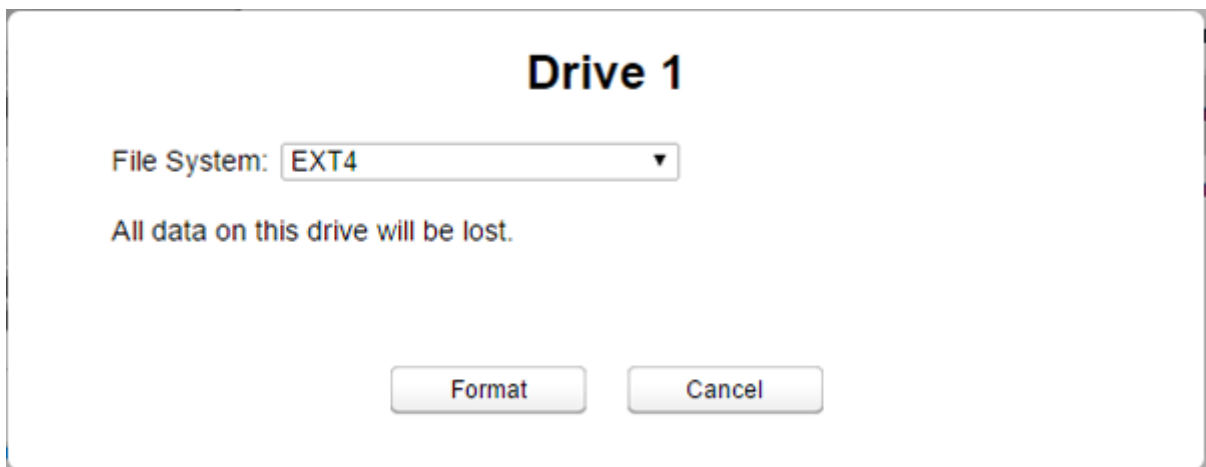

5 When formatting is finished, click *OK*, then *Close*.

Notes:

- Do not turn off the LinkStation or disconnect a hard drive while formatting.
- The following file systems can be formatted from Settings.

Internal Hard Drive	ext4
External Hard Drive	ext3, ext4, exFAT

Hard Drive Replacement

If a drive fails, NAS Navigator2 and Settings will show an error message. The hard drive will need to be replaced for the unit to function properly. After the drive is replaced, you will need to rebuild the RAID array.

Notes:

- While the LinkStation is powered on, never unplug or remove drives without dismounting them first, and never replace a running drive. Power down the LinkStation before changing the drive.
- For the replacement drive, use a Buffalo OP-HDBST series drive. If using LS520DE, you can also use a compatible other manufacturers' drives listed on the Buffalo website.

The new drive should be the same size or larger as the replaced drive. If a larger drive is used, the extra space will not be usable in a RAID 0 array. However with RAID 1, you can expand current RAID array capacity if you replace a drive with a larger-sized hard drive. To expand the capacity, refer to the "Expanding the RAID Array Capacity" section above for the procedure.

- If there is existing data on the replacement drive, back it up as all data on the drive will be lost during the replacement process.
- If sending a defective drive to Buffalo for replacement, please keep the cartridge as Buffalo will only replace the hard drive and not the cartridge.
- To avoid damaging the LinkStation with static electricity, ground yourself by touching something made of metal before handling any sensitive electronic parts.
- Do not change the order of the hard drives in the LinkStation. For example, pulling out drive 1 and replacing it with drive 2 may cause data to be corrupted or lost.

Step 1 - Replacing a Hard Drive

1 Turn the LinkStation off and remove all cables.

2 Squeeze the left side of the front panel and swing it open.

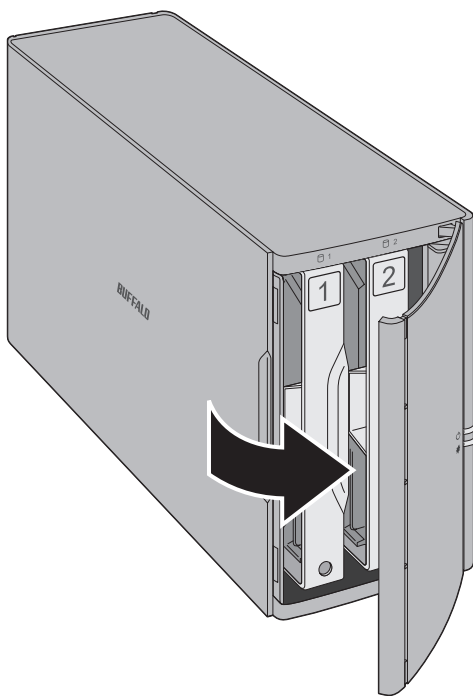

3 Push the failed drive's cartridge up and remove it from the LinkStation.

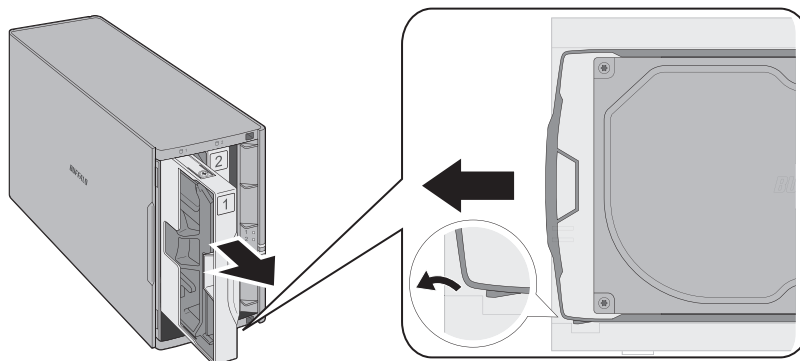

Notes:

- Do not press hard on the top of the LinkStation.
- Pull the drive straight out the front of the chassis.

4 Remove the drive from the cartridge.

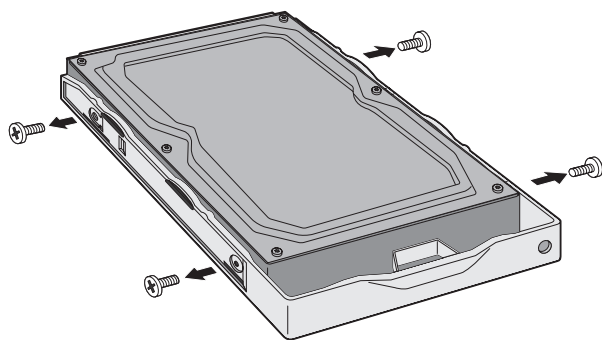

5 Install a new drive in the cartridge.

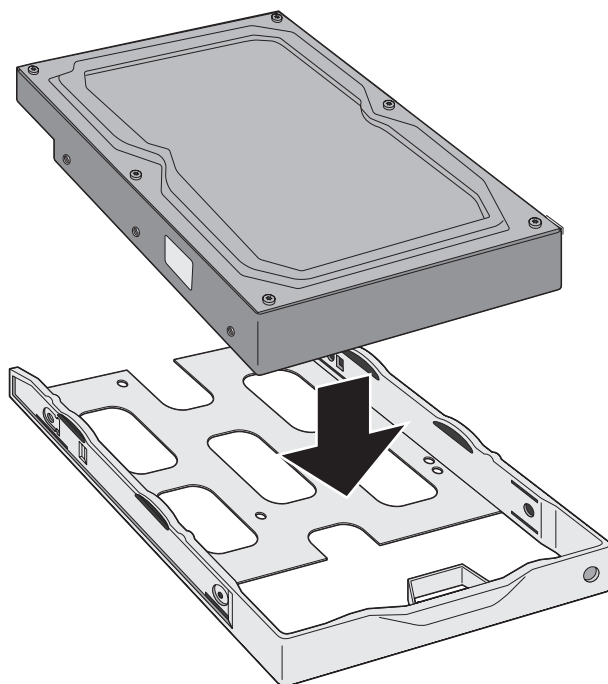

6 Replace the four screws.

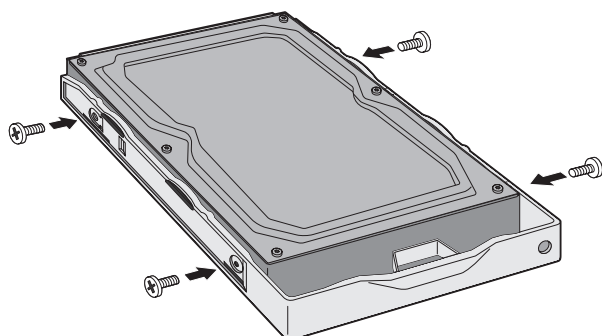

7 Insert the new drive into the empty slot.

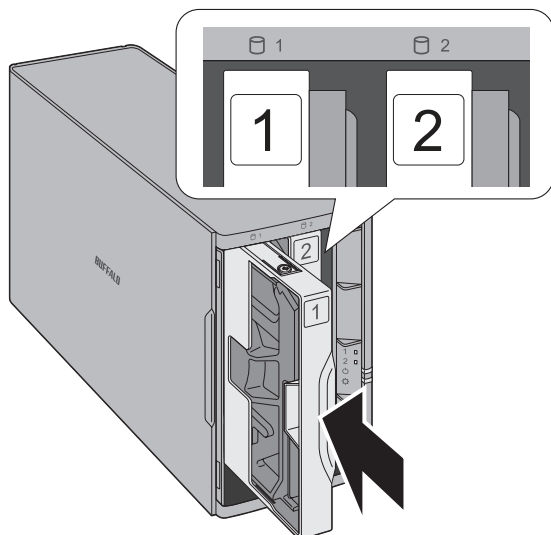

8 Close the front panel.

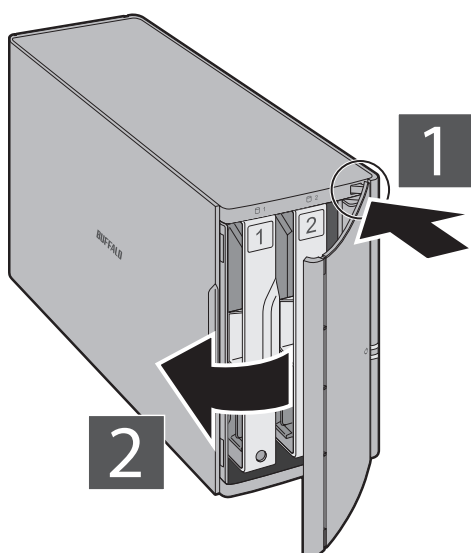

9 Connect all cables, then turn on the LinkStation.

Step 2 - Rebuilding the RAID Array

Depending on your RAID mode, the rebuilding procedure will be different. Follow the corresponding procedure below that matches your RAID mode.

Using RAID 1

1 Follow the drive replacement procedure described above and replace the failed drive with a new drive.

2 Hold down the function button on the back of the LinkStation for 5 seconds.

- 3 The LinkStation will start rebuilding the RAID array. After a few minutes, the I18 message will be displayed in NAS Navigator2. Wait until the drive finishes rebuilding; the I18 message will be extinguished.

Using RAID 0 or Linear

- 1 Follow the drive replacement procedure described above and replace the failed drive with a new drive.
- 2 Open Settings and click *Disk Manager*.
- 3 The error message below will be displayed due to a new drive being inserted. Click *OK*.

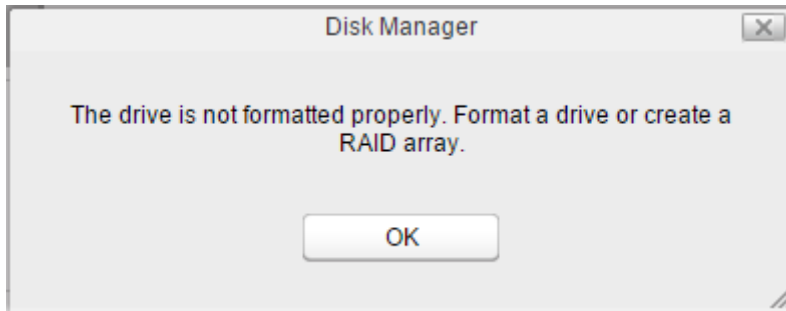

- 4 Click the *RAID* tab, then *Create RAID Array*.

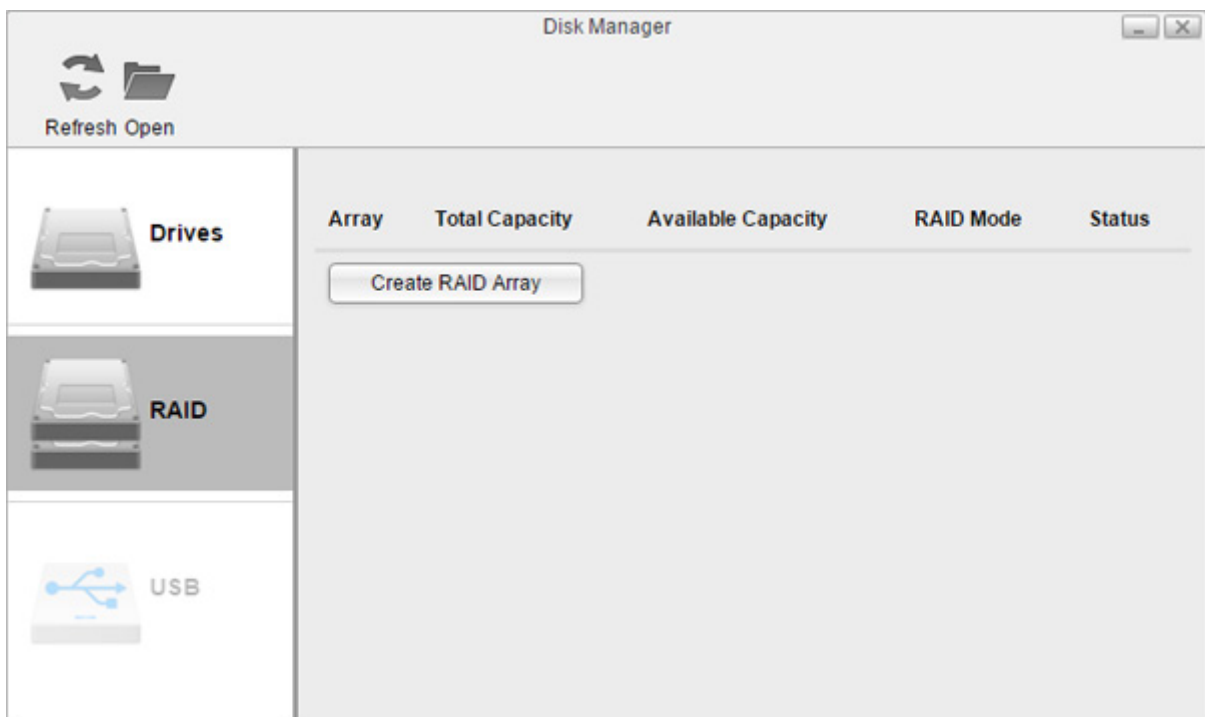

5 Select a RAID mode and click *Next*.

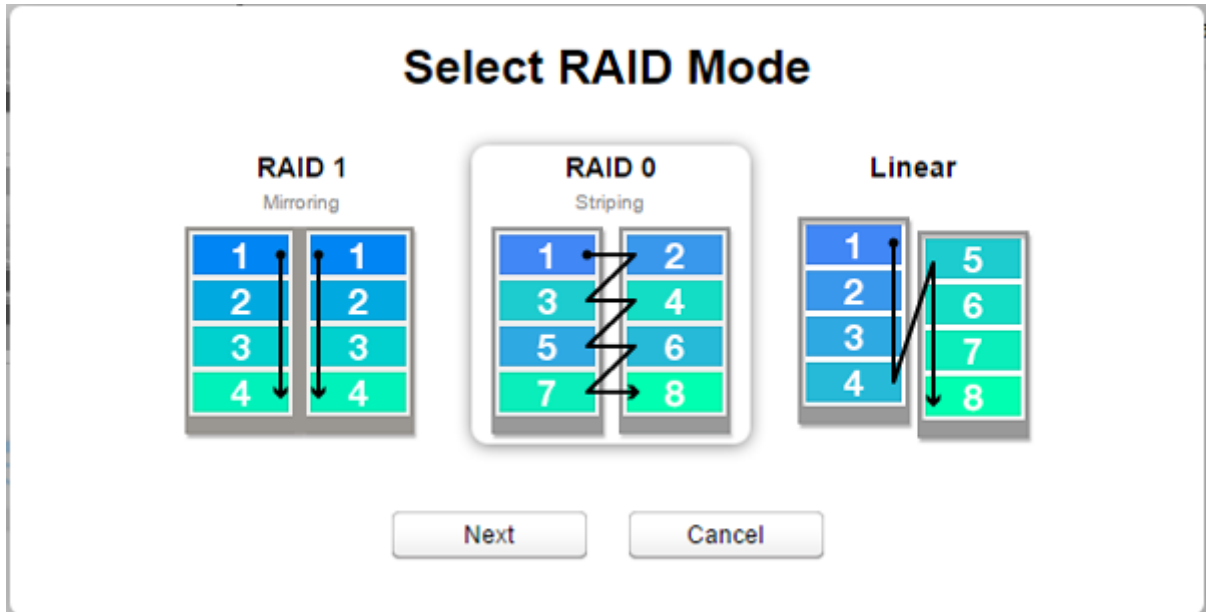

6 Click *Yes*.

7 RAID array creation will start. Wait until it's done. When it's finished, click *OK*, then *Close*.

Once the RAID array is configured, create shared folders on the array to use them. Refer to the "Folder Setup" section in chapter 7 for the procedure.

Using JBOD

If the drive that was initially formatted fails, the LinkStation will not be accessible unless the drive is replaced.

1 Follow the drive replacement procedure described above and replace the failed drive with a new drive.

2 Open *Settings* and click *Disk Manager*.

3 The error message below will be displayed due to a new drive being inserted. Click *OK*.

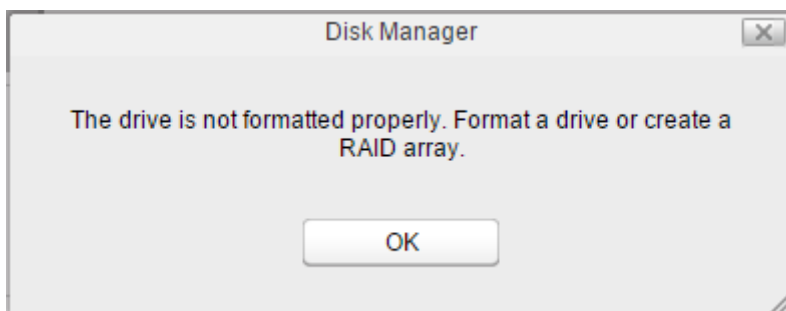

4 Select a drive that shows "Unformatted" and click *Format*.

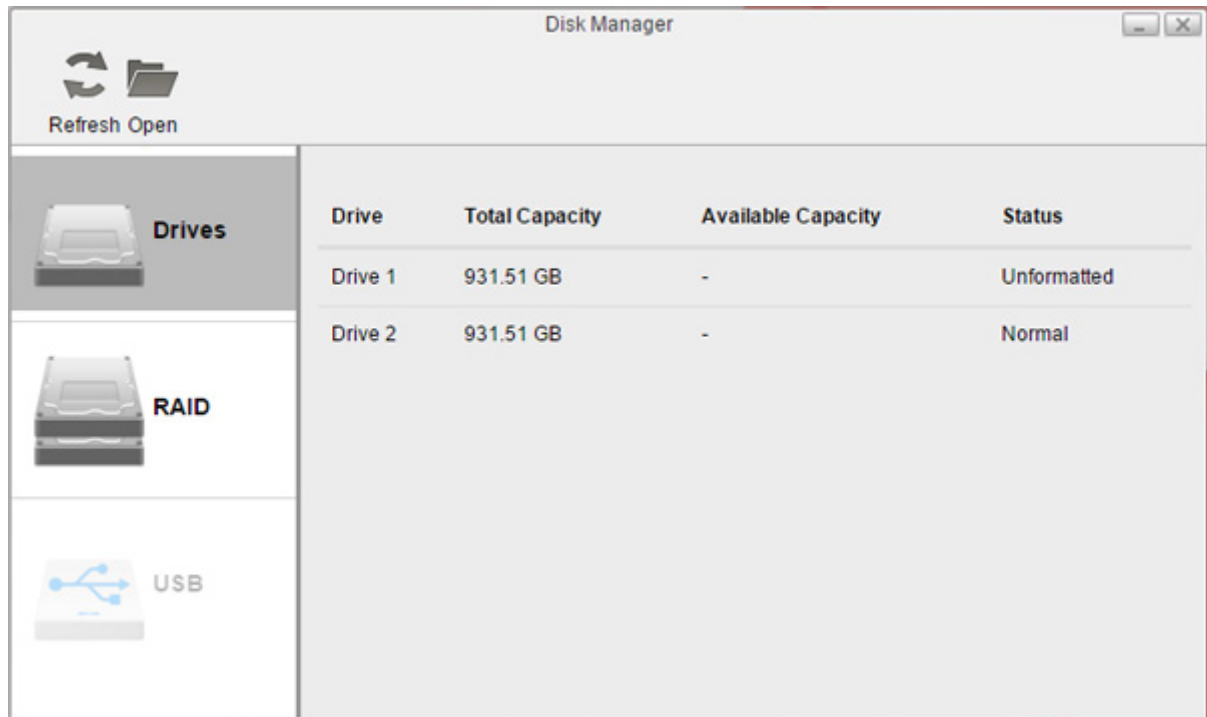

5 Select a file system from the drop-down list and click *Format*.

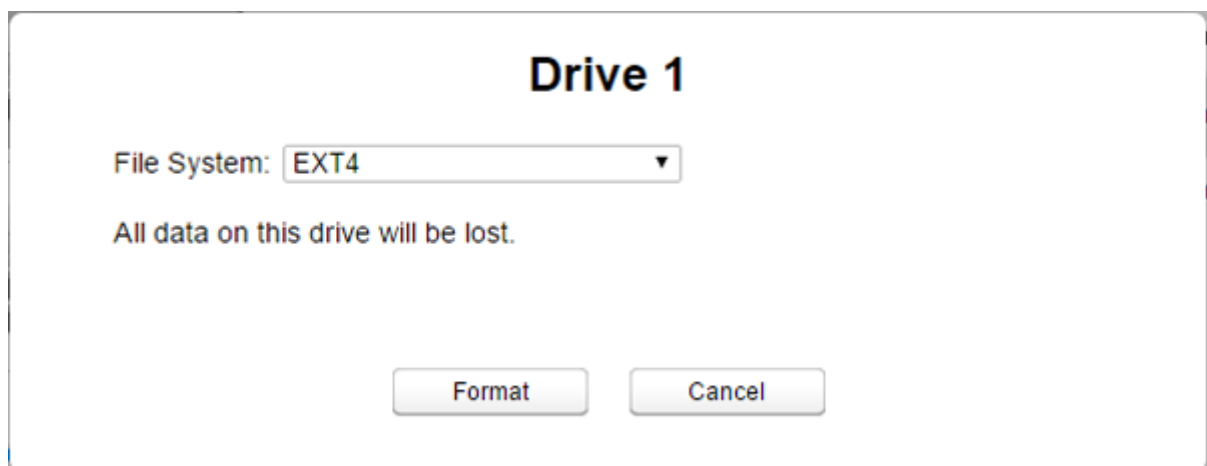

6 When the format is finished, click *OK*, then *Close*.

Once the drive is formatted, create shared folders on the drive to use them. Refer to the "Folder Setup" section in chapter 7 for the procedure.

Chapter 6 System Information



Click the  icon in the main menu to open "System Settings".

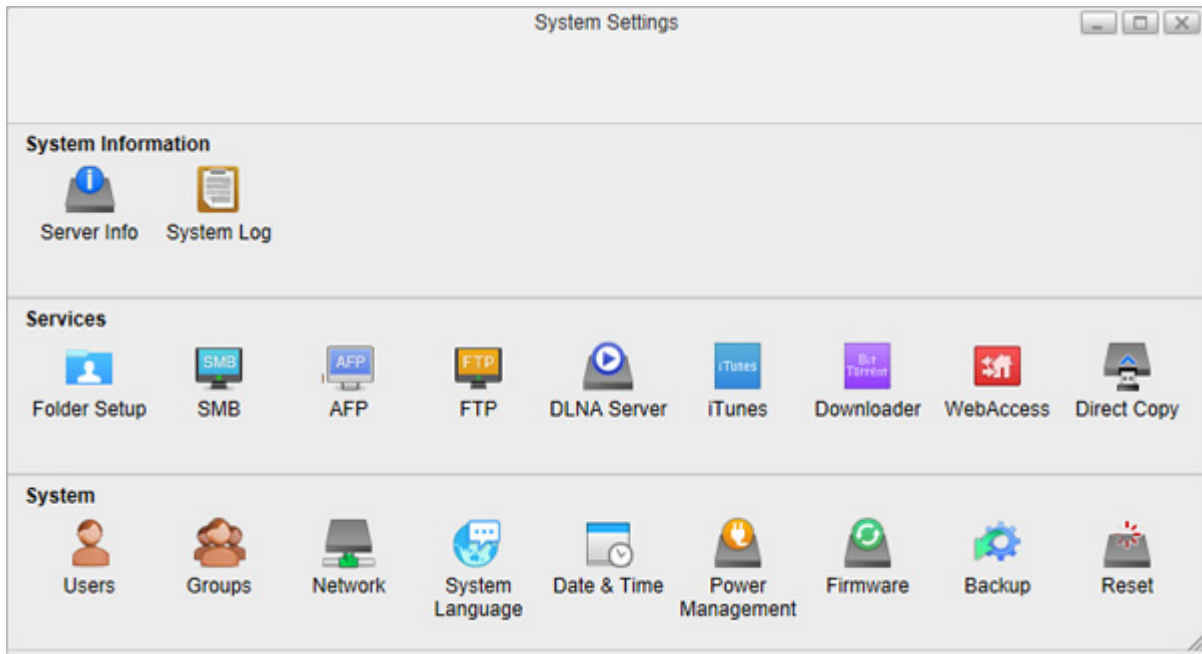

Server Info

Displays the hostname, workgroup name, IP address, MAC address, firmware version, time, and other minor system information.

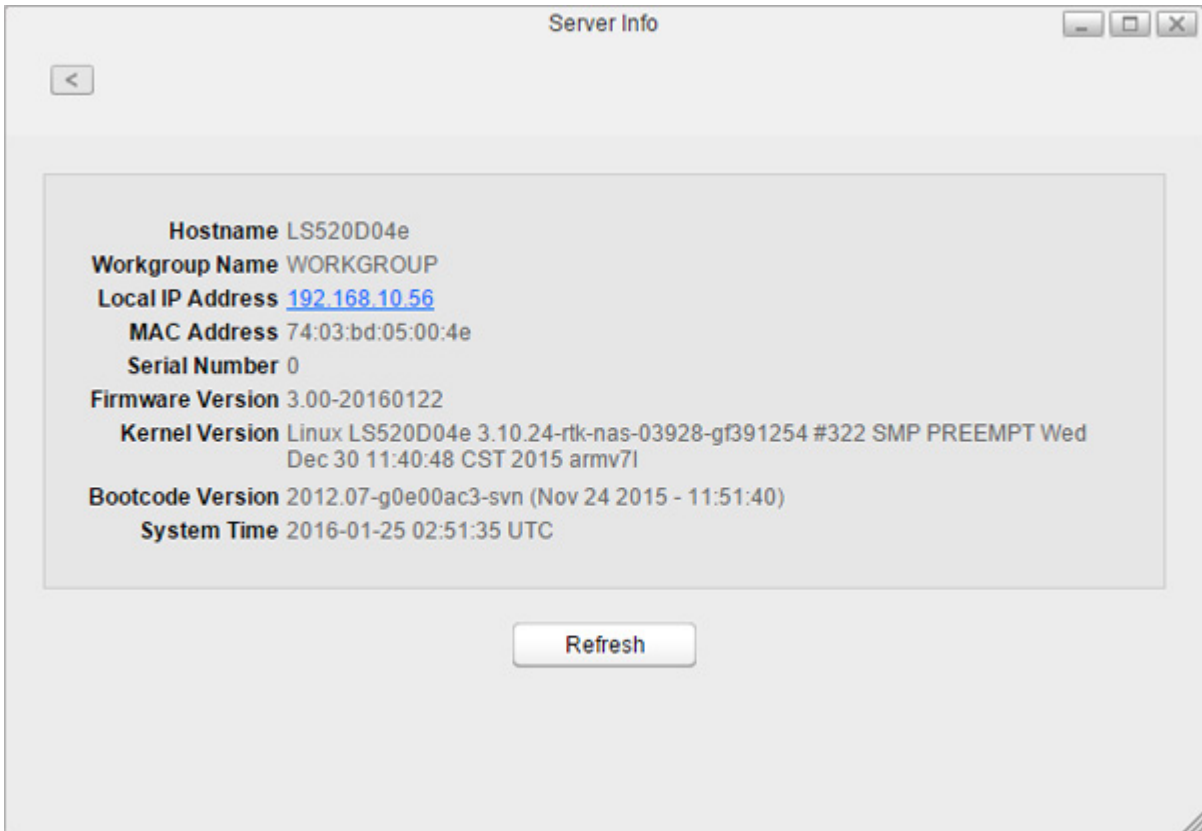

To open the Server Info window, click *Server Info* in System Settings.

System Log

Displays multiple logs of the LinkStation.

To open the System Log window, click *System Log* in System Settings.

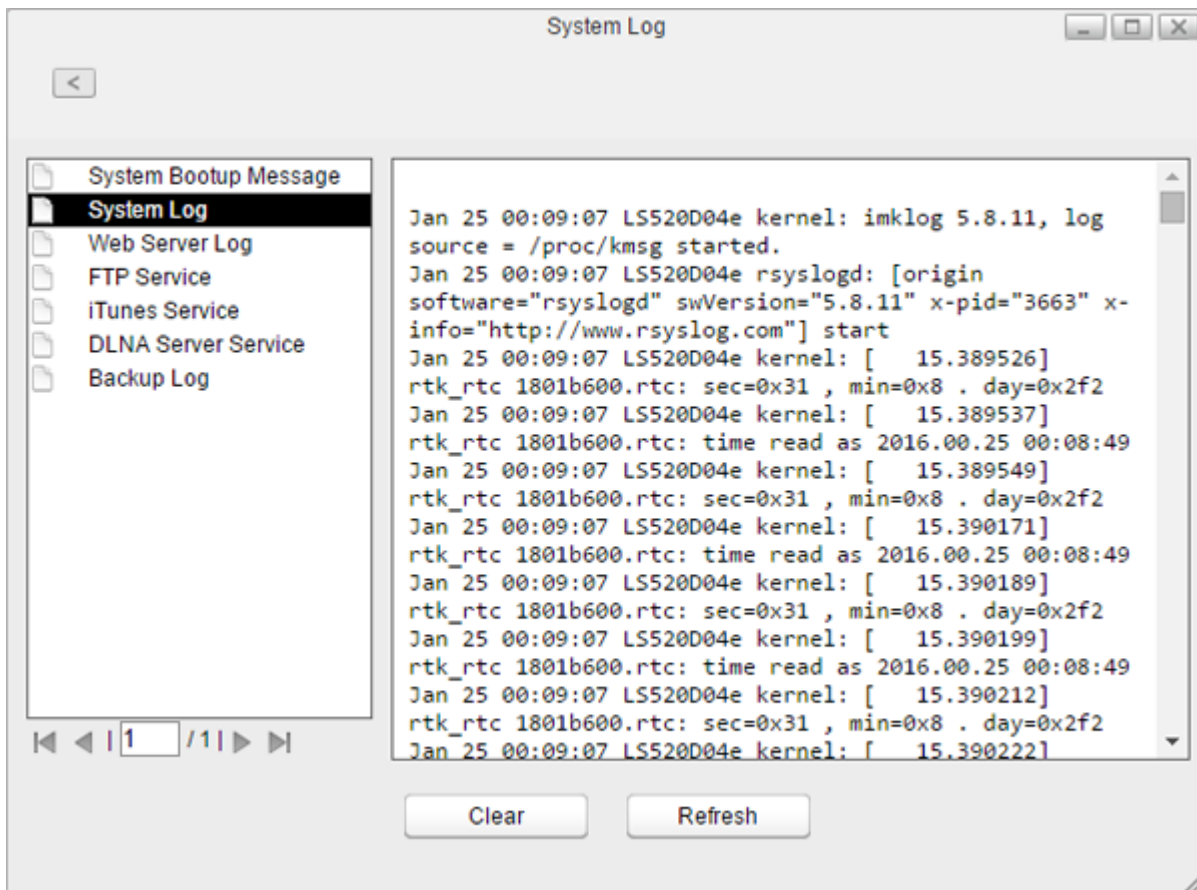

Note: Up to 10 latest logs will be kept in the LinkStation.

Chapter 7 Services

Folder Setup

Create or delete shared folders in the LinkStation and enable or disable protocol services.

Adding Shared Folders

- 1 In Settings, click *System Settings*.
- 2 Click *Folder Setup*.

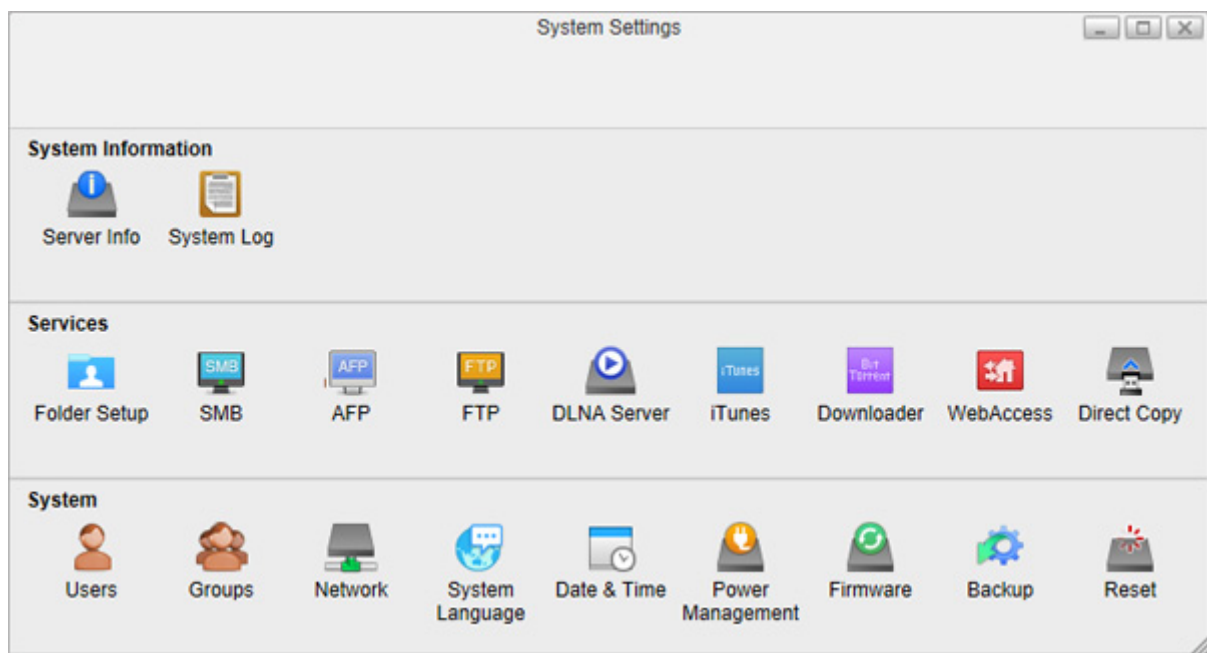

3 Click *Add*.

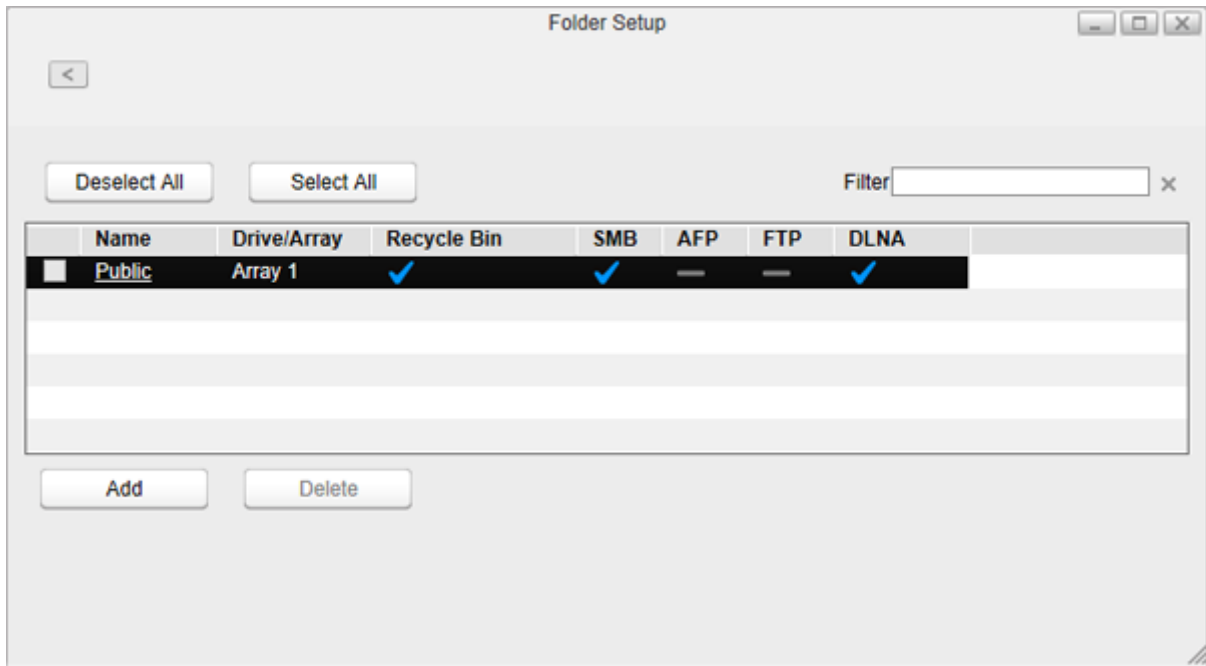

4 Enter a folder name and configure the desired settings, then click *OK*.

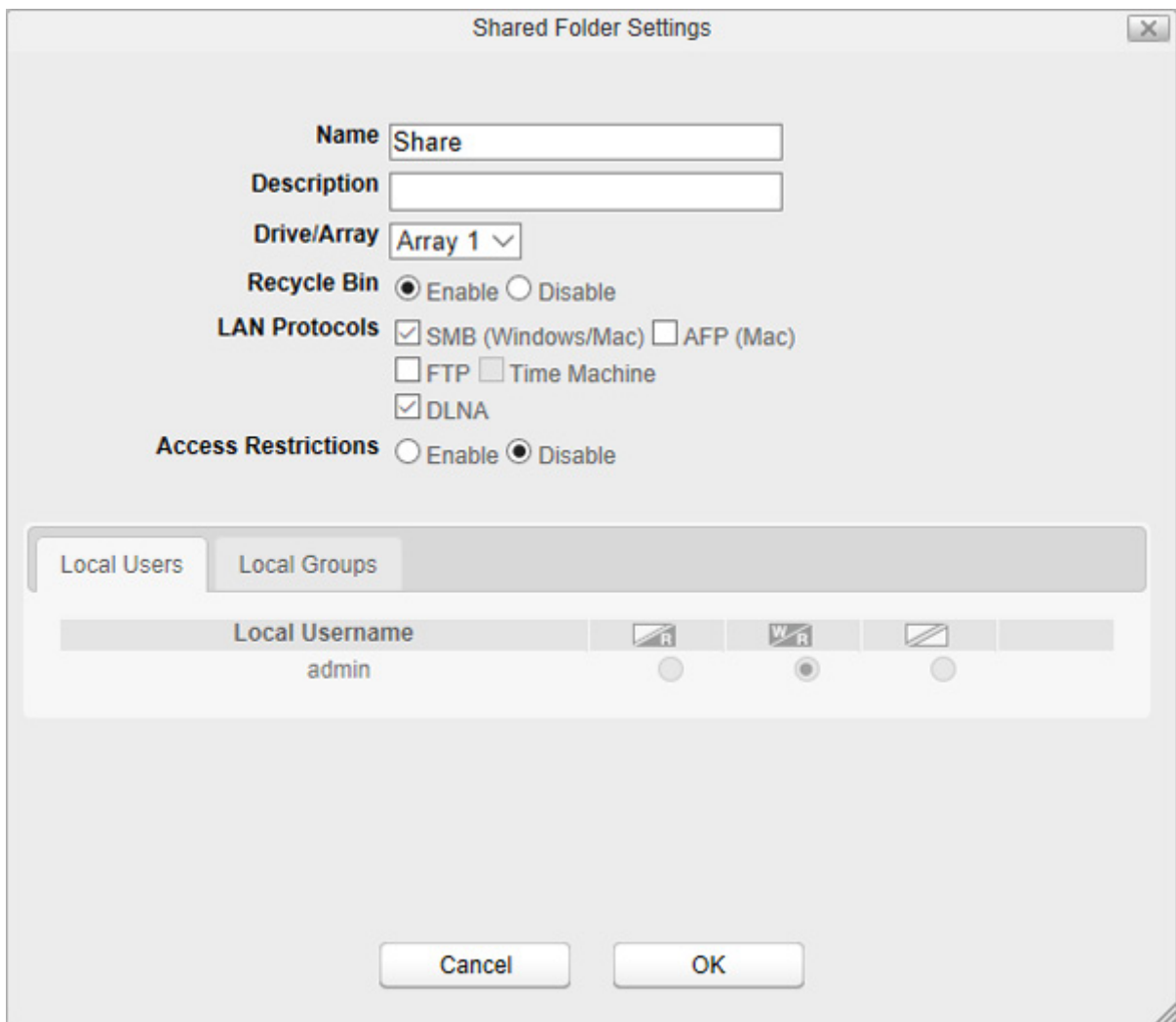

Notes:

- Names may contain up to 27 alphanumeric or multibyte characters, hyphens (-), and underscores (_). Do not use a symbol as the first character in the name.
- Descriptions may contain up to 75 alphanumeric or multibyte characters, hyphens (-), underscores (_), and spaces. Do not use a symbol or space as the first character.
- Names already in use for existing folders cannot be used.

Recycle Bin

To protect your data from accidental deletion, you may configure your LinkStation to use a recycle bin instead of deleting files immediately. The recycle bin will only work with SMB connections. To configure the recycle bin, navigate to *System Settings - Folder Setup* in Settings, select the folder from the list, and enable the recycle bin.

Configuring Access Restrictions

You may restrict access to specific shared folders.

1 In Settings, click *System Settings*.

2 Click *Folder Setup*.

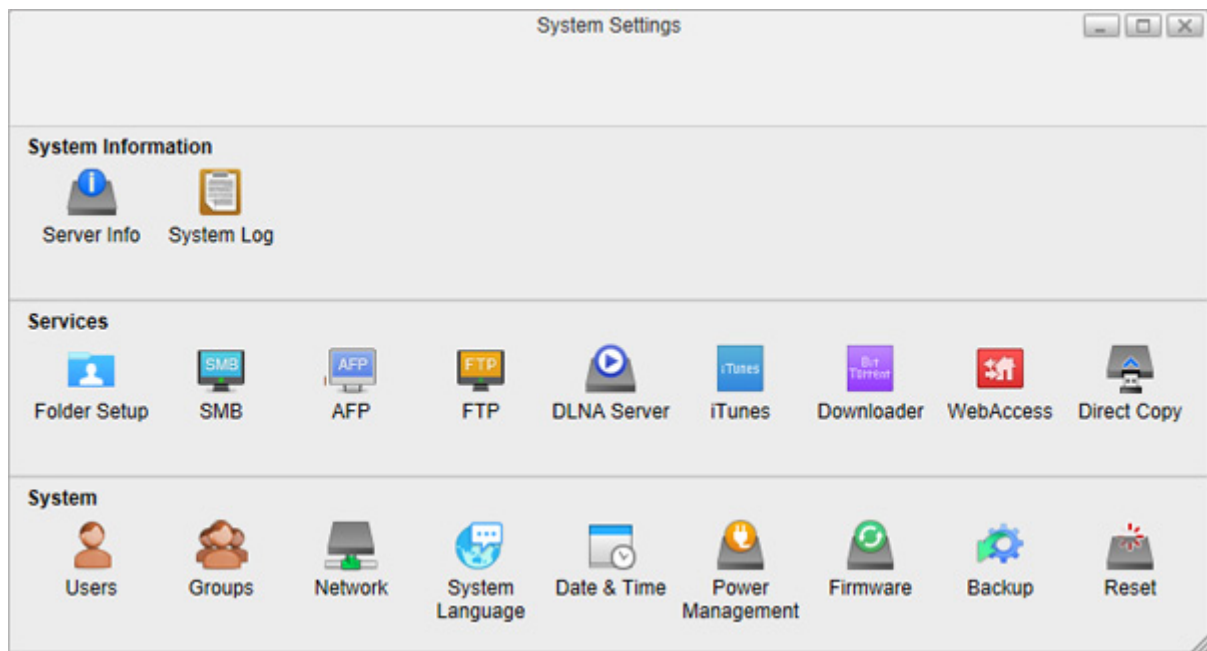

3 Click the shared folder that you want to set access restrictions for.

4 Enable "Access Restrictions".

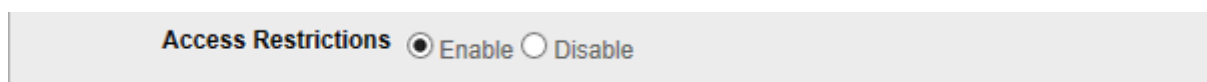

5 Select the level of access for the user or group you added.

 : Read and write access allowed  : Read access allowed  : Access prohibited

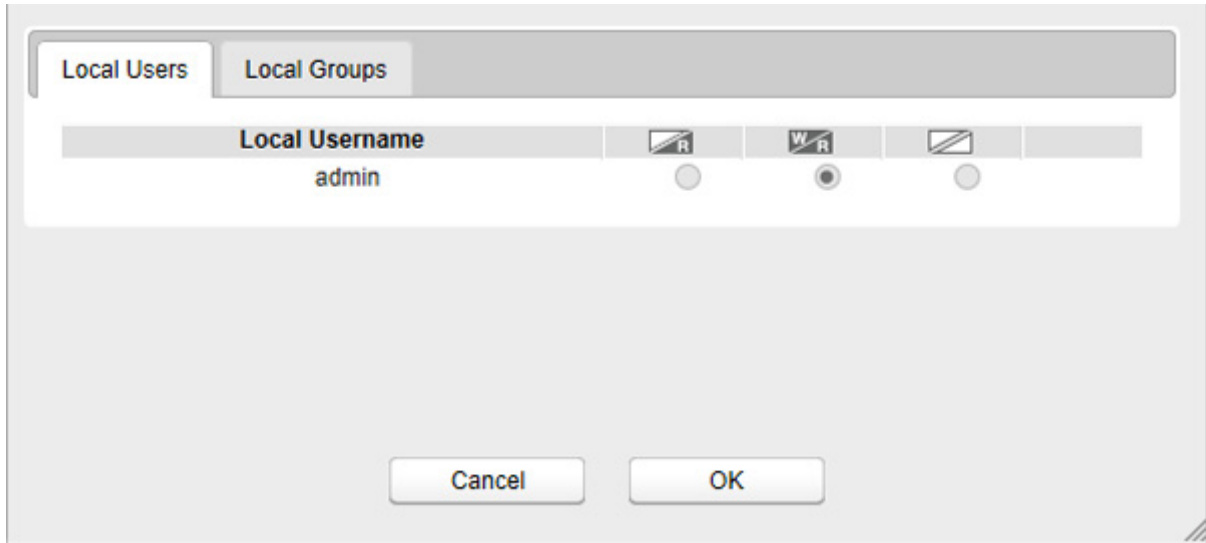

The picture above shows the example for restrictions by the user. If restricting access by group, click the *Local Groups* tab and select group permissions.

6 Click *OK*.

Samba

Enable or disable SMB connections for the LinkStation.

1 In Settings, click *System Settings*.

2 Click *Samba*.

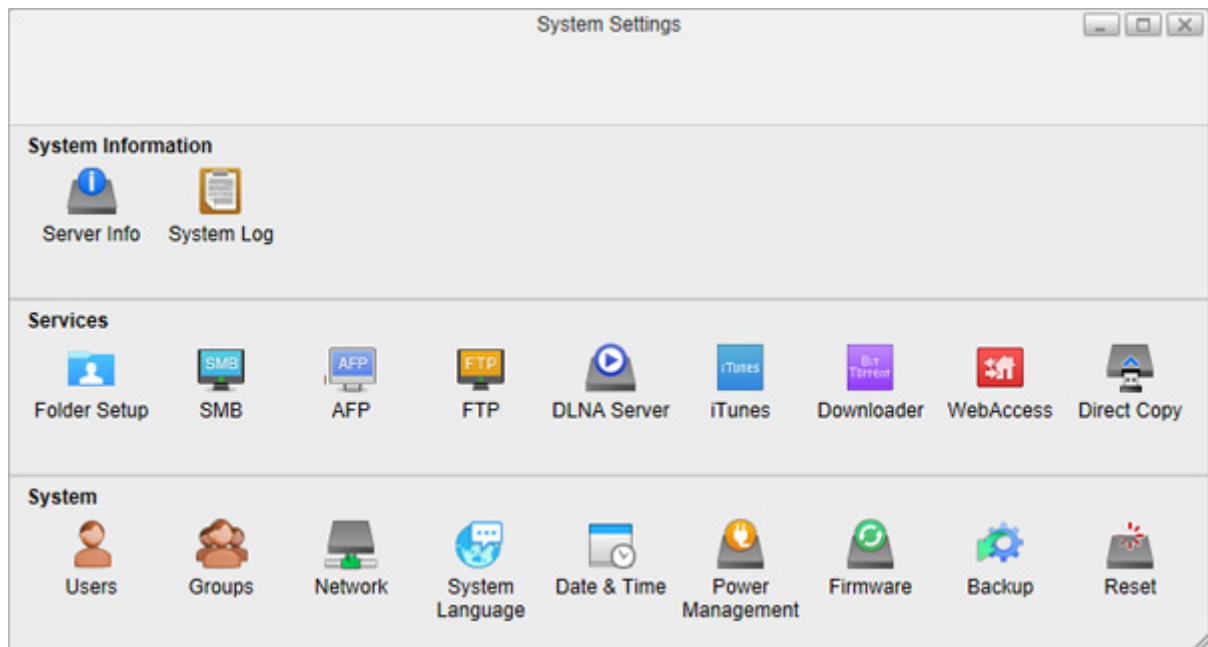

3 Select "Enable Samba service" to enable SMB connections and click *Apply*.

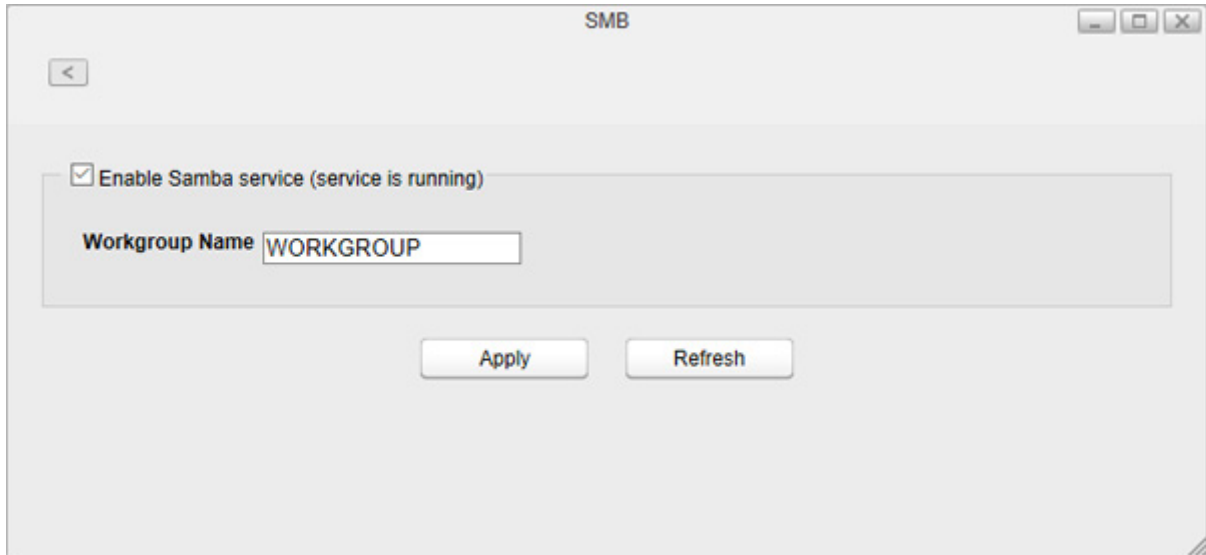

Even if the file sharing service is enabled, it will not be enabled for the folder automatically. Go to "Folder Setup" and enable the service for the folder.

AFP

Enable or disable AFP connections for the LinkStation.

1 In Settings, click *System Settings*.

2 Click *AFP*.

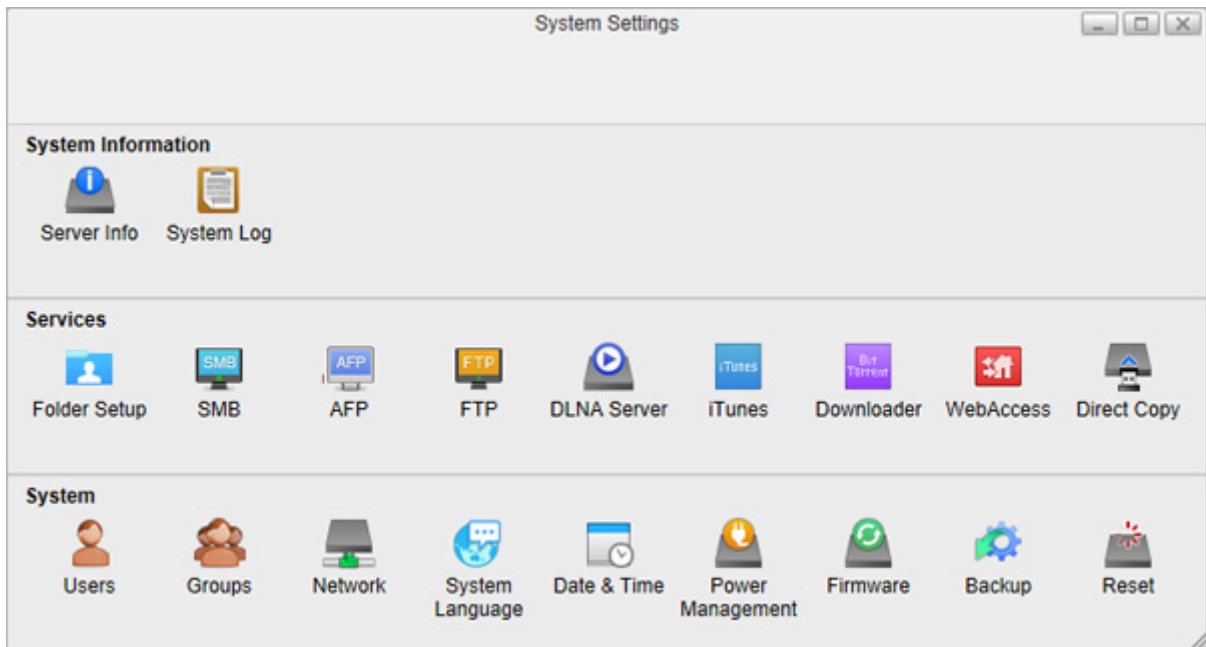

3 Select "Enable AFP service" to enable AFP connections and click *Apply*.

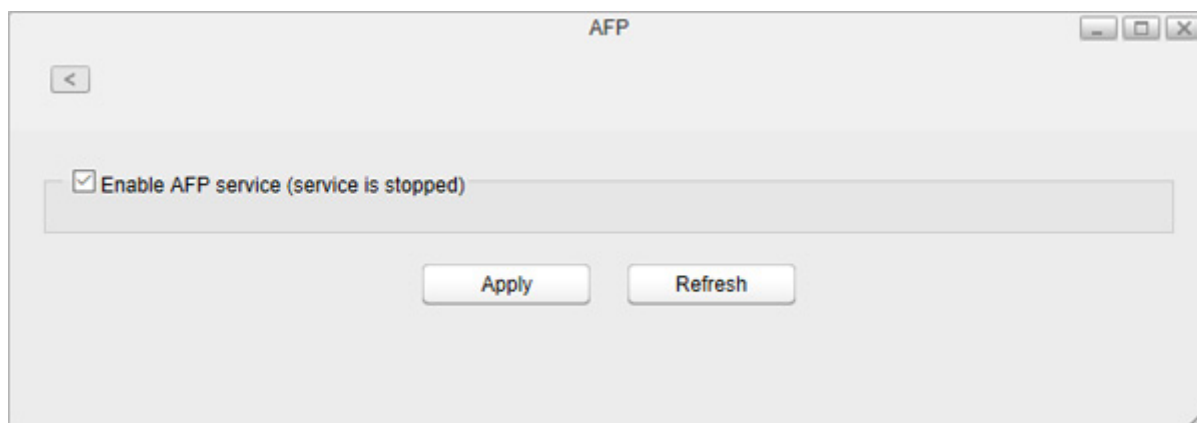

Even if the file sharing service is enabled, it will not be enabled for the folder automatically. Go to "Folder Setup" and enable the service for the folder.

FTP

Enable or disable FTP connection of the LinkStation.

1 In Settings, click *System Settings*.

2 Click *FTP*.

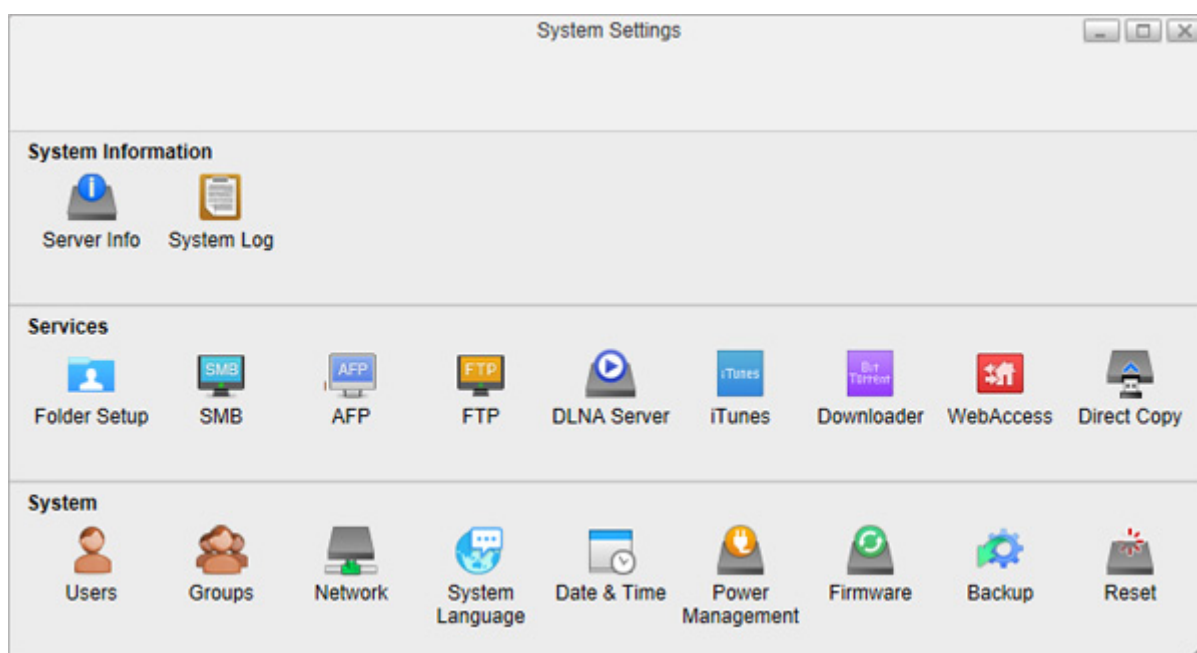

3 Select "Enable FTP service" to enable FTP connections.

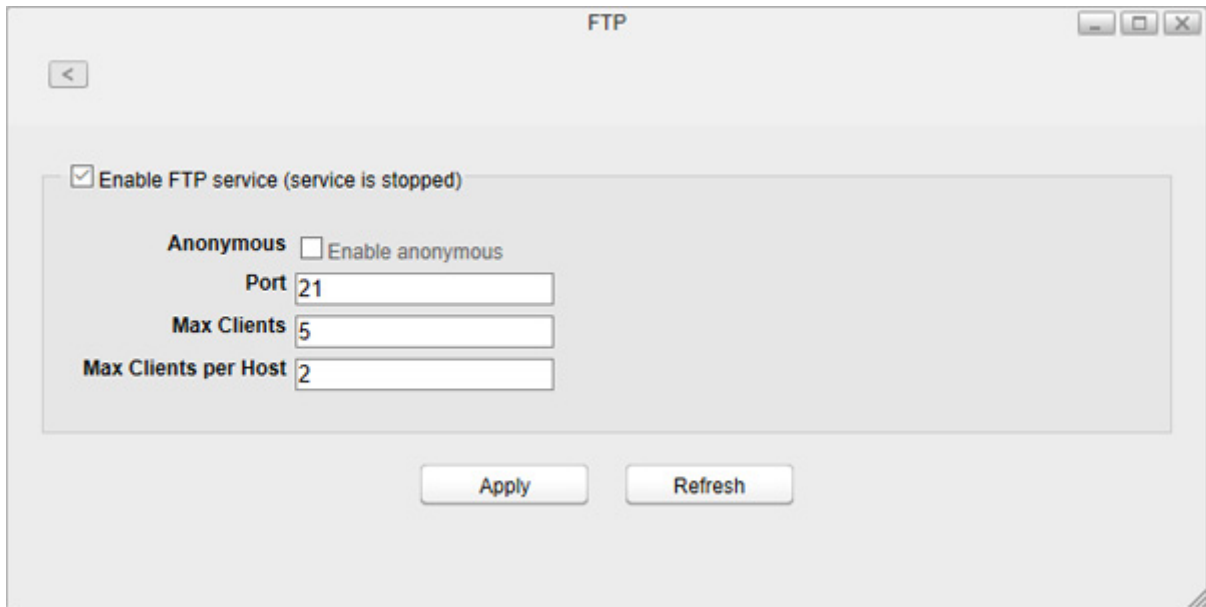

4 Enter a desired port number and other settings. If you want to allow anonymous access, select "Enable anonymous".

5 Click *Apply*.

Even if the file sharing service is enabled, it will not be enabled for the folder automatically. Go to "Folder Setup" and enable the service for the folder.

Note: If you access the LinkStation as an anonymous user via FTP, it will be read-only access.

DLNA Server

Enable or disable DLNA. If enabled, you can view or play files stored in the LinkStation from the DLNA-compatible devices.

DLNA is a set of guidelines for sharing digital media. The LinkStation includes a DLNA server compliant with DLNA guidelines. Movies, photos, and music saved on the LinkStation can be played on DLNA-compatible TVs, stereo equipment, game consoles, and other devices on the local network.

1 In Settings, click *System Settings*.

2 Click *Folder Setup*.

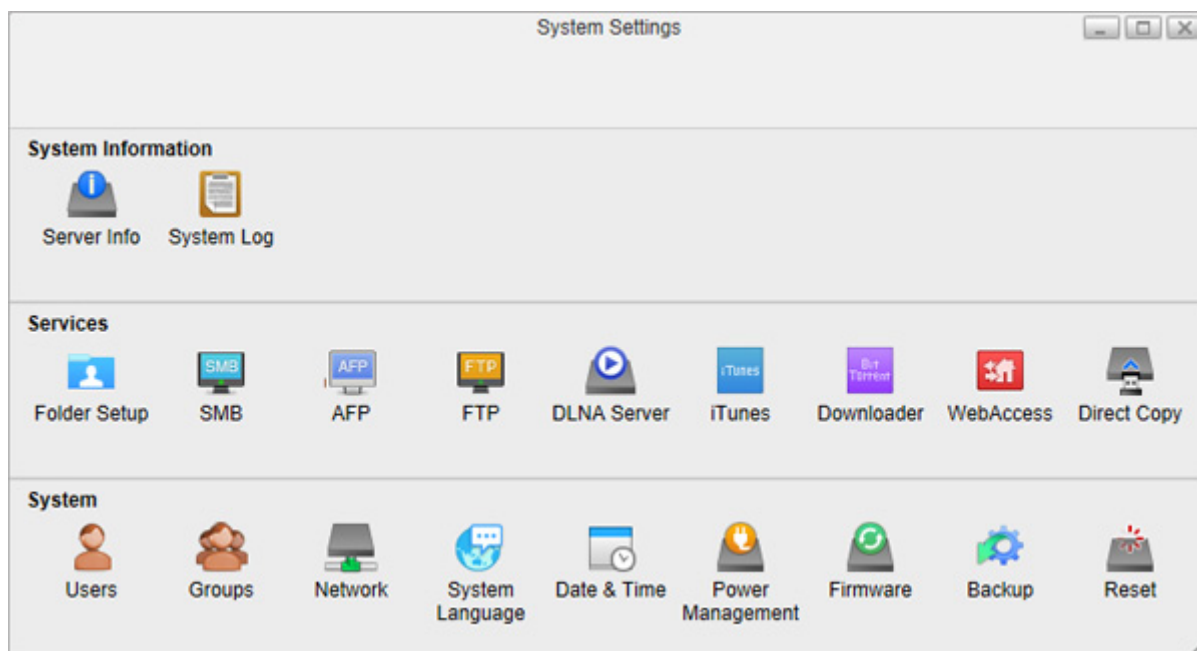

3 Select a shared folder for the DLNA server.

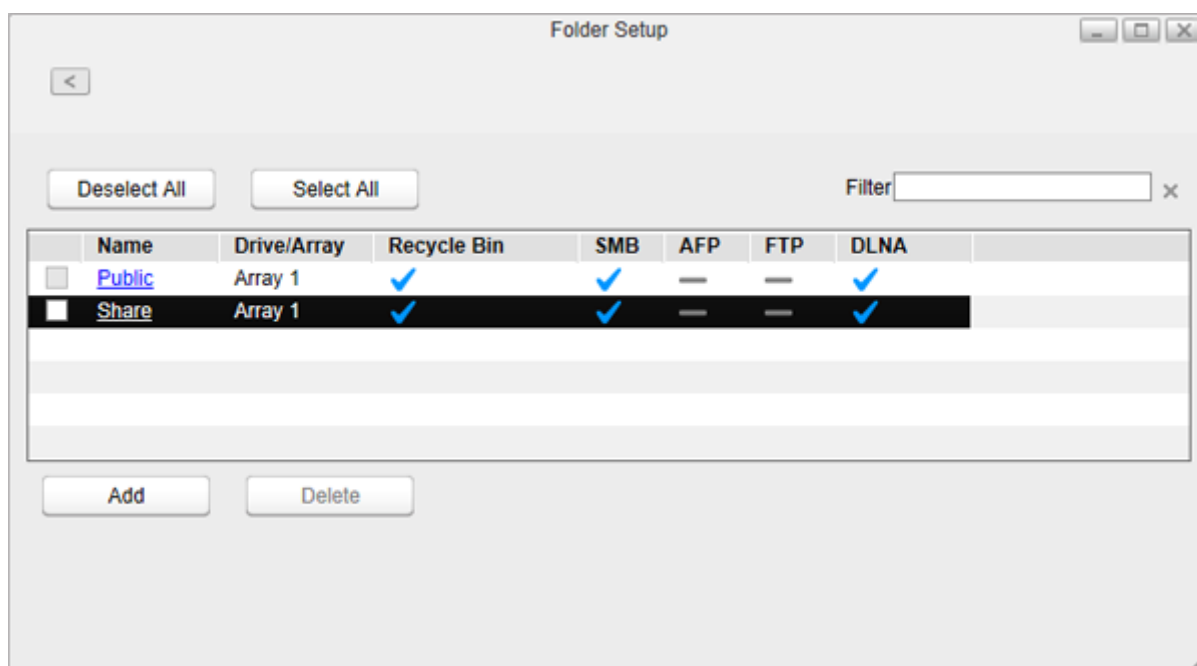

- 4** Make sure that "DLNA" is enabled for the folder. If not, select the "DLNA" checkbox for "LAN Protocols", then click *OK*.

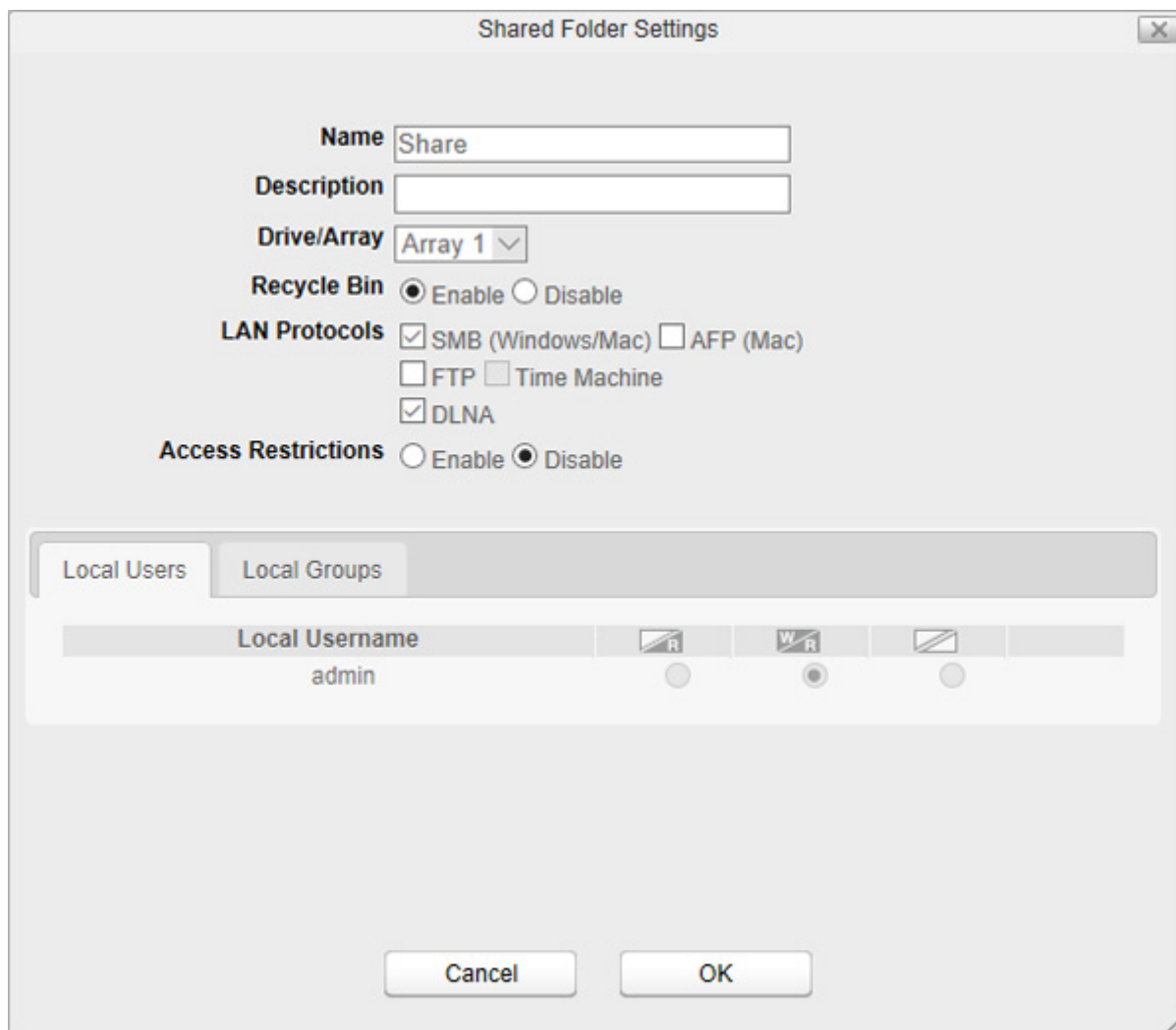

If DLNA service is not enabled, it will be enabled automatically when enabling the service for shared folder.

Playing Files on the DLNA Client Device

To play back content from a DLNA-compatible device:

- 1** Connect the DLNA-compatible device to the same network as the LinkStation and turn it on.
- 2** Select the LinkStation in the software of the DLNA-compatible device.
- 3** Select the content to be played back.

Notes:

- For more information on playing files, see the DLNA-compatible devices' manuals.
- Windows Media files (.wmv, .wma) without simple index do not support fast forwarding/rewinding.

iTunes

Enable or disable the iTunes server, change the server name, and select the folder for sharing. If the iTunes server is enabled, computers on your network with iTunes can play music files stored on the LinkStation.

- 1** In Settings, click *System Settings*.

2 Click *iTunes*.

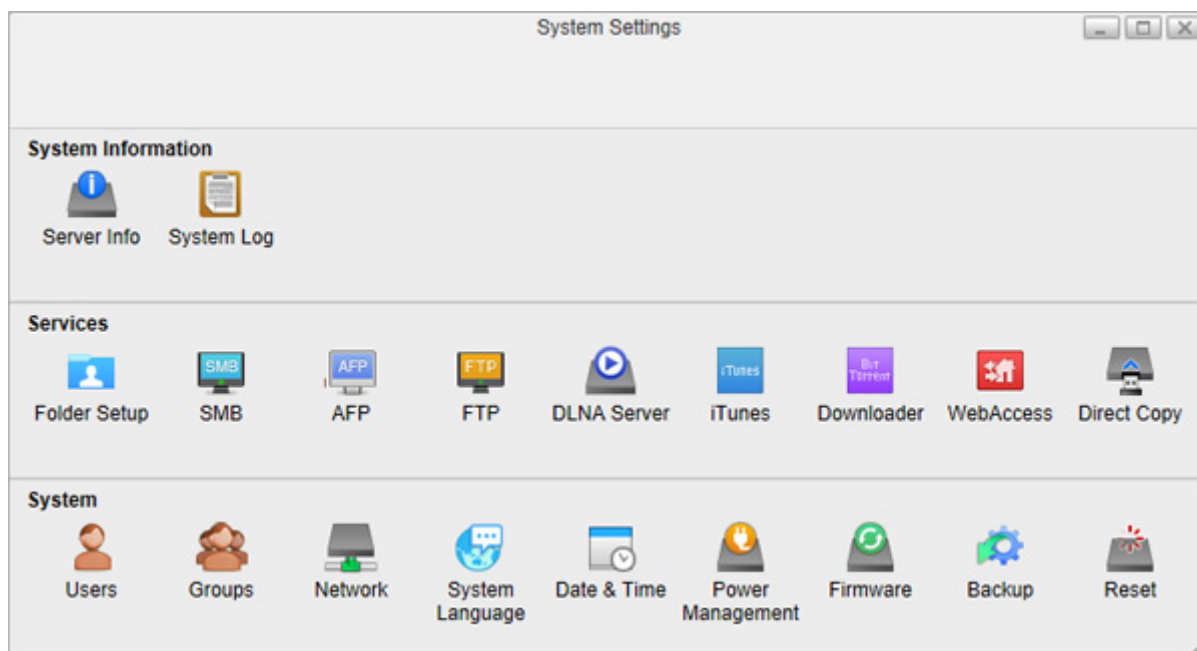

3 Select "Enable iTunes service" to enable the iTunes server and enter a desired server name. If you prefer to use the LinkStation name as the server name, select "Use hostname".

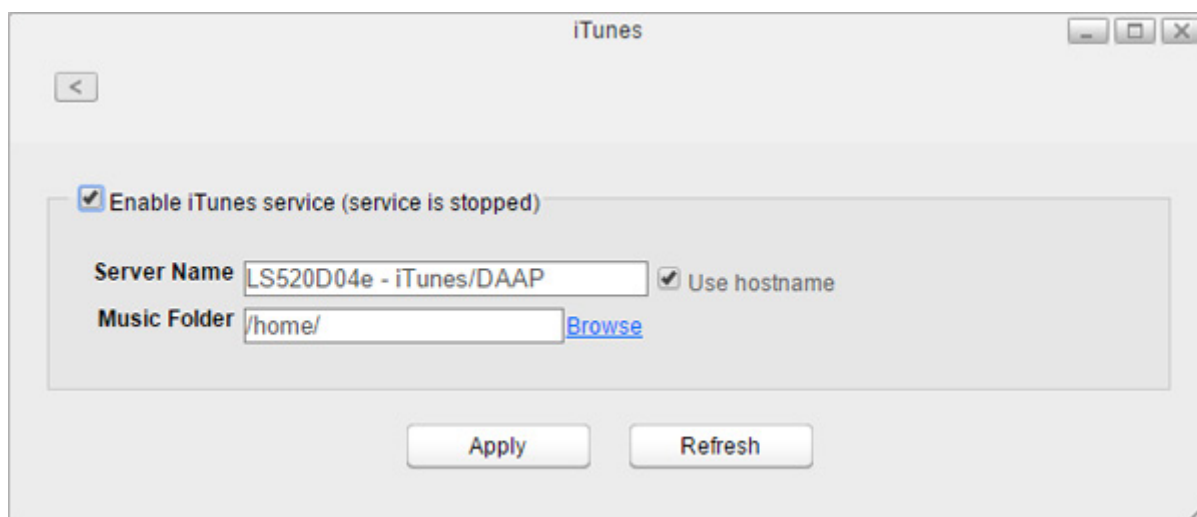

4 Click *Browse* and select the folder to use for iTunes, then click *Open*.

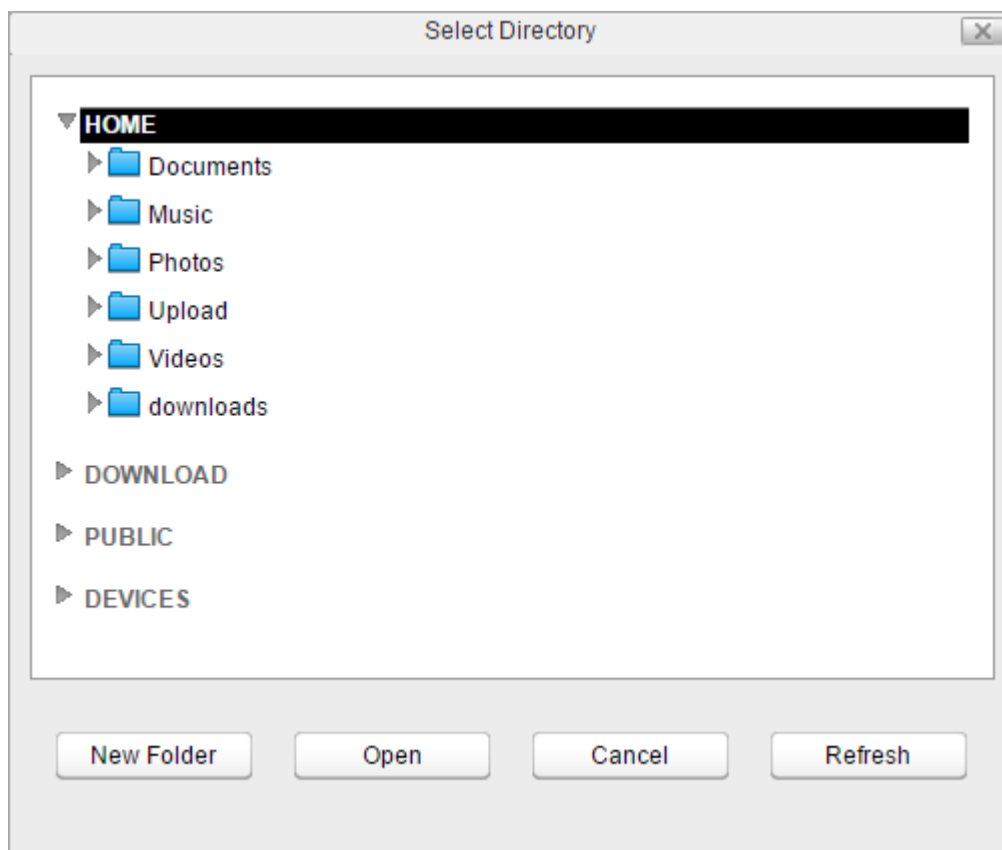

5 Click *Apply*.

Note: When you access the iTunes server from a computer or iOS device right after enabling the service on the LinkStation, the file list may not be displayed properly. In such a case, disconnect and reconnect the LinkStation to the computer or iOS device. The file list should be updated.

Downloader

Enable or disable BitTorrent.

BitTorrent is a protocol for distributing large amounts of data efficiently. The information in this section is for users who are familiar with BitTorrent.

Enabling Downloader Service

1 In Settings, click *System Settings*.

2 Click *Downloader*.

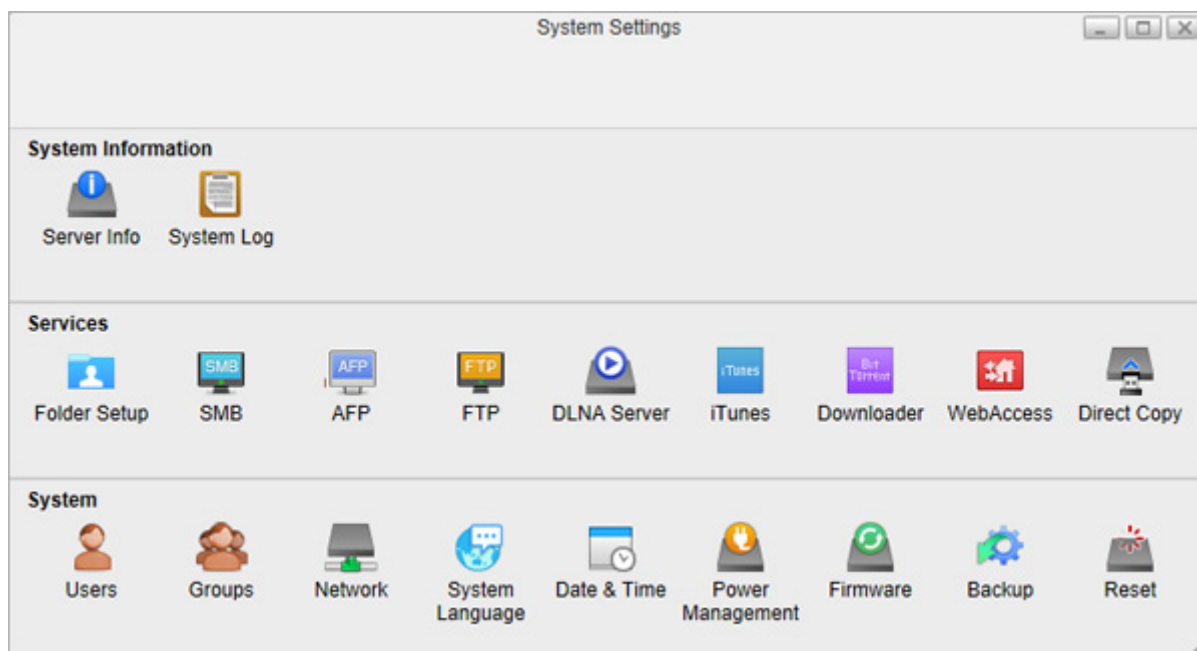

3 Click "Enable download service" to enable BitTorrent and click *Apply*.

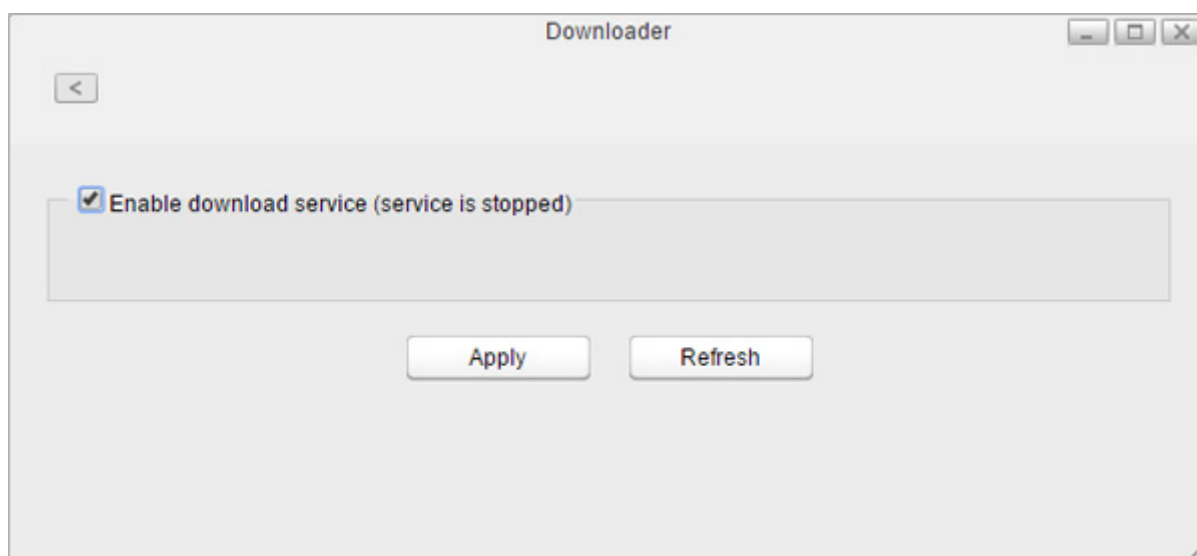

Opening the Download Manager

1 In Settings, click *System Settings*.

2 Click *Downloader*.

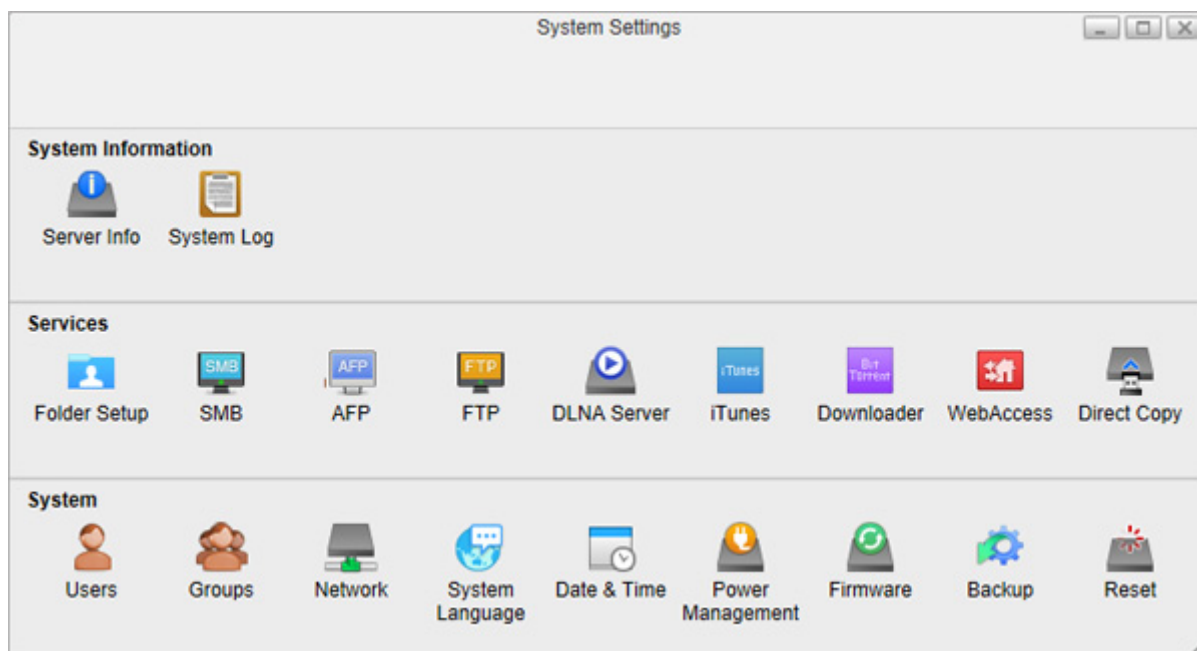

3 Click the icon displayed in the window. If no icon is displayed like the screen below, you should enable it by following the procedure in the "Enabling Downloader Service" section.

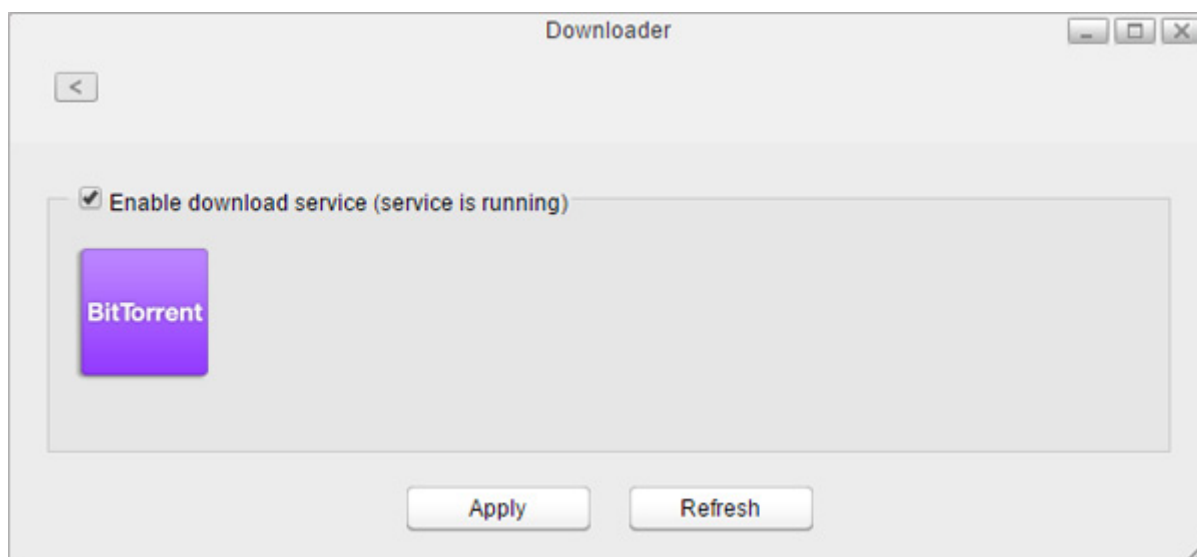

4 Enter a username and password, then click *Log In*.

The username is "admin" and the password is blank (no password).

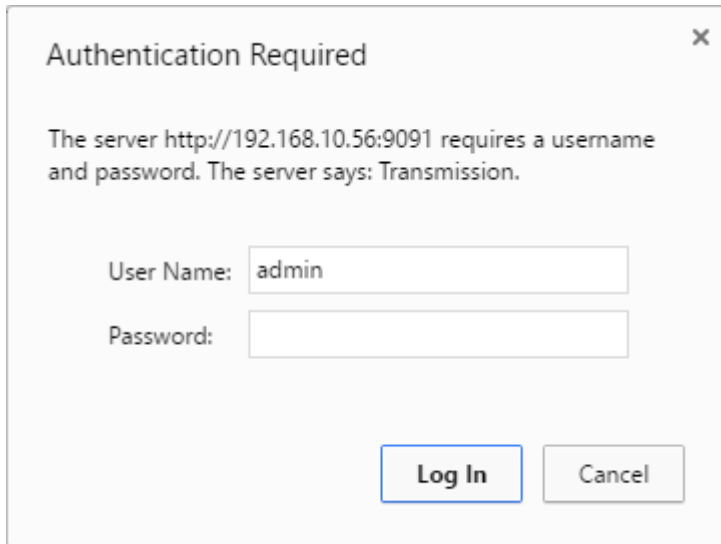

5 The download manager will open.

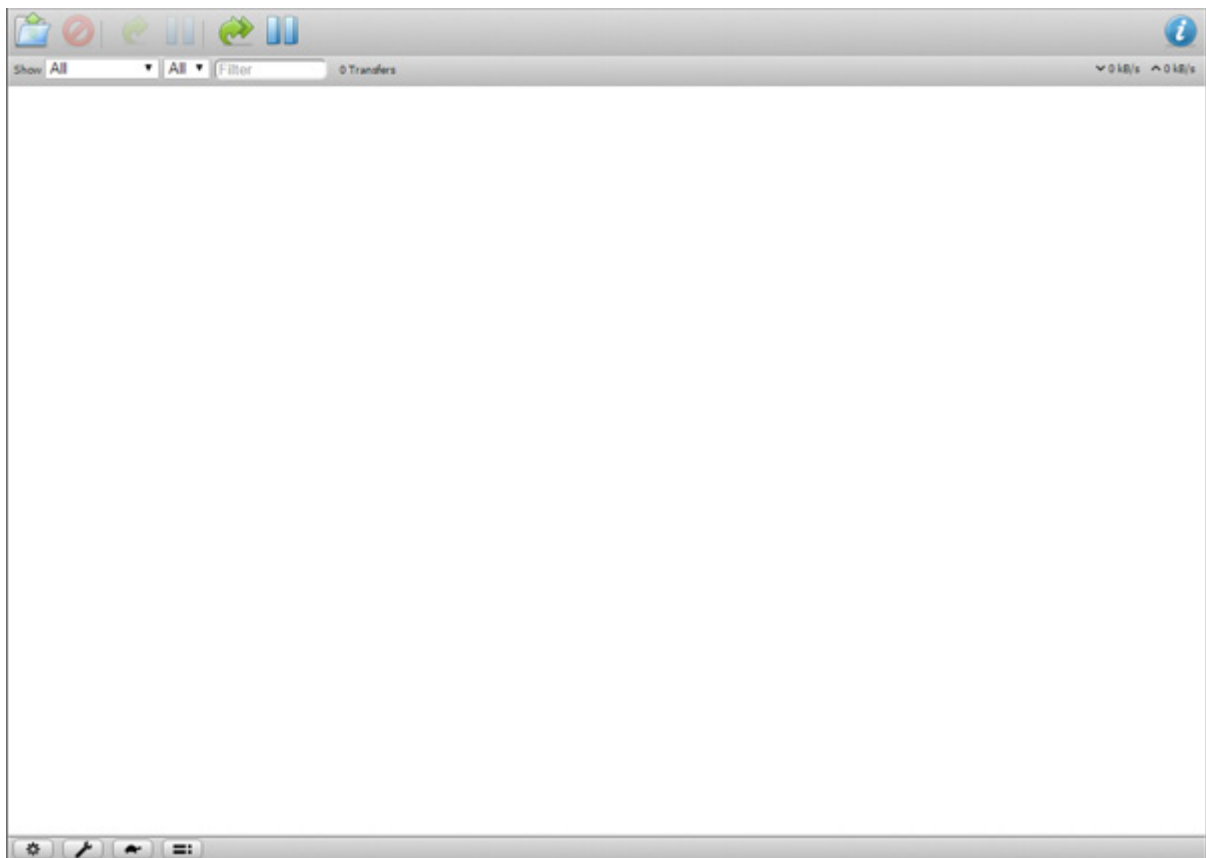

Downloading Files

1 Open the download manager.

2 Click the  icon.

3 Select a file to upload or enter the URL into the "Or enter a URL:" field, specify the location to save the downloaded file, then click *Upload*.

Select "Start when added" to start downloading immediately after clicking *Upload*.

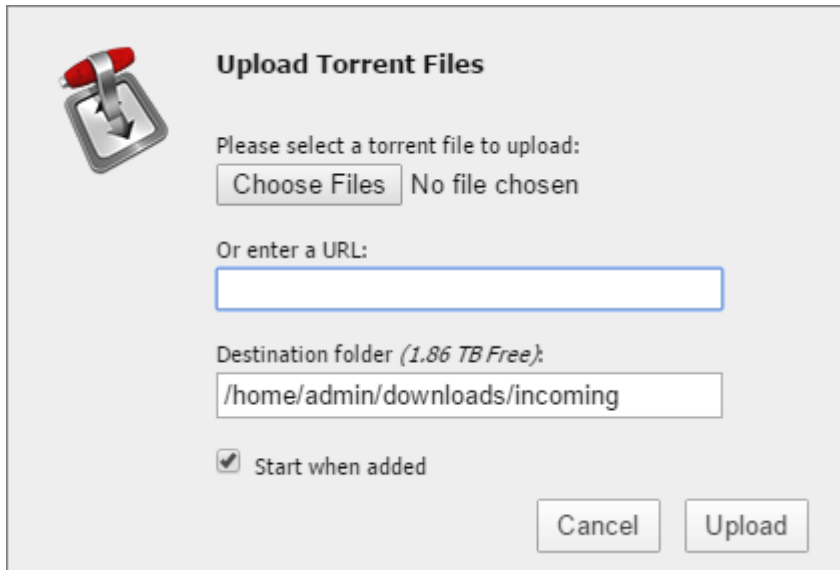

Note: By default, the downloaded file will be saved in the "incoming" folder in the personal folder. To change the download folder, click the  icon at the left bottom corner and change the directory at "Download to:".

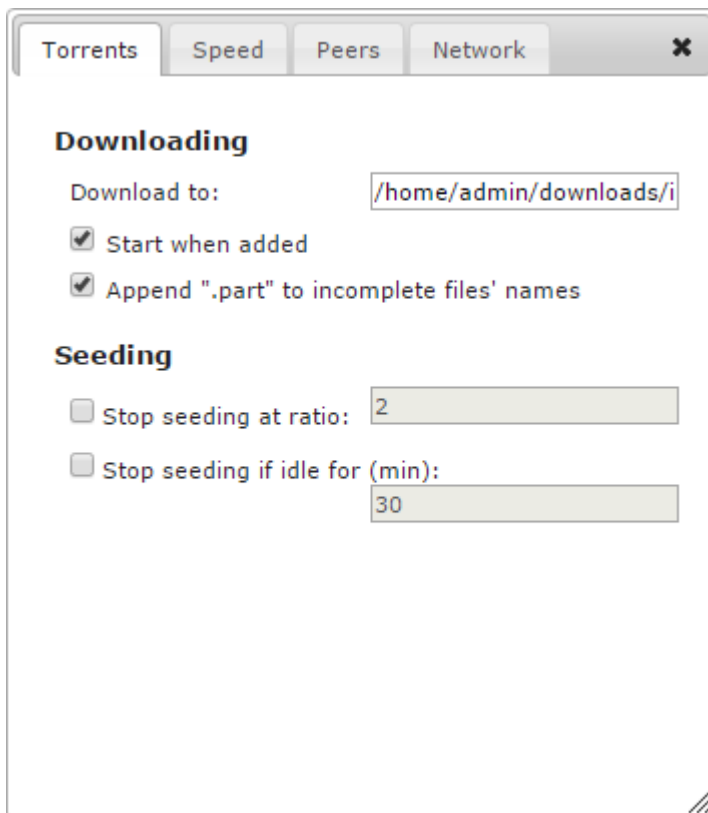

4 The download will start.

To cancel downloading, click , then *Remove*. Click  to pause the download. Click  or  to resume.

WebAccess

WebAccess is a program that allows you to remotely access files in your LinkStation's shared folder from your computer or mobile device through the Internet.

Configuring WebAccess

By using remote access options that are allowed in the WebAccess screen, you can configure WebAccess settings using a simpler process.

If you are using LinkStation version 1.10 or earlier, your admin password may not be changed from the default value. However, WebAccess is always enabled so files on the LinkStation are also published. We highly recommend changing the password from "password", the default value, to increase security.

1 In Settings, click *System Settings*.

2 Click *WebAccess*.

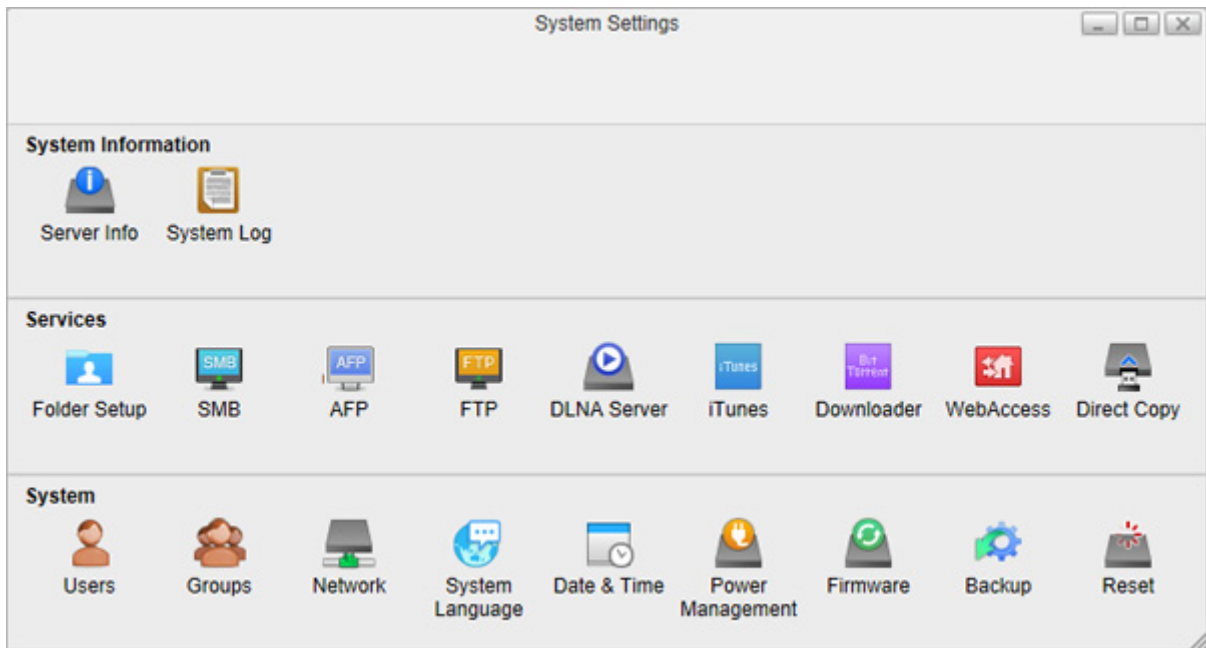

3 Select "Remote access options" to easily configure WebAccess settings.

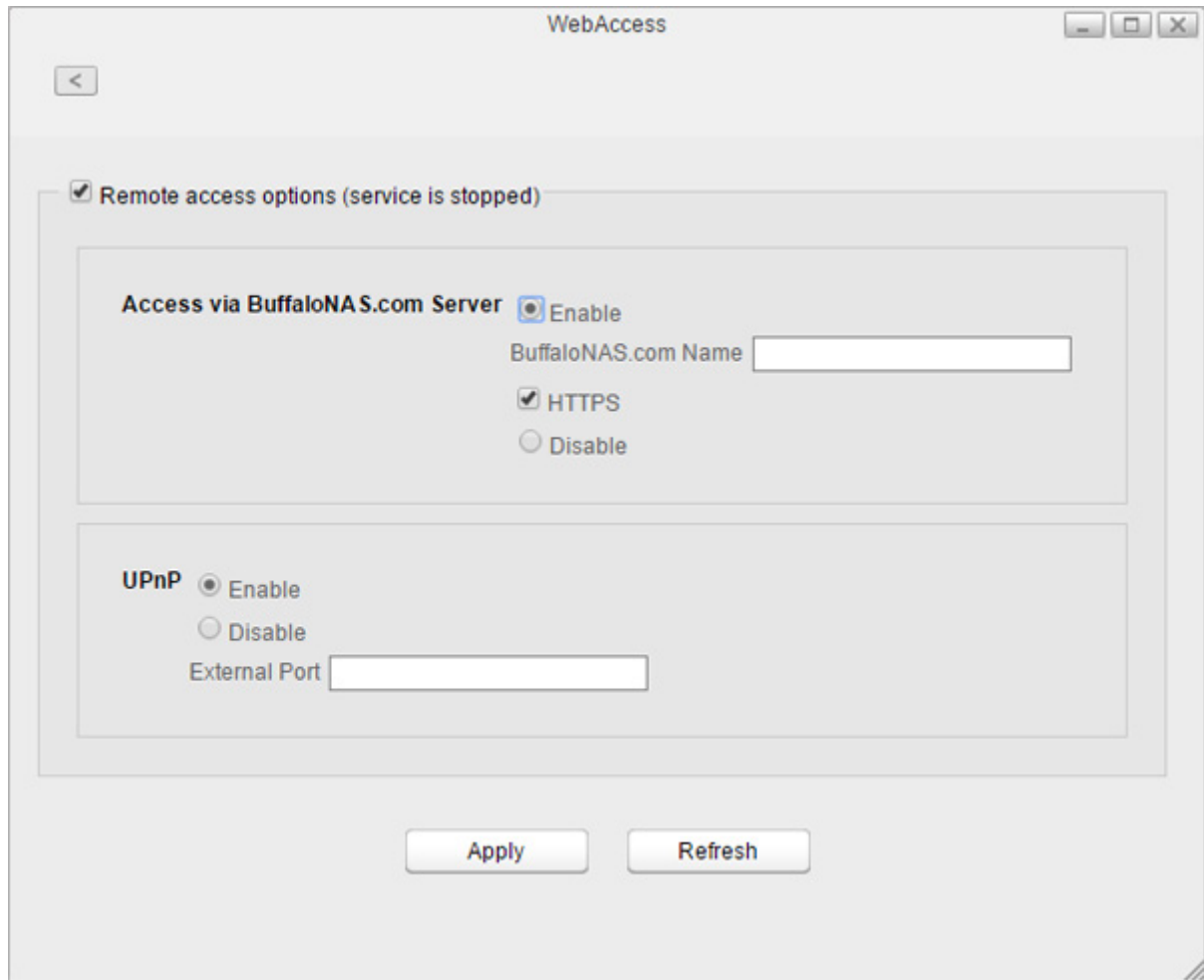

4 Configure the desired settings, then click *Apply*.

- You may use the default BuffaloNAS.com registration, or select "Disable" to use a different DNS server.
- Choose a "BuffaloNAS.com Name" for your WebAccess account. Names may contain 3 to 20 alphanumeric characters, underscores (_), and hyphens (-).
- If your router supports UPnP, enable "UPnP". If UPnP is not supported or disabled on the router, disable that setting and enter either "80" (HTTP) or "443" (HTTPS) into the "External Port" box. If configuring the external port, port forwarding configuration is required to add the port number on the router. Access the router's port forwarding configuration page and register the port number "80" or "443" to the router.

Accessing Remotely

Once settings are configured, you are now ready for remote access from outside the local network. There are many ways to access WebAccess folders depending on your device.

- From a computer, enter <http://buffalonas.com/> into the address bar on your Internet browser and log in with your BuffaloNAS.com name. Settings will remotely be opened. From My LinkStation, you can access the files on the LinkStation.
- To access from an iOS device, install the "WebAccess i" application from the App Store.
For more procedure: <http://buffalonas.com/manual/i/en/>
- To access from an Android device, install the "WebAccess A" application from the Google Play.
For more procedure: <http://buffalonas.com/manual/a/en/>

Access Restrictions When Accessing Remotely

Access attributes for the shared folders on the LinkStation are as below:

R/W: Read and write, R: Read only, -: No access

- For the "Public" folder and shared folders created in Folder Setup

Access method		WebAccess i			WebAccess A			My LinkStation		
Access restrictions		Read and write	Read only	Disabled	Read and write	Read only	Disabled	Read and write	Read only	Disabled
Available user	admin	R/W	R/W	R/W	R/W	R/W	R/W	R/W	R/W	R/W
	Registered user	R/W	R/W	R/W	R	R/W	R	R/W	R/W	R/W
	Not logged in	-	-	-	-	-	-	R	R	-

For username folder

Access method		WebAccess i	WebAccess A	My LinkStation
Available user	admin	R	R/W	R/W
	Registered user	R	R/W	R/W
	Not logged in	-	-	-

Direct Copy

Use Direct Copy to copy data from a USB mass storage device directly to the LinkStation. To copy using Direct Copy, follow the procedure below.

Note: Direct Copy will not work while the backup is running. The prior process will work.

- 1 Connect the USB device. When it mounts, the function LED will light up.

Note: Unsupported devices will not cause the function LED to light.

- 2 You now have 60 seconds to press the function button once. If you do, the function LED will flash as all the files on the USB device are copied to the Direct Copy folder ("usb_backup" under "Public" folder) of the LinkStation.

Notes:

- While the function LED is flashing, hold the function button down for 3 seconds to cancel Direct Copy.
- To change the Direct Copy target folder, navigate to *System Settings - Direct Copy - Browse* in Settings, select a new folder, and click *Apply*.

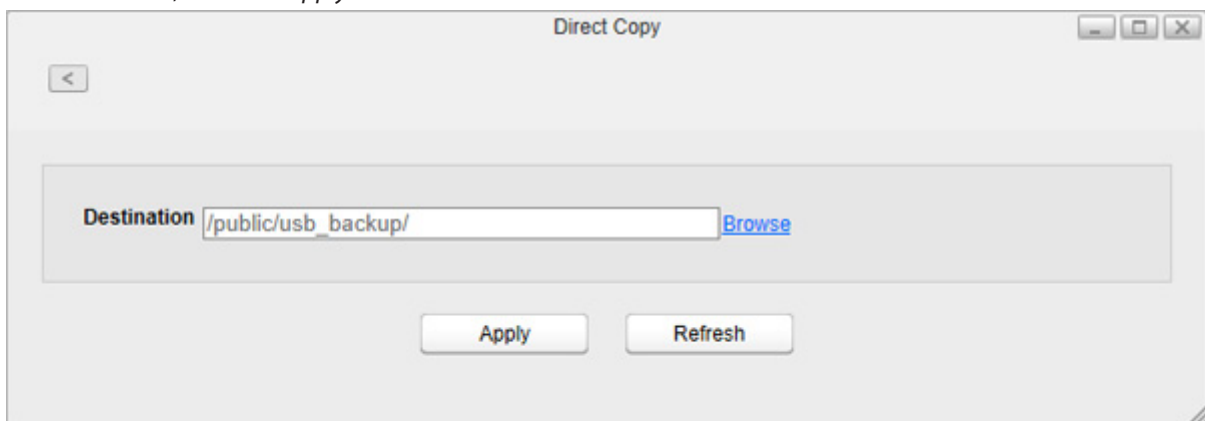

- 3 When the copy operation is finished, the access LED of the USB device will stop flashing and the function LED on the LinkStation will be extinguished. Dismount the USB device from the LinkStation referring to the "Dismounting an External Drive" section in chapter 5.

Chapter 8 System

Users

Create or delete users in the LinkStation, or change the administrator password.

Creating Users

- 1 In Settings, click *System Settings*.
- 2 Click *Users*.

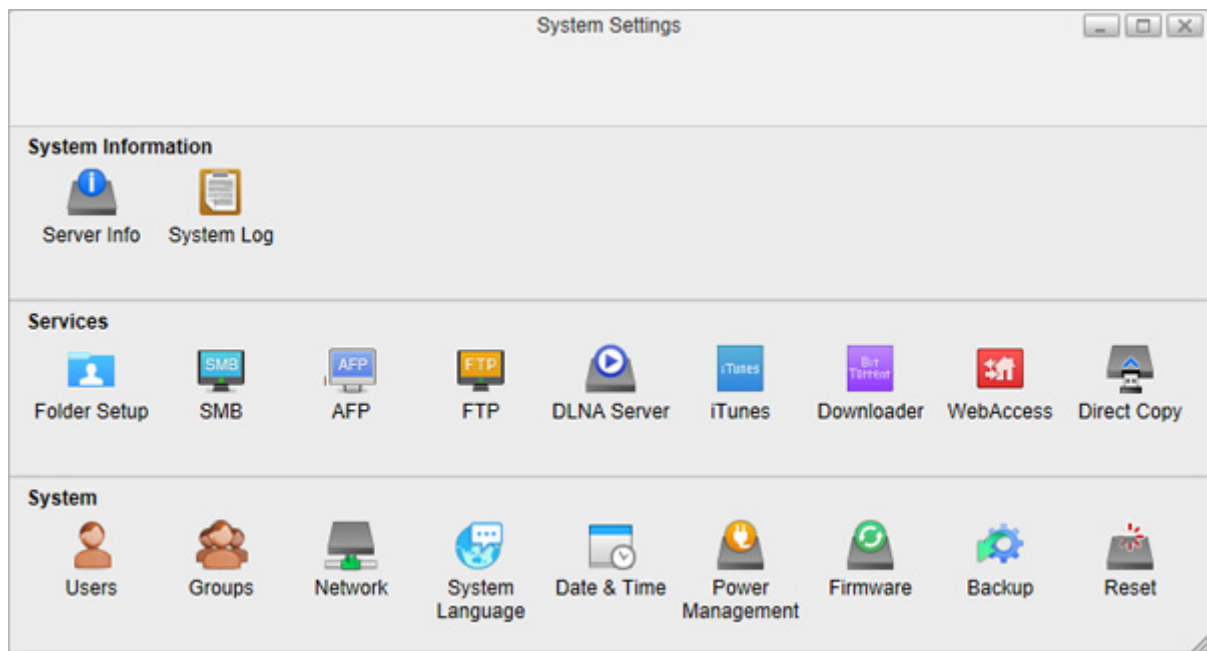

3 Click *New*.

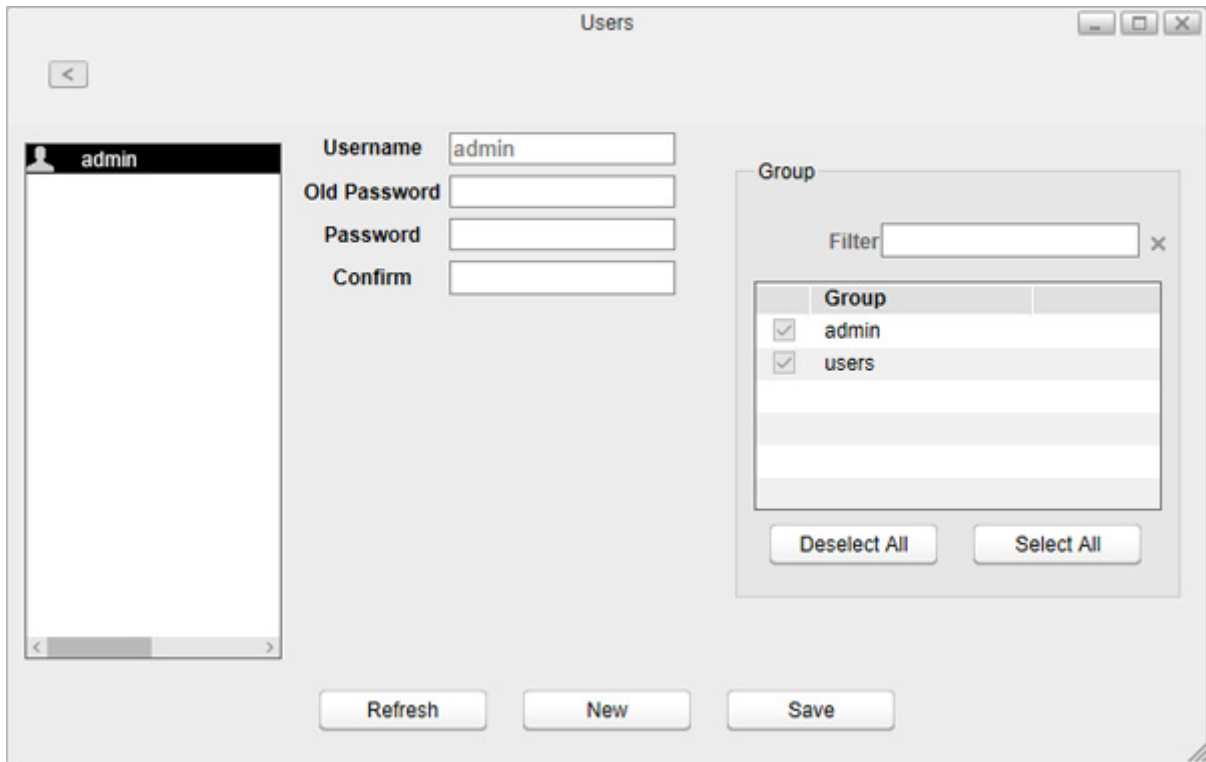

4 Enter a username and password, and confirm the new password.

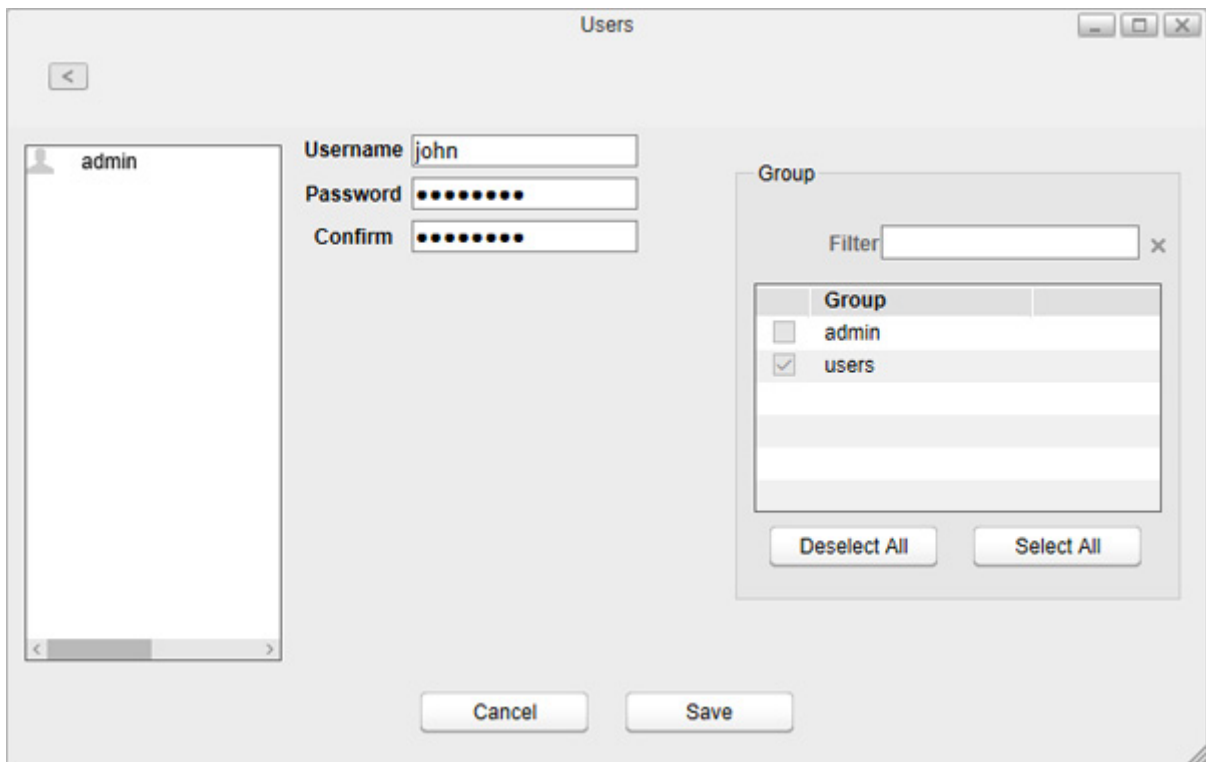

5 Select the group to join and click *Save*.

A new user will be added to the list. When a new user is created, a shared folder that uses the username as its folder name is also created.

Notes:

- Usernames may contain up to 32 alphanumeric characters and the following symbols: - _ . ! # + \$ ^ %. Do not use a symbol as the first character.

- Passwords may contain up to 20 alphanumeric characters and the following symbols: - _ @ ! # \$ % & ' () * + , . / ; < > = ? " [] ^ { } | ~ . Do not use a symbol other than an underscore (_) as the first character.
- Names already in use for existing shared folders cannot be used.

Changing Passwords

Administrator Password

- 1 Log in to Settings as the admin user.
- 2 In Settings, click *System Settings*.
- 3 Click *Users*.

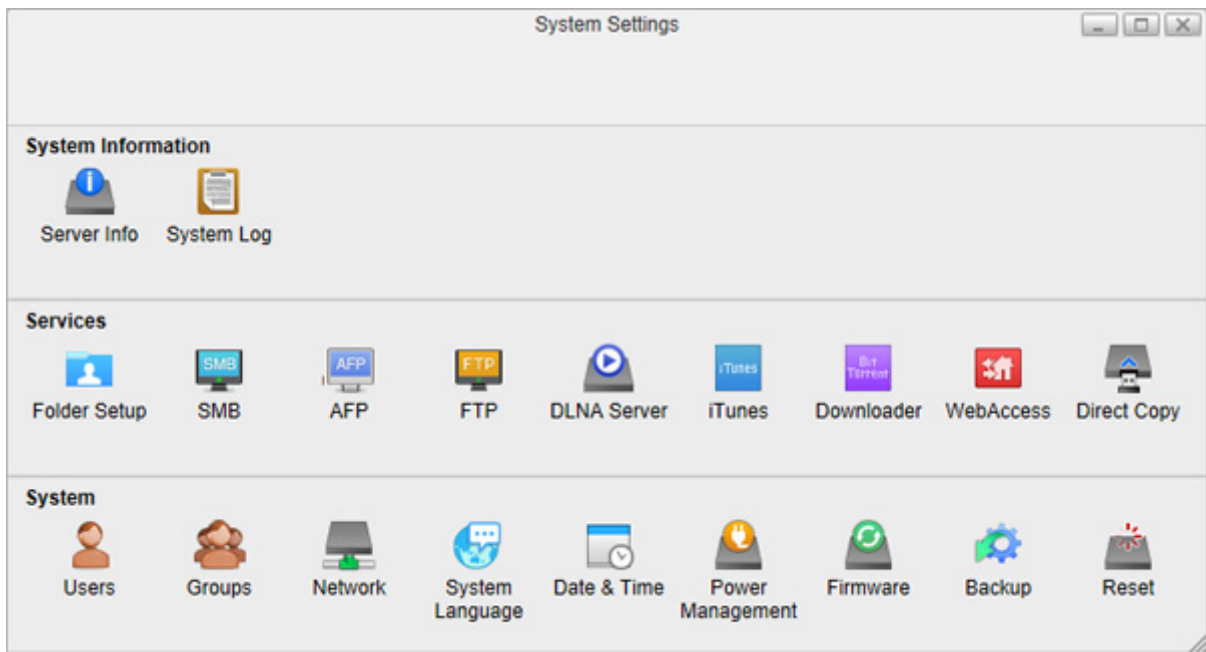

- 4 Enter the current password and new password, confirm the new password, then click *Save*.

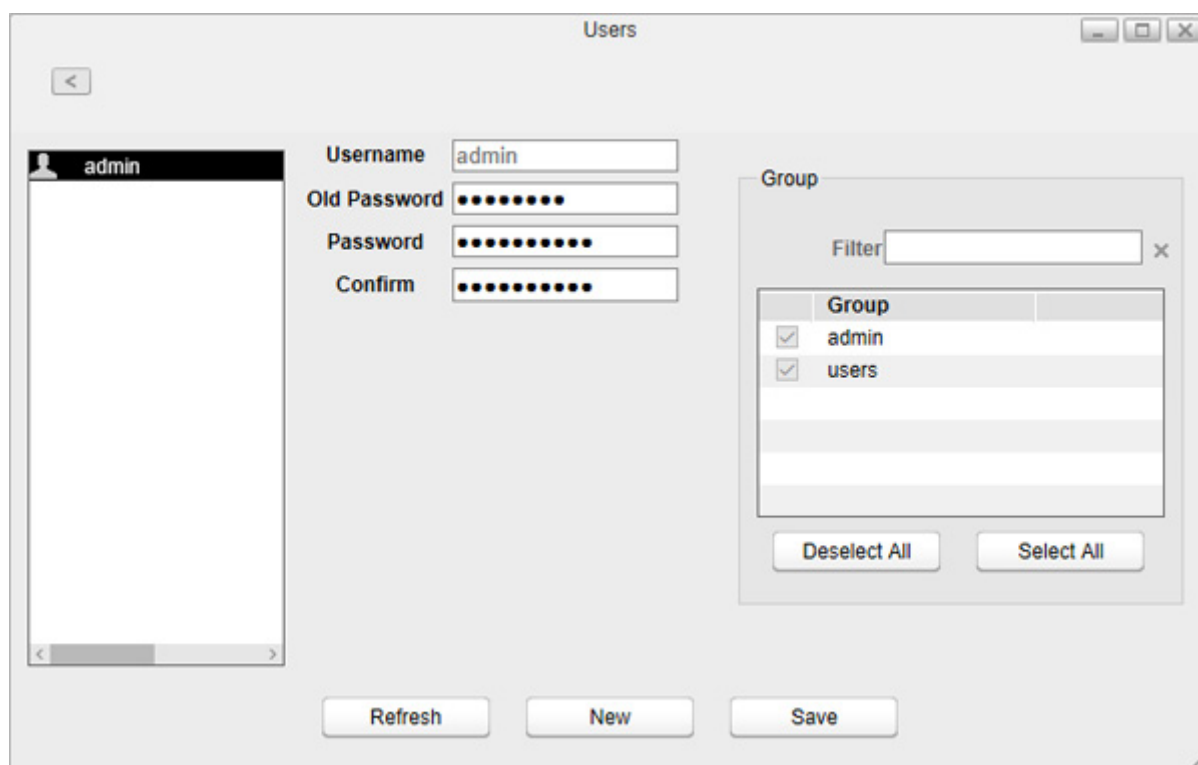

Other Users' Passwords

- 1 Log in to Settings as a user who want to change their password.
- 2 In Settings, double-click *Applications* at the desktop.
- 3 Double-click *Password*.
- 4 Enter the current password and new password, confirm the new password, then click *Apply*.

Deleting Users

- 1 In Settings, click *System Settings*.
- 2 Click *Users*.
- 3 Select a user and click *Delete*.
- 4 Click *OK*.

The selected user is deleted. When the user is deleted, the user's shared folder and data within will be deleted together.

Groups

Creating Groups

- 1 In Settings, click *System Settings*.

2 Click *Groups*.

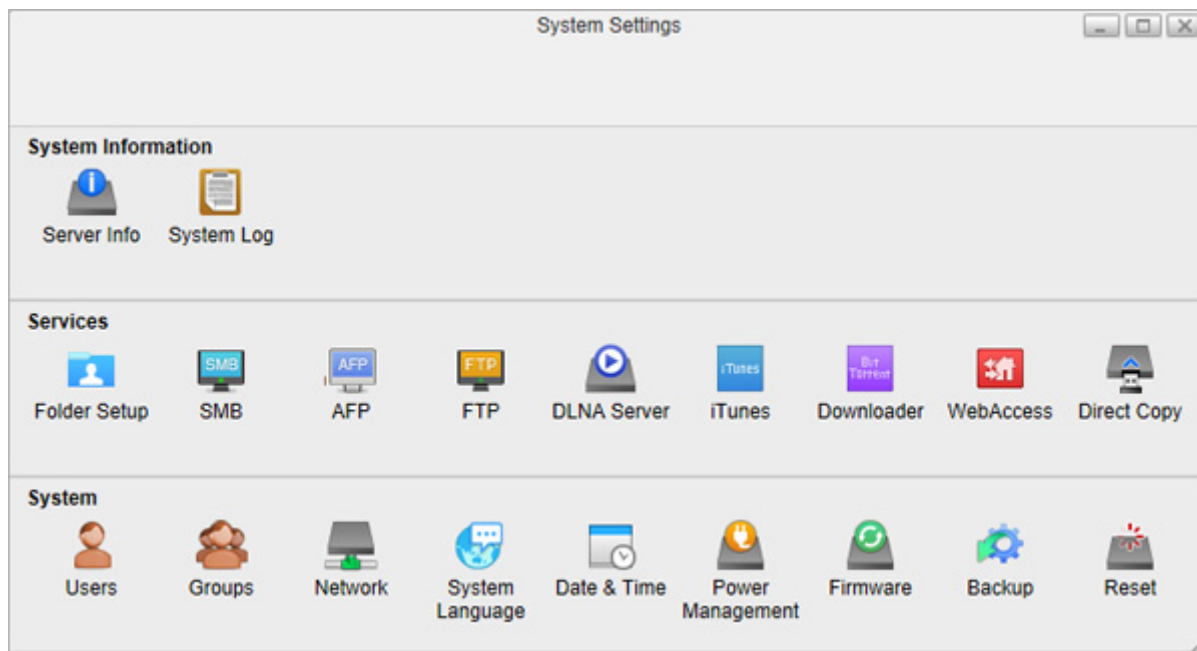

3 Click *Add*.

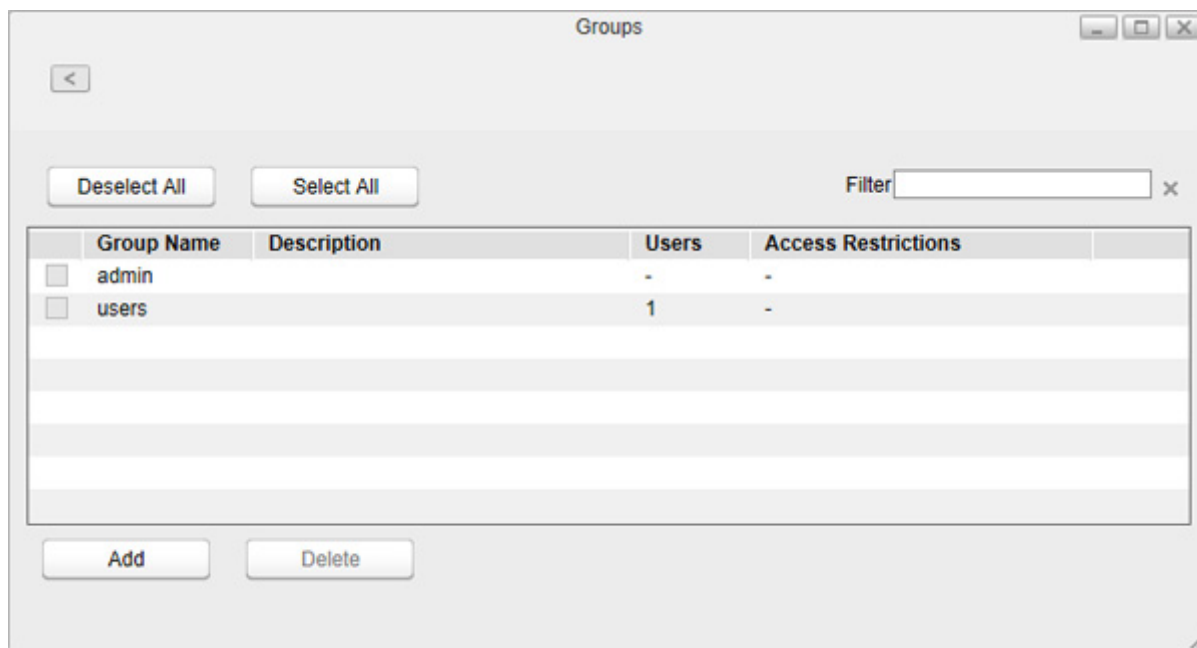

4 Enter a group name and select the users whose belong to, then click *Save*.

The screenshot shows a 'Group Settings' dialog box. It contains a 'Group Name' text field, a 'Description' text area, and a 'Users' section. The 'Users' section includes a 'Filter' text field, a list of users with a dropdown menu set to 'Users', and a checked checkbox next to the user 'admin'. Below the list are 'Deselect All' and 'Select All' buttons. At the bottom of the dialog are 'Cancel' and 'Save' buttons.

A new group will be added to the list.

Notes:

- Group names may contain up to 20 alphanumeric characters, hyphens (-), underscores (_), and periods (.). Do not use a symbol other than an underscore (_) as the first character in the name.
- Group descriptions may contain up to 75 alphanumeric or multibyte characters, hyphens (-), underscores (_), and spaces. Do not use a symbol or space as the first character.

Deleting Groups

- 1** In Settings, click *System Settings*.
- 2** Click *Groups*.
- 3** Select a group's checkbox and click *Delete*.
- 4** Click *OK*.

The selected group is deleted.

Network

Configure network settings such as a hostname, IP address, or Wake-on-LAN.

Changing the Hostname

- 1** In Settings, click *System Settings*.

2 Click *Network*.

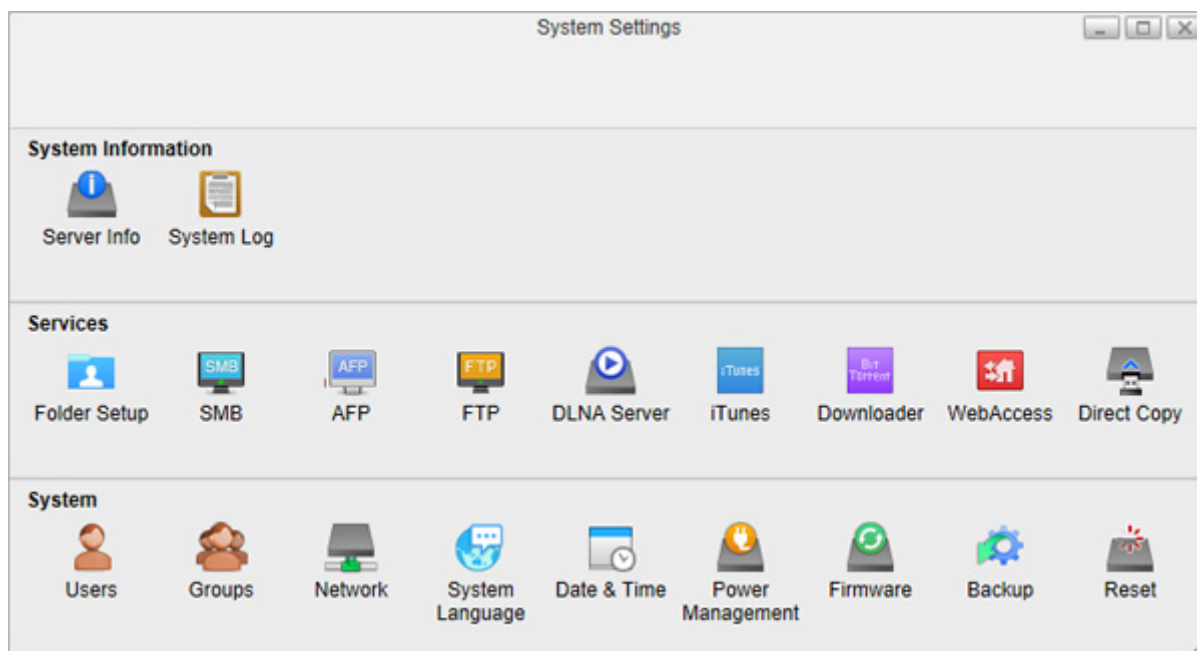

3 Click the *Name* tab, enter a new LinkStation name, and click *Apply*.

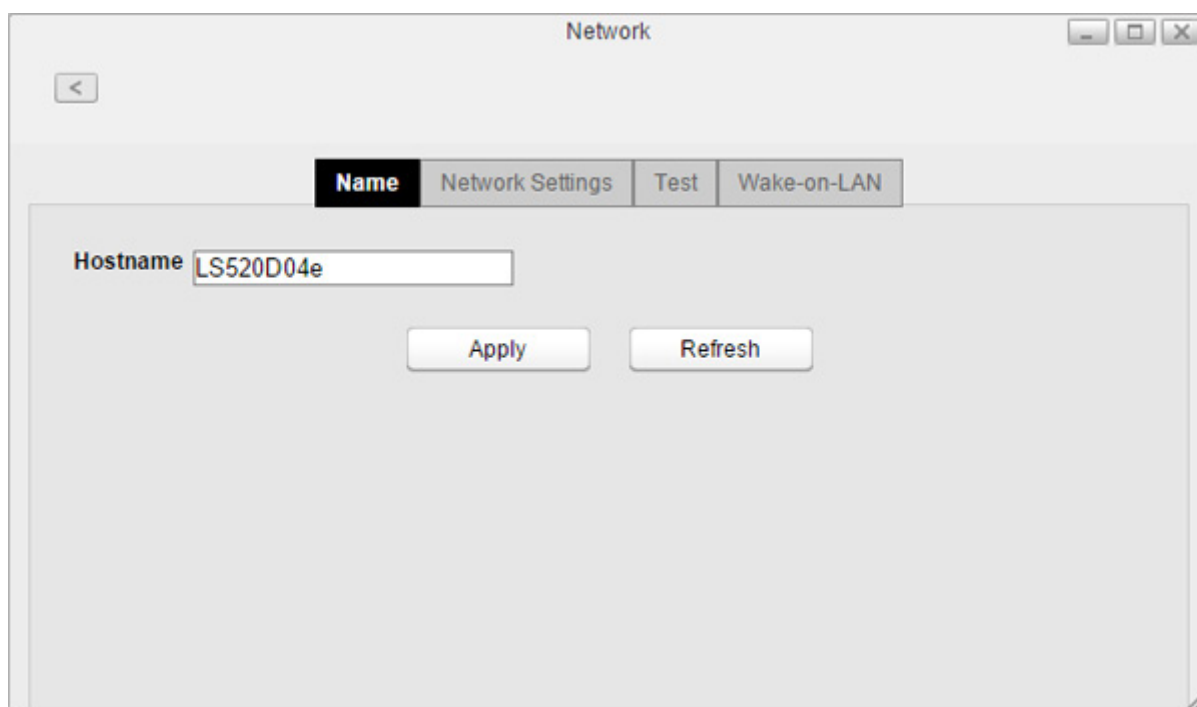

Note: A hostname may contain up to 15 alphanumeric characters.

Changing the IP Address

1 In Settings, click *System Settings*.

2 Click *Network*.

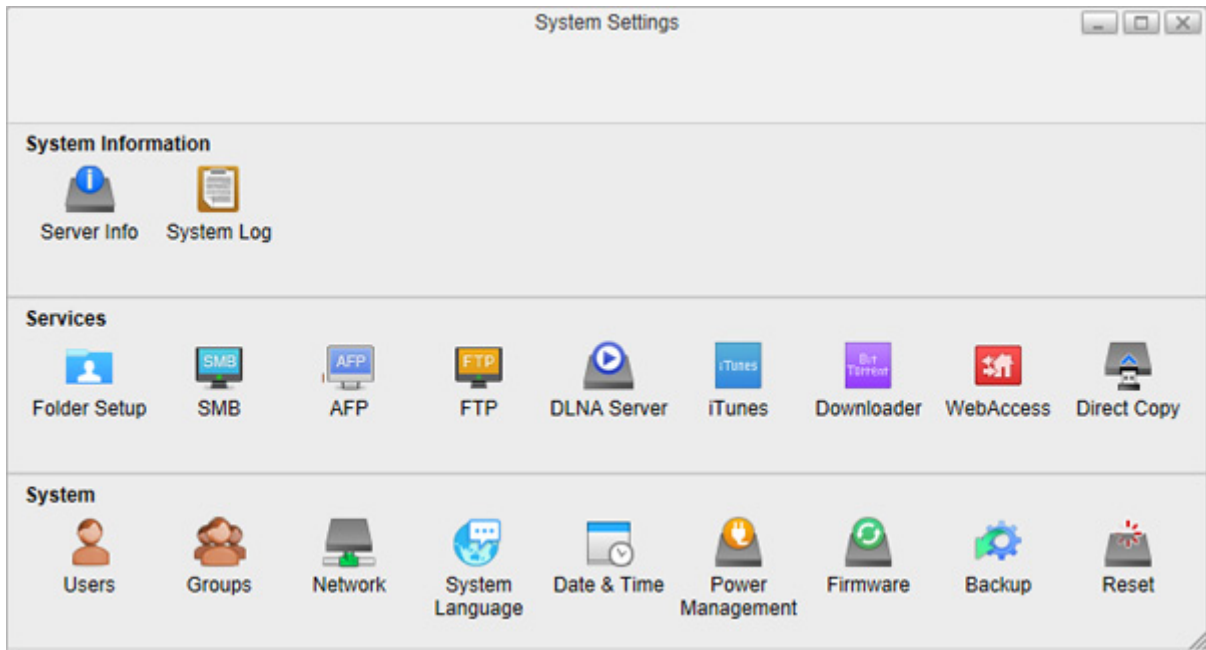

3 Click the *Network Settings* tab.

4 Select *Static IP*, enter the desired network address settings, and click *Apply*.

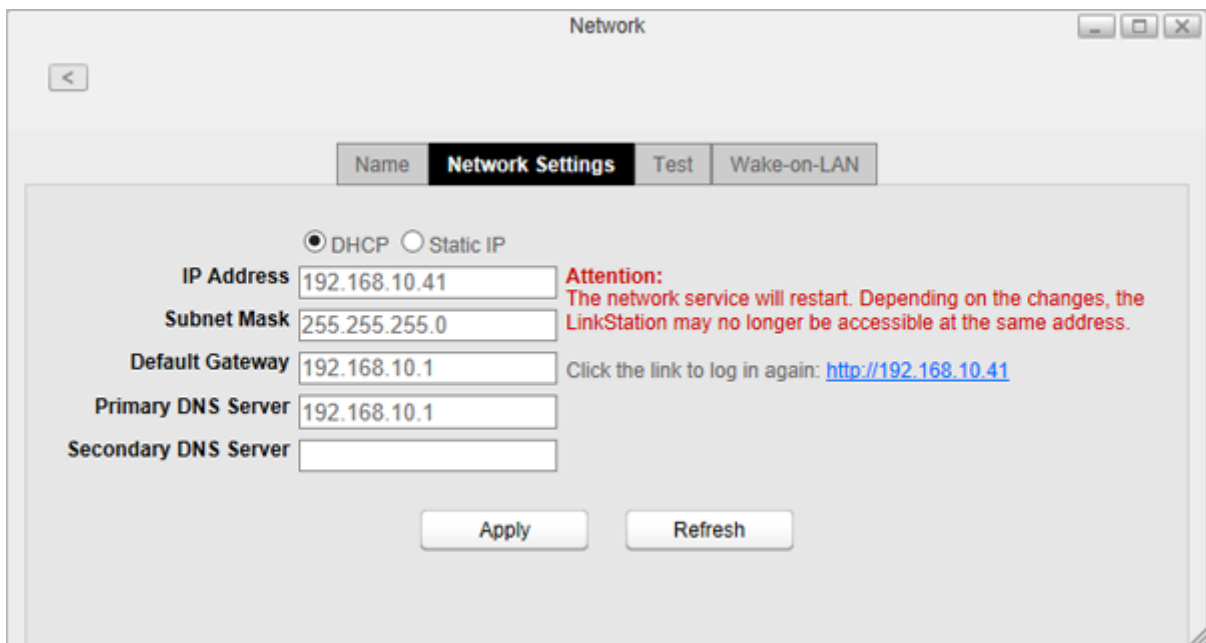

Note: The following IP addresses are reserved and should not be used. If you configure one of them by accident, initialize settings with the function button on the LinkStation.

- Local loopback address: 127.0.0.1, 255.255.255.0
- Network address: 0.0.0.0, 255.255.255.0
- Broadcast address: 255.255.255.255, 255.255.255.0
- The IP address range from 224.0.0.0 to 255.255.255.0

Wake-on-LAN

The LinkStation supports Wake-on-LAN, which allows it to be turned on remotely. You can only wake the LinkStation up when the LinkStation is in sleep (standby) mode.

Note: To use Wake-on-LAN, you'll need Wake-on-LAN software that sends magic packets. The LinkStation does not include Wake-on-LAN software.

1 In Settings, click *System Settings*.

2 Click *Network*.

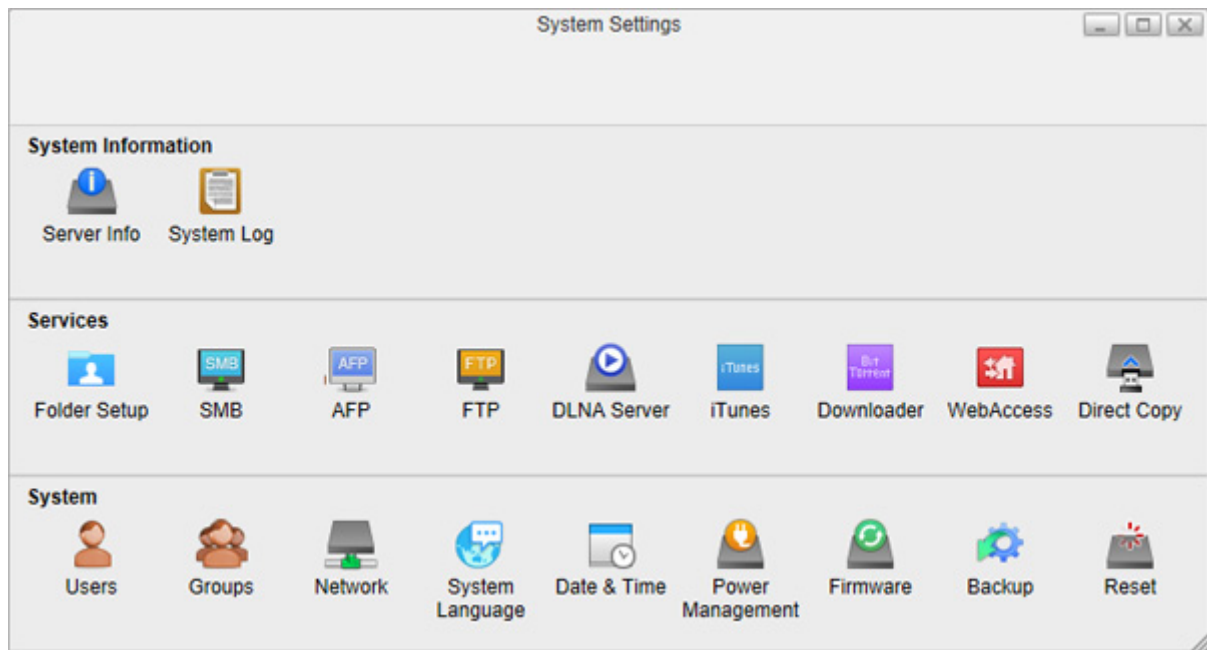

3 Click the *Wake-on-LAN* tab and check "Enable Wake-on-LAN" to enable Wake-on-LAN.

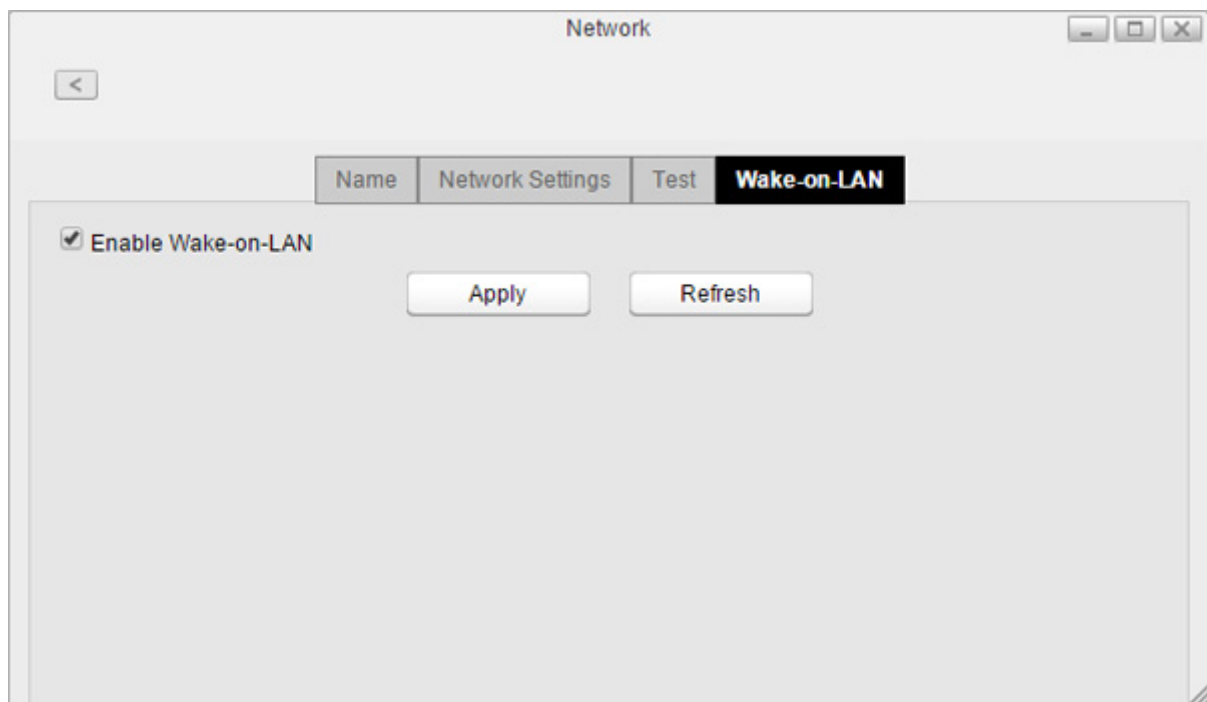

System Language

Changing System Languages

This setting changes the language used by the LinkStation for DLNA. To change the language displayed in Settings, refer to the "Changing Display Languages" section in chapter 2.

- 1 In Settings, click *System Settings*.
- 2 Click *System Language*.

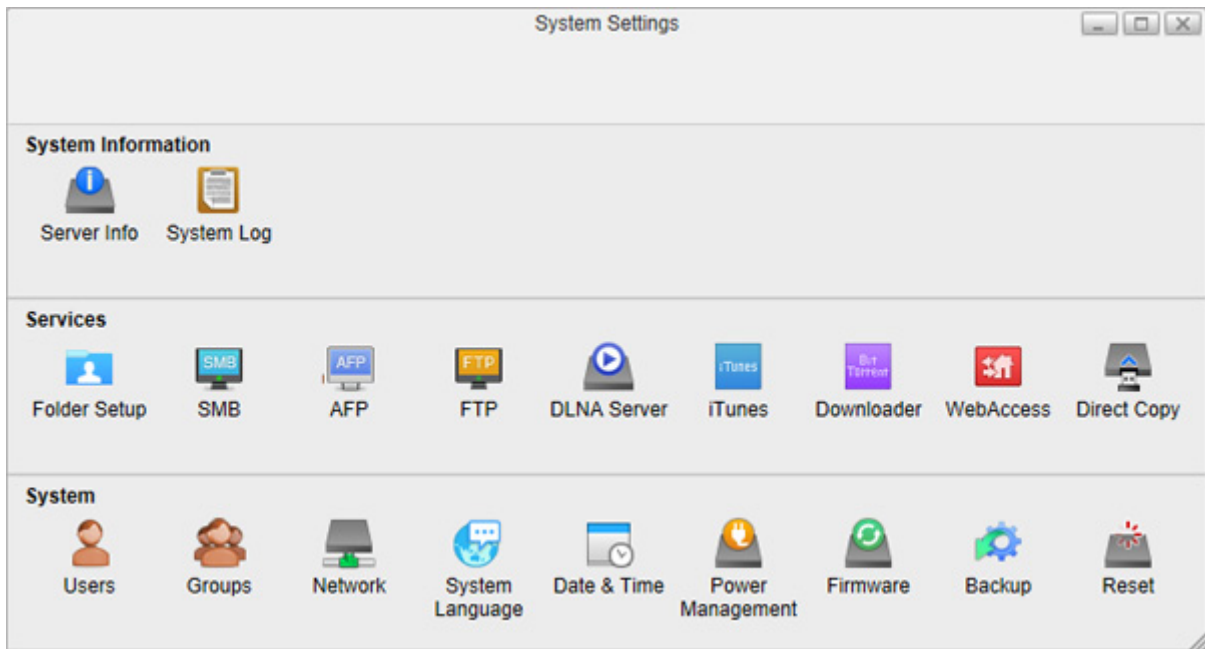

- 3 Select the language from the drop-down list of "Language" and click *Apply*.

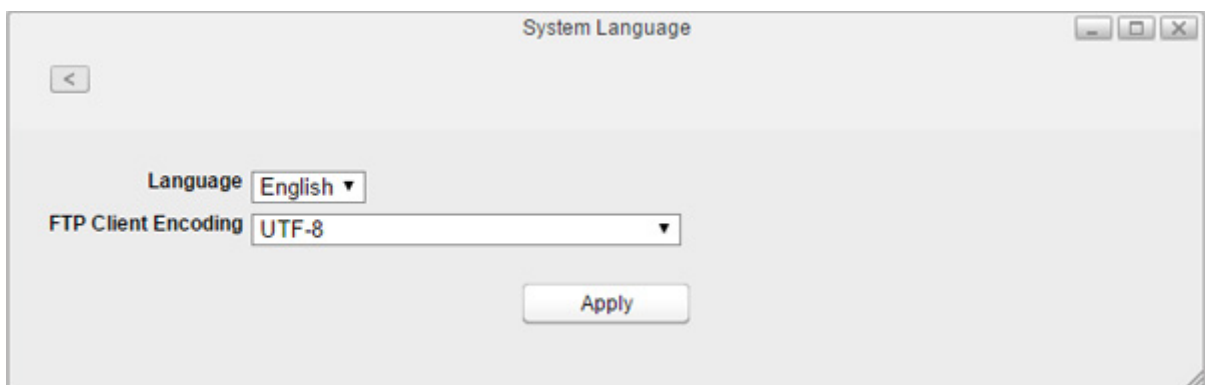

Changing FTP Client Character Encoding

To change the FTP client's character encoding settings, follow the procedure below. These encoding settings should match your FTP client's settings. If these settings do not match those of the FTP client, characters in a filename may not display properly.

- 1 In Settings, click *System Settings*.

2 Click *System Language*.

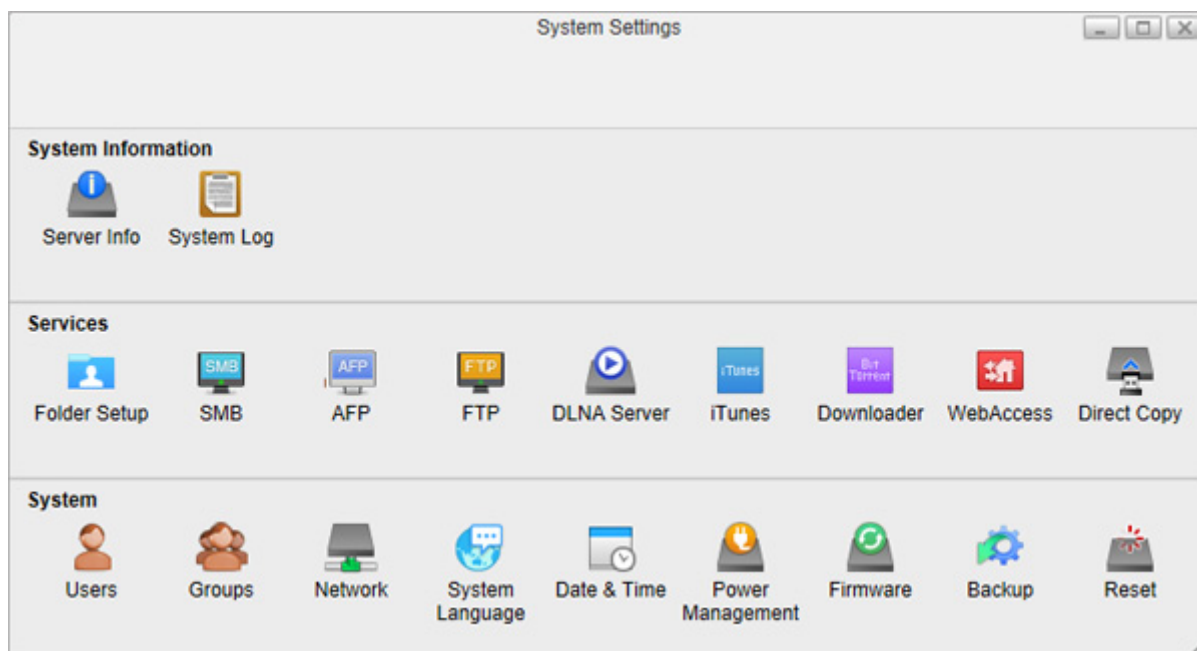

3 Select the character encoding from the drop-down list of "FTP Client Encoding" and click *Apply*.

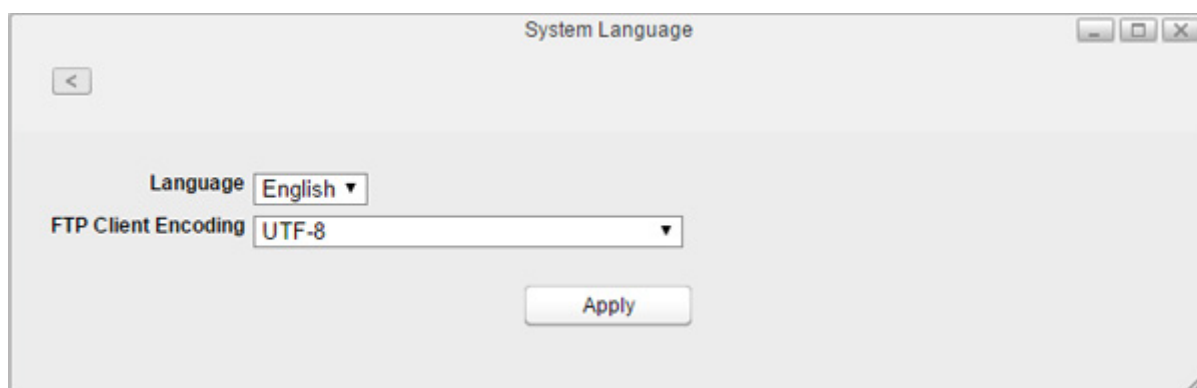

Date & Time

Configures time settings such as date and time, time zone, or NTP settings.

Changing Date and Time

1 In Settings, click *System Settings*.

2 Click *Date & Time*.

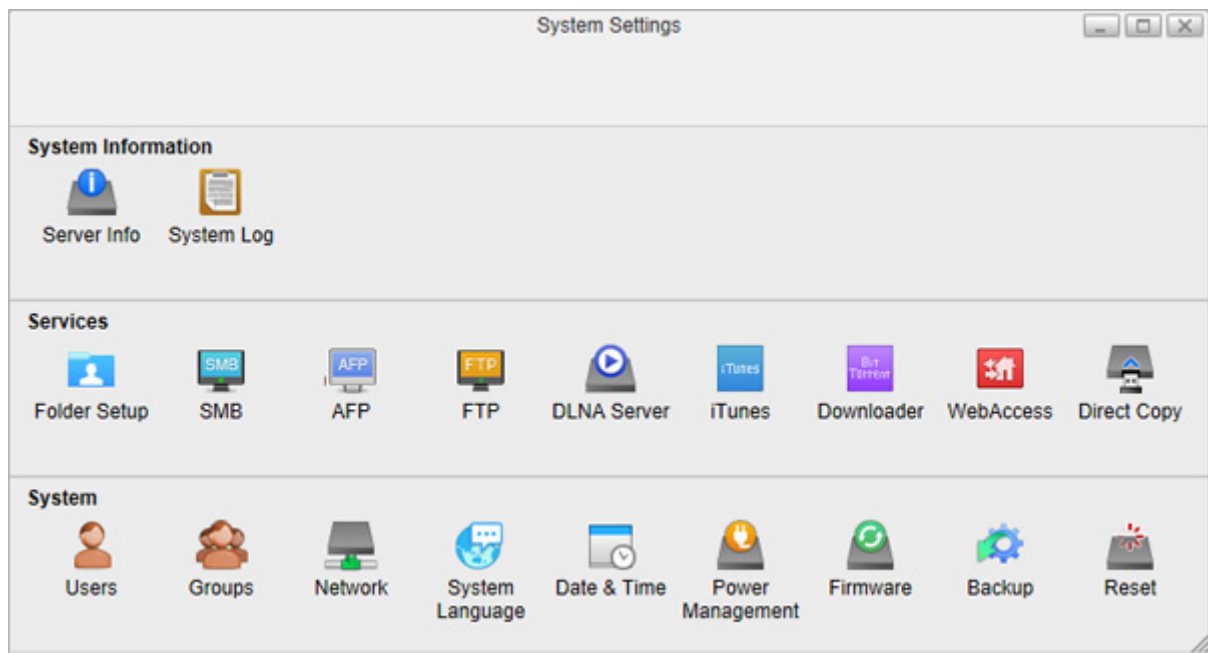

3 Click the *Date & Time* tab.

4 Select whether to enable NTP or manually set the date and time.

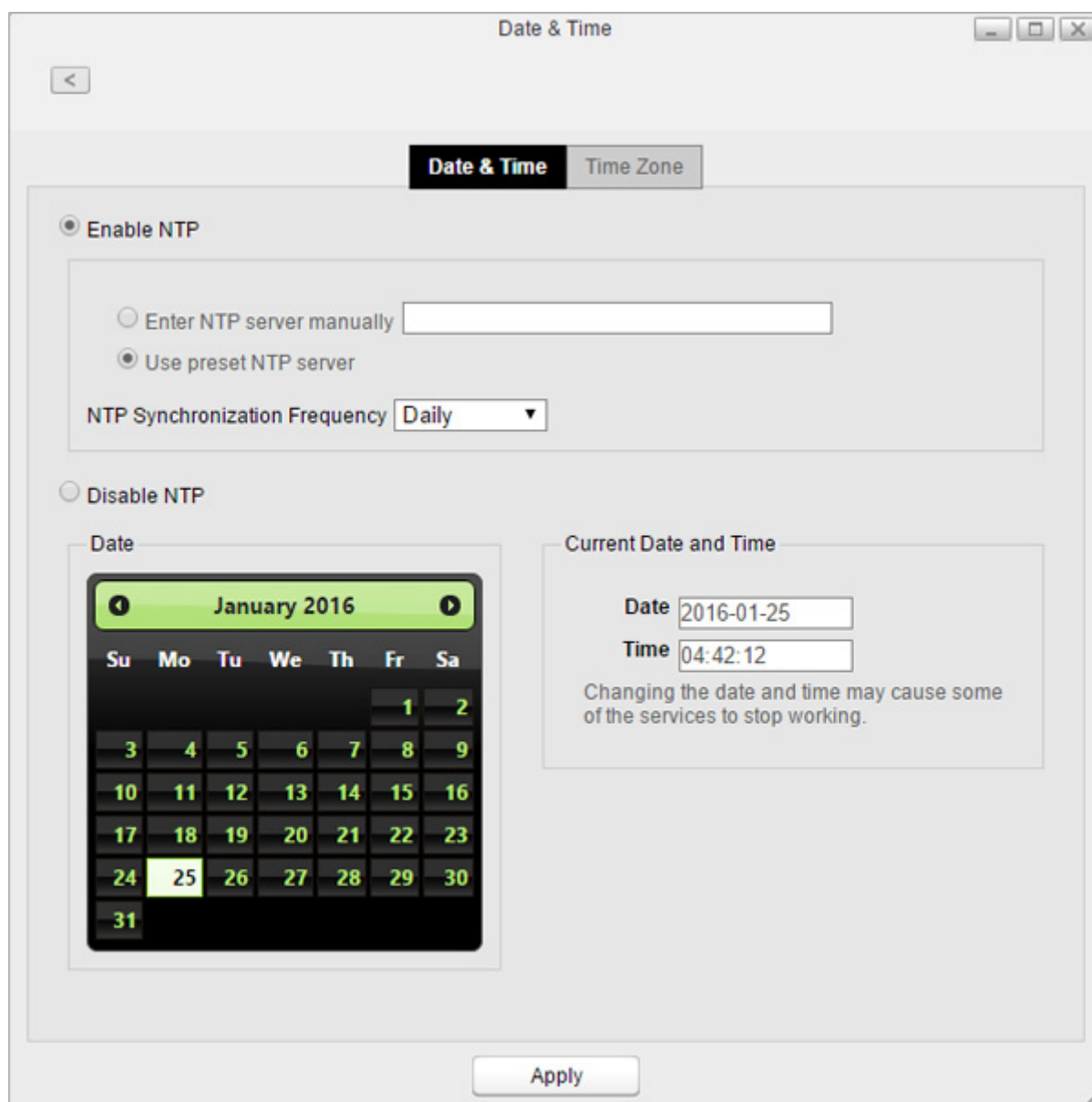

If NTP is enabled, the LinkStation adjusts its clock automatically by using the NTP server. You can either enter the NTP server manually, or use a preset NTP server on the LinkStation and how often to sync with it. If disabled, select the date from the calendar or enter the date into the "Date" box, and enter the time directly into the "Time" boxes.

5 Click *Apply*.

Changing Time Zone

1 In Settings, click *System Settings*.

2 Click *Date & Time*.

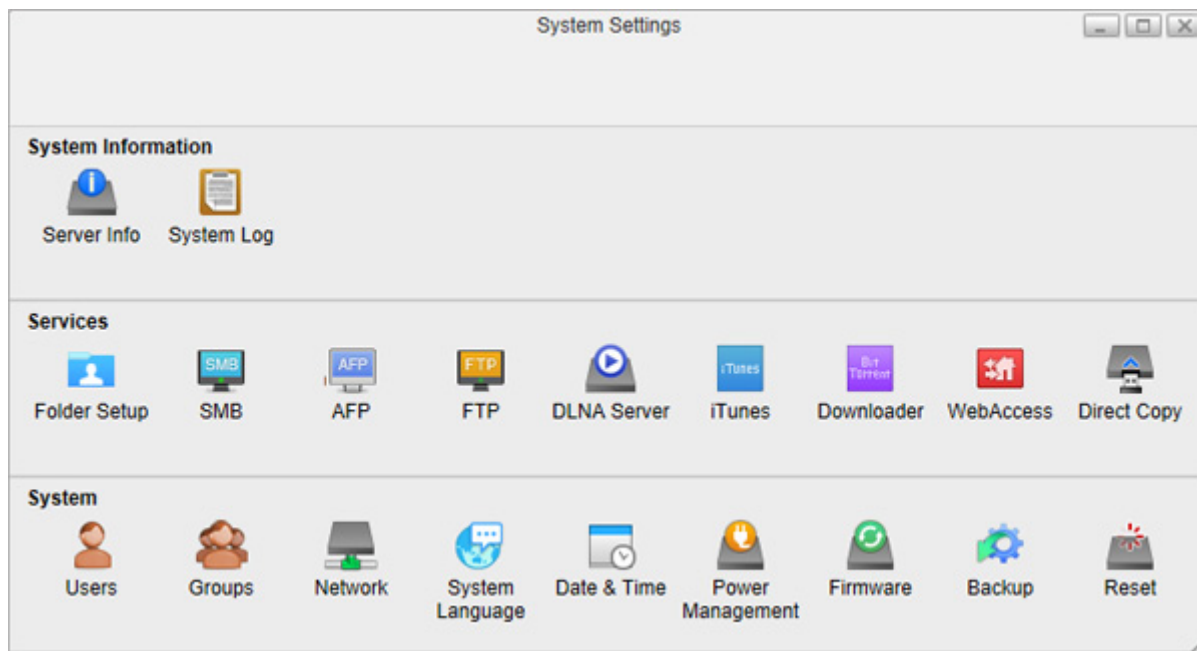

3 Click the *Time Zone* tab and select the desired time zone from the list, then click *Apply*.

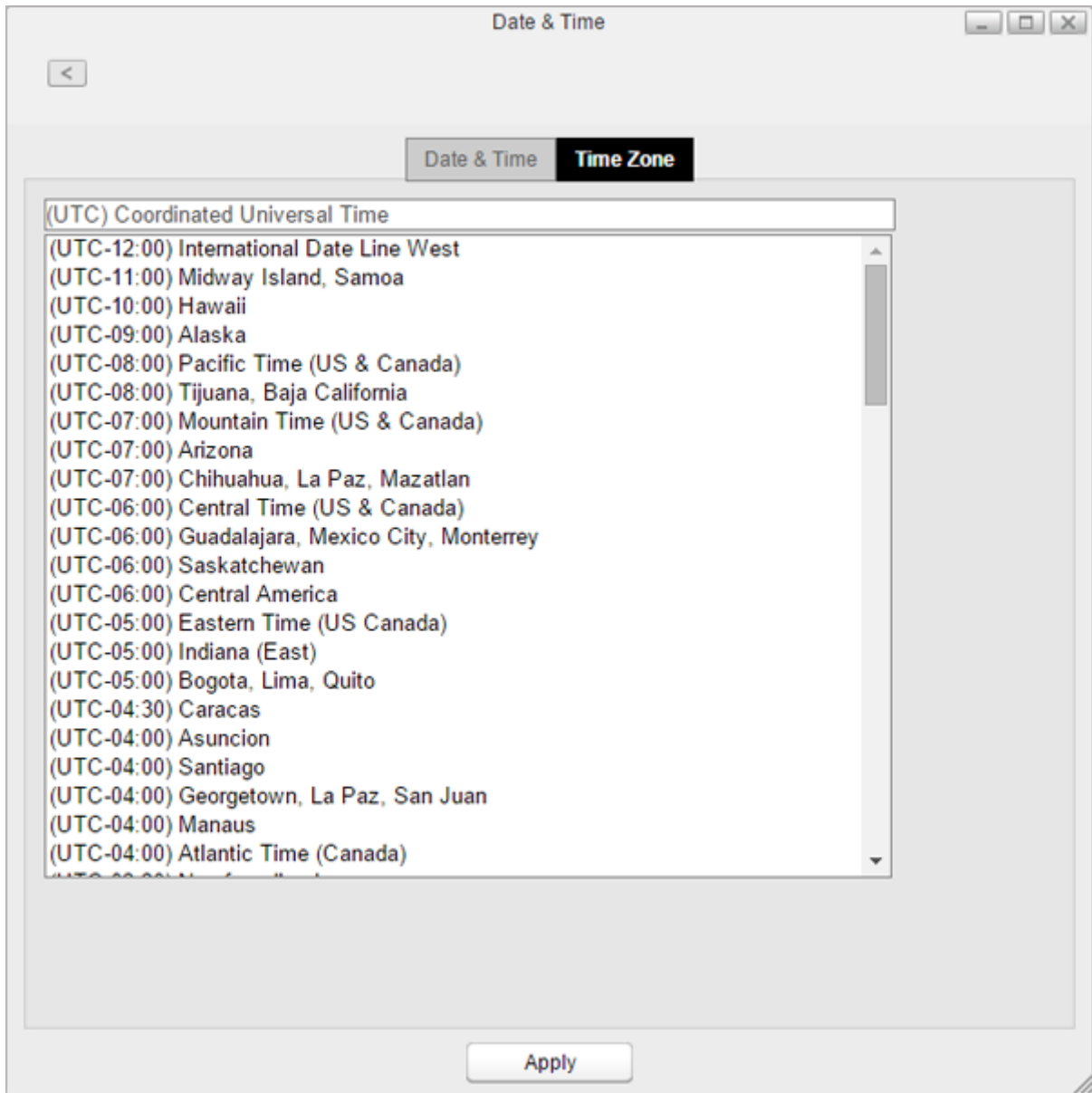

Power Management

Configures sleep settings for the system or hard drives.

Drive Spin Down

With this function, only hard drives will enter sleep mode. This may help maintain hard drive longevity. While in spin down, hard drives will start working again once the LinkStation is accessed.

1 In Settings, click *System Settings*.

2 Click *Power Management*.

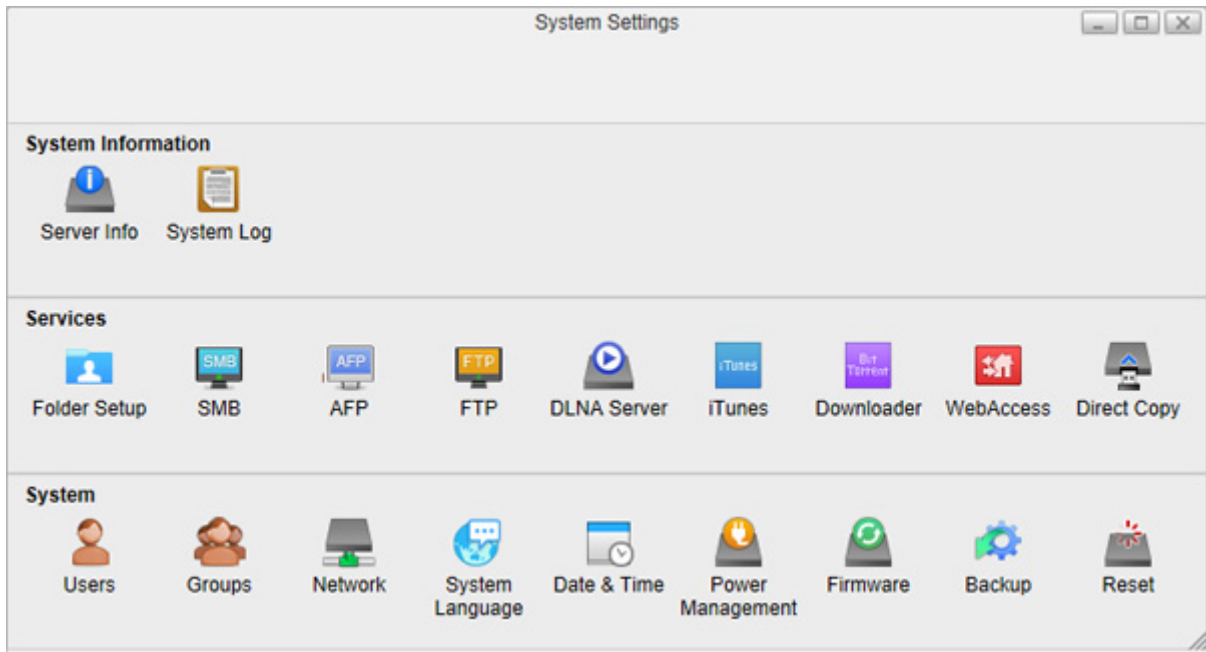

3 Click the *Drive Sleep* tab and configure the time interval when the hard drive will spin down. For example, if you select 5 minutes as the standby time, the hard drive will spin down 5 minutes after no drive access.

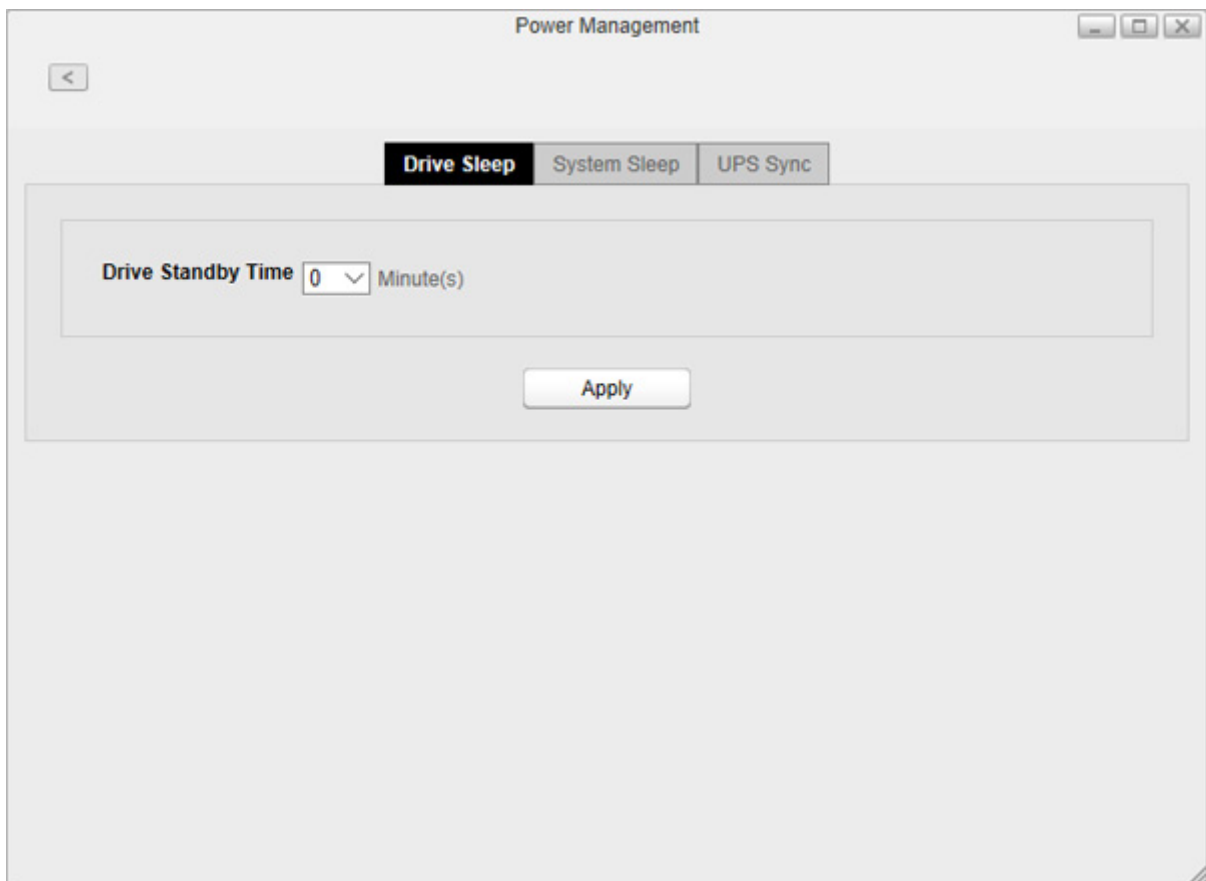

4 Click *Apply*.

Note: If you configure spin down settings after formatting internal drives or creating the RAID array, drive spin down will not occur during specific periods because the formatting process is still working in the background.

Sleep Mode

To save energy, you can configure a timer to have the LinkStation enter sleep (standby) mode at a designated time, where all hard drives and LEDs are turned off.

1 In Settings, click *System Settings*.

2 Click *Power Management*.

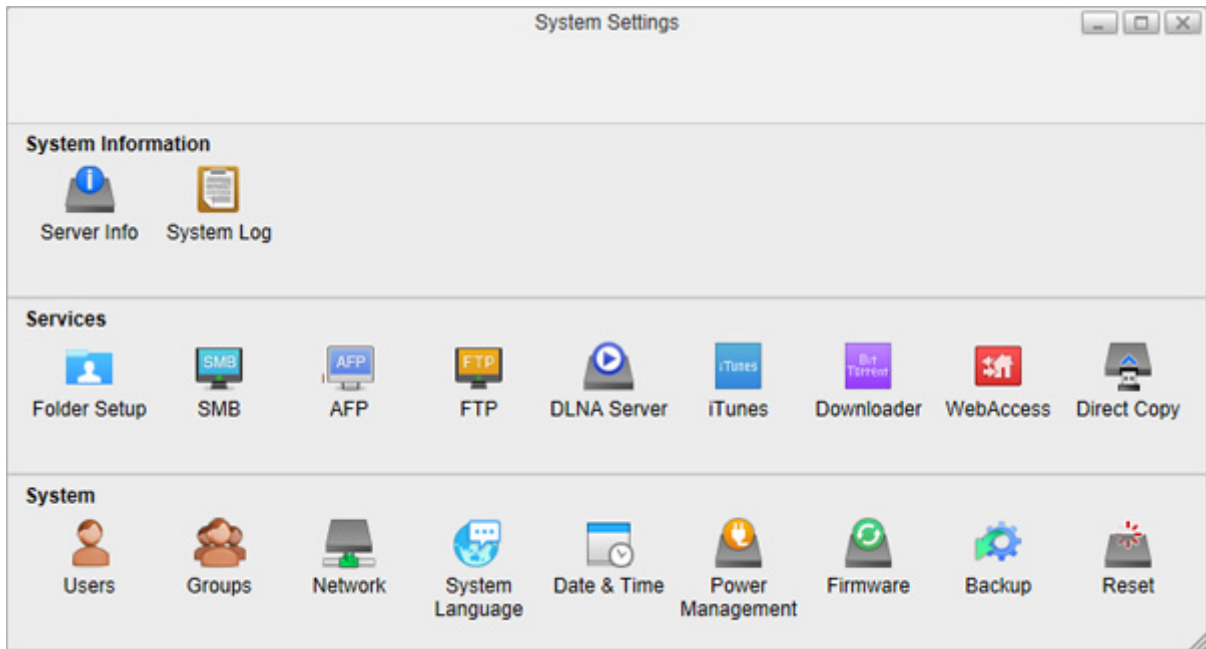

3 Click the *System Sleep* tab.

- 4 Select the timer interval from "Daily" or "Weekly", time to go into sleep mode, and how long the LinkStation will be in sleep mode.

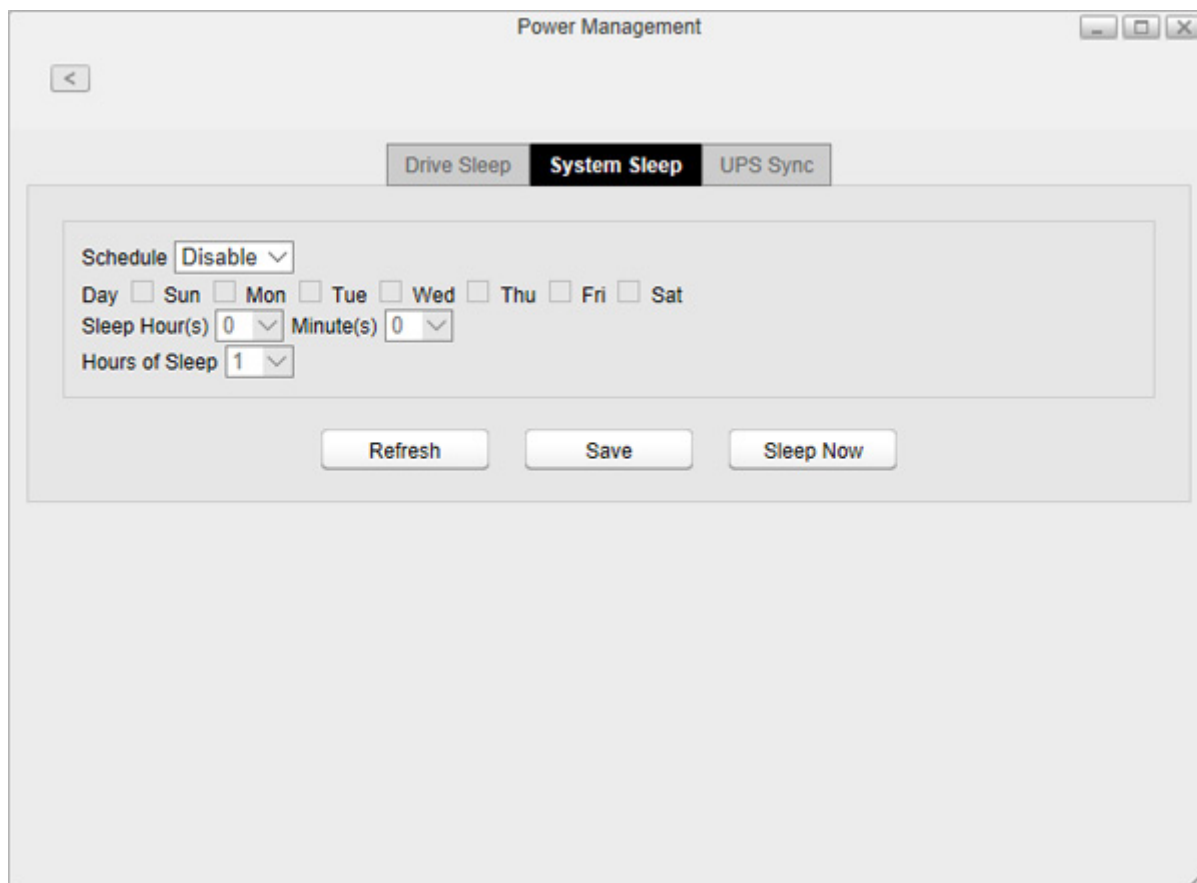

- 5 Click *Save*. If you want to make the LinkStation enter sleep mode immediately, click *Sleep Now*.

Notes:

- Examples of multiple timer settings are shown below.

Example 1:

If running at a current time of 10:00 Wednesday

Schedule: Daily

Sleep Hour: 0:00

Hours of Sleep: 12

The unit goes into sleep mode at 12:00 a.m. and wake up after 12 hours, 12:00 p.m. on Thursday.

Example 2:

If running at a current time of 10:00 Wednesday

Schedule: Weekly Wednesday

Sleep Hour: 20:00

Hours of Sleep: 12

On every Wednesday, the unit goes into sleep mode at 8:00 p.m. and wake up after 12 hours, 8:00 a.m. on Thursday.

- To turn on the LinkStation before the wake-up time when it is in sleep mode, press the function button, use Wake-on-LAN, or turn off, then on the LinkStation.

UPS Sync

If a UPS (Uninterruptible Power Supply, sold separately) is attached, the LinkStation can be automatically shut down to protect data in the event of a power outage.

- 1 Plug the power cable of the UPS wall socket.

2 Connect the AC cable of the LinkStation to the UPS.

3 Connect the UPS and LinkStation using a USB cable.

4 Turn on the UPS, then the LinkStation.

5 In Settings, click *System Settings*.

6 Click *Power Management*.

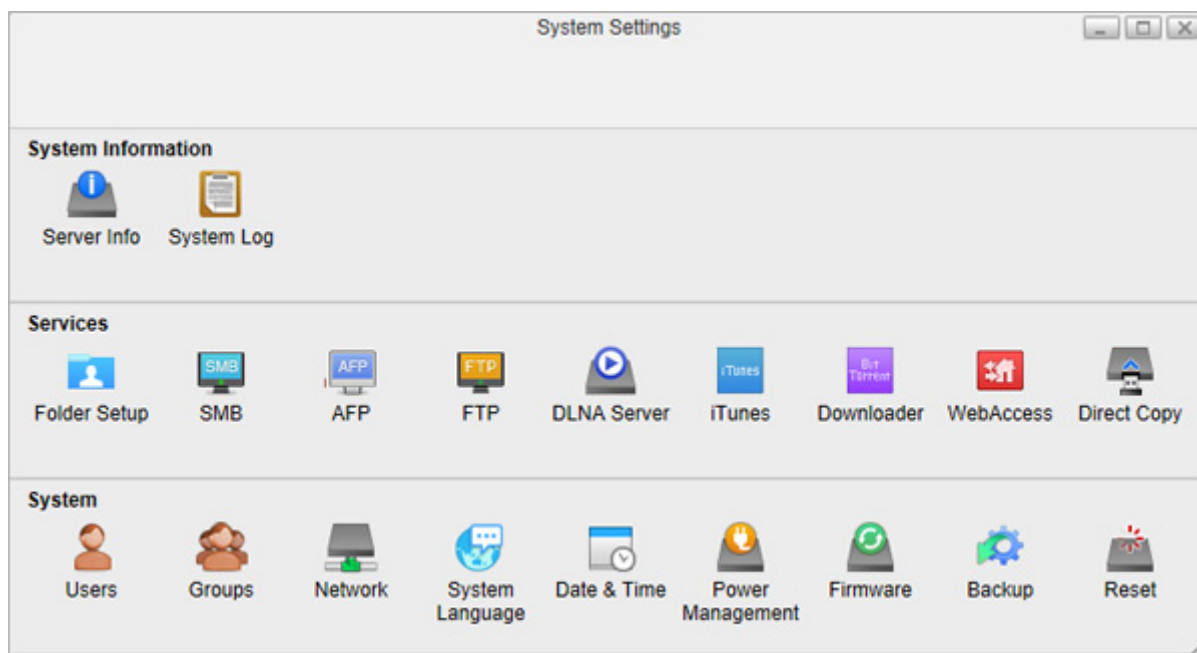

7 Click the *UPS Sync* tab.

8 Configure the desired settings, then click *Save*.

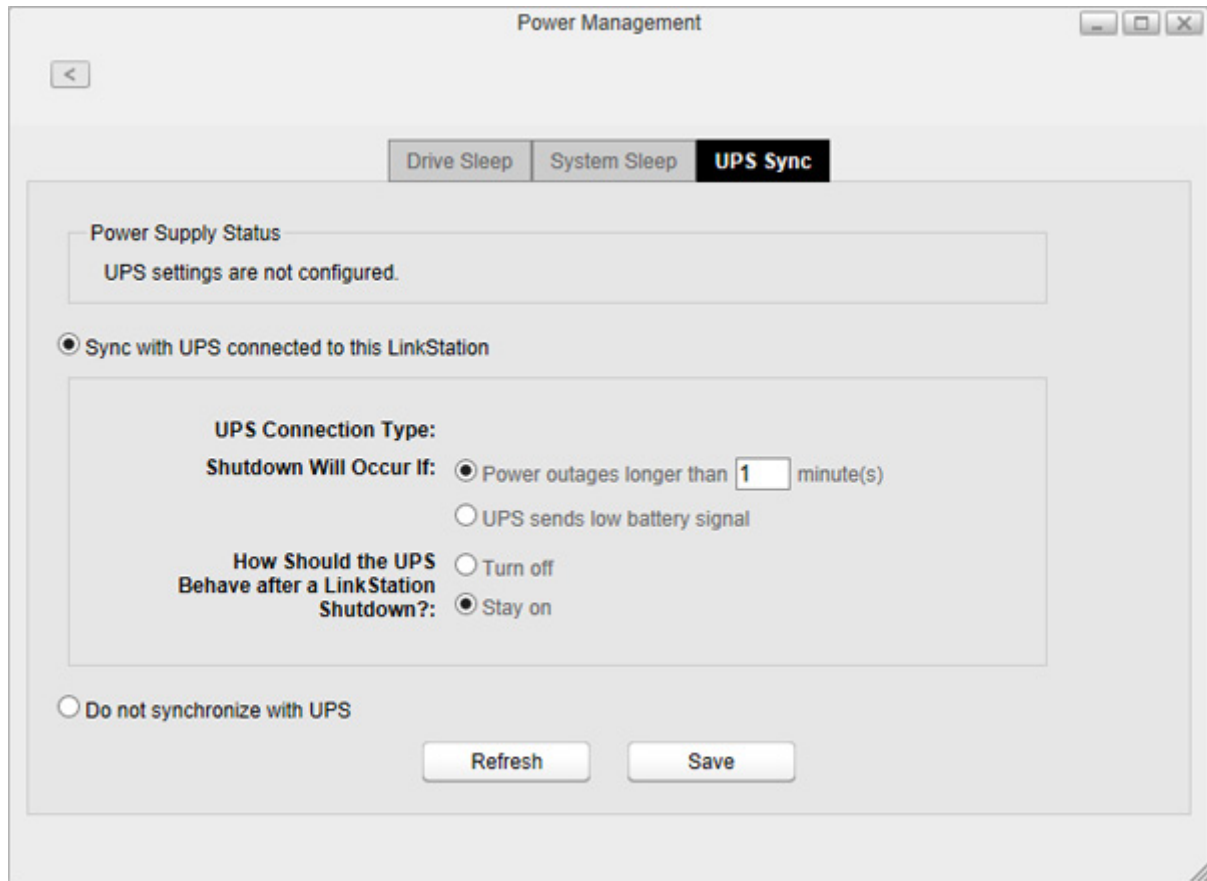

Note: When the LinkStation restarts after an automatic shutdown, such as from a power outage or power supply problem, verify that the power supply has been restored. If the LinkStation is turned on while it is still running on the UPS and the power supply has not been restored, automatic shutdown will not occur, even after the specified time has elapsed.

Firmware

Verify the firmware version or update the LinkStation's firmware. There are two ways to update the firmware.

Online Update

If a new firmware is available, a message and button are displayed in Settings.

Manual Update

You can update the LinkStation's firmware manually.

- 1** Download the latest firmware image file from the Buffalo website and save the firmware image file to the LinkStation's shared folder.

2 In Settings, click *System Settings*.

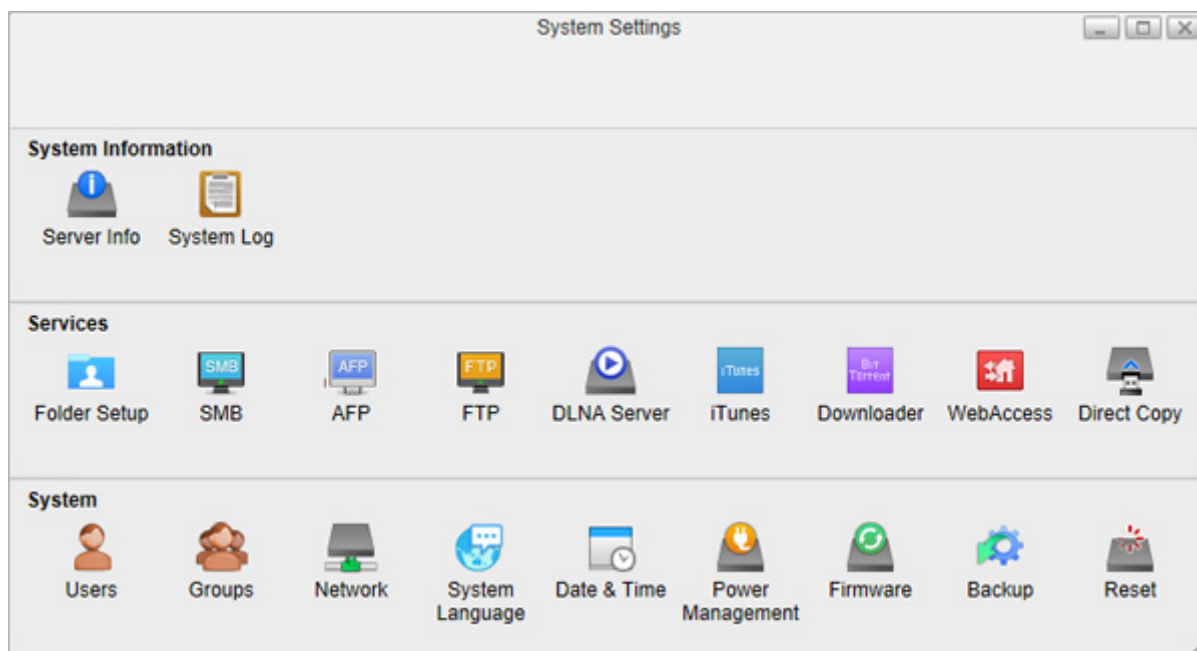

3 Click *Firmware*.

4 Click *Browse*.

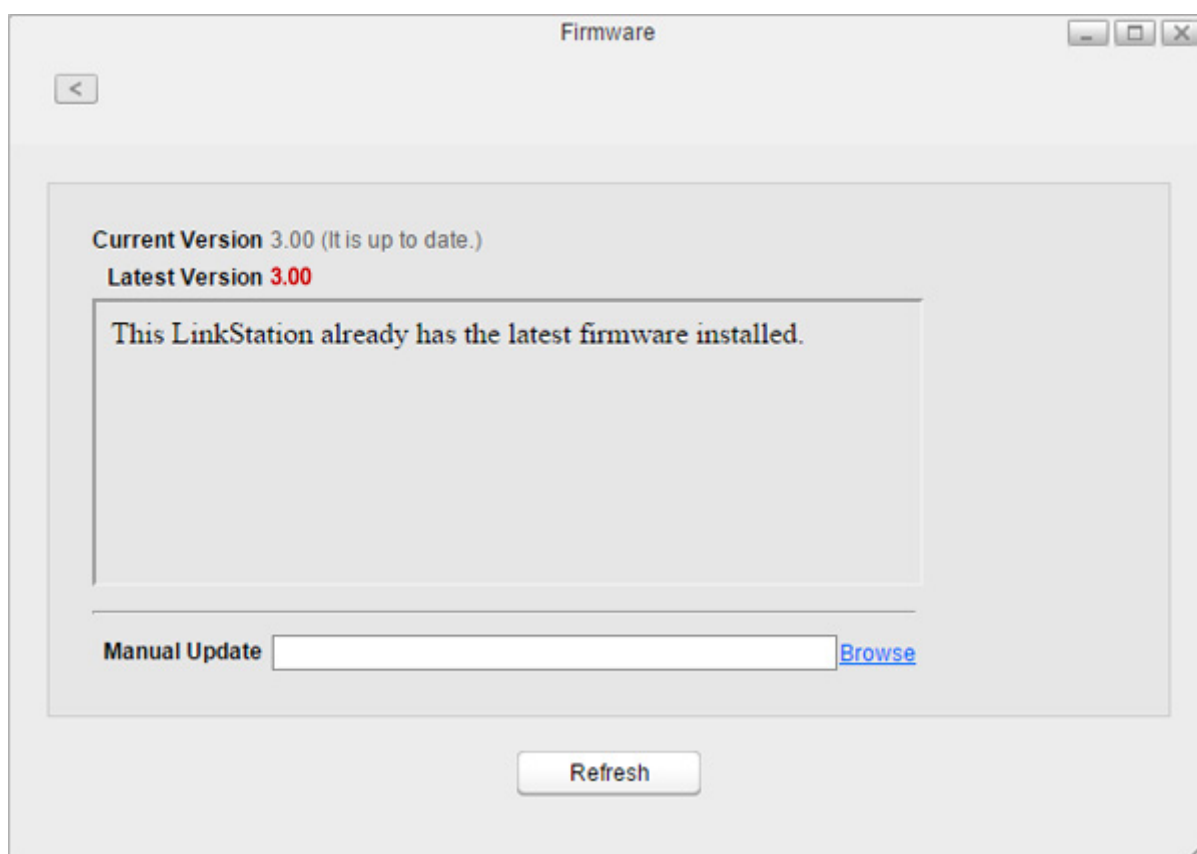

5 Specify the firmware image file that was saved in the LinkStation's shared folder and click *Open*.

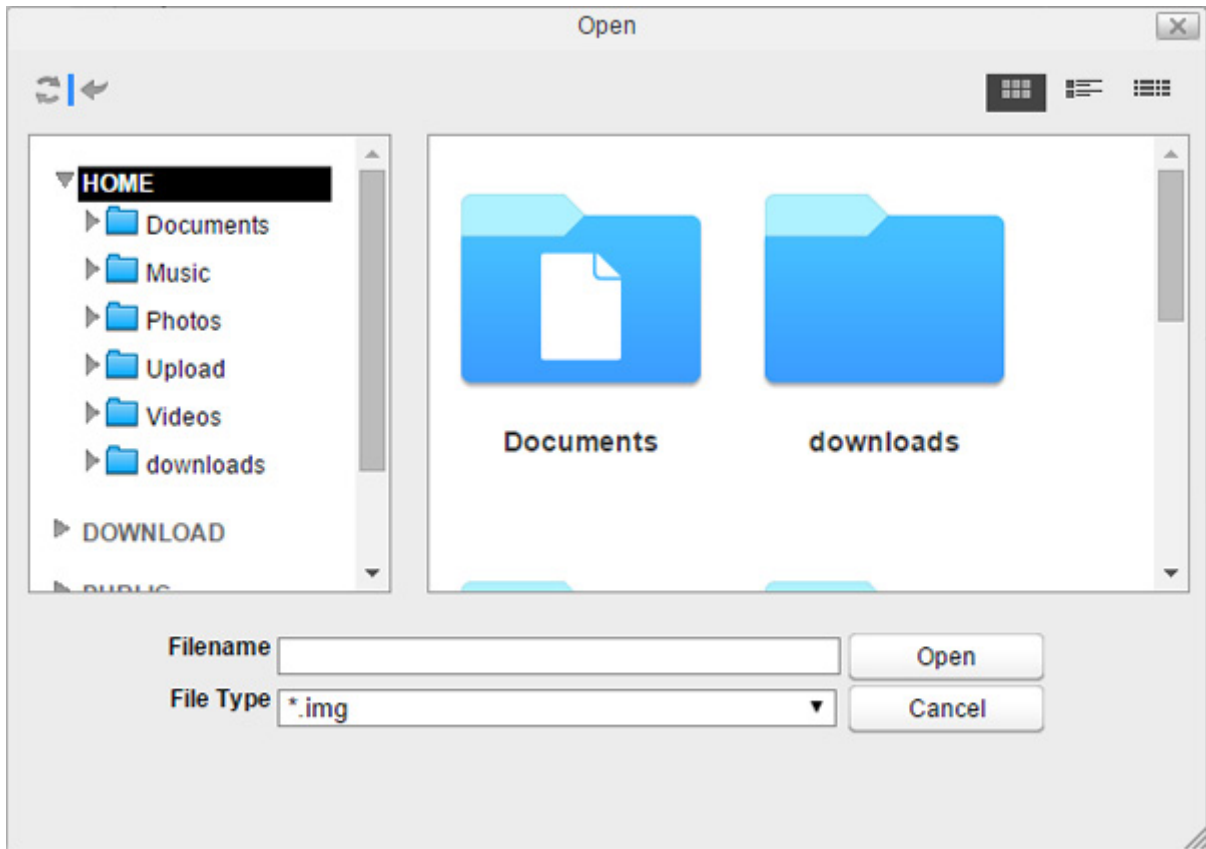

6 Click *Apply*.

7 While the firmware updates, the power LED blinks amber. Wait until the update is complete and the LED returns to white.

Backup

Backs up the data in the LinkStation to another location to avoid unexpected data failure.

Backing Up from LinkStation

You can back up a LinkStation folder to:

- A different folder on the LinkStation
- A USB device connected to the LinkStation

To create a backup job, follow the procedure below.

1 In Settings, click *System Settings*.

2 Click *Backup*.

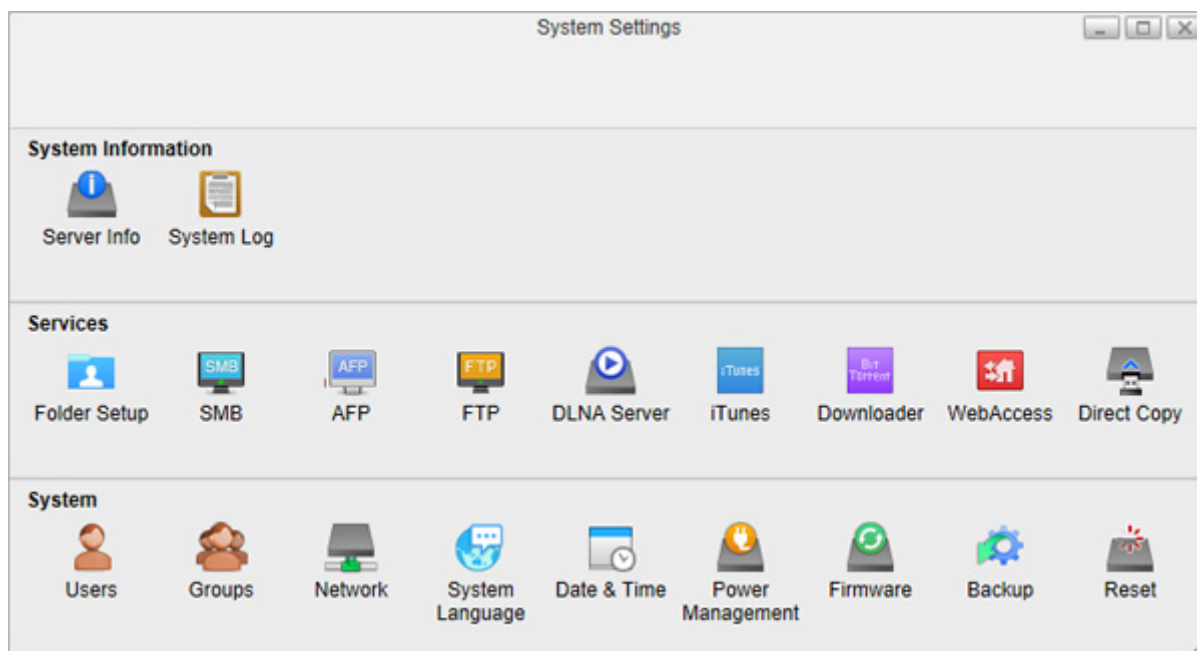

3 Enter a job name and configure backup settings such as date and time to run.

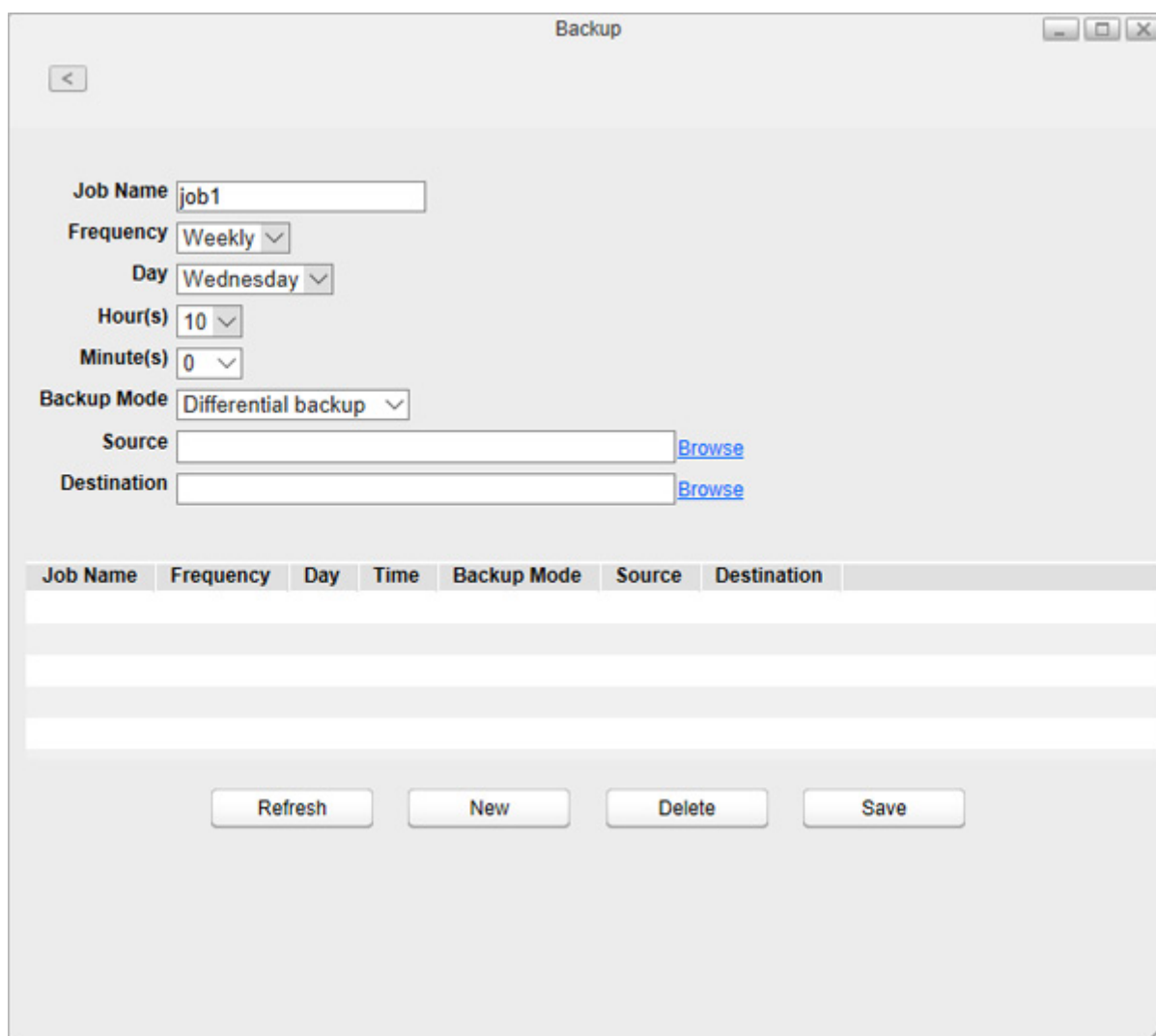

4 Select the backup mode from the drop-down list. The details of each mode are described below.

5 Click *Browse* to the right of "Source".

6 Select the folder that will be the backup source, then click *Open*.

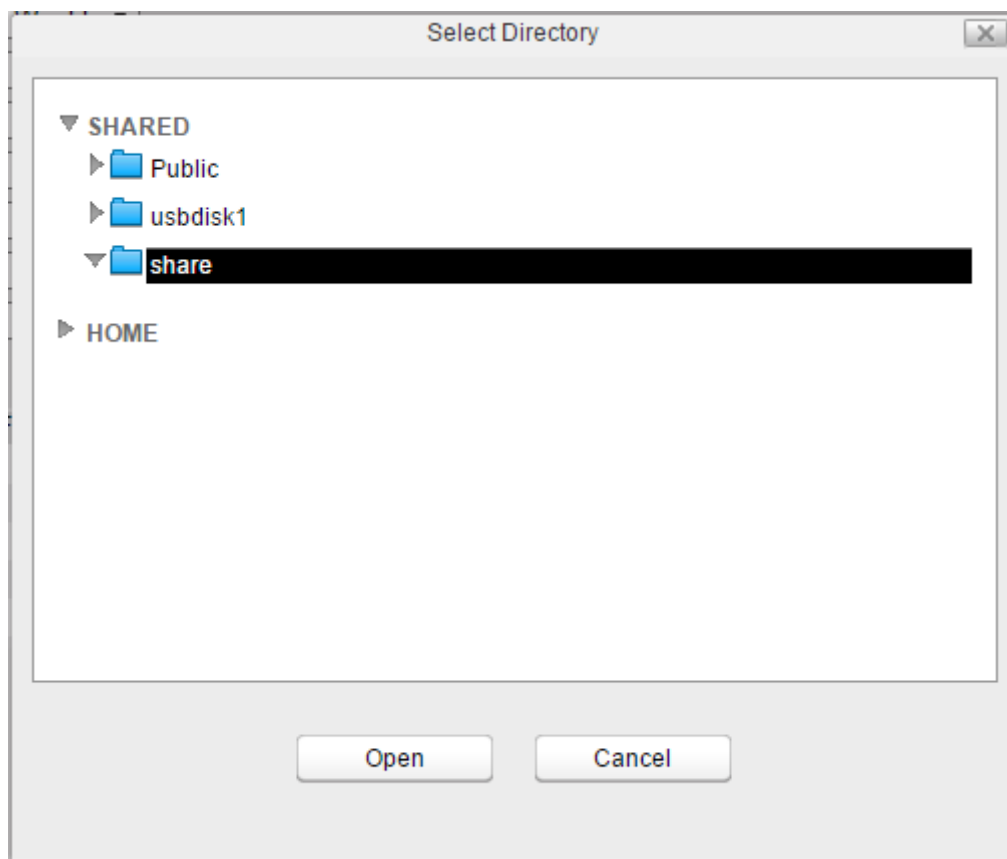

7 Click *Browse* to the right of "Destination".

Backup

Job Name

Frequency

Day

Hour(s)

Minute(s)

Backup Mode

Source [Browse](#)

Destination [Browse](#)

Job Name	Frequency	Day	Time	Backup Mode	Source	Destination

8 Select the folder that will be the backup destination, then click *Open*.

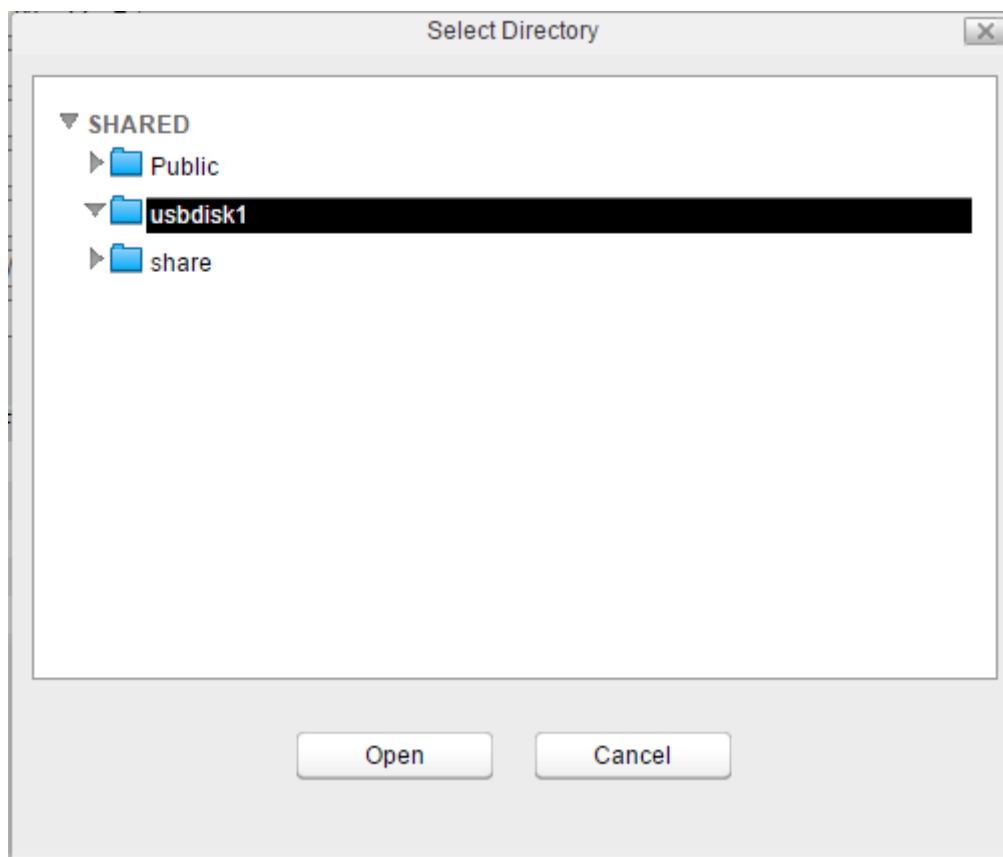

9 Click Save.

Backup

Job Name

Frequency

Day

Hour(s)

Minute(s)

Backup Mode

Source [Browse](#)

Destination [Browse](#)

Job Name	Frequency	Day	Time	Backup Mode	Source	Destination

The backup job is added to the list.

Backup Modes

Mode	Files included
Differential backup	The first backup job runs like a full backup. The backed up data will be stored under the automatically-created folder of the job name. As each additional backup job runs, files are added to and deleted from the backup folder. The backup destination folder will always be the same size as the backup source folder.
Incremental backup	The first backup job runs like a full backup. The backed up data will be stored under the automatically-created folder of the job name. In subsequent backups, files added to the source as well as files deleted from the source are kept in the backup folder.
Full backup	All files in the source will be backed up to the destination. Whenever the backup job runs, the folder with the name as the date when the backup job runs will be created automatically and the backed up data will be stored here.

Notes:

- Up to 8 backup jobs can be configured.

- When a backup job starts, a folder that contains the backup date in its folder name will be created in the backup destination automatically and all data will be backed up to that folder.
- If a backup job is scheduled to run while Direct Copy is running, the job will be canceled. The prior process will work.

Backing Up Your Mac with Time Machine

Time Machine is a backup program included with macOS. To use your LinkStation as a backup destination for Time Machine, configure it as described below.

1 In Settings, click *System Settings*.

2 Click *Folder Setup*.

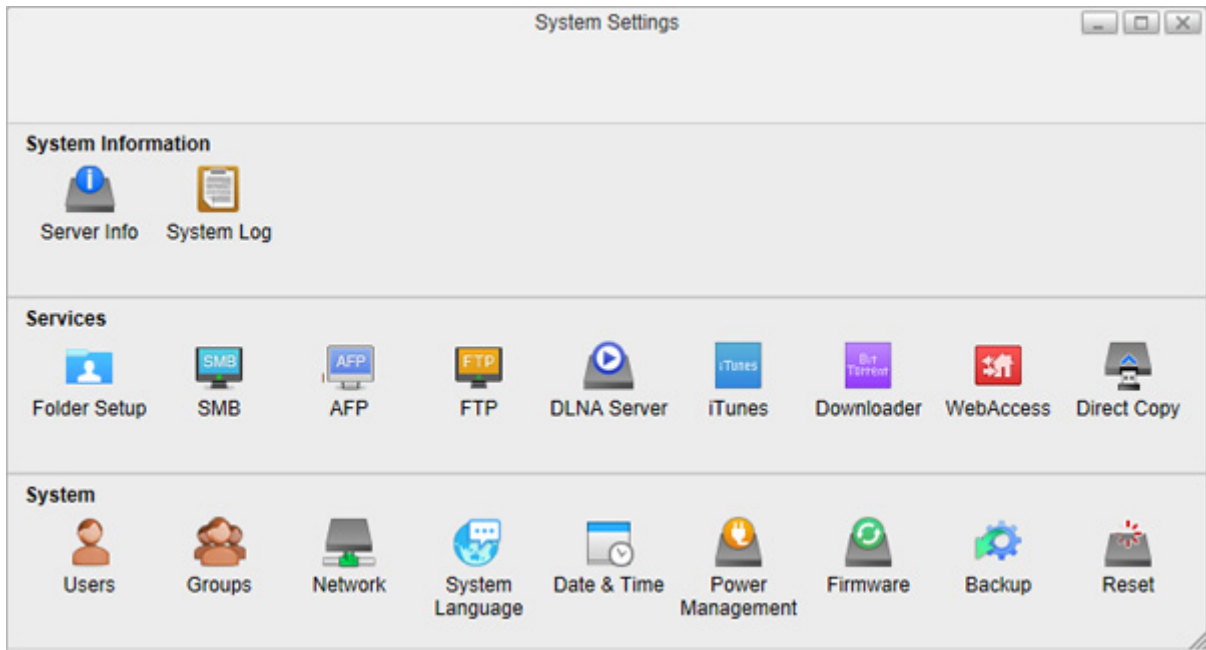

3 Choose a shared folder as your backup destination for Time Machine.

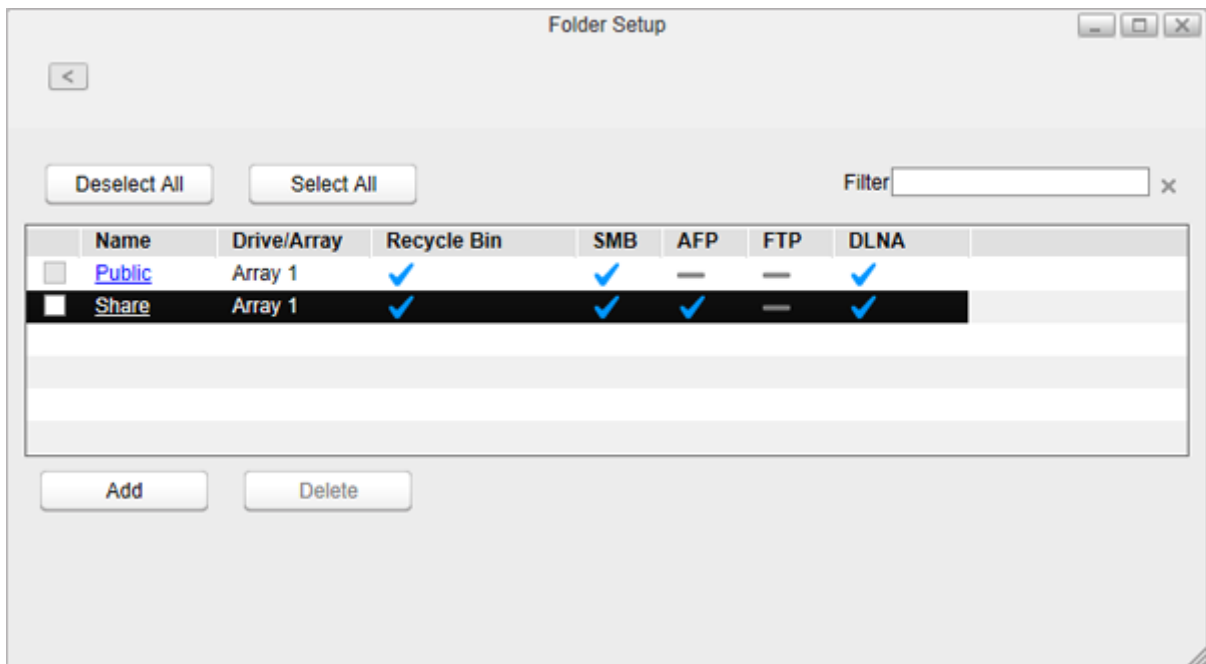

4 Select the "AFP (Mac)" and "Time Machine" checkboxes for "LAN Protocols" and click *OK*.

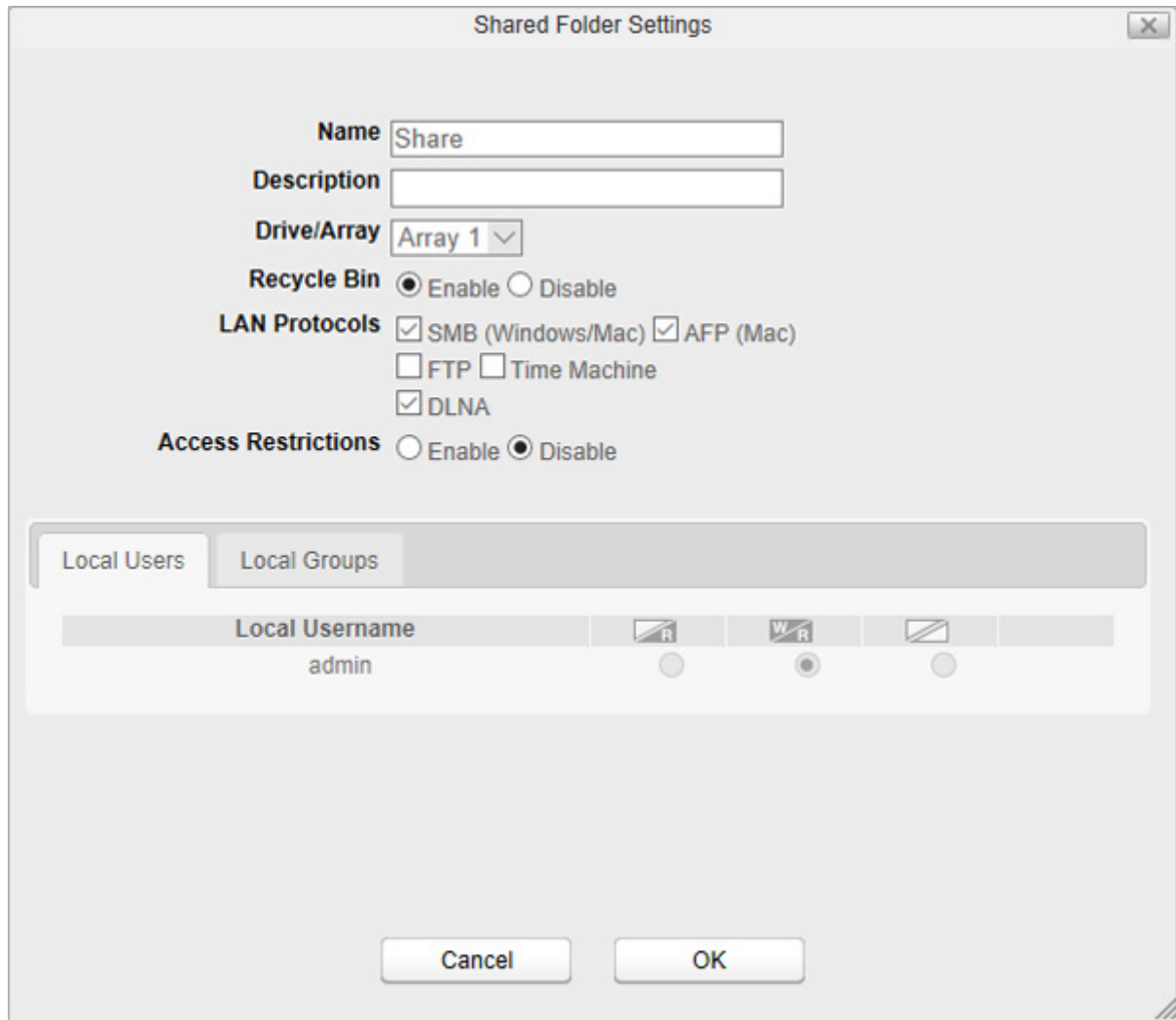

5 On the Mac, open *System Preferences*.

6 Click *Time Machine*.



7 Click *Select Backup Disk*.

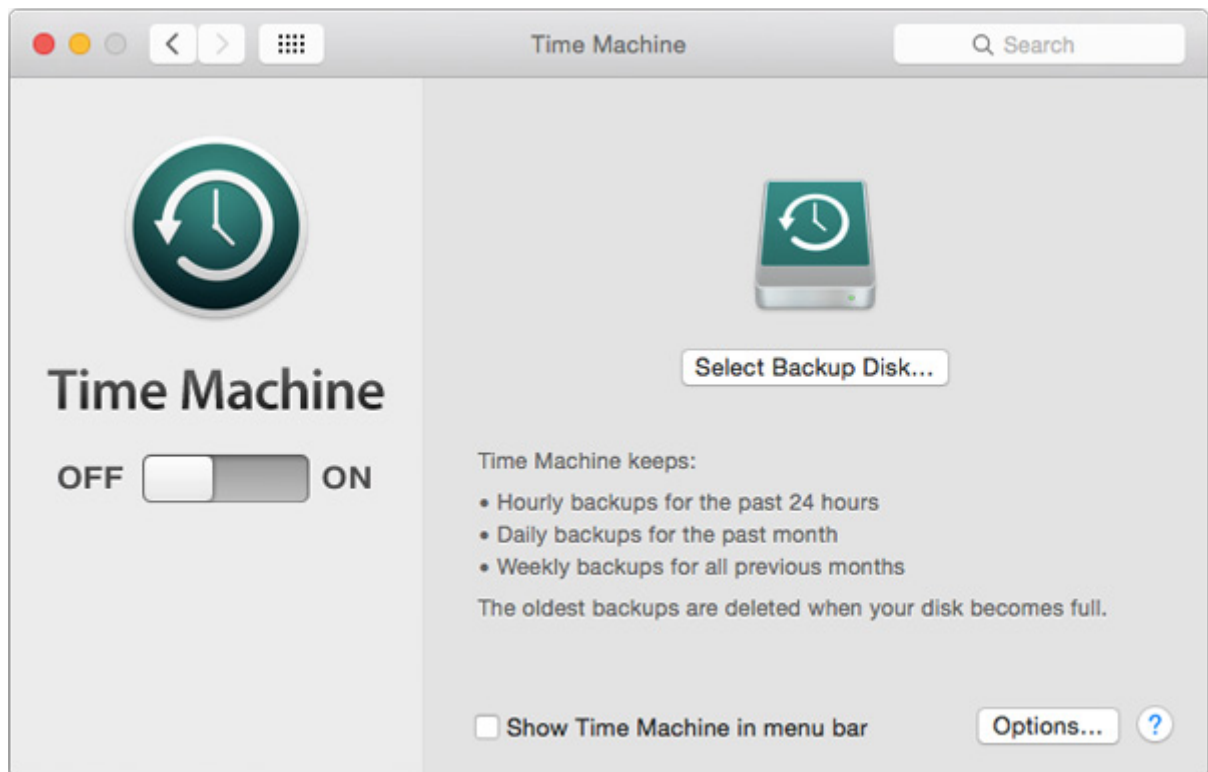

8 Select the LinkStation, then click *Use Disk*.

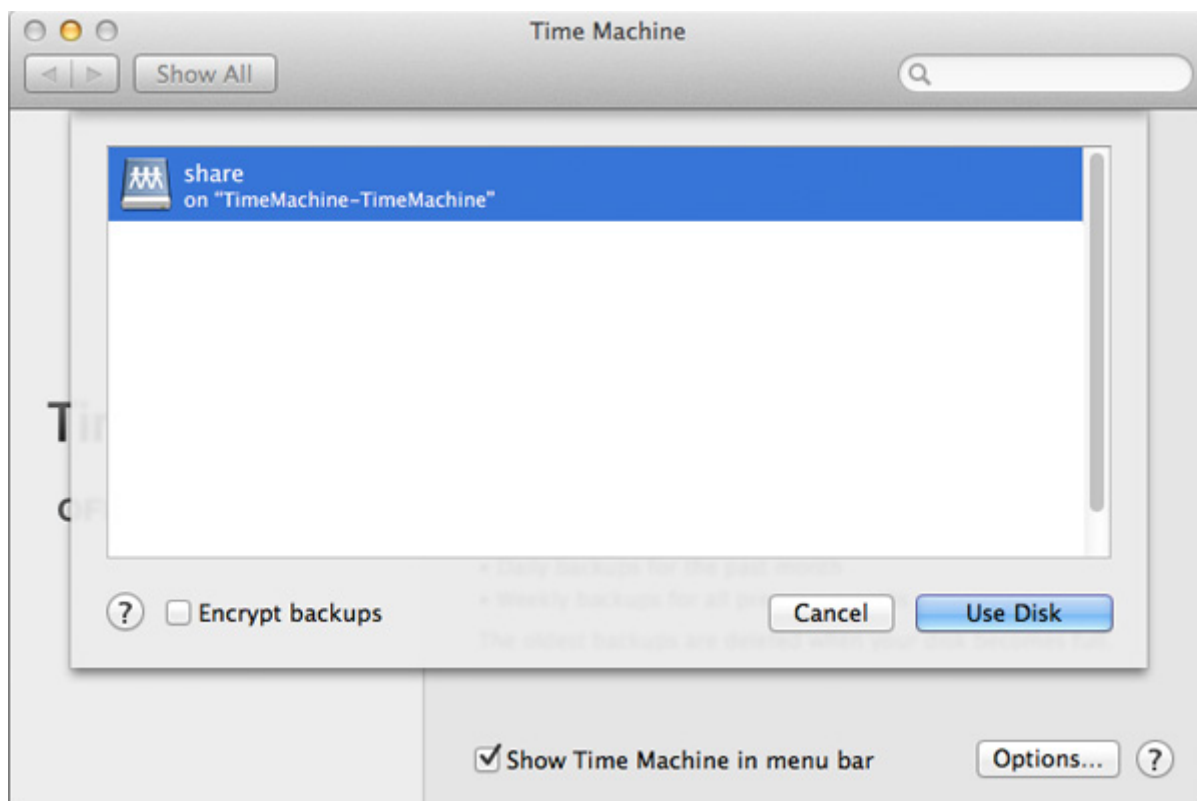

9 Enter a username and password with the rights to access the shared folder on the LinkStation, then click *Connect*.

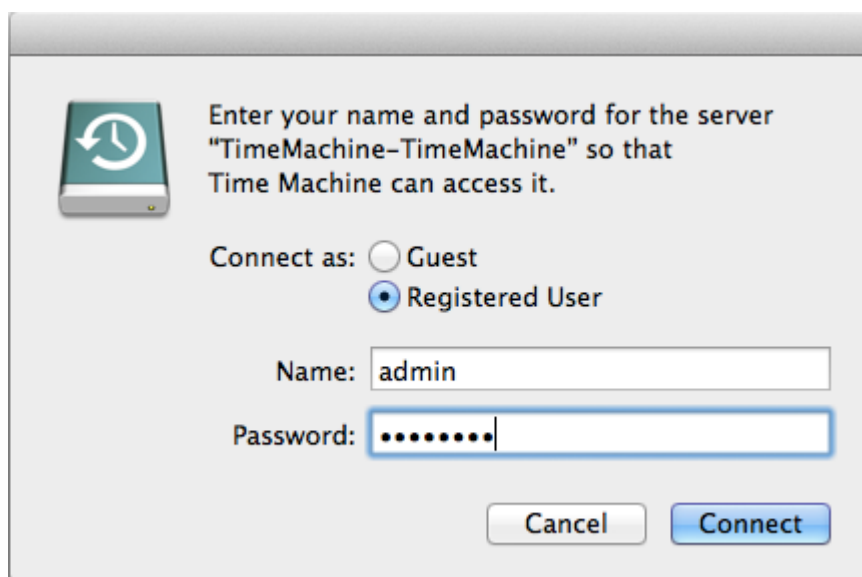

10 Time Machine will count down from 120 seconds and backup will start.



Note: A FAT32-formatted USB drive cannot be used as a Time Machine backup destination folder.

Reset

Enable or disable function button initialization or initialize the LinkStation to factory defaults from Settings.

Note: If you are using your LinkStation with 2 or more partitions and running firmware version 2.00 or earlier, you will lose your data when initializing settings because the disk management process has been changed since version 3.00. Before initializing the settings, make sure all your data has been backed up to the external device.

Initializing from Settings

When initializing the LinkStation from Settings, all values will be erased and restored to its factory default. The data stored in the LinkStation will be kept.

1 In Settings, click *System Settings*.

2 Click *Reset*.

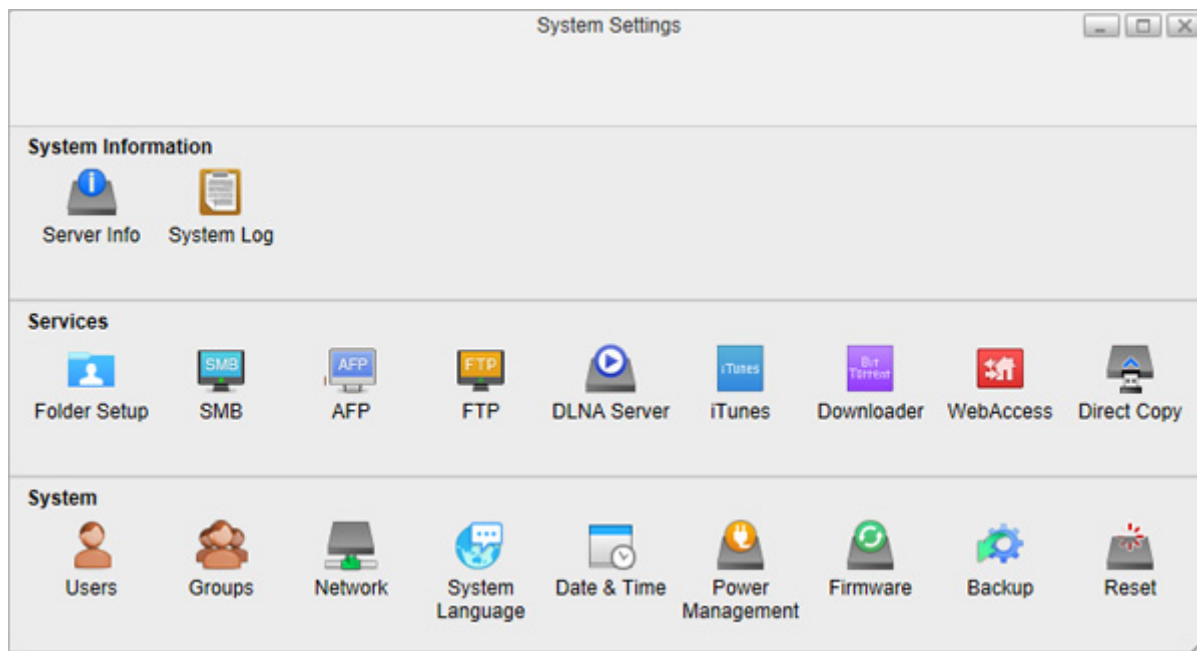

3 Click *Initialize*.

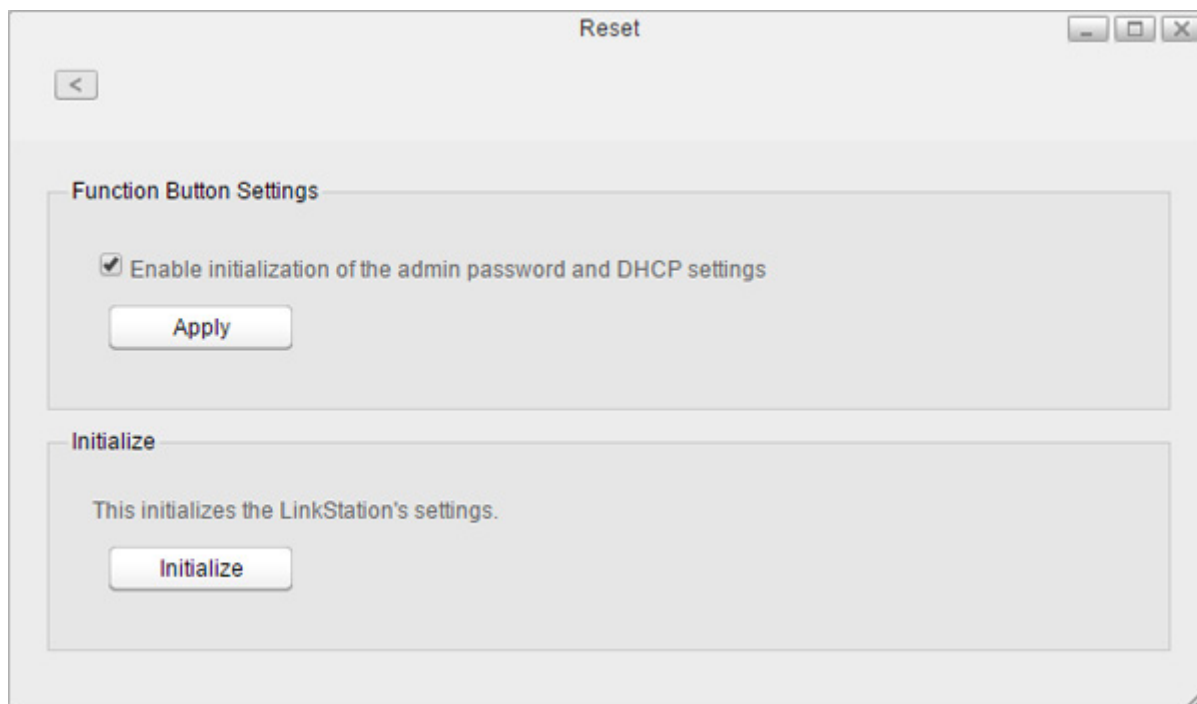

4 Read the confirmation and click Yes.

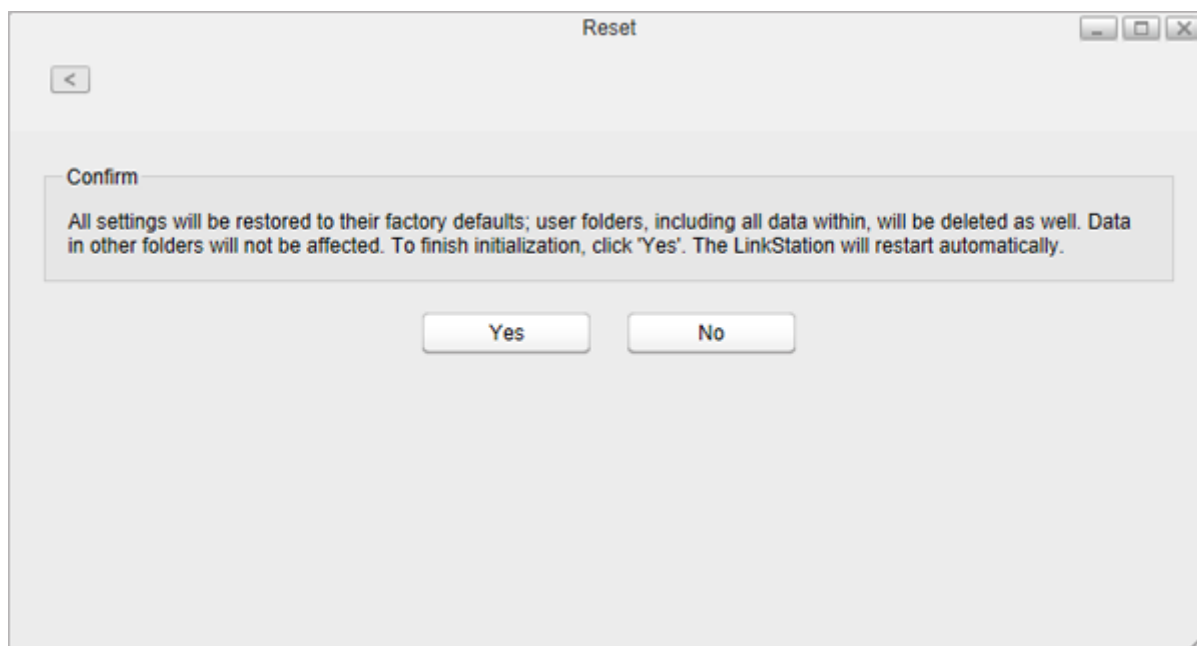

5 The LinkStation will be restored to its factory default settings.

Initializing with the Function Button

You can also initialize the admin password and IP address with the function button. The IP address will only be restored from manual to DHCP. It is enabled by default.

- 1** Turn off the LinkStation.
- 2** Turn the LinkStation on while holding down the function button until the power LED flashes amber.
- 3** Initialization will start. Do not power down the LinkStation while the power LED is blinking.
- 4** When the power LED glows a steady white, initialization is finished.
- 5** Once you reset the admin password, open Settings and run the setup wizard to configure a new password.

Note: To disable the function button reset, navigate to *System Settings - Reset* and select or clear the "Enable initialization of the admin password and DHCP settings" checkbox. If this is cleared and you lose your admin password, you will not be able to reset it.

Chapter 9 Configuring from Mobile Devices

Settings That Can Be Changed from Your Mobile Device

You can change the following settings from your mobile device:

- Create or delete users, and change the user passwords.
- Configure WebAccess settings to remotely access your LinkStation.
- Configure your LinkStation to use with DLNA-compatible devices on the LAN.
- Configure and dismount a USB device connected to your LinkStation, including Direct Copy options.
- Change the RAID mode and recover the RAID array when a drive fails.
- Configure UPS synchronization.

For the procedure of opening Settings from your mobile devices, refer to the "Opening Settings" section in chapter 2.

Managing User Accounts

You can create or delete users, and change the user password using the following procedure.

Creating Users

1 In Settings, tap *Users*.



2 Tap *Create User*.

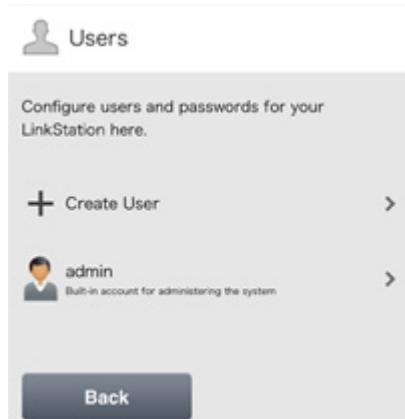

3 Enter the desired username and password (twice), then tap *Apply*.



4 Tap *Close*.

Notes:

- Usernames may contain up to 32 alphanumeric characters and the following symbols: - _ . ! # + \$ ^ %. Do not use a symbol as the first character.
- Passwords may contain up to 20 alphanumeric characters and the following symbols: - _ @ ! # \$ % & ' () * + , . / ; < > = ? " [] ^ { } | ~ . Do not use a symbol other than an underscore (_) as the first character.

Changing Passwords

1 Tap an existing user to change the user's password from the list.

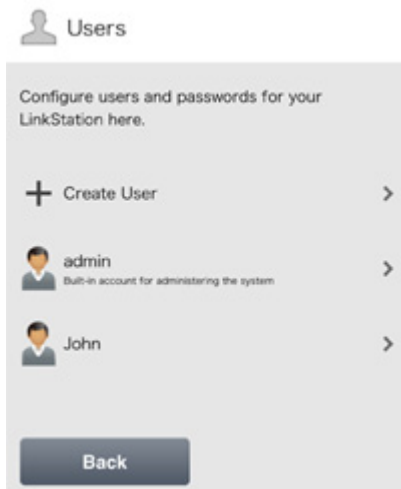

2 Enter the new password (twice) and click *Apply*.

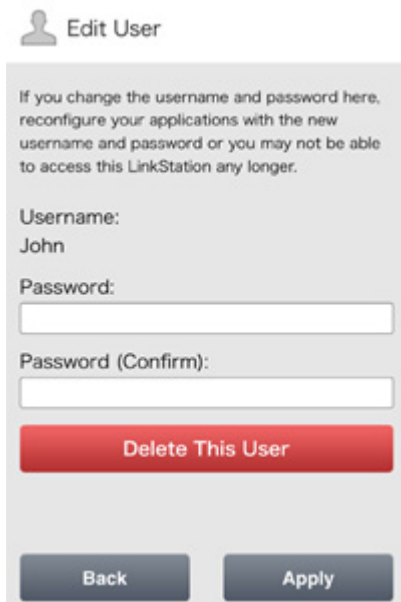

3 Tap *Close*.

Deleting Users

- 1 Tap an existing user to delete from the list.

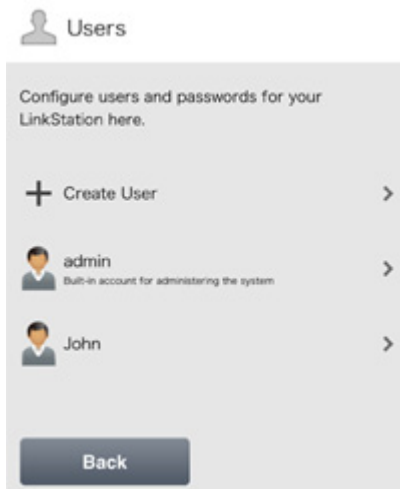

- 2 Tap *Delete This User*.

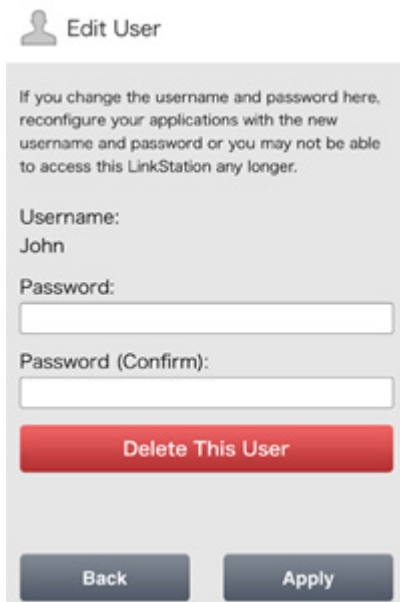

- 3 Tap Yes.
- 4 The "Confirm Operation" screen will open. Enter the confirmation number, then tap *OK*.
- 5 Tap *OK*.

Changing the RAID Mode

You can change the RAID settings easily from your mobile device.

1 In Settings, tap *Disk Manager*.



2 Select the desired RAID mode and tap *Apply*.

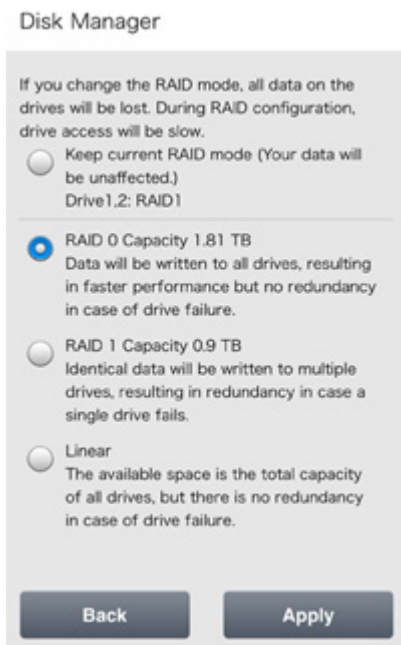

3 Tap Yes.

4 The "Confirm Operation" screen will open. Enter the confirmation number, then tap *OK*.

Once you tap *OK*, the RAID array will be changed. Changing the RAID array will delete all data on the drives.

5 Tap *OK*.

Configuring WebAccess

Note: On your mobile device, download and install the "SmartPhone Navigator" and "WebAccess" apps from the App Store (iOS devices) or Google Play (Android devices).

1 Open SmartPhone Navigator on your mobile device.



2 Select the LinkStation to configure WebAccess.



3 Tap *NAS Setup*.

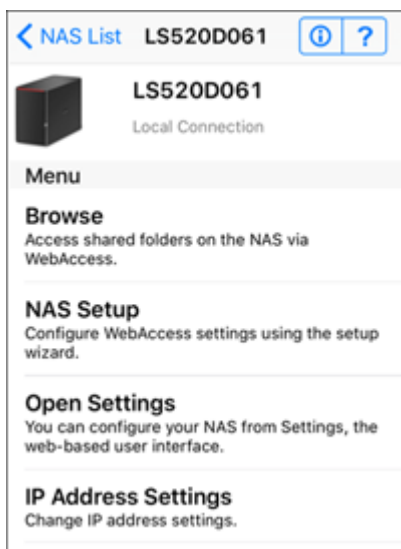

4 Enter a username and password. This will create a new user. Tap *Next*.

[Back](#) **NAS Setup**

Enter an username and password. If the account does not already exist, a new user will be created. A shared folder will be created with the same name as the username.

Username

Password

Cancel Next

5 Enter the password from the previous step again and tap *Next*.

[Back](#)

Enter the password for .

Password:

Cancel Next

If UPnP is not enabled on your network, you will only be able to access your LinkStation from the local network. To use WebAccess from outside your home, either enable UPnP in the router or open port 9000 for WebAccess in your router's settings.

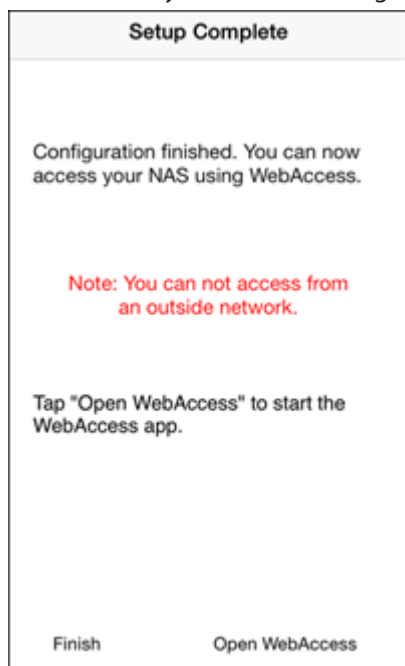

6 Enter the BuffaloNAS.com name and tap *Set*.



7 Tap *Open WebAccess*.

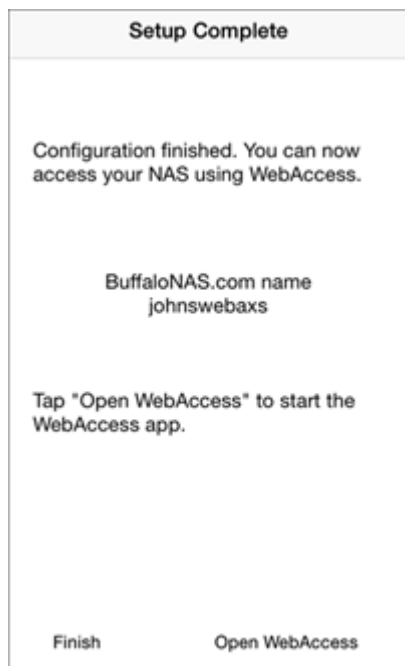

8 WebAccess will launch.

9 Tap *OK* if the following message is displayed.

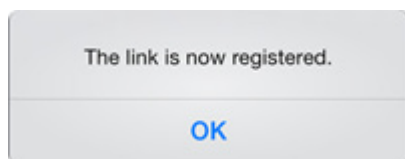

10 Tap your LinkStation's hostname to open the shared folder.



If Unable to Create a BuffaloNAS.com Name

If UPnP is disabled on your router, creating the BuffaloNAS.com name from SmartPhone Navigator may fail. If this happens, try the following procedure.

- 1 Tap the "SmartPhone Navigator" icon on your mobile device.
- 2 Tap *Open Settings*.
- 3 Tap *WebAccess*.



- 4 Enter the desired BuffaloNAS.com name.

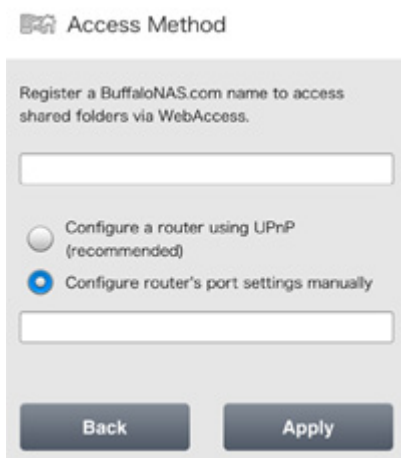

- 5 Select "Configure router's port settings manually", enter the router's port number, and tap *Apply*.

Configuring DLNA Server

1 In Settings, tap *DLNA Server*.



2 Enable the shared folder for DLNA and tap *Apply*.

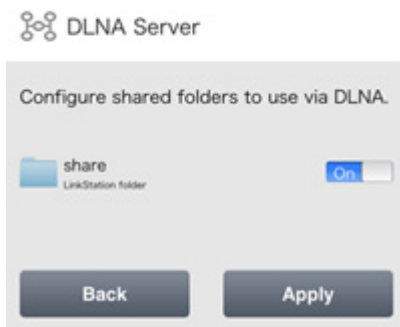

You can add a shared folder for sharing via DLNA from Settings using the computer. Refer to the "Folder Setup" section in chapter 7 for the procedure.

Managing USB Devices

From "USB Device" option in Settings, you can dismount the USB drive, working with Direct Copy, and configuring UPS sync settings.

Dismounting USB Drives

1 In Settings, tap *USB Device*.



2 Tap *Dismount*.



3 When the completion message is displayed, unplug the USB device and tap *OK*.

Starting Direct Copy

With the specific USB devices, you can copy the data in the USB device with your mobile device.

1 Connect the USB device. After it mounts (about 10 seconds), the function LED will light up. Unsupported devices will not cause the function LED to light.

2 Open Settings and tap *USB Device*.



3 Tap *Start Direct Copy*.



4 If you do, the function LED will flash as all the files on the USB device are copied to the Direct Copy folder to the LinkStation.

Note: As the default settings, the Direct Copy folder is configured to the "usb_backup" folder in the "Public" folder. You can change the destination folder from Settings using the computer. Refer to the "Direct Copy" section in chapter 7 for the procedure.

5 When the copy operation is finished, the access LED of the USB device will stop flashing. Safely dismount the USB device by using the dismount process.

Configuring UPS Sync

You can enable/disable UPS sync settings from your mobile device. For other settings such as changing the shutdown process when using UPS sync, go to Settings from the computer. Refer to the "UPS Sync" section in chapter 8 for the procedure.

1 In Settings, tap *USB Device*.



2 Move the UPS sync switch to the "on" or "off" position to enable or disable UPS sync.

Chapter 10 Utilities

NAS Navigator2 for Windows

NAS Navigator2 is a utility program that makes it easy to display Settings, change the LinkStation's IP address, or check its hard drive. You can download NAS Navigator2 from the Buffalo website.

NAS Navigator2 will run in the system tray when the computer is on.



Double-click the  icon to start NAS Navigator2.

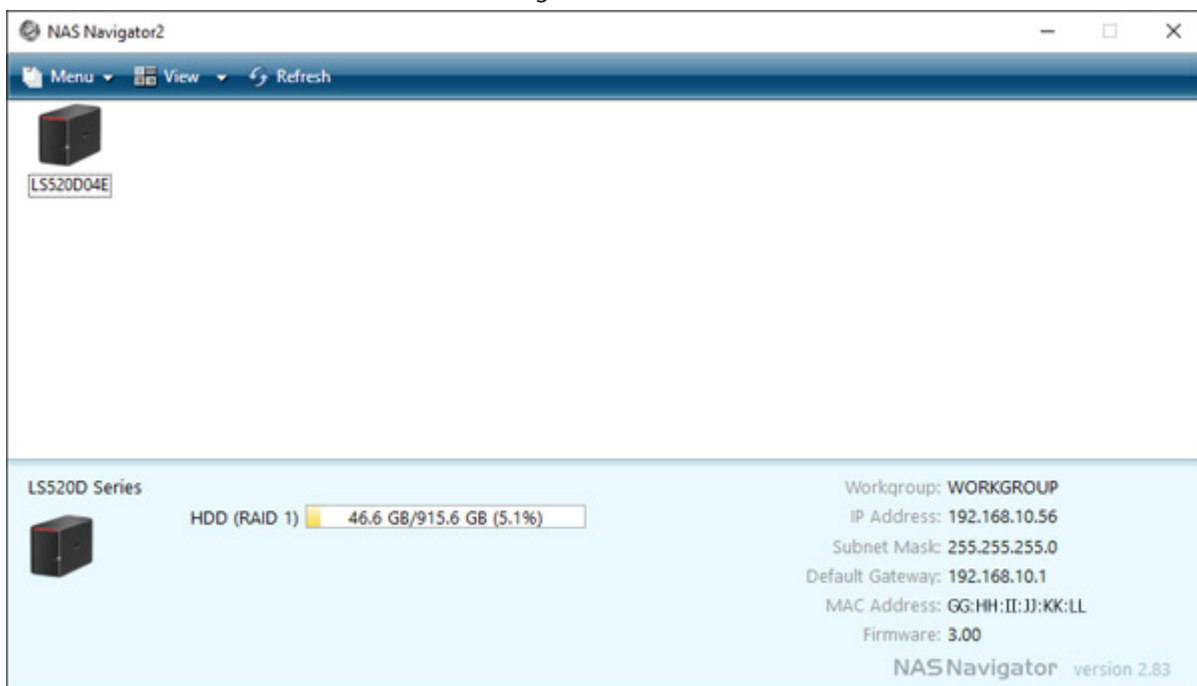

Click on a LinkStation's icon to display:

- Total capacity
- Capacity in use
- IP address
- Workgroup
- Subnet mask
- Default gateway
- MAC address
- Firmware version

Double-click the icon to open a share on the LinkStation.

Name		Description
Menu	Map All Remote Shares to Drive Letters	Assigns all the LinkStations' or TeraStations' shared folders as network drives. Note: LS520D cannot be assigned as the network drive with this option.
	Create Desktop Shortcut*	Creates a desktop shortcut to the selected LinkStation's or TeraStation's shared folders.
	Launch NAS Navigator2 on Startup	Launches NAS Navigator2 in the system tray when Windows boots.
	Display Errors	If an error occurs, an error message will pop up from the NAS Navigator2 icon in the system tray.
	Properties*	Opens the selected LinkStation's or TeraStation's properties page.
	Close	Closes NAS Navigator2.
View	View	Icons: Displays icons. Details: Displays the hostname, product name, workgroup, IP address, subnet mask, and default gateway.
	Sort by	If you have multiple LinkStations and TeraStations on the network, you may choose to display them in order of hostname, product name, workgroup, IP address, subnet mask, or default gateway.
Browse*		Opens the selected LinkStation's or TeraStation's shared folders.
Refresh		Searches for NAS devices on the network again.
Displays when you right-click a device's icon.	Browse Shares	Opens the selected LinkStation's or TeraStation's shared folders.
	Settings	Opens Settings for the selected LinkStation or TeraStation.
	Properties	Opens the selected LinkStation's or TeraStation's properties page.
	Create Desktop Shortcut	Creates a desktop shortcut to the selected LinkStation's or TeraStation's shared folders.

*Click on the selected LinkStation's or TeraStation's icon to display these options.

When NAS Navigator2 is minimized, right-click on the NAS Navigator2 icon in the system tray for the following options.

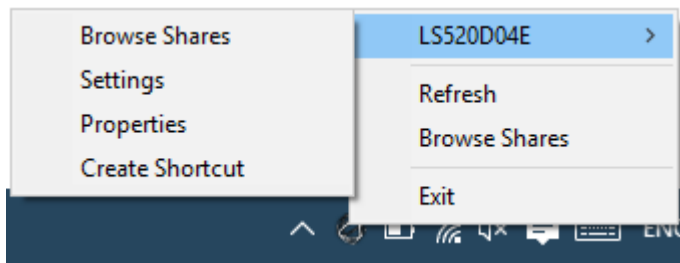

Name		Description
NAS Name	Browse Shares	Opens the selected LinkStation's or TeraStation's shared folders.
	Settings	Opens Settings for the selected LinkStation or TeraStation.
	Properties	Opens the selected LinkStation's or TeraStation's properties page.
	Create Shortcut	Creates a desktop shortcut to the selected LinkStation's or TeraStation's shared folders.
Refresh		Refreshes list of NAS devices.
Browse Shares		Displays NAS Navigator2 window.
Exit		Exits NAS Navigator2.

The following tasks may be performed from the properties page.

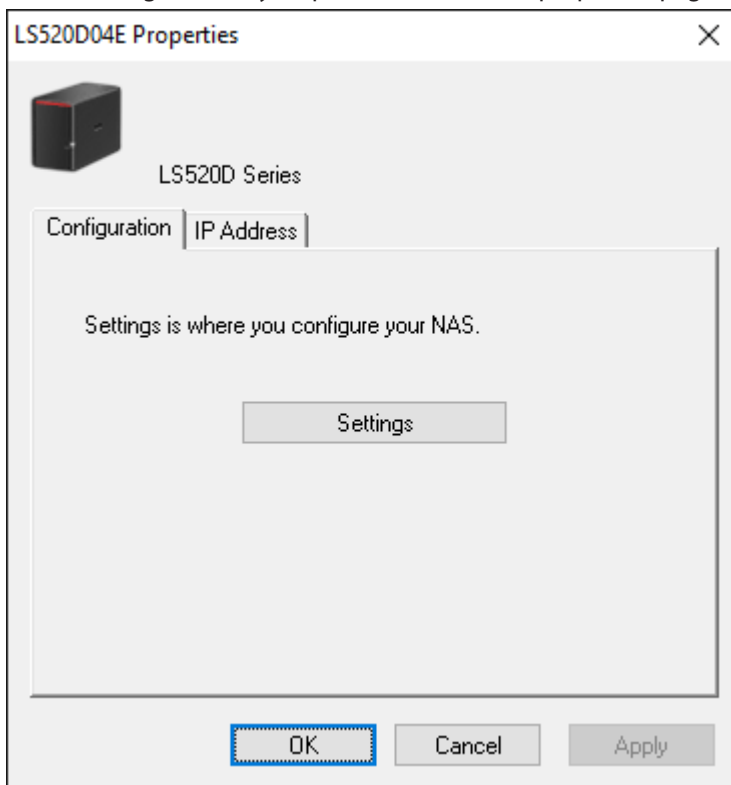

Name	Description
Configuration	Click <i>Settings</i> to open the configuration interface.
IP Address	Select the <i>Use DHCP</i> checkbox to assign an IP address from the DHCP server automatically. If there is no DHCP server on the network, you cannot use this function. Select the <i>Renew IP address</i> checkbox to obtain an IP address from the DHCP server. You can enter a static IP address, subnet mask, and default gateway.

Changing the IP Address

- 1 Double-click the  icon to start NAS Navigator2.

2 Right-click on your LinkStation's icon and choose *Properties - IP Address*.

3 Clear the "Use DHCP" checkbox and enter the desired settings, then click *OK*. If the username and password prompts appears, enter the admin username and password.

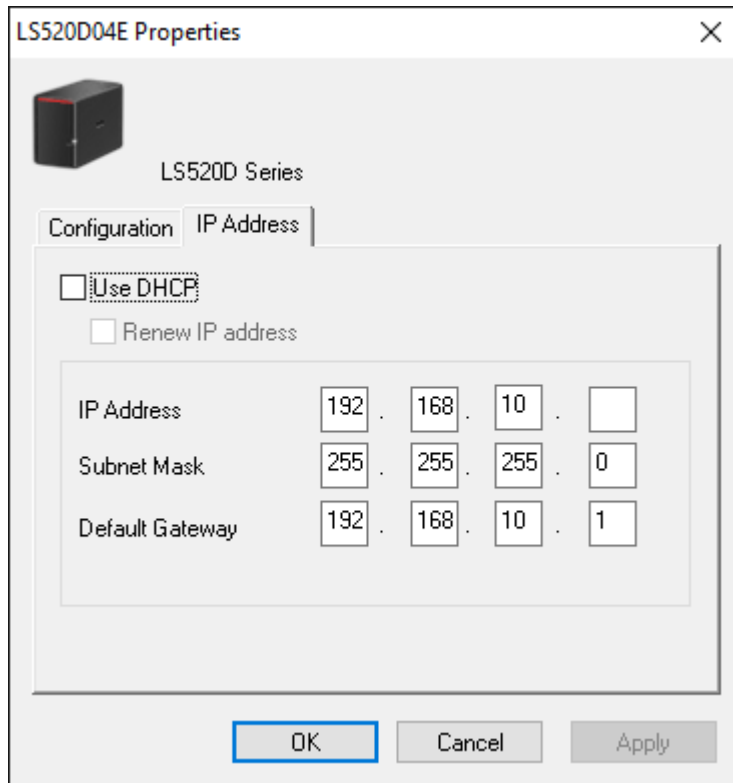

Note: The following IP addresses are reserved and should not be used. If you configure one of them by accident, initialize settings with the function button on the LinkStation.

- Local loopback address: 127.0.0.1, 255.255.255.0
- Network address: 0.0.0.0, 255.255.255.0
- Broadcast address: 255.255.255.255, 255.255.255.0
- The IP address range from 224.0.0.0 to 255.255.255.255

NAS Navigator2 for macOS

NAS Navigator2 is a utility that makes it easy to display Settings, change the LinkStation's IP address, or check its hard drive. You can download NAS Navigator2 from the Buffalo website.



Click the  icon in the Dock to start NAS Navigator2.

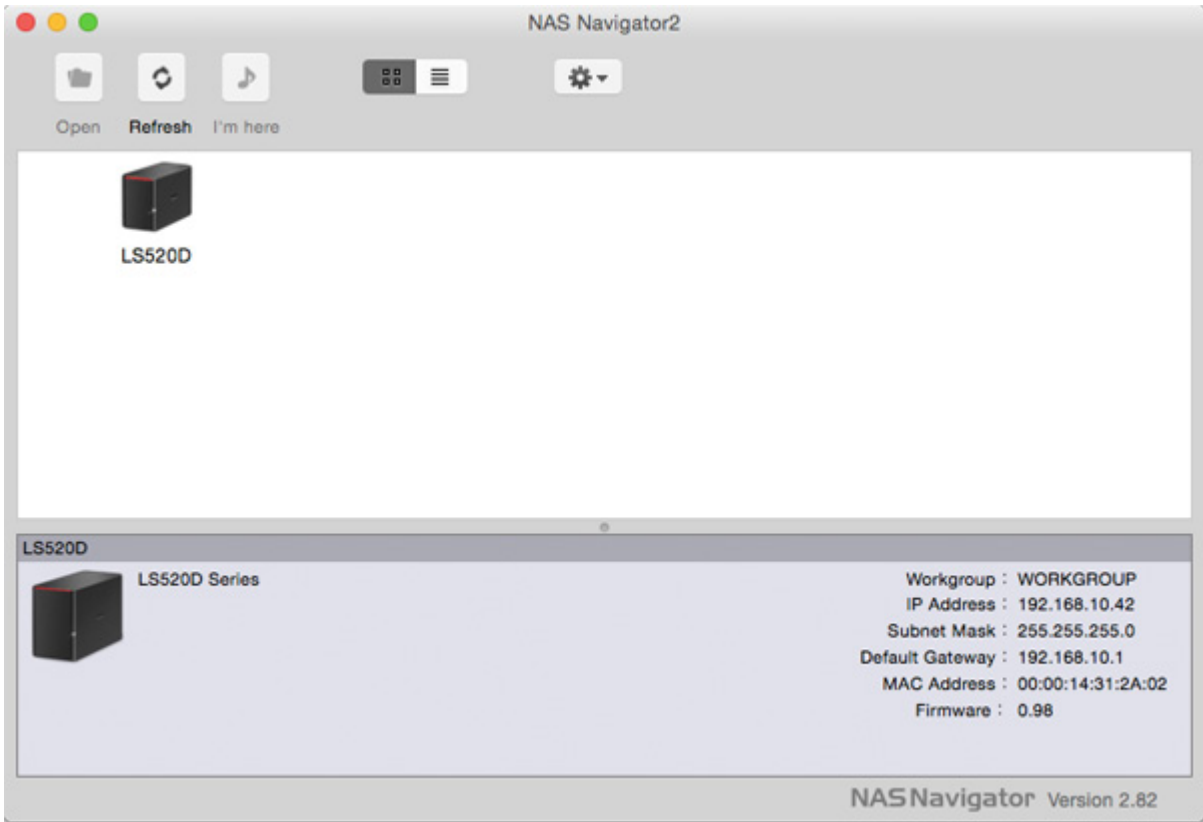

Click on a LinkStation's icon to display:

- Total capacity
- Capacity in use
- IP address
- Workgroup
- Subnet mask
- Default gateway
- MAC address
- Firmware version

Name		Description
Open		Opens the default shared folder for a selected LinkStation or TeraStation.
Refresh		Searches for NAS devices on the network again.
Settings		Opens Settings for the selected LinkStation or TeraStation.
Configure		Opens a window that lets you configure the NAS's IP address or open Settings.
Label Color		Selects the color of the name displayed below the icon.
View Options		Lets you choose icon size, position, and view mode.
Auto Power Mode		Auto power mode can turn supported TeraStations and LinkStations on the network on and off automatically.
To display these options, hold down the control key and click a device's icon.	Open Folder	Opens the selected LinkStation's or TeraStation's shared folder.
	Settings	Opens Settings for the selected LinkStation or TeraStation.
	Configure	Opens a window that lets you configure the NAS's IP address or open Settings.
	Label Color	Selects the color of the name displayed below the icon.

The following tasks may be performed from the properties page.

Name	Description
Configuration	Click <i>Settings</i> to open the configuration interface.
IP Address	Select the <i>Use DHCP</i> checkbox to assign an IP address from the DHCP server automatically. If there is no DHCP server on the network, you cannot use this function. Select the <i>Renew IP address</i> checkbox to obtain an IP address from the DHCP server. You can enter a static IP address, subnet mask, and default gateway.

Changing the IP Address



- 1 Click the icon in the Dock to start NAS Navigator2.
- 2 Hold down the control key, select your LinkStation, and choose *Configure - IP Address*.
- 3 Clear the "Use DHCP" checkbox; enter the desired settings and the administrator password, then click *Apply*.

Note: The following IP addresses are reserved and should not be used. If you configure one of them by accident, initialize settings with the function button on the LinkStation.

- Local loopback address: 127.0.0.1, 255.255.255.0
- Network address: 0.0.0.0, 255.255.255.0
- Broadcast address: 255.255.255.255, 255.255.255.0
- The IP address range from 224.0.0.0 to 255.255.255.255

NovaBACKUP

NovaBACKUP is a Windows utility that lets you back up the data on your computer or LinkStations.

The software is available at <http://d.buffalo.jp/LS500/>. To download the installer, you need the serial number of your LinkStation. The serial number is printed on the label at the back of the unit.

Chapter 11 Appendix

When the Power LED Blinks

White

The power LED will blink white during bootup or shutdown.

Red

If there is an error, the power LED will blink red. You can also see any errors in NAS Navigator2.

Error Code	Description	Corrective Action
E04	The firmware is corrupted.	Save the firmware file to the root directory of a FAT32-formatted USB memory device. Power off the LinkStation, connect the USB memory device, then power the LinkStation back on. The firmware file will be restored automatically. http://86886.jp/ls500-r/ If the error still present, contact Buffalo technical support for assistance. Note: By recovering the firmware, all the LinkStation's settings will be initialized to default values, but the data on the LinkStation will be kept.
E10	The LinkStation is running on the UPS battery due to a power outage. The system will now be shut down safely.	Check that power is being supplied to the UPS, and if there are no problems, turn on the LinkStation.
E11	An error occurred in the fan speed.	Check the fan. Use compressed air or tweezers to remove any dust or foreign objects. Confirm that the fan is spinning normally. If it is not, contact Buffalo technical support for assistance.
E12	A rise in the system temperature may have exceeded the allowable safety value.	Do not place objects in the area around the LinkStation. Also, move the LinkStation to a cool location.
E14	RAID array cannot be mounted.	Run the RAID array disk check in Settings.
E15	The bad sectors have reached a dangerous level.	Replace the defective drive.
E16	Unable to find the hard drive.	The hard drive may be disconnected or may have failed. Shut down the LinkStation and reinstall the hard drive.
E22	Unable to mount the hard drive.	Format the hard drive. After formatting, if the error still appears after rebooting, replace the hard drive. If the error is displayed again, contact Buffalo technical support for assistance.
E30	A hard drive error occurred.	Replace the faulty drive.

Amber

If there is a status message, the power LED will blink amber. You can also see any status messages in NAS Navigator2.

Information Code	Description	Corrective Action
I12	Operating in degraded mode.	-
I13	Formatting RAID array.	-
I16	Creating RAID array.	-
I18	Rebuilding RAID array. Note: Transfer speeds are slower during the rebuilding process.	-
I19	Writing 0s to RAID array, erasing all data.	-
I20	Formatting the hard drive.	Don't turn off the LinkStation.
I21	Checking the hard drive.	Don't turn off the LinkStation.
I22	Erasing the data for the hard drive.	-
I23	System is being initialized.	-
I25	Updating the LinkStation firmware.	-
I28	Formatting USB hard drive.	Don't turn off the LinkStation.
I46	Data migration or conversion (RAID migration) is in progress.	Don't turn off the LinkStation.
I52	A new firmware version has been released.	Update the firmware.
I54	A backup job has failed.	Make sure that the backup job is configured correctly, and that the NAS is on and not in standby mode. If the backup job still fails, check the status of the NAS and the backup source and destination.

Default Settings

Administrator's Name	admin
Shared Folders	"Public" and "admin" (for both Windows and Mac computers).
DHCP Client	Normally, the LinkStation will get its IP address automatically from a DHCP server on the network. If no DHCP server is available, then an IP address will be assigned as follows: IP address: IP address will be assigned starting from "169.254". Subnet mask: 255.255.0.0
Microsoft Network Group Setting	WORKGROUP
Samba	Enabled
AFP	Disabled
FTP	Disabled
DLNA Server	Enabled
iTunes	Disabled
Downloader	Disabled
WebAccess	Disabled
Wake-on-LAN	Enabled
NTP	Enabled

Enable initialization of the admin password and DHCP settings	Enabled
RAID Mode	RAID 1 (LS520D)

Specifications

Check the Buffalo website for the latest product information and specifications.

LAN Port	Interface	IEEE 802.3ab (1000BASE-T), IEEE 802.3u (100BASE-TX), IEEE 802.3 (10BASE-T)
	Transfer Speed	1000 Mbps full duplex (auto-negotiation) 100 Mbps full duplex/half duplex (auto-negotiation) 10 Mbps full duplex/half duplex (auto-negotiation)
	Number of Ports	1 port (supports auto MDI-X)
	Connector Type	RJ-45 8-pin
	Protocol	TCP/IP
	Access Method	CSMA/CD
	File Sharing	SMB/CIFS, AFP, FTP, HTTP
	Management	HTTP
USB Port	1 USB 3.0 port (type A)	
Internal Hard Drive	If a hard drive in your LS520D or LS520DE malfunctions, replace it with a Buffalo OP-HDBST series of the same or larger capacity. For LS520DE, you can also use compatible other manufacturers' hard drives that is listed on the compatible information, available from the Buffalo website.	
Power Supply	AC 100–240 V, 50/60 Hz	
Dimensions (W x H x D)	LS510D: 45 x 128 x 205 mm; 1.8 x 5.0 x 8.1 in LS520D, LS520DE: 87 x 128 x 205 mm; 3.4 x 5.0 x 8.1 in	
Weight	LS510D: Approx. 1.3 kg; 2.9 lb LS520D: Approx. 2.5 kg; 5.5 lb LS520DE: Approx. 0.9 kg; 1.9 lb	
Power Consumption (Max.)	LS510D: 24 W LS520D, LS520DE: 36 W	
Operating Environment	Temperature: 5–35°C; 41–95°F Environment humidity: 20–80% (no condensation)	
Compatible Devices and OS	<ul style="list-style-type: none"> • Windows computers with Ethernet interface (both 32-bit and 64-bit) Windows 10, 8.1, 8, 7, Vista • Intel Mac computers with Ethernet interface macOS 10.12, 10.11, 10.10, 10.9, 10.8, 10.7 • iPhone, iPad, and iPod touch iOS 7.0 or later • Android smartphones and tablets Android 4.1 or later <p>Note: The LinkStation requires an Ethernet connection with your computer for operation. It cannot be connected via USB. To use with mobile devices, Wi-Fi connection is required.</p>	

Chapter 12 Regulatory Compliance Information

For Customers in the United States

FCC Statement

This equipment has been tested and found to comply with the limits for a Class B digital device, pursuant to Part 15 of the FCC Rules. These limits are designed to provide reasonable protection against harmful interference in a residential installation.

This equipment generates, uses and can radiate radio frequency energy and, if not installed and used in accordance with the instructions, may cause harmful interference to radio communications. However, there is no guarantee that interference will not occur in a particular installation.

If this equipment does cause harmful interference to radio or television reception, which can be determined by turning the equipment off and on, the user is encouraged to try to correct the interference by one or more of the following measures:



- Reorient or relocate the receiving antenna.
- Increase the separation between the equipment and receiver.
- Connect the equipment into an outlet on a circuit different from that to which the receiver is connected.
- Consult the dealer or an experienced radio/TV technician for help.

This device complies with Part 15 of the FCC Rules. Operation is subject to the following two conditions: (1) This device may not cause harmful interference, and (2) this device must accept any interference received, including interference that may cause undesired operation.

Only use the cables and accessories that are included in the package. Don't use other accessories or cables unless specifically instructed to in the documentation.

MET

Label Information

	Direct current
	Polarity of DC connector

Proposition 65

WARNING:

This product and its components contain chemicals known to the State of California to cause cancer and birth defects, or reproductive harm. Wash hands after handling.

For Customers in Europe

EU Declaration of Conformity



Dansk

Brug ikke USB-kabler, der er 3 meter eller længere for at tilslutte USB enheder til denne LinkStation serie. Der må kun bruges de kabler og det tilbehør der er inkluderet i pakken. Der må ikke bruges andet tilbehør eller kabler, medmindre det er udtrykkeligt beskrevet i dokumentationen.

Deutsch

Verwenden Sie keine USB-Kabel, die 3 Meter lang oder länger sind, um USB-Geräte an LinkStations dieser Serie anzuschließen.

Verwenden Sie ausschließlich die Kabel und Zubehörteile, die im Lieferumfang enthalten sind. Andere Zubehörteile oder Kabel dürfen nur dann verwendet werden, wenn dies in der Dokumentation ausdrücklich vorgeschrieben ist.

English

Do not use USB cables that are 3 meters or longer to connect USB devices to this LinkStation series.

Only use the cables and accessories that are included in the package. Don't use other accessories or cables unless specifically instructed to in the documentation.

Español

Utilice cables de una longitud inferior a 3 metros para conectar los dispositivos USB a este tipo de LinkStation.

Utilice únicamente los cables y accesorios incluidos en el paquete. No utilice otros accesorios ni cables a menos que así se indique en la documentación.

Français

Utilisez des câbles d'une longueur de moins 3 mètres pour connecter les périphériques USB à ce type de LinkStation.

Utilisez uniquement les câbles et accessoires inclus dans ce package. N'utilisez aucun autre accessoire ou câble sauf instruction spécifique de la documentation.

Italiano

Non utilizzare cavi USB lunghi 3 metri o più per collegare dispositivi USB a questa LinkStation.

Utilizzare esclusivamente i cavi e gli accessori inclusi nell'imballaggio. Non utilizzare altri accessori o cavi a meno che non sia specificamente indicato nella documentazione.

Nederlands

Gebruik geen USB-kabels die 3 meter of langer zijn om USB-apparaten met deze LinkStation series te verbinden.

Gebruik alleen de kabels en toebehoren die zich in de verpakking bevinden. Gebruik geen ander toebehoren of kabels tenzij dit uitdrukkelijk in de handleiding wordt aangegeven.

Norsk

Bruk ikke USB-kabler på tre meter eller mer for å koble USB-enheter til denne LinkStation-serien.

Bruk kun kabler og tilbehør som er inkludert i pakken. Ikke bruk annet tilbehør eller kabler med mindre spesielt instruert til å gjøre det i dokumentasjonen.

Português

Não usar cabos USB de 3 metros ou mais para ligar dispositivos USB a esta série LinkStation.

Utilizar apenas cabos e acessórios incluídos na embalagem. Não utilizar outros acessórios ou cabos, salvo se especificamente indicado na documentação.

Suomi

Älä käytä 3m tai pitempiä USB-kaapeleita USB-laitteiden liittämiseen näille LinkStation-sarjoille.

Käytä ainoastaan pakkauksen mukana toimitettuja kaapeleita ja varusteita. Älä käytä muita varusteita tai kaapeleita ellei näin ole erityisesti ohjeistettu asiakirjoissa.

Svensk

Använd inte USB-kablar som är 3 meter eller längre för att ansluta USB-enheter till den här LinkStation-serien.

Använd bara kablar och tillbehör som ingår i förpackningen. Använd inte andra tillbehör eller kablar om du inte får uttryckliga instruktioner om det i dokumentationen.

Türk

USB aygıtları bu LinkStation serisine bağlamak için 3 metre ve daha uzun USB kabloları kullanmayın.



Yalnızca pakette bulunan kablo ve aksesuarları kullanın. Belgelerde özellikle belirtilmedikçe başka aksesuar ve kablolar kullanmayın.

AC Adapter

LS510D	Asian Power Devices Inc. WA-24Q12R
LS520D, LS520DE	Asian Power Devices Inc. WA-36A12 or WA-36A12R

CB

Label Information

	Direct current
	Polarity of DC connector