

# Linux Shell Scripting Tutorial

## v2.0

Written by Vivek Gite <[vivek@nixcraft.com](mailto:vivek@nixcraft.com)>

# Contents

## Articles

Linux Shell Scripting Tutorial -A Beginner's handbook>About	1
---	---

## Chapter 1: Quick Introduction to Linux **4**

What Is Linux	4
Who created Linux	5
Where can I download Linux	6
How do I Install Linux	6
Linux usage in everyday life	7
What is Linux Kernel	7
What is Linux Shell	8
Unix philosophy	9
But how do you use the shell	10
What is a Shell Script or shell scripting	11
Why shell scripting	12
Chapter 1 Challenges	14

## Chapter 2: Getting Started With Shell Programming **15**

The bash shell	15
Shell commands	16
The role of shells in the Linux environment	19
Other standard shells	20
Hello, World! Tutorial	21
Shebang	22
Shell Comments	24
Setting up permissions on a script	25
Execute a script	26
Debug a script	27
Chapter 2 Challenges	28

## Chapter 3:The Shell Variables and Environment **29**

Variables in shell	29
Assign values to shell variables	33
Default shell variables value	34
Rules for Naming variable name	36

Display the value of shell variables	37
Quoting	40
The export statement	43
Unset shell and environment variables	44
Getting User Input Via Keyboard	44
Perform arithmetic operations	46
Create an integer variable	48
Create the constants variable	49
Bash variable existence check	50
Customize the bash shell environments	51
Recalling command history	55
Path name expansion	57
Create and use aliases	59
The tilde expansion	61
Startup scripts	62
Using aliases	64
Changing bash prompt	65
Setting shell options	69
Setting system wide shell options	74
Chapter 3 Challenges	75

## **Chapter 4: Conditionals Execution (Decision Making) 76**

Bash structured language constructs	76
Test command	78
If structures to execute code based on a condition	79
If..else..fi	81
Nested ifs	84
Multilevel if-then-else	85
The exit status of a command	86
Conditional execution	88
Logical AND &&	89
Logical OR	90
Logical Not !	91
Conditional expression using [	92
Conditional expression using <code>&lt;nowiki&gt;[[&lt;/nowiki&gt;</code>	93
Numeric comparison	93
String comparison	94
File attributes comparisons	96

Shell command line parameters	101
How to use positional parameters	102
Parameters Set by the Shell	103
Create usage messages	104
Exit command	106
The case statement	108
Dealing with case sensitive pattern	112
Chapter 4 Challenges	115
<b>Chapter 5: Bash Loops</b>	<b>116</b>
The for loop statement	116
Nested for loop statement	122
The while loop statement	124
Use of : to set infinite while loop	128
The until loop statement	130
The select loop statement	132
Exit the select loop statement	135
Using the break statement	137
Using the continue statement	139
Command substitution	142
Chapter 5 Challenges	144
<b>Chapter 6: Shell Redirection</b>	<b>145</b>
Input and Output	145
Standard input	146
Standard output	148
Standard error	149
Empty file creation	150
/dev/null discards unwanted output	151
Here documents	152
Here strings	154
Redirection of standard error	155
Redirection of standard output	157
Appending redirected output	158
Redirection of both standard error and output	158
Writing output to files	159
Assigns the file descriptor (fd) to file for output	161
Assigns the file descriptor (fd) to file for input	162

Closes the file descriptor (fd)	163
Opening the file descriptors for reading and writing	163
Reads from the file descriptor (fd)	164
Executes commands and send output to the file descriptor (fd)	167
Chapter 6 Challenges	173
<b>Chapter 7: Pipes and Filters</b>	<b>174</b>
Linking Commands	174
Multiple commands	175
Putting jobs in background	176
Pipes	178
How to use pipes to connect programs	179
Input redirection in pipes	181
Output redirection in pipes	182
Why use pipes	182
Filters	183
Chapter 7 Challenges	185
<b>Chapter 8: Traps</b>	<b>186</b>
Signals	186
What is a Process?	187
How to view Processes	189
Sending signal to Processes	192
Terminating Processes	194
Shell signal values	197
The trap statement	198
How to clear trap	200
Include trap statements in a script	202
Use the trap statement to catch signals and handle errors	204
What is a Subshell?	208
Compound command	210
Exec command	211
Chapter 8 Challenges	212
<b>Chapter 9: Functions</b>	<b>213</b>
Writing your first shell function	213
Displaying functions	214
Removing functions	216

Defining functions	216
Writing functions	218
Calling functions	220
Pass arguments into a function	224
Local variable	227
Returning from a function	230
Shell functions library	232
Source command	235
Recursive function	236
Putting functions in background	238
Chapter 9 Challenges	240
<b>Chapter 10: Interactive Scripts</b>	<b>241</b>
Menu driven scripts	241
Getting information about your system	243
Bash display dialog boxes	247
Dialog customization with configuration file	250
A yes/no dialog box	253
An input dialog box	255
A password box	257
A menu box	259
A progress bar (gauge box)	262
The form dialog for input	265
<b>/etc</b>	<b>267</b>
Shell scripting help	267
<b>References</b>	
Article Sources and Contributors	268
Image Sources, Licenses and Contributors	272
<b>Article Licenses</b>	
License	273

# Linux Shell Scripting Tutorial -A Beginner's handbook>About

---

This document is Copyright (C) 1999-2009 by Vivek Gite <sup>[1]</sup> and its contributors. Some rights reserved.

## Audience

This book is for students and Linux System Administrators. It provides the skills to read, write, and debug Linux shell scripts using bash shell. The book begins by describing Linux and simple scripts to automate frequently executed commands and continues by describing conditional logic, user interaction, loops, menus, traps, and functions. Finally, book covers various sys admin related scripts such as making a backup, using cron jobs, writing interactive tools, web based tools, remote login, ftp and database backup related scripts. This book is intended for Linux system administrators or students who have mastered the basics of a Linux Operating System. You should be able to:

- Login to local or remote Linux system.
- Use basic Linux commands, such as cp, mv, rm, man,less, chmod and others.
- Create and edit text files in vi or any other text editor.
- GUI is not required except for interactive GTK+ based GUI scripts.

## Licensing Information

This book is available under *Creative Commons Attribution-Noncommercial-Share Alike 3.0 Unported* <sup>[2]</sup>.

- You are **free**:
  - to *Share* — to copy, distribute and transmit the work
  - to *Remix* — to adapt the work
- Under the following **conditions**:
  - *Attribution* — If you republish this content, we require that you:
    1. Indicate that the content is from "Linux Shell Scripting Tutorial - A Beginner's handbook" ([http://bash.cyberciti.biz/guide/Main\\_Page](http://bash.cyberciti.biz/guide/Main_Page)), and nixCraft (<http://nixcraft.com/>).
    2. Hyperlink to the original article on the source site (e.g., [http://bash.cyberciti.biz/guide/What\\_Is\\_Linux](http://bash.cyberciti.biz/guide/What_Is_Linux))
    3. Show the author name (e.g., Vivek Gite) for all pages.
    4. Hyperlink each contributors name back to their profile page on the source wiki (e.g., <http://bash.cyberciti.biz/guide/User:USERNAME>)
  - *Noncommercial* — You may not use this work for commercial purposes including the Internet ad supported websites or any sort of print media.
  - *Share Alike* — If you alter, transform, or build upon this work, you may distribute the resulting work only under the same or similar license to this one.

With the understanding that:

- *Waiver* — Any of the above conditions can be waived if you get permission from the copyright holder (i.e. the Author: Vivek Gite).
  - *Other Rights* — In no way are any of the following rights affected by the license:
    - Your fair dealing or fair use rights;
    - The author's moral rights;
    - Rights other persons may have either in the work itself or in how the work is used, such as publicity or privacy rights.
-

- Notice — For any reuse or distribution, you must make clear to others the license terms of this work. The best way to do this is with a link to this web page ([http://bash.cyberciti.biz/guide/Linux\\_Shell\\_Scripting\\_Tutorial\\_-\\_A\\_Beginner%27s\\_handbook>About](http://bash.cyberciti.biz/guide/Linux_Shell_Scripting_Tutorial_-_A_Beginner%27s_handbook>About)).

## History

- Ver.0.8 - 1998 - First draft with only 8 pages.
- Ver.0.9 - 2000 - Second draft with a few more pages.
- Ver.1.0 - 2002 - Third draft published on freeos.com.
- Ver.1.5r3 - 2004 - Updated version published on freeos.com.
- Ver.2.0.beta - Aug-2009 - Wiki started.
- This document is now in a wiki format.
- All user contributed content licensed under Attribution-Noncommercial-Share Alike 3.0 Unported.

## Disclaimer

- This web site / wiki ("Site") provides educational learning information on Linux scripting for sys admin work, but you are 100% responsible for what you do or don't do with it.
- The information compiled by Vivek Gite (and its contributors) as well as the links to complimentary material are provided "as is" with no warranty, express or implied, for their accuracy or reliability.
- You use these sites at your own risk, and acknowledge that, while every effort has been made to correct errors before they appear, this site may include certain inaccuracies, errors, or omissions. nixCraft makes no representations as to the suitability, reliability, availability, timeliness, and accuracy of the information on this site for any purpose.
- Using this site (cyberciti.biz) means you accept its terms <sup>[3]</sup>.
- All trademark within are property of their respective holders.
- Although the author and its contributors believes the contents to be accurate at the time of publication, no liability is assumed for them, their application or any consequences thereof. If any misrepresentations, errors or other need of clarification is found, please contact the us immediately <sup>[4]</sup>. Please read our disclaimer <sup>[3]</sup> and privacy policy <sup>[5]</sup>.
- The opinions and ideas expressed in this book are solely those of the author, and do not necessarily reflect those of nixCraft consultancy services <sup>[6]</sup> and/or my current/past employers.

## About the author

- This book is created and maintained by Vivek Gite - a Sr. UNIX admin. Vivek is specialize in the design of high performance computing (HPC) using Linux, security and optimization for the internet and intranet usage. Vivek has a particular interest in TCP/IP, Anti DDoS, Server side optimization, computer clusters, parallel computing, HPTC and embedded Linux / FreeBSD devices etc. Visit my Linux admin blog <sup>[7]</sup> for more tutorials, guides and news about FOSS.



## Feedback

- Please give me your feedback. Whatever you see here, is based upon my own hard-earned experience. I have taught myself both through trial and error. Shoot me an email at [vivek@nixcraft.com](mailto:vivek@nixcraft.com) <sup>[8]</sup>.
- If you see a typo, a spelling mistake, or an error, please edit wiki page. Alternatively, you can tell me about it by sending me an e-mail.

## Donations

If you found this book useful please send charitable donations (\$10 is minimum and recommended) to the following non-profit organization that helps to support, promote, and develop free software:

- The FreeBSD Foundation <sup>[9]</sup>
- The Free Software Foundation (FSF) <sup>[10]</sup>
- The OpenBSD Foundation <sup>[11]</sup>

## References

- [1] <http://vivekgite.com/>
  - [2] <http://creativecommons.org/licenses/by-nc-sa/3.0/>
  - [3] <http://www.cyberciti.biz/tips/disclaimer>
  - [4] [http://www.cyberciti.biz/tips/contact\\_us](http://www.cyberciti.biz/tips/contact_us)
  - [5] <http://www.cyberciti.biz/tips/privacy>
  - [6] <http://vivekgite.com/about/services/>
  - [7] <http://www.cyberciti.biz/>
  - [8] <mailto:vivek@nixcraft.com>
  - [9] <http://www.freebsdoundation.org/>
  - [10] <http://www.fsf.org/>
  - [11] <http://www.openbsdoundation.org/>
-

---

# Chapter 1: Quick Introduction to Linux

---

## What Is Linux

---

<a href="#">← Main Page</a>	<b>Home</b>	<a href="#">→ Who created Linux →</a>
-----------------------------	-------------	---------------------------------------

Linux is a free open-source operating system based on Unix. Linus Torvalds originally created Linux with the assistance of developers from around the world. Linux is:

- Free
- Unix Like
- Open Source
- Network operating system

Strictly speaking, Linux is a kernel. A kernel provides access to the computer hardware and control access to resources such as:

- Files and data.
- Running programs.
- Loading programs into memory.
- Networks.
- Security and firewall.
- Other resources etc.

The kernel decides who will use a resource, for how long and when. You can download the Linux kernel from the official web site. However, the Linux kernel itself is useless unless you get all the applications such as text editors, email clients, browsers, office applications, etc. Therefore, someone came up with idea of a Linux distribution. A typical Linux distribution includes:

- Linux kernel.
- GNU application utilities such as text editors, browsers etc.
- Collection of various GUI (X windows) applications and utilities.
- Office application software.
- Software development tools and compilers.
- Thousands of ready to use application software packages.
- Linux Installation programs/scripts.
- Linux post installation management tools daily work such as adding users, installing applications, etc.
- And, glued together by the shell.

Corporate and small businesses users need support while running Linux, so companies such as Red Hat or Novell provide Linux tech-support and sell it as product. Nevertheless, community driven Linux distributions do exist such as Debian, Gentoo and they are entirely free. There are over 200+ Linux distributions.

<a href="#">← Main Page</a>	<b>Home</b>	<a href="#">→ Who created Linux →</a>
-----------------------------	-------------	---------------------------------------

---

# Who created Linux

---

→ ← What Is Linux **Home** → Where can I download Linux →

In 1991 Linus Torvalds was studying UNIX at a university, where he was using a special educational experimental purpose operating system called Minix (a small version of UNIX to be used in the academic environment). However, Minix had its limitations and Linus felt he could create something better. Therefore, he developed his own version of Minix, known as Linux. Linux was Open Source right from the start.

Linux is kernel developed by Linus. The kernel was bundled with system utilities and libraries from the GNU project to create a usable operating system. Sometime people refer Linux as GNU/Linux because it has system utilities and libraries from the GNU project. Linus Torvalds is credited for creating the Linux Kernel, not the entire Linux operating system<sup>[1]</sup>.

Linux distribution = Linux kernel + GNU system utilities and libraries + Installation scripts + Management utilities etc.

Please note that Linux is now packaged for different uses in Linux distributions, which contain the sometimes modified kernel along with a variety of other software packages tailored to different requirements such as:

1. Server
2. Desktop
3. Workstation
4. Routers
5. Various embedded devices
6. Mobile phones

More information on Linus Torvalds, can be found on his blog and old home page.

## External links

- [Linus's Blog](#)<sup>[2]</sup>

## References

[1] GNU/Linux (<http://www.gnu.org/gnu/gnu-linux-faq.html>) FAQ by Richard

[2] <http://torvalds-family.blogspot.com/>



Linus Torvalds, of the Linux kernel

→ ← What Is Linux **Home** → Where can I download Linux →

---

# Where can I download Linux

---

<a href="#">→ ← Who created Linux</a>	<b>Home</b>	<a href="#">→ How do I Install Linux →</a>
---------------------------------------	-------------	--

Linux is available for download over the internet. However, this is only useful if your internet connection is fast. Another way is to order the CD-ROMs, which saves time, and the installation is fast and automatic. I recommend the following most popular Linux distributions.

If you are in India then you can get a Linux distribution from the leading computer magazines such as PC Quest or Digit. Most Linux books from you local bookstore also include a Linux distribution. See the list of recommended Linux books.

<a href="#">→ ← Who created Linux</a>	<b>Home</b>	<a href="#">→ How do I Install Linux →</a>
---------------------------------------	-------------	--

# How do I Install Linux

---

<a href="#">→ ← Where can I download Linux</a>	<b>Home</b>	<a href="#">→ Linux usage in everyday life</a> →
--	-------------	---

See the Linux installation section, which provides guidance and step-by-step instructions for installing Linux.

<a href="#">→ ← Where can I download Linux</a>	<b>Home</b>	<a href="#">→ Linux usage in everyday life</a> →
--	-------------	---

---

# Linux usage in everyday life

---

<a href="#">→ ← How do I Install Linux</a>	<b>Home</b>	<a href="#">→ What is Linux Kernel →</a>
--	-------------	--

You can use Linux as a server operating system or as a stand alone operating system on your PC. As a server operating system it provides different services/network resources to a client. A server operating system must be:

- Stable
- Robust
- Secure
- High performance

Linux offers all of the above characteristics plus it is free and open source. It is an excellent operating system for:

- Desktop computer
- Web server
- Software development workstation
- Network monitoring workstation
- Workgroup server
- Killer network services such as DHCP, Firewall, Router, FTP, SSH, Mail, Proxy, Proxy Cache server etc.

<a href="#">→ ← How do I Install Linux</a>	<b>Home</b>	<a href="#">→ What is Linux Kernel →</a>
--	-------------	--

## What is Linux Kernel

---

<a href="#">→ ← Linux usage in everyday life</a>	<b>Home</b>	<a href="#">→ What is Linux Shell →</a>
--	-------------	---

The kernel is the heart of the Linux operating system. It manages the resources of Linux such as:

- File management
- Multitasking
- Memory management
- I/O management
- Process management
- Device management
- Networking support including IPv4 and IPv6
- Advanced features such as virtual memory, shared libraries, demand loading, shared copy-on-write executables etc

The kernel decides who will use these resources and for how long and when. It runs your programs or sets up to execute binary files. The kernel acts as an intermediary between the computer hardware and various applications.

---

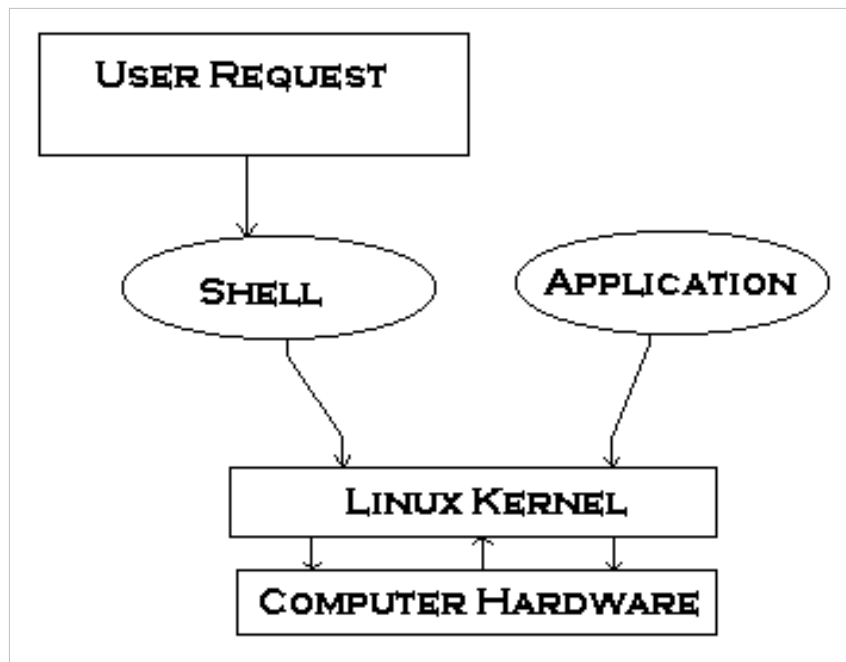

→ ← Linux usage in everyday life	<b>Home</b>	→ What is Linux Shell →
----------------------------------	-------------	----------------------------

## What is Linux Shell

→ ← What is Linux Kernel	<b>Home</b>	→ Unix philosophy →
--------------------------	-------------	------------------------

Computers understand the language of zeros and ones known as binary language. In the early days of computing, instructions were provided using binary language, which is difficult for all of us to read and write. Therefore, in an operating system there is a special program called the shell. The shell accepts human readable commands and translates them into something the kernel can read and process.

### What Is a Shell?

- The shell is a user program or it is an environment provided for user interaction.
- It is a command language interpreter that executes commands read from the standard input device such as keyboard or from a file.
- The shell started when you log in or open a console (terminal).
- Quick and dirty way to execute utilities.
- The shell is not part of system kernel, but uses the system kernel to execute programs, create files etc.
- Several shells are available for Linux including:
  - BASH ( Bourne-Again SHell ) - Most common shell in Linux. It's Freeware shell.
  - CSH (C SHell) - The C shell's syntax and usage are very similar to the C programming language.
  - KSH (Korn SHell) - Created by [[David Korn] at AT & T Bell Labs.
  - TCSH - It is an enhanced but completely compatible version of the Berkeley UNIX C shell (CSH).

Please note that each shell does the same job, but each understands different command syntax and provides different built-in functions. Under MS-DOS, the shell name is COMMAND.COM which is also used for the same purpose,

but it is not as powerful as our Linux Shells are!

## How do I find Out My Current Shell Name?

To find all of the available shells in your system, type the following command:

```
cat /etc/shells
```

## Command Line Interface (CLI)

The shell provides an interface to Linux where you can type or enter commands using the keyboard. It is known as the command line interface (CLI). To find out your current shell type following command<sup>[1]</sup> .:

```
echo $SHELL
ps $$
ps -p $$
```

## References

[1] Command to find out current shell name (<http://www.cyberciti.biz/tips/how-do-i-find-out-what-shell-im-using.html>) from the nixCraft FAQ section.

→ ← What is Linux Kernel	<b>Home</b>	→ Unix philosophy →
--------------------------	-------------	------------------------

## Unix philosophy

---

→ ← What is Linux Shell	<b>Home</b>	→ But how do you use the shell →
-------------------------	-------------	-------------------------------------

The Unix philosophy is philosophical approaches to developing software based on the experience of leading developers of the Unix operating system. The following philosophical approaches also applies to Linux operating systems.

- *Do one thing and do it well* - Write programs that do one thing and do it well. Write programs to work together. Write programs to handle text streams, because that is a universal interface.
  - *Everything is file* - Ease of use and security is offered by treating hardware as a file.
  - *Small is beautiful*
  - *Store data and configuration in flat text files* - Text file is a universal interface. Easy to create, backup and move files to another system.
  - *Use shell scripts to increase leverage and portability* - Use shell script to automate common tasks across various UNIX / Linux installations.
  - *Chain programs together to complete complex task* - Use shell → pipes and → filters to chain small utilities that perform one task at time.
  - *Choose portability over efficiency.*
  - *Keep it Simple, Stupid (KISS).*
-

## External links

- [Wikipedia:Unix philosophy](#)
- [The Unix Philosophy in One Lesson](#) <sup>[1]</sup>

<a href="#">← ← What is Linux Shell</a>	<b>Home</b>	<a href="#">→ But how do you use the shell</a> →
---	-------------	---

## References

- [1] <http://www.catb.org/~esr/writings/taoup/html/ch01s07.html>

# But how do you use the shell

---

<a href="#">→ ← Unix philosophy</a>	<b>Home</b>	<a href="#">→ What is a Shell Script or shell scripting</a> →
-------------------------------------	-------------	--

To use the shell you simply type commands. A command is a computer program, which is built to perform a specific task. Examples of commands include:

```
ls
clear
cal
date
```

If your Linux system is booted into a text mode, you can start using the shell as soon as you log in. If you started in a graphical mode (GUI), such as the Gnome desktop or Kde desktop, you can open a shell by going to Applications >> System Tools >> Terminal. Alternatively, you can switch to a virtual console by pressing Ctrl-Alt-F1 and logging in with your username and password.

<a href="#">→ ← Unix philosophy</a>	<b>Home</b>	<a href="#">→ What is a Shell Script or shell scripting</a> →
-------------------------------------	-------------	--



# What is a Shell Script or shell scripting

---

→ ← But how do you use the shell	<b>Home</b>	→ Why shell scripting →
----------------------------------	-------------	-------------------------

Normally shells are interactive. It means the shell will accept command from you (via keyboard) and execute them. However, if you store a sequence of commands to a text file and tell the shell to execute the text file instead of entering the commands, that is known as a shell program or shell script.

Shell script defined as - "*a series of command(s) stored in a plain text file*". A shell script is similar to a batch file in MS-DOS, but it is much more powerful as compare to MS-DOS shell.

## Each shell script consists of

- **Shell keywords** such as if..else, do..while.
- **Shell commands** such as pwd, test, echo, continue, type.
- **Linux binary commands** such as w, who, free etc..
- **Text processing utilities** such as grep, awk, cut.
- **Functions** - add frequent actions together via functions. For example, /etc/init.d/functions file contains functions to be used by most or all system shell scripts in the /etc/init.d directory.
- **Control flow** statments such as if..then..else or shell loops to preform repeated actions.

## Each script has purpose

- **Specific purpose** - For example, backup file system and database to NAS server.
- **Act like a command** - Each shell script executed like any command under Linux.
- **Script code usability** - Shell scripts can be extended from existing scripts. Also, you can use functions files to packages frequently used tasks.

## Did you know?

- It is the shell that lets you run different commands without having to type the full pathname to them even when they do not exist in the current directory.
- It is the shell that expands wildcard characters, such as \* or ?, thus saving you laborious typing.
- It is the shell that gives you the ability to run previously run commands without having to type the full command again by pressing the up arrow, or pulling up a complete list with the history command.
- It is the shell that does input, output and error redirection.

→ ← But how do you use the shell	<b>Home</b>	→ Why shell scripting →
----------------------------------	-------------	-------------------------

---

# Why shell scripting

---

→ ← What is a Shell Script or shell scripting	<b>Home</b>	→ Chapter 1 Challenges →
---	-------------	-----------------------------

Shell scripts are useful for automating process that you repeat at the prompt.

## Why shell scripting?

- Shell scripts can take input from a user or file and output them to the screen.
- Whenever you find yourself doing the same task over and over again you should use shell scripting i.e. repetitive task automation.
  - Creating your own power tools/utilities.
  - Automating command input or entry.
  - Customizing administrative task.
  - Creating simple applications.
  - Since scripts are well tested, the chances of errors are reduced while configuring services or system administration task such as adding new users.

## Practical examples where shell scripting actively used

- Monitoring your Linux system.
- Data backup and creating snapshots.
- Dumping Oracle or MySQL database for backup.
- Creating email based alert system.
- Find out what processes are eating up your system resources.
- Find out available and free memory.
- Find out all logged in users and what they are doing.
- Find out if all necessary network services are running or not. For example if web server failed then send an alert to system administrator via a pager or an email.
- Find out all failed login attempt, if login attempt are continue repeatedly from same network IP automatically block all those IPs accessing your network/service via firewall.
- User administration as per your own security policies.
- Find out information about local or remote servers.
- Configure server such as BIND (DNS server) to add zone entries.

Shell scripting is fun. It is useful to create nice (perhaps ugly) things in shell scripting. Here are few script example I use everyday:

- Find out today's weather (useful when you are busy in a chat room).
  - Find out what that site is running (just like netcraft).
  - Download RSS feeds and display them as you login or in your email.
  - Find out the name of the MP3 file you are listening to.
  - Monitor your domain expiry date every day.
-

## Advantages

- Easy to use.
- Quick start, and interactive debugging.
- Time Saving.
- Sys Admin task automation.

## Disadvantages

- Compatibility problems between different platforms.
- Slow execution speed.
- A new process launched for almost every shell command executed.

## Which Shell we are going use in this tutorial?

- Bash shell.

## Learning Objectives

After completing this tutorial, you will be able to:

- Understand the basis of Linux shell scripting.
- Write shell scripts and use it to save time with automated scripts.
- Customizing shell start-up files.
- Creating nifty utilities.
- Control your administration tasks such as Linux user management, Linux system monitoring etc.

→ ← What is a Shell Script or shell scripting	<b>Home</b>	→ Chapter 1 Challenges →
---	-------------	-----------------------------

# Chapter 1 Challenges

---

→ ← Why shell scripting	<b>Home</b>	Chapter 2: Getting Started With Shell Programming →
-------------------------	-------------	---

- What is the shell?
- Decide whether the following sentence is true or false:
  1. Linux is a collection of programs and utilities glued together by the bash shell.
  2. Shell manages files and data.
  3. Shell manages networks, memory and other resources.
  4. Linux kernel runs programs and loads them into the memory.
  5. Bash shell is a poor user interface.
  6. Bourne Shell is also known as /bin/sh.
  7. Bash Shell is also known as /bin/bash or /usr/local/bin/bash.
  8. C Shell offers more C like syntax.
  9. A few commands are built into the shell.
  10. Linux file system organised as hierarchy.
  11. To refer to several files with similar names you need to use wildcards.
  12. Wildcards increase command typing time.
  13. Command ls is used to list directories.
  14. rmdir command will only remove empty directories.
  15. Everything is file in Linux.
  16. rm -i filename command will prompts for confirmation.
  17. Linux can run many programs at the same time.
  18. The bash shell is just a program.
- Write a command names, which can display the files to the terminal.
- Write a command to list details of all files ending in '.perl' in reverse time order.
- Write a command to list your running programs.
- Write a command to list files waiting to be printed.
- Write a command to delete 3 files called file1.txt, file2.txt, and data1.txt.
- Write a command to creates a new sub-directory called 'foo' in /tmp.
- Write a command to delete the directory called 'foo'.
- Write a command to read all ls command options.

---

# Chapter 2: Getting Started With Shell Programming

---

## The bash shell

---

<a href="#">← Chapter 2: Getting Started With Shell Programming</a>	<a href="#">Home</a>	<a href="#">→ Shell commands →</a>
---	----------------------	------------------------------------

Bash is the shell, or command language interpreter, for the Linux operating system. The name is an acronym for the Bourne-Again SHell, a pun on Stephen Bourne, the author of the direct ancestor of the current Unix shell sh, which appeared in the Seventh Edition Bell Labs Research version of Unix Bash Reference Manual<sup>[1]</sup>.

### Introduction to BASH

- Developed by GNU project.
- The default Linux shell.
- Backward-compatible with the original sh UNIX shell.
- Bash is largely compatible with sh and incorporates useful features from the Korn shell ksh and the C shell csh.
- Bash is the default shell for Linux. However, it does not run on every version of Unix and a few other operating systems such as ms-dos, os/2, and Windows platforms.

Quoting from the official Bash home page:

*Bash is the shell, or command language interpreter, that will appear in the GNU operating system. It is intended to conform to the IEEE POSIX P1003.2/ISO 9945.2 Shell and Tools standard. It offers functional improvements over sh for both programming and interactive use. In addition, most sh scripts can be run by Bash without modification.*

### The improvements offered by BASH include:

- Command line editing.
  - Command line completion.
  - Unlimited size command history.
  - Job Control.
  - Prompt control.
  - Shell Functions and Aliases.
  - Indexed arrays of unlimited size.
  - Integer arithmetic in any base from two to sixty-four.
-

## Authors

- Brian J. Fox authored the GNU Bash shell, in 1987.
- Fox maintained Bash as the primary maintainer until 1993, at which point Chet Ramey took over.
- Chet Ramey is the current maintainer of the GNU Bourne Again Shell and GNU Readline.

## Download Bash Shell

- Bash is the default shell under Linux. The current production versions are Bash 3.x and 4.x. You can grab it from the official website <sup>[2]</sup>.

## External links

- Bash home page <sup>[3]</sup>
- Chet's home page <sup>[4]</sup>

## References

[1] Bash Reference Manual.

[2] <http://ftp.gnu.org/gnu/bash/>

[3] <http://www.gnu.org/software/bash/bash.html>

[4] <http://cnswww.cns.cwru.edu/php/chet/>

# Shell commands

---

→ ← The bash shell	<b>Home</b>	→ The role of shells in the Linux environment →
--------------------	-------------	---

The bash shell comes with two types of commands:

- Internal commands (builtins) - part of the shell itself i.e. built into the shell.
- External commands - separate binaries stored in /sbin, /usr/sbin, /usr/bin, /bin, or /usr/local/bin directories.

## Bash and Command Execution

The bash shell understand and consider the following as commands:

- **Alias** such as ll
- **Keyword** such as if
- **Function** (user defined functions such as genpasswd)
- **Builtin** such as pwd
- *File* such as /bin/date

The type command can be used find out command type.

---

## type command

The type command can be used to find out if command is builtin or external binary file.

### Find out if ls is builtin or external command

Type the following command at a shell prompt:

```
type -a ls
```

Sample Output:

```
ls is /bin/ls
```

Find out if history command is builtin or external command, enter:

```
type -a history
```

Sample Output:

```
history is a shell builtin
```

However, some commands are supplied as of both internal and external commands. For example:

```
type -a true
```

```
type -a echo
```

Sample Outputs:

```
echo is a shell builtin
```

```
echo is /bin/echo
```

### List of command bash builtin commands

- JOB\_SPEC &
- (( expression ))
- . filename
- [[:]]
- [ arg... ]
- expression
- alias
- bg
- bind
- builtin
- caller
- case
- command
- compgen
- complete
- continue
- declare
- dirs
- disown
- echo
- enable

- 
- eval
  - exec
  - exit
  - export
  - false
  - fc
  - fg
  - for
  - getopts
  - hash
  - help
  - history
  - if
  - jobs
  - kill
  - let
  - local
  - logout
  - popd
  - printf
  - pushd
  - pwd
  - read
  - readonly
  - return
  - select
  - set
  - shift
  - shopt
  - source
  - suspend
  - test
  - time
  - times
  - trap
  - true
  - type
  - typeset
  - ulimit
  - umask
  - unalias
  - → unset
  - until
  - → variables
  - while
-



# The role of shells in the Linux environment

---



Shell is used for various purposes under Linux. Linux user environment is made of the following components:

- Kernel - The core of Linux operating system.
- Shell - Provides an interface between the user and the kernel.
- Terminal emulator - The xterm program is a terminal emulator for the X Window System. It allows user to enter commands and display back their results on screen.
- Linux Desktop and Windows Manager - Linux desktop is collection of various software apps. It includes the file manger, the windows manager, the Terminal emulator and much more. KDE and Gnome are two examples of the complete desktop environment in Linux.

## Login

User can login locally into the console when in runlevel # 3 or graphically when in runlevel # 5. In both cases you need to provide username and password. Bash uses the following initialization and start-up files:

1. /etc/profile - The systemwide initialization file, executed for login shells.
2. /etc/bash.bashrc - The systemwide per-interactive-shell startup file.
3. /etc/bash.logout - The systemwide login shell cleanup file, executed when a login shell exits.
4. \$HOME/.bash\_profile - The personal initialization file, executed for login shells.
5. \$HOME/.bashrc - The individual per-interactive-shell startup file.
6. \$HOME/.bash\_logout - The individual login shell cleanup file, executed when a login shell exits.
7. \$HOME/.inputrc - Individual readline initialization file.

## Bash Startup Scripts

Script of commands executed at login to set up environment. For example, setup JAVA\_HOME path.

### Login Shell

Login shells are first shell started when you log in to the system. Login shells set environment which is exported to non-login shells. Login shell calls the following when a user logs in:

- /etc/profile runs first when a user logs in runlevel # 3.
  - /etc/profile.d
- \$HOME/.bash\_profile, \$HOME/.bash\_login, and \$HOME/.profile, runs second when a user logs in in that order. \$HOME/.bash\_profile calls \$HOME/.bashrc, which calls /etc/bashrc (/etc/bash.bashrc).

### Non-Login Shell

- When an interactive shell that is not a login shell is started, bash reads and executes commands from /etc/bash.bashrc or /etc/bashrc and \$HOME/.bashrc, if these files exist. First, it calls \$HOME/.bashrc. This calls /etc/bash.bashrc, which calls /etc/profile.d.

## Bash Logout Scripts

- When a login shell exits, bash reads and executes commands from the file \$HOME/.bash\_logout, if it exists.

# Other standard shells

---

→ ← The role of shells in the Linux environment **Home** → Hello, World! Tutorial →

In Linux, a lot of work is done using a command line shell. Linux comes preinstalled with Bash. Many other shells are available under Linux:

- tcsh - An enhanced version of csh, the C shell.
- ksh - The real, AT&T version of the Korn shell.
- csh - Shell with C-like syntax, standard login shell on BSD systems.
- zsh - A powerful interactive shell.
- scsh- An open-source Unix shell embedded within Scheme programming language.

## Find out available binary packages shell list

To find the list of available shell packages under Red Hat Enterprise Linux / CentOS Linux / Fedora Linux, enter:

```
yum search shell
```

To find the list of available shell packages under Debian Linux / Ubuntu Linux, enter:

```
apt-cache search shell
```

## Pathnames of valid login shells

/etc/shells is a text file which contains the full pathnames of valid login shells. This file is consulted by chsh and available to be queried by other programs such as ftp servers.

```
cat /etc/shells
```

Sample outputs:

```
/bin/sh
/bin/bash
/sbin/nologin
/bin/tcsh
/bin/csh
/bin/zsh
/bin/ksh
```

## which command

You can also use the which command to display the full path of (shell) commands:

```
which commandname
which bash
```

Sample outputs:

```
/bin/bash
```

For each of its command line arguments it prints to stdout (screen) the full path of the executables that would have been executed when this argument had been entered at the shell prompt:

```
which date
which gcc
which vi
```

→ ← The role of shells in the Linux environment **Home** → Hello, World! Tutorial →

# Hello, World! Tutorial

---

→ ← Other standard shells **Home** → Shebang →

To create a shell script:

1. Use a text editor such as vi. Put required Linux commands and logic in the file.
2. Save and close the file (exit from vi).
3. Make the script executable.
4. Test the script.
5. Once satisfied with the output, move script to production environment.

The simplest program in Bash consists of a line that tells the computer a command. Start up your favorite text editor (such as vi) and save the following into a file called hello.sh:

```
#!/bin/bash
echo "Hello, World!"
echo "Knowledge is power."
```

Save and close the file. You can run the script as follows:

```
./hello.sh
```

Sample outputs:

```
bash: ./hello.sh: Permission denied
```

## Saving and Running Your Script

The command `./hello.sh` displayed an error message on the screen. It will not run script since you've not set execute permission for your script `hello.sh`. To execute this program, type the following command:

```
chmod +x hello.sh
./hello.sh
```

Sample Outputs:

```
Hello, World!
Knowledge is power.
```

## See also

- `chmod` command
- `vi` command

→ ← Other standard shells	<b>Home</b>	→ Shebang →
---------------------------	-------------	-------------

## Shebang

---

→ ← Hello, World! Tutorial	<b>Home</b>	→ Shell Comments →
----------------------------	-------------	-----------------------

The `#!` syntax used in scripts to indicate an interpreter for execution under UNIX / Linux operating systems. Most Linux shell and perl / python script starts with the following line:

```
#!/bin/bash
```

OR

```
#!/usr/bin/perl
```

OR

```
#!/usr/bin/python
```

## Starting a Script With `#!`

1. It is called a shebang or a "bang" line.
2. It is nothing but the absolute path to the Bash interpreter.
3. It consists of a number sign and an exclamation point character (`#!`), followed by the full path to the interpreter such as `/bin/bash`.
4. All scripts under Linux execute using the interpreter specified on a first line<sup>[1]</sup>.
5. Almost all bash scripts often begin with `#!/bin/bash` (assuming that Bash has been installed in `/bin`)
6. This ensures that Bash will be used to interpret the script, even if it is executed under another shell<sup>[2]</sup>.
7. The shebang was introduced by Dennis Ritchie between Version 7 Unix and 8 at Bell Laboratories. It was then also added to the BSD line at Berkeley<sup>[3]</sup>.

## **/bin/sh**

For a system boot script, use /bin/sh:

```
#!/bin/sh
```

sh is the standard command interpreter for the system. The current version of sh is in the process of being changed to conform with the POSIX 1003.2 and 1003.2a specifications for the shell.

### **An example of /bin/sh script**

- /etc/init.d/policykit

```
#!/bin/sh
### BEGIN INIT INFO
# Provides:          policykit
# Required-Start:    $local_fs
# Required-Stop:     $local_fs
# Default-Start:     2 3 4 5
# Default-Stop:
# Short-Description: Create PolicyKit runtime directories
# Description:       Create directories which PolicyKit needs at
runtime,
#
#                   such as /var/run/PolicyKit
### END INIT INFO

# Author: Martin Pitt <martin.pitt@ubuntu.com>

case "$1" in
  start)
    mkdir -p /var/run/PolicyKit
    chown root:polkituser /var/run/PolicyKit
    chmod 770 /var/run/PolicyKit
    ;;
  stop|restart|force-reload)
    ;;
  *)
    echo "Usage: $SCRIPTNAME {start|stop|restart|force-reload}" >&2
    exit 3
    ;;
esac

:
```

For a typical script use the #!/bin/bash shell.

## External links

- Explain: `#!/bin/bash` <sup>[4]</sup> - or `#!/bin/bash --` In A Shell Script
- Shebang (Unix)

## References

- [1] Howto Make Script More Portable With `#!/usr/bin/env` As a Shebang (<http://www.cyberciti.biz/tips/finding-bash-perl-python-portably-using-env.html>) FAQ by nixCraft.
- [2] Bash man page and the official documentation.
- [3] extracts from 4.OBSD (<http://www.in-ulm.de/~mascheck/various/shebang/sys1.c.html>) `/usr/src/sys/newsys/sys1.c`.
- [4] <http://www.cyberciti.biz/faq/binbash-interpreter-spoofing/>

→ ← Hello, World! Tutorial	<b>Home</b>	→ Shell Comments
		→

## Shell Comments

---

→ ← Shebang	<b>Home</b>	→ Setting up permissions on a script
		→

Take look at the following shell script:

```
#!/bin/bash
# A Simple Shell Script To Get Linux Network Information
# Vivek Gite - 30/Aug/2009
echo "Current date : $(date) @ $(hostname) "
echo "Network configuration"
/sbin/ifconfig
```

The first line is called a → shebang or a "bang" line. The following are the next two lines of the program:

```
# A Simple Shell Script To Get Linux Network Information
# Vivek Gite - 30/Aug/2009
```

- A word or line beginning with `#` causes that word and all remaining characters on that line to be ignored.
- These lines aren't statements for the bash to execute. In fact, the bash totally ignores them.
- These notes, called comments.
- It is nothing but explanatory text about script.
- It make source code easier to understand.
- These notes, are for humans and other sys admins.
- It help other sys admins to understand your code, logic and it helps them to modify the script you wrote.

## External links

- Shell scripting: Put multiple line comment <sup>[1]</sup>

→ ← Shebang	<b>Home</b>	→ Setting up permissions on a script →
-------------	-------------	---

## References

- [1] <http://www.cyberciti.biz/faq/bash-comment-out-multiple-line-code/>

# Setting up permissions on a script

---

→ ← Shell Comments	<b>Home</b>	→ Execute a script →
--------------------	-------------	-------------------------

The `chmod` command (change mode) is a shell command in Linux. It can change file system modes of files and directories. The modes include permissions and special modes. Each shell script must have the execute permission. Mode can be either a symbolic representation of changes to make, or an octal number representing the bit pattern for the new mode bits.

## Examples

Allowing everyone to execute the script, enter:

```
chmod +x script.sh
```

OR

```
chmod 0766 script.sh
```

Only allow owner to execute the script, enter:

```
chmod 0700 script.sh
```

OR

```
chmod u=rwx,go= script.sh
```

OR

```
chmod u+x script.sh
```

To view the permissions, use:

```
ls -l script.sh
```

Set the permissions for the user and the group to read and execute only (no write permission), enter:

```
chmod ug=rx script.sh
```

Remove read and execute permission for the group and user, enter:

```
chmod ug= script.sh
```

## More about chmod

Type the following command to read chmod man page:

```
man chmod
```

Please note that script must have both executable and read permission.

## External links

- [How to use chmod and chown command](http://www.cyberciti.biz/faq/how-to-use-chmod-and-chown-command/) <sup>[1]</sup>
- [Chmod Numeric Permissions Notation UNIX / Linux Command](http://www.cyberciti.biz/faq/unix-linux-bsd-chmod-numeric-permissions-notation-command/) <sup>[2]</sup>

<a href="#">→ ← Shell Comments</a>	<b>Home</b>	<a href="#">→ Execute a script →</a>
------------------------------------	-------------	--------------------------------------

## References

[1] <http://www.cyberciti.biz/faq/how-to-use-chmod-and-chown-command/>

[2] <http://www.cyberciti.biz/faq/unix-linux-bsd-chmod-numeric-permissions-notation-command/>

# Execute a script

---

<a href="#">→ ← Setting up permissions on a script</a>	<b>Home</b>	<a href="#">→ Debug a script →</a>
--	-------------	------------------------------------

A shell script can be executed using the following syntax:

```
chmod +x script.sh
./script.sh
```

You can also run the script directly as follows without setting the script execute permission:

```
bash script.sh
./script.sh
```

In last example, you are using `.` (dot) command which read and execute commands from filename in the current shell. If filename does not contain a slash, file names in PATH are used to find the directory containing filename. The specialty of dot (`.`) command is you do not have to setup an executable permission on script.

---



# Debug a script

---

→ ← Execute a script	<b>Home</b>	→ Chapter 2 Challenges →
----------------------	-------------	-----------------------------

You need to run a shell script with `-x` option from the command line itself:

```
bash -x script-name
```

OR

```
bash -xv script-name
```

You can also modify `→` shebang line to run an entire script in debugging mode:

```
#!/bin/bash -x
echo "Hello ${LOGNAME}"
echo "Today is $(date)"
echo "Users currently on the machine, and their processes:"
w
```

## Use of set builtin command

Bash shell offers debugging options which can be turn on or off using set command.

- `set -x` : Display commands and their arguments as they are executed.
- `set -v` : Display shell input lines as they are read.
- `set -n` : Read commands but do not execute them. This may be used to check a shell script for syntax errors.

```
#!/bin/bash
### Turn on debug mode ###
set -x

# Run shell commands
echo "Hello ${LOGNAME}"
echo "Today is $(date)"
echo "Users currently on the machine, and their processes:"
w

### Turn OFF debug mode ###
set +x

# Add more commands without debug mode
```

Another example using `set -n` and `set -o noexec`:

```
#!/bin/bash
set -n # only read command but do not execute them
set -o noexec
echo "This is a test"
```

```
# no file is created as bash will only read commands but do not
executes them
>/tmp/debug.txt
```

## See also

- → Setting shell options

## External links

- How to debug a Shell <sup>[1]</sup> Script under Linux or UNIX.

→ ← Execute a script	<b>Home</b>	→ Chapter 2 Challenges →
----------------------	-------------	-----------------------------

## References

- [1] <http://www.cyberciti.biz/tips/debugging-shell-script.html>

# Chapter 2 Challenges

---

→ ← Debug a script	<b>Home</b>	Chapter 3:The Shell Variables and Environment →
--------------------	-------------	---

- Write the following shell script, and note down the it's output:

```
# Script to print currently logged in users information, and current
date & time.
clear
echo "Hello $USER"
echo -e "Today is \c ";date
echo -e "Number of user login : \c" ; who | wc -l
echo "Calendar"
cal
exit 0
```

- Write a program that prints your favorite movie name. It should print director name on the next line.
- Write a shell script that prints out your name and waits for the user to press the [Enter] key before the script ends.
- List 10 builtin and external commands.
- Cd to /etc/init.d and view various system init scripts.

→ ← Debug a script	<b>Home</b>	Chapter 3:The Shell Variables and Environment →
--------------------	-------------	---

---

# Chapter 3: The Shell Variables and Environment

---

## Variables in shell

---

← Chapter 3: The Shell Variables and Environment	<b>Home</b>	→ Assign values to shell variables →
--	-------------	--------------------------------------

You can use variables to store data and configuration options. There are two types of variable as follows:

### System Variables

Created and maintained by Linux bash shell itself. This type of variable is defined in CAPITAL LETTERS. You can configure aspects of the shell by modifying system variables such as PS1, PATH, LANG, HISTSIZE, and DISPLAY etc.

### View All System Variables

To see all system variables, type the following command at a console / terminal:

```
set
```

OR

```
env
```

OR

```
printenv
```

Sample Outputs from set command:

```
BASH=/bin/bash
BASH_ARGC=()
BASH_ARGV=()
BASH_LINENO=()
BASH_SOURCE=()
BASH_VERSINFO=([0]="3" [1]="2" [2]="39" [3]="1" [4]="release"
[5]="i486-pc-linux-gnu")
BASH_VERSION='3.2.39(1)-release'
COLORTERM=gnome-terminal
COLUMNS=158
DBUS_SESSION_BUS_ADDRESS=unix:abstract=/tmp/dbus-FSGj0JzI4V,guid=7f59a3dd0813f52d6296ee40
DESKTOP_SESSION=gnome
DIRSTACK=()
DISPLAY=:0.0
```

---

```
EUID=1000
GDMSESSION=gnome
GDM_LANG=en_IN
GDM_XSERVER_LOCATION=local
GNOME_DESKTOP_SESSION_ID=this-is-deprecated
GPG_AGENT_INFO=/tmp/gpg-X7NqIv/S.gpg-agent:7340:1
GROUPS=()
GTK_RC_FILES=/etc/gtk/gtkrc:/home/vivek/.gtkrc-1.2-gnome2
HISTFILE=/home/vivek/.bash_history
HISTFILESIZE=500
HISTSIZE=500
HOME=/home/vivek
HOSTNAME=vivek-desktop
HOSTTYPE=i486
IFS=$' \t\n'
LANG=en_IN
LINES=57
LOGNAME=vivek
MACHTYPE=i486-pc-linux-gnu
MAILCHECK=60
OLDPWD=/home/vivek
OPTERR=1
OPTIND=1
ORBIT_SOCKETDIR=/tmp/orbit-vivek
OSTYPE=linux-gnu
PATH=/usr/local/sbin:/usr/local/bin:/usr/sbin:/usr/bin:/sbin:/bin:/usr/games
PIPESTATUS=([0]="0")
PPID=7542
PS1='${debian_chroot:+($debian_chroot)}\u@\h:\w\$ '
PS2='> '
PS4='+ '
PWD=/tmp
SESSION_MANAGER=local/vivek-desktop:/tmp/.ICE-unix/7194
SHELL=/bin/bash
SHELLOPTS=braceexpand:emacs:hashall:histexpand:history:interactive-comments:monitor
SHLVL=1
SSH_AGENT_PID=7339
SSH_AUTH_SOCK=/tmp/ssh-IoFXyh7194/agent.7194
TERM=xterm
UID=1000
USER=vivek
USERNAME=vivek
WINDOWID=18874428
WINDOWPATH=7
XAUTHORITY=/home/vivek/.Xauthority
XDG_DATA_DIRS=/usr/local/share/:/usr/share/:/usr/share/gdm/
XDG_SESSION_COOKIE=186611583e30fed08439ca0047067c9d-1251633372.846960-528440704
```

```

_=set
command_not_found_handle ()
{
    if [ -x /usr/lib/command-not-found ]; then
        /usr/bin/python /usr/lib/command-not-found -- $1;
        return $?;
    else
        return 127;
    fi
}
mp3 ()
{
    local o=$IFS;
    IFS=$(echo -en "\n\b");
    /usr/bin/beep-media-player "$(cat $@)" & IFS=o
}
genpasswd ()
{
    local l=$1;
    [ "$1" == "" ] && l=16;
    tr -dc A-Za-z0-9_ < /dev/urandom | head -c ${l} | xargs
}
xrpm ()
{
    [ "$1" != "" ] && ( rpm2cpio "$1" | cpio -idmv )
}

```

## Commonly Used Shell Variables

The following variables are set by the shell:

System Variable	Meaning	To View Variable Value Type
BASH_VERSION	Holds the version of this instance of bash.	echo \$BASH_VERSION
HOSTNAME	The name of the your computer.	echo \$HOSTNAME
CDPATH	The search path for the cd command.	echo \$CDPATH
HISTFILE	The name of the file in which command history is saved.	echo \$HISTFILE
HISTFILE	The name of the file in which command history is saved.	echo \$HISTFILE
HISTFILESIZE	The maximum number of lines contained in the history file.	echo \$HISTFILESIZE
HISTSZIE	The number of commands to remember in the command history. The default value is 500.	echo \$HISTSZIE
HOME	The home directory of the current user.	echo \$HOME
IFS	The Internal Field Separator that is used for word splitting after expansion and to split lines into words with the read builtin command. The default value is <space><tab><newline>.	echo \$IFS
LANG	Used to determine the locale category for any category not specifically selected with a variable starting with LC_.	echo \$LANG
PATH	The search path for commands. It is a colon-separated list of directories in which the shell looks for commands.	echo \$PATH

PS1	Your prompt settings.	echo \$PS1
TMOU	The default timeout for the read builtin command. Also in an interactive shell, the value is interpreted as the number of seconds to wait for input after issuing the command. If not input provided it will logout user.	echo \$TMOU
TERM	Your login terminal type.	echo \$TERM export TERM=vt100
SHELL	Set path to login shell.	echo \$SHELL
DISPLAY	Set X display name	echo \$DISPLAY export DISPLAY=:0.1
EDITOR	Set name of default text editor.	export EDITOR=/usr/bin/vim

- Note you may add above variable (export command) to the initialization file located in the home directory of your account such as ~/.bash\_profile.

## How Do I Display The Value Of a Variable?

Use echo command to display variable value. To display the program search path, type:

```
echo $PATH
```

To display your prompt setting, type:

```
echo $PS1
```

All variable names must be prefixed with \$ symbol. Try the following example to display the value of a variable without using \$ prefix:

```
echo HOME
```

To display the value of a variable with echo \$HOME:

```
echo $HOME
```

You must use \$ followed by variable name to print variables contains.

## User Defined Variables

Created and maintained by user. This type of variable defined in a lower letters.

← Chapter 3: The Shell Variables and Environment	<b>Home</b>	→ Assign values to shell variables →
--	-------------	---

# Assign values to shell variables

---

→ ← Variables **Home** → Default shell variables value →

Creating and setting variables within a script is fairly simple. Use the following syntax:

```
varName=someValue
```

**someValue** is assigned to given **varName** and **someValue** must be on right side of = (equal) sign. If **someValue** is not given, the variable is assigned the null string.

## How Do I Display The Variable Value?

You can display the value of a variable with **echo \$varName** or **echo \${varName}**:

```
echo $varName
```

OR

```
echo ${varName}
```

For example, create a variable called **vech**, and give it a value 'Bus', type the following at a shell prompt:

```
vech=Bus
```

Display the value of a variable **vech** with **echo** command:

```
echo $vech
```

OR

```
echo ${vech}
```

However,

```
n=10 # this is ok
10=no# Error, NOT Ok, Value must be on right side of = sign.
```

## Common Examples

Define your home directory:

```
myhome="/home/v/vivek"
echo $myhome
```

Set file path:

```
input="/home/sales/data.txt"
echo "Input file $input"
```

Store current date (you can store the output of date by running the shell command):

```
NOW=$(date)
echo $NOW
```

Set NAS device backup path:

```
BACKUP="/nas05"
echo "Backing up files to $BACKUP/$USERNAME"
```

### More About \${varName} Syntax

You need to use \${varName} to avoid any kind of ambiguity. For example, try to print "MySHELL=>\$SHELLCode<="

```
echo "MySHELL=>$SHELLCode<="
```

Sample outputs:

```
MySHELL=><<=
```

The bash shell would try to look for a variable called SHELLCode instead of \$SHELL. To avoid this kind of ambiguity use \${varName} syntax i.e. \${BASH}Code:

```
echo "MySHELL=>${SHELL}Code<="
```

Sample outputs:

```
MySHELL=>/bin/bashCode<=
```

→ ← Variables **Home** → Default shell variables value →

## Default shell variables value

→ ← Assign values to shell variables **Home** → Rules for Naming variable name →

You can set the default shell variable value using the following syntax. For example, try to display the value of an undefined variable called grandslam:

```
echo $grandslam
```

Nothing will be displayed as the variable grandslam was not set in the first place. If \$grandslam unset, set name to "Maria Sharapova", enter:

```
echo ${grandslam=Maria Sharapova}
```

Sample outputs:

```
Maria Sharapova
```

You can also use the following syntax:

```
echo ${grandslam-Maria Sharapova}
```

- if \$grandslam name is not set use default "Maria Sharapova":

```
echo ${grandslam-Maria Sharapova}
```

- if \$grandslam unset, set name to default "Maria Sharapova":

```
echo ${grandslam=Maria Sharapova}
```



## The := syntax

If the variable is an empty, you can assign a default value. The syntax is:

```
`${var:=defaultValue}
```

### Example

Type the following command at a shell prompt:

```
echo `${arg:=Foo}
bank=HSBC
echo `${bank:=Citi}
unset bank
echo `${bank:=Citi}
```

In this example, the → function die assign a default value if \$1 argument is missing:

```
function die(){
  local error=${1:=Undefined error}
  echo "$0: $LINE $error"
}
die "File not found"
die
```

The second die call will produce an error on screen:

```
bash: $1: cannot assign in this way
```

Update the die → function as follows:

```
function die(){
  local error=${1:-Undefined error}
  echo "$0: $LINE $error"
}
# call die() with an argument
die "File not found"

# call die() without an argument
die
```

# Rules for Naming variable name

---

→ ← Default shell variables value **Home** → Echo Command →

Variable name must begin with alphanumeric character or underscore character (\_), followed by one or more alphanumeric character. Valid shell variable examples:

```
HOME
SYSTEM_VERSION
vech
no
```

Do not put spaces on either side of the equal sign when assigning value to variable. For example, the following is valid variable declaration:

```
no=10
```

However, any of the following variable declaration will result into an error such as *command not found*:

```
no =10
no= 10
no = 10
```

Variables names are case-sensitive, just like filename in Linux

```
no=10
No=11
NO=20
nO=2
```

All are different variable names, to display value 20 you've to use \$NO variable:

```
echo $no # print 10 but not 20
echo $No # print 11 but not 20
echo $nO # print 2 but not 20
echo $NO # print 20
```

You can define a NULL variable as follows (NULL variable is variable which has no value at the time of definition):

```
vech=
$ vech=""
```

Try to print it's value by issuing the following command:

```
echo $vech
```

Do not use ?,\* and other special characters, to name your variable.

```
?no=10 #invalid
out*put=/tmp/filename.txt #invalid
_GREP=/usr/bin/grep #valid
echo $_GREP
```

→ ← Default shell variables value	<b>Home</b>	→ Echo Command →
-----------------------------------	-------------	------------------

## Display the value of shell variables

→ ← Rules for Naming variable name	<b>Home</b>	→ Quoting →
------------------------------------	-------------	----------------

To display the value of a variable, either use echo or printf command as follows:

```
echo $varName
```

OR (see → quoting):

```
echo "$varName"
```

OR

```
printf "%s\n" $varName
```

## Generating Output With echo command

Use echo command to display a line of text or a variable value. It offers no formatting option. It is a good command to display a simple output.

### echo Command Examples

```
#!/bin/bash
# Display welcome message, computer name and date
echo "*** Backup Shell Script ***"
echo
echo "*** Run time: $(date) @ $(hostname) "
echo

# Define variables
BACKUP="/nas05"
NOW=$(date +"%d-%m-%Y")

# Let us start backup
echo "*** Dumping MySQL Database to $BACKUP/$NOW..."

# Just sleep for 3 secs
sleep 3
```

```
# And we are done...
echo
echo "*** Backup wrote to $BACKUP/$NOW/latest.tar.gz"
```

## Printing file names with echo

You can also print the file names using wildcards and echo command:

```
cd /etc
echo *.conf
```

Sample outputs:

```
aatv.conf adduser.conf apg.conf argus.conf atool.conf brltty.conf
ca-certificates.conf
chkrootkit.conf cowpoke.conf cvs-cron.conf cvs-pserver.conf dconf.conf
dconf-custom.conf
debconf.conf deluser.conf
....
...
..
wodim.conf wpa_supplicant.conf wvdial.conf xorg.conf
```

## Generating Output With printf command

printf command format and display data on screen. However, printf does not provide a new line. You need to provide format string using % directives and escapes to format numeric and string arguments in a way that is mostly similar to the C printf() function. Use printf to generate formatted output.

### printf Format Directives

From the printf man page:

```
FORMAT controls the output as in C printf. Interpreted sequences
are:
```

\"	double quote
\NNN	character with octal value NNN (1 to 3 digits)
\\	backslash
\a	alert (BEL)
\b	backspace
\c	produce no further output
\f	form feed

```

\n      new line

\r      carriage return

\t      horizontal tab

\v      vertical tab

\xHH    byte with hexadecimal value HH (1 to 2 digits)

\uHHHH Unicode (ISO/IEC 10646) character with hex value HHHH (4
digits)

\UHHHHHHHH
        Unicode character with hex value HHHHHHHH (8 digits)

%%      a single %

%b      ARGUMENT as a string with '\' escapes interpreted, except
that octal escapes are of the form
        \0 or \0NNN and all C format specifications ending with
one of diouxXfeEgGcs,
        with ARGUMENTs converted to proper type first. Variable
widths are handled.

```

Format control string syntax is as follows:

```
printf "%w.pL\n" $varName
```

Where,

- w - Minimum field width.
- p - Display number of digits after the decimal point (precision).
- L - a conversion character. It can be:
  - s - String
  - d - Integer
  - e - Exponential
  - f - Floating point

### printf Command Examples

Type the following at a shell prompt:

```

vech="Car"
printf "%s\n" $vech
printf "%1s\n" $vech
printf "%1.1s\n" $vech
printf "%1.2s\n" $vech
printf "%1.3s\n" $vech
printf "%10.3s\n" $vech
printf "%10.1s\n" $vech

```

```
no=10
printf "%d\n" $no
big=5355765
printf "%e\n" $big
printf "%5.2e\n" $big
sales=54245.22
printf "%f\n" $sales
printf "%.2f\n" $sales
```

→ ← Rules for Naming variable name	<b>Home</b>	→ Quoting →
------------------------------------	-------------	----------------

## Quoting

---

→ ← Echo Command	<b>Home</b>	→ Export Variables →
------------------	-------------	----------------------

Your bash shell understand special characters with special meanings. For example, \$var is used to display the variable value. Bash expands variables and wildcards, for example:

```
echo $PATH
echo $PS1
echo /etc/*.conf
```

However, sometime you do not wish to use variables or wildcards. For example, do not print value of \$PATH, but just print \$PATH on screen as a word. You can enable or disable the meaning of a special character by enclosing them into a single or double quotes. This is also useful to suppress warnings and error messages while writing the shell scripts.

```
echo "Path is $PATH"
```

OR

```
echo 'I want to print $PATH'
```

## Quoting

There are three types of quotes:

Quote type	Name	Meaning	Example (type at shell prompt)
"	The double quote	The double quote ( "quote" ) protects everything enclosed between two double quote marks except \$, ', " and \. Use the double quotes when you want only <b>variables and command substitution</b> . * <b>Variable</b> - Yes * <b>Wildcards</b> - No * <b>Command substitution</b> - yes	The double quotes allows to print the value of \$SHELL variable, disables the meaning of wildcards, and finally allows command substitution. echo "\$SHELL" echo "/etc/*.conf" echo "Today is \$(date) "
'	The single quote	The single quote ( 'quote' ) protects everything enclosed between two single quote marks. It is used to <b>turn off the special meaning</b> of all characters. * <b>Variable</b> - No * <b>Wildcards</b> - No * <b>Command substitution</b> - No	The single quotes prevents displaying variable \$SHELL value, disabled the meaning of wildcards /etc/*.conf, and finally command substitution (\$(date) itself). echo '\$SHELL' echo '/etc/*.conf' echo 'Today is \$(date) '
\	The Backslash	Use backslahs to change the special meaning of the characters or to escape special characters within the text such as quotation marks.	You can use \ before dollar sign is used to told to have no special meaning. Disable the meaning of the next character in \$PATH (i.e. do not display value of \$PATH variable): echo "Path is \\$PATH" echo "Path is \$PATH"

## The Backslash

The backslash ( \ ) alters the special meaning of the ' and " i.e. it will escape or cancel the special meaning of the next character. The following will display filename in double quote:

```
FILE="/etc/resolv.conf"
echo "File is \" $FILE \" "
```

Sample Outputs:

```
File is "/etc/resolv.conf"
```

The following will remove the special meaning of the dollar ( \$ ) sign:

```
FILE="/etc/resolv.conf"
echo "File is $FILE "
```

Sample Outputs:

```
File is $FILE
```

## The backslash-escaped characters

You can use the following backslash-escaped characters. It will get replaced as specified by the ANSI C standard. Quoting directly from bash man page:

```
\a    alert (bell)
\b    backspace
\e    an escape character
\f    form feed
\n    new line
\r    carriage return
\t    horizontal tab
```

```

    \v      vertical tab
    \\      backslash
    \'      single quote
    \nnn    the eight-bit character whose value is the octal
value nnn (one to three digits)
    \xHH    the eight-bit character whose value is the
hexadecimal value HH (one or two hex digits)
    \cx     a control-x character

```

## Examples

```

echo "Pizza bill \$22.5"
echo -e "\a Ding dong\a"
echo "CIFS path must be \\.\NT-Server-Name\ShareName"
echo -e "Sr.no\t DVD (price) "
echo -e "1\t Spirited Away (INR.200) "
echo -e "2\t Dragon Ball Z (INR.300) "

```

The special parameters \* and @ have special meaning when in double quotes, but you can disable them with the backslash:

```

echo "*"
echo "\*"
echo "\@"

```

## Continue command on next line

You can use the backslash (\) as last character on line to continue command on next line:

```

echo "A monkey-tailed boy named Goku is found by an old martial \
>arts expert who raises him as his grandson. One day Goku meets a \
>girl named Bulma and together they go on a quest to retrieve the seven
Dragon Balls"

```

You can also use the backslash while writing program or → function:

```

# Purpose: clean /tmp/$domain ?
check_temp_clean() {
    [ "$SERVER_MODE" = "daemon" ] || return 1
    [ "$SERVER_MODE" = "init" ] && return 0
    # note use of the backslash character to continue command on
next line
    [ "$SERVER_MODE" = "clean" \
    -a -e /usr/local/etc/nixcraft/lighttpd/disk_cache.init ] &&
return 0
    return 1
}

```



### Protecting command line arguments

Type the following command to find out all c program file (\*.c):

```
find $HOME -name *.c
```

In the above example, the \*.c is expanded by the bash shell. It will try to match all filename ending with .c in the current directory such as main.c, lib1.c, lib2.c, ssh.c, auth.c etc. You can escape the wild card using the backslash as the escape character:

```
find $HOME -name \*.c
find $HOME -name \*main.c
find /nas01/apps/admin -iname \*py
```

You can also use the double quote

```
find $HOME -name "*.c"
```

→ ← Echo Command	<b>Home</b>	→ Export Variables →
------------------	-------------	----------------------

## The export statement

→ ← Quoting	<b>Home</b>	→ Unset →
----------------	-------------	--------------

The export builtin automatically export to the environment of subshells. For example, Create the variable called vech, and give it a value "Bus":

```
vech=Bus
```

Display the value of a variable with echo, enter:

```
echo $vech
```

Now, start a new shell instance, enter:

```
bash
```

Now, display back the value of a variable vech with echo, enter:

```
echo $vech
```

You will get an empty line as the variable vech is not exported to subshell bash instance. To make the variable known to subshells use export command. Try the following example at a console / terminal:

```
export backup="/nas10/mysql"
echo "Backup dir $backup"
bash
echo "Backup dir $backup"
```

By default all user defined variables are local. They are not exported to subshell. Use export command to export variables and functions to subshell. If no variable names or function names are given, or if the -p option is given, a list of all names that are exported in this shell is printed. An argument of -n says to remove the export property from

subsequent NAMES.

```
export -p
```

Please note that system environment variables are passed to subshell.

→ ← Quoting	<b>Home</b>	→ Unset →
----------------	-------------	--------------

## Unset shell and environment variables

---

→ ← Export Variables	<b>Home</b>	→ Getting User Input Via Keyboard →
----------------------	-------------	-------------------------------------

Use unset command to delete the variables during program execution. It can remove both functions and shell variables.

```
vech=Bus
echo $vech
unset vech
echo $vech
```

→ ← Export Variables	<b>Home</b>	→ Getting User Input Via Keyboard →
----------------------	-------------	-------------------------------------

## Getting User Input Via Keyboard

---

→ ← Unset	<b>Home</b>	→ Perform arithmetic operations →
--------------	-------------	--------------------------------------

You can accept input from the keyboard and assign an input value to a user defined shell variable using read command.

### read Command Syntax

```
read -p "Prompt" variable1 variable2 variableN
```

Where,

- **-p "Prompt"** : Display prompt to user without a newline.
- **variable1** : The first input (word) is assigned to the variable1.
- **variable2** : The second input (word) is assigned to the variable2.

## Handling Input

Create a script called greet.sh as follows:

```
#!/bin/bash
read -p "Enter your name : " name
echo "Hi, $name. Let us be friends!"
```

Save and close the file. Run it as follows:

```
chmod +x greet.sh
./greet.sh
```

Sample Outputs:

```
Enter your name : Vivek Gite
Hi, Vivek Gite. Let us be friends!
```

## Examples

Try the following examples.

### Multiple Input (number.sh)

```
#!/bin/bash
# read three numbers and assigned them to 3 vars
read -p "Enter number one : " n1
read -p "Enter number two : " n2
read -p "Enter number three : " n3

# display back 3 numbers - punched by user.
echo "Number1 - $n1"
echo "Number2 - $n2"
echo "Number3 - $n3"
```

### Display Domain Owner Information

A shell script to display the Internet domain name owner information (domain.sh):

```
#!/bin/bash
read -p "Enter the Internet domain name (e.g. nixcraft.com) : "
domain_name
whois $domain_name
```

### Timeout Input

You can time out read command using the -t option. It causes read to time out and return failure if a complete line of input is not read within TIMEOUT seconds. For example, if no input provided within 10 second, program will be aborted (domain2.sh):

```
#!/bin/bash
read -t 10 -p "Enter the Internet domain name (e.g. nixcraft.com) : "
domain_name
whois $domain_name
```

## Handling Passwords

The `-s` option causes input coming from a terminal to not be displayed on the screen. This is useful for password handling (readpass.sh):

```
#!/bin/bash
read -s -p "Enter Password : " my_password
echo
echo "Your password - $my_password"
```

→ ← Unset	<b>Home</b>	→ Perform arithmetic operations →
--------------	-------------	--------------------------------------

## Perform arithmetic operations

→ ← Getting User Input Via Keyboard	<b>Home</b>	→ Create an integer variable →
-------------------------------------	-------------	-----------------------------------

You can perform math operations on Bash shell → variables. The bash shell has built-in arithmetic option. You can also use external command such as `expr` and `bc` calculator.

## Arithmetic Expansion in Bash Shell

Arithmetic expansion and evaluation is done by placing an integer expression using the following format:

```
$( (expression) )
$( ( n1+n2 ) )
$( ( n1/n2 ) )
$( ( n1-n2 ) )
```

## Examples

Add two numbers on fly using the echo command:

```
echo $( ( 10 + 5 ) )
```

Add two numbers using `x` and `y` variable. Create a shell program called `add.sh` using a text editor:

```
#!/bin/bash
x=5
y=10
ans=$( ( x + y ) )
echo "$x + $y = $ans"
```

Save and close the file. Run it as follows:

```
chmod +x add.sh
./add.sh
```

Sample Outputs:

```
5 + 10 = 15
```

Create an interactive program using the `→ read` command called `add1.sh` using a text editor:

```
#!/bin/bash
read -p "Enter two numbers : " x y
ans=$(( x + y ))
echo "$x + $y = $ans"
```

Save and close the file. Run it as follows:

```
chmod +x add1.sh
./add1.sh
```

Sample Outputs:

```
Enter two numbers : 20 30
20 + 30 = 50
```

### Mathematical Operators With Integers

Operator	Description	Example	Evaluates To
+	Addition	echo \$(( 20 + 5 ))	25
-	Subtraction	echo \$(( 20 - 5 ))	15
/	Division	echo \$(( 20 / 5 ))	4
*	Multiplication	echo \$(( 20 * 5 ))	100
%	Modulus	echo \$(( 20 % 3 ))	2
++	post-increment (add variable value by 1)	x=5 echo \$(( x++ ))	6
--	post-decrement (subtract variable value by 1)	x=5 echo \$(( x-- ))	4
**	Exponentiation	x=2 y=3 echo \$(( x ** y ))	8

### Order of Precedence

Operators are evaluated in order of precedence. The levels are listed in order of decreasing precedence (quoting from the bash man page).

```
id++ id--
    variable post-increment and post-decrement
++id --id
    variable pre-increment and pre-decrement
- +
    unary minus and plus
! ~
    logical and bitwise negation
**
    exponentiation
* / %
    multiplication, division, remainder
+ -
    addition, subtraction
```

```

<< >> left and right bitwise shifts
<= >= < >
        comparison
== != equality and inequality
&      bitwise AND
^      bitwise exclusive OR
|      bitwise OR
&&     logical AND
||     logical OR
expr?expr:expr
        conditional operator
= *= /= %= += -= <<= >>= &= ^= |=
        assignment
expr1 , expr2
        comma

```

→ ← Getting User Input Via Keyboard	<b>Home</b>	→ Create an integer variable →
-------------------------------------	-------------	-----------------------------------

## Create an integer variable

→ ← Perform arithmetic operations	<b>Home</b>	→ Create the constants variable →
-----------------------------------	-------------	--------------------------------------

- To create an integer variable use the declare command as follows:

```

declare -i y=10
echo $y

```

- Create a shell script called intmath.sh:

```

#!/bin/bash
# set x,y and z to an integer data type
declare -i x=10
declare -i y=10
declare -i z=0
z=$(( x + y ))
echo "$x + $y = $z"

# try setting to character 'a'
x=a
z=$(( x + y ))
echo "$x + $y = $z"

```

Save and close the file. Run it as follows:

```

chmod +x intmath.sh
./intmath.sh

```

Sample outputs:

```
10 + 10 = 20
0 + 10 = 10
```

- When you try to set the variable x to character 'a', shell converted it to an integer attribute i.e. zero number.

→ ← Perform arithmetic operations	<b>Home</b>	→ Create the constants variable →
-----------------------------------	-------------	-----------------------------------

## Create the constants variable

→ ← Create an integer variable	<b>Home</b>	→ Bash variable existence check →
--------------------------------	-------------	-----------------------------------

- You can create the constants variables using the readonly command or declare command.
- The readonly builtin syntax is as follows:

```
readonly var
readonly varName=value
```

- The declare builtin syntax is as follows:

```
declare -r var
declare -r varName=value
```

### Example

- Create a constant variable called DATA and make it's value is always the same throughout the shell script i.e. it can't be changed:

```
readonly DATA=/home/sales/data/feb09.dat
echo $DATA
# Error ... readonly variable
DATA=/tmp/foo
```

- You cannot → unset (delete) the readonly variable:

```
unset DATA
```

Sample outputs:

```
bash: unset: DATA: cannot unset: readonly variable
```

→ ← Create an integer variable	<b>Home</b>	→ Bash variable existence check →
--------------------------------	-------------	-----------------------------------

# Bash variable existence check

---

→ ← Create the constants variable	<b>Home</b>	→ Chapter 3 Challenges →
--------------------------------------	-------------	-----------------------------

- If the → variable is not defined, you can stop executing the Bash script with the following syntax:

```
 ${varName:?Error varName is not defined}
```

- This is useful for a sanity check.
- The script will stop executing if the → variable is not defined.

## Example

- Create a shell script called varcheck.sh:

```
#!/bin/bash
# varcheck.sh: Variable sanity check with :?
path=${1:?Error command line argument not passed}

echo "Backup path is $path."
echo "I'm done if \ $path is set."
```

Run it as follows:

```
chmod +x varcheck.sh
./varcheck.sh /home
```

Sample outputs:

```
Backup path is /home.
I'm done if $path is set.
```

Run the script without any arguments:

```
./varcheck.sh
```

Sample outputs:

```
./varcheck.sh: line 3: 1: Error command line argument not passed
```

→ ← Create the constants variable	<b>Home</b>	→ Chapter 3 Challenges →
--------------------------------------	-------------	-----------------------------



# Customize the bash shell environments

---

→ ← Bash variable existence check	<b>Home</b>	→ Recalling command history →
-----------------------------------	-------------	----------------------------------

- Strictly speaking there are two types of shell variables:
  1. Local variables (shell variable) - Used by shell and or user scripts. All user created variables are **local unless exported** using the export command.
  2. Environment variables - Used by shell or user but they are also passed onto other command. Environment variables are **passed to subprocesses or subshells**.

## How do I configure and customize the Bash shell environment?

- Your Bash shell can be configured using the following:
  1. → Variables
  2. set command
  3. shopt command

## How do I view local variables?

Use the set built-in command to view all variables:

```
set
```

Usually, all upper-case variables are set by bash. For example,

```
echo $SHELL
echo $MAIL
```

## How do I export local variables?

Use the export command:

```
export EDITOR=/usr/bin/vim
# export DISPLAY environment variable and run xeyes
export DISPLAY=localhost:11.0 xeyes
```

Be careful when changing the shell variables. For a complete list of variables set by shell, read the man page for bash by typing the following command:

```
man bash
```

---

## How do I view environment variables?

Use the `env` command to view all environment variables:

```
env
```

Sample outputs:

```
ORBIT_SOCKETDIR=/tmp/orbit-vivek
SSH_AGENT_PID=4296
GPG_AGENT_INFO=/tmp/gpg-ElCDl5/S.gpg-agent:4297:1
TERM=xterm
SHELL=/bin/bash
XDG_SESSION_COOKIE=186611583e30fed08439ca0047067c9d-1255929792.297209-1700262470
GTK_RC_FILES=/etc/gtk/gtkrc:/home/vivek/.gtkrc-1.2-gnome2
WINDOWID=48252673
GTK_MODULES=canberra-gtk-module
USER=vivek
SSH_AUTH_SOCK=/tmp/keyring-s4fcR1/socket.ssh
GNOME_KEYRING_SOCKET=/tmp/keyring-s4fcR1/socket
SESSION_MANAGER=local/vivek-desktop:/tmp/.ICE-unix/4109
USERNAME=vivek
DESKTOP_SESSION=gnome
PATH=/usr/local/sbin:/usr/local/bin:/usr/sbin:/usr/bin:/sbin:/bin:/usr/games
GDM_XSERVER_LOCATION=local
PWD=/home/vivek
LANG=en_IN
GDM_LANG=en_IN
GDMSESSION=gnome
SHLVL=1
HOME=/home/vivek
GNOME_DESKTOP_SESSION_ID=this-is-deprecated
LOGNAME=vivek
DBUS_SESSION_BUS_ADDRESS=unix:abstract=/tmp/dbus-16XVNAMkFB,guid=0acb6a08e3992ccc7338726c
XDG_DATA_DIRS=/usr/local/share/:/usr/share/:/usr/share/gdm/
WINDOWPATH=7
DISPLAY=:0.0
COLORTERM=gnome-terminal
XAUTHORITY=/home/vivek/.Xauthority
OLDPWD=/usr/share/man
_=/usr/bin/env
```

## Common Environment Variables

- HOME - Your home directory path.
- PATH - Set your executable search path.
- PWD - Your current working directory.
- See more standard environment variables list.

### How do I locate command?

The which command displays the pathnames of the files which would be executed in the current environment. It does this by searching the PATH for executable files matching the names of the arguments.

```
which command-name
```

Show fortune command path which print a random, hopefully interesting, adage on screen. Type the following command:

```
which fortune
```

Sample output:

```
/usr/games/fortune
```

Display your current PATH:

```
echo $PATH
```

Sample outputs:

```
/usr/local/sbin:/usr/local/bin:/usr/sbin:/usr/bin:/sbin:/bin:/usr/games
```

Customize your PATH variable and remove /usr/games from PATH:

```
export PATH=/usr/local/sbin:/usr/local/bin:/usr/sbin:/usr/bin:/sbin:/bin
```

Now, try searching fortune command path, enter:

```
which fortune
```

Try executing fortune command:

```
fortune
```

Sample outputs:

```
-bash: fortune: command not found
```

The fortune command could not be located because '/usr/games' is not included in the PATH environment variable. You can type full command path (/usr/games/fortune) or simply add /usr/games to PATH variable:

```
export PATH=$PATH:/usr/games
fortune
```

Sample outputs:

```
Your lucky number has been disconnected.
```

## whereis command

The whereis command is used to locate the binary, source, and manual page files for a command.

```
whereis command-name  
whereis ls
```

Sample outputs:

```
ls: /bin/ls /usr/share/man/man1/ls.1.gz
```

## whatis command

The whatis command is used display a short description about command. whatis command searches the manual page names and displays the manual page descriptions for a command:

```
whatis command-name  
whatis date  
whatis ifconfig  
whatis ping
```

Sample outputs:

```
date (1)           - print or set the system date and time  
ifconfig (8)      - configure a network interface  
ping (8)          - send ICMP ECHO_REQUEST to network hosts
```

→ ← Bash variable existence check	<b>Home</b>	→ Recalling command history →
-----------------------------------	-------------	----------------------------------

# Recalling command history

---

→ ← Customize the bash shell environments	<b>Home</b>	→ Path name expansion →
---	-------------	-------------------------

- Bash keeps a command history in buffer or a default file called `~/.bash_history`.
- The history buffer can hold many commands.
- Use **history command** to display a list of command you entered at a shell prompt. You can also **repeat commands** stored in history.
- The history command displays the history list with line numbers.
- By default history is enabled but can be disabled using *set builtin* command.
- You can recall the basic command with arrow keys.

## See list of executed commands

Type the following command

```
history
```

Sample outputs:

```
3 tail -f /var/log/maillog
4 cat /etc/resolv.conf
5 vnstat
6 vnstat -m
7 rpm -qa | grep vnstat
8 yum update vnstat
9 cd /opt/
10 wget http://humdi.net/vnstat/vnstat-1.9.tar.gz
11 tar -zxvf vnstat-1.9.tar.gz
12 cd vnstat-1.9
13 ls
14 vi INSTALL
15 make
16 cd examples/
17 ls
18 vi vnstat.cgi
19 cd ..
20 ls
21 cd cfg/
22 ls
23 vi vnstat.conf
24 cd /t,
25 cd /tmp/
26 yumdownloader --source vnstat
27 rpm -ivh vnstat-1.6-1.el5.src.rpm
28 cd -
```

## Recall commands

Simply hit [Up] and [Down] arrow keys.

## Interactively search history

Press [CTRL-R] from the shell prompt to search backwards through history buffer or file for a command:

```
(reverse-i-search)`rpm ': rpm -ql rhn-client-tools-0.4.20-9.e15
```

## To repeat last command

Just type !! at a shell prompt:

```
date
!!
```

## To repeat last command started with ...

Recall the most recent command starting with vn

```
date
vnstat
ls
ifconfig
route -n
!vn
```

## To repeat a command by its number

Recall to command line number 13:

```
history
!13
```

See history command help page for more detailed information about the events and usage:

```
man bash
help history
```

→ ← Create the constants variable	<b>Home</b>	→ Path name expansion →
--------------------------------------	-------------	-------------------------

# Path name expansion

---

→ ← Recalling command history	<b>Home</b>	→ Create and use aliases →
----------------------------------	-------------	----------------------------

- Bash shell support path name expansion using the following techniques.

## Curly braces

- A curly braces (`{..}`) expands to create pattern and syntax is:

```
{ pattern1, pattern2, patternN }
text{ pattern1, pattern2, patternN }
text1{ pattern1, pattern2, patternN }text2
command something/{ pattern1, pattern2, patternN }
```

- It will save command typing time.
- **Arbitrary strings** may be generated.

## Examples

Create a string pattern:

```
echo I like {tom,jerry}
```

Sample outputs:

```
I like tom jerry
```

A string is created, however this can be used to create unique file names:

```
echo file{1,2,3}.txt
```

Sample outputs:

```
file1.txt file2.txt file3.txt
```

OR

```
echo file{1..5}.txt
```

Sample outputs:

```
file1.txt file2.txt file3.txt file4.txt file5.txt
```

The filenames generated need not exist. You can also run command for every pattern inside the braces. Usually, you can type the following to list three files:

```
ls -l /etc/resolv.conf /etc/hosts /etc/passwd
```

But, with curly braces:

```
ls /etc/{resolv.conf,hosts,passwd}
```

Sample outputs: To remove files called `hello.sh`, `hello.py`, `hello.pl`, and `hello.c`, enter:

```
rm -v hello.{sh,py,pl,c}
```

Another example:

```
D=/webroot
mkdir -p $D/{dev,etc,bin,sbin,var,tmp}
```

## Wildcards

- Bash supports the following three simple wildcards:
  1. `*` - Matches any string, including the null string
  2. `?` - Matches any single (one) character.
  3. `[...]` - Matches any one of the enclosed characters.

## Examples

To display all configuration (`.conf`) files stored in `/etc` directory, enter:

```
ls /etc/*.conf
```

To display all C project header files, enter:

```
ls *.h
```

To display all C project `.c` files, enter:

```
ls *.c
```

You can combine wildcards with curly braces:

```
ls *.{c,h}
```

Sample outputs:

```
f.c fo1.c fo1.h fo2.c fo2.h fo3.c fo3.h fo4.c fo4.h fo5.c
fo5.h t.c
```

To list all png file (image1.png, image2.png...image7.png, imageX.png), enter: `<source lang="bash">ls image?.png</source>` To list all file configuration file start with either letter a or b, enter:

```
ls /etc/[ab]*.conf
```

→ ← Recalling command history	<b>Home</b>	→ Create and use aliases →
-------------------------------	-------------	----------------------------



# Create and use aliases

---

→ ← Path name expansion	<b>Home</b>	→ The tilde expansion →
-------------------------	-------------	----------------------------

- An alias is nothing but shortcut to commands.
- Use alias command to display list of all defined aliases.
- Add user defined aliases to ~/.bashrc file.

## Create and use aliases

Use the following syntax:

```
alias name='command'
alias name='command arg1 arg2'
```

### Examples

Create an alias called c to clear the terminal screen, enter:

```
alias c='clear'
```

To clear the terminal, enter:

```
c
```

Create an alias called d to display the system date and time, enter:

```
alias d='date'
d
```

Sample outputs:

```
Tue Oct 20 01:38:59 IST 2009
```

### How do I remove the alias?

- Aliases are created and listed with the alias command, and removed with the unalias command. The syntax is:

```
unalias alias-name
unalias c
unalias c d
```

To list currently defined aliases, enter:

```
alias
```

```
alias c='clear'
alias d='date'
```

If you need to unalias a command called d, enter:

```
unalias d
alias
```

If the `-a` option is given, then remove all alias definitions, enter:

```
unalias -a
alias
```

## How do I permanently add aliases to my session?

- If you want to add aliases for every user, please them either in `/etc/bashrc` or `/etc/profile.d/useraliases.sh` file.
- User specific alias must be placed in `~/.bashrc` (`$HOME/.bashrc`) file.

### Sample `~/.bashrc` file

- Example `~/.bashrc` script:

```
# make sure bc start with standard math library
alias bc='bc -l'
# protect cp, mv, rm command with confirmation
alias cp='cp -i'
alias mv='mv -i'
alias rm='rm -i'

# Make sure dnstop only shows eth1 stats
alias dnstop='dnstop -l 5 eth1'

# Make grep pretty
alias grep='grep --color'

# ls command shortcuts
alias l.='ls -d .* --color=tty'
alias ll='ls -l --color=tty'
alias ls='ls --color=tty'

# Centos/RHEL server update
alias update='yum update'
alias updatey='yum -y update'
# vi is vim
alias vi='vim'

# Make sure vnstat use eth1 by default
alias vnstat='vnstat -i eth1'
```

## How do I ignore an alias?

Consider the following example:

```
alias ls='ls --color'
```

To ignore an alias called `ls` and run `ls` command, enter<sup>[1]</sup>:

```
\ls
```

OR

```
"ls"
```

Or just use the full path:

```
/bin/ls
$(which ls)
```

## References

[1] Bash Shell: Ignore Aliases / Functions When Running A Command (<http://www.cyberciti.biz/faq/ignore-shell-aliases-functions-when-running-command/>)

→ ← Path name expansion	<b>Home</b>	→ The tilde expansion →
-------------------------	-------------	----------------------------

## The tilde expansion

→ ← Create and use aliases	<b>Home</b>	→ Startup scripts →
----------------------------	-------------	------------------------

- The tilde (~) may be used to refer your own home directory or other users home directory.

## Syntax

Display your home directory file listing:

```
ls ~
```

Display a file called `.bashrc` stored in your home directory:

```
ls ~/.bashrc
cat ~/.bashrc
```

- If the tilde-prefix is a `~+`, the value of the shell variable `PWD` replaces the tilde-prefix.

```
pwd
ls ~+
```

- If the tilde-prefix is a `~-`, the value of the shell variable `OLDPWD`, if it is set, is substituted.

```
cd /etc
pwd
cd /bin
pwd
echo $OLDPWD
# display /etc/ directory listing and not /bin
ls ~-
```

→ ← Create and use aliases	<b>Home</b>	→ Startup scripts →
----------------------------	-------------	------------------------

## Startup scripts

---

→ ← The tilde expansion	<b>Home</b>	→ Using aliases →
-------------------------	-------------	----------------------

If you'd like to set the bash environment variables permanently, add your settings to the initialization file located in the home directory of your account `$HOME/.bash_profile`.

### Script Execution Order

1. `/etc/profile` - It contains Linux system wide environment and startup programs. This file **runs first** when a user logs in to the system. This file also act as a **system-wide profile** file for the bash shell.
2. `/etc/profile.d` - `/etc/profile` calls `/etc/profile.d/`. It is a directory and all scripts in this directory called by `/etc/profile` using a `→` for loop. This file **runs second** when a user logs in.
3. `~/.bash_profile` or `$HOME/.bash_profile` - Finally, the file `~/.bash_profile` is called in the users home directory (`$HOME`). This file **runs third** when a user logs in. This file calls `~/.bashrc` in the users home directory.

Please note that each script can add or undo changes made in previously called script. For example, the `PS1` variable is set in the `/etc/profile`, but it can be modified in the `~/.bash_profile` or `~/.bashrc` file.

### Usage

- Use above files to customize your environment.
- Typical examples:
  1. Set `PATH` and `PS1` (shell prompt) variables.
  2. Set default printer via `PRINTER` variable.
  3. Set default text editor via `EDITOR` variable.
  4. Set default pager via `PAGER` variable.
  5. Set default `umask` (file mode creation mask).
  6. Override and remove unwanted settings such as variables or aliases (undo changes).
  7. Set up environment.
  8. Set up `→` aliases.
  9. Set up functions.

## How do I view dot (.) files?

Type the following command in your \$HOME directory:

```
ls -a
```

OR

```
ls -A | less
```

Sample outputs:

```
.bash_logout .bash_profile .bashrc domain-check-2.txt .mozilla
safe s.img test12 test1.csv .zshrc
```

To view contents of the file, enter:

```
cat .bash_profile
```

OR

```
cat $HOME/.bash_profile
```

OR

```
cat ~/.bash_profile
```

## See also

- The role of shells in the Linux environment

→ ← The tilde expansion	<b>Home</b>	→ Using aliases →
-------------------------	-------------	----------------------

# Using aliases

---

→ ← Startup scripts	<b>Home</b>	→ Changing bash prompt →
---------------------	-------------	--------------------------

- Task: Customize your bash shell environment by creating alias as follows:

Alias	The system will run...
c	Clear the screen
update	Update and install the newest versions of all packages currently installed on the Debian system.
ports	Lists all listening TCP/UDP ports with the PID of the associated process.
vi	Run vim text editor instead of old vi.

- Edit ~/.bashrc file:

```
vi ~/.bashrc
```

Append the following aliases:

```
alias c='clear'
alias update='apt-get update && apt-get upgrade'
alias ports='netstat -tulpn'
alias vi='vim'
```

- Save and close the file. Test your changed by doing logout and login back operation. Or simply type the following:

```
. ~/.bashrc
```

OR

```
bash
```

- To list all your aliases, enter:

```
alias
```

## See also

- → Create and use aliases
- Bash Shell Temporarily Disable an Alias <sup>[1]</sup>

→ ← Startup scripts	<b>Home</b>	→ Changing bash prompt →
---------------------	-------------	--------------------------

## References

[1] <http://www.cyberciti.biz/faq/bash-shell-temporarily-disable-an-alias/>

# Changing bash prompt

→ ← Using aliases	<b>Home</b>	→ Setting shell options →
-------------------	-------------	---------------------------

- Task: You need to **customize your bash prompt** by editing PS1 variable.
- Display, your current prompt setting, enter:

```
echo $PS1
```

Sample outputs:

```
\u@\h:\w\$\
```

- For testing purpose set PS1 as follows and notice the change:

```
PS1='your wish is my command : '
```

Sample outputs:

```
vivek@vivek-desktop:~$ PS1='your wish is my command : '
your wish is my command :
```

## Customizing Prompt

Bash shell allows prompt strings to be customized by inserting a number of backslash-escaped special characters. Quoting from the bash man page:

Sequence	Description
\a	An ASCII bell character (07)
\d	The date in "Weekday Month Date" format (e.g., "Tue May 26")
\e	An ASCII escape character (033)
\h	The hostname up to the first .
\H	The hostname (FQDN)
\j	The number of jobs currently managed by the shell
\l	The basename of the shell's terminal device name
\n	Newline
\r	Carriage return
\s	The name of the shell, the basename of \$0 (the portion following the final slash)
\t	The current time in 24-hour HH:MM:SS format
\T	The current time in 12-hour HH:MM:SS format
\@	The current time in 12-hour am/pm format
\A	The current time in 24-hour HH:MM format
\u	The username of the current user

\v	The version of bash (e.g., 2.00)
\V T	The release of bash, version + patch level (e.g., 2.00.0)
\w	The current working directory, with \$HOME abbreviated with a tilde
\W	The basename of the current working directory, with \$HOME abbreviated with a tilde
!\	The history number of this command
\#	The command number of this command
\\$	If the effective UID is 0, a #, otherwise a \$
\nnn	The character corresponding to the octal number nnn
\\	A backslash
\[	Begin a sequence of non-printing characters, which could be used to embed a terminal control sequence into the prompt
\]	End a sequence of non-printing characters

You can use above backslash-escaped sequence to display name of the host with current working directory:

```
PS1='\h \W $ '
```

## Adding color to prompt

It is quite easy to add colors to your prompt. Set green color prompt for normal user account<sup>[1]</sup>:

```
export PS1='\[\e[1;32m\][\u@\h \W]\$'\[\e[0m\] '
```

And red color prompt for root user account:

```
export PS1='\[\e[1;31m\][\u@\h \W]\$'\[\e[0m\] '
```

## How do I make prompt setting permanent?

Edit your ~/.bashrc or ~/.bash\_profile

```
vi ~/.bashrc
```

Append your PS1 definition:

```
export PS1='\[\e[1;32m\][\u@\h \W]\$'\[\e[0m\] '
```

Save and close the file.

## PROMPT\_COMMAND variable

If PROMPT\_COMMAND environment variable set, the value is executed as a command prior to issuing each primary prompt. In other words, the contents of this variable are executed as a regular Bash command just before Bash displays a prompt<sup>[2]</sup>:

```
PROMPT_COMMAND="echo Yahooo"
```

Sample outputs:

```
[vivek@vivek-desktop man]$ PROMPT_COMMAND="echo Yahooo"
Yahooo
[vivek@vivek-desktop man]$ date
Tue Oct 20 23:50:01 IST 2009
```



```
Yahooo
```

## Creating complex prompt

Edit ~/.bashrc file<:

```
vi ~/.bashrc
```

Add the following two shell functions<sup>[3]</sup>

```
bash_prompt_command() {
    # How many characters of the $PWD should be kept
    local pwdmaxlen=25
    # Indicate that there has been dir truncation
    local trunc_symbol=".."
    local dir=${PWD##*/}
    pwdmaxlen=$(( ( pwdmaxlen < ${#dir} ) ? ${#dir} : pwdmaxlen ))
    NEW_PWD=${PWD/#$HOME/~}
    local pwdoffset=$(( ${#NEW_PWD} - pwdmaxlen ))
    if [ ${pwdoffset} -gt "0" ]
    then
        NEW_PWD=${NEW_PWD:$pwdoffset:$pwdmaxlen}
        NEW_PWD=${trunc_symbol}/${NEW_PWD#*/}
    fi
}

bash_prompt() {
    case $TERM in
        xterm*|rxvt*)
            local TITLEBAR='\[\033]0;\u:${NEW_PWD}\007\'
            ;;
        *)
            local TITLEBAR=""
            ;;
    esac
    local NONE="\[\033[0m\" # unsets color to term's fg color

    # regular colors
    local K="\[\033[0;30m\" # black
    local R="\[\033[0;31m\" # red
    local G="\[\033[0;32m\" # green
    local Y="\[\033[0;33m\" # yellow
    local B="\[\033[0;34m\" # blue
    local M="\[\033[0;35m\" # magenta
    local C="\[\033[0;36m\" # cyan
    local W="\[\033[0;37m\" # white

    # emphasized (bolded) colors
    local EMK="\[\033[1;30m\"
```

```

local EMR="\[\033[1;31m\"
local EMG="\[\033[1;32m\"
local EMY="\[\033[1;33m\"
local EMB="\[\033[1;34m\"
local EMM="\[\033[1;35m\"
local EMC="\[\033[1;36m\"
local EMW="\[\033[1;37m\"

# background colors
local BGK="\[\033[40m\"
local BGR="\[\033[41m\"
local BGG="\[\033[42m\"
local BGY="\[\033[43m\"
local BGB="\[\033[44m\"
local BGM="\[\033[45m\"
local BGC="\[\033[46m\"
local BGW="\[\033[47m\"

local UC=$W # user's color
[ $UID -eq "0" ] && UC=$R # root's color

PS1="$TITLEBAR ${EMK} [${UC} \u${EMK}@${UC} \h
${EMB} \${NEW_PWD} ${EMK}] ${UC} \\\$ ${NONE}"
# without colors: PS1="[ \u@ \h \${NEW_PWD} ] \\\$ "
# extra backslash in front of \$ to make bash colorize the prompt
}
# init it by setting PROMPT_COMMAND
PROMPT_COMMAND=bash_prompt_command
bash_prompt
unset bash_prompt

```

## External links

- [How to: Change / Setup bash custom prompt \(PS1\)](#) <sup>[4]</sup>
- [BASH Shell change the color of my shell prompt under Linux or UNIX](#) <sup>[5]</sup>
- [Color Bash Prompt](#) <sup>[6]</sup>
- [Bash Prompt HOWTO](#) <sup>[7]</sup>

→ ← Using aliases	<b>Home</b>	→ Setting shell options →
-------------------	-------------	---------------------------

## References

- [1] BASH Shell change the color of my shell prompt under Linux or UNIX (<http://www.cyberciti.biz/faq/bash-shell-change-the-color-of-my-shell-prompt-under-linux-or-unix/>)
- [2] PROMPT\_COMMAND (<http://tldp.org/HOWTO/Bash-Prompt-HOWTO/x264.html>) from Bash prompt howto
- [3] Color bash prompt ([http://wiki.archlinux.org/index.php/Color\\_Bash\\_Prompt](http://wiki.archlinux.org/index.php/Color_Bash_Prompt)) code taken from the official Arch Linux wiki
- [4] <http://www.cyberciti.biz/tips/howto-linux-unix-bash-shell-setup-prompt.html>
- [5] <http://www.cyberciti.biz/faq/bash-shell-change-the-color-of-my-shell-prompt-under-linux-or-unix/>
- [6] [http://wiki.archlinux.org/index.php/Color\\_Bash\\_Prompt](http://wiki.archlinux.org/index.php/Color_Bash_Prompt)
- [7] <http://tldp.org/HOWTO/Bash-Prompt-HOWTO/>

## Setting shell options

---

→ ← Changing bash prompt	<b>Home</b>	→ Setting system wide shell options →
--------------------------	-------------	---------------------------------------

- Task: Make **changes to your bash shell environment** using set and shopt commands.
- The set and shopt command controls several values of variables controlling shell behavior.

### List currently configured shell options

Type the following command:

```
set -o
```

Sample outputs:

```
allexport          off
braceexpand       on
emacs             on
errexit           off
errtrace          off
functrace         off
hashall           on
histexpand        on
history           on
ignoreeof         off
interactive-comments on
keyword           off
monitor           on
noclobber         off
noexec            off
noglob           off
nolog             off
notify            off
nounset           off
onecmd            off
physical          off
pipefail          off
posix             off
```

```
privileged      off
verbose         off
vi              off
xtrace          off
```

- See set command for detailed explanation of each variable.

## How do I set and unset shell variable options?

To set shell variable option use the following syntax:

```
set -o variableName
```

To unset shell variable option use the following syntax:

```
set +o variableName
```

### Examples

Disable <CTRL-d> which is used to logout of a login shell (local or remote login session over ssh).

```
set -o ignoreeof
```

Now, try pressing [CTRL-d] Sample outputs:

```
Use "exit" to leave the shell.
```

Turn it off, enter:

```
set +o ignoreeof
```

## shopt command

You can turn on or off the values of variables controlling optional behavior using the shopt command. To view a list of some of the currently configured option via shopt, enter:

```
shopt
shopt -p
```

Sample outputs:

```
cdable_vars      off
cdspell          off
checkhash        off
checkwinsize     on
cmdhist          on
compat31         off
dotglob          off
execfail         off
expand_aliases   on
extdebug         off
extglob          off
extquote         on
failglob         off
force_ignores    on
gnu_errfmt       off
```

```
histappend          off
histreedit          off
histverify          off
hostcomplete        on
huponexit           off
interactive_comments on
lithist             off
login_shell         off
mailwarn            off
no_empty_cmd_completion off
nocaseglob          off
nocasematch         off
nullglob            off
progcomp            on
promptvars          on
restricted_shell    off
shift_verbose       off
sourcepath          on
xpg_echo            off
```

### How do I enable (set) and disable (unset) each option?

To enable (set) each option, enter:

```
shopt -s optionName
```

To disable (unset) each option, enter:

```
shopt -u optionName
```

### Examples

If `cdspell` option set, minor errors in the spelling of a directory name in a `cd` command will be corrected. The errors checked for are transposed characters, a missing character, and one character too many. If a correction is found, the corrected file name is printed, and the command proceeds. For example, type the command (note `/etc` directory spelling):

```
cd /etcc
```

Sample outputs:

```
bash: cd: /etcc: No such file or directory
```

Now, turn on `cdspell` option and try again the same `cd` command, enter:

```
shopt -s cdspell
```

```
cd /etcc
```

Sample outputs:

```
/etc
[vivek@vivek-desktop /etc]$
```

## Customizing Bash environment with shopt and set

Edit your ~/.bashrc, enter

```
vi ~/.bashrc
```

Add the following commands:

```
# Correct dir spellings
shopt -q -s cdspell

# Make sure display get updated when terminal window get resized
shopt -q -s checkwinsize

# Turn on the extended pattern matching features
shopt -q -s extglob

# Append rather than overwrite history on exit
shopt -s histappend

# Make multi-line commandline in history
shopt -q -s cmdhist

# Get immediate notification of background job termination
set -o notify

# Disable [CTRL-D] which is used to exit the shell
set -o ignoreeof

# Disable core files
ulimit -S -c 0 > /dev/null 2>&1
```

### How do I setup environment variables?

Simply add the settings to ~/.bashrc:

```
# Store 5000 commands in history buffer
export HISTSIZE=5000

# Store 5000 commands in history FILE
export HISTFILESIZE=5000

# Avoid duplicates in history
export HISTIGNORE='&:[ ]*'

# Use less command as a pager
export PAGER=less

# Set vim as default text editor
export EDITOR=vim
```

```
export VISUAL=vim
export SVN_EDITOR="$VISUAL"

# Oracle database specific
export ORACLE_HOME=/usr/lib/oracle/xe/app/oracle/product/10.2.0/server
export ORACLE_SID=XE
export NLS_LANG=$(($ORACLE_HOME/bin/nls_lang.sh))

# Set JAVA_HOME
export JAVA_HOME=/usr/lib/jvm/java-6-sun/jre

# Add ORACLE, JAVA and ~/bin bin to PATH
export PATH=$PATH:$ORACLE_HOME/bin:$HOME/bin:$JAVA_HOME/bin

# Secure SSH login stuff using keychain
# No need to input password again ever
/usr/bin/keychain $HOME/.ssh/id_dsa
source $HOME/.keychain/$HOSTNAME-sh

# Turn on Bash command completion
source /etc/bash_completion

# MS-DOS / XP cmd like stuff
alias edit=$VISUAL
alias copy='cp'
alias cls='clear'
alias del='rm'
alias dir='ls'
alias md='mkdir'
alias move='mv'
alias rd='rmdir'
alias ren='mv'
alias ipconfig='ifconfig'

# Other Linux stuff
alias bc='bc -l'
alias diff='diff -u'

# get updates from RHN
alias update='yum -y update'

# set eth1 as default
alias dnstop='dnstop -l 5 eth1'
alias vnstat='vnstat -i eth1'

# force colorful grep output
alias grep='grep --color'
```

```
# ls stuff
alias l.='ls -d .* --color=tty'
alias ll='ls -l --color=tty'
alias ls='ls --color=tty'
```

→ ← Changing bash prompt	<b>Home</b>	→ Setting system wide shell options →
--------------------------	-------------	---------------------------------------

## Setting system wide shell options

---

→ ← Setting shell options	<b>Home</b>	→ Chapter 3 Challenges →
---------------------------	-------------	--------------------------

- By default `/etc/profile` file act as a system-wide profile file for the Bash shell.
- You can force setting using this file for all user. However, it is recommended that you use `/etc/profile.d` file under CentOS / Fedora / Redhat Enterprise Linux. For all other distribution edit `/etc/profile` file.
- Task: Setting up a `JAVA_HOME` and `PATH` settings for all user.
  - Create `/etc/profile.d/java.sh` file, enter:

```
#!/bin/bash
export JAVA_HOME=/opt/jdk1.5.0_12
export PATH=$PATH:$JAVA_HOME/bin
```

Save and close the file. Setup → executable permission:

```
chmod +x /etc/profile.d/java.sh
```

→ ← Setting shell options	<b>Home</b>	→ Chapter 3 Challenges →
---------------------------	-------------	--------------------------



# Chapter 3 Challenges

---

→ ← Setting system wide shell options	<b>Home</b>	Chapter 4: Conditionals Execution (Decision Making) →
---------------------------------------	-------------	---

1. Make a backup of existing variable called PS1 to OLDPS1. Set PS1 to '\$'. Reset your prompt using OLDPS1 variable.
2. Customize your bash prompt by setting PS1 variable to 'I Love Scripting '.
3. Edit your \$HOME/.bashrc file and set your new PS1 variable.
4. Create a list of legal and illegal bash variable names. Describe why each is either legal or illegal.
5. Write a command to display the environment.
6. Write a shell script that allows a user to enter his or her top three ice cream flavors. Your script should then print out the name of all three flavors.
7. Write a shell script that allows a user to enter any Internet domain name (host name such as www.cyberciti.biz). Your script should then print out the IP address of the Internet domain name.
8. Write a shell script that allows a user to enter any existing file name. The program should then copy file to /tmp directory.
9. Write a shell script that allows a user to enter directory name. The program should then create directory name in /tmp directory.
10. Write a shell script that allows a user to enter three file names. The program should then copy all files to USB pen.
11. Write a simple shell script where the user enters a pizza parlor bill total. Your script should then display a 10 percent tip.
12. Write a simple calculator program that allows user to enter two numeric values and operand as follows. The program should then print out the sum of two numbers. Make sure it works according to entered operand.

```
Enter two values : 10 20
Enter operand ( +, -, /, *) : +
Output: 10 + 20 = 30
```

→ ← Setting system wide shell options	<b>Home</b>	Chapter 4: Conditionals Execution (Decision Making) →
---------------------------------------	-------------	---

---

# Chapter 4: Conditionals Execution (Decision Making)

---

## Bash structured language constructs

---

← Chapter 4: Conditionals Execution (Decision Making) **Home** → Test command →

You can use the `if` command to test a condition. For example, shell script may need to execute `tar` command only if a certain condition exists (such as backup only on Friday night).

```
If today is Friday
    execute tar command
otherwise
    print an error message on screen.
```

.

### More About Logic

- So far, the script you've used followed sequential flow:

```
#!/bin/bash
echo "Today is $(date) "
echo "Current directory : $(pwd) "
echo "What User Are Doing:"
w
```

- Each command and/or statement is executed once, in order in above script.
- With sequential flow scripts, you cannot write complex applications (intelligent Linux scripts).
- However, with `if` command you will be able to selectively run certain commands (or part) of your script.
- You can create a warning message and run script more interactively using `if` command to execute code based on a condition.

### But What Is A Condition?

- A condition is nothing but an expression that evaluates to a boolean value (true or false).
- In other words condition can be either true or false.
- A condition is used in shell script loops and `if` statements.

### So, How Do I Make One?

A condition is mainly a comparison between two values. Open a shell prompt (console) and type the following command:

```
echo $(( 5 + 2 ))
```

Sample Output:

```
7
```

---

Addition is 7. But,

```
echo $(( 5 < 2 ))
```

Sample Output:

```
0
```

Answer is zero (0). Shell simple compared two number and returned result as true or false. Is 5 is less than 2? No. So 0 is returned. The Boolean (logical data) type is a primitive data type having one of two values

- True
- False

In shell:

- 0 value indicates false.
- 1 or non-zero value indicate true.

### Examples

Operator	Example	Description	True / False	Evaluates To
5 > 12	echo \$( 5 > 12 )	Is 5 greater than 12?	No (false)	0
5 == 10	echo \$( 5 == 10 )	Is 5 equal to 10?	No (flase)	0
5 != 2	echo \$( 5 != 2 )	5 is not equal to 2?	Yes (true)	1
1 < 2	echo \$( 1 < 2 )	Is 1 less than 2?	Yes (true)	1
5 == 5	echo \$( 5 == 5 )	Is 5 equal to 5?	Yes (true)	1

Now, it make no sense to use comparisons like above echo command. But, when you compare it with some value it becomes very useful. For example:

```
if [ file exists /etc/resolv.conf ]
then
    make a copy
else
    print an error on screen
fi
```

# Test command

---

→ ← Bash structured language constructs **Home** → if structures to execute code based on a condition →

The test command is used to check file types and compare values. Test is used in conditional execution. It is used for:

- File attributes comparisons
- Perform string comparisons.
- Arithmetic comparisons.

## test command syntax

```
test condition
```

OR

```
test condition && true-command
```

OR

```
test condition || false-command
```

OR

```
test condition && true-command || false-command
```

Type the following command at a shell prompt (is 5 greater than 2?):

```
test 5 > 2 && echo "Yes"
```

Sample Output:

```
Yes
```

You need to use the test command while make decision. Try the following examples and note down its output:

```
test 5 == 5 && echo "Yes" || echo "No"
test 5 == 15 && echo "Yes" || echo "No"
test 5 != 10 && echo "Yes" || echo "No"
test -f /etc/resolv.conf && echo "File /etc/resolv.conf found." || echo
"File /etc/resolv.conf not found."
test -f /etc/resolv1.conf && echo "File /etc/resolv.conf found." ||
echo "File /etc/resolv.conf not found."
```

→ ← Bash structured language constructs **Home** → if structures to execute code based on a condition →

---

# If structures to execute code based on a condition

---

→ ← Test command	<b>Home</b>	→ If..else..fi →
------------------	-------------	------------------

Now, you can use the if statement to test a condition. if command The general syntax is as follows:

```
if condition
then
    command1
    command2
    ...
    commandN
fi
```

OR

```
if test var == value
then
    command1
    command2
    ...
    commandN
fi
```

OR

```
if test -f /file/exists
then
    command1
    command2
    ...
    commandN
fi
```

If given condition is true than the command1, command2..commandN are executed. Otherwise script continues directly to the next statement following the if structure. Open a text editor and create the script called verify.sh:

```
#!/bin/bash
read -p "Enter a password" pass
if test "$pass" == "jerry"
then
    echo "Password verified."
fi
```

Save and close the file. Run it as follows:

```
chmod +x verify.sh
./verify.sh
```

Sample Outputs:

```
Enter a password : jerry
Password verified.
```

Run it again:

```
./verify.sh
```

Sample Output:

```
Enter a password : tom
```

The if structure is pretty straightforward. The read command will read the password and store it to variable called pass. If \$pass (i.e. password) is equal to "jerry", then "Password verified." is displayed. However, if it is not equal to "jerry", the script does not print any message and script will go to the next statement. Here is another example (number.sh):

```
#!/bin/bash
read -p "Enter # 5 : " number
if test $number == 5
then
    echo "Thanks for entering # 5"
fi
if test $number != 5
then
    echo "I told you to enter # 5. Please try again."
fi
```

Enter # 5 : 5 Thanks for entering # 5 Save and close the file. Run it as follows:

```
chmod +x number.sh
./number.sh
```

Sample Outputs:

```
Enter # 5 : 5
Thanks for entering # 5
```

Try it again:

```
./number.sh
```

Sample Outputs:

```
Enter # 5 : 11
I told you to enter # 5. Please try again.
```

# If..else..fi

---

→ ← if structures to execute code based on a condition	<b>Home</b>	→ Nested ifs →
--	-------------	----------------

if..else..fi allows to make choice based on a condition. For example, find out if file exists (true condition) or not (false condition) and take action based on a condition result.

## if..then..else Syntax

```

if condition
then
    condition is true
    execute all commands up to else statement

else
    if condition is not true then
    execute all commands up to fi

fi

```

OR

```

if test var -eq val
then
    condition is true
    execute all commands up to else statement

else
    if condition is not true then
    execute all commands up to fi

fi

```

Make sure you always end the construct with fi.

## if/then/else Example

Update verify.sh as follows

```

#!/bin/bash
read -p "Enter a password" pass
if test "$pass" == "jerry"
then
    echo "Password verified."
else
    echo "Access denied."
fi

```

Save and close the file. Run it as follows:

```
./verify.sh
```

You have updated `verify.sh` and added an `else` statement to existing `if` command to create `if..else..fi` structure. If `$pass` (i.e. password) is equal to "jerry", then "Password verified." is displayed. However, with `else` statement, the script can display "Access denied." message on screen. This ensures that your script will always execute one of the code block as follows:

```
if condition is true
then
    print "Password verified message."
else    # if condition is false
    print "Access denied message."
fi
```

### Number Testing Script

Create a shell script called `testnum.sh`:

```
#!/bin/bash
read -p "Enter number : " n
if test $n -ge 0
then
    echo "$n is positive number."
else
    echo "$n number is negative number."
fi
```

Save and close the file. Run it as follows:

```
chmod +x testnum.sh
./testnum.sh
```

### Putting It All Together

The following script (`chk_hardware.sh`) use `mcelog` command on x86-64 machines running a 64-bit Linux kernel. It will find out hardware error such as RAM or CPU and send an e-mail to server administrator. This is useful for predicting server hardware failure before actual server crash. This script demonstrate:

- Script comments
- Shell script variable
- `if..else..fi` command
- Sending an e-mail from the script

```
#!/bin/bash
# Purpose: Detecting Hardware Errors
# Author: Vivek Gite <vivek@nixcraft.com>
# Note : The script must run as a cron-job.
# Last updated on : 28-Aug-2007
# -----

# Store path to commands
LOGGER=/usr/bin/logger
FILE=/var/log/mcelog
```



```
# Store email settings
AEMAIL="vivek@nixcraft.net.in"
ASUB="H/W Error - $(hostname) "
AMESS="Warning - Hardware errors found on $(hostname) @ $(date). See
log file for the details /var/log/mcelog."
OK_MESS="OK: NO Hardware Error Found."
WARN_MESS="ERROR: Hardware Error Found."

# Check if $FILE exists or not
if test ! -f "$FILE"
then
    echo "Error - $FILE not found or mcelog is not configured for 64
bit Linux systems."
    exit 1
fi

# okay search for errors in file
error_log=$(grep -c -i "hardware error" $FILE)

# error found or not?
if [ $error_log -gt 0 ]
then
    # yes error(s) found, let send an email
    echo "$AMESS" | email -s "$ASUB" $AEMAIL
else
    # naa, everything looks okay
    echo "$OK_MESS"
fi
```

→ ← if structures to execute code based on a condition	<b>Home</b>	→ Nested ifs →
--	-------------	----------------

# Nested ifs

---

→ ← If..else..fi **Home** → Multilevel if-then-else →

You can put if command within if command and create the nested ifs as follows:

```
if condition
then
  if condition
  then
    .....
    ..
    do this
  else
    ....
    ..
    do this
  fi
else
  ...
  .....
  do this
fi
```

→ ← If..else..fi **Home** → Multilevel if-then-else →

---

# Multilevel if-then-else

---

→ ← Nested ifs	<b>Home</b>	→ The exit status of a command →
----------------	-------------	----------------------------------

if..elif..else..fi allows the script to have various possibilities and conditions. This is handy, when you want to compare one variable to a different values.

```

if condition
then
    condition is true
    execute all commands up to elif statement
elif condition1
then
    condition1 is true
    execute all commands up to elif statement
elif condition2
then
    condition2 is true
    execute all commands up to elif statement

elif conditionN
then
    conditionN is true
    execute all commands up to else statement

else
    None of the above conditions are true
    execute all commands up to fi
fi

```

In if..elif..else..fi structure, the block of the first true condition is executed. If no condition is true, the else block, is executed.

## Example

A simple shell script to determine if the given number is a negative or a positive number (numest.sh):

```

#!/bin/bash
read -p "Enter a number : " n
if [ $n -gt 0 ]; then
    echo "$n is a positive."
elif [ $n -lt 0 ]
then
    echo "$n is a negative."
elif [ $n -eq 0 ]
then
    echo "$n is zero number."
else

```

```
echo "Oops! $n is not a number."
fi
```

Save and close the file. Run it as follows:

```
chmod +x numest.sh
./numest.sh
```

→ ← Nested ifs **Home** → The exit status of a command →

## The exit status of a command

→ ← Multilevel if-then-else **Home** → Conditional execution →

Each Linux command returns a status when it terminates normally or abnormally. You can use command exit status in the shell script to display an error message or take some sort of action. For example, if tar command is unsuccessful, it returns a code which tells the shell script to send an e-mail to sys admin.

### Exit Status

- Every Linux command executed by the shell script or user, has an exit status.
- The exit status is an integer number.
- The Linux man pages stats the exit statuses of each command.
- 0 exit status means the command was successful without any errors.
- A non-zero (1-255 values) exit status means command was failure.
- You can use special shell variable called `?` to get previously executed command. To print `?` variable use the echo command (`echo $?`)

### How Do I See Exit Status Of The Command?

Type the following command:

```
date
```

To view exist status of date command, enter:

```
echo $?
```

Sample Output:

```
0
```

Try non-existence command

```
date1
echo $?
ls /eeteec
echo $?
```

Sample Output:

```
2
```

According to ls man page - *exit status is 0 if OK, 1 if minor problems, 2 if serious trouble.*

## How Do I Store Exit Status Of The Command In a Shell Variable?

Assign \$? to a shell variable:

```
ls -l /tmp
status=$?
echo "ls command exit stats - $status"
```

### Exit Status Shell Script Example

A simple shell script to locate username (finduser.sh)

```
#!/bin/bash
# set var
PASSWD_FILE=/etc/passwd

# get user name
read -p "Enter a user name : " username

# try to locate username in in /etc/passwd
grep "^$username" $PASSWD_FILE > /dev/null

# store exit status of grep
# if found grep will return 0 exit stauts
# if not found, grep will return a nonzero exit stauts
status=$?

if test $status -eq 0
then
    echo "User '$username' found in $PASSWD_FILE file."
else
    echo "User '$username' not found in $PASSWD_FILE file."
fi
```

Save and close the file. Run it as follows:

```
chmod +x finduser.sh
./finduser.sh
```

Sample Outputs:

```
Enter a user name : vivek
User 'vivek' found in /etc/passwd file.
```

Run it again:

```
chmod +x finduser.sh
./finduser.sh
```

### Sample Outputs:

```
Enter a user name : tommy
User 'tommy' not found in /etc/passwd file.
```

You can combine the grep and if command in a single statement as follows:

```
if test grep "^$username" >/dev/null
then
    echo "User '$username' found in $PASSWD_FILE file."
else
    echo "User '$username' not found in $PASSWD_FILE file."
fi
```

Notice that standard output from grep command is ignored by sending them to /dev/null.

→ ← Multilevel if-then-else	<b>Home</b>	→ Conditional execution →
--------------------------------	-------------	------------------------------

## Conditional execution

---

→ ← The exit status of a command	<b>Home</b>	→ Logical AND →
----------------------------------	-------------	-----------------

You can link two commands under bash shell using conditional execution based on the exit status of the last command. This is useful to control the sequence of command execution. Also, you can do conditional execution using the if statement. The bash support the following two conditional executions:

1. → Logical AND && - Run second command only if **first is successful**.
2. → Logical OR || - Run second command only if first is **not successful**.

→ ← The exit status of a command	<b>Home</b>	→ Logical AND →
----------------------------------	-------------	-----------------

# Logical AND &&

---

→ ← Conditional execution	<b>Home</b>	→ Logical OR →
---------------------------	-------------	----------------

Logical and (&&) is boolean operator. It can execute commands or shell functions based on the → exit status of another command.

## Syntax

```
command1 && command2
```

OR

```
First_command && Second_command
```

command2 is executed if, and only if, command1 returns an → exit status of zero (true). In other words, run command1 and if it is successful, then run command2.

## Example

Type the following at a shell prompt:

```
rm /tmp/filename && echo "File deleted."
```

The → echo command will only run if the rm command exits successfully with a status of zero. If file is deleted successfully the rm command set the exit stats to zero and echo command get executed.

### Lookup a username in /etc/passwd file

```
grep "^vivek" /etc/passwd && echo "Vivek found in /etc/passwd"
```

### Exit if a directory /tmp/foo does not exist

```
test ! -d /tmp/foo && { read -p "Directory /tmp/foo not found. Hit [Enter] to exit..." enter; exit 1; }
```

## External links

- How to display error message instantly when command fails <sup>[1]</sup>

→ ← Conditional execution	<b>Home</b>	→ Logical OR →
---------------------------	-------------	----------------

## References

[1] <http://www.cyberciti.biz/tips/shell-displaying-error-messages.html>

# Logical OR ||

---

→ ← Logical AND	<b>Home</b>	→ Logical Not ! →
-----------------	-------------	----------------------

Logical OR (||) is boolean operator. It can execute commands or shell functions based on the → exit status of another command.

## Syntax

```
command1 || command2
```

OR

```
First_command || Second_command
```

command2 is executed if, and only if, command1 returns a non-zero exit status. In other words, run command1 successfully or run command2.

## Example

```
cat /etc/shadow 2>/dev/null || echo "Failed to open file"
```

The cat command will try to display /etc/shadow file and it (the cat command) sets the exit stats to non-zero value if it failed to open /etc/shadow file. Therefore, 'Failed to open file' will be displayed cat command failed to open the file.

### Find username else display an error

```
grep "^vivek" /etc/passwd || echo "User vivek not found in /etc/passwd"
```

## How Do I Combine Both Logical Operators?

Try it as follows:

```
cat /etc/shadow 2>/dev/null && echo "File successfully opened." || echo "Failed to open file."
```

Make sure only root can run this script:

```
test $(id -u) -eq 0 && echo "You are root" || echo "You are NOT root"
```

OR

```
test $(id -u) -eq 0 && echo "Root user can run this script." || echo "Use sudo or su to become a root user."
```

---



## External links

- How to display error message instantly when command fails <sup>[1]</sup>

→ ← Logical AND	<b>Home</b>	→ Logical Not ! →
-----------------	-------------	----------------------

## Logical Not !

---

→ ← Logical OR	<b>Home</b>	→ Conditional expression →
----------------	-------------	----------------------------

Logical not (!) is boolean operator, which is used to test whether expression is true or not. For example, if file not exists, then display an error on screen.

## Syntax

```
! expression
```

True if expression is false.

## Example

Try the following example:

```
test ! -f /etc/resolv.conf && echo "File /etc/resolv.conf not found."
```

OR

```
test ! -f /etc/resolv.conf && echo "File /etc/resolv.conf not found."  
|| echo "File /etc/resolv.conf found."
```

→ ← Logical OR	<b>Home</b>	→ Conditional expression →
----------------	-------------	----------------------------

---

# Conditional expression using [

→ ← Logical Not !	<b>Home</b>	→ Numeric comparison →
----------------------	-------------	---------------------------

The → test command is used to check file types and compare values. You can also use [ as test command. It is used for:

- File attributes comparisons
- Perform string comparisons.
- Arithmetic comparisons.

## Syntax

```
[ condition ]
```

OR

```
[ ! condition ]
```

OR

```
[ condition ] && true-command
```

OR

```
[ condition ] || false-command
```

OR

```
[ condition ] && true-command || false-command
```

## Examples

```
[ 5 == 5 ] && echo "Yes" || echo "No"
[ 5 == 15 ] && echo "Yes" || echo "No"
[ 5 != 10 ] && echo "Yes" || echo "No"
[ -f /etc/resolv.conf ] && echo "File /etc/resolv.conf found." || echo
"File /etc/resolv.conf not found."
[ -f /etc/resolv1.conf ] && echo "File /etc/resolv.conf found." || echo
"File /etc/resolv.conf not found."
```

→ ← Logical Not !	<b>Home</b>	→ Numeric comparison →
----------------------	-------------	---------------------------

# Conditional expression using `<nowiki>[[</nowiki>nowiki>`

*This article is a stub. You can help us by expanding it* <sup>[1]</sup>.

## References

[1] [http://en.wikipedia.org/wiki/Bash\\_test\\_conditional\\_expression\\_%28safer\\_version%29](http://en.wikipedia.org/wiki/Bash_test_conditional_expression_%28safer_version%29)

## Numeric comparison

→ ← Conditional expression	<b>Home</b>	→ String comparison →
----------------------------	-------------	--------------------------

The `→` test command can perform various numeric comparison using the following operators:

Operator	Syntax	Description	Example
<code>eq</code>	<code>INTEGER1 -eq INTEGER2</code>	INTEGER1 is equal to INTEGER2	<pre>#!/bin/bash read -p "Please enter and confirm number 10 via keyboard : " n if test \$n -eq 10 then     echo "Thanks for entering 10 number." fi</pre>
<code>ge</code>	<code>INTEGER1 -ge INTEGER2</code>	INTEGER1 is greater than or equal to INTEGER2	<pre>#!/bin/bash read -p "Enter number &gt;= 10 : " n if test \$n -ge 10 then     echo "\$n is greater than or equal to 10" fi</pre>
<code>gt</code>	<code>INTEGER1 -gt INTEGER2</code>	INTEGER1 is greater than INTEGER2	<pre>#!/bin/bash read -p "Enter number &gt; 20 : " n if test \$n -gt 20 then     echo "\$n is greater than 20." fi</pre>
<code>le</code>	<code>INTEGER1 -le INTEGER2</code>	INTEGER1 is less than or equal to INTEGER2	<pre>#!/bin/bash read -p "Enter backup level : " n if test \$n -le 6 then     echo "Incremental backup requested." fi if test \$n -eq 7 then     echo "Full backup requested." fi</pre>

lt	INTEGER1 -lt INTEGER2	INTEGER1 is less than INTEGER2	#!/bin/bash read -p "Do not enter negative number here : " n if test \$n -lt 0 then echo "Dam! you entered negative number!!" fi
ne	INTEGER1 -ne INTEGER2	INTEGER1 is not equal to INTEGER2	#!/bin/bash read -p "Do not enter -1 number here : " n if test \$n -ne -1 then echo "Thanks for not entering -1." fi

→ ← Conditional expression	<b>Home</b>	→ String comparison →
----------------------------	-------------	--------------------------

## String comparison

→ ← Numeric comparison	<b>Home</b>	→ File attributes comparisons →
------------------------	-------------	---------------------------------

String comparison can be done using test command itself.

### The strings are equal

Use the following syntax:

```
STRING1 = STRING2
```

#### Example

```
#!/bin/bash
read -s -p "Enter your password " pass
echo
if test "$pass" = "tom"
then
    echo "You are allowed to login!"
fi
```

### The strings are not equal

Use the following syntax:

```
STRING1 != STRING2
```

#### Example

```
#!/bin/bash
read -s -p "Enter your password " pass
echo
```

```
if test "$pass" != "tom"
then
    echo "Wrong password!"
fi
```

## The length of STRING is zero

Use the following syntax (this is useful to see if variable is empty or not):

```
-z STRING
```

### Example

```
#!/bin/bash
read -s -p "Enter your password " pass
echo
if test -z $pass
then
    echo "No password was entered!!! Cannot verify an empty
password!!!"
    exit 1
fi
if test "$pass" != "tom"
then
    echo "Wrong password!"
fi
```

→ ← Numeric comparison	<b>Home</b>	→ File attributes comparisons →
------------------------	-------------	---------------------------------

# File attributes comparisons

---

→ ← String comparison	<b>Home</b>	→ Shell command line parameters →
-----------------------	-------------	--------------------------------------

Use the following file comparisons to test various file attributes. You can use the → test command or → conditional expression using [.

## -a file

True if file exists.

### Example

```
[ -a /etc/resolv.conf ] && echo "File found" || echo "Not found"
```

## -b file

True if file exists and is a block special file.

### Example

```
[ -b /dev/zero ] && echo "block special file found" || echo "block special file not found"
```

OR

```
[ -b /dev/sda ] && echo "block special file found" || echo "block special file not found"
```

## -c file

True if file exists and is a character special file.

### Example

```
[ -c /dev/tty0 ] && echo "Character special file found." || echo "Character special file not found."
```

## -d dir

True if file exists and is a directory.

### Example

```
#!/bin/bash
DEST=/backup
SRC=/home

# Make sure backup dir exists
[ ! -d $DEST ] && mkdir -p $DEST
```

```
# If source directory does not exists, die...
[ ! -d $SRC ] && { echo "$SRC directory not found. Cannot make backup
to $DEST"; exit 1; }

# Okay, dump backup using tar
echo "Backup directory $DEST..."
echo "Source directory $SRC..."
/bin/tar zcf $SRC $DEST/backup.tar.gz 2>/dev/null

# Find out if backup failed or not
[ $? -eq 0 ] && echo "Backup done!" || echo "Backup failed"
```

## **-e file**

True if file exists.

### **Example**

```
[ -e /tmp/test.txt ] && echo "File found" || echo "File not found"
```

## **-f file**

True if file exists and is a regular file.

### **Example**

```
[ ! -f /path/to/file ] && echo "File not found!"
```

A sample shell script that compare various file attributes and create webalizer (application that generates web pages of analysis, from access and usage log) stats configuration file to given Internet domain name.

```
#!/bin/bash
# Purpose: A Shell Script To Create Webalizer Stats Configuration File
# Written by: Vivek Gite
# -----
# Set vars

# Apache vroot for each domain
HTTPDROOT="/home/httpd"

# Path to GeoIP DB
GEOIPDBPATH="/usr/local/share/GeoIP/GeoIP.dat"

# Get the Internet domain such as cyberciti.biz
echo "*** A Shell Script To Create Webalizer Stats Configuration File
***"
read -p "Enter a domain name : " DOMAIN

# Make sure we got the Input else die with an error on screen
[ -z $DOMAIN ] && { echo "Please enter a domain name. Try again!"; exit
```

```
1; }

# Alright, set some variable based upon $DOMAIN
OUT="$HTTPDROOT/$DOMAIN/stats/webalizer.conf"
CONFROOT="$HTTPDROOT/$DOMAIN/stats"
LOGFILE="$HTTPDROOT/$DOMAIN/logs/access.log"

# Die if configuration file exists...
[ -f $OUT ] && { echo "Webalizer configuration file '$OUT' exists for
domain $DOMAIN."; exit 2; }

# Make sure configuration directory exists
[ ! -d $CONFROOT ] && mkdir -p $CONFROOT

# Write a log file

>$OUT
echo "LogFile $LOGFILE" >> $OUT
echo "LogType clf" >> $OUT
echo "OutputDir $CONFROOT/out" >> $OUT
echo "HistoryName $CONFROOT/webalizer.hist" >> $OUT
echo "Incremental yes" >> $OUT
echo "IncrementalName $CONFROOT/webalizer.current" >> $OUT
echo "HostName $DOMAIN" >> $OUT
echo "Quiet yes" >> $OUT
echo "FoldSeqErr yes" >> $OUT
echo "AllSearchStr yes" >> $OUT
echo "HideSite $DOMAIN" >> $OUT
echo "HideSite localhost" >> $OUT
echo "HideReferrer $DOMAIN" >> $OUT
echo "HideURL *.gif" >> $OUT
echo "HideURL *.GIF" >> $OUT
echo "HideURL *.jpg" >> $OUT
echo "HideURL *.JPG" >> $OUT
echo "HideURL *.png" >> $OUT
echo "HideURL *.PNG" >> $OUT
echo "HideURL *.ra" >> $OUT
echo "GroupReferrer yahoo.com/ Yahoo!" >> $OUT
echo "GroupReferrer excite.com/ Excite" >> $OUT
echo "GroupReferrer infoseek.com/ InfoSeek" >> $OUT
echo "GroupReferrer webcrawler.com/ WebCrawler" >> $OUT
echo "SearchEngine .yahoo. p=" >> $OUT
echo "SearchEngine altavista.com q=" >> $OUT
echo "SearchEngine .google. q=" >> $OUT
echo "SearchEngine eureka.com q=" >> $OUT
echo "SearchEngine lycos.com query=" >> $OUT
echo "SearchEngine hotbot.com MT=" >> $OUT
```



```
echo "SearchEngine msn.com MT=" >> $OUT
echo "SearchEngine infoseek.com qt=" >> $OUT
echo "SearchEngine webcrawler searchText=" >> $OUT
echo "SearchEngine excite search=" >> $OUT
echo "SearchEngine netscape.com search=" >> $OUT
echo "SearchEngine mamma.com query=" >> $OUT
echo "SearchEngine alltheweb.com query=" >> $OUT
echo "SearchEngine northernlight.com qr=" >> $OUT
echo "CountryFlags yes" >> $OUT
echo "GeoIP yes" >> $OUT
echo "GeoIPDatabase $GEOIPDBPATH" >> $OUT
echo "GraphMonths 72" >> $OUT
echo "IndexMonths 120" >> $OUT
echo "GraphMonths 72" >> $OUT
echo "TopReferrers 20" >> $OUT
echo "TopSites 20" >> $OUT
echo "TopURLs 50" >> $OUT
echo "TopKURLs 50" >> $OUT

echo "Weblizer config wrote to $OUT"
```

### **-g file**

True if file exists and is set-group-id.

### **-h file**

True if file exists and is a symbolic link.

### **-k file**

True if file exists and its “sticky” bit is set.

### **-p file**

True if file exists and is a named pipe (FIFO).

### **-r file**

True if file exists and is readable.

**-s file**

True if file exists and has a size greater than zero.

**-t fd**

True if file descriptor fd is open and refers to a terminal.

**-u file**

True if file exists and its set-user-id bit is set.

**-w file**

True if file exists and is writable.

**-x file**

True if file exists and is executable.

**-O file**

True if file exists and is owned by the effective user id.

**-G file**

True if file exists and is owned by the effective group id.

**-L file**

True if file exists and is a symbolic link.

**-S file**

True if file exists and is a socket.

**-N file**

True if file exists and has been modified since it was last read.

→ ← String comparison	<b>Home</b>	→ Shell command line parameters →
-----------------------	-------------	--------------------------------------

# Shell command line parameters

→ ← File attributes comparisons	<b>Home</b>	→ How to use positional parameters →
---------------------------------	-------------	--------------------------------------

Most Linux command can take different actions depending on the command line arguments supplied to the command.

## What is a command line argument?

A command line argument is nothing but an argument sent to a program being called. A program can take any number of command line arguments. For example, type the following command:

```
ls grate_stories_of
```

Sample Outputs:

```
grate_stories_of: No such file or directory.
```

`ls` is the name of an actual command and shell executed this command when you type command at shell prompt. The first word on the command line is:

- `ls` - name of the command to be executed.
- Everything else on command line is taken as *arguments* to this command.

Consider the following example:

```
tail +10 /path/to/file.txt
```

- **tail** : command name.
- **+10 /path/to/file.txt** : The arguments.

## Examples

Try the following command and note down its command line arguments:

Command	Command name	Total number of arguments	Argument name(s)
<code>ls</code>	<code>ls</code>	0	N/A
<code>ls /etc/resolv.conf</code>	<code>ls</code>	1	<code>/etc/resolv.conf</code>
<code>cp /etc/resolv.conf /tmp/test.txt</code>	<code>cp</code>	2	<code>/etc/resolv.conf</code> , and <code>/tmp/test.txt</code>
<code>sort -r -n /path/to/file</code>	<code>sort</code>	3	<code>-r</code> , <code>-n</code> , and <code>/path/to/file</code>
<code>date +"%-d-%m-%Y"</code>	<code>date</code>	1	<code>+"%-d-%m-%Y"</code>

## Command line parameters different names

A Command line parameter also known as:

- Command line options
- Options
- Positional parameters
- Flag
- Switches or switch
- Command-line arguments

## Why use command line arguments

- Telling the command/utility which option to use.
- Informing the utility/command which file or group of files to process (reading/writing of files).

→ ← File attributes comparisons	<b>Home</b>	→ How to use positional parameters →
---------------------------------	-------------	--------------------------------------

# How to use positional parameters

---

→ ← Shell command line parameters	<b>Home</b>	→ Parameters Set by the Shell →
-----------------------------------	-------------	---------------------------------

All command line parameters ( positional parameters ) are available via special shell variable \$1, \$2, \$3,...,\$9.

## How Do I Access Command-Line Arguments

Create a simple shell script called cmdargs.sh:

```
#!/bin/bash
echo "The script name : $0"
echo "The value of the first argument to the script : $1"
echo "The value of the second argument to the script : $2"
echo "The value of the third argument to the script : $3"
echo "The number of arguments passed to the script : $#"
```

```
echo "The value of all command-line arguments (\$* version) : $*"
echo "The value of all command-line arguments (\$@ version) : $@"
```

Save and close the file. Run it as follows:

```
chmod +x cmdargs.sh
./cmdargs.sh bmw ford toyota
```

Sample outputs:

```
The script name : ./cmdargs.sh
The value of the first argument to the script : bmw
The value of the second argument to the script : ford
The value of the third argument to the script : toyota
The number of arguments passed to the script : 3
```

```
The value of all command-line arguments ($* version) : bmw ford toyota
The value of all command-line arguments ($@ version) : bmw ford toyota
```

Try the following examples:

```
ls /tmp
./math 10 + 2
~/scripts/addzone cyberciti.com
~/scripts/adddomain cyberciti.biz '74.86.48.99' '2607:f0d0:1002:11::4'
/etc/init.d/named reload
/usr/local/etc/rc.d/jail restart cyberciti.biz
```

Shell script name (\$0)	Total number of arguments (\$#)	Actual Command line argument (\$1,..,\$9)
ls	1	/tmp
./math	3	10, +, and 3
~/scripts/addzone	1	cyberciti.com
~/scripts/adddomain	3	cyberciti.biz, 74.86.48.99, and 2607:f0d0:1002:11::4
/etc/init.d/named reload	1	reload
/usr/local/etc/rc.d/jail	2	restart, and cyberciti.biz

→ ← Shell command line parameters **Home** → Parameters Set by the Shell →

## Parameters Set by the Shell

→ ← How to use positional parameters **Home** → Create usage messages →

Bash shell set several special parameters. For example \$? (see return values section) holds the return value of the executed command.

- All command line parameters or arguments can be accessed via \$1, \$2, \$3,..., \$9.
- **\$\*** holds all command line parameters or arguments.
- **\$#** holds the number of positional parameters.
- **\$-** holds flags supplied to the shell.
- **\$?** holds the return value set by the previously executed command.
- **\$\$** holds the process number of the shell (current shell).
- **\$\_** hold the process number of the last background command.
- **\$@** holds all command line parameters or arguments.

Use echo command to display special shell parameters:

```
echo $#
```

You can store them to a shell → variables as follows:

```
status=$?
[ $status -eq 0 ] && echo "Lighttpd ... [Ok]" || echo "Lighttpd ..."
```

```
[Failed]"
```

- Assignment to special parameter is not allowed:

```
# okay
status=$?
# noop not allowed
$?=-1
```

→ ← How to use positional parameters	<b>Home</b>	→ Create usage messages →
--------------------------------------	-------------	---------------------------

## Create usage messages

---

→ ← Parameters Set by the Shell	<b>Home</b>	→ Exit command →
---------------------------------	-------------	---------------------

You can use the `if` command to check command line arguments. Many Linux commands display an error or usage information when required command line option is not passed. For example, try the following command:

```
gcc
```

Sample outputs:

```
gcc: no input files
```

Try `rm` command:

```
rm
```

Sample outputs:

```
rm: missing operand
Try `rm --help' for more information.
```

## How Do I Add Usage Functionality To The Script?

A shell script that depends upon user input must:

- Verify the number of arguments passed to it.
- Display an error or usage message if arguments or input is not passed to the script. Your shell script can also create such usage message using `if` command and  `$#`  special shell variable parameter. Create a shell script called `userlookup.sh`:

```
#!/bin/bash
# A shell script to lookup usernames in /etc/passwd file
# Written by: Vivek Gite
# Last updated on: Sep/10/2003
# -----
# Set vars
```

```
user=$1    # first command line argument

passwd=/etc/passwd

# Verify the type of input and number of values
# Display an error message if the username (input) is not correct
# Exit the shell script with a status of 1 using exit 1 command.
[ $# -eq 0 ] && { echo "Usage: $0 username"; exit 1; }

grep "^$user" $passwd >/dev/null
retval=$?    # store exit status of grep

# If grep found username, it sets exit status to zero
# Use exit status to make the decision
[ $retval -eq 0 ] && echo "$user found" || echo "$user not found"
```

Save and close the file. Run it as follows:

```
chmod +x userlookup.sh
./userlookup.sh
```

Sample outputs:

```
Usage: ./userlookup.sh username
```

Pass the command line argument kate:

```
./userlookup.sh kate
```

Sample outputs:

```
kate not found
```

Pass the command line argument vivek:

```
./userlookup.sh vivek
```

Sample outputs:

```
vivek found
```

→ ← Parameters Set by the Shell	<b>Home</b>	→ Exit command →
---------------------------------	-------------	---------------------

# Exit command

---

→ ← Create usage messages **Home** → The case statement →

The syntax is as follows:

```
exit N
```

- The exit statement is used to exit from the shell script with a status of N.
- Use the exit statement to indicate *successful* or *unsuccessful* shell script termination.
- The value of N can be used by other commands or shell scripts to take their own action.
- If N is omitted, the exit status is that of the last command executed.
- Use the exit statement to terminate shell script upon an error.
- If N is set to 0 means normal shell exit. Create a shell script called exitcmd.sh:

```
#!/bin/bash
echo "This is a test."
# Terminate our shell script with success message
exit 0
```

Save and close the file. Run it as follows:

```
chmod +x exitcmd.sh
./exitcmd.sh
```

Sample outputs:

```
This is a test.
```

To see exit status of the script, enter (see → the exit status of a command for more information about special shell variable \$?):

```
echo $?
```

## Shell script example

- Any non zero value indicates unsuccessful shell script termination.
- Create a shell script called datatapebackup.sh:

```
#!/bin/bash
BAK=/data2
TAPE=/dev/st0
echo "Trying to backup ${BAK} directory to tape device ${TAPE} .."

# See if $BAK exists or not else die
# Set unsuccessful shell script termination with exit status # 1
[ ! -d $BAK ] && { echo "Source backup directory $BAK not found."; exit
1; }

# See if $TAPE device exists or not else die
# Set unsuccessful shell script termination with exit status # 2
```



```
[ ! -b $TAPE ] && { echo "Backup tape drive $TAPE not found or
configured."; exit 2; }

# Okay back it up
tar cvf $TAPE $BAK 2> /tmp/error.log

if [ $? -ne 0 ]
then
    # die with unsuccessful shell script termination exit status # 3
    echo "An error occurred while making a tape backup, see
/tmp/error.log file".
    exit 3
fi

# Terminate our shell script with success message i.e. backup done!
exit 0
```

Save and close the file. Run it as follows:

```
chmod +x datatapebackup.sh
./datatapebackup.sh
echo $?
```

→ ← Create usage messages	<b>Home</b>	→ The case statement →
---------------------------	-------------	------------------------

# The case statement

---

→ ← Exit command	<b>Home</b>	→ Dealing with case sensitive pattern →
---------------------	-------------	---

The case statement is good alternative to → multilevel if-then-else-fi statement. It enable you to match several values against one variable. It is easier to read and write.

## Syntax

The syntax is as follows:

```

case $variable-name in
    pattern1)
        command1
        ...
        ....
        commandN
        ;;
    pattern2)
        command1
        ...
        ....
        commandN
        ;;
    patternN)
        command1
        ...
        ....
        commandN
        ;;
    *)
esac

```

OR

```

case $variable-name in
    pattern1|pattern2|pattern3)
        command1
        ...
        ....
        commandN
        ;;
    pattern4|pattern5|pattern6)
        command1
        ...
        ....
        commandN
        ;;

```

```

        pattern7|pattern8|patternN)
            command1
            ...
            ....
            commandN
            ;;
        *)
    esac

```

- The case statement allows you to easily check pattern (conditions) and then process a command-line if that condition evaluates to true.
- In other words the \$variable-name is compared against the patterns until a match is found.
- \*) acts as default and it is executed if no match is found.
- The pattern can also act as wildcards.
- You must include ;; at the end of each commandN. The shell executes all the statements up to the two semicolons that are next to each other.
- The esac is always required to indicate end of case statement.

## Example

Create a shell script called rental.sh:

```

#!/bin/bash

# if no command line arg given
# set rental to Unknown
if [ -z $1 ]
then
    rental="*** Unknown vehicle ***"
elif [ -n $1 ]
then
    # otherwise make first arg as a rental
    rental=$1
fi

# use case statement to make decision for rental
case $rental in
    "car") echo "For $rental rental is Rs.20 per k/m.";;
    "van") echo "For $rental rental is Rs.10 per k/m.";;
    "jeep") echo "For $rental rental is Rs.5 per k/m.";;
    "bicycle") echo "For $rental rental 20 paisa per k/m.";;
    "enfield") echo "For $rental rental Rs.3 per k/m.";;
    "thunderbird") echo "For $rental rental Rs.5 per k/m.";;
    *) echo "Sorry, I can not get a $rental rental for you!";;
esac

```

Save and close the file. Run it as follows:

```

chmod +x rental.sh
./rental.sh

```

```
./rental.sh jeep
./rental.sh enfield
./rental.sh bike
```

#### Sample outputs:

```
Sorry, I can not gat a *** Unknown vehicle *** rental for you!
For jeep rental is Rs.5 per k/m.
For enfield rental Rs.3 per k/m.
Sorry, I can not gat a bike rental for you!
```

The case statement first checks \$rental against each option for a match. If it matches "car", the echo command will display rental for car. If it matches "van", the echo command will display rental for van and so on. If it matches nothing i.e. \* (default option), an appropriate warning message is printed.

### Using Multiple Patterns

```
#!/bin/bash
NOW=$(date +"%a")
case $NOW in
    Mon)
        echo "Full backup";;
    Tue|Wed|Thu|Fri)
        echo "Partial backup";;
    Sat|Sun)
        echo "No backup";;
    *) ;;
esac
```

The following shell script demonstrate the concept of command line parameters processing using the case statement (casecmdargs.sh):

```
#!/bin/bash
OPT=$1 # option
FILE=$2 # filename

# test -e and -E command line args matching
case $OPT in
    -e|-E)
        echo "Editing $2 file..."
        # make sure filename is passed else an error displayed
        [ -z $FILE ] && { echo "File name missing"; exit 1; } || vi
        $FILE
        ;;
    -c|-C)
        echo "Displaying $2 file..."
        [ -z $FILE ] && { echo "File name missing"; exit 1; } || cat
        $FILE
        ;;

```

```

-d|-D)
    echo "Today is $(date)"
    ;;
*)
    echo "Bad argument!"
    echo "Usage: $0 -ecd filename"
    echo "    -e file : Edit file."
    echo "    -c file : Display file."
    echo "    -d      : Display current date and time."
    ;;
esac

```

Run it as follows:

```

chmod +x casecmdargs.sh
./casecmdargs.sh
./casecmdargs.sh -e /tmp/file
./casecmdargs.sh -E /tmp/file
./casecmdargs.sh -e
./casecmdargs.sh -D

```

## Creating a backup script

Create a backup script called `allinonebackup.sh`:

```

#!/bin/bash
# A shell script to backup mysql, webserver and files to tape
opt=$1
case $opt in
    sql)
        echo "Running mysql backup using mysqldump tool..."
        ;;
    sync)
        echo "Running backup using rsync tool..."
        ;;
    tar)
        echo "Running tape backup using tar tool..."
        ;;
    *)
        echo "Backup shell script utility"
        echo "Usage: $0 {sql|sync|tar}"
        echo "    sql  : Run mySQL backup utility."
        echo "    sync : Run web server backup utility."
        echo "    tar  : Run tape backup utility."        ;;
esac

```

Save and close the file. Run it as follows:

```

chmod +x allinonebackup.sh
# run sql backup

```

```
./allinonebackup.sh sql
# Dump file system using tape device
./allinonebackup.sh tar
# however, the following will fail as patterns are case sensitive
# you must use command line argument tar and not TAR, Tar, TaR etc.
./allinonebackup.sh TAR
```

→ ← Exit command	<b>Home</b>	→ Dealing with case sensitive pattern →
---------------------	-------------	---

## Dealing with case sensitive pattern

→ ← The case statement	<b>Home</b>	→ Chapter 4 Challenges →
------------------------	-------------	-----------------------------

Words can differ in meaning based on differing use of uppercase and lowercase letters. Linux allow a file to have more than one name. For example, Sample.txt, SAMPLE.txt, and SAMPLE.TXT all are three different file names. The case sensitive problem also applies to → the case statement. For example, our backup script can be executed as follows:

```
./allinonebackup.sh tar
```

However, the following example will not work, as patterns are case sensitive. You must use command line argument tar and not TAR, Tar, TaR etc:

```
./allinonebackup.sh TAR
```

However, you can get around this problem using any one of the following solution.

### Solution # 1: Convert pattern to lowercase

You can convert a pattern to lowercase using the tr command and → here strings as follows:

```
echo "TeSt" | tr '[:upper:]' '[:lower:]'
var="TeSt"
tr '[:upper:]' '[:lower:]' <<<"$var"
```

You can update the script as follows:

```
#!/bin/bash
# A shell script to backup mysql, webserver and files to tape
# allinonebackup.sh version 2.0
# -----
# covert all passed arguments to lowercase using
# tr command and here strings
opt=$( tr '[:upper:]' '[:lower:]' <<<"$1" )
case $opt in
    sql)
```

```

        echo "Running mysql backup using mysqldump tool..."
        ;;
sync)
        echo "Running backup using rsync tool..."
        ;;
tar)
        echo "Running tape backup using tar tool..."
        ;;
*)
        echo "Backup shell script utility"
        echo "Usage: $0 {sql|sync|tar}"
        echo "    sql  : Run mySQL backup utility."
        echo "    sync : Run web server backup utility."
        echo "    tar  : Run tape backup utility."        ;;
esac

```

Run it as follows:

```

./allinonebackup.sh TAR
./allinonebackup.sh TaR

```

## Solution # 2: Use regex with case patterns

Case command pattern supports regular expressions, which provide a concise and flexible means for identifying words, or patterns of characters. For example, you can match tar pattern using the following syntax:

```
[Tt][Aa][Rr]
```

- The above is called a bracket expression.
- It matches a single character that is contained within the brackets.
  - For example, [tom] matches "t", "o", or "m".
  - [a-z] specifies a range which matches any lowercase letter from "a" to "z".
  - [Aa] matches "A", or "a".
  - [Tt][Aa][Rr] matches "tar", "TAR", "taR", "TaR", etc
- With regex you can avoid the external tr command.
- Here is the update version of the same script:

```

#!/bin/bash
# A shell script to backup mysql, webserver and files to tape
opt=$1

#####
# Use regex to match all command line arguments          #
# [Tt][Aa][Rr] matches "tar", "TAR", "taR", "TaR", etc #
# [Ss][Qq][Ll] matches "sql", "SQL", "S QL", "SqL", etc #
#####
case $opt in
    [Ss][Qq][Ll])
        echo "Running mysql backup using mysqldump tool..."

```

```

        ;;
    [Ss] [Yy] [Nn] [Cc])
        echo "Running backup using rsync tool..."
        ;;
    [Tt] [Aa] [Rr])
        echo "Running tape backup using tar tool..."
        ;;
*)
    echo "Backup shell script utility"
    echo "Usage: $0 {sql|sync|tar}"
    echo "    sql  : Run mySQL backup utility."
    echo "    sync : Run web server backup utility."
    echo "    tar  : Run tape backup utility."        ;;
esac

```

### Solution # 3: Turn on nocasematch

If you turn on nocasematch option, shell matches patterns in a case-insensitive fashion when performing matching while executing → case or → [[ conditional commands.

#### How do I turn on nocasematch option?

Type the following command:

```
shopt -s nocasematch
```

#### How do I turn off nocasematch option?

Type the following command:

```
shopt -u nocasematch
```

Here is an updated version of the same:

```

#!/bin/bash
# A shell script to backup mysql, webserver and files to tape
opt=$1
# Turn on a case-insensitive matching (-s set nocasematch)
shopt -s nocasematch
case $opt in
    sql)
        echo "Running mysql backup using mysqldump tool..."
        ;;
    sync)
        echo "Running backup using rsync tool..."
        ;;
    tar)
        echo "Running tape backup using tar tool..."
        ;;
*)
    echo "Backup shell script utility"

```



```

    echo "Usage: $0 {sql|sync|tar}"
    echo "    sql  : Run MySQL backup utility."
    echo "    sync : Run web server backup utility."
    echo "    tar  : Run tape backup utility."    ;;
esac

# Turn off a case-insensitive matching (-u unset nocasematch)
shopt -u nocasematch

```

## See also

- set command
- shopt command

→ ← The case statement	<b>Home</b>	→ Chapter 4 Challenges →
------------------------	-------------	-----------------------------

## Chapter 4 Challenges

---

→ ← Dealing with case sensitive pattern	<b>Home</b>	Chapter 5: Bash Loops →
---	-------------	----------------------------

- Decide whether the following sentence is true or false:
  1. The case statement provides an alternative method for performing conditional execution.
  2. \*) acts as default in the case statement.
  3. For testing conditions you can only use the case..in...esac statement.
  4. AND operator is ||
  5. OR operator is ||
  6. NOT operator is !
- Write a shell script that display one of ten unique fortune cookie message, at random each it is run.

→ ← Dealing with case sensitive pattern	<b>Home</b>	Chapter 5: Bash Loops →
---	-------------	----------------------------

---

# Chapter 5: Bash Loops

---

## The for loop statement

---

[← Chapter 5: Bash Loops](#) **Home** [→ Nested for loop statement →](#)

Bash shell can repeat particular instruction again and again, until particular condition satisfies. A group of instruction that is executed repeatedly is called a loop. Bash supports:

- The for loop
- The `while` loop

Each and every loop must:

- First, the variable used in loop condition must be initialized, then execution of the loop begins.
- A test (condition) is made at the beginning of each iteration.
- The body of loop ends with a statement that modifies the value of the test (condition) variable.
- Repeatedly execute a block of statements.

### The for loop syntax

The for loop syntax is as follows:

```
for var in item1 item2 ... itemN
do
    command1
    command2
    ....
    ...
    commandN
done
```

The for loop numerical explicit list syntax:

```
for var in list-of-values
do
    command1
    command2
    ....
    ...
    commandN
done
```

The for loop explicit file list syntax:

```
for var in file1 file2 file3 fileN
do
    command1
    command2
```

```

        ....
        ...
        commandN
done

```

The for loop variable's contents syntax:

```

for var in $fileNames
do
    command1
    command2
    ....
    ...
    commandN
done

```

The for loop command substitution syntax:

```

for var in $(Linux-command-name)
do
    command1
    command2
    ....
    ...
    commandN
done

```

The for loop explicit file list using bash array syntax:

```

# define an array
ArrayName=(~/config/*.conf)
for var in "${ArrayName[@]}"
do
    command1 on $var
    command2
    ....
    ...
    commandN
done

```

The for loop three-expression syntax ( this type of for loop share a common heritage with the C programming language ):

```

for ( ( EXP1; EXP2; EXP3 ) )
do
    command1
    command2
    command3
done

```

The above syntax is characterized by a three-parameter loop control expression; consisting of an initializer (EXP1), a loop-test or condition (EXP2), and a counting expression (EXP3).

## More about the for loop

The for loop execute a command line once for every new value assigned to a var (variable) in specified list (item1...itemN) i.e. repeat all statement between do and done till condition is not satisfied. The lists or values are normally:

1. Strings
2. Numbers
3. Command line arguments
4. File names
5. Linux command output

## Example

Create a shell script called testforloop.sh:

```
#!/bin/bash
for i in 1 2 3 4 5
do
    echo "Welcome $i times."
done
```

Save and close the file. Run it as follows:

```
chmod +x testforloop.sh
./testforloop.sh
```

The for loop first creates i variable and assigned a number to i from the list of number from 1 to 5. The shell execute echo statement for each assignment of i. This is known as iteration. This process will continue until all the items in the list were not finished. See bash for loop examples <sup>[1]</sup> page for more information.

## The For Loop Using Strings

Create a shell script called forcars.sh

```
#!/bin/bash
# A simple shell script to print list of cars
for car in bmw ford toyota nissan
do
    echo "Value of car is: $car"
done
```

Another example, create a shell script called forcnds.sh:

```
#!/bin/bash
# A simple shell script to run commands
for command in date pwd df
do
    echo
    echo "*** The output of $command command >"
    #run command
    $command
    echo
```

```
done
```

Save and close the file. Run it as follows:

```
chmod +x forcmands.sh
./forcmands.sh
```

Sample outputs:

```
*** The output of date command >
Sun Sep  6 14:32:41 IST 2009
```

```
*** The output of pwd command >
/1.5/share/data/songs
```

```
*** The output of df command >
```

Filesystem	1K-blocks	Used	Available	Use%	Mounted on
/dev/sdb2	96116904	27589760	63644592	31%	/
tmpfs	4149972	0	4149972	0%	/lib/init/rw
varrun	4149972	272	4149700	1%	/var/run
varlock	4149972	0	4149972	0%	/var/lock
udev	4149972	2808	4147164	1%	/dev
tmpfs	4149972	356	4149616	1%	/dev/shm
/dev/sdb5	286374908	274733944	11640964	96%	/share
/dev/sdc2	240402848	159452732	68738308	70%	/disk1p2
/dev/sda5	1341352436	412128756	861086932	33%	/1.5
/dev/sdd1	1442145212	26365188	1342523224	2%	/media/backup

## The For Loop Using Variable's Contents

Create a shell script called forfilenames.sh

```
#!/bin/bash
# A shell script to verify user password database
files="/etc/passwd /etc/group /etc/shadow /etc/gshadow"
for f in $files
do
    [ -f $f ] && echo "$f file found" || echo "*** Error - $f file
missing."
done
```

## The For Loop Using Command-line Arguments

Create a shell script called forcmdargs.sh:

```
#!/bin/bash
# A simple shell script to display a file on screen passed as command
line argument
[ $# -eq 0 ] && { echo "Usage: $0 file1 file2 fileN"; exit 1; }

# read all command line arguments via the for loop
for f in $*
do
echo
echo "< $f >"
[ -f $f ] && cat $f || echo "$f not file."
echo "-----"
done
```

Save and close the file. Run it as follows:

```
chmod +x forcmdargs.sh
./forcmdargs.sh /etc/resolv.conf /etc/hostname
```

Sample outputs:

```
< /etc/resolv.conf >
nameserver 127.0.0.1
nameserver 4.2.2.1
nameserver 4.2.2.2
-----
```

```
< /etc/hostname >
vivek-desktop
-----
```

## The for loop using command substitution

→ Command substitution is nothing but a shell command output stored in into a string or a variable. The command is a shell command and must be enclosed between grave accents or \$(..). The syntax is as follows:

```
$(command-name)
`command-name`
var=$(command-name)
NOW=$(date)
echo $NOW
```

Create a shell script called forcmdsub.sh:

```
#!/bin/bash
echo "Printing file names in /tmp directory:"
for f in $(ls /tmp/*)
do
```

```
    echo $f
done
```

### The for loop using ranges or counting

The for loop can be set using the numerical range. The range is specified by a beginning and ending number. The for loop executes a sequence of commands for each member in a list of items. A representative example in BASH is as follows to display multiplication table with for loop (multiplication.sh):

```
#!/bin/bash
n=$1
# make sure command line arguments are passed to the script
if [ $# -eq 0 ]
then
    echo "A shell script to print multiplication table."
    echo "Usage : $0 number"
    exit 1
fi

# Use for loop
for i in {1..10}
do
    echo "$n * $i = $(( $i * $n ))"
done
```

Save and close the file. Run it as follows:

```
chmod +x multiplication.sh
./multiplication.sh
./multiplication.sh 13
```

Sample outputs:

```
13 * 1 = 13
13 * 2 = 26
13 * 3 = 39
13 * 4 = 52
13 * 5 = 65
13 * 6 = 78
13 * 7 = 91
13 * 8 = 104
13 * 9 = 117
13 * 10 = 130
```

## Further readings

- BASH For Loop Examples <sup>[1]</sup>
- KSH For Loop Examples <sup>[2]</sup>

← Chapter 5: Bash Loops **Home** → Nested for loop statement →

## References

[1] <http://www.cyberciti.biz/faq/bash-for-loop/>

[2] <http://www.cyberciti.biz/faq/ksh-for-loop/>

# Nested for loop statement

---

→ ← for loop **Home** → While loop →

Nested for loops means loop within loop. They are useful for when you want to repeat something several times for several things. For example, create a shell script called nestedfor.sh:

```
#!/bin/bash
# A shell script to print each number five times.
for (( i = 1; i <= 5; i++ ))          ### Outer for loop ###
do

    for (( j = 1 ; j <= 5; j++ )) ### Inner for loop ###
    do
        echo -n "$i "
    done

    echo "" #### print the new line ###
done
```

Save and close the file. Run it as follows:

```
chmod +x nestedfor.sh
./nestedfor.sh
```

Sample outputs:

```
1 1 1 1 1
2 2 2 2 2
3 3 3 3 3
4 4 4 4 4
5 5 5 5 5
```

For each value of *i* the inner loop is cycled through 5 times, with the variable *j* taking values from 1 to 5. The inner for loop terminates when the value of *j* exceeds 5, and the outer loop terminates when the value of *i* exceeds 5.



## Chessboard Example

A chessboard is the type of checkerboard used in the game of chess, and consists of 64 squares - eight rows and eight columns arranged in two alternating colors. The colors are called "black" and "white". Let us write a shell script called chessboard.sh to display a chessboard on screen:

```
#!/bin/bash
for (( i = 1; i <= 8; i++ )) ### Outer for loop ###
do
  for (( j = 1 ; j <= 8; j++ )) ### Inner for loop ###
  do
    total=$(( $i + $j)) # total
    tmp=$(( $total % 2)) # modulus
    # Find out odd and even number and change the color
    # alternating colors using odd and even number logic
    if [ $tmp -eq 0 ];
    then
      echo -e -n "\033[47m "
    else
      echo -e -n "\033[40m "
    fi
  done
  echo "" ##### print the new line ###
done
```

Save and close the file. Run it as follows:

```
chmod +x chessboard.sh
./chessboard.sh
```

Sample outputs:



# The while loop statement

---

→ ← Nested for loop statement **Home** : infinite while loop →

The **while statement** is used to executes a list of commands repeatedly.

## The while loop syntax

The syntax is:

```
while [ condition ]
do
    command1
    command2
    ..
    ....
    commandN
done
```

Command1..commandN will executes while a condition is true. To read a text file line-by-line, use the following syntax:

```
while IFS= read -r line
do
    command1 on $line
    command2 on $line
    ..
    ....
    commandN
done < "/path/to/filename"
```

OR

```
while IFS= read -r field1 field2 field3 ... fieldN
do
    command1 on $field1
    command2 on $field1 and $field3
    ..
    ....
    commandN on $field1 ... $fieldN
done < "/path/to dir/file name with space"
```

IFS is used to set field separator (default is while space). The -r option to read command disables backslash escaping (e.g., \n, \t). This is failsafe while read loop for reading text files.

---

## while loop Example

Create a shell script called while.sh:

```
#!/bin/bash
# set n to 1
n=1

# continue until $n equals 5
while [ $n -le 5 ]
do
    echo "Welcome $n times."
    n=$(( n+1 ))      # increments $n
done
```

Save and close the file. Run it as follows:

```
chmod +x while.sh
./while.sh
```

Sample outputs:

```
Welcome 1 times.
Welcome 2 times.
Welcome 3 times.
Welcome 4 times.
Welcome 5 times.
```

The script initializes the variable `n` to 1, and then increments it by one. The while loop prints out the "Welcome `$n` times" until it equals 5 and exit the loop.

### Using ((expression)) Format With The While Loop

You can use `((expression))` syntax to test arithmetic evaluation (condition). If the value of the expression is non-zero, the return status is 0; otherwise the return status is 1. To replace while loop condition `while [ $n -le 5 ]` with `while (( num <= 10 ))` to improve code readability:

```
#!/bin/bash
n=1
while (( $n <= 5 ))
do
    echo "Welcome $n times."
    n=$(( n+1 ))
done
```

### Reading A Text File

You can read a text file using `read` command and while loop as follows (whilereadfile.sh):

```
#!/bin/bash
file=/etc/resolv.conf
while IFS= read -r line
do
    # echo line is stored in $line
```

```
    echo $line
done < "$file"
```

Save and close the file. Run it as follows:

```
chmod +x whilereadfile.sh
./whilereadfile.sh
```

Sample outputs:

```
nameserver 127.0.0.1
nameserver 192.168.1.254
nameserver 4.2.2.1
```

### Reading A Text File With Separate Fields

You can store above output in two separate fields as follows (whilereadfields.sh):

```
#!/bin/bash
file=/etc/resolv.conf
while IFS= read -r f1 f2
do
    echo "field # 1 : $f1 ==> field #2 : $f2"
done < "$file"
```

Run it as follows:

```
chmod +x whilereadfields.sh
./whilereadfields.sh
```

Sample outputs:

```
field # 1 : nameserver ==> field #2 : 127.0.0.1
field # 1 : nameserver ==> field #2 : 192.168.1.254
field # 1 : nameserver ==> field #2 : 4.2.2.1
```

Another useful example for reading and phrasing `/etc/passwd` <sup>[1]</sup> file using the while loop (readpasswd.sh):

```
#!/bin/bash
file=/etc/passwd
# set field delimiter to :
# read all 7 fields into 7 vars
while IFS=: read -r user enpass uid gid desc home shell
do
    # only display if UID >= 500
    [ $uid -ge 500 ] && echo "User $user ($uid) assigned \"$home\"
home directory with $shell shell."
done < "$file"
```

Save and close the file. Run it as follows:

```
chmod +x readpasswd.sh
./readpasswd.sh
```

**Sample output:**

```
User nobody (65534) assigned "/nonexistent" home directory with /bin/sh
shell.
User vivek (1000) assigned "/home/vivek" home directory with /bin/bash
shell.
User oracle (1004) assigned "/usr/lib/oracle/xe" home directory with
/bin/bash shell.
User simran (1001) assigned "/home/simran" home directory with
/bin/bash shell.
User t2 (1002) assigned "/home/t2" home directory with
/usr/local/bin/t2.bot shell.
```

**External Links**

- [Bash While Loop Example](#) <sup>[2]</sup>
- [Howto: Read One Character At A Time](#) <sup>[3]</sup>

→ ← Nested for loop statement	<b>Home</b>	: infinite while loop →
-------------------------------	-------------	-------------------------

**References**

- [1] <http://www.cyberciti.biz/faq/understanding-etcpasswd-file-format/>  
[2] <http://www.cyberciti.biz/faq/bash-while-loop/>  
[3] <http://www.cyberciti.biz/faq/linux-unix-read-one-character-atatime-while-loop/>

# Use of : to set infinite while loop

---

→ ← While loop **Home** → Until loop →

You can use `:` special command with `→` while loop to tests or set an infinite loop or an endless loop. An infinite loop occurs when the condition will never be met, due to some inherent characteristic of the loop. There are a few situations when this is desired behavior. For example, the menu driven program typically continue till user selects to exit their main menu (loop). To set an infinite while loop use:

1. **true command** - do nothing, successfully (always returns exit code 0)
2. **false command** - do nothing, unsuccessfully (always returns exit code 1)
3. **: command** - no effect; the command does nothing (always returns exit code 0)

## Syntax

Use `:` command to set an infinite loop:

```
#!/bin/bash
# Recommend syntax for setting an infinite while loop
while :
do
    echo "Do something; hit [CTRL+C] to stop!"
done
```

Use the `true` command to set an infinite loop:

```
#!/bin/bash
while true
do
    echo "Do something; hit [CTRL+C] to stop!"
done
```

Use the `false` command to set an infinite loop:

```
#!/bin/bash
while false
do
    echo "Do something; hit [CTRL+C] to stop!"
done
```

Note the first syntax is recommended as `:` is part of shell itself i.e. `:` is a shell builtin command.

## A menu driven program using while loop

The following menu driven program typically continue till user selects to exit by pressing 4 option. → The case statement is used to match values against \$choice variable and it will take appropriate action according to users choice. Create a shell script called menu.sh:

```
#!/bin/bash
# set an infinite loop
while :
do
    clear
    # display menu
    echo "Server Name - $(hostname)"
    echo "-----"
    echo "    M A I N - M E N U"
    echo "-----"
    echo "1. Display date and time."
    echo "2. Display what users are doing."
    echo "3. Display network connections."
    echo "4. Exit"
    # get input from the user
    read -p "Enter your choice [ 1 -4 ] " choice
    # make decision using case..in..esac
    case $choice in
        1)
            echo "Today is $(date)"
            read -p "Press [Enter] key to continue..."
            readEnterKey
            ;;
        2)
            w
            read -p "Press [Enter] key to continue..."
            readEnterKey
            ;;
        3)
            netstat -nat
            read -p "Press [Enter] key to continue..."
            readEnterKey
            ;;
        4)
            echo "Bye!"
            exit 0
            ;;
        *)
            echo "Error: Invalid option..."
            read -p "Press [Enter] key to continue..."
            readEnterKey
            ;;
    esac
```

**done**

Save and close the file. Run it as follows:

```
chmod +x menu.sh
./menu.sh
```

Sample outputs:

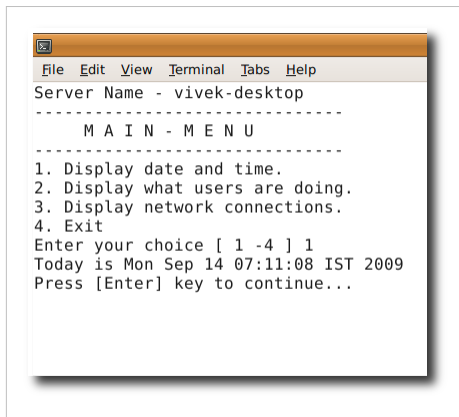

```

Server Name - vivek-desktop
-----
  M A I N - M E N U
-----
1. Display date and time.
2. Display what users are doing.
3. Display network connections.
4. Exit
Enter your choice [ 1 -4 ] 1
Today is Mon Sep 14 07:11:08 IST 2009
Press [Enter] key to continue...

```

→ ← While loop **Home** → Until loop →

## The until loop statement

← : infinite while loop **Home** → select loop →

Just like → while loop, until loop is also based on a condition.

### Syntax

The until loop continues running commands as long as the item in list continues to evaluate true. Once an item evaluates false, the loop is exited. The syntax is:

```
until [ condition ]
do
  command1
  command2
  ...
  ....
  commandN
done
```



## The while loop vs the until loop

1. The until loop executes until a nonzero status is returned.
2. The while command executes until a zero status is returned.
3. The until loop always executes at least once.

## Example

Create a shell script called until.sh:

```
#!/bin/bash
i=1
until [ $i -gt 6 ]
do
    echo "Welcome $i times."
    i=$(( i+1 ))
done
```

Save and close the file. Run it as follows:

```
chmod +x until.sh
./until.sh
```

Sample outputs:

```
Welcome 1 times.
Welcome 2 times.
Welcome 3 times.
Welcome 4 times.
Welcome 5 times.
Welcome 6 times.
```

The loop in the above example initializes the variable `i` to 1, and then increments and displays out the message until it equals 6.

← : infinite while loop	<b>Home</b>	→ select loop →
-------------------------	-------------	--------------------

# The select loop statement

→ ← Until loop **Home** → Exit select loop →

The Bash Shell also offer select Loop, the syntax is:

```
select varName in list
do
    command1
    command2
    ....
    .....
    commandN
done
```

OR (combine both select and case statement)

```
select varName in list
do
    case $varName in
        pattern1)
            command1;;
        pattern2)
            command2;;
        pattern1)
            command3;;
        *)
            echo "Error select option 1..3";;
    esac
done
```

- Select command use PS3 variable to print its prompt.
- Each word in list is printed on screen preceded by a number.
- If the line consists of the number corresponding to one of the displayed words (from the list), then varName is set to that word. You can use → if..else.fi or → case..in..esac to make a decision.
- If the line is empty, WORDS and the prompt are redisplayed.
- If EOF (end of file) is read, the command completes.
- The loop continues until a break (CTRL+C) is encountered.

## Example

Create a shell script called select.sh:

```
#!/bin/bash
# Set PS3 prompt
PS3="Enter the space shuttle to get more information : "

# set shuttle list
select shuttle in columbia endeavour challenger discovery atlantis
```

```
enterprise pathfinder
do
    echo "$shuttle selected"
done
```

Save and close the file. Run it as follows:

```
chmod +x select.sh
./select.sh
```

Sample outputs:

```
/tmp/x.sh
1) columbia      3) challenger  5) atlantis    7) pathfinder
2) endeavour    4) discovery  6) enterprise
Enter the space shuttle name to get more information : 1
columbia selected
Enter the space shuttle name to get more information :
```

## Combining the select and the case statement

Another select loop example and decision making does with `→ case..in..esac` statement (selectshuttle.sh):

```
#!/bin/bash
# Set PS3 prompt
PS3="Enter the space shuttle to get quick information : "

# set shuttle list
select shuttle in columbia endeavour challenger discovery atlantis
enterprise pathfinder
do
    case $shuttle in
        columbia)
            echo "-----"
            echo "Space Shuttle Columbia was the first
spaceworthy space shuttle in NASA's orbital fleet."
            echo "-----"
            ;;
        endeavour)
            echo "-----"
            echo "Space Shuttle Endeavour is one of three
currently operational orbiters in the Space Shuttle."
            echo "-----"
            ;;
        challenger)
            echo "-----"
            echo "Space Shuttle Challenger was NASA's second Space
Shuttle orbiter to be put into service."
            echo "-----"
            ;;
        discovery)
```

```
        echo "-----"
        echo "Discovery became the third operational orbiter,
and is now the oldest one in service."
        echo "-----"

        ;;
    atlantis)
        echo "-----"
        echo "Atlantis was the fourth operational shuttle
built."
        echo "-----"

        ;;
    enterprise)
        echo "-----"
        echo "Space Shuttle Enterprise was the first Space
Shuttle orbiter."
        echo "-----"

        ;;
    pathfinder)
        echo "-----"
        echo "Space Shuttle Orbiter Pathfinder is a Space
Shuttle simulator made of steel and wood."
        echo "-----"

        ;;
    *)
        echo "Error: Please try again (select 1..7)!"
        ;;
done
esac
```

Save and close the file. Run it as follows:

```
chmod +x selectshuttle.sh
./selectshuttle.sh
```

Sample outputs:

```

1) columbia    3) challenger  5) atlantis    7) pathfinder
2) endeavour   4) discovery   6) enterprise
Enter the space shuttle to get quick information : 1
-----
Space Shuttle Columbia was the first spaceworthy space shuttle in NASA's orbital fleet.
-----
Enter the space shuttle to get quick information : 6
-----
Space Shuttle Enterprise was the first Space Shuttle orbiter.
-----
Enter the space shuttle to get quick information : 9
Error: Please try again (select 1..7)!
Enter the space shuttle to get quick information : ^C

```

selectshuttle.sh output

→ ← Until loop	<b>Home</b>	→ Exit select loop →
----------------	-------------	----------------------

## Exit the select loop statement

→ ← select loop	<b>Home</b>	→ Break statement →
--------------------	-------------	---------------------

You can exiting the → select loop statement either pressing Ctrl+C or by adding the exit option as follows:

```

#!/bin/bash
# Set PS3 prompt
PS3="Enter the space shuttle to get quick information : "

# set shuttle list
# exit option
select shuttle in columbia endeavour challenger discovery atlantis
enterprise pathfinder exit
do
    case $shuttle in
        columbia)
            echo "-----"
            echo "Space Shuttle Columbia was the first
spaceworthy space shuttle in NASA's orbital fleet."
            echo "-----"
            ;;
        endeavour)
            echo "-----"
            echo "Space Shuttle Endeavour is one of three
currently operational orbiters in the Space Shuttle."
            echo "-----"
            ;;
        challenger)
            echo "-----"

```

```

        echo "Space Shuttle Challenger was NASA's second Space
Shuttle orbiter to be put into service."
        echo "-----"
        ;;
    discovery)
        echo "-----"
        echo "Discovery became the third operational orbiter,
and is now the oldest one in service."
        echo "-----"

        ;;
    atlantis)
        echo "-----"
        echo "Atlantis was the fourth operational shuttle
built."

        echo "-----"

        ;;
    enterprise)
        echo "-----"
        echo "Space Shuttle Enterprise was the first Space
Shuttle orbiter."
        echo "-----"

        ;;
    pathfinder)
        echo "-----"
        echo "Space Shuttle Orbiter Pathfinder is a Space
Shuttle simulator made of steel and wood."
        echo "-----"

        ;;
    exit)
        echo "Bye!"
        break
        ;;
    *)
        echo "Error: Please try again (select 1..8)!"
        ;;
esac
done

```

Sample output:

```

1) columbia      3) challenger  5) atlantis    7) pathfinder
2) endeavour     4) discovery   6) enterprise  8) exit
Enter the space shuttle to get quick information : 5
-----

```

```
Atlantis was the fourth operational shuttle built.
```

```
-----
```

```
Enter the space shuttle to get quick information : 8
```

```
Bye!
```

→ ← select loop	<b>Home</b>	→ Break statement →
--------------------	-------------	---------------------

## Using the break statement

→ ← Exit select loop	<b>Home</b>	→ Continue statement →
----------------------	-------------	------------------------

Use the break statement to exit from within a → FOR, → WHILE or → UNTIL loop i.e. stop loop execution.

### Syntax

```
break
```

OR

```
break N
```

### Example: for loop break statement

Create a shell script called forbreak.sh:

```
#!/bin/bash
match=$1 # fileName
found=0 # set to 1 if file found in the for loop

# show usage
[ $# -eq 0 ] && { echo "Usage: $0 fileName"; exit 1; }

# Try to find file in /etc
for f in /etc/*
do

    if [ $f == "$match" ]
    then
        echo "$match file found!"
        found=1 # file found
        break # break the for loop
    fi
done

# noop file not found
[ $found -ne 1 ] && echo "$match file not found in /etc directory"
```

Save and close the file. Run it as follows:

```
chmod +x forbreak.sh
./forbreak.sh /etc/resolv1.conf
./forbreak.sh /etc/resolv.conf
```

Sample outputs:

```
/etc/resolv1.conf file not found in /etc directory
/etc/resolv.conf file found!
```

## Example: while loop break statement

Create a shell script called whilebreak.sh:

```
#!/bin/bash
# set an infinite while loop
while :
do
    read -p "Enter number ( -9999 to exit ) : " n

    # break while loop if input is -9999
    [ $n -eq -9999 ] && { echo "Bye!"; break; }

    isEvenNo=$(( $n % 2 )) # get modules
    [ $isEvenNo -eq 0 ] && echo "$n is an even number." || echo "$n
is an odd number."
done
```

Save and close the file. Run it as follows:

```
chmod +x whilebreak.sh
./whilebreak.sh
```

Sample outputs:

```
Enter number ( -9999 to exit ) : 11
11 is an odd number.
Enter number ( -9999 to exit ) : -2
-2 is an even number.
Enter number ( -9999 to exit ) : 20
20 is an even number.
Enter number ( -9999 to exit ) : -9999
Bye!
```



## How To Break Out Of a Nested Loop

A nested loop means loop within loop. You can break out of a certain number of levels in a nested loop by adding break n statement. n is the number of levels of nesting. For example, following code will break out the second done statement:

```
...
for i in something
do
  while true
  do
    cmd1
    cmd2
    [ condition ] && break 2
  done
done
....
..
```

The above break 2 will breaks you out of two enclosing for and while loop.

→ ← Exit select loop	<b>Home</b>	→ Continue statement →
----------------------	-------------	---------------------------

## Using the continue statement

→ ← Break statement	<b>Home</b>	→ Command substitution →
---------------------	-------------	--------------------------

The continue statement is used to resume the next iteration of the enclosing → FOR, → WHILE or → UNTIL loop.

### Syntax

```
continue
```

OR

```
continue n
```

OR

```
...
..
for i in something
do
  [ condition ] && continue
  cmd1
  cmd2
done
```

```
..
...
```

OR

```
...
..
while true
do
    [ condition1 ] && continue
    cmd1
    cmd2
    [ condition2 ] && break
done
..
...
```

The following two examples assumes that familiarity with MySQL and BIND 9 named servers.

### Example: MySQL Backup Shell Script

- Use the continue statement to return to the top of the loop by skipping the rest of the commands in in the loop.

```
#!/bin/bash
# A sample mysql backup script
# Must be run as the root user
# Written by Vivek Gite
# Last updated on : 23/Aug/2003
# -----
# MySQL Login Info
MUSER="admin"                # MySQL user
MHOST="192.168.1.100"        # MySQL server ip
MPASS="MySQLServerPassword" # MySQL password

# format dd-mm-yyyy
NOW=$(date +"%d-%m-%Y")

# Backupfile path
BPATH=/backup/mysql/$NOW

# if backup path does not exists, create it
[ ! -d $BPATH ] && mkdir -p $BPATH

# get database name lists
DBS="$(/usr/bin/mysql -u $MUSER -h $MHOST -p$MPASS -Bse 'show
databases')"
```

```
for db in $DBS
do
    # Backup file name
```

```

FILE="{BPATH}/${db}.gz"

# skip database backup if database name is adserverstats or mint
[ "$db" == "adserverstats" ] && continue
[ "$db" == "mint" ] && continue

# okay lets dump a database backup
/usr/bin/mysqldump -u $MUSER -h $MHOST -p$MPASS $db | /bin/gzip -9 >
$FILE
done

```

### Example: Bind9 named.conf Example

```

#!/bin/bash
# convert all domain names to a lowercase
DOMAINS="$(echo $@|tr ' [A-Z]' ' [a-z] ')"

# Path to named.conf
NAMEDCONF="/var/named/chroot/etc/named.conf"

# Check named.conf for error
NAMEDCHEKCONF="/usr/sbin/named-checkconf -t /var/named/chroot/"

# Display usage and die
if [ $# -eq 0 ]
then
    echo "Usage: $0 domain1 domain2 ..."
    exit 1
fi

# okay use for loop to process all domain names passed
# as a command line args
for d in $DOMAINS
do
    # if domain already exists, skip the rest of the loop
    grep $d $NAMEDCONF >/dev/null
    if [ $? -eq 0 ]
    then
        echo "$d exists in in $NAMEDCONF, skipping ..."
        continue # skip it
    fi

    # else add domain to named.conf
    echo "Adding domain $d to $NAMEDCONF..."

    echo "zone \"${d}\" {" >> $NAMEDCONF
    echo "    type master;" >> $NAMEDCONF

```

```

echo "          file \"/etc/named/master.${d}\";" >> $NAMEDCONF
echo "          allow-transfer { slaveservers; };;" >> $NAMEDCONF
echo "};;" >> $NAMEDCONF

# Run named configuration file syntax checking tool
$NAMEDCHECKCONF >/dev/null
if [ $? -ne 0 ] # error found?
then
    echo "**** Warning: named-checkconf - Cannot reload named
due to errors for $d ****"
else
    echo "**** Domain $d sucessfully added to $NAMEDCONF
****"
fi
done

```

→ ← Break statement	<b>Home</b>	→ Command substitution →
---------------------	-------------	--------------------------

## Command substitution

→ ← Continue statement	<b>Home</b>	→ Chapter 5 Challenges →
------------------------	-------------	--------------------------

Command substitution is nothing but run a shell command and store its output to a variable or display back using echo command. For example, display date and time:

```
echo "Today is $(date) "
```

OR

```
echo "Computer name is $(hostname) "
```

### Syntax

You can use the grave accent ( ` ) to perform a command substitution. The syntax is:

```
`command-name`
```

OR

```
$(command-name)
```

### Command substitution in an echo command

```
echo "Text $(command-name) "
```

OR

```
echo -e "List of logged on users and what they are doing:\n $(w) "
```

**Sample outputs:**

List of logged on users and what they are doing:

```
09:49:06 up 4:09, 3 users, load average: 0.34, 0.33, 0.28
USER      TTY      FROM          LOGIN@      IDLE        JCPU        PCPU WHAT
vivek    tty7      :0            05:40      ?          9:06m      0.09s
/usr/bin/gnome-
vivek    pts/0     :0.0         07:02      0.00s      2:07m      0.13s bash
vivek    pts/2     :0.0         09:03      20:46m     0.04s      0.00s
/bin/bash ./ssl
```

**Command substitution and shell variables**

You can store command output to a shell variable using the following syntax:

```
var=$(command-name)
```

Store current date and time to a variable called NOW:

```
NOW=$(date)
echo "$NOW"
```

Store system's host name to a variable called SERVERNAME:

```
SERVERNAME=$(hostname)
echo "Running command @ $SERVERNAME...."
```

Store current working directory name to a variable called CWD:

```
CWD=$(pwd)
cd /path/some/where/else
echo "Current dir $(pwd) and now going back to old dir .."
cd $CWD
```

**Command substitution and shell loops**

Shell loop can use command substitution to get input:

```
for f in $(ls /etc/*.conf)
do
    echo "$f"
done
```

→ ← Continue statement	<b>Home</b>	→ Chapter 5 Challenges →
------------------------	-------------	--------------------------

# Chapter 5 Challenges

---

→ ← Command substitution   **Home**   Chapter 6: Shell Redirection →

- Decide whether the following sentence is true or false:
  1. For repeated actions use if-then-else.
  2. For choice making use bash shell loop.
  3. To executes for each value in a list use while loop.
  4. Use break statement to return to the top of the loop.
  5. Use continue statement to return to the top of the loop.
  6. The PS3 reserved variable is used by select statement.
  7. The default value for PS3 is set to #?.
- Write a menu driven script using the select statement to print calories for food items such as pizza, burger, Salad, Pasta etc.
- Write a shell script that, given a file name as the argument will count vowels, blank spaces, characters, number of line and symbols.
- Write a shell script that, given a file name as the argument will count English language articles such As 'A', 'An' and 'The'.
- Write a shell script that, given a file name as the argument will write the even numbered line to a file with name evenfile and odd numbered lines in a text file called oddfile.
- Write a shell script to monitor Linux server disk space using a while loop. Send an email alert when percentage of used disk space is  $\geq 90\%$ .
- Write a shell script to determine if an input number is a palindrome or not. A palindromic number is a number where the digits, with decimal representation usually assumed, are the same read backwards, for example, 58285.
- Write a shell program to read a number \*such as 123) and find the sum of digits (1+2+3=6).
- Write a shell program to read a number and display reverse the number. For example, 123 should be printed as as 321.
- Write the shell program which produces a report from the output of `ls -l` in the following format using the for loop statement:

```
file1
file2
[DIR] test/
Total regular files : 7
Total directories : 4
Total symbolic links : 0
Total size of regular files : 2940
```

- Write a shell script that will count the number of files in each of your sub-directories using the for loop.
- Write a shell script that accepts two directory names as arguments and deletes those files in the first directory which are similarly named in the second directory.
- Write a shell script to search for no password entries in `/etc/passwd` and lock all accounts.
- Write a shell program to read two numbers and display all the odd numbers between those two numbers.

→ ← Command substitution   **Home**   Chapter 6: Shell Redirection →

---

---

# Chapter 6: Shell Redirection

---

## Input and Output

---

← Chapter 6: Shell Redirection	<b>Home</b>	→ Standard input →
-----------------------------------	-------------	-----------------------

Almost all commands produces the output to screen or take input from the keyboard, but in Linux it is possible to send output to a file or to read input from a file. Each shell command has its own input and outputs. Before a command is executed, its input and output may be redirected using a special notation interpreted by the shell. For example, sending output of date command to a file instead of to the screen. Changing the default path of input or output is called redirection.

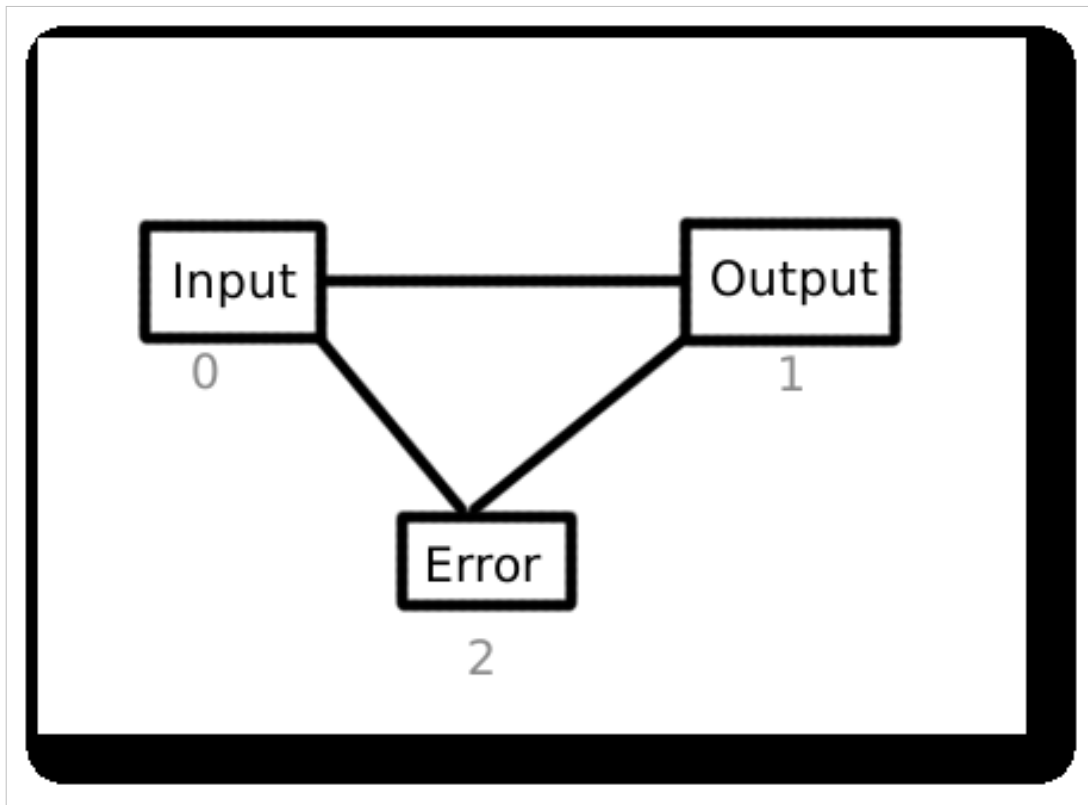

- In Linux everything is a file.
- Your hardware is also a file:
  - 0 - Input - Keyboard (stdin)
  - 1 - Output - Screen (stdout)
  - 2 - Error - Screen (stderr)
- The above three numbers are standard POSIX numbers and also known as file descriptors (FD). Every Linux command at least open the above streams to talk with users or other system programs.

Integer value

---

Standard File	File Descriptor Number	Meaning	Example (type at shell prompt)
stdin	0	Read input from a file (the default is keyboard)	cat < filename
stdout	1	Send data to a file (the default is screen).	date > output.txt cat output.txt
stderr	2	Send all error messages to a file (the default is screen).	rm /tmp/4815162342.txt 2>error.txt cat error.txt

You can manipulate the final result by redirecting input and output.

← Chapter 6: Shell Redirection	<b>Home</b>	→ Standard input →
--------------------------------	-------------	-----------------------

## Standard input

→ ← Input and Output	<b>Home</b>	→ Standard output →
----------------------	-------------	------------------------

- Standard input is the default input method, which is used by all commands to read its input.
- It is denoted by zero number (0).
- Also known as stdin.
- The default standard input is the keyboard.
- < is input redirection symbol and syntax is:

```
command < filename
```

- For example, you can run cat command as follows to display /etc/passwd on screen:

```
cat < /etc/passwd
```



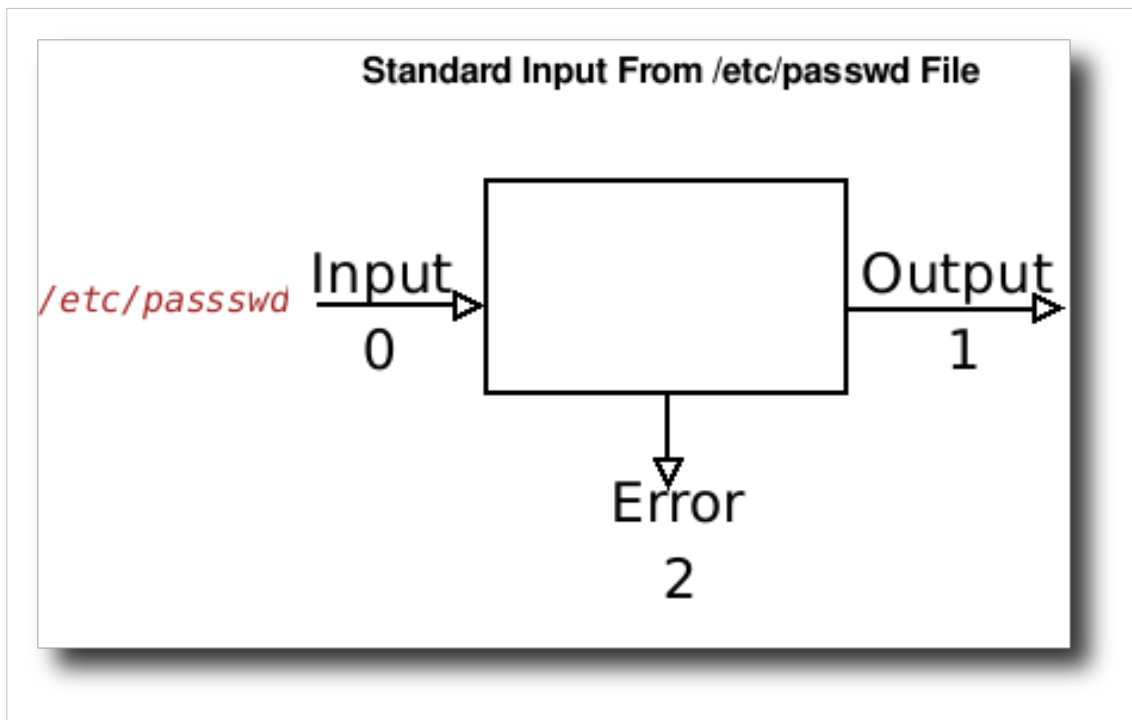

- To sort `/etc/resolv.conf` file, enter:

```
sort < /etc/resolv.conf
```

→ ← Input and Output	<b>Home</b>	→ Standard output →
-------------------------	-------------	------------------------

# Standard output

→ ← Standard input	<b>Home</b>	→ Standard error →
-----------------------	-------------	-----------------------

- Standard output is used by a command to writes (display) its output.
- The default is the screen.
- It is denoted by one number (1).
- Also known as stdout.
- The default standard output is the screen.
- > is output redirection symbol and syntax is:

```
command > output.file.name
```

For example, ls command by default writes its output to the screen:

```
ls
```

But, you can save the output to a file called output.txt, enter:

```
ls > /tmp/output.txt
```

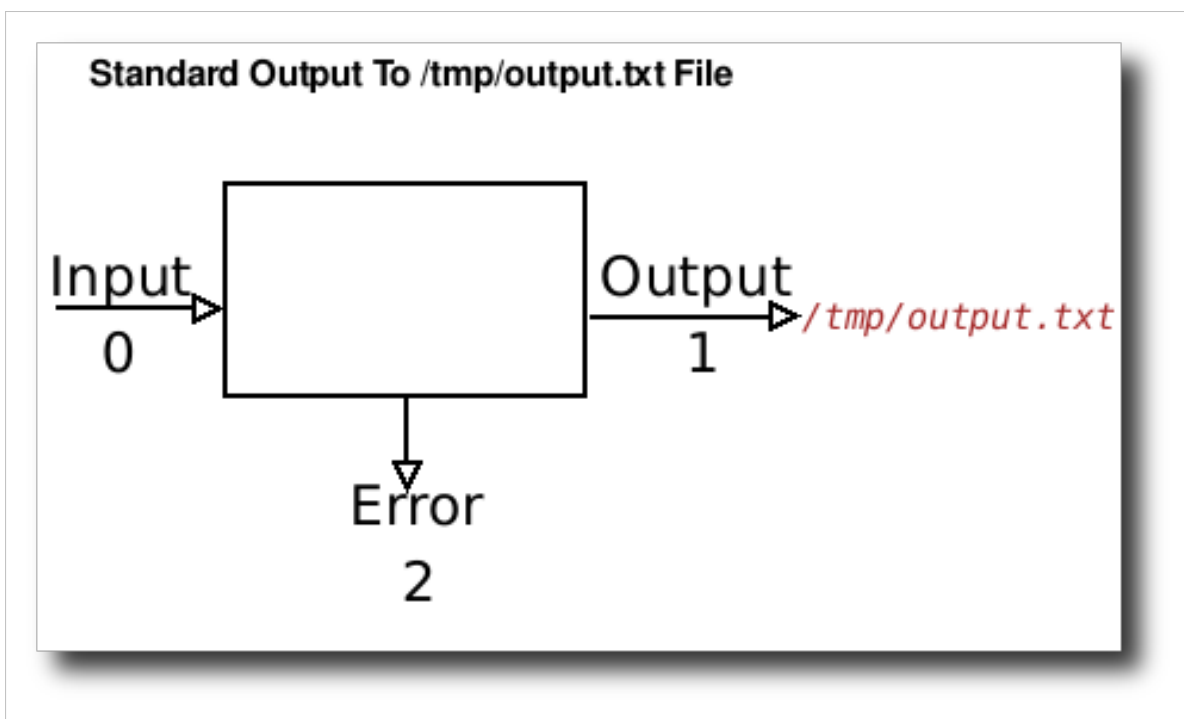

To view file, enter:

```
cat /tmp/output.txt
```

- Please note that /tmp/output.txt file is created if it doesn't exist. And if file /tmp/output.txt file is overwritten if it exists.
- You can also save your script output to the file:

```
./your.script.name.sh > myoutput
cat myoutput
```

→ ← Standard input	<b>Home</b>	→ Standard error →
-----------------------	-------------	-----------------------

## Standard error

→ ← Standard output	<b>Home</b>	→ Empty file creation →
------------------------	-------------	-------------------------

- Standard error is the default error output device, which is used to write all system error messages.
- It is denoted by two number (2).
- Also known as stderr.
- The default standard input is the screen or monitor.
- 2> is input redirection symbol and syntax is:

```
command 2> errors.txt
```

For example, send find command errors to a file called fileerrors.txt, sothat you can review errors later on, enter:

```
find / -iname "*.conf" 2>fileerrors.txt
cat fileerrors.txt
```

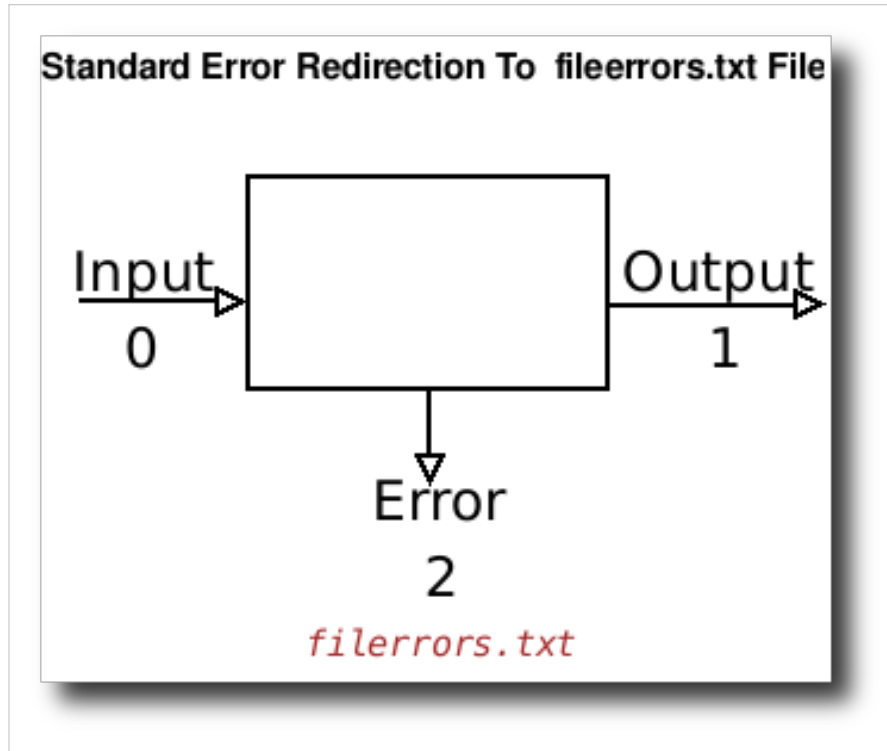

→ ← Standard output	<b>Home</b>	→ Empty file creation →
------------------------	-------------	-------------------------

# Empty file creation

---

→ ← Standard error	<b>Home</b>	/dev/null discards unwanted output →
--------------------	-------------	--------------------------------------

- To create empty file use the following syntax:

```
>newfile.name
```

- > operator redirects output to a file. If no command given and if file doesn't exist it will create empty file. For example, create a shell script called tarbackup.sh:

```
#!/bin/bash
TAR=/bin/tar

# SCSI tape device
TAPE=/dev/st0

# Backup dir names
BDIRS="/www /home /etc /usr/local/mailboxes /phpjail /pythonjail
/perlcgibin"

# Logfile name
ERRLOG=/tmp/tar.logfile.txt

# Remove old log file and create the empty log file
>$ERRLOG

# Okay lets make a backup
$TAR -cvf $TAPE $BDIRS 2>$ERRLOG
```

Notice you can also use touch command for empty file creation:

```
touch /tmp/newtextfile
```

Save and close the file. Run it as follows:

```
chmod +x tarbackup.sh
./tarbackup.sh
```

→ ← Standard error	<b>Home</b>	/dev/null discards unwanted output →
--------------------	-------------	--------------------------------------

# /dev/null discards unwanted output

→ ← Empty file creation **Home** → here documents →

All data written on a `/dev/null` or `/dev/zero` special file is discarded by the system. Use `/dev/null` to send any unwanted output from program/command and syntax is:

```
command >/dev/null
```

This syntax redirects the command standard output messages to `/dev/null` where it is ignored by the shell. OR

```
command 2>/dev/null
```

This syntax redirects the command error output messages to `/dev/null` where it is ignored by the shell. OR

```
command &>/dev/null
```

This syntax redirects both standard output and error output messages to `/dev/null` where it is ignored by the shell.

## Example

Try searching user vivek in `/etc/passwd` file:

```
grep vivek /etc/passwd && echo "Vivek found" || "Vivek not found"
```

Sample outputs:

```
vivek:x:1000:1000:Vivek Gite,,,,:/home/vivek:/bin/bash
Vivek found
```

To ignore actual output and just display the message, modify your command as follows:

```
grep vivek /etc/passwd >/dev/null && echo "Vivek found" || "Vivek not found"
```

Sample outputs:

```
Vivek found
```

Consider the following example from → the exit status chapter. The output of `grep "^$username" $PASSWD_FILE > /dev/null` is sent to `/dev/null` where it is ignored by the shell.

```
#!/bin/bash
# set var
PASSWD_FILE=/etc/passwd

# get user name
read -p "Enter a user name : " username

# try to locate username in in /etc/passwd
#
grep "^$username" $PASSWD_FILE > /dev/null

# store exit status of grep
```

```
# if found grep will return 0 exit stauts
# if not found, grep will return a nonzero exit stauts
status=$?

if test $status -eq 0
then
    echo "User '$username' found in $PASSWORD_FILE file."
else
    echo "User '$username' not found in $PASSWORD_FILE file."
fi
```

→ ← Empty file creation	<b>Home</b>	→ here documents →
-------------------------	-------------	--------------------

## Here documents

---

← /dev/null discards unwanted output	<b>Home</b>	→ here strings →
--------------------------------------	-------------	---------------------

To create a here document use the following syntax:

```
command <<HERE
text1
text2
testN
$varName
HERE
```

This type of redirection tells the shell to read input from the current source (HERE) until a line containing only word (HERE) is seen. HERE word is not subjected to variable name, parameter expansion, arithmetic expansion, pathname expansion, or → command substitution. All of the lines read up to that point are then used as the standard input for a command. Files are processed in this manner are commonly called here documents.

### Example

Use here document feature to give constant text to a command. For example the following command will count the words for input:

```
echo 'This is a test.' | wc -w
```

Sample outputs:

```
4
```

But, how do you count lots of lines at a time? Use here document as follows:

```
wc -w <<EOF
> This is a test.
> Apple juice.
> 100% fruit juice and no added sugar, colour or preservative.
> EOF
```

Sample outputs:

```
16
```

The <<, reads the shell input typed after the wc command at the PS2 prompts, >) up to a line which is identical to word EOF.

## HERE document and mail command

For example, write an email using the mail command. Create a shell script called tapebackup1.sh:

```
#!/bin/bash
# run tar command and dump data to tape
tar -cvf /dev/st0 /www /home 2>/dev/null

# Okay find out if tar was a success or a failure
[ $? -eq 0 ] && status="Success!" || status="Failed!!!"

# write an email to admin
mail -s 'Backup status' vivek@nixcraft.co.in<<END_OF_EMAIL

The backup job finished.

End date: $(date)
Hostname : $(hostname)
Status : $status

END_OF_EMAIL
```

Save and close the file. Run it as follows:

```
chmod +x tapebackup1.sh
./tapebackup1.sh
```

Sample outputs:

```
Subject: Test
From: root <root@www-03.nixcraft.net.in>
Date: 12:57 Am
To: vivek@nixcraft.co.in

The backup job finished.

End date: Thu Sep 17 14:27:35 CDT 2009
Hostname : txvipl.simplyguide.org
Status : Success
```

The script provides the constant multi-line text input to the mail command.

← /dev/null discards unwanted output	<b>Home</b>	→ here strings
		→

# Here strings

---

→ ← here documents **Home** → Redirection of standard error →

Here strings is just like → here documents and syntax is:

```
command <<<$word
```

OR

```
command arg1 <<<"$word"
```

The \$word (a shell → variable) is expanded and supplied to the command on its → standard input. The following wc command will count words from given argument:

```
wc -w <<< "This is a test."
```

Sample outputs:

```
4
```

## grepping into a shell variable

Usually, you can not grep into a \$var. For example, try to grep word "nor" using \$var:

```
var="Neither in this world nor elsewhere is there any happiness in  
store for him who always doubts."  
grep "nor" $var
```

Sample outputs:

```
grep: Neither: No such file or directory  
grep: in: No such file or directory  
grep: this: No such file or directory  
grep: world: No such file or directory  
grep: nor: No such file or directory  
grep: elsewhere: No such file or directory  
grep: is: No such file or directory
```

However, with here string you can grep into \$var, enter:

```
grep "nor" <<<$var >/dev/null && echo "Found" || echo "Not found"
```

Sample output:

```
Found
```

Notice you can use shell → pipes to grep into \$var:

```
echo $var | grep "nor" -q && echo "Found" || echo "Not found"
```

However, here strings looks more logical and easy to read.

---



## Counting network interfaces

The following command counts the total active network interfaces:

```
wc -w <<<$(netstat -i | cut -d" " -f1 | egrep -v "^Kernel|Iface|lo")
```

Sample outputs:

```
3
```

→ ← here documents	<b>Home</b>	→ Redirection of standard error →
--------------------	-------------	-----------------------------------

## Redirection of standard error

---

→ ← here strings	<b>Home</b>	→ Redirection of standard output →
------------------	-------------	------------------------------------

To redirect standard error into file called error.log, enter:

```
command-name 2>error.log
```

Find all .profile files in /home directory and log errors to /tmp/error file, enter:

```
find /home -name .profile 2>/tmp/error
```

Sample output:

```
/home/t2/.profile
/home/vivek/ttt/skel/.profile
```

To view errors, enter:

```
more /tmp/error
```

Sample outputs:

```
find: `/home/vivek/.cpan/build/Acme-POE-Tree-1.01-qmq77': Permission
denied
find: `/home/vivek/.cpan/build/Lchown-1.00-uOM4tb': Permission denied
find: `/home/vivek/.cpan/build/IO-Tty-1.07-F9rDy3': Permission denied
find: `/home/vivek/.cpan/build/POE-Test-Loops-1.002-9AjIro': Permission
denied
find: `/home/vivek/.cpan/build/POE-1.003-KwXVB1': Permission denied
find: `/home/vivek/.cpan/build/Curses-1.27-ZLo169': Permission denied
```

## Redirect Script Errors

You can redirect script error to a log file called scripts.err:

```
./script.sh 2>scripts.err  
/path/to/example.pl 2>scripts.err
```

## Append To Error Log

You can append standard error to end of error.log file using >> operator:

```
command-name 2>>error.log  
./script.sh 2>>error.log  
/path/to/example.pl 2>>error.log
```

## External links

- [BASH Shell: How To Redirect stderr To stdout \( redirect stderr to a File \)](#) <sup>[1]</sup>
- [BASH Shell Redirect Output and Errors To /dev/null](#) <sup>[2]</sup>
- [How do I save or redirect stdout and stderr into different files?](#) <sup>[3]</sup>

→ ← here strings	<b>Home</b>	→ Redirection of standard output →
---------------------	-------------	------------------------------------

## References

- [1] <http://www.cyberciti.biz/faq/redirecting-stderr-to-stdout/>  
[2] <http://www.cyberciti.biz/faq/how-to-redirect-output-and-errors-to-devnull/>  
[3] <http://www.cyberciti.biz/faq/saving-stdout-stderr-into-separate-files/>

# Redirection of standard output

---

→ ← Redirection of standard error	<b>Home</b>	→ Appending redirected output →
-----------------------------------	-------------	---------------------------------

To redirect output simple use the following syntax:

```
command > /path/to/file
/path/to/script.sh > output.txt
```

For example, send output of date command to a file called now.txt:

```
date > now.txt
```

You can also use the > operator to print file, enter:

```
cat file.txt > /dev/lp0
```

OR

```
sudo bash -c "cat file.txt > /dev/lp0"
```

To make a usage listing of the directories in the /home partition, enter:

```
sudo bash -c "cd /home ; du -s * | sort -rn >/tmp/usage"
```

You can also use the following syntax:

```
echo "Today is $(date)" 1>/tmp/now.txt
```

## External links

- [BASH Shell: How To Redirect stderr To stdout \( redirect stderr to a File \)](#) <sup>[1]</sup>
- [BASH Shell Redirect Output and Errors To /dev/null](#) <sup>[2]</sup>
- [How do I save or redirect stdout and stderr into different files?](#) <sup>[3]</sup>

→ ← Redirection of standard error	<b>Home</b>	→ Appending redirected output →
-----------------------------------	-------------	---------------------------------

---

# Appending redirected output

→ ← Redirection of standard output	<b>Home</b>	→ Redirection of both standard error and output →
------------------------------------	-------------	--

You can append the output to the same file using >> operator, enter:

```
date >> now.txt
cat now.txt
```

You can also use the following syntax:

```
echo "Today is $(date)" 1>>/tmp/now.txt
```

## External links

- [BASH Shell: How To Redirect stderr To stdout \( redirect stderr to a File \)](#) <sup>[1]</sup>
- [BASH Shell Redirect Output and Errors To /dev/null](#) <sup>[2]</sup>
- [How do I save or redirect stdout and stderr into different files?](#) <sup>[3]</sup>

→ ← Redirection of standard output	<b>Home</b>	→ Redirection of both standard error and output →
------------------------------------	-------------	--

# Redirection of both standard error and output

→ ← Appending redirected output	<b>Home</b>	→ Writing output to files →
---------------------------------	-------------	-----------------------------

You can redirect both stdout and stderr to file using the following syntax:

```
command-name &>filename
command-name >cmd.log 2>&1
command-name >/dev/null 2>&1
```

This syntax is often used with cron jobs:

```
@hourly /scripts/backup/nas.backup >/dev/null 2>&1
```

OR

```
@hourly /scripts/backup/nas.backup &>/dev/null
```

## External links

- BASH Shell: How To Redirect stderr To stdout ( redirect stderr to a File ) <sup>[1]</sup>
- BASH Shell Redirect Output and Errors To /dev/null <sup>[2]</sup>
- How do I save or redirect stdout and stderr into different files? <sup>[3]</sup>

→ ← Appending redirected output	<b>Home</b>	→ Writing output to files →
---------------------------------	-------------	-----------------------------

## Writing output to files

→ ← Redirection of both standard error and output	<b>Home</b>	→ Assigns the file descriptor (fd) to file for output →
---	-------------	---

You need to use the redirection symbol, `>`, to send data to a file. For example, my script called `./payment.py` generate output as follows on screen:

```
./payment.py -a -t net
```

Sample outputs:

```
+--+-----+-----+-----+
|#|      Month |      NetRev      | Paid Details|
+--+-----+-----+-----+
|1|    Feb-09 |      747.56 | 06-Apr-2009 |
|2|    Mar-09 |      373.14 | 20-Apr-2009 |
|3|    Apr-09 |      163.66 | 19-May-2009 |
|4|    May-09 |      158.18 | 19-Jun-2009 |
|5|    Jun-09 |     3768.96 | 17-Jul-2009 |
|6|    Jul-09 |     2150.06 | 21-Aug-2009 |
+--+-----+-----+-----+
```

Use the `>` redirection symbol, to send data to a file called `netrevenue.txt`, enter:

```
./payment.py -a -t net >netrevenue.txt
```

## Append Output To Files

Use the `>>` redirection symbols, to append to a file called `netrevenue.txt`, enter:

```
./payment.py -a -t net >>netrevenue.txt
```

## Avoid Overwriting To Files

To disallow existing regular files to be overwritten with the `>` operator set `noclobber` option as follows:

```
echo "Test" > /tmp/test.txt
set -C
echo "Test 123" > /tmp/test.txt
```

Sample outputs:

```
bash: /tmp/test.txt: cannot overwrite existing file
```

To enable existing regular files to be overwritten with the > operator set noclobber option as follows:

```
cat /tmp/test.txt
set +C
echo "Test 123" > /tmp/test.txt
cat /tmp/test.txt
```

## Reading and Writing From Files

Create a text file called fnames.txt:

```
vivek
tom
Jerry
Ashish
Babu
```

Now, run tr command as follows to convert all lowercase names to the uppercase, enter:

```
tr "[a-z]" "[A-Z]" < fnames.txt
```

Sample outputs:

```
VIVEK
TOM
JERRY
ASHISH
BABU
```

You can save the output to a file called output.txt, enter:

```
tr "[a-z]" "[A-Z]" < fnames.txt > output.txt
cat output.txt
```

Notice do not use the same file name for standard input and standard output. This will result into data loss and results are unpredictable.

To sort names stored in output.txt, enter:

```
sort < output.txt
```

Finally, store all sorted named to a file called sorted.txt

```
sort < output.txt > sorted.txt
```

However,

```
sort > sorted1.txt < output.txt
```

→ ← Redirection of both standard error and output	<b>Home</b>	→ Assigns the file descriptor (fd) to file for output →
---	-------------	---

# Assigns the file descriptor (fd) to file for output

---

→ ← Writing output to files **Home** → Assigns the file descriptor (fd) to file for input →

File descriptors 0, 1 and 2 are reserved for stdin, stdout and stderr respectively. However, bash shell allows you to assign a file descriptor to an input file or output file. This is done to improve file reading and writing performance. This is known as user defined file descriptors.

## Syntax

You can assign a file descriptor to an output file with the following syntax:

```
exec fd> output.txt
```

- where, fd >= 3

## Example

Create a shell script called fdwrite.sh:

```
#!/bin/bash
# Let us assign the file descriptor to file for output
# fd # 3 is output file
exec 3> /tmp/output.txt

# Executes echo commands and # Send output to
# the file descriptor (fd) # 3 i.e. write output to /tmp/output.txt
echo "This is a test" >&3

# Write date command output to fd # 3
date >&3

# Close fd # 3
exec 3<&-
```

Save and close the file. Run it as follows:

```
chmod +x fdwrite.sh
./fdwrite.sh
cat /tmp/output.txt
```

Sample outputs:

```
This is a test
Sun Sep 20 01:10:38 IST 2009
```

→ ← Writing output to files **Home** → Assigns the file descriptor (fd) to file for input →

# Assigns the file descriptor (fd) to file for input

---

→ ← Assigns the file descriptor (fd) to file for output **Home** → Closes the file descriptor (fd) →

To assign a file descriptor to an input file use the following syntax:

```
exec fd< input.txt
```

- where, fd >= 3.

## Example

Create a shell script called fdread.sh:

```
#!/bin/bash
# Let us assign the file descriptor to file for input
# fd # 3 is Input file
exec 3< /etc/resolv.conf

# Executes cat commands and read input from
# the file descriptor (fd) # 3 i.e. read input from /etc/resolv.conf
file
cat <&3

# Close fd # 3
exec 3<&-
```

Save and close the file. Run it as follows:

```
chmod +x fdread.sh
./fdread.sh
```

→ ← Assigns the file descriptor (fd) to file for output **Home** → Closes the file descriptor (fd) →



## Closes the file descriptor (fd)

→ ← Assigns the file descriptor (fd) to file for input	<b>Home</b>	→ Opening the file descriptors for reading and writing →
--	-------------	--

To close the file descriptor use the following syntax:

```
exec fd<&-
```

To close fd # 5, enter:

```
exec 5<&-
```

## Opening the file descriptors for reading and writing

→ ← Closes the file descriptor (fd)	<b>Home</b>	→ Reads from the file descriptor (fd) →
-------------------------------------	-------------	---

Bash supports the following syntax to open file for both reading and writing on file descriptor:

```
exec fd<>fileName
```

- File descriptor 0 is used if fd is not specified.
- If the file does not exist, it is created.
- This syntax is useful to update file.

### Example

Create a shell script called fdreadwrite.sh

```
#!/bin/bash
FILENAME="/tmp/out.txt"
# Opening file descriptors # 3 for reading and writing
# i.e. /tmp/out.txt
exec 3<>$FILENAME

# Write to file
echo "Today is $(date)" >&3
echo "Fear is the path to the dark side. Fear leads to anger. " >&3
echo "Anger leads to hate. Hate leads to suffering." >&3
echo "--- Yoda" >&3

# close fd # 3
exec 3>&-
```

→ ← Closes the file descriptor (fd)	<b>Home</b>	→ Reads from the file descriptor (fd) →
-------------------------------------	-------------	---

# Reads from the file descriptor (fd)

→ ← Opening the file descriptors for reading and writing **Home** → Executes commands and send output to the file descriptor (fd) →

You can use the read command to read data from the keyboard or file. You can pass the -u option to the read command from file descriptor instead of the keyboard. This is useful to read file line by line or one word at a time.

## Syntax

```
read -u fd var1 var2 ... varN
```

OR use the → while loop to read the entire file line:

```
while IFS= read -u fd -r line
do
    command1 on $line
    command2 on $line
    ..
    ....
    commandN
done
```

## Example

Create a shell script called readwritefd.sh as follows:

```
#!/bin/bash
# Let us assign the file descriptor to file for input fd # 3 is Input
file
exec 3< /etc/resolv.conf

# Let us assign the file descriptor to file for output fd # 3 is Input
file
exec 4> /tmp/output.txt

# Use read command to read first line of the file using fd # 3
read -u 3 a b

# Display data on screen
echo "Data read from fd # 3:"
echo $a $b

# Write the same data to fd # 4 i.e. our output file
echo "Wrting data read from fd #3 to fd#4 ... "
echo "Field #1 - $a " >&4
echo "Field #2 - $b " >&4

# Close fd # 3 and # 4
exec 3<&-
```

```
exec 4<&-
```

Save and close the file. Run it as follows:

```
chmod +x readwritefd.sh
./readwritefd.sh
```

Sample output:

```
Data read from fd # 3:
nameserver 192.168.1.254
Wrting data read from fd #3 to fd#4 ...
```

To view data written to fd # 4 i.e. /tmp/output.txt, use the cat command as follows:

```
cat /tmp/output.txt
```

Sample outputs:

```
Field #1 - nameserver
Field #2 - 192.168.1.254
```

### Shell Script To Display Its Own FDs

The following shell script displays its actual fd numbers and file associated with them (displayfds.sh):

```
#!/bin/bash
# Let us assign the file descriptor to file for input fd # 3 is Input
file
exec 3< /etc/resolv.conf

# Let us assign the file descriptor to file for output fd # 3 is Input
file
exec 4> /tmp/output.txt

# Use read command to read first line of the file
read -u 3 a b

echo "*** My pid is $$"
mypid=$$

echo "*** Currently open files by $0 scripts.."
```

```
ls -l /proc/$mypid/fd

# Close fd # 3 and # 4
exec 3<&-
exec 4<&-
```

Save and close the file. Run it as follows:

```
chmod +x displayfds.sh
./displayfds.sh
```

Sample output:

```
*** My pid is 19560
*** Currently open files by ./displayfds.sh scripts..
total 0
lrwx----- 1 vivek vivek 64 2009-09-20 01:45 0 -> /dev/pts/2
lrwx----- 1 vivek vivek 64 2009-09-20 01:45 1 -> /dev/pts/2
lrwx----- 1 vivek vivek 64 2009-09-20 01:45 2 -> /dev/pts/2
lr-x----- 1 vivek vivek 64 2009-09-20 01:45 255 ->
/tmp/displayfds.sh
lr-x----- 1 vivek vivek 64 2009-09-20 01:45 3 -> /etc/resolv.conf
l-wx----- 1 vivek vivek 64 2009-09-20 01:45 4 -> /tmp/output.txt
```

1. The file descriptors 3 is assigned to `/etc/resolv.conf` and 4 is assigned to `/tmp/output.txt`.
2. Fd # 0, 1, and 2 are all assigned to `/dev/pts/2` i.e. my screen in this output.
3. The `ls /proc/$mypid/fd` command lists all open fds using scripts PID (process identification number) number.
4. The `proc` file system (`/proc`) is a pseudo-file system which is used as an interface to kernel data structures.
5. There is a numerical subdirectory for each running process; the subdirectory is named by the process ID. Each such subdirectory contains the pseudo-files and directories.
6. `/proc/[PID]/fd` is one of such directory containing one entry for each file which the process has open, named by its file descriptor, and which is a symbolic link to the actual file. Thus, 0 is standard input, 1 standard output, 2 standard error, 3 `/etc/resolv.conf`, 4 `/tmp/output.txt` etc.

## Shell Script To Read File Line by Line

Create a shell script called `readfile.sh`:

```
#!/bin/bash
# Shell script utility to read a file line line.
FILE="$1"

# make sure filename supplied at a shell prompt else die
[ $# -eq 0 ] && { echo "Usage: $0 filename"; exit 1; }

# make sure file exist else die
[ ! -f $FILE ] && { echo "Error - File $FILE does not exists." ; exit
2; }

# make sure file readonly else die
[ ! -r $FILE ] && { echo "Error - Can not read $FILE file."; exit 3; }

IFS=$(echo -en "\n\b")

exec 3<$FILE
while read -u 3 -r line
do
```

```

    echo $line
done

# Close fd # 3
exec 3<&-

# exit with 0 success status
exit 0

```

Save and close the file. Run it as follows:

```

chmod +x readfile.sh
./readfile.sh /etc/resolv.conf

```

→ ← Opening the file descriptors for reading and writing	<b>Home</b>	→ Executes commands and send output to the file descriptor (fd) →
--	-------------	---

## Executes commands and send output to the file descriptor (fd)

---

→ ← Reads from the file descriptor (fd)	<b>Home</b>	→ Chapter 6 Challenges →
---	-------------	-----------------------------

The syntax is as follows to run or execute commands and send output to the file descriptor:

```

command-name >& fd
./shell-script >& fd

```

For example, send output of 'free -m' command to the fd # 4:

```

#!/bin/bash
exec 4> /tmp/out.txt
free -m >&4

```

### Shell Script To Collect System Information

Create a shell script called sysinfo.sh:

```

#!/bin/bash
# get date in dd-mm-yyyy format
NOW=$(date +"%d-%m-%Y")

# create output file name
OUTPUT="/tmp/sysinfo.$NOW.log"

# Assign the fd 3 to $OUTPUT file
exec 3> $OUTPUT

```

```
# Write date, time and hostname
echo "-----" >&3
echo "System Info run @ $(date) for $(hostname)" >&3
echo "-----" >&3

echo "*****" >&3
echo "*** Installed Hard Disks ***" >&3
echo "*****" >&3
fdisk -l | egrep "^Disk /dev" >&3

echo "*****" >&3
echo "*** File System Disk Space Usage ***" >&3
echo "*****" >&3
df -H >&3

echo "*****" >&3
echo "*** CPU Information ***" >&3
echo "*****" >&3
grep 'model name' /proc/cpuinfo | uniq | awk -F: '{ print $2}' >&3

echo "*****" >&3
echo "*** Operating System Info ***" >&3
echo "*****" >&3
uname -a >&3
[ -x /usr/bin/lsb_release ] && /usr/bin/lsb_release -a >&3 || echo
"/usr/bin/lsb_release not found." >&3

echo "*****" >&3
echo "*** Amount Of Free And Used Memory ***" >&3
echo "*****" >&3
free -m >&3

echo "*****" >&3
echo "*** Top 10 Memory Eating Process ***" >&3
echo "*****" >&3
ps -auxf | sort -nr -k 4 | head -10 >&3

echo "*****" >&3
echo "*** Top 10 CPU Eating Process ***" >&3
echo "*****" >&3
ps -auxf | sort -nr -k 3 | head -10 >&3

echo "*****" >&3
echo "*** Network Device Information [eth0] ***" >&3
echo "*****" >&3
netstat -i | grep -q eth0 && /sbin/ifconfig eth0 >&3 || echo "eth0 is
not installed" >&3
```

```

echo "*****" >&3
echo "*** Network Device Information [eth1] ***" >&3
echo "*****" >&3
netstat -i | grep -q eth1 && /sbin/ifconfig eth1 >&3 || echo "eth1 is
not installed" >&3

echo "*****" >&3
echo "*** Wireless Device [wlan0] ***" >&3
echo "*****" >&3
netstat -i | grep -q wlan0 && /sbin/ifconfig wlan0 >&3 || echo "wlan0 is
not installed" >&3

echo "*****" >&3
echo "*** All Network Interfaces Stats ***" >&3
echo "*****" >&3
netstat -i >&3
echo "System info wrote to $OUTPUT file."

```

Save and close the file. Runt it as follows:

```

chmod +x sysinfo.sh
./sysinfo.sh

```

Sample outputs:

```

-----
System Info run @ Sun Sep 20 02:41:43 IST 2009 for vivek-desktop
-----

```

```

*****
*** Installed Hard Disks ***
*****

```

```

Disk /dev/sda: 1500.3 GB, 1500301910016 bytes

```

```

Disk /dev/sdb: 500.1 GB, 500107862016 bytes

```

```

Disk /dev/sdc: 500.1 GB, 500107862016 bytes

```

```

*****

```

```

*** File System Disk Space Usage ***

```

```

*****

```

Filesystem	Size	Used	Avail	Use%	Mounted on
/dev/sdb2	99G	29G	65G	31%	/
tmpfs	4.3G	0	4.3G	0%	/lib/init/rw
varrun	4.3G	267k	4.3G	1%	/var/run
varlock	4.3G	0	4.3G	0%	/var/lock
udev	4.3G	2.9M	4.3G	1%	/dev
tmpfs	4.3G	361k	4.3G	1%	/dev/shm
/dev/sdb5	294G	282G	12G	96%	/share
/dev/sdc2	247G	164G	71G	70%	/disk1p2

```

/dev/sda5          1.4T   444G   861G   34% /1.5
*****
*** CPU Information ***
*****
Filesystem          Size   Used  Avail Use% Mounted on
/dev/sdb2           99G    29G    65G   31% /
tmpfs                4.3G     0    4.3G   0% /lib/init/rw
varrun              4.3G   267k    4.3G   1% /var/run
varlock             4.3G     0    4.3G   0% /var/lock
udev                4.3G   2.9M    4.3G   1% /dev
tmpfs                4.3G   361k    4.3G   1% /dev/shm
/dev/sdb5           294G   282G    12G   96% /share
/dev/sdc2           247G   164G    71G   70% /disk1p2
/dev/sda5          1.4T   444G   861G   34% /1.5
*****
*** Operating System Info ***
*****
Linux vivek-desktop 2.6.27-11-server #1 SMP Wed Apr 1 21:53:55 UTC 2009
i686 GNU/Linux
Distributor ID:      Ubuntu
Description:         Ubuntu 8.10
Release:             8.10
Codename:            intrepid
*****
*** Amount Of Free And Used Memory ***
*****
              total          used            free           shared           buffers
cached
Mem:           8105           4178           3926                0             181
3093
-/+ buffers/cache:           903           7201
Swap:          1906              0           1906
*****
*** Top 10 Memory Eating Process ***
*****
vivek      8413  5.8  4.1 658020 343488 ?           Rl   Sep19  29:51
\__ /opt/firefox/firefox-bin
vivek     18058  1.2  2.3 241724 198904 pts/1       Sl   00:54   1:18 vi
/home/vivek/output.txt
vivek      8600  3.9  1.1 175616 93900 ?           Sl   Sep19  20:00
/usr/bin/python /usr/bin/deluge
root       7701  3.0  0.5 314200 41940 tty7        Sls+ Sep19  15:20
\__ /usr/X11R6/bin/X :0 -br -audit 0 -auth /var/lib/gdm/:0.Xauth
-nolisten tcp vt7
tomcat55   7875  0.0  0.4 293688 36460 ?           Sl   Sep19   0:17 \__
/usr/bin/jsvc -user tomcat55 -cp
/usr/share/java/commons-daemon.jar:/usr/share/tomcat5.5/bin/bootstrap.jar

```



```

-outfile SYSLOG -errfile SYSLOG -pidfile /var/run/tomcat5.5.pid
-Djava.awt.headless=true -Xmx128M
-Djava.endorsed.dirs=/usr/share/tomcat5.5/common/endorsed
-Dcatalina.base=/var/lib/tomcat5.5 -Dcatalina.home=/usr/share/tomcat5.5
-Djava.io.tmpdir=/var/lib/tomcat5.5/temp -Djava.security.manager
-Djava.security.policy=/var/lib/tomcat5.5/conf/catalina.policy
-Djava.util.logging.manager=org.apache.juli.ClassLoaderLogManager
-Djava.util.logging.config.file=/var/lib/tomcat5.5/conf/logging.properties
org.apache.catalina.startup.Bootstrap
vivek      8283  0.0  0.3 113548 28888 ?          Sl   Sep19   0:03
gnome-terminal
vivek      18341 0.3  0.3  62048 28732 pts/2    S    01:07   0:20  |
\_ gedit /tmp/x
vivek      17561 0.0  0.3  77692 27172 ?          S    00:33   0:01
\_ nautilus --no-desktop --browser
vivek      8181  0.0  0.2  52844 22180 ?          S    Sep19   0:15
\_ gnome-panel
vivek      8147  0.0  0.2  63868 17652 ?          Ssl  Sep19   0:02
/usr/lib/gnome-settings-daemon/gnome-settings-daemon
*****
*** Top 10 CPU Eating Process ***
*****
vivek      8413  5.8  4.1 658020 343836 ?          Dl   Sep19  29:51
\_ /opt/firefox/firefox-bin
vivek      8600  3.9  1.1 175616 93900 ?          Sl   Sep19  20:00
/usr/bin/python /usr/bin/deluge
root       7701  3.0  0.5 314200 41940 tty7      SLs+ Sep19  15:20
\_ /usr/X11R6/bin/X :0 -br -audit 0 -auth /var/lib/gdm/:0.Xauth
-nolisten tcp vt7
vivek      8097  1.4  0.0  31124  4776 ?          Ssl  Sep19   7:18
/usr/bin/pulseaudio -D --log-target=syslog
vivek      18058 1.2  2.3 241724 198904 pts/1    Sl   00:54   1:18 vi
/tmp/sysinfo.sh
vivek      18341 0.3  0.3  62048 28732 pts/2    R    01:07   0:20  |
\_ gedit /tmp/x
root       8302  0.1  0.0     0     0 ?          S<   Sep19   0:53  \_
[ntos_wq]
www-data   8064  0.0  0.0  30204  2412 ?          S    Sep19   0:00
\_ /usr/bin/php-cgi
www-data   8063  0.0  0.0  30204  2412 ?          S    Sep19   0:00
\_ /usr/bin/php-cgi
www-data   8062  0.0  0.0  30204  2412 ?          S    Sep19   0:00
\_ /usr/bin/php-cgi
*****
*** Network Device Information [eth0] ***
*****
eth0 is not installed

```

```

*****
*** Network Device Information [eth1] ***
*****

eth1 is not installed
*****
*** Wireless Device [wlan0] ***
*****

wlan0      Link encap:Ethernet  HWaddr 00:1e:2a:47:42:8d
           inet addr:192.168.1.100  Bcast:192.168.1.255
Mask:255.255.255.0
           inet6 addr: fe80::21e:2aff:fe47:428d/64 Scope:Link
           UP BROADCAST RUNNING MULTICAST  MTU:1500  Metric:1
           RX packets:648676 errors:0 dropped:0 overruns:0 frame:0
           TX packets:622282 errors:0 dropped:0 overruns:0 carrier:0
           collisions:0 txqueuelen:1000
           RX bytes:465564933 (465.5 MB)  TX bytes:310468013 (310.4 MB)
           Interrupt:18 Memory:e3000000-e3010000

*****
*** All Network Interfaces Stats ***
*****

Kernel Interface table
Iface      MTU Met    RX-OK RX-ERR RX-DRP RX-OVR      TX-OK TX-ERR TX-DRP
TX-OVR Flg
lo          16436 0        6784    0      0 0          6784    0      0
           0 LRU
vmnet1     1500 0          0      0      0 0          60      0      0
           0 BMRU
vmnet3     1500 0          0      0      0 0          60      0      0
           0 BMRU
vmnet8     1500 0          0      0      0 0          60      0      0
           0 BMRU
wlan0      1500 0       648676    0      0 0       622282    0      0
           0 BMRU

```

# Chapter 6 Challenges

---

→ ← Executes commands and send output to the file descriptor (fd)	<b>Home</b>	Chapter 7: Pipes and Filters →
---	-------------	--------------------------------

- Decide whether the following sentence is true or false:
  1. To create empty file use **>filename**.
  2. If no files given cat command reads from standard input.
  3. The standard input defaults to user keyboard.
  4. **0<filename"" takes standard input from file. # ""2>filename** puts standard output to file.
  5. **./script.sh 2>&1** puts standard error to current destination of standard output.
  6. **>output.txt** if output.txt doesn't exist it is created and if it exist it is overwritten.
  7. The order in which you place redirection is significant.
  8. The following command will generate an error message - `</etc/passwd grep vivek`
  9. The following two commands will produced the same results:

```
sort < input.txt > output.txt
sort > output.txt < input.txt
```

- Write a shell command that associates the file descriptor 2 to a file called log.txt and send fd # 2 to a log.txt instead of the screen. Then associates fd # 1 with the file associated with the fd # 2.
- Write a shell script to open /etc/passwd file using fd (input) and copy the same to /tmp/passwd.output file using file descriptor (output).

→ ← Executes commands and send output to the file descriptor (fd)	<b>Home</b>	Chapter 7: Pipes and Filters →
---	-------------	--------------------------------

# Chapter 7: Pipes and Filters

## Linking Commands

← Chapter 7: Pipes and Filters	<b>Home</b>	→ Multiple commands →
--------------------------------	-------------	--------------------------

Under bash you can create a sequence of one or more commands separated by one of the following operators:

Operator	Syntax	Description	Example
;	command1; command2	Separates commands that are executed in sequence.	In this example, pwd is executed only after date command completes. <pre>date ; pwd</pre>
&	command arg &	The shell executes the command in the background in a subshell. The shell does not wait for the command to finish, and the return status is 0. The & operator runs the command in background while freeing up your terminal for other work.	In this example, find command is executed in background while freeing up your shell prompt. <pre>find / -iname "*.pdf" &gt;/tmp/output.txt &amp;</pre>
&&	command1 && command2	command2 is executed if, and only if, command1 returns an exit status of zero i.e. command2 only runs if first command1 run successfully.	<pre>[ ! -d /backup ] &amp;&amp; mkdir -p /backup</pre> See → Logical AND section for examples.
	command1    command2	command2 is executed if and only if command1 returns a non-zero exit status i.e. command2 only runs if first command fails.	<pre>tar cvf /dev/st0 /home    mail -s 'Backup failed' you@example.com &lt;/dev/null</pre> See → Logical OR section for examples.
	command1   command2	Linux shell pipes join the standard output of command1 to the standard input of command2.	In this example, output of the ps command is provided as the standard input to the grep command <pre>ps aux   grep httpd</pre>

← Chapter 7: Pipes and Filters	<b>Home</b>	→ Multiple commands →
--------------------------------	-------------	--------------------------

# Multiple commands

[← Linking Commands](#)
[Home](#)
[→ Putting jobs in background →](#)

You can build a sequences of commands using the ; character (operator) and syntax is:

```
command1 ; command2 ; commandN
```

OR

```
{ command1; command2 }
```

This way you can run commands one after the other. The following example, shell scripts display an error message if sufficient command line arguments are not passed (math.sh):

```
#!/bin/bash
a=$1
b=$3
op=$2
ans=0

# display usage
# run commands one after the other using ; chracter
[ $# -eq 0 ] && { echo -e "Usage: $0 num1 op num2\n\t $0 1 + 5"; exit
1; }

case $op in
+)
    ans=$(( a+b ));;
-)
    ans=$(( a-b ));;
/)
    ans=$(( a/b ));;
\*|x)
    ans=$(( a+b ));;
*)
    echo "Unknown operator."
    exit 2;;
esac
echo "$a $op $b = $ans"
```

Save and close the file. Run it as follows:

```
chmod +x math.sh
./math.sh
./math.sh 1 + 5
./math.sh 10 \* 5
```

Without ; and && character (operator) joining multiple command the following one liner:

```
[ $# -eq 0 ] && { echo -e "Usage: $0 num1 op num2\n\t $0 1 + 5"; exit
1; }
```

would look like as follows:

```
if [ $# -eq 0 ]
then
    echo -e "Usage: $0 num1 op num2\n\t $0 1 + 5"
    exit 1;
fi
```

## Examples

Use the watch command to monitor temp file (/tmp) system every 5 seconds:

```
watch -n 5 'df /tmp; ls -lASft /tmp'
```

→ ← Linking Commands **Home** → Putting jobs in background →

# Putting jobs in background

---

→ ← Multiple commands **Home** → Pipes →

- Linux supports executing multiple processes in parallel or in series.
- You always begin your first session (login session) on the Linux system with a single process running bash as shell.
- Most Linux commands such as editing files, displacing current date & time, logged in users etc can be done with various Linux commands.
- You type all commands at a shell prompt one by one. These program always take control of your screen and when done you will get back the shell prompt to type a new set of commands.
- However, sometime you need to carry out tasks in background and use the terminal for other purpose. For example, find all mp3 files stored on a disk while writing a c program.

## Job Control

- The bash shell allows you to run tasks (or commands) in the background using the facility called **job control**.
- Job control refers to the ability to selectively stop, suspend the execution of processes and continue (resume) their execution at a later point.
- A user typically employs this facility via an interactive interface supplied jointly by the system's terminal driver and bash.

## Jobs

- Processes under the influence of a job control facility are referred to as jobs.
- Each job has a unique id called job number.
- You can use the following command to control the job:
  - fg - Place job in the foreground.
  - bg - Place job in the background.
  - jobs - Lists the active jobs on screen.

## Background process

- A command that has been scheduled nonsequentially is called **background process**.
- You can not see the background processes on screen. For example, Apache httpd server runs in background to serve web pages. You can put your shell script or any command in background.

## Foreground process

- A command that you can see the command on screen is called the **foreground process**.

## How do I put commands in background?

The syntax is as follows for putting jobs in background:

```
command &
command arg1 arg2 &
command1 | command2 arg1 &
command1 | command2 arg1 > output &
```

- The & operator puts command in the background and free up your terminal.
- The command which runs in background is called a job.
- You can type other command while background command is running.

## Example

For example, if you type:

```
find /nas -iname "*.mp3" > /tmp/filelist.txt &
```

Sample outputs:

```
[1] 1307
```

The find command is now running in background. When bash starts a job in the background, it prints a line showing a job number ([1]) and a process identification number (PID - 1307). A job sends a message to the terminal upon completion as follows identifying the job by its number and showing that it has completed:

```
[1]+  Done                  find /share/ -iname "*.mp3" >
/tmp/filelist
```

→ ← Multiple commands	<b>Home</b>	→ Pipes →
-----------------------	-------------	-----------

# Pipes

---

<a href="#">← Putting jobs in background</a>	<a href="#">Home</a>	<a href="#">→ How to use pipes to connect programs</a>
--	----------------------	--

A shell pipe is a way to connect the output of one program to the input of another program without any temporary file.

## Syntax

```
command1 | command2
command1 | command2 | commandN
command1 arg1 | command2 arg1 arg2
get_data_command | verify_data_command | process_data_command |
format_data_command > output.data.file
get_data_command < input.data.file | verify_data_command |
process_data_command | format_data_command > output.data.file
```

- You can connect two or more commands at a time.
- The data path which joins two programs is called a *pipe*.
- The vertical bar (|) is the pipe symbol.
- A shell pipe supports Unix philosophy of chaining programs thorougher to complete complex task.
- Redirection in pipes is also allowed.
- The data path only works in one direction:

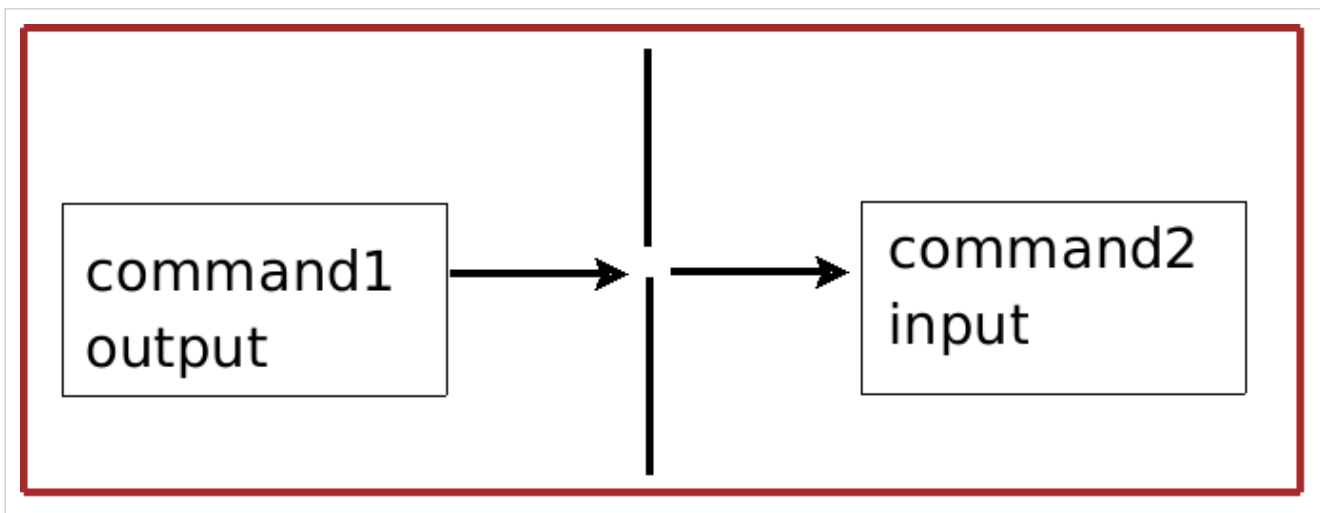

<a href="#">← Putting jobs in background</a>	<a href="#">Home</a>	<a href="#">→ How to use pipes to connect programs</a>
--	----------------------	--



# How to use pipes to connect programs

---

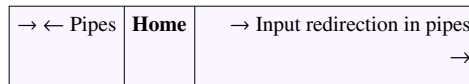

- Use the vertical bar (|) between two commands. In this example, send ls command output to grep command i.e. find out if data.txt file exists or not in the current working directory):

```
ls | grep "data.txt"
```

- All → command line arguments (parameters) listed after command name, but before the the vertical bar:

```
ls -al | grep "data.txt"
```

- There is no need to put spaces between command names and vertical bars, it is optional:

```
ls -al|grep "data.txt"
```

- However, I recommend putting white spacing between the command names and vertical bars to improve the readability.
- You can redirect → pipe output to a file (→ output redirection with > symbol):

```
ps aux | grep httpd > /tmp/ps.output.log
```

## Examples

Common shell pipe examples:

### Pause ls command output

Send output of the ls command as input to the more command. So that output is printed one screen full page at a time:

```
ls -l | more
```

### Show a sorted list of logged on users

Output of who command is given as input to sort command. So that it will print a sorted list of users:

```
who | sort  
who | sort > sorted_list.txt
```

## Count logged in users

Output of who command is given as input to wc command, so that it will number of user who logged on to the system:

```
who | wc -l
```

## Find out if user vivek logged in or not

```
who | grep -i vivek
```

## Count total files in current directory

```
ls -l | wc -l
```

## Execute a shutdown command at a given time

```
echo "shutdown -h now" | at 12am tomorrow
```

## Format output of mount command

Display mount command output in a nice format

```
mount | column -t
```

## Backup (tar over ssh)

Use tar command over secure ssh session to backup local /home file system:

```
tar zcvf - /home | ssh user@server "cat > /backup/home_fs.workstation_sep_21_09.tar.gz"
```

## Case conversion

```
v="Unix Philosophy"; echo $v | tr '[:lower:]' '[:upper:]'
echo 'tHIs IS A TeSt' | tr '[:upper:]' '[:lower:]'
```

## Birthday Email Reminder

```
echo "/usr/bin/mail -s 'Birthday gift for Julia' vivek@gite.in < /dev/null" | at 17:45
```

## Create An ISO CD Image

Create an ISO cdrom image from contents of /home/vivek/photos directory:

```
mkisofs -V Photos -r /home/vivek/photos | gzip -9 > /tmp/photos.iso.cd.gz
```

You can burn an ISO cdrom image using the following syntax:

```
gzip -dc /tmp/photos.iso.cd.gz | cdrecord -v dev=/dev/dvdrw -
```

It is also possible to create an ISO image and burn it directly to cd:

```
mkisofs -V Photos -r /home/vivek/photos | cdrecord -v dev=/dev/dvdrw -
```

## Create a random password

```
tr -dc A-Za-z0-9_ < /dev/urandom | head -c12 | xargs
```

→ ← Pipes	Home	→ Input redirection in pipes →
-----------	------	-----------------------------------

# Input redirection in pipes

---

→ ← How to use pipes to connect programs	Home	→ Output redirection in pipes →
--	------	---------------------------------

- The → input < redirection symbol can be used with pipes to get input from a file:

```
command1 < input.txt | command2  
command1 < input.txt | command2 arg1 | command3
```

For example, the sort command will get input from /etc/passwd file, which is piped to grep command:

```
sort < input.txt | grep something  
sort < input.txt | uniq | grep something
```

→ ← How to use pipes to connect programs	Home	→ Output redirection in pipes →
--	------	---------------------------------

# Output redirection in pipes

→ ← Input redirection in pipes	<b>Home</b>	→ Why use pipes →
--------------------------------	-------------	-------------------

You redirect the standard output of the last command using a pipe with → > or >> redirection symbol. The syntax is:

```
command1 | command2 > output.txt
command1 | command2 arg1 > output.txt
command1 < input.txt | command2 > output.txt
command1 < input.txt | command2 arg1 arg2 | command3 arg1 >
output.txt
```

For example, sort all process memory wise and save the output to a file called memory.txt:

```
ps -e -orss=,args= | sort -b -k1,1n > memory.txt
```

Or directly send an email to your account, enter:

```
ps -e -orss=,args= | sort -b -k1,1n | mail -s 'Memory process'
vivek@gite.in
```

→ ← Input redirection in pipes	<b>Home</b>	→ Why use pipes →
--------------------------------	-------------	-------------------

# Why use pipes

→ ← Output redirection in pipes	<b>Home</b>	→ Filters →
---------------------------------	-------------	-------------

In this example, mysqldump a database backup program is used to backup a database called wiki:

```
mysqldump -u root -p'passWord' wiki > /tmp/wikidb.backup
gzip -9 /tmp/wikidb.backup
scp /tmp/wikidb.backup user@secure.backupserver.com:~/mysql
```

- The mysqldump command is used to backup database called wiki to /tmp/wikidb.backup file.
- The gzip command is used to compress large database file to save the disk space.
- The scp command is used to move file to offsite backup server called secure.backupserver.com.
- All three commands run one after the other.
- A temporary file is created on local disk in /tmp.
- However, using pipes you can join the standard output of mysqldump command to the standard input of gzip command without creating /tmp/wikidb.backup file:

```
mysqldump -u root -p'passWord' wiki | gzip -9 > /tmp/wikidb.backup
scp /tmp/wikidb.backup user@secure.backupserver.com:~/mysql
```

- You can avoid creating a temporary file all together and run commands at the same time:

```
mysqldump -u root -p'passWord' wiki | gzip -9 | ssh
user@secure.backupserver.com "cat > /home/user/mysql/wikidb.gz"
```

- The above syntax is compact and easy to use.
- You just chained three programs together to complete complex task to make a remote mysql backup using pipes.
- → Filtering out data is another good reason to use pipes.
- Notice → standard error from pipe are mixed together:

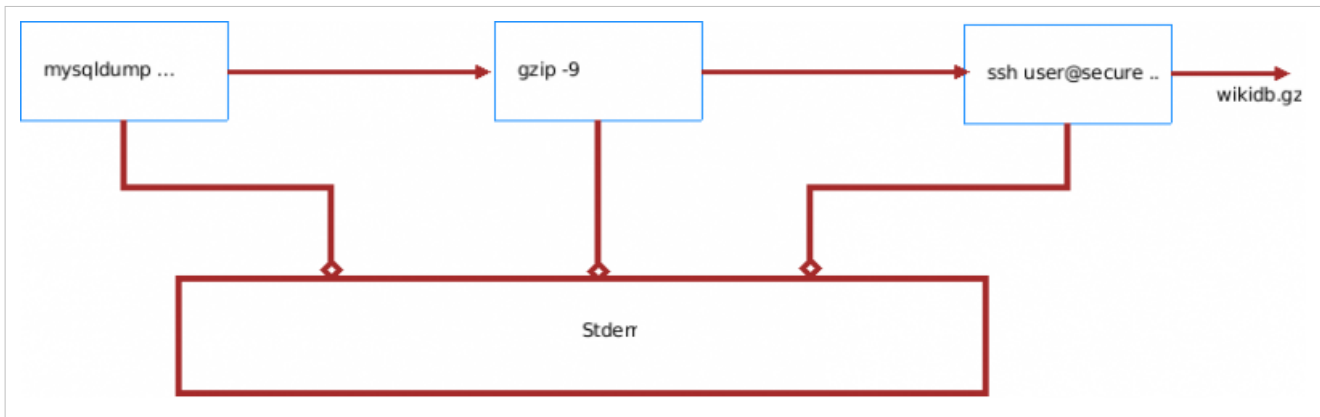

→ ← Output redirection in pipes **Home** → Filters →

## Filters

→ ← Why use pipes **Home** → Chapter 7 Challenges →

- If a Linux command accepts its input data from the → standard input and produces its output (result) on → standard output is known as a **filter**.
- Filters usually works with Linux → pipes.

## Syntax

The syntax is:

```
command1 | command2
command1 file.txt | command2
command1 args < input.txt | command2
```

Where,

- command2 is a filter command.

## Example

In this example, the `grep` command act as a filter (it will filter out name vivek from its input):

```
cut -d: -f1 /etc/passwd | sort | uniq | grep vivek
```

Filter `ps` command output using the `grep` command:

```
ps aux | grep php-cgi
```

Consider the following example:

```
sort < sname | uniq > u_sname
```

The `uniq` command is filter, which takes its input from the `sort` command and passes output as input to `uniq` command; Then `uniq` command output is redirected to "u\_sname" file. The `grep` command is considered as one of most popular filter under Linux and UNIX like operating systems.

## Commonly used filter commands

- `awk` <sup>[1]</sup>
- `cut` <sup>[2]</sup>
- `grep` <sup>[3]</sup>
- `gzip` <sup>[4]</sup>
- `head` <sup>[5]</sup>
- `paste` <sup>[6]</sup>
- `perl` <sup>[7]</sup>
- `sed` <sup>[8]</sup>
- `sort` <sup>[9]</sup>
- `split` <sup>[10]</sup>
- `strings` <sup>[11]</sup>
- `tac` <sup>[12]</sup>
- `tail` <sup>[13]</sup>
- `tee` <sup>[14]</sup>
- `tr` <sup>[15]</sup>
- `uniq` <sup>[16]</sup>
- `wc` <sup>[17]</sup>

<a href="#">→ ← Why use pipes</a>	<b>Home</b>	<a href="#">→ Chapter 7 Challenges</a> →
-----------------------------------	-------------	---

## References

- [1] <http://www.gnu.org/manual/gawk/gawk.html>
- [2] [http://www.gnu.org/software/coreutils/manual/html\\_node/cut-invocation.html](http://www.gnu.org/software/coreutils/manual/html_node/cut-invocation.html)
- [3] <http://www.gnu.org/software/grep/>
- [4] <http://www.gnu.org/software/gzip/>
- [5] [http://www.gnu.org/software/coreutils/manual/html\\_node/head-invocation.html](http://www.gnu.org/software/coreutils/manual/html_node/head-invocation.html)
- [6] [http://www.gnu.org/software/coreutils/manual/html\\_node/paste-invocation.html](http://www.gnu.org/software/coreutils/manual/html_node/paste-invocation.html)
- [7] <http://perldoc.perl.org/perl.html>
- [8] <http://www.gnu.org/software/sed/sed.html>
- [9] [http://www.gnu.org/software/coreutils/manual/html\\_node/sort-invocation.html](http://www.gnu.org/software/coreutils/manual/html_node/sort-invocation.html)
- [10] [http://www.gnu.org/software/coreutils/manual/html\\_node/split-invocation.html](http://www.gnu.org/software/coreutils/manual/html_node/split-invocation.html)
- [11] <http://sourceware.org/binutils/docs-2.19/binutils/strings.html>
- [12] [http://www.gnu.org/software/coreutils/manual/html\\_node/tac-invocation.html](http://www.gnu.org/software/coreutils/manual/html_node/tac-invocation.html)
- [13] [http://www.gnu.org/software/coreutils/manual/html\\_node/tail-invocation.html](http://www.gnu.org/software/coreutils/manual/html_node/tail-invocation.html)
- [14] [http://www.gnu.org/software/coreutils/manual/html\\_node/tee-invocation.html](http://www.gnu.org/software/coreutils/manual/html_node/tee-invocation.html)
- [15] [http://www.gnu.org/software/coreutils/manual/html\\_node/tr-invocation.html](http://www.gnu.org/software/coreutils/manual/html_node/tr-invocation.html)
- [16] [http://www.gnu.org/software/coreutils/manual/html\\_node/uniq-invocation.html](http://www.gnu.org/software/coreutils/manual/html_node/uniq-invocation.html)
- [17] [http://www.gnu.org/software/coreutils/manual/html\\_node/wc-invocation.html](http://www.gnu.org/software/coreutils/manual/html_node/wc-invocation.html)

## Chapter 7 Challenges

---

→ ← Filters	<b>Home</b>	Chapter 8: Traps →
-------------	-------------	-----------------------

- Decide whether the following sentence is true or false:
  1. Linux is rich with filter programs.
  2. A filter is a program that gets most of its data from its standard input and writes its main results to its standard output.
  3. A set of processes chained by their standard streams, so that the output of each process feeds directly as input to the next one is called Linux pipeline.
  4. You can run commands one after the other using ; operator.
  5. You can run commands one after the other using && operator.
  6. Second command only runs if first is successful when you use conditional or (||) operator.
  7. A filter is very useful as part of Linux pipes.

---

# Chapter 8: Traps

---

## Signals

---

<a href="#">← Chapter 8: Traps</a>	<a href="#">Home</a>	<a href="#">→ What is a Process? →</a>
--	----------------------	--

- Linux supports both POSIX reliable signals ("standard signals") and POSIX real-time signals.
- A signal is nothing but some sort of inter-process communication (techniques for the exchanging data among multiple threads in one or more processes or commands) in Linux and Unix like operating systems.
- A signal is sent to a process or command in order to notify an event that occurred.
- For example, while running a command called `ls -R /`, you may hit CTRL+C (or Break) to cancel command execution. As soon as you hit CTRL+C, a signal called SIGINT (2) is sent to indicate interrupt from keyboard. When, SIGINT is sent to `ls` command, Linux interrupts the process's normal flow of execution. In this example, `ls` command gets terminated.
- However, you can register a signal handler for CTRL+C and take some sort of action like ignore it or display a message on the screen when `ls` command is interrupted by SIGINT.
- You need to use the `trap` command to catch signals and handle errors under Linux shell scripts.
- You can send various signals to commands and processes. For example, to terminate foreground process you can hit Ctrl+C key combination. To kill background process you can use the `kill` command and send SIGTERM (terminate command):

```
kill -TERM pid
kill -TERM 1234
```

<a href="#">← Chapter 8: Traps</a>	<a href="#">Home</a>	<a href="#">→ What is a Process? →</a>
--	----------------------	--

---



# What is a Process?

---

→ ← Signals **Home** → How to view Processes →

Linux is a multiuser (multiple users can login to Linux and share its resources) and multitasking operating system. It means you can run multiple commands and carry out multiple tasks at a time.

## More about Process

For example, you can write a c program, while listening mp3s or download files using P2P in background.

- A process is program (or command typed by user) to perform specific Job.
- In Linux when you start a process, it is given a unique number called a PID or process-id.
- PIDs start from 0 to 65535.
- PID 1 is always assigned to init process, which is the first process stated at boot time. Type the following command to verify that init always has PID 1:

```
ps -C init -o pid=,cmd
```

Sample outputs:

```
CMD
1 /sbin/init
```

## Parent and Child Processes

- A parent process is a Linux process that has created one or more child processes.
- A process can fork a child i.e create a child process.
  - For example, if a user types the ls command at a shell prompt.
  - The shell executes ls command.
  - The Linux kernel will duplicate the shell's pages of memory and then execute the ls command.
- In UNIX, every process is created using fork and exec method. However, this model results in a waste of system resources.
- Under Linux, the fork method is implemented using copy-on-write pages, so the only penalty that it incurs is the time and memory required to duplicate the parent's page tables, and to create a unique task structure for the child.
- The copy-on-write model avoids creation of unnecessary copies of structures when creating new processes.
  - For example, user types ls command at a shell prompt.
  - The Linux kernel will fork and create a subprocess or child process of bash.
  - In this example, bash is parent and ls command is child. In other words, the ls command is pointed to the same pages of memory as the bash shell.
  - Then, the child execs the ls command using copy-on-write.

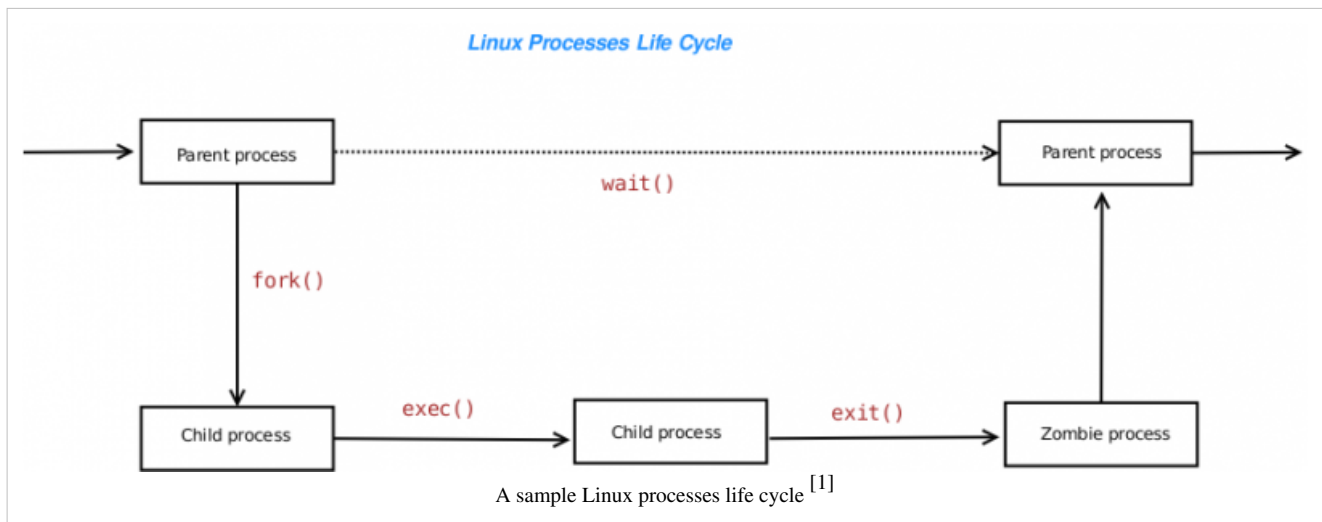

## Process States

Every Linux process has its own life cycle such as creation, execution, termination, and removal. Every process has its own state that shows what is currently happening in the process. The status of the process which can be one of the following:

1. D (uninterruptible sleep) - Process is sleeping and cannot be bring back until an event such as I/O occurred. For example, process foo is a process waiting for keyboard interrupt.
2. R (running) - Process is running or executing.
3. S (sleeping) - Process is not running and is waiting for an event or a → signal.
4. T (traced or stopped) - Process is stopped by → signals such as SIGINT or SIGSTOP.
5. Z (zombie or defunct) - Processes marked <defunct> are dead processes (so-called "zombies") that remain because their parent has not destroyed them properly. These processes will be destroyed by init if the parent process exits.

## How do I view Process states

To view states of a process, enter:

```
ps -C processName -o pid=,cmd,stat
```

For example, to display states of lighttpd, php-cgi and firefox-bin processes, enter:

```
ps -C firefox-bin -o pid=,cmd,stat
ps -C lighttpd -o pid=,cmd,stat
ps -C php-cgi -o pid=,cmd,stat
```

Sample outputs:

```

CMD                                STAT
7633 /opt/firefox/firefox-bin       Sl

CMD                                STAT
32082 /usr/sbin/lighttpd -f /etc/ S
32326 /usr/sbin/lighttpd -f /etc/ S

CMD                                STAT

```

```
1644 /usr/bin/php-cgi      S
31331 /usr/bin/php-cgi      S
31332 /usr/bin/php-cgi      S
31538 /usr/bin/php-cgi      S
```

## External links

- [Linux Kernel Process Management](#) <sup>[2]</sup>
- [Wikipedia:Copy-on-write](#)
- [man pages fork\(2\), top\(1\), ps\(1\).](#)

## References

[1] Chapter 3: Process - Understanding the Linux Kernel, Third Edition, O'Reilly Media.

[2] <http://www.informit.com/articles/article.aspx?p=370047&seqNum=2>

→ ← Signals **Home** → How to view Processes →

# How to view Processes

---

→ ← What is a Process? **Home** → Sending signal to Processes →

You need to use the `ps` command, `pstree` command, and `pgrep` command to view a snapshot of the current processes.

## ps - View process

To view current process use the `ps` command:

```
ps
ps aux | less
ps aux | grep "process-name"
ps aux | grep "httpd"
ps alx | grep "mysqld"
```

## pstree - Display a tree of processes

To display a tree of processes use the `pstree` command:

```
pstree
```

Sample outputs:

```
init├─acpid
    │
    ├─apache2──6*[apache2]
    │
    ├─atd
    │
    ├─atop
    │
    ├─avahi-daemon──avahi-daemon
    │
    ├─bonobo-activati──{bonobo-activati}
    │
    └─console-kit-dae──63*[{console-kit-dae}]
```

```

├─cron
├─2*[dbus-daemon]
├─dbus-launch
├─dd
├─deluge—5*[{deluge}]
├─dhclient
├─dnsmasq
├─evince—{evince}
├─firefox—run-mozilla.sh—firefox-bin—27*[{firefox-bin}]
├─gconfd-2
├─gdm—gdm├─Xorg
|   └─gnome-session├─gnome-panel
|                   └─gpg-agent
|                   └─metacity
|                   └─nautilus
|                   └─python
|                   └─seahorse-agent
|                   └─ssh-agent
|                   └─tracker-applet
|                   └─trackerd—2*[{trackerd}]
|                   └─update-notifier
|                   └─{gnome-session}
├─gedit
├─6*[getty]
├─gnome-power-man
├─gnome-screensav
├─gnome-settings—{gnome-settings-}
├─gnome-terminal├─bash—pstree
|               └─bash—ssltx—ssh
|               └─gnome-pty-helpe
|               └─{gnome-terminal}
├─gvfs-fuse-daemo—3*[{gvfs-fuse-daemo}]
├─gvfs-gphoto2-vo
├─gvfs-hal-volume
├─gvfsd
├─gvfsd-burn
├─gvfsd-trash
├─hald—hald-runner├─hald-addon-acpi
|                 └─hald-addon-cpuf
|                 └─hald-addon-inpu
|                 └─hald-addon-stor
├─jsvc├─jsvc
|     └─jsvc—39*[{jsvc}]
├─klogd
├─lighttpd—2*[php-cgi—4*[php-cgi]]
├─mixer_applet2—{mixer_applet2}
├─mount.ntfs

```

```

├─mysqld_safe├─logger
|           └─mysqld──10*[{mysqld}]
├─netspeed_applet
├─ntpd
├─pppd──sh──pptpgw
├─pptpcm
├─pulseaudio├─gconf-helper
|           └─2*[{pulseaudio}]
├─squid──squid──unlinkd
├─sshproxyd
├─syslogd
├─system-tools-ba

├─thunderbird──run-mozilla.sh──thunderbird-bin──10*[{thunderbird-bin}]
├─udev
├─vmnet-bridge
├─2*[{vmnet-dhcpd}]
├─vmnet-natd
├─3*[{vmnet-netifup}]
├─winbindd──winbindd
├─workrave──{workrave}
├─workrave-applet
└─wpa_supplicant

```

## pgrep - Look up processes

pgrep looks through the currently running processes and lists the process IDs which matches the selection criteria to screen. List the processes called php-cgi AND owned by vivek user.

```
pgrep -u vivek php-cgi
```

To list the processes owned by vivek OR krish.

```
pgrep -u vivek,krish
```

## External links

- [Show All Running Processes in Linux](#) <sup>[1]</sup>
- [ps - Displays The Processes](#) <sup>[2]</sup>

[← ← What is a Process?](#)
**Home**
[→ Sending signal to Processes →](#)

## References

- [1] <http://www.cyberciti.biz/faq/show-all-running-processes-in-linux/>  
 [2] <http://www.cyberciti.biz/tips/top-linux-monitoring-tools.html#5>

# Sending signal to Processes

→ ← How to view Processes **Home** → Terminating Processes →

You can send various signals to commands / process and shell scripts using the, pkill command, kill command, and killall command.

## kill - send a signal to a process

The default signal for kill is TERM. To list available signals, enter:

```
kill -l
```

Sample outputs:

```

1) SIGHUP          2) SIGINT          3) SIGQUIT        4) SIGILL
5) SIGTRAP        6) SIGABRT        7) SIGBUS         8) SIGFPE
9) SIGKILL        10) SIGUSR1       11) SIGSEGV       12) SIGUSR2
13) SIGPIPE       14) SIGALRM       15) SIGTERM       16) SIGSTKFLT
17) SIGCHLD       18) SIGCONT       19) SIGSTOP       20) SIGTSTP
21) SIGTTIN       22) SIGTTOU       23) SIGURG        24) SIGXCPU
25) SIGXFSZ       26) SIGVTALRM     27) SIGPROF       28) SIGWINCH
29) SIGIO         30) SIGPWR        31) SIGSYS         34) SIGRTMIN
35) SIGRTMIN+1    36) SIGRTMIN+2    37) SIGRTMIN+3    38)
SIGRTMIN+4
39) SIGRTMIN+5    40) SIGRTMIN+6    41) SIGRTMIN+7    42)
SIGRTMIN+8
43) SIGRTMIN+9    44) SIGRTMIN+10   45) SIGRTMIN+11   46)
SIGRTMIN+12
47) SIGRTMIN+13   48) SIGRTMIN+14   49) SIGRTMIN+15   50)
SIGRTMAX-14
51) SIGRTMAX-13   52) SIGRTMAX-12   53) SIGRTMAX-11   54)
SIGRTMAX-10
55) SIGRTMAX-9    56) SIGRTMAX-8    57) SIGRTMAX-7    58)
SIGRTMAX-6
59) SIGRTMAX-5    60) SIGRTMAX-4    61) SIGRTMAX-3    62)
SIGRTMAX-2
63) SIGRTMAX-1    64) SIGRTMAX

```

## kill command Examples

The kill command can send all of the above signals to commands and process. However, commands only give response if they are programmed to recognize those signals. Particularly useful signals include:

1. SIGHUP (1) - Hangup detected on controlling terminal or death of controlling process.
2. SIGINT (2) - Interrupt from keyboard.
3. SIGKILL (9) - Kill signal i.e. kill running process.
4. SIGSTOP (19) - Stop process.
5. SIGCONT (18) - Continue process if stopped.

To send a kill signal to PID # 1234 use:

```
kill -9 1234
```

OR

```
kill -KILL 1234
```

OR

```
kill -SIGKILL 1234
```

## killall - kill processes by name

killall sends a signal to all processes running any of the specified commands . If no signal name is specified, SIGTERM is sent. To terminate all firefox process (child and parent), enter:

```
killall processName  
killall firefox-bin
```

To send a KILL signal to firefox, enter:

```
killall -s SIGKILL firefox-bin
```

## pkill - kill process

The pkill command is another command with additional options to kill process by its name, user name, group name, terminal, UID, EUID, and GID. It will send the specified signal (by default SIGTERM) to each process instead of listing them on stdout. To send a kill signal to php-cgi process, enter:

```
pkill -KILL php-cgi
```

The above example will kill all users php-cgi process. However, -u option will kill only processes whose effective user ID is set to vivek:

```
pkill -KILL -u vivek php-cgi
```

Make sshd reread its configuration file, enter:

```
pkill -HUP sshd
```

## External links

- Kill process in Linux or terminate a process in UNIX / Linux <sup>[1]</sup>
- Linux / UNIX killing a process <sup>[2]</sup>
- Linux logout user or logoff user with pkill command <sup>[3]</sup>

→ ← How to view Processes **Home** → Terminating Processes →

## References

- [1] <http://www.cyberciti.biz/faq/kill-process-in-linux-or-terminate-a-process-in-unix-or-linux-systems/>  
 [2] <http://www.cyberciti.biz/faq/howto-linux-unix-killing-restarting-the-process/>  
 [3] <http://www.cyberciti.biz/faq/linux-logout-user-howto/>

# Terminating Processes

---

→ ← Sending signal to Processes **Home** → Shell signal values  
→

- Generally, all process terminates on their own. In this example, find command will terminate when it completed its task:

```
find /home -name "*.c" 2>error.log 1>filelists &
```

- You can terminate foreground process by pressing CTRL+C. It will send a TERM single to the process. In this example, ls -R is running on screen:

```
ls -R /
```

- To terminate simply press CTRL+C (hold down CTRL key and press C) to send an in interrupt single to the ls command.
- To terminate unwanted background process use kill command with -9 single as described in sending signal to processes section:

```
kill -TERM pid
kill -KILL pid
```

- To stop (suspend) a foreground process hit CTRL+Z (hold down CTRL key and press z). To resume the foreground process use the fg command, enter:

```
fg jobid
fg 1
fg %
```



## Example

Create a shell script called `phpjail.sh`. This script is used to start php service in a jail. This is done to improve Apache or Lighttpd web server security. This script demonstrates the usage of the `pgrep` command, `pskill` commands, and other skills you've learned so far.

```
#!/bin/sh
# A shell script to start / stop php-cgi process.
# Author: Vivek Gite <vivek@gite.in>
# Last updated on June-23-2007.
# -----
fFCGI=/usr/bin/spawn-fcgi
fIP=127.0.0.1
fPORT=9000
fUSER=phpjail
fGROUP=phpjail
fCHILD=10
fJAILEDIR=/phpjail
fPID=/var/run/fcgi.php.pid
fPHPCGI=/usr/bin/php-cgi

# path to binary files.
PKILL=/usr/bin/pkill
RM=/bin/rm
PGREP=/usr/bin/pgrep
GREP=/bin/grep
ID=/usr/bin/id

# Must be run as root else die
[ ${ID} -u -eq 0 ] || { echo "$0: Only root may run this script.";
exit 1; }

# Jail user must exist else die
${GREP} -q $fUSER /etc/passwd || { echo "$0: User $fUSER not found in
/etc/passwd."; exit 2; }

# Jail group must exist else die
${GREP} -q $fGROUP /etc/passwd || { echo "$0: Group $fGROUP not found
in /etc/group."; exit 3; }

# Jail directory must exist else die
[ ! -d ${fJAILEDIR} ] && { echo "$0: php-cgi jail directory
\"${fJAILEDIR}\" not found."; exit 4; }

# Use case to make decision
case "$1" in

    start)
```

```

        # start php-cgi in jail at given IP and server port
        $fFCGI -a $fIP -p $fPORT -u $fUSER -g $fGROUP -C
$fCHILD -c $fJAILEDIR -P $fPID -- $fPHPCGI
        [ $? -eq 0 ] && echo "Starting php-cgi .. [ OK ]" ||
echo "Starting php-cgi .. [ FAILED ]"
        ;;
stop)
        # make sure php-cgi is running
read line < "$fPID"
        if [ -d /proc/$line ]
        then
                # kill php-cgi owned by user
                ${PKILL} -KILL -u $fUSER php-cgi
                [ $? -eq 0 ] && echo "Stopping php-cgi .. [ OK ]"
\
                || echo "Stopping php-cgi .. [ FAILED
] "

                ${RM} -f $fPID
        else
                echo "$0: php-cgi is not running."
        fi
        ;;
status)
        # find out if php-cgi is running or not
        ${PGREP} -u ${fUSER} php-cgi >/dev/null 2>&1
        [ $? -eq 0 ] && echo "$0: php-cgi is running at
$fIP:$fPORT" \
                || echo "$0: php-cgi is not running at
$fIP:$fPORT"
        ;;
*)
        # display usage
        echo "Usage: $0 {start|stop|status}"
esac

```

I highly recommend the following two articles which deals with php and web server security:

- Apache2 mod\_fastcgi: Connect to External PHP via UNIX Socket or TCP/IP Port <sup>[1]</sup>
- Lighttpd FasCGI PHP, MySQL chroot jail installation under Debian Linux <sup>[2]</sup>

→ ← Sending signal to Processes	<b>Home</b>	→ Shell signal values →
---------------------------------	-------------	----------------------------

## References

- [1] <http://www.cyberciti.biz/tips/rhel-fedora-centos-apache2-external-php-spawn.html>
- [2] <http://www.cyberciti.biz/tips/howto-setup-lighttpd-php-mysql-chrooted-jail.html>

# Shell signal values

→ ← Terminating Processes	<b>Home</b>	→ trap statement →
---------------------------	-------------	-----------------------

- You must know signal and their values while writing the shell scripts.
- You cannot use (trap) all available signals.
- Some signals can never be caught. For example, the signals SIGKILL (9) and SIGSTOP (19) cannot be caught, blocked, or ignored.
- The following table is a list of the commonly used signal numbers, description and whether they can be trapped or not:

Number	Constant	Description	Default action	Trappable (Yes/No)
0	0	Success	Terminate the process.	Yes
1	SIGHUP	Hangup detected on controlling terminal or death of controlling process. Also, used to reload configuration files for many UNIX / Linux daemons.	Terminate the process.	Yes
2	SIGINT	Interrupt from keyboard (Ctrl+C)	Terminate the process.	Yes
3	SIGQUIT	Quit from keyboard (Ctrl-\ or, Ctrl-4 or, on the virtual console, the SysRq key)	Terminate the process and dump core.	Yes
4	SIGILL	Terminate the process and dump core.	Illegal instruction.	Yes
6	SIGABRT	Abort signal from abort(3) - software generated.	Terminate the process and dump core.	Yes
8	SIGFPE	Floating point exception.	Terminate the process and dump core.	Yes
9	SIGKILL	Kill signal	Terminate the process.	No
15	SIGTERM	Termination signal	Terminate the process.	Yes
20	SIGSTP	Stop typed at tty (CTRL+z)	Stop the process.	Yes

To view list of all signals, enter:

```
kill -l
```

To view numeric number for given signal called SIGTSTP, enter:

```
kill -l SIGTSTP
```

You can also view list of signal by visiting /usr/include/linux/signal.h file:

```
more /usr/include/linux/signal.h
```

→ ← Terminating Processes	<b>Home</b>	→ trap statement →
---------------------------	-------------	-----------------------

# The trap statement

---

→ ← Shell signal values	<b>Home</b>	→ How to clear trap →
-------------------------	-------------	--------------------------

- While running a script user may press Break or CTRL+C to terminate the process.
- User can also stop the process by pressing CTRL+Z.
- Error can occurred dues to bug in a shell script such as arithmetic overflow.
- This may result into errors or unpredictable output.
- Whenever user interrupts a signal is send to the command or the script.
- Signals force the script to exit.
- However, the trap command captures an interrupt.
- The trap command provides the script to captures an interrupt (signal) and then clean it up within the script.

## Syntax

The syntax is as follows

```
trap arg signal
trap command signal
trap 'action' signal1 signal2 signalN
trap 'action' SIGINT
trap 'action' SIGTERM SIGINT SIGFPE SIGSTP
trap 'action' 15 2 8 20
```

## Example

Create a shell script called testtrap.sh:

```
#!/bin/bash
# capture an interrupt # 0
trap 'echo "Exit 0 signal detected..."' 0

# display something
echo "This is a test"

# exit shell script with 0 signal
exit 0
```

Save and close the file. Run it as follows:

```
chmod +x testtrap.sh
./testtrap.sh
```

Sample outputs:

```
This is a test
Exit 0 signal detected...
```

- The first line sets a trap when script tries to exit with status 0.

- Then script exits the shell with 0, which would result in running echo command.
- Try the following example at a shell prompt (make sure /tmp/rap54ibs2sap.txt doesn't exist).
- Define a shell variable called \$file:

```
file=/tmp/rap54ibs2sap.txt
```

Now, try to remove \$file, enter:

```
rm $file
```

Sample output:

```
rm: cannot remove `/tmp/rap54ibs2sap.txt': No such file or directory
```

Now sets a trap for rm command:

```
trap "rm $file; exit" 0 1 2 3 15
```

Display list of defined traps, enter:

```
trap
```

Sample outputs:

```
trap -- 'rm /tmp/rap54ibs2sap.txt; exit' EXIT
trap -- 'rm /tmp/rap54ibs2sap.txt; exit' SIGHUP
trap -- 'rm /tmp/rap54ibs2sap.txt; exit' SIGINT
trap -- 'rm /tmp/rap54ibs2sap.txt; exit' SIGQUIT
trap -- 'rm /tmp/rap54ibs2sap.txt; exit' SIGTERM
```

Now, try again to remove the \$file, enter:

```
rm $file
```

This time rm command did not display an error. The \$file doesn't exist yet. The trap command simply exits whenever it gets 0, 1, 2, 3, or 15 signals. Try capturing CTRL+C:

```
#!/bin/bash
# capture an interrupt # 2 (SIGINT)
trap '' 2
# read CTRL+C from keyboard with 30 second timeout
read -t 30 -p "I'm sleeping hit CTRL+C to exit..."
```

Sample outputs:

```
I'm sleeping hit CTRL+C to exit...^C^C^C
```

→ ← Shell signal values	<b>Home</b>	→ How to clear trap values →
-------------------------	-------------	------------------------------

# How to clear trap

---

→ ← trap statement	<b>Home</b>	→ Include trap statements in a script →
--------------------	-------------	---

To clear a trap use the following syntax:

```
trap - signal
trap - signal1 signal2
```

For example, set a trap for rm command:

```
file=/tmp/test4563.txt
trap 'rm $file' 1 2 3 15
trap
```

To clear SIGINT (2), enter:

```
trap - SIGINT
trap
```

To clear all traps, enter:

```
trap - 1 2 3 15
trap
```

Create a shell script called oddoreven.sh:

```
#!/bin/bash
# Shell script to find out odd or even number provided by the user
# ----
# set variables to an integer attribute
declare -i times=0
declare -i n=0

# capture CTRL+C, CTRL+Z and quit singles using the trap
trap 'echo " disabled"' SIGINT SIGQUIT SIGTSTP

# set an infinite while loop
# user need to enter -9999 to exit the loop
while true
do
    # get date
    read -p "Enter number (-9999 to exit) : " n
    # if it is -9999 die
    [ $n -eq -9999 ] && { echo "Bye!"; break; }
    # find out if $n is odd or even
    ans=$(( n % 2 ))
    # display result
    [ $ans -eq 0 ] && echo "$n is an even number." || echo "$n is an
odd number."
```

```
    # increase counter by 1
    times=$(( ++times ))
done

# reset all traps
trap - SIGINT SIGQUIT SIGTSTP

# display counter
echo "You played $times times."
exit 0
```

Save and close the file. Run it as follows:

```
chmod +x oddoreven.sh
./oddoreven.sh
```

Sample outputs:

```
Enter number (-9999 to exit) : 2
2 is an even number.
Enter number (-9999 to exit) : 999
999 is an odd number.
Enter number (-9999 to exit) : ^C disabled

0 is an even number.
Enter number (-9999 to exit) : -9999
Bye!
You played 3 times.
```

<a href="#">→ ← trap statement</a>	<b>Home</b>	<a href="#">→ Include trap statements in a script →</a>
------------------------------------	-------------	---

# Include trap statements in a script

→ ← How to clear trap	<b>Home</b>	→ Use the trap statement to catch signals and handle errors →
-----------------------	-------------	---

You can use the trap command in shell script as follows. Create a shell script called mainmenu01.sh:

```
#!/bin/bash

# capture CTRL+C, CTRL+Z and quit singles using the trap
trap 'echo "Control-C disabled."' SIGINT
trap 'echo "Cannot terminate this script."' SIGQUIT
trap 'echo "Control-Z disabled."' SIGTSTP

# Create infinite while loop
while true
do
    clear
    # display menu
    echo "Server Name - $(hostname) "
    echo "-----"
    echo "    M A I N - M E N U"
    echo "-----"
    echo "1. Display date and time."
    echo "2. Display what users are doing."
    echo "3. Display network connections."
    echo "4. Exit"

    # get input from the user
    read -p "Enter your choice [ 1 -4 ] " choice

    # make decision using case..in..esac
    case $choice in
        1)
            echo "Today is $(date) "
            read -p "Press [Enter] key to continue..."
            readEnterKey
            ;;
        2)
            w
            read -p "Press [Enter] key to continue..."
            readEnterKey
            ;;
        3)
            netstat -nat
            read -p "Press [Enter] key to continue..."
            readEnterKey
    esac
done
```



```

        ;;
4)
    echo "Bye!"
    exit 0
    ;;
*)
    echo "Error: Invalid option..."
    read -p "Press [Enter] key to continue..."
readEnterKey
    ;;
esac

done

```

Save and close the file. Run it as follows:

```

chmod +x mainmenu01.sh
./mainmenu01.sh

```

Sample outputs:

```

Server Name - vivek-desktop
-----
      M A I N - M E N U
-----
1. Display date and time.
2. Display what users are doing.
3. Display network connections.
4. Exit
Enter your choice [ 1 -4 ] ^CControl-C disabled.
^ZControl-Z disabled.
1
Today is Wed Sep 23 00:26:38 IST 2009
Press [Enter] key to continue...
Server Name - vivek-desktop
-----
      M A I N - M E N U
-----
1. Display date and time.
2. Display what users are doing.
3. Display network connections.
4. Exit
Enter your choice [ 1 -4 ] 4
Bye!

```

→ ← How to clear trap	<b>Home</b>	→ Use the trap statement to catch signals and handle errors →
-----------------------	-------------	---

# Use the trap statement to catch signals and handle errors

---

→ ← Include trap statements in a script	<b>Home</b>	→ What is a Subshell? →
---	-------------	-------------------------

You can define 'functions' in scripts using the following syntax:

```
die(){
  echo "An error occurred."
  exit 2
}
```

You can simply call it as normal command:

```
die
```

You can pass arguments to function:

```
#!/bin/bash
# define var
file="/tmp/data.$$"
# create function
die(){
  echo "$@"
  exit 2
}

# ... call die if needed
[ ! -f $file ] && die "$0: File $file not found." || echo "$0: File $file found."
```

## The trap command and functions

You can use the trap command with shell functions as follows:

```
# define die()
die(){
  echo "... "
}

# set trap and call die()
trap 'die' 1 2 3 15
....
...
```

The following is an updated shell script from → how to clear a trap section:

```
#!/bin/bash
# Shell script to find out odd or even number provided by the user
# set variables to an integer attribute
declare -i times=0
declare -i n=0

# define function
warning(){
    echo -e "\n*** CTRL+C and CTRL+Z keys are disabled. Please enter
number only. Hit [Enter] key to continue..."
}

# capture CTRL+C, CTRL+Z and quit singles using the trap
trap 'warning' SIGINT SIGQUIT SIGTSTP

# set an infinite while loop
# user need to enter -9999 to exit the loop
while true
do
    # get date
    read -p "Enter number (-9999 to exit) : " n

    # if it is -9999 die
    [ $n -eq -9999 ] && { echo "Bye!"; break; }

    # $n is 0, just get next number
    [ $n -eq 0 ] && continue

    # find out if $n is odd or even
    ans=$(( n % 2 ))

    # display result
    [ $ans -eq 0 ] && echo "$n is an even number." || echo "$n is an
odd number."

    # increase counter by 1
    times=$(( ++times ))
done

# reset all traps
trap - SIGINT SIGQUIT SIGTSTP

# display counter
echo "You played $times times."
exit 0
```

The following example, add a user to the Linux system by updating /etc/passwd file and creating home directory at /home for user. It traps various single to avoid errors while creating user accounts. If user pressed CTRL+C or script

terminated it will try to rollback changes made to system files. Traps are turned on before the useradd command in shell script, and then turn off the trap after the chpasswd line.

```
#!/bin/bash
# setupaccounts.sh: A Shell script to add user to the Linux system.
# set path to binary files
ADD=/usr/sbin/useradd
SETPASSWORD=/usr/sbin/chpasswd
USERDEL=/usr/sbin/userdel
# set variables
HOMEBASE=/home
HOMEDIR=""
username=""

# define function to clean up useradd procedure
# handle errors using this function
clean_up_useradd(){
    # remove dir
    [ -d $HOMEDIR ] && /bin/rm -rf $HOMEDIR
    # remove user from passwd if exists
    grep -q "^${username}" /etc/passwd && $USERDEL ${username}
    # now exit
    exit
}

# make sure script is run by root else die
[ $(id -u) -eq 0 ] || { echo "$0: Only root may add a user or group to
the system."; exit 1;}

# get username and password
read -p "Enter user name : " username

# create homedir path
HOMEDIR="${HOMEBASE}/${username}"

# capture 0 2 3 15 signals
# if script failed while adding user make sure we clean up mess from
# /home directory and /etc/passwd file
# catch signals using clean_up_useradd()
trap 'clean_up_useradd' SIGINT SIGQUIT SIGTERM

# get password
read -sp "Enter user password : " password

# make sure user doesn't exists else die
grep -q "^${username}" /etc/passwd && { echo "$0: The user '$username'
already exists."; exit 2;}
```

```

# create a home dir
echo "Creating home directory for ${username} at ${HOMEDIR}..."
[ ! -d ${HOMEDIR} ] && mkdir -p ${HOMEDIR}

# Add user
echo "Adding user ${username}..."
${ADD} -s /bin/bash -d ${HOMEDIR} ${username} || { echo "$0: User
addition failed."; exit 3; }

# Set a password
echo "Setting up the password for ${username}..."
#printf "%s|%s\n" $username $password | ${SETPASSWORD} || { echo "$0:
Failed to set password for the user."; exit 3; }
echo "$username:$password" | ${SETPASSWORD} || { echo "$0: Failed to
set password for the user."; exit 3; }

# reset all traps
trap - 0 SIGINT SIGQUIT SIGTERM

# add rest of the script...

```

You can run this script as follows: `chmod +x setupaccounts.sh ./setupaccounts.sh` Sample outputs:

```

Enter user name : testuser
Enter user password : Creating home directory for testuser at
/home/testuser...
Adding user testuser...
Setting up the password for testuser...

```

→ ← Include trap statements in a script	<b>Home</b>	→ What is a Subshell? →
---	-------------	-------------------------

# What is a Subshell?

---

→ ← Use the trap statement to catch signals and handle errors **Home** → Compound command →

- Whenever you run a shell script, it creates a new process called subshell and your script will get executed using a subshell.
- A Subshell can be used to do parallel processing.
- If you start another shell on top of your current shell, it can be referred to as a subshell. Type the following command to see subshell value:

```
echo $BASH_SUBSHELL
```

OR

```
echo "Current shell: $BASH_SUBSHELL"; ( echo "Running du in subshell: $BASH_SUBSHELL" ;cd /tmp; du 2>/tmp/error 1>/tmp/output)
```

- Any commands enclosed within parentheses are run in a subshell.

## Exporting Functions and Variables

A subshell does not inherit a variable's setting. Use the export command to export variables and functions to subshell:

```
WWWJAIL=/apache.jail
export WWWJAIL
die() { echo "$@"; exit 2; }
export -f die
# now call script that will access die() and $WWWJAIL
/etc/nixcraft/setupjail -d cyberciti.com
```

- However, environment variables (such as \$HOME, \$MAIL etc) are passed to subshell.

## Use exec command to avoid subshell

You can use the → exec command to avoid subshell. The exec command replaces this shell with the specified program without swapping a new subshell or proces. For example,

```
exec command
# redirect the shells stderr to null
exec 2>/dev/null
```

## The . (dot) Command and Subshell

The . (dot) command is used to run shell scripts as follows:

```
. script.sh
```

The dot command allows you to modify current shell variables. For example, create a shell script as follows called /tmp/dottest.sh:

```
#!/bin/bash
echo "In script before : $WWWJAIL"
WWWJAIL=/apache.jail
echo "In script after : $WWWJAIL"
```

Close and save the file. Run it as follows:

```
chmod +x /tmp/dottest.sh
```

Now, define a variable called WWWJAIL at a shell prompt:

```
WWWJAIL=/foobar
echo $WWWJAIL
```

Sample outputs:

```
/foobar
```

Run the script:

```
/tmp/dottest.sh
```

Check the value of WWWJAIL:

```
echo $WWWJAIL
```

You should see the original value of \$WWWJAIL (/foobar) as the shell script was executed in a subshell. Now, try the dot command:

```
. /tmp/dottest.sh
echo $WWWJAIL
```

Sample outputs:

```
/apache.jail
```

The value of \$WWWJAIL (/apache.jail) was changed as the script was run in the current shell using the dot command.

# Compound command

---

→ ← What is a Subshell? **Home** → exec command →

A compound command is one of the following syntax format:

```
( list )  
( command1; command2 )  
{ command1; command2 }
```

## Why use ( command1; command2 ) syntax

In the following example, you are running multiple commands:

```
hostname ; date ; who | wc -l
```

Now try to save output to a file called /tmp/output.txt:

```
hostname ; date ; who | wc -l > /tmp/output.txt  
cat /tmp/output.txt
```

All commands will run but only the output of last pipe is saved to the file. To save output of all of the above commands to file, enter:

```
( hostname ; date ; who | wc -l ) > /tmp/output.txt  
cat /tmp/output.txt
```

All commands inside ( ... ) run using a subshell.

## Why use { command1; command2; } syntax

- This syntax allows you to run all commands in the current shell environment.
- It works like a group command:

```
[ $? -eq 0 ] && { echo "Usage: $0 filename"; exit 1; }
```

→ ← What is a Subshell? **Home** → exec command →

---



# Exec command

---

→ ← Compound command	<b>Home</b>	→ Chapter 8 Challenges →
----------------------	-------------	-----------------------------

- The exec command is used to replace the current shell with the command without spawning a new process or subshell.
- The exec command is also used to assign → the file descriptor fd to filename:

```
exec 3> /tmp/output
```

- The exec command is used by "wrapper" scripts. For example, php-cgi can run as cgi program after setting environment variables or other configuration.
- By using exec, the resources used by the php.cgi shell program do not need to stay in use after the program is started. The following script can be run using Apache web server <sup>[1]</sup> and it will speed up php execution:

```
#!/bin/bash
# Shell Script wrapper to Run PHP5 using mod_fastcgi under Apache 2.2.x
# Tested under CentOS Linux and FreeBSD and 7.x server.
PHP_CGI=/usr/local/bin/php-cgi
# for centos / rhel set it as follows
# PHP_CGI=/usr/bin/php-cgi
export PHP_FCGI_CHILDREN=4
export PHP_FCGI_MAX_REQUESTS=1000
exec $PHP_CGI
```

→ ← Compound command	<b>Home</b>	→ Chapter 8 Challenges →
----------------------	-------------	-----------------------------

## References

[1] [http://www.cyberciti.biz/faq/freebsd-apache-php-mod\\_fastcgi-tutorial/](http://www.cyberciti.biz/faq/freebsd-apache-php-mod_fastcgi-tutorial/)

# Chapter 8 Challenges

---

→ ← exec command	<b>Home</b>	Chapter 9: Functions →
------------------	-------------	------------------------

- Decide whether the following sentence is true or false:
  1. You can make the shell variable known to subshells with export command.
  2. To suspend a foreground process in a screen press CTRL+C.
  3. Commands enclosed within parentheses (...) are always executed in a subshell.
  4. CTRL+C sends a single to background process.
  5. To launch a gedit text editor as a background process append an ampersand to the end of gedit command.  
`gedit &`
  6. To send a SIGKILL (KILL or 9) to all running process use the kill command. `kill -KILL pid`
  7. Process is on the run queue means it is in runnable (R) state.
  8. init process always has PID 1.
  9. Every process has a parent.
  10. You can also trap the EXIT (0) signal with the trap command.
  11. All process in Linux starts with a process called "fork and exec".
  12. A process has PID and file descriptors.
- Describe how the trap statement works
- Write a shell command to locate a specific process is running or not (for example, find out if mysqld process is running or not)?
- Write a shell command that will execute the command vim without forking.
- From vi it is possible to run **date** or **ps aux** command without wasting time spawning another process. Write a vi command syntax to run shell command to execute in same shell.
- How do you use set a trap that will work through out time of script execution.

→ ← exec command	<b>Home</b>	Chapter 9: Functions →
------------------	-------------	------------------------

---

---

# Chapter 9: Functions

---

## Writing your first shell function

---

<a href="#">← Chapter 9: Functions</a>	<b>Home</b>	<a href="#">→ Displaying functions →</a>
--	-------------	--

We humans are certainly an intelligent species. We work with others and we depend on each other for common tasks. For example, you depend on a milkman to deliver milk in milk bottles or cartons. This logic applies to computer programs including shell scripts. When scripts gets complex you need to use divide and conquer technique.

### Shell functions

- Sometime shell scripts get complicated.
- To avoid large and complicated scripts use functions.
- You divide large scripts into a small chunks/entities called **functions**.
- Functions makes shell script modular and easy to use.
- Function avoids repetitive code. For example, `is_root_user()` function can be reused by various shell scripts to determine whether logged on user is root or not.
- Function performs a specific task. For example, add or delete a user account.
- Function used like normal command.
- In other high level programming languages function is also known as procedure, method, subroutine, or routine.

### Writing the `hello()` function

Type the following command at a shell prompt:

```
hello() { echo 'Hello world!' ; }
```

### Invoking the `hello()` function

`hello()` function can be used like normal command. To execute, simply type:

```
hello
```

### Passing the arguments to the `hello()` function

You can pass command line arguments to user defined functions. Define `hello` as follows:

```
hello() { echo "Hello $1, let us be a friend." ; }
```

You can `hello` function and pass an argument as follows:

```
hello Vivek
```

Sample outputs:

```
Hello Vivek, let us be a friend.
```

---

- One line functions inside { ... } must end with a semicolon. Otherwise you get an error on screen:

```
xrpm() { rpm2cpio "$1" | cpio -idmv }
```

Above will not work. However, the following will work (notice semicolon at the end):

```
xrpm() { rpm2cpio "$1" | cpio -idmv; }
```

← Chapter 9: Functions	<b>Home</b>	→ Displaying functions →
---------------------------	-------------	-----------------------------

## Displaying functions

→ ← Writing your first shell function	<b>Home</b>	→ Removing functions →
---------------------------------------	-------------	------------------------

To display defined function names use the declare command. Type the following command at a shell prompt:

```
declare -f
```

Sample outputs:

```
declare -f command_not_found_handle
declare -f genpasswd
declare -f grabmp3
declare -f hello
declare -f mp3
declare -f xrpm
```

### Display Function Source Code

To view function names and source code, enter:

```
declare -f
```

OR

```
declare -f | less
```

Sample outputs:

```
command_not_found_handle ()
{
    if [ -x /usr/lib/command-not-found ]; then
        /usr/bin/python /usr/lib/command-not-found -- $1;
        return $?;
    else
        return 127;
    fi
}
genpasswd ()
{
    local l=$1;
```

```

    [ "$1" == "" ] && l=16;
    tr -dc A-Za-z0-9_ < /dev/urandom | head -c ${l} | xargs
}
grabmp3 ()
{
    local t=$(($HOME/bin/mp3 | sed 's/^n//');
    grep -q "$t" $HOME/out/best.eng.mp3
    if [ $? -ne 0 ]; then
        echo "$t" >> $HOME/out/best.eng.mp3;
        echo "'$t' - added!";
    else
        echo "Duplicate entry found!";
    fi
}
hello ()
{
    echo "Hello $1"
}
mp3 ()
{
    local o=$IFS;
    IFS=$(echo -en "\n\b");
    /usr/bin/beep-media-player "$(cat $@)" & IFS=o
}
xrpm ()
{
    [ "$1" != "" ] && ( rpm2cpio "$1" | cpio -idmv )
}

```

To view a specific function source code, enter:

```

declare -f functionName
declare -f xrpm

```

Notice if you just type the declare command with no arguments, then it will list all declared variables and functions.

## See also

- declare command

→ ← Writing your first shell function	<b>Home</b>	→ Removing functions →
---------------------------------------	-------------	------------------------

# Removing functions

---

<a href="#">→ ← Displaying functions</a>	<b>Home</b>	<a href="#">→ Defining functions →</a>
--	-------------	--

To unset or remove the function use the `→ unset` command as follows:

```
unset -f functionName
unset -f hello
declare
```

## See also

- `→ unset` command
- `declare` command

<a href="#">→ ← Displaying functions</a>	<b>Home</b>	<a href="#">→ Defining functions →</a>
--	-------------	--

# Defining functions

---

<a href="#">→ ← Removing functions</a>	<b>Home</b>	<a href="#">→ Writing functions →</a>
--	-------------	---------------------------------------

To define a function, use the following syntax:

```
name () {
  command1;
  command2
}
```

OR

```
function name () {
  command1;
  command2
}
```

OR

```
function name { command1; command2 }
```

OR

```
name () { command1; command2 }
```

where `name` is the name of the function, and "`command1; command2`" is a list of commands used in the function. You need to replace `name` with actual function name such as `delete_account`:

```
rollback () {
  ...
}
```

```

add_user() {
    ...
}

delete_user() {
    ...
}

```

## Example

Define a function called `mount_nas` and `umount_nas`:

```

# function to mount NAS device
mount_nas() {
    # define variables
    NASMNT=/nas10
    NASSERVER="nas10.nixcraft.net.in"
    NASUSER="vivek"
    NASPASSWORD="myNasAccountPassword"
    [ ! -d $NASMNT ] && /bin/mkdir -p $NASMNT
    mount | grep -q $NASMNT
    [ $? -eq 0 ] || /bin/mount -t cifs //$NASSERVER/$NASUSER -o
username=$NASUSER,password=$NASPASSWORD $NASMNT
}

# function to unmount NAS device
umount_nas() {
    NASMNT=/nas10
    mount | grep -q $NASMNT
    [ $? -eq 0 ] && /bin/umount $NASMNT
}

```

You can type your function at the beginning of the shell script:

```

#!/bin/bash
# define variables
NASMNT=/nas10
....
..
....
# define functions
function umount_nas() {
    /bin/mount | grep -q $NASMNT
    [ $? -eq 0 ] && /bin/umount $NASMNT
}

# another function
function mount_nas() {

```

```

command1
command2
}

....
...
### main logic ##

[ $? -eq 0 ] && { echo "Usage: $0 device"; exit 1; }
...
.....

# When you wish to access function, you use the following format:
umount_nas

```

→ ← Removing functions   **Home**   → Writing functions →

## Writing functions

---

→ ← Defining functions   **Home**   → Calling functions →

- Write shell function:

```

name() {
  command list;
}

```

- The idea is very simple create a modular scripts.
- Place frequently used commands or logic in a script.
- You can call the function whenever it is required rather writing or repeating the same code again.
- You can create a functions file.
  - /etc/init.d/functions is default functions file which contains functions to be used by most or all shell scripts in the /etc/init.d directory. This file can be autoloaded as and when required.
  - You can view /etc/init.d/functions file with the following command:

```
less /etc/init.d/functions
```

- All shell functions are treated as a command.
- You must define a function at the start of a script.
- You must load a function file at the start of a script using source command or by specifying the full path:

```
/path/to/fuctions.sh
```

OR

```
source /path/to/fuctions.sh
```



- You can call function like normal command:

```
name
name arg1 arg2
```

## Write a function at the start of a script

A function must be created before calling. For example, the following script (ftest.sh) will fail:

```
#!/bin/bash
TEST="/tmp/filename"

# call delete_file; fail...
delete_file

# write delete_file()
delete_file(){
    echo "Deleting $TEST..."
}
```

Sample output:

```
./ftest.sh: line 5: delete_file: command not found
```

To avoid such problems write a function at the start of a script. Also, define all variables at the start of a script:

```
#!/bin/bash
# define variables at the start of script
# so that it can be accessed by our function
TEST="/tmp/filename"

# write delete_file() function
delete_file(){
    echo "Deleting $TEST..."
}

# call delete_file
delete_file
```

# Calling functions

→ ← Writing functions	<b>Home</b>	→ Pass arguments into a function →
-----------------------	-------------	------------------------------------

To call or invoke the function, type the name of the function:

```
functionName
```

For example, define and write a function called yday() to display yesterday's date:

```
yday() { date --date='1 day ago'; }
```

To invoke the function yday():

```
yday
```

In the end your program should like as follows:

```
#!/bin/bash
# write the function
yday() {
    date --date='1 day ago'
}
# invoke the function
yday
```

## Putting It All Together

- Create a shell script called nas\_backup.sh.
- Function such as mount\_nas and other get called several times (code reuse).
- The use functions makes script easy to modify and read.
- All functions and variables are created at the start of a script.
- You must declare the variable before any commands attempt to use them.
- This script also demonstrate the use of → here documents, sending an alert email, → command substitution, invoke the command via variables, logging a message to a syslog, and much more.

```
#!/bin/bash
# A shell script to backup MySQL database and directories to a nas
server.
# Written by Vivek Gite <vivek@gite.in>
# Last updated on, Feb-2-2007
#####
#           Variables           #
#####

### SETUP BIN PATHS ###
MKDIR=/bin/mkdir
CP=/bin/cp
GTAR=/bin/tar
```

```
RSYNC=/usr/bin/rsync
MOUNT=/bin/mount
UMOUNT=/bin/umount
GREP=/bin/grep
AWK=/bin/awk
SED=/bin/sed
CUT=/bin/cut
MYSQL=/usr/bin/mysql
MYSQLADMIN=/usr/bin/mysqladmin
MYSQLDUMP=/usr/bin/mysqldump
GZIP=/bin/gzip
LOGGER=/usr/bin/logger
MAILCMD=/bin/mail
DU=/usr/bin/du
RM=/bin/rm

### SETUP NAS LOGIN ###
NASUSER=vivek
NASPASSWORD=MyPassWord
NASERVER=nas10.nixcraft.net.in
NASMNT=/nas10

### ADMIN Notification Email Ids ###
WARN_ADMIN_EMAIL_IDS="user@example.com,user@example.net,vivek@gite.in"

### SETUP MYSQL LOGIN/Password ###
MUSER='root'
MPASS='mySqlLoginPassword'
MHOST="127.0.0.1"

### SETUP MYSQL BACKUP PATHS ###
MBAKPATH=${NASMNT}/mysql

### SETUP TAR BALL BACKUP PATHS ###
TBAKPATH=${NASMNT}/tarballs

### Setup file system dirs to backup ###
TAR_SRC_DIRS='/etc /var/named/chroot /root /home /var/www/html
/usr/local/mailboxes'

### Date format dd-mm-yyyy ###
NOW=$(date +"%d-%m-%Y")

### Time format hh_mm_ssAM|PM ###
TIME_FORMAT='%H_%M_%S%P'

#####
```

```

# User Defined Functions      #
#####

#
# Purpose: Send warning email.
#
tar_warn_email(){
    $LOGGER "$ (basename $0) GNU/tar: *** Failed at $(date) ***"
    $MAILCMD -s "GNU/TAR Backup Failed" "${WARN_ADMIN_EMAIL_IDS}"<<EOF
GNU/Tar backup failed @ $(date) for $(hostname)
EOF
}

#
# Purpose: Backup file system directories.
#
backup_tar(){
    $LOGGER "$ (basename $0) GNU/tar: Started at $(date)"
    # call function to mount nas device
    mount_nas
    [ ! -d ${TBAKPATH}/${NOW}/ ] && $MKDIR -p ${TBAKPATH}/${NOW}/
    local path="${TBAKPATH}/${NOW}/fs-$(date
+ "${TIME_FORMAT}").tar.gz"
    $GTAR --exclude "*/proc/*" --exclude "*/dev/*" --exclude
'*/cache/*' -zcvf $path $TAR_SRC_DIRS
    [ $? -ne 0 ] && tar_warn_email
    # call function to unmount nas device
    umount_nas
    $LOGGER "$ (basename $0) GNU/tar: Ended at $(date)"
}

#
# Purpose: Mount backup nas device.
#
mount_nas(){
    [ ! -d $NASMNT ] && $MKDIR -p $NASMNT
    $MOUNT | $GREP $NASMNT >/dev/null
    [ $? -eq 0 ] || $MOUNT -t cifs //$NASSEVER/$NASUSER -o
username=$NASUSER,password=$NASPASSWORD $NASMNT
}

#
# Purpose: Unmount backup nas device.
#
umount_nas(){
    $MOUNT | $GREP $NASMNT >/dev/null
    [ $? -eq 0 ] && $UMOUNT $NASMNT
}

#

```

```

# Purpose: Backup mysql database.
#
mysql () {
    $LOGGER "$(basename $0) mysql: Started at $(date)"
    local DBS="$($MYSQL -u $MUSER -h $MHOST -p$MPASS -Bse 'show
databases')"
    local db=""
    local linkname=""
    [ ! -d $MBAKPATH/$NOW ] && $MKDIR -p $MBAKPATH/$NOW
    for db in $DBS
    do
        [ "$db" == "sgopenxadserver" ] && continue
        local tTime=$(date +"${TIME_FORMAT}")
        local FILE="$MBAKPATH/$NOW/${db}.${tTime}.gz"
        $MYSQLDUMP -u $MUSER -h $MHOST -p$MPASS $db | $GZIP -9 >
$FILE

        #create latest file link
        linkname="$MBAKPATH/$NOW/${db}.latest"
        [ -L $linkname ] && /bin/rm $linkname
        /bin/ln -s $FILE $linkname
    done
    $LOGGER "$(basename $0) mysql: Ended at $(date)"
}

#
# Purpose: Wrapper function to call other functions.
#
backup_mysql () {
    mount_nas          # call function to mount nas device
    mysql
    umount_nas         # call function to unmount nas device
}

#####
# Main Script Logic Starts Here #
#####
case "$1" in
    mysql)
        backup_mysql
        ;;
    fsbak)
        backup_tar
        ;;
    mount)
        mount_nas
        ;;
    umount)

```

```

        umount_nas
        ;;
    *)
        echo "Usage: $0 {mysql|fsbak|mount|umount}"
        echo ""
        echo "Use this shell script to backup mysql database
and directories to backup nas server."
    esac

```

You can run this script as follows to make a mysql database backup:

```
./nas_backup.sh mysql
```

To make a file system backup, enter:

```
./nas_backup.sh fsbak
```

→ ← Writing functions	<b>Home</b>	→ Pass arguments into a function →
-----------------------	-------------	------------------------------------

## Pass arguments into a function

→ ← Calling functions	<b>Home</b>	→ local variable →
-----------------------	-------------	--------------------

- Shell functions have their own command line argument.
- Use variable \$1, \$2..\$n to access argument passed to the function.
- The syntax is as follows:

```

name () {
    arg1=$1
    arg2=$2
    command on $arg1
}

```

- To invoke the the function use the following syntax:

```
name foo bar
```

Where,

1. **name** = function name.
2. **foo** = Argument # 1 passed to the function (positional parameter # 1).
3. **bar** = Argument # 2 passed to the function.

## Example

Create a function called fresh.sh:

```
#!/bin/bash

# write a function
fresh(){
    # t stores $1 argument passed to fresh()
    t=$1
    echo "fresh(): \$0 is $0"
    echo "fresh(): \$1 is $1"
    echo "fresh(): \$t is $t"
    echo "fresh(): total args passed to me $#"
```

Save and close the file. Run it as follows:

```
chmod +x fresh.sh
./fresh.sh
```

Sample outputs:

```
**** calling fresh() 1st time ****
fresh(): $0 is /tmp/x
fresh(): $1 is Tomato
fresh(): $t is Tomato
fresh(): total args passed to me 1
fresh(): all args ($@) passed to me -"Tomato"
fresh(): all args ($*) passed to me -"Tomato"
**** calling fresh() 2nd time ****
fresh(): $0 is /tmp/x
fresh(): $1 is Tomato
fresh(): $t is Tomato
fresh(): total args passed to me 3
fresh(): all args ($@) passed to me -"Tomato Onion Paneer"
fresh(): all args ($*) passed to me -"Tomato Onion Paneer"
```

## Function shell variables

- All function parameters or arguments can be accessed via \$1, \$2, \$3,..., \$N.
- \$0 always point to the shell script name.
- \$\* or @\$ holds all parameters or arguments passed to the function.
- \$# holds the number of positional parameters passed to the function.

## Example

Create a shell script to determine if given name is file or directory (cmdargs.sh):

```
#!/bin/bash
file="$1"

# User-defined function
is_file_dir(){
    # $f is local variable
    local f="$1"
    # file attributes comparisons using test i.e. [ ... ]
    [ -f "$f" ] && { echo "$f is a regular file."; exit 0; }
    [ -d "$f" ] && { echo "$f is a directory."; exit 0; }
    [ -L "$f" ] && { echo "$f is a symbolic link."; exit 0; }
    [ -x "$f" ] && { echo "$f is an executeble file."; exit 0; }
}

# make sure filename supplied as command line arg else die
[ $# -eq 0 ] && { echo "Usage: $0 filename"; exit 1; }

# invoke the is_file_dir and pass $file as arg
is_file_dir "$file"
```

Run it as follows:

```
./cmdargs.sh /etc/resolv.conf
./cmdargs.sh /bin/date
./cmdargs.sh $HOME
./cmdargs.sh /sbin
```

Sample outputs:

```
/etc/resolv.conf is a regular file.
/bin/date is a regular file.
/home/vivek is a directory.
/sbin is a directory.
```

→ ← Calling functions	<b>Home</b>	→ local variable
		→



# Local variable

---

→ ← Pass arguments into a function   **Home**   → Returning from a function →

- By default all variables defined before function names are global to functions.
- You can modify the variables in function and the original values will be lost.
- This can be result into problem. For example, create a shell script called fvar.sh:

```
#!/bin/bash
d=/apache.jail

create_jail(){
    d=$1
    echo "create_jail(): d is set to $d"
}

echo "Before calling create_jail d is set to $d"

create_jail "/home/apache/jail"

echo "After calling create_jail d is set to $d"
```

Save and close the file. Run it as follows:

```
chmod +x fvar.sh
./fvar.sh
```

Sample outputs:

```
Before calling create_jail d is set to /apache.jail
create_jail(): d is set to /home/apache/jail
After calling create_jail d is set to /home/apache/jail
```

## local command

- You can create a local variables using the local command and syntax is:

```
local var=value
local varName
```

OR

```
function name() {
    local var=$1
    command1 on $var
}
```

- local command can only be used within a function.
- It makes the variable name have a **visible scope restricted to that function** and its children only. The following is an updated version of the above script:

```
#!/bin/bash
# global d variable
d=/apache.jail

# User defined function
create_jail(){
    # d is only visible to this function
    local d=$1
    echo "create_jail(): d is set to $d"
}

echo "Before calling create_jail d is set to $d"

create_jail "/home/apache/jail"

echo "After calling create_jail d is set to $d"
```

Sample output:

```
Before calling create_jail d is set to /apache.jail
create_jail(): d is set to /home/apache/jail
After calling create_jail d is set to /home/apache/jail
```

## Example

In the following example:

- The declare command is used to create → the constant variable called PASSWD\_FILE.
- The function die() is defined before all other functions.
- You can call a function from the same script or other function. For example, die() is called from is\_user\_exist().
- All function → variables are local. This is a good programming practice.

```
#!/bin/bash
# Make readonly variable i.e. constant variable
declare -r PASSWD_FILE=/etc/passwd

#
# Purpose: Display message and die with given exit code
#
die(){
    local message="$1"
    local exitCode=$2
    echo "$message"
    [ "$exitCode" == "" ] && exit 1 || exit $exitCode
}

#
# Purpose: Find out if user exists or not
#
is_user_exist(){
```

```
    local u=$1
    grep -qEw "^$u" $PASSWD_FILE && die "Username $u exists."
}

#
# Purpose: Is script run by root? Else die..
#
is_root_user(){
    [ "$(id -u)" != "0" ] && die "You must be root to run this script" 2
}

#
# Purpose: Display usage
#
usage(){
    echo "Usage: $0 username"
    exit 2
}

[ $# -eq 0 ] && usage

# invoke the function is_root_user
is_root_user

# call the function is_user_exist
is_user_exist "$1"

# display something on screen
echo "Adding user $1 to database..."
# just display command but do not add a user to system
echo "/sbin/useradd -s /sbin/bash -m $1"
```

→ ← Pass arguments into a function	<b>Home</b>	→ Returning from a function →
------------------------------------	-------------	-------------------------------

# Returning from a function

→ ← local variable	<b>Home</b>	→ Shell functions library →
--------------------	-------------	-----------------------------

- In mathematics a function  $f$  takes an input,  $x$ , and returns an output  $f(x)$ .
- In computer a shell function name can take an input,  $\$1$  and return back the value (true or false) to the script.
- In other words, you can return from a function with  $\rightarrow$  an exit status.

## Syntax

- The return command causes a function to exit with the return value specified by  $N$  and syntax is:

```
return N
```

- If  $N$  is not specified, the return  $\rightarrow$  status is that of the last command.
- The return command terminates the function.

## Example

Create a shell script called `isroot.sh` as follows:

```
#!/bin/bash
# version 1.0

# Purpose: Determine if current user is root or not
is_root_user(){
  [ $(id -u) -eq 0 ] && return 0 || return 1
}

# invoke the function
# make decision using conditional logical operators
is_root_user && echo "You can run this script." || echo "You need to
run this script as a root user."
```

Save and close the file. Run it as follows:

```
chmod +x isroot.sh
./isroot.sh
```

Sample outputs:

```
You need to run this script as a root user.
```

Run it as the root user:

```
sudo ./isroot.sh
```

Sample outputs:

```
[sudo] password for vivek:
You can run this script.
```

The following is an updated version of the same script. This version → create the constants variables using the declare command called TRUE and FALSE.

```
#!/bin/bash
# version 2.0
# define constants
declare -r TRUE=0
declare -r FALSE=1

# Purpose: Determine if current user is root or not
is_root_user(){
    # root user has user id (UID) zero.
    [ $(id -u) -eq 0 ] && return $TRUE || return $FALSE
}

is_root_user && echo "You can run this script." || echo "You need to
run this script as a root user."
```

## Returning a string or word from a function

- You cannot return a word or anything else from a function.
- However, you can use echo or printf command to send back output easily to the script.

```
#!/bin/bash
# Variables
domain="CyberCiti.BIz"
out=""

#####
# Purpose: Converts a string to lower case
# Arguments:
#   $@ -> String to convert to lower case
#####
function to_lower()
{
    local str="$@"
    local output
    output=$(tr ' [A-Z]' ' [a-z]'<<<"${str}")
    echo $output
}

# invoke the to_lower()
to_lower "This Is a TEST"

# invoke to_lower() and store its result to $out variable
out=$(to_lower ${domain})
```

```
# Display back the result from $out
echo "Domain name : $out"
```

→ ← local variable	<b>Home</b>	→ Shell functions library →
-----------------------	-------------	-----------------------------

## Shell functions library

→ ← Returning from a function	<b>Home</b>	→ Source command →
-------------------------------	-------------	-----------------------

- You can store all your function in a function files called functions library.
- You can load all function into the current script or the command prompt.
- The syntax is as follows to load all functions:

```
./path/to/your/functions.sh
```

### Example

Create a function file called myfunctions.sh:

```
#!/bin/bash
# set variables
declare -r TRUE=0
declare -r FALSE=1
declare -r PASSWD_FILE=/etc/passwd

#####
# Purpose: Converts a string to lower case
# Arguments:
# $1 -> String to convert to lower case
#####
function to_lower()
{
    local str="$@"
    local output
    output=$(tr '[A-Z]' '[a-z]'<<<"${str}")
    echo $output
}

#####
# Purpose: Display an error message and die
# Arguments:
# $1 -> Message
# $2 -> Exit status (optional)
#####
function die()
```

```

{
    local m="$1"      # message
    local e=${2-1}   # default exit status 1
    echo "$m"
    exit $e
}

#####
# Purpose: Return true if script is executed by the root user
# Arguments: none
# Return: True or False
#####
function is_root()
{
    [ $(id -u) -eq 0 ] && return $TRUE || return $FALSE
}

#####
# Purpose: Return true $user exists in /etc/passwd
# Arguments: $1 (username) -> Username to check in /etc/passwd
# Return: True or False
#####
function is_user_exists()
{
    local u="$1"
    grep -q "^${u}" $PASSWD_FILE && return $TRUE || return $FALSE
}

```

You can load myfunctions.sh into the current shell environment, enter:

```
. myfunctions.sh
```

OR

```
. /path/to/myfunctions.sh
```

## How do I load myfunctions.sh into the script?

Create a script called functionsdemo.sh:

```

#!/bin/bash
# Load the myfunctions.sh
# My local path is /home/vivek/lsst2/myfunctions.sh
. /home/vivek/lsst2/myfunctions.sh

# Define local variables
# var1 is not visitable or used by myfunctions.sh
var1="The Mahabharata is the longest and, arguably, one of the greatest
    epic poems in any language."

```

```
# Invoke the is_root()
is_root && echo "You are logged in as root." || echo "You are not
logged in as root."

# Find out if user account vivek exists or not
is_user_exists "vivek" && echo "Account found." || echo "Account not
found."

# Display $var1
echo -e "*** Original quote: \n${var1}"

# Invoke the to_lower()
# Pass $var1 as arg to to_lower()
# Use command substitution inside echo
echo -e "*** Lowercase version: \n$(to_lower ${var1})"
```

Save and close the file. Run it as follows:

```
chmod +x functionsdemo.sh
./functionsdemo.sh
```

Sample outputs:

```
You are not logged in as root.
Account found.
*** Original quote:
The Mahabharata is the longest and, arguably, one of the greatest epic
poems in any language.
*** Lowercase version:
the mahabharata is the longest and, arguably, one of the greatest epic
poems in any language.
```

→ ← Returning from a function	<b>Home</b>	→ Source command →
-------------------------------	-------------	-----------------------



# Source command

---

→ ← Shell functions library **Home** → Recursive function →

- The source command can be used to load any functions file into the current shell script or a command prompt.
- It read and execute commands from given FILENAME and return.
- The pathnames in \$PATH are used to find the directory containing FILENAME. If any ARGUMENTS are supplied, they become the positional parameters when FILENAME is executed.
- The syntax is as follows:

```
source functions.sh
source /path/to/functions.sh
source functions.sh WWWROOT=/apache.jail PHPROOT=/fastcgi.php_jail
```

- Our previous example can be updated using source command as follows:

```
#!/bin/bash
# load myfunctions.sh function file
source /home/vivek/lsst2/myfunctions.sh

# local variable
quote="He WHO Sees me in all things, and ALL things in me, is never far
from me, and I am never far from him."

# invoke is_root()
is_root && echo "You are a superuser." || echo "You are not a
superuser."

# call to_lower() with ${quote}
to_lower ${quote}
```

→ ← Shell functions library **Home** → Recursive function →

# Recursive function

---

→ ← Source command	<b>Home</b>	→ Putting functions in background →
--------------------	-------------	-------------------------------------

- A recursive function is a function that **repeatedly calls itself**.
- **No limit** is placed on the number of *recursive calls*.
- Create a shell script called fact.sh:

```
#!/bin/bash
# fact.sh - Shell script to find factorial of given command line arg
factorial() {
    local i=$1
    local f
    declare -i i
    declare -i f

    # factorial() is called until the value of $f is returned and is it
    is <= 2
    # This is called the recursion
    [ $i -le 2 ] && echo $i || { f=$(( i - 1 )); f=$(factorial $f); f=$((
f * i )); echo $f; }
}

# display usage
[ $# -eq 0 ] && { echo "Usage: $0 number"; exit 1; }

# call factorial
factorial $1
```

Save and close the file. Run it as follows:

```
chmod +x fact.sh
./fact.sh
./fact.sh 2
./fact.sh 5
```

Sample outputs:

```
2
120
```

- You can → debug the script as follows:

```
bash -x ./fact.sh 5
```

Sample outputs:

```
+ '[' 1 -eq 0 ']'
+ factorial 5
+ local i=5
+ local f
+ declare -i i
+ declare -i f
+ [[ 5 -le 2 ]]
+ f=4
++ factorial 4
++ local i=4
++ local f
++ declare -i i
++ declare -i f
++ [[ 4 -le 2 ]]
++ f=3
+++ factorial 3
+++ local i=3
+++ local f
+++ declare -i i
+++ declare -i f
+++ [[ 3 -le 2 ]]
+++ f=2
++++ factorial 2
++++ local i=2
++++ local f
++++ declare -i i
++++ declare -i f
++++ [[ 2 -le 2 ]]
++++ echo 2
+++ f=2
+++ f=6
+++ echo 6
++ f=6
++ f=24
++ echo 24
+ f=24
+ f=120
+ echo 120
120
```

- Recursive functions are **slow** under bash.
- Avoid using recursive functions if possible.
- For serious **number crunching** take a look at the GNU C/C++/Fortran Compiler Collection (GCC).

## External links

- [Wikipedia:Recursion \(computer science\)](#)
- [GNU C/C++/Fortran <sup>\[1\]</sup> Compiler Collection.](#)

<a href="#">← Source command</a>	<b>Home</b>	<a href="#">→ Putting functions in background →</a>
----------------------------------	-------------	---

## References

- [1] <http://gcc.gnu.org/>

# Putting functions in background

---

<a href="#">← Recursive function</a>	<b>Home</b>	<a href="#">→ Chapter 9 Challenges →</a>
--------------------------------------	-------------	--

- The & operator puts command in background and free up your terminal.
- You can also put a **function in background**.

## How Do I Put a Function In Background?

- The syntax is as follows:

```
name () {
    echo "Do something"
    sleep 1
}

# put a function in the background
name &

# do something
```

## Example

- You can display a series of dots (progress bar) while performing tape backup. This is useful for the user or operator to display a progress bar.
- Create a shell script called `progressdots.sh`<sup>[1]</sup>:

```
#!/bin/bash
# progressdots.sh - Display progress while making backup
# Based on idea presnted by nixCraft forum user rockdalinux
# Show progress dots
progress() {
    echo -n "$0: Please wait..."
    while true
    do
        echo -n "."
        sleep 5
    done
}
```

```
done
}

dobackup() {
    # put backup commands here
    tar -zcvf /dev/st0 /home >/dev/null 2>&1
}

# Start it in the background
progress &

# Save progress() PID
# You need to use the PID to kill the function
MYSELF=$!

# Start backup
# Transfer control to dobackup()
dobackup

# Kill progress
kill $MYSELF >/dev/null 2>&1

echo -n "...done."
echo
```

Save and close the file. Run it as follows:

```
chmod +x progressdots.sh
./progressdots.sh
```

Sample outputs:

```
./progressdots.sh: Please wait.....done.
```

## External links

- [Bar](#)<sup>[2]</sup> is a simple tool to copy a stream of data and print a display for the user on stderr showing (a) the amount of data passed, (b) the throughput of the data transfer, and (c) the transfer time, or, if the total size of the data stream is known, the estimated time remaining, what percentage of the data transfer has been completed, and a progress bar.
- [pv](#)<sup>[3]</sup> (Pipe Viewer) is a terminal-based tool for monitoring the progress of data through a pipeline.
- → [dialog](#) - Another way to add a progress bar to your script using `dialog --gauge`.

## References

- [1] Shell Script To Show Progress Indicators / Dots While Making The Backups (<http://nixcraft.com/getting-started-tutorials/13664-shell-script-show-progress-indicators-dots-while-making-backups.html>) from the nixCraft forum.
- [2] <http://clpbar.sourceforge.net/>
- [3] <http://www.ivarch.com/programs/pv.shtml>

→ ← Recursive function	<b>Home</b>	→ Chapter 9 Challenges →
------------------------	-------------	-----------------------------

## Chapter 9 Challenges

---

→ ← Recursive function	<b>Home</b>	[[ →]]
------------------------	-------------	-----------

- Decide whether the following sentence is true or false:
  1. The function file does not need to be executable.
  2. The function is treated the same as other shell command.
  3. To invoke the function, just type the name of the function.
  4. You must create a function at the start of a script.
  5. You must write a function before invoking it.
  6. All single line function must follow the final command with a semicolon.
  7. A recursive function is a function that repeatedly calls itself.
  8. The return command return from a function with an exit status.
  9. The { list; } also creates a function. ( [ \$# -eq 0 ] && { echo "I'm function"; exit 1; } )
  10. Bash does support pointer arithmetic, and indirect referencing just like C programs.
- Create user-defined functions in a shell script for the following tasks:
  1. add\_user() - Add a user to the system.
  2. add\_group() - Add a group to the system.
  3. change\_password() - Change user password.
  4. delete\_user() - Remove a user from the system.

→ ← Recursive function	<b>Home</b>	[[ →]]
------------------------	-------------	-----------

---

# Chapter 10: Interactive Scripts

---

## Menu driven scripts

---

- You use some sort of generic application menu everyday.
- A menu is nothing but a list of commands presented to a user by a shell script.
- For example, you can write a menu driven shell script to get the terminal information. The menu driven shell script works as "shortcuts to frequently used commands that avoid the user having to remember syntax".
- Usually, you need to type the instructions or commands to complete the task.
- Command input can be done with the help of menus.

### Syntax

```
#!/bin/bash
# A menu driven shell script sample template
## -----
# Step #1: Define variables
# -----
EDITOR=vim
PASSWD=/etc/passwd
RED='\033[0;41;30m'
STD='\033[0;0;39m'

# -----
# Step #2: User defined function
# -----
function one() {
    echo "one() called"
}

# do something in two()
function two() {
    echo "two() called"
}

# function to display menus
function show_menus() {
    clear
    echo "~~~~~"
    echo " M A I N - M E N U "
    echo "~~~~~"
    echo "1. Set Terminal"
    echo "2. Reset Terminal"
    echo "3. Exit"
}
```

```
# read input from the keyboard and take a action
# invoke the one() when the user select 1 from the menu option.
# invoke the two() when the user select 2 from the menu option.
# Exit when user the user select 3 form the menu option.
function read_options(){
    local choice
    read -p "Enter choice [ 1 - 3] " choice
    case $choice in
        1) one ;;
        2) two ;;
        3) exit 0;;
        *) echo -e "${RED}Error...${STD}" && sleep 2
    esac
}

# -----
# Step #3: Trap CTRL+C, CTRL+Z and quit singles
# -----
trap '' SIGINT SIGQUIT SIGTSTP

# -----
# Step #4: Main logic - infinite loop
# -----
while true
do

    show_menus
    read_options
done
```



# Getting information about your system

---

- Create a script called grabsysinfo.sh:

```
#!/bin/bash
# grabsysinfo.sh - A simple menu driven shell script to to get
information about your
# Linux server / desktop.
# Author: Vivek Gite
# Date: 12/Sep/2007

# Define variables
LSB=/usr/bin/lsb_release

# Purpose: Display pause prompt
# $1-> Message (optional)
function pause() {
    local message="$@"
    [ -z $message ] && message="Press [Enter] key to continue..."
    read -p "$message" readEnterKey
}

# Purpose - Display a menu on screen
function show_menu() {
    date
    echo "-----"
    echo "    Main Menu"
    echo "-----"
    echo "1. Operating system info"
    echo "2. Hostname and dns info"
    echo "3. Network info"
    echo "4. Who is online"
    echo "5. Last logged in users"
    echo "6. Free and used memory info"
    echo "7. exit"
}

# Purpose - Display header message
# $1 - message
function write_header() {
    local h="$@"
    echo
    "-----"
    echo "    ${h}"
    echo
    "-----"
}
```

```
# Purpose - Get info about your operating system
function os_info(){
    write_header " System information "
    echo "Operating system : $(uname)"
    [ -x $LSB ] && $LSB -a || echo "$LSB command is not installed (set
    \ $LSB variable)"
    #pause "Press [Enter] key to continue..."
    pause
}

# Purpose - Get info about host such as dns, IP, and hostname
function host_info(){
    local dnsips=$(sed -e '/^$/d' /etc/resolv.conf | awk '{if
    (tolower($1)=="nameserver") print $2}')
    write_header " Hostname and DNS information "
    echo "Hostname : $(hostname -s)"
    echo "DNS domain : $(hostname -d)"
    echo "Fully qualified domain name : $(hostname -f)"
    echo "Network address (IP) : $(hostname -i)"
    echo "DNS name servers (DNS IP) : ${dnsips}"
    pause
}

# Purpose - Network interface and routing info
function net_info(){
    devices=$(netstat -i | cut -d" " -f1 | egrep -v
    "^Kernel|Iface|lo")
    write_header " Network information "
    echo "Total network interfaces found : $(wc -w <<<${devices})"

    echo "*** IP Addresses Information ***"
    ip -4 address show

    echo "*****"
    echo "*** Network routing ***"
    echo "*****"
    netstat -nr

    echo "*****"
    echo "*** Interface traffic information ***"
    echo "*****"
    netstat -i

    pause
}
```

```

# Purpose - Display a list of users currently logged on
#           display a list of receltly logged in users
function user_info(){
    local cmd="$1"
    case "$cmd" in
        who) write_header " Who is online "; who -H; pause ;;
        last) write_header " List of last logged in users "; last ;
    pause ;;
    esac
}

# Purpose - Display used and free memory info
function mem_info(){
    write_header " Free and used memory "
    free -m

    echo "*****"
    echo "*** Virtual memory statistics ***"
    echo "*****"
    vmstat

    echo "*****"
    echo "*** Top 5 memory eating process ***"
    echo "*****"
    ps auxf | sort -nr -k 4 | head -5
    pause
}

# Purpose - Get input via the keyboard and make a decision using
case..esac
function read_input(){
    local c
    read -p "Enter your choice [ 1 - 7 ] " c
    case $c in
        1)    os_info ;;
        2)    host_info ;;
        3)    net_info ;;
        4)    user_info "who" ;;
        5)    user_info "last" ;;
        6)    mem_info ;;
        7)    echo "Bye!"; exit 0 ;;
        *)

            echo "Please select between 1 to 7 choice only."
            pause
    esac
}

# ignore CTRL+C, CTRL+Z and quit singles using the trap
trap '' SIGINT SIGQUIT SIGTSTP

```

```
# main logic
while true
do
    clear
    show_menu      # display menu
    read_input    # wait for user input
done
```

Save and close the file. Run it as follows:

```
chmod +x grabsysinfo.sh
./grabsysinfo.sh
```

Sample

outputs:

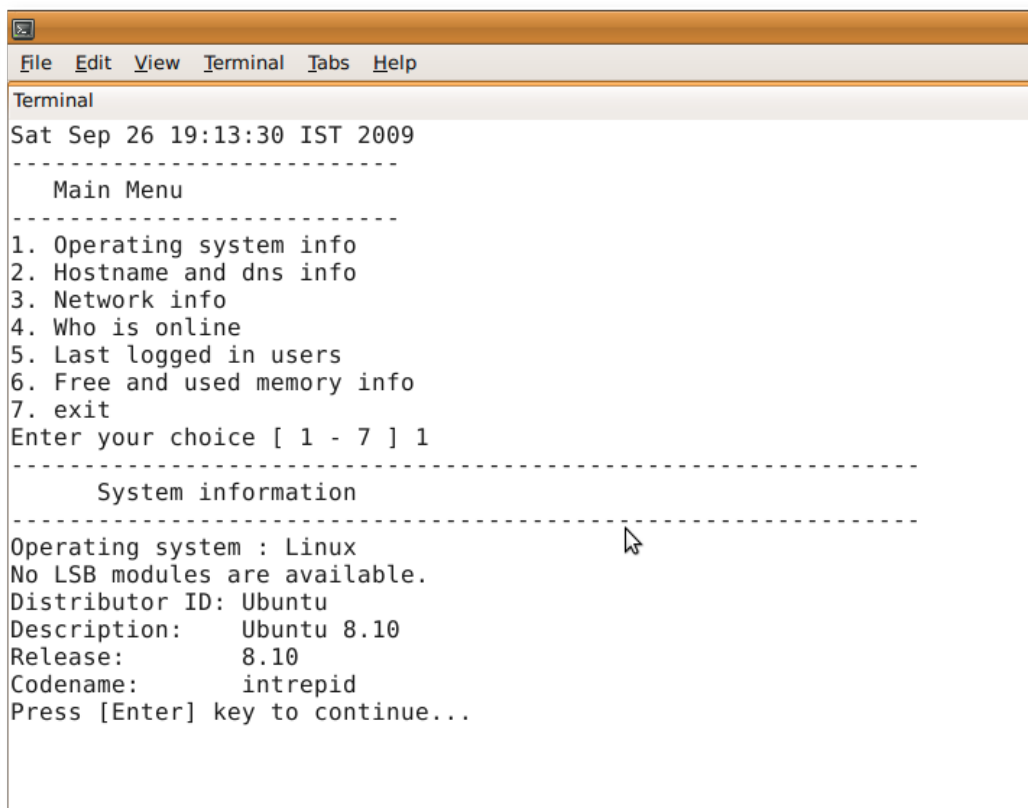

```
Terminal
Sat Sep 26 19:13:30 IST 2009
-----
      Main Menu
-----
1. Operating system info
2. Hostname and dns info
3. Network info
4. Who is online
5. Last logged in users
6. Free and used memory info
7. exit
Enter your choice [ 1 - 7 ] 1
-----
      System information
-----
Operating system : Linux
No LSB modules are available.
Distributor ID: Ubuntu
Description:     Ubuntu 8.10
Release:        8.10
Codename:       intrepid
Press [Enter] key to continue...
```

# Bash display dialog boxes

- The dialog command allows you to display a variety of questions or display messages using dialog boxes from a shell script.
- Use the dialog utility for creating TTY (terminal) dialog boxes.

## Install dialog command

Type the following command to install the dialog command line utility under Debian or Ubuntu Linux:

```
sudo apt-get update
sudo apt-get install dialog
```

Type the following command to install the dialog command line utility under CentOS or Redhat Linux:

```
yum install dialog
```

## Syntax

The syntax is as follows:

```
dialog --common-options --boxType "Text" Height Width
--box-specific-option
```

- --common-options are used to set dialog boxes background color, title, etc.
- All dialog boxes have at least three parameters:
  - "Text" : The caption or contents of the box.
  - height : The height of the dialog box.
  - width : The width of the dialog box.

## Your first dialog

Type the following command at a shell prompt:

```
dialog --title "Hello" --msgbox 'Hello world!' 6 20
```

1. A message box is displayed on the screen with a single OK button.
2. You can use this dialog box to display any message you like.
3. After reading the message, the user can press the ENTER key so that dialog will exit and the calling shell script can continue its operation.
4. If the message is too large for the space, dialog may allow you to scroll it. In this case, a percentage is shown in the base of the widget.
5. On exit, no text is written to dialog's output. Only an "OK" button is provided for input, but an ESC exit status may be returned.



## Understanding dialog options

- **--title "Hello"** : Set a "title string" (caption) to be displayed at the top of the dialog box. In this example, set a title string to "Hello".
- **--msgbox 'Hello world!'** : Create a message box with "Hello world!" message.
- **6** : Set the height of the msgbox box.
- **20** : Set the width of the msgbox box.

## Setting backtitle

You can set a backtitle string to be displayed on the backdrop, at the top of the screen using the `--backtitle "Title"` syntax:

```
dialog --backtitle "System Information" \  
--title "About" \  
--msgbox 'This is an entirely open source software.' 10 30
```

## Positioning the box

The `--begin y x` option can be used to set the position of the upper left corner of a dialog box on the screen.

```
dialog --begin 10 30 --backtitle "System Information" \  
--title "About" \  
--msgbox 'This is an entirely open source software.' 10 30
```

Where,

- `--begin 10 30`: 10 is y i.e. horizontal position and 30 is vertical position.

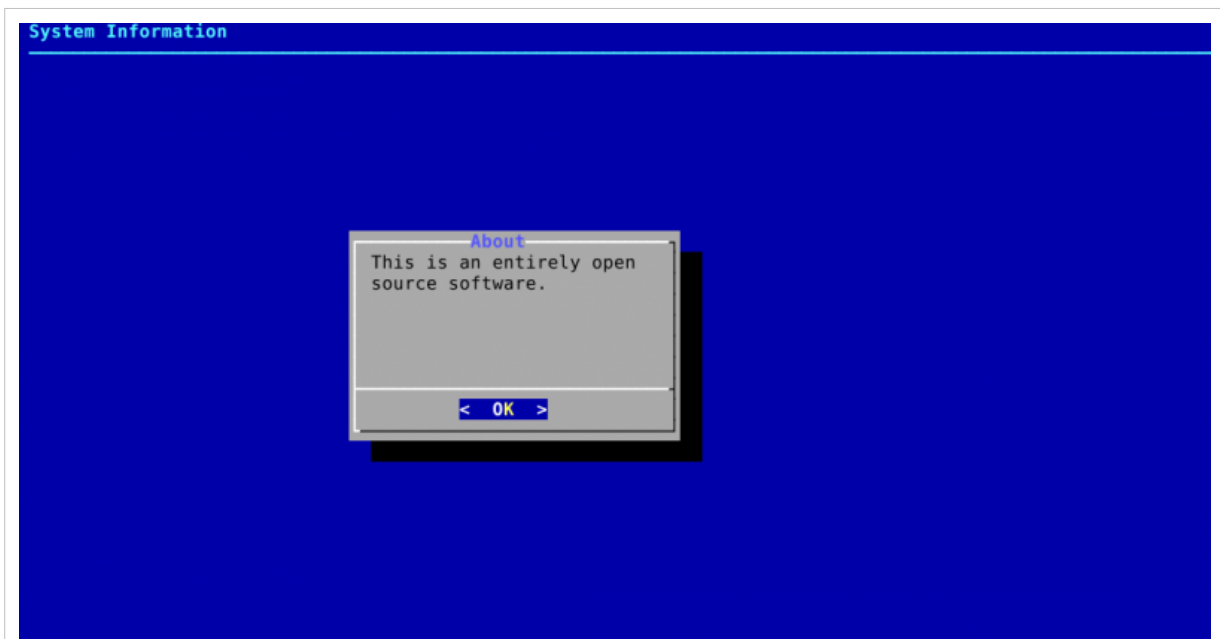

Dialog command with y x position and backtitle

## Common dialog boxes and their options

Box options:

```
--calendar      <text> <height> <width> <day>
<month> <year>
--checklist     <text> <height> <width> <list
height> <tag1> <item1> <status1>...
--dselect      <directory> <height> <width>
--editbox      <file> <height> <width>
--fselect      <filepath> <height> <width>
--gauge        <text> <height> <width>
[<percent>]
--infobox      <text> <height> <width>
--inputbox     <text> <height> <width>
[<init>]
--inputmenu    <text> <height> <width> <menu
height> <tag1> <item1>...
--menu         <text> <height> <width> <menu
height> <tag1> <item1>...
--msgbox       <text> <height> <width>
--passwordbox  <text> <height> <width>
[<init>]
--pause       <text> <height> <width>
<seconds>
--progressbox <height> <width>
--radiolist   <text> <height> <width> <list
height> <tag1> <item1> <status1>...
--tailbox     <file> <height> <width>
--tailboxbg   <file> <height> <width>
--textbox     <file> <height> <width>
--timebox     <text> <height> <width> <hour>
<minute> <second>
--yesno       <text> <height> <width>
```

# Dialog customization with configuration file

---

- You can customize various aspects of the dialog command with ~/.dialogrc file.
- \$HOME/.dialogrc is a default configuration file.

## How do I create a sample ~/.dialogrc file?

Type the following command:

```
dialog --create-rc ~/.dialogrc
```

To customize ~/.dialogrc, enter:

```
vi ~/.dialogrc
```

Turn on shadow dialog boxes

```
use_shadow = ON
```

Turn on color support ON

```
use_colors = ON
```

Change default blue background color to BLACK

```
screen_color = (CYAN, BLACK, ON)
```

Save and close the file. Here is my sample configuration file:

```
#
# Run-time configuration file for dialog
#
# Automatically generated by "dialog --create-rc <file>"
#
#
# Types of values:
#
# Number      - <number>
# String      - "string"
# Boolean     - <ON|OFF>
# Attribute   - (foreground,background,highlight?)

# Set aspect-ration.
aspect = 0

# Set separator (for multiple widgets output).
separate_widget = ""

# Set tab-length (for textbox tab-conversion).
tab_len = 0
```



```
# Make tab-traversal for checklist, etc., include the list.
visit_items = OFF

# Shadow dialog boxes? This also turns on color.
use_shadow = ON

# Turn color support ON or OFF
use_colors = ON

# Screen color
screen_color = (CYAN, GREEN, ON)

# Shadow color
shadow_color = (BLACK, BLACK, ON)

# Dialog box color
dialog_color = (BLACK, WHITE, OFF)

# Dialog box title color
title_color = (BLUE, WHITE, ON)

# Dialog box border color
border_color = (WHITE, WHITE, ON)

# Active button color
button_active_color = (WHITE, BLUE, ON)

# Inactive button color
button_inactive_color = (BLACK, WHITE, OFF)

# Active button key color
button_key_active_color = (WHITE, BLUE, ON)

# Inactive button key color
button_key_inactive_color = (RED, WHITE, OFF)

# Active button label color
button_label_active_color = (YELLOW, BLUE, ON)

# Inactive button label color
button_label_inactive_color = (BLACK, WHITE, ON)

# Input box color
inputbox_color = (BLACK, WHITE, OFF)

# Input box border color
inputbox_border_color = (BLACK, WHITE, OFF)
```

```
# Search box color
searchbox_color = (BLACK,WHITE,OFF)

# Search box title color
searchbox_title_color = (BLUE,WHITE,ON)

# Search box border color
searchbox_border_color = (WHITE,WHITE,ON)

# File position indicator color
position_indicator_color = (BLUE,WHITE,ON)

# Menu box color
menubox_color = (BLACK,WHITE,OFF)

# Menu box border color
menubox_border_color = (WHITE,WHITE,ON)

# Item color
item_color = (BLACK,WHITE,OFF)

# Selected item color
item_selected_color = (WHITE,BLUE,ON)

# Tag color
tag_color = (BLUE,WHITE,ON)

# Selected tag color
tag_selected_color = (YELLOW,BLUE,ON)

# Tag key color
tag_key_color = (RED,WHITE,OFF)

# Selected tag key color
tag_key_selected_color = (RED,BLUE,ON)

# Check box color
check_color = (BLACK,WHITE,OFF)

# Selected check box color
check_selected_color = (WHITE,BLUE,ON)

# Up arrow color
uarrow_color = (GREEN,WHITE,ON)

# Down arrow color
```

```
darrow_color = (GREEN,WHITE,ON)

# Item help-text color
itemhelp_color = (WHITE,BLACK,OFF)

# Active form text color
form_active_text_color = (WHITE,BLUE,ON)

# Form text color
form_text_color = (WHITE,CYAN,ON)

# Readonly form item color
form_item_readonly_color = (CYAN,WHITE,ON)
```

## See also

- `$HOME/.dialogrc` file

# A yes/no dialog box

---

- You can display a yes/no dialog box using the following syntax:

```
dialog --common-options --yesno text height width
```

- This dialog box is useful for asking questions that require the user to answer either yes or no.
- The dialog box has a Yes button and a No button, in which the user can switch between by pressing the TAB key.
- On exit, no text is written to dialog's output. In addition to the "Yes" and "No" exit codes and ESC → exit status may be returned as follows:
  - **0** - Yes chosen.
  - **1** - No chosen.
  - **255** - Escape key was pressed i.e. box closed.

## Example

- Create a script called `dynbox.sh`:

```
#!/bin/bash
# dynbox.sh - Yes/No box demo
dialog --title "Delete file" \
--backtitle "Linux Shell Script Tutorial Example" \
--yesno "Are you sure you want to permanently delete \"/tmp/foo.txt\"?"
 7 60

# Get exit status
# 0 means user hit [yes] button.
# 1 means user hit [no] button.
# 255 means user hit [Esc] key.
response=$?
case $response in
```

```
0) echo "File deleted.>";;
1) echo "File not deleted.>";;
255) echo "[ESC] key pressed.>";;
```

```
esac
```

Save and close the file. Run it as follows:

```
chmod +x dynbox.sh
./dynbox.sh
```

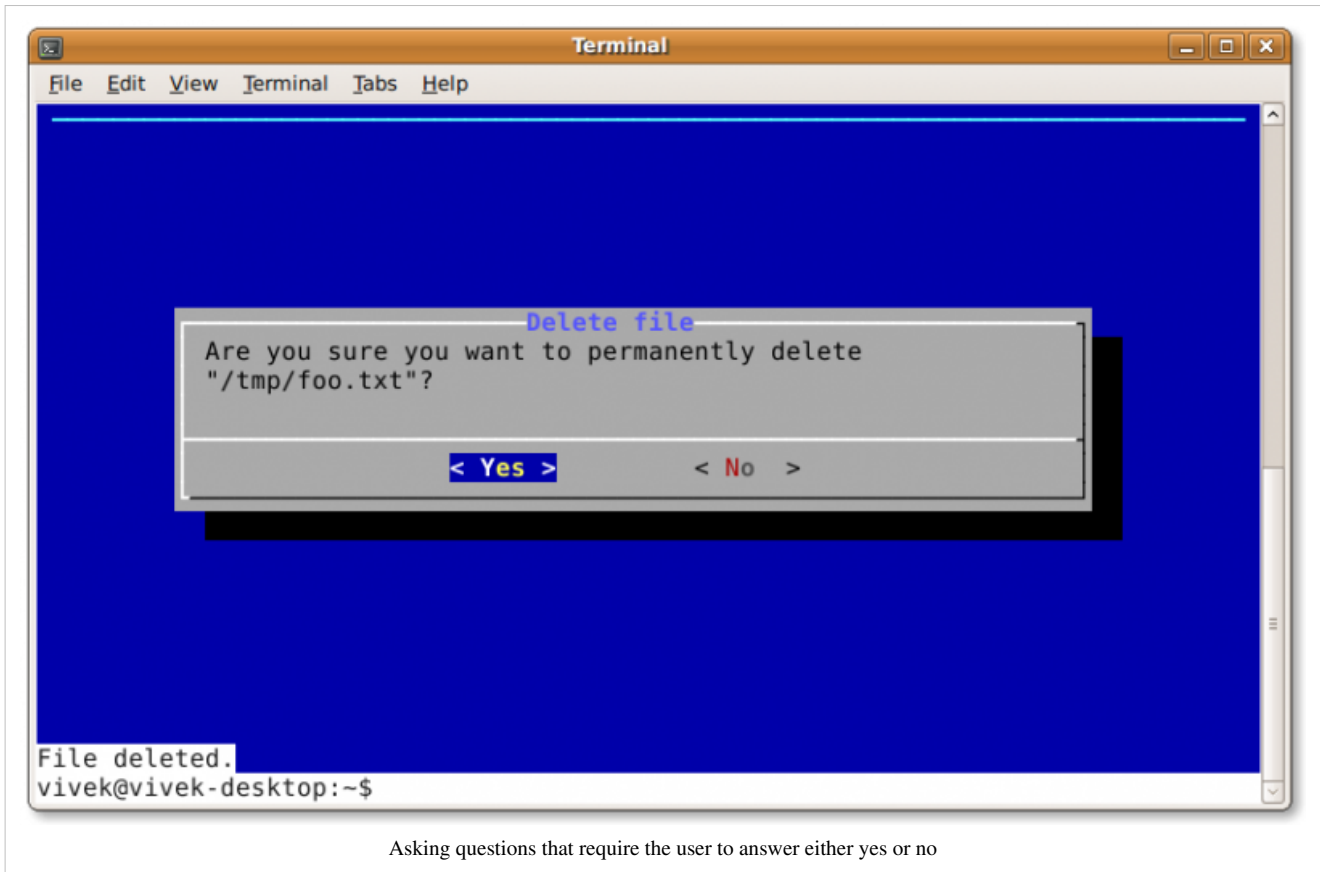

# An input dialog box

---

- An **input box** is useful when you want to ask questions that require the user to input a data as the answer via the keyboard.
- When entering the data, the backspace, delete and cursor keys can be used to correct typing errors.
- If the input data is longer than can fit in the dialog box, the input field will be scrolled.
- On exit, the input string will be printed on dialog's output. This can be redirected to a text file.

## Example

- Create a shell script called `yesnobox.sh`:

```
#!/bin/bash
# yesnobox.sh - An inputbox demon shell script
OUTPUT="/tmp/input.txt"

# create empty file
>$OUTPUT

# Purpose - say hello to user
# $1 -> name (set default to 'anonymous person')
function sayhello(){
    local n=${@-"anonymous person"}
    #display it
    dialog --title "Hello" --clear --msgbox "Hello ${n}, let us be
friends!" 10 41
}

# cleanup - add a trap that will remove $OUTPUT
# if any of the signals - SIGHUP SIGINT SIGTERM it received.
trap "rm $OUTPUT; exit" SIGHUP SIGINT SIGTERM

# show an inputbox
dialog --title "Inputbox - To take input from you" \
--backtitle "Linux Shell Script Tutorial Example" \
--inputbox "Enter your name " 8 60 2>$OUTPUT

# get respose
response=$?

# get data stored in $OUPUT using input redirection
name=$(<$OUTPUT)

# make a decsion
case $response in
0)
    sayhello ${name}
;;
```

```
1)
    echo "Cancel pressed."
    ;;
255)
    echo "[ESC] key pressed."
esac

# remove $OUTPUT file
rm $OUTPUT
```

Save and close the file. Run it as follows:

```
chmod +x yesnobox.sh
./yesnobox.sh
```

Sample outputs:

### yesnobox.sh shell script output

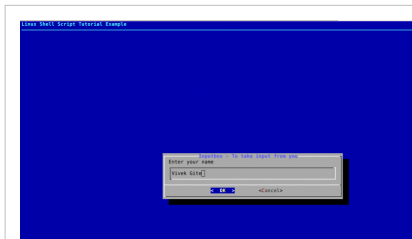

An input dialog box

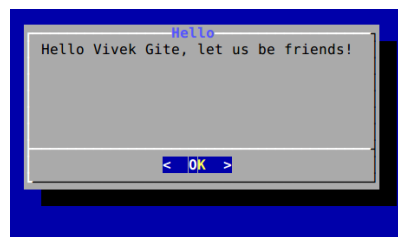

Messagebox

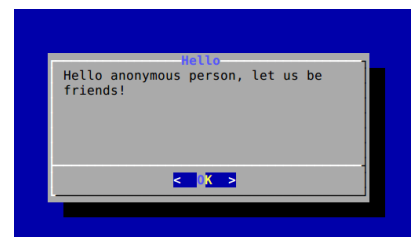

Messagebox with default value

### See also

- → trap command
- → How to set the default shell variable value

# A password box

---

- A **password box** is just like an → input box, except that the text the operator enters in to displayed on screen.
- Use this to collect user passwords.
- The "--insecure" option will display password as sting.
- On exit, the input string will be printed on dialog's output.

## Example

- Create a shell script called `getpasswd1.sh`:

```
#!/bin/bash
# getpasswd1.sh - A sample shell script to read users password.
# password storage
data=$(tempfile 2>/dev/null)

# trap it
trap "rm -f $data" 0 1 2 5 15

# get password
dialog --title "Password" \
--clear \
--passwordbox "Enter your password" 10 30 2> $data

ret=$?

# make decision
case $ret in
  0)
    echo "Password is $(cat $data)";;
  1)
    echo "Cancel pressed.";;
  255)
    [ -s $data ] && cat $data || echo "ESC pressed.";;
esac
```

Save and close the file. Run it as follows:

```
chmod +x getpasswd1.sh
./getpasswd1.sh
```

Sample outputs:

## getpasswd1.sh shell script output

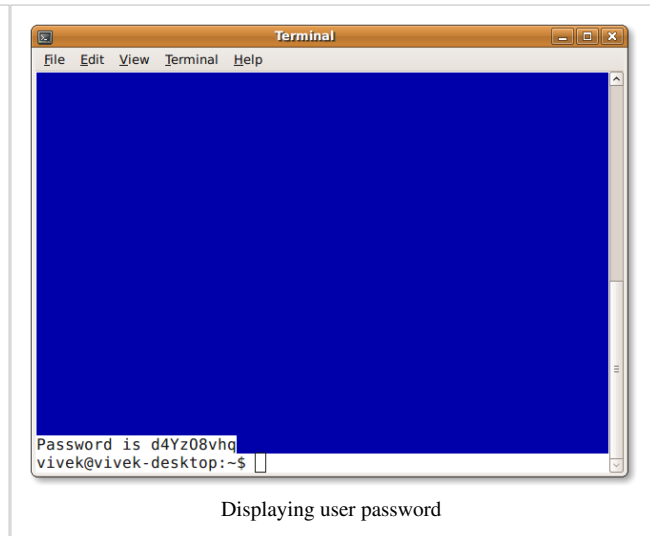
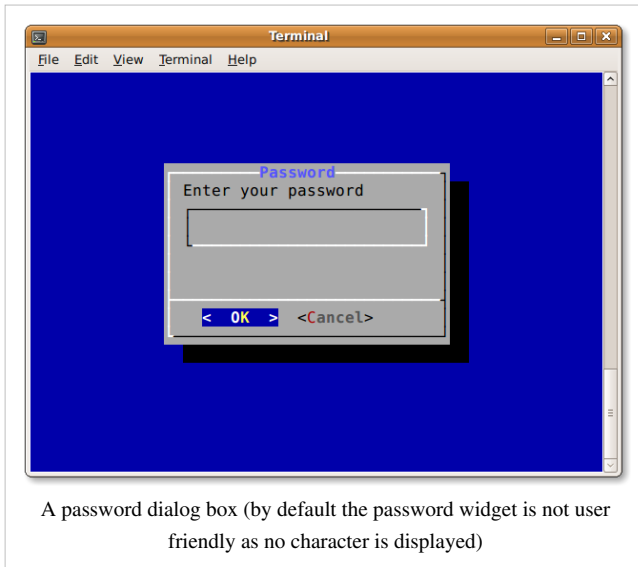
**The --insecure option**

- The --insecure option makes the password widget friendlier but less secure, by echoing asterisks for each character.
- Create a shell script called getpasswd2.sh:

```
#!/bin/bash
# getpasswd2.sh - A sample shell script to read users password.
# password storage
data=$(tempfile 2>/dev/null)

# trap it
trap "rm -f $data" 0 1 2 5 15

# get password with the --insecure option
dialog --title "Password" \
--clear \
--insecure \
--passwordbox "Enter your password" 10 30 2> $data

ret=$?

# make decison
case $ret in
0)
    echo "Password is $(cat $data)";;
1)
    echo "Cancel pressed.";;
255)
    [ -s $data ] && cat $data || echo "ESC pressed.";;
esac
```



Sample outputs:



## A menu box

- A **menu box** display a list of choices to the user in the form of a menu.
- Each menu is made of a *tag* string and an *item* string. In this example, a tag (e.g., Calendar) is on left side and an item (e.g., "Displays a calendar") is on right side:

```
Date/time "Displays date and time" \
Calendar "Displays a calendar" \
Editor "Start a text editor" \
Exit "Exit to the shell"
```

- The *tag* gives the entry a name to distinguish it from the other entries in the menu. Use the *tag* to make decision using `→ if` statement or `→ case..esac` statement.
- The item is nothing but a short description of the option that the entry represents.
- All choices (menus) are displayed in the order given.

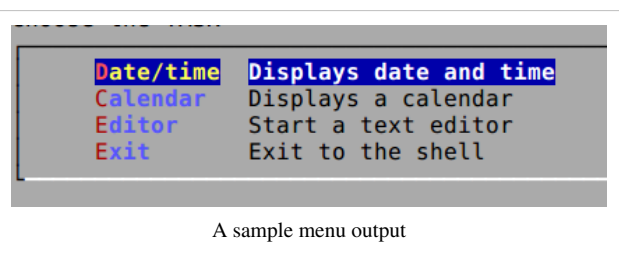

- On exit the *tag* of the chosen menu entry will be printed on dialog's output. This can be redirected to the file using `→` the following syntax:

```
> /tmp/menu.output
```

- If the "--help-button" option is given, the corresponding help text will be printed if the user selects the help button.

## Example

- Create a shell script called utilitymenu.sh:

```
#!/bin/bash
# utilitymenu.sh - A sample shell script to display menus on screen
# Store menu options selected by the user
INPUT=/tmp/menu.sh.$$

# Storage file for displaying cal and date command output
OUTPUT=/tmp/output.sh.$$

# get text editor or fall back to vi_editor
vi_editor=${EDITOR-vi}

# trap and delete temp files
trap "rm $OUTPUT; rm $INPUT; exit" SIGHUP SIGINT SIGTERM

#
# Purpose - display output using msgbox
# $1 -> set msgbox height
# $2 -> set msgbox width
# $3 -> set msgbox title
#
function display_output(){
    local h=${1-10}           # box height default 10
    local w=${2-41}          # box width default 41
    local t=${3-Output}      # box title
    dialog --backtitle "Linux Shell Script Tutorial" --title "${t}"
--clear --msgbox "$(<$OUTPUT)" ${h} ${w}
}
#
# Purpose - display current system date & time
#
function show_date(){
    echo "Today is $(date) @ $(hostname -f)." >$OUTPUT
    display_output 6 60 "Date and Time"
}
#
# Purpose - display a calendar
#
function show_calendar(){
    cal >$OUTPUT
    display_output 13 25 "Calendar"
}
#
# set infinite loop
#
```

```
while true
do

### display main menu ###
dialog --clear --help-button --backtitle "Linux Shell Script Tutorial"
\
--title "[ M A I N - M E N U ]" \
--menu "You can use the UP/DOWN arrow keys, the first \n\
letter of the choice as a hot key, or the \n\
number keys 1-9 to choose an option.\n\
Choose the TASK" 15 50 4 \
Date/time "Displays date and time" \
Calendar "Displays a calendar" \
Editor "Start a text editor" \
Exit "Exit to the shell" 2>"${INPUT}"

menuitem=$(<"${INPUT}")

# make decsion
case $menuitem in
    Date/time) show_date;;
    Calendar) show_calendar;;
    Editor) $vi_editor;;
    Exit) echo "Bye"; break;;
esac

done

# if temp files found, delete em
[ -f $OUTPUT ] && rm $OUTPUT
[ -f $INPUT ] && rm $INPUT
```

Save and close the file. Run it as follows:

```
chmod +x utilitymenu.sh
./utilitymenu.sh
```

Sample outputs:

## utilitymenu.sh shell script output (dialog command with menus)

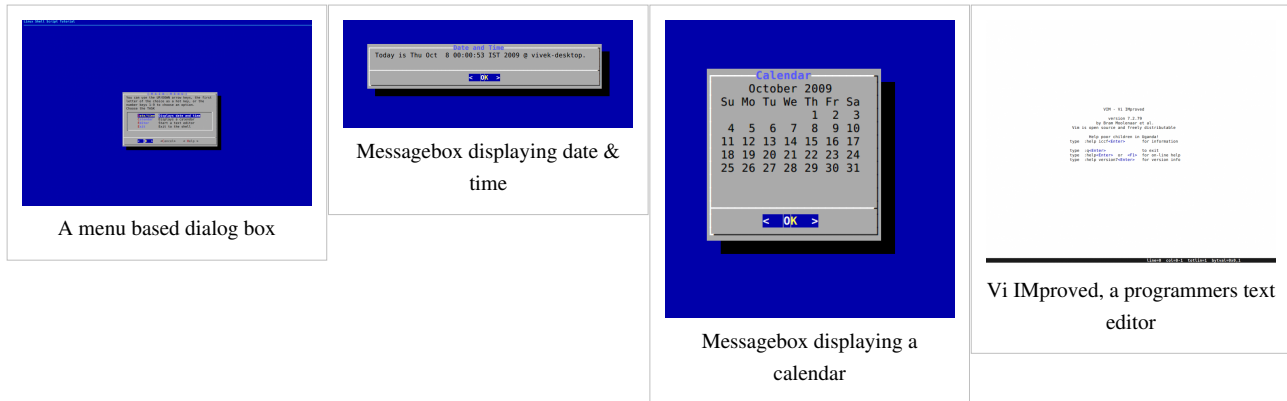

## A progress bar (gauge box)

- You can create a **progress bar** (progress indicator) when copying/moving files or making backups using the *gauge box*.
- It displays a meter along the bottom of the box. The meter indicates the percentage. New percentages are read from standard input, one integer per line. The meter is updated to reflect each new percentage.
- If the standard input reads the string "START\_BAR", then the first line following is taken as an integer percentage, then subsequent lines up to another "START\_BAR" are used for a new prompt. The gauge exits when EOF is reached on the standard input.
- The syntax is as follows:

```
echo percentage | dialog --gauge "text" height width percent
echo "10" | dialog --gauge "Please wait" 10 70 0
echo "50" | dialog --gauge "Please wait" 10 70 0
echo "100" | dialog --gauge "Please wait" 10 70 0
```

- However, you need to use the `→ while` or `→ for` loop to show 0 to 100% progress. In this example, the `→ for` loop is used to display progress:

```
for i in $(seq 0 10 100) ; do sleep 1; echo $i | dialog --gauge "Please
wait" 10 70 0; done
```

### Example

Create a shell script `dvdcopy.sh`:

```
#!/bin/bash
# dvdcopy.sh - A sample shell script to display a progress bar
# set counter to 0
counter=0
(
# set infinite while loop
while :
do
cat <<EOF
XXX
```

```

$counter
Disk copy /dev/dvd to /home/data ( $counter%):
XXX
EOF
# increase counter by 10
(( counter+=10 ))
[ $counter -eq 100 ] && break
# delay it a specified amount of time i.e 1 sec
sleep 1
done
) |
dialog --title "File Copy" --gauge "Please wait" 7 70 0

```

Save and close the file. Run it as follows:

```

chmod +x dvdcopy.sh
./dvdcopy.sh

```

Sample outputs:

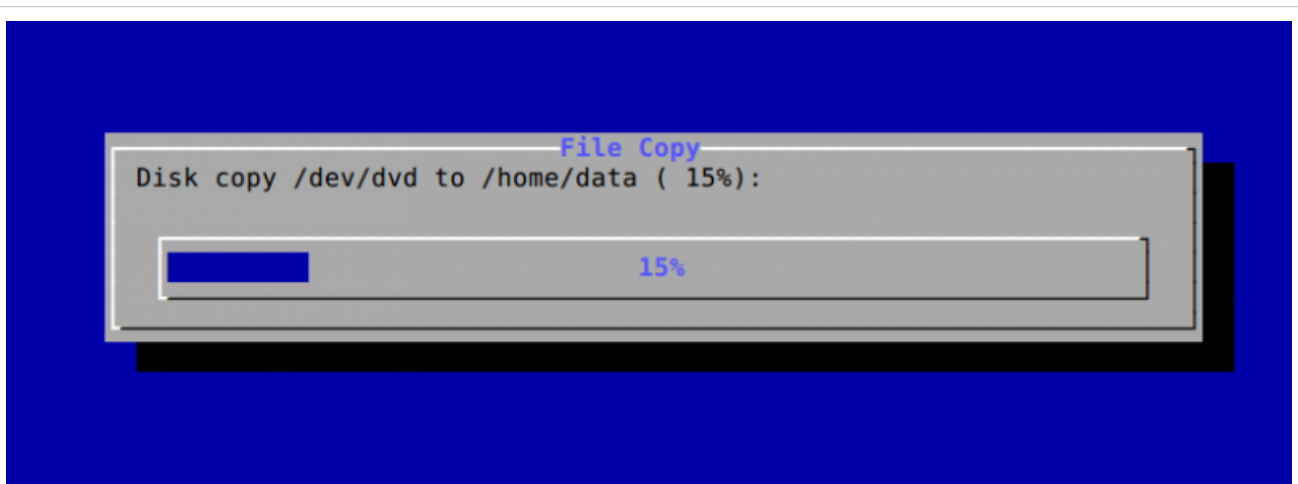

A sample progress bar (gauge box)

## File Copy Progress Bar With Dialog

- Create a shell script called pcp.sh:

```

#!/bin/bash
# pcp.sh: A shell script to copy /bin/* and /etc/* files
#         Display a progress bar while copying files.
# * Based upon Greg's (GreyCat's) GPLd wiki example. *
# -----
# Create an array of all files in /etc and /bin directory
DIRS=(/bin/* /etc/*)

# Destination directory
DEST="/tmp/test.$$"

```

```

# Create $DEST if does not exists
[ ! -d $DEST ] && mkdir -p $DEST

#
# Show a progress bar
# -----
# Redirect dialog commands input using substitution
#
dialog --title "Copy file" --gauge "Copying file..." 10 75 < <(
  # Get total number of files in array
  n=${#DIRS[*]};

  # set counter - it will increase every-time a file is copied to $DEST
  i=0

  #
  # Start the for loop
  #
  # read each file from $DIRS array
  # $f has filename
  for f in "${DIRS[@]}"
  do
    # calculate progress
    PCT=$(( 100*(++i)/n ))

    # update dialog box
cat <<EOF
XXX
$PCT
Copying file "$f"...
XXX
EOF
    # copy file $f to $DEST
    /bin/cp $f ${DEST} &>/dev/null
  done
)

# just delete $DEST directory
/bin/rm -rf $DEST

```

Save and close the file. Run it as follows:

```

chmod +x pcp.sh
./pcp.sh

```

# The form dialog for input

- The **form dialog** displays data entry form which consisting of labels and fields.
- You can set the field length.
- An operator can use up/down arrows to move between fields and tab to move between windows.

The syntax is as follows:

```
dialog --form text height width formheight [label x y item x y flen
ilen ]
```

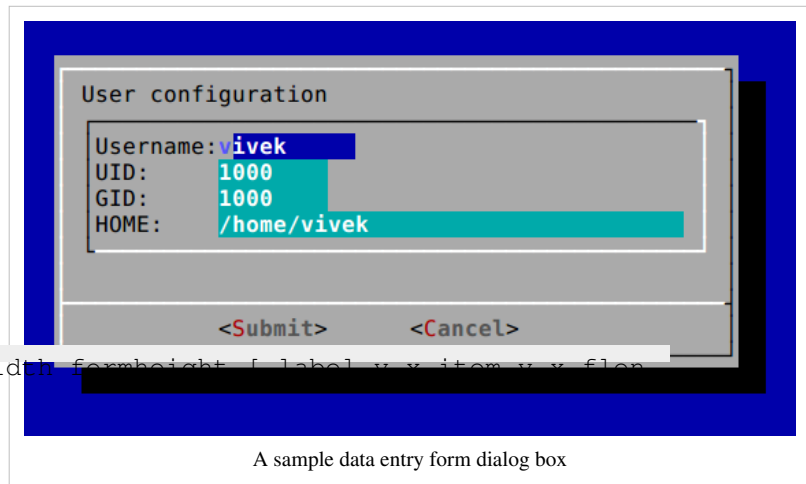

- Where,
  - The field length flen and input-length ilen tell how long the field can be.
  - If flen is zero, the corresponding field cannot be altered. and the contents of the field determine the displayed-length.
  - If flen is negative, the corresponding field cannot be altered, and the negated value of flen is used as the displayed-length.
  - If ilen is zero, it is set to flen.

## Example

- Create a shell script called useradd1.sh:

```
#!/bin/bash
# useradd1.sh - A simple shell script to display the form dialog on
screen
# set field names i.e. shell variables
shell=""
groups=""
user=""
home=""

# open fd
exec 3>&1

# Store data to $VALUES variable
VALUES=$(dialog --ok-label "Submit" \
  --backtitle "Linux User Managment" \
  --title "Useradd" \
  --form "Create a new user" \
15 50 0 \
  "Username:" 1 1 "$user" 1 10 10 0 \
  "Shell:" 2 1 "$shell" 2 10 15 0 \
  "Group:" 3 1 "$groups" 3 10 8 0 \
  "HOME:" 4 1 "$home" 4 10 40 0 \
```

```
2>&1 1>&3)

# close fd
exec 3>&-

# display values just entered
echo "$VALUES"
```

Save and close the file. Run it as follows:

```
chmod +x useradd1.sh
./useradd1.sh
```

Sample outputs:

useradd1.sh: shell script output (the dialog command with data entry form)

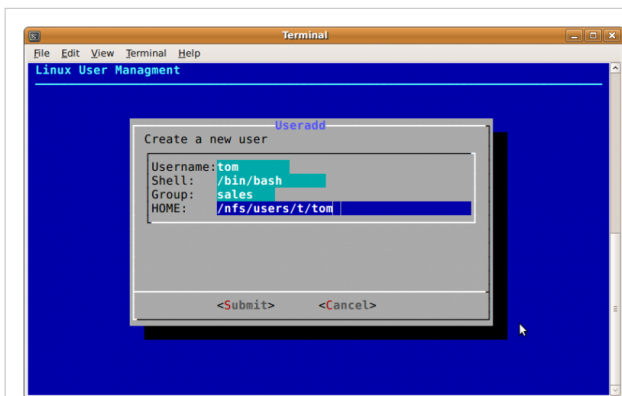

The form dialog box in action

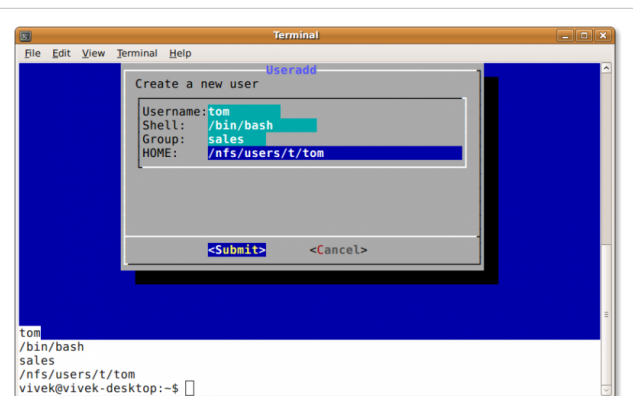

Displaying output stored in \$VALUES

## See also

- → exec command
- → Assigns the file descriptor (fd) to file for output



---

/etc

---

## Shell scripting help

---

- If you see a typo, a spelling mistake, or an error, please edit wiki page. Alternatively, you can tell me about it by sending me an e-mail.

### Have a Question About Shell Scripting?

- If you'd like to contact us about helping you with a Linux / UNIX shell scripting problem just click here to visit our <sup>[1]</sup> ( <http://nixcraft.com> ) excellent shell scripting tech support forum.
- View more scripts at Bash shell scripting directory <sup>[2]</sup> - <http://bash.cyberciti.biz> .

---

• Enjoy! Peace & Love!!

- Copyright © 1999-2009 Vivek Gite <[vivek@nixcraft.com](mailto:vivek@nixcraft.com)> and its contributors.

## References

[1] <http://nixcraft.com/>

[2] <http://bash.cyberciti.biz>

---

# Article Sources and Contributors

**Linux Shell Scripting Tutorial -A Beginner's handbook:About** *Source:* <http://bash.cyberciti.biz/wiki/index.php?oldid=1601> *Contributors:* Admin

**What Is Linux** *Source:* <http://bash.cyberciti.biz/wiki/index.php?oldid=831> *Contributors:* Admin

**Who created Linux** *Source:* <http://bash.cyberciti.biz/wiki/index.php?oldid=1391> *Contributors:* Admin

**Where can I download Linux** *Source:* <http://bash.cyberciti.biz/wiki/index.php?oldid=833> *Contributors:* Admin

**How do I Install Linux** *Source:* <http://bash.cyberciti.biz/wiki/index.php?oldid=834> *Contributors:* Admin

**Linux usage in everyday life** *Source:* <http://bash.cyberciti.biz/wiki/index.php?oldid=835> *Contributors:* Admin

**What is Linux Kernel** *Source:* <http://bash.cyberciti.biz/wiki/index.php?oldid=1786> *Contributors:* Admin, 1 anonymous edits

**What is Linux Shell** *Source:* <http://bash.cyberciti.biz/wiki/index.php?oldid=837> *Contributors:* Admin

**Unix philosophy** *Source:* <http://bash.cyberciti.biz/wiki/index.php?oldid=838> *Contributors:* Admin

**But how do you use the shell** *Source:* <http://bash.cyberciti.biz/wiki/index.php?oldid=840> *Contributors:* Admin

**What is a Shell Script or shell scripting** *Source:* <http://bash.cyberciti.biz/wiki/index.php?oldid=1590> *Contributors:* Admin, Cfajohnson

**Why shell scripting** *Source:* <http://bash.cyberciti.biz/wiki/index.php?oldid=1591> *Contributors:* Admin

**Chapter 1 Challenges** *Source:* <http://bash.cyberciti.biz/wiki/index.php?oldid=1087> *Contributors:* Admin

**The bash shell** *Source:* <http://bash.cyberciti.biz/wiki/index.php?oldid=1787> *Contributors:* Admin, 1 anonymous edits

**Shell commands** *Source:* <http://bash.cyberciti.biz/wiki/index.php?oldid=846> *Contributors:* Admin

**The role of shells in the Linux environment** *Source:* <http://bash.cyberciti.biz/wiki/index.php?oldid=847> *Contributors:* Admin

**Other standard shells** *Source:* <http://bash.cyberciti.biz/wiki/index.php?oldid=1184> *Contributors:* Admin

**Hello, World! Tutorial** *Source:* <http://bash.cyberciti.biz/wiki/index.php?oldid=1425> *Contributors:* Admin

**Shebang** *Source:* <http://bash.cyberciti.biz/wiki/index.php?oldid=1426> *Contributors:* Admin

**Shell Comments** *Source:* <http://bash.cyberciti.biz/wiki/index.php?oldid=1428> *Contributors:* Admin

**Setting up permissions on a script** *Source:* <http://bash.cyberciti.biz/wiki/index.php?oldid=1214> *Contributors:* Admin

**Execute a script** *Source:* <http://bash.cyberciti.biz/wiki/index.php?oldid=856> *Contributors:* Admin

**Debug a script** *Source:* <http://bash.cyberciti.biz/wiki/index.php?oldid=1746> *Contributors:* Admin, Vivek

**Chapter 2 Challenges** *Source:* <http://bash.cyberciti.biz/wiki/index.php?oldid=1181> *Contributors:* Admin, Dovis

**Variables in shell** *Source:* <http://bash.cyberciti.biz/wiki/index.php?oldid=1788> *Contributors:* Admin, 1 anonymous edits

**Assign values to shell variables** *Source:* <http://bash.cyberciti.biz/wiki/index.php?oldid=869> *Contributors:* Admin

**Default shell variables value** *Source:* <http://bash.cyberciti.biz/wiki/index.php?oldid=1548> *Contributors:* Admin, Xlevanus

**Rules for Naming variable name** *Source:* <http://bash.cyberciti.biz/wiki/index.php?oldid=871> *Contributors:* Admin

**Display the value of shell variables** *Source:* <http://bash.cyberciti.biz/wiki/index.php?oldid=1615> *Contributors:* Admin, Xlevanus

**Quoting** *Source:* <http://bash.cyberciti.biz/wiki/index.php?oldid=1636> *Contributors:* Admin

**The export statement** *Source:* <http://bash.cyberciti.biz/wiki/index.php?oldid=1479> *Contributors:* Admin, Xlevanus

**Unset shell and environment variables** *Source:* <http://bash.cyberciti.biz/wiki/index.php?oldid=875> *Contributors:* Admin

**Getting User Input Via Keyboard** *Source:* <http://bash.cyberciti.biz/wiki/index.php?oldid=1784> *Contributors:* Admin, Dovis, 2 anonymous edits

**Perform arithmetic operations** *Source:* <http://bash.cyberciti.biz/wiki/index.php?oldid=1785> *Contributors:* Admin, 1 anonymous edits

**Create an integer variable** *Source:* <http://bash.cyberciti.biz/wiki/index.php?oldid=1174> *Contributors:* Admin

**Create the constants variable** *Source:* <http://bash.cyberciti.biz/wiki/index.php?oldid=1550> *Contributors:* Admin, Xlevanus

**Bash variable existence check** *Source:* <http://bash.cyberciti.biz/wiki/index.php?oldid=1552> *Contributors:* Admin, Test

**Customize the bash shell environments** *Source:* <http://bash.cyberciti.biz/wiki/index.php?oldid=1778> *Contributors:* Admin

**Recalling command history** *Source:* <http://bash.cyberciti.biz/wiki/index.php?oldid=1777> *Contributors:* Admin

**Path name expansion** *Source:* <http://bash.cyberciti.biz/wiki/index.php?oldid=1667> *Contributors:* Admin

**Create and use aliases** *Source:* <http://bash.cyberciti.biz/wiki/index.php?oldid=1713> *Contributors:* Admin

**The tilde expansion** *Source:* <http://bash.cyberciti.biz/wiki/index.php?oldid=1681> *Contributors:* Admin

**Startup scripts** *Source:* <http://bash.cyberciti.biz/wiki/index.php?oldid=1780> *Contributors:* Admin

**Using aliases** *Source:* <http://bash.cyberciti.biz/wiki/index.php?oldid=1716> *Contributors:* Admin

**Changing bash prompt** *Source:* <http://bash.cyberciti.biz/wiki/index.php?oldid=1738> *Contributors:* Admin

**Setting shell options** *Source:* <http://bash.cyberciti.biz/wiki/index.php?oldid=1774> *Contributors:* Admin

**Setting system wide shell options** *Source:* <http://bash.cyberciti.biz/wiki/index.php?oldid=1775> *Contributors:* Admin

**Chapter 3 Challenges** *Source:* <http://bash.cyberciti.biz/wiki/index.php?oldid=1773> *Contributors:* Admin

**Bash structured language constructs** *Source:* <http://bash.cyberciti.biz/wiki/index.php?oldid=881> *Contributors:* Admin

**Test command** *Source:* <http://bash.cyberciti.biz/wiki/index.php?oldid=883> *Contributors:* Admin

**If structures to execute code based on a condition** *Source:* <http://bash.cyberciti.biz/wiki/index.php?oldid=884> *Contributors:* Admin

**If..else..fi** *Source:* <http://bash.cyberciti.biz/wiki/index.php?oldid=885> *Contributors:* Admin

**Nested ifs** *Source:* <http://bash.cyberciti.biz/wiki/index.php?oldid=887> *Contributors:* Admin

**Multilevel if-then-else** *Source:* <http://bash.cyberciti.biz/wiki/index.php?oldid=1481> *Contributors:* Admin, Xlevanus

**The exit status of a command** *Source:* <http://bash.cyberciti.biz/wiki/index.php?oldid=889> *Contributors:* Admin

**Conditional execution** *Source:* <http://bash.cyberciti.biz/wiki/index.php?oldid=1592> *Contributors:* Admin, 1 anonymous edits

**Logical AND &&** *Source:* <http://bash.cyberciti.biz/wiki/index.php?oldid=1595> *Contributors:* Admin, 3 anonymous edits

**Logical OR ||** *Source:* <http://bash.cyberciti.biz/wiki/index.php?oldid=1068> *Contributors:* Admin

**Logical Not !** *Source:* <http://bash.cyberciti.biz/wiki/index.php?oldid=1596> *Contributors:* Admin, 1 anonymous edits

**Conditional expression using [** *Source:* <http://bash.cyberciti.biz/wiki/index.php?oldid=895> *Contributors:* Admin

**Conditional expression using <nowiki>[[</nowiki>** *Source:* <http://bash.cyberciti.biz/wiki/index.php?oldid=1705> *Contributors:* Admin

**Numeric comparison** *Source:* <http://bash.cyberciti.biz/wiki/index.php?oldid=896> *Contributors:* Admin

**String comparison** *Source:* <http://bash.cyberciti.biz/wiki/index.php?oldid=1307> *Contributors:* Admin

**File attributes comparisons** *Source:* <http://bash.cyberciti.biz/wiki/index.php?oldid=1712> *Contributors:* Admin, 2 anonymous edits

**Shell command line parameters** *Source:* <http://bash.cyberciti.biz/wiki/index.php?oldid=899> *Contributors:* Admin

**How to use positional parameters** *Source:* <http://bash.cyberciti.biz/wiki/index.php?oldid=1700> *Contributors:* Admin

**Parameters Set by the Shell** *Source:* <http://bash.cyberciti.biz/wiki/index.php?oldid=1690> *Contributors:* Admin

**Create usage messages** *Source:* <http://bash.cyberciti.biz/wiki/index.php?oldid=1314> *Contributors:* Admin

**Exit command** *Source:* <http://bash.cyberciti.biz/wiki/index.php?oldid=975> *Contributors:* Admin

**The case statement** *Source:* <http://bash.cyberciti.biz/wiki/index.php?oldid=1534> *Contributors:* Admin, 1 anonymous edits

**Dealing with case sensitive pattern** *Source:* <http://bash.cyberciti.biz/wiki/index.php?oldid=1701> *Contributors:* Admin

**Chapter 4 Challenges** *Source:* <http://bash.cyberciti.biz/wiki/index.php?oldid=1196> *Contributors:* Admin

**The for loop statement** *Source:* <http://bash.cyberciti.biz/wiki/index.php?oldid=1725> *Contributors:* Admin

**Nested for loop statement** *Source:* <http://bash.cyberciti.biz/wiki/index.php?oldid=907> *Contributors:* Admin

**The while loop statement** *Source:* <http://bash.cyberciti.biz/wiki/index.php?oldid=1424> *Contributors:* Admin

**Use of : to set infinite while loop** *Source:* <http://bash.cyberciti.biz/wiki/index.php?oldid=1726> *Contributors:* Admin

**The until loop statement** *Source:* <http://bash.cyberciti.biz/wiki/index.php?oldid=910> *Contributors:* Admin

**The select loop statement** *Source:* <http://bash.cyberciti.biz/wiki/index.php?oldid=911> *Contributors:* Admin

**Exit the select loop statement** *Source:* <http://bash.cyberciti.biz/wiki/index.php?oldid=912> *Contributors:* Admin

**Using the break statement** *Source:* <http://bash.cyberciti.biz/wiki/index.php?oldid=913> *Contributors:* Admin

**Using the continue statement** *Source:* <http://bash.cyberciti.biz/wiki/index.php?oldid=914> *Contributors:* Admin

**Command substitution** *Source:* <http://bash.cyberciti.biz/wiki/index.php?oldid=1628> *Contributors:* Admin

**Chapter 5 Challenges** *Source:* <http://bash.cyberciti.biz/wiki/index.php?oldid=917> *Contributors:* Admin

**Input and Output** *Source:* <http://bash.cyberciti.biz/wiki/index.php?oldid=920> *Contributors:* Admin

**Standard input** *Source:* <http://bash.cyberciti.biz/wiki/index.php?oldid=921> *Contributors:* Admin

**Standard output** *Source:* <http://bash.cyberciti.biz/wiki/index.php?oldid=922> *Contributors:* Admin

**Standard error** *Source:* <http://bash.cyberciti.biz/wiki/index.php?oldid=923> *Contributors:* Admin

**Empty file creation** *Source:* <http://bash.cyberciti.biz/wiki/index.php?oldid=1103> *Contributors:* Admin, Philippe.Petrinko

**/dev/null discards unwanted output** *Source:* <http://bash.cyberciti.biz/wiki/index.php?oldid=1310> *Contributors:* Admin

**Here documents** *Source:* <http://bash.cyberciti.biz/wiki/index.php?oldid=926> *Contributors:* Admin

**Here strings** *Source:* <http://bash.cyberciti.biz/wiki/index.php?oldid=1322> *Contributors:* Admin

**Redirection of standard error** *Source:* <http://bash.cyberciti.biz/wiki/index.php?oldid=930> *Contributors:* Admin

**Redirection of standard output** *Source:* <http://bash.cyberciti.biz/wiki/index.php?oldid=932> *Contributors:* Admin

**Appending redirected output** *Source:* <http://bash.cyberciti.biz/wiki/index.php?oldid=933> *Contributors:* Admin

**Redirection of both standard error and output** *Source:* <http://bash.cyberciti.biz/wiki/index.php?oldid=934> *Contributors:* Admin

**Writing output to files** *Source:* <http://bash.cyberciti.biz/wiki/index.php?oldid=1745> *Contributors:* Admin

**Assigns the file descriptor (fd) to file for output** *Source:* <http://bash.cyberciti.biz/wiki/index.php?oldid=936> *Contributors:* Admin

**Assigns the file descriptor (fd) to file for input** *Source:* <http://bash.cyberciti.biz/wiki/index.php?oldid=937> *Contributors:* Admin

**Closes the file descriptor (fd)** *Source:* <http://bash.cyberciti.biz/wiki/index.php?oldid=938> *Contributors:* Admin

**Opening the file descriptors for reading and writing** *Source:* <http://bash.cyberciti.biz/wiki/index.php?oldid=939> *Contributors:* Admin

**Reads from the file descriptor (fd)** *Source:* <http://bash.cyberciti.biz/wiki/index.php?oldid=940> *Contributors:* Admin

**Executes commands and send output to the file descriptor (fd)** *Source:* <http://bash.cyberciti.biz/wiki/index.php?oldid=941> *Contributors:* Admin

**Chapter 6 Challenges** *Source:* <http://bash.cyberciti.biz/wiki/index.php?oldid=942> *Contributors:* Admin

**Linking Commands** *Source:* <http://bash.cyberciti.biz/wiki/index.php?oldid=944> *Contributors:* Admin

**Multiple commands** *Source:* <http://bash.cyberciti.biz/wiki/index.php?oldid=945> *Contributors:* Admin

**Putting jobs in background** *Source:* <http://bash.cyberciti.biz/wiki/index.php?oldid=1483> *Contributors:* Admin

**Pipes** *Source:* <http://bash.cyberciti.biz/wiki/index.php?oldid=948> *Contributors:* Admin

**How to use pipes to connect programs** *Source:* <http://bash.cyberciti.biz/wiki/index.php?oldid=950> *Contributors:* Admin

**Input redirection in pipes** *Source:* <http://bash.cyberciti.biz/wiki/index.php?oldid=954> *Contributors:* Admin

**Output redirection in pipes** *Source:* <http://bash.cyberciti.biz/wiki/index.php?oldid=955> *Contributors:* Admin

**Why use pipes** *Source:* <http://bash.cyberciti.biz/wiki/index.php?oldid=956> *Contributors:* Admin

**Filters** *Source:* <http://bash.cyberciti.biz/wiki/index.php?oldid=1297> *Contributors:* Admin, Philippe.Petrinko

**Chapter 7 Challenges** *Source:* <http://bash.cyberciti.biz/wiki/index.php?oldid=958> *Contributors:* Admin

**Signals** *Source:* <http://bash.cyberciti.biz/wiki/index.php?oldid=1046> *Contributors:* Admin

**What is a Process?** *Source:* <http://bash.cyberciti.biz/wiki/index.php?oldid=1436> *Contributors:* Admin, Wburwash

**How to view Processes** *Source:* <http://bash.cyberciti.biz/wiki/index.php?oldid=1048> *Contributors:* Admin

**Sending signal to Processes** *Source:* <http://bash.cyberciti.biz/wiki/index.php?oldid=1049> *Contributors:* Admin

**Terminating Processes** *Source:* <http://bash.cyberciti.biz/wiki/index.php?oldid=1050> *Contributors:* Admin

**Shell signal values** *Source:* <http://bash.cyberciti.biz/wiki/index.php?oldid=1051> *Contributors:* Admin

**The trap statement** *Source:* <http://bash.cyberciti.biz/wiki/index.php?oldid=1052> *Contributors:* Admin

**How to clear trap** *Source:* <http://bash.cyberciti.biz/wiki/index.php?oldid=1053> *Contributors:* Admin

**Include trap statements in a script** *Source:* <http://bash.cyberciti.biz/wiki/index.php?oldid=1054> *Contributors:* Admin

**Use the trap statement to catch signals and handle errors** *Source:* <http://bash.cyberciti.biz/wiki/index.php?oldid=1055> *Contributors:* Admin

**What is a Subshell?** *Source:* <http://bash.cyberciti.biz/wiki/index.php?oldid=1066> *Contributors:* Admin

**Compound command** *Source:* <http://bash.cyberciti.biz/wiki/index.php?oldid=1058> *Contributors:* Admin

**Exec command** *Source:* <http://bash.cyberciti.biz/wiki/index.php?oldid=1090> *Contributors:* Admin

**Chapter 8 Challenges** *Source:* <http://bash.cyberciti.biz/wiki/index.php?oldid=1236> *Contributors:* Admin

**Writing your first shell function** *Source:* <http://bash.cyberciti.biz/wiki/index.php?oldid=1709> *Contributors:* Admin

**Displaying functions** *Source:* <http://bash.cyberciti.biz/wiki/index.php?oldid=1789> *Contributors:* Admin, 1 anonymous edits

**Removing functions** *Source:* <http://bash.cyberciti.biz/wiki/index.php?oldid=1243> *Contributors:* Admin

**Defining functions** *Source:* <http://bash.cyberciti.biz/wiki/index.php?oldid=1245> *Contributors:* Admin

**Writing functions** *Source:* <http://bash.cyberciti.biz/wiki/index.php?oldid=1684> *Contributors:* Admin

**Calling functions** *Source:* <http://bash.cyberciti.biz/wiki/index.php?oldid=1685> *Contributors:* Admin

**Pass arguments into a function** *Source:* <http://bash.cyberciti.biz/wiki/index.php?oldid=1686> *Contributors:* Admin

**Local variable** *Source:* <http://bash.cyberciti.biz/wiki/index.php?oldid=1687> *Contributors:* Admin

**Returning from a function** *Source:* <http://bash.cyberciti.biz/wiki/index.php?oldid=1251> *Contributors:* Admin

**Shell functions library** *Source:* <http://bash.cyberciti.biz/wiki/index.php?oldid=1252> *Contributors:* Admin

**Source command** *Source:* <http://bash.cyberciti.biz/wiki/index.php?oldid=1253> *Contributors:* Admin

**Recursive function** *Source:* <http://bash.cyberciti.biz/wiki/index.php?oldid=1688> *Contributors:* Admin

**Putting functions in background** *Source:* <http://bash.cyberciti.biz/wiki/index.php?oldid=1689> *Contributors:* Admin

**Chapter 9 Challenges** *Source:* <http://bash.cyberciti.biz/wiki/index.php?oldid=1255> *Contributors:* Admin

**Menu driven scripts** *Source:* <http://bash.cyberciti.biz/wiki/index.php?oldid=1614> *Contributors:* Admin, 2 anonymous edits

**Getting information about your system** *Source:* <http://bash.cyberciti.biz/wiki/index.php?oldid=1442> *Contributors:* Admin, Noahspurrier

**Bash display dialog boxes** *Source:* <http://bash.cyberciti.biz/wiki/index.php?oldid=1368> *Contributors:* Admin

**Dialog customization with configuration file** *Source:* <http://bash.cyberciti.biz/wiki/index.php?oldid=1378> *Contributors:* Admin

**A yes/no dialog box** *Source:* <http://bash.cyberciti.biz/wiki/index.php?oldid=1411> *Contributors:* Admin

**An input dialog box** *Source:* <http://bash.cyberciti.biz/wiki/index.php?oldid=1571> *Contributors:* Admin

**A password box** *Source:* <http://bash.cyberciti.biz/wiki/index.php?oldid=1581> *Contributors:* Admin

**A menu box** *Source:* <http://bash.cyberciti.biz/wiki/index.php?oldid=1464> *Contributors:* Admin

**A progress bar (gauge box)** *Source:* <http://bash.cyberciti.biz/wiki/index.php?oldid=1564> *Contributors:* Admin

**The form dialog for input** *Source:* <http://bash.cyberciti.biz/wiki/index.php?oldid=1569> *Contributors:* Admin

**Shell scripting help** *Source:* <http://bash.cyberciti.biz/wiki/index.php?oldid=1589> *Contributors:* Admin

# Image Sources, Licenses and Contributors

**File:Linus\_Torvalds.jpeg** *Source:* [http://bash.cyberciti.biz/wiki/index.php?title=File:Linus\\_Torvalds.jpeg](http://bash.cyberciti.biz/wiki/index.php?title=File:Linus_Torvalds.jpeg) *License:* unknown *Contributors:* Admin

**File:Rela.gif** *Source:* <http://bash.cyberciti.biz/wiki/index.php?title=File:Rela.gif> *License:* unknown *Contributors:* Admin

**File:Chessboard.sh-output.png** *Source:* <http://bash.cyberciti.biz/wiki/index.php?title=File:Chessboard.sh-output.png> *License:* unknown *Contributors:* Admin

**File:Menu.sh-output.png** *Source:* <http://bash.cyberciti.biz/wiki/index.php?title=File:Menu.sh-output.png> *License:* unknown *Contributors:* Admin

**File:Space-shuttle.sh-output.png** *Source:* <http://bash.cyberciti.biz/wiki/index.php?title=File:Space-shuttle.sh-output.png> *License:* unknown *Contributors:* Admin

**File:Shell-input-output.png** *Source:* <http://bash.cyberciti.biz/wiki/index.php?title=File:Shell-input-output.png> *License:* unknown *Contributors:* Admin

**File:Input-redirect etc passwd.png** *Source:* [http://bash.cyberciti.biz/wiki/index.php?title=File:Input-redirect\\_etc\\_passwd.png](http://bash.cyberciti.biz/wiki/index.php?title=File:Input-redirect_etc_passwd.png) *License:* unknown *Contributors:* Admin

**File:Output-redirect filename.png** *Source:* [http://bash.cyberciti.biz/wiki/index.php?title=File:Output-redirect\\_filename.png](http://bash.cyberciti.biz/wiki/index.php?title=File:Output-redirect_filename.png) *License:* unknown *Contributors:* Admin

**File:stderr-redirect.png** *Source:* <http://bash.cyberciti.biz/wiki/index.php?title=File:Stderr-redirect.png> *License:* unknown *Contributors:* Admin

**File:Shell-pipes.png** *Source:* <http://bash.cyberciti.biz/wiki/index.php?title=File:Shell-pipes.png> *License:* unknown *Contributors:* Admin

**File:Pipes-stderr.png** *Source:* <http://bash.cyberciti.biz/wiki/index.php?title=File:Pipes-stderr.png> *License:* unknown *Contributors:* Admin

**File:Linux-processes-life-cycle.png** *Source:* <http://bash.cyberciti.biz/wiki/index.php?title=File:Linux-processes-life-cycle.png> *License:* unknown *Contributors:* Admin

**File:Grabsysinfo.sh-output.png** *Source:* <http://bash.cyberciti.biz/wiki/index.php?title=File:Grabsysinfo.sh-output.png> *License:* unknown *Contributors:* Admin

**File:Bash-shell-dialog-msgbox-output.png** *Source:* <http://bash.cyberciti.biz/wiki/index.php?title=File:Bash-shell-dialog-msgbox-output.png> *License:* unknown *Contributors:* Admin

**File:Bash-dialog-output-with-yx-pos.png** *Source:* <http://bash.cyberciti.biz/wiki/index.php?title=File:Bash-dialog-output-with-yx-pos.png> *License:* unknown *Contributors:* Admin

**File:Dialog-yesno-box-output.png** *Source:* <http://bash.cyberciti.biz/wiki/index.php?title=File:Dialog-yesno-box-output.png> *License:* unknown *Contributors:* Admin

**File:Input-dialog-1.png** *Source:* <http://bash.cyberciti.biz/wiki/index.php?title=File:Input-dialog-1.png> *License:* unknown *Contributors:* Admin

**File:Input-dialog-2.png** *Source:* <http://bash.cyberciti.biz/wiki/index.php?title=File:Input-dialog-2.png> *License:* unknown *Contributors:* Admin

**File:Input-dialog-3.png** *Source:* <http://bash.cyberciti.biz/wiki/index.php?title=File:Input-dialog-3.png> *License:* unknown *Contributors:* Admin

**File>Password-1.png** *Source:* <http://bash.cyberciti.biz/wiki/index.php?title=File:Password-1.png> *License:* unknown *Contributors:* Admin

**File>Password-2.png** *Source:* <http://bash.cyberciti.biz/wiki/index.php?title=File:Password-2.png> *License:* unknown *Contributors:* Admin

**File>Password-3.png** *Source:* <http://bash.cyberciti.biz/wiki/index.php?title=File:Password-3.png> *License:* unknown *Contributors:* Admin

**File:Dialog-menu-output.png** *Source:* <http://bash.cyberciti.biz/wiki/index.php?title=File:Dialog-menu-output.png> *License:* unknown *Contributors:* Admin

**File:Utilitymenu.sh-output-1.png** *Source:* <http://bash.cyberciti.biz/wiki/index.php?title=File:Utilitymenu.sh-output-1.png> *License:* unknown *Contributors:* Admin

**File:Utilitymenu.sh-output-2.png** *Source:* <http://bash.cyberciti.biz/wiki/index.php?title=File:Utilitymenu.sh-output-2.png> *License:* unknown *Contributors:* Admin

**File:Utilitymenu.sh-output-3.png** *Source:* <http://bash.cyberciti.biz/wiki/index.php?title=File:Utilitymenu.sh-output-3.png> *License:* unknown *Contributors:* Admin

**File:Utilitymenu.sh-output-4.png** *Source:* <http://bash.cyberciti.biz/wiki/index.php?title=File:Utilitymenu.sh-output-4.png> *License:* unknown *Contributors:* Admin

**File:Shell-progress-bar.png** *Source:* <http://bash.cyberciti.biz/wiki/index.php?title=File:Shell-progress-bar.png> *License:* unknown *Contributors:* Admin

**File:Shell-data-entry-form.png** *Source:* <http://bash.cyberciti.biz/wiki/index.php?title=File:Shell-data-entry-form.png> *License:* unknown *Contributors:* Admin

**File:Createuser.sh-1-form.png** *Source:* <http://bash.cyberciti.biz/wiki/index.php?title=File:Createuser.sh-1-form.png> *License:* unknown *Contributors:* Admin

**File:Createuser.sh-2-form.png** *Source:* <http://bash.cyberciti.biz/wiki/index.php?title=File:Createuser.sh-2-form.png> *License:* unknown *Contributors:* Admin

# License

---

Attribution-Noncommercial-Share Alike 3.0 Unported  
<http://creativecommons.org/licenses/by-nc-sa/3.0/>

---