

LMV821, LMV824

Single and Quad Low Voltage, Rail-to-Rail Operational Amplifiers

The LMV821 and LMV824 are operational amplifiers with low input voltage offset and drift vs. temperature. In spite of low quiescent current requirements these devices have 5 MHz bandwidth and 1.4 V/ μ s slew rate. In addition they provide rail-to-rail output swing into 600 Ω loads. The input common-mode voltage range includes ground, and the maximum input offset voltage is only 3.5 mV. Substantially large capacitive loads can be driven by simply adding a pullup resistor or isolation resistor.

The LMV821 (single) is available in a space-saving SC70-5 while the quad comes in SOIC and TSSOP packages.

Features

- Low Offset Voltage: 3.5 mV
- Very low Offset Drift: 1.0 μ V/ $^{\circ}$ C
- High Bandwidth: 5 MHz
- Rail-to-Rail Output Swing into a 600 Ω load
- Capable of driving highly capacitive loads
- Small Packages:
 - LMV821 in SC-70
 - LMV824 in SOIC-14 and TSSOP-14
- These Devices are Pb-Free and are RoHS Compliant

Typical Applications

- Notebook Computers
- PDAs
- Modem Transmitter/ Receivers

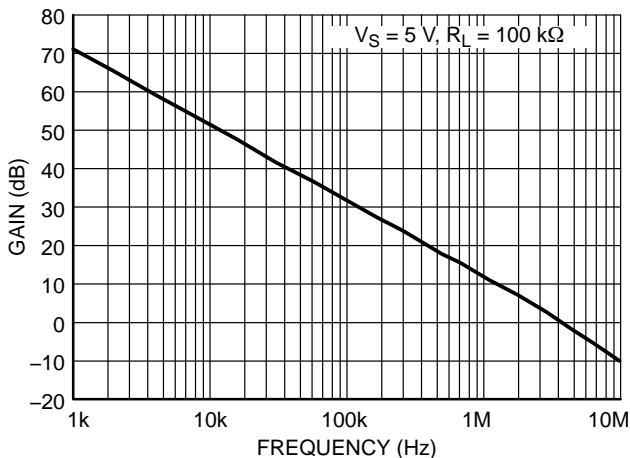

Figure 1. Gain vs. Frequency

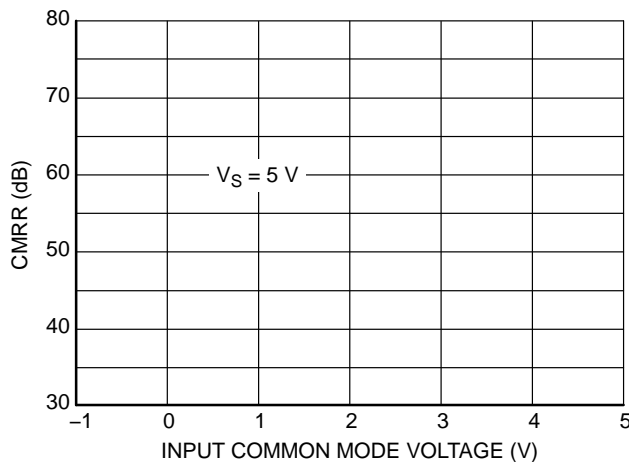

Figure 2. CMRR vs. Input Common Mode Voltage



ON Semiconductor®

www.onsemi.com



SC-70
CASE 419A



SOIC-14
CASE 751A

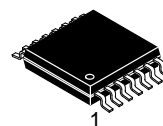

TSSOP-14
CASE 948G

ORDERING AND MARKING INFORMATION

See detailed ordering, marking and shipping information in the package dimensions section on page 2 of this data sheet.

LMV821, LMV824

MARKING DIAGRAMS

SC-70

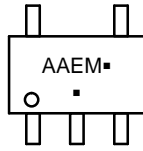

AAE = Specific Device Code
 M = Date Code
 ■ = Pb-Free Package

(Note: Microdot may be in either location)

SOIC-14

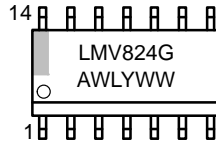

LMV824 = Specific Device Code
 A = Assembly Location
 WL = Wafer Lot
 Y = Year
 WW = Work Week
 G = Pb-Free Package

TSSOP-14

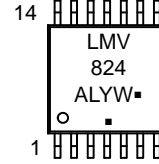

LMV824 = Specific Device Code
 A = Assembly Location
 L = Wafer Lot
 Y = Year
 W = Work Week
 ■ = Pb-Free Package

(Note: Microdot may be in either location)

PIN CONNECTIONS

SC70-5

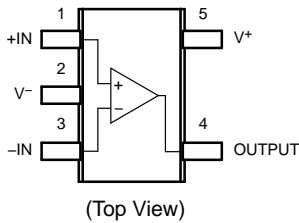

SOIC-14

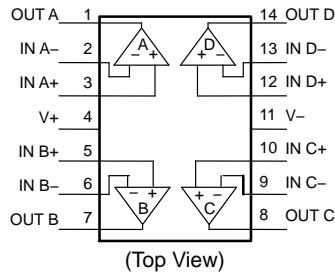

TSSOP-14

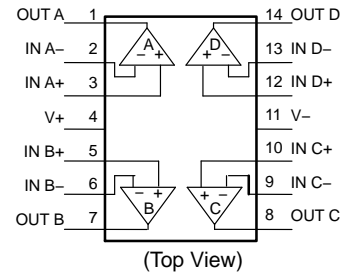

ORDERING INFORMATION

Order Number	Number of Channels	Specific Device Marking	Package Type	Shipping†
LMV821SQ3T2G	Single	AAE	SC-70 (Pb-Free)	3000 / Tape & Reel
LMV824DR2G	Quad	LMV824	SOIC-14 (Pb-Free)	2500 / Tape & Reel
LMV824DTBR2G	Quad	LMV 824	TSSOP-14 (Pb-Free)	2500 / Tape & Reel

†For information on tape and reel specifications, including part orientation and tape sizes, please refer to our Tape and Reel Packaging Specifications Brochure, BRD8011/D.

LMV821, LMV824

MAXIMUM RATINGS

Symbol	Rating	Value	Unit
V _S	Supply Voltage (Operating Range V _S = 2.7 V to 5.5 V)	5.5	V
V _{IDR}	Input Differential Voltage	± Supply Voltage	V
V _{ICR}	Input Common Mode Voltage Range	-0.5 to (V+) +0.5	V
	Maximum Input Current	10	mA
t _{SO}	Output Short Circuit (Note 1)	Continuous	
T _J	Maximum Junction Temperature (Operating Range -40°C to 85°C)	150	°C
θ _{JA}	Thermal Resistance		°C/W
	SC-70	280	
	SOIC-14	156	
	TSSOP-14	190	
T _{STG}	Storage Temperature	-65 to 150	°C
	Mounting Temperature (Infrared or Convection – 20 sec)	235	°C
V _{ESD}	ESD Tolerance	Machine Model	200
		Human Body Model	2000

Stresses exceeding those listed in the Maximum Ratings table may damage the device. If any of these limits are exceeded, device functionality should not be assumed, damage may occur and reliability may be affected.

1. Continuous short-circuit operation to ground at elevated ambient temperature can result in exceeding the maximum allowed junction temperature of 150°C. Output currents in excess of 45 mA over long term may adversely affect reliability. Shorting output to either V+ or V- will adversely affect reliability.

LMV821, LMV824

2.7V DC ELECTRICAL CHARACTERISTICS Unless otherwise noted, all min/max limits are guaranteed for $T_A = 25^\circ\text{C}$, $V_+ = 2.7\text{ V}$, $V_- = 0\text{ V}$, $V_{CM} = V_+/2$, $V_O = V_+/2$ and $R_L > 1\text{ M}\Omega$. Typical specifications represent the most likely parametric norm. Min/Max specifications are guaranteed by testing, characterization, or statistical analysis.

Parameter	Symbol	Conditions	Min	Typ	Max	Unit
Input Offset Voltage	V_{IO}			1	3.5	mV
		$T_A = -40^\circ\text{C to } +85^\circ\text{C}$			4	
Input Offset Voltage Average Drift	TCV_{OS}			1		$\mu\text{V}/^\circ\text{C}$
Input Bias Current	I_B			105	210	nA
		$T_A = -40^\circ\text{C to } +85^\circ\text{C}$			315	
Input Offset Current	I_{IO}			0.5	30	nA
		$T_A = -40^\circ\text{C to } +85^\circ\text{C}$			50	
Common-Mode Rejection Ratio	CMRR	$0\text{ V} \leq V_{CM} \leq 1.7\text{ V}$	70	85		dB
		$T_A = -40^\circ\text{C to } +85^\circ\text{C}$	68			
Power Supply Rejection Ratio	PSRR	$1.5\text{ V} \leq V_+ \leq 4\text{ V}$, $V_- = -1\text{ V}$, $V_O = 0\text{ V}$, $V_{CM} = 0.0\text{ V}$	75	85		dB
		$T_A = -40^\circ\text{C to } +85^\circ\text{C}$	70			
Input Common-Mode Voltage Range	V_{CM}	For CMRR $\geq 53\text{ dB}$ and $T_A = -40^\circ\text{C to } +85^\circ\text{C}$	-0.2	-0.3 to 2.0	1.9	V
Large Signal Voltage Gain	AV	$R_L = 600\ \Omega$, $V_O = 0.5\text{ V to } 2.5\text{ V}$	80	95		dB
		$T_A = -40^\circ\text{C to } +85^\circ\text{C}$	70			
		$R_L = 2\text{ k}\Omega$, $V_O = 0.5\text{ V to } 2.5\text{ V}$	83	89		
		$T_A = -40^\circ\text{C to } +85^\circ\text{C}$	80			
Output Swing	V_{OH}	$R_L = 600\ \Omega$ to 1.35 V	2.5	2.58		V
		$T_A = -40^\circ\text{C to } +85^\circ\text{C}$	2.4			
	V_{OL}	$R_L = 600\ \Omega$ to 1.35 V		0.13	0.21	
		$T_A = -40^\circ\text{C to } +85^\circ\text{C}$			0.3	
	V_{OH}	$R_L = 2\text{ k}\Omega$ to 1.35 V	2.6	2.66		
		$T_A = -40^\circ\text{C to } +85^\circ\text{C}$	2.5			
V_{OL}	$R_L = 2\text{ k}\Omega$ to 1.35 V		0.08	0.12		
	$T_A = -40^\circ\text{C to } +85^\circ\text{C}$			0.2		
Output Current	I_O	Sourcing, $V_O = 0\text{ V}$	12			mA
		Sinking, $V_O = 2.7\text{ V}$	12	26		
Supply Current	I_{CC}	LMV821 (Single)		0.242	0.3	mA
		$T_A = -40^\circ\text{C to } +85^\circ\text{C}$			0.5	
		LMV824 (All Four Channels)		1	1.3	
		$T_A = -40^\circ\text{C to } +85^\circ\text{C}$			1.5	

LMV821, LMV824

2.5V DC ELECTRICAL CHARACTERISTICS Unless otherwise noted, all min/max limits are guaranteed for $T_A = 25^\circ\text{C}$, $V_+ = 2.5\text{ V}$, $V_- = 0\text{ V}$, $V_{CM} = V_+/2$, $V_O = V_+/2$ and $R_L > 1\text{ M}\Omega$. Typical specifications represent the most likely parametric norm. Min/Max specifications are guaranteed by testing, characterization, or statistical analysis.

Parameter	Symbol	Conditions	Min	Typ	Max	Unit
Input Offset Voltage	V_{IO}	$T_A = -40^\circ\text{C}$ to $+85^\circ\text{C}$		1	3.5	mV
					4	
Output Swing	V_{OH}	$R_L = 600\ \Omega$ to 1.25 V	2.3	2.37		V
		$T_A = -40^\circ\text{C}$ to $+85^\circ\text{C}$	2.2			
	V_{OL}	$R_L = 600\ \Omega$ to 1.25 V		0.13	0.20	
		$T_A = -40^\circ\text{C}$ to $+85^\circ\text{C}$			0.3	
	V_{OH}	$R_L = 2\text{ k}\Omega$ to 1.25 V	2.4	2.46		
		$T_A = -40^\circ\text{C}$ to $+85^\circ\text{C}$	2.3			
	V_{OL}	$R_L = 2\text{ k}\Omega$ to 1.25 V		0.08	0.12	
		$T_A = -40^\circ\text{C}$ to $+85^\circ\text{C}$			0.20	

2.7V AC ELECTRICAL CHARACTERISTICS Unless otherwise specified, all limits are guaranteed for $T_A = 25^\circ\text{C}$, $V_+ = 2.7\text{ V}$, $V_- = 0\text{ V}$, $V_{CM} = 1.0\text{ V}$, $V_O = V_+/2$ and $R_L > 1\text{ M}\Omega$. Typical specifications represent the most likely parametric norm. Min/Max specifications are guaranteed by testing, characterization, or statistical analysis.

Parameter	Symbol	Conditions	Min	Typ	Max	Unit
Slew Rate	SR	(Note 2)		1.5		V/ μS
Gain Bandwidth Product	GBWP			5		MHz
Phase Margin	θ_m			55		$^\circ$
Gain Margin	G_m			12.9		dB
Input-Referred Voltage Noise	e_n	$f = 1\text{ kHz}$, $V_{CM} = 1\text{ V}$		12		nV/ $\sqrt{\text{Hz}}$
Input-Referred Current Noise	i_n	$f = 1\text{ kHz}$		0.2		pA/ $\sqrt{\text{Hz}}$
Total Harmonic Distortion	THD	$f = 1\text{ kHz}$, $AV = -2$, $R_L = 10\text{ k}\Omega$, $V_O = 1.8\text{ V}_{PP}$		0.023		%
Amplifier-to-Amplifier Isolation		(Note 3)		135		dB

2. Connected as voltage follower with input step from 0.5 V to 1.5 V. Number specified is the average of the positive and negative slew rates.
3. Input referred, $R_L = 100\text{ k}\Omega$ connected to $V_+/2$. Each amp excited in turn with 1kHz to produce $V_O = 3\text{ V}_{PP}$. For Supply Voltages $< 3\text{ V}$, $V_O = V_+$.

LMV821, LMV824

5V DC ELECTRICAL CHARACTERISTICS Unless otherwise noted, all min/max limits are guaranteed for $T_A = 25^\circ\text{C}$, $V_+ = 5\text{ V}$, $V_- = 0\text{ V}$, $V_{CM} = V_+/2$, $V_O = V_+/2$ and $R_L > 1\text{ M}\Omega$. Typical specifications represent the most likely parametric norm. Min/Max specifications are guaranteed by testing, characterization, or statistical analysis.

Parameter	Symbol	Conditions	Min	Typ	Max	Unit
Input Offset Voltage	V_{IO}			1	3.5	mV
		$T_A = -40^\circ\text{C}$ to $+85^\circ\text{C}$			4	
Input Offset Voltage Average Drift	TCV_{OS}			1		$\mu\text{V}/^\circ\text{C}$
Input Bias Current	I_B			119	245	nA
		$T_A = -40^\circ\text{C}$ to $+85^\circ\text{C}$			380	
Input Offset Current	I_{IO}			0.5	30	nA
		$T_A = -40^\circ\text{C}$ to $+85^\circ\text{C}$			50	
Common-Mode Rejection Ratio	CMRR	$0\text{ V} \leq V_{CM} \leq 4.0\text{ V}$	72	90		dB
		$T_A = -40^\circ\text{C}$ to $+85^\circ\text{C}$	70			
Power Supply Rejection Ratio	PSRR	$1.7\text{ V} \leq V_+ \leq 4\text{ V}$, $V_- = 1\text{ V}$, $V_O = 0\text{ V}$, $V_{CM} = 0.0\text{ V}$	75	85		dB
		$T_A = -40^\circ\text{C}$ to $+85^\circ\text{C}$	70			
Input Common-Mode Voltage Range	V_{CM}	For CMRR $\geq 58\text{ dB}$ and $T_A = -40^\circ\text{C}$ to $+85^\circ\text{C}$	-0.2	-0.2 to 4.3	4.2	V
Large Signal Voltage Gain	A_V	$R_L = 600\ \Omega$, $V_O = 1.0\text{ V}$ to 4.0 V	87	100		dB
		$T_A = -40^\circ\text{C}$ to $+85^\circ\text{C}$	73			
		$R_L = 2\text{ k}\Omega$, $V_O = 1.0\text{ V}$ to 4.0 V	84	99		
		$T_A = -40^\circ\text{C}$ to $+85^\circ\text{C}$	82			
Output Swing	V_{OH}	$R_L = 600\ \Omega$ to 2.5 V	4.75	4.84		V
		$T_A = -40^\circ\text{C}$ to $+85^\circ\text{C}$	4.7			
	V_{OL}	$R_L = 600\ \Omega$ to 2.5 V		0.17	0.33	
		$T_A = -40^\circ\text{C}$ to $+85^\circ\text{C}$			0.4	
	V_{OH}	$R_L = 2\text{ k}\Omega$ to 2.5 V	4.85	4.9		
		$T_A = -40^\circ\text{C}$ to $+85^\circ\text{C}$	4.8			
V_{OL}	$R_L = 2\text{ k}\Omega$ to 2.5 V		0.1	0.15		
	$T_A = -40^\circ\text{C}$ to $+85^\circ\text{C}$			0.2		
Output Current	I_O	Sourcing, $V_O = 0\text{ V}$	20	45		mA
		$T_A = -40^\circ\text{C}$ to $+85^\circ\text{C}$	10			
		Sinking, $V_O = 5\text{ V}$	20	40		
		$T_A = -40^\circ\text{C}$ to $+85^\circ\text{C}$	15			
Supply Current	I_{CC}			0.3	0.4	mA
		$T_A = -40^\circ\text{C}$ to $+85^\circ\text{C}$			0.6	
		LMV822 (Both Applications)		0.5	0.7	
		$T_A = -40^\circ\text{C}$ to $+85^\circ\text{C}$			0.9	
		LMV824 (All Four Applications)		1	1.3	
		$T_A = -40^\circ\text{C}$ to $+85^\circ\text{C}$			1.5	

LMV821, LMV824

5V AC ELECTRICAL CHARACTERISTICS Unless otherwise specified, all limits are guaranteed for $T_A = 25^\circ\text{C}$, $V_+ = 5\text{ V}$, $V_- = 0\text{ V}$, $V_{CM} = 2.0\text{ V}$, $V_O = V_+/2$ and $R_L > 1\text{ M}\Omega$. Typical specifications represent the most likely parametric norm. Min/Max specifications are guaranteed by testing, characterization, or statistical analysis.

Parameter	Symbol	Conditions	Min	Typ	Max	Unit
Slew Rate	SR	(Note 4)		2		V/ μS
Gain Bandwidth Product	GBWP			5.6		MHz
Phase Margin	θ_m			63		$^\circ$
Gain Margin	G_m			11.7		dB
Input-Referred Voltage Noise	e_n	$f = 1\text{ kHz}$, $V_{CM} = 1\text{ V}$		11		nV/ $\sqrt{\text{Hz}}$
Input-Referred Current Noise	i_n	$f = 1\text{ kHz}$		0.21		pA/ $\sqrt{\text{Hz}}$
Total Harmonic Distortion	THD	$f = 1\text{ kHz}$, $A_V = -2$, $R_L = 10\text{ k}\Omega$, $V_O = 4.11\text{ VPP}$		0.012		%
Amplifier-to-Amplifier Isolation		(Note 5)		135		dB

4. Connected as voltage follower with input step from 0.5 V to 3.5 V. Number specified is the average of the positive and negative slew rates.
5. Input referred, $R_L = 100\text{ k}\Omega$ connected to $V_+/2$. Each amp excited in turn with 1 kHz to produce $V_O = 3\text{ VPP}$. (For Supply Voltages $< 3\text{ V}$, $V_O = V_+$).

TYPICAL PERFORMANCE CHARACTERISTICS

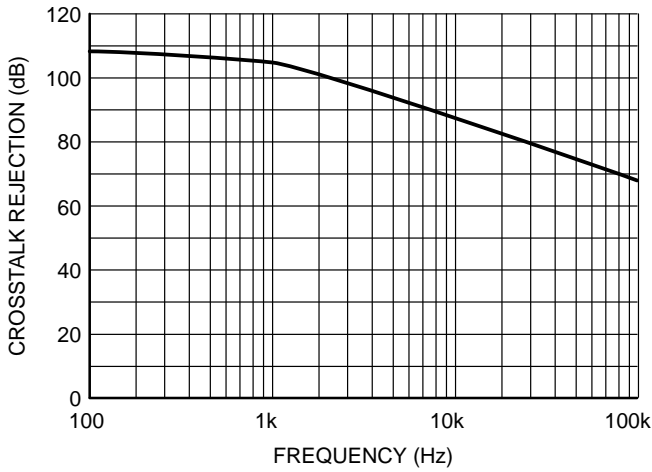

Figure 3. Crosstalk Rejection vs. Frequency

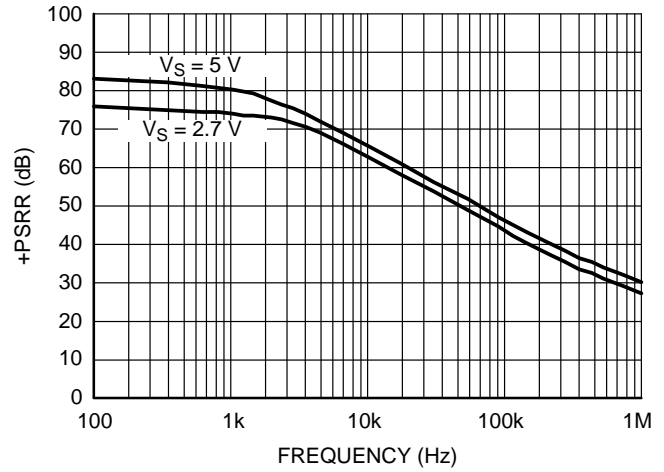

Figure 4. +PSRR vs. Frequency

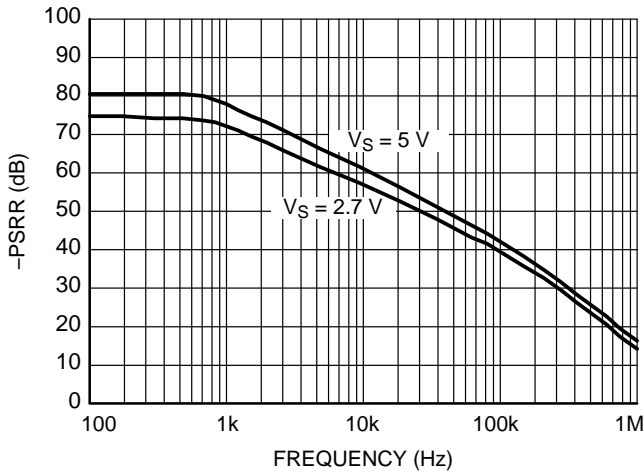

Figure 5. -PSRR vs. Frequency

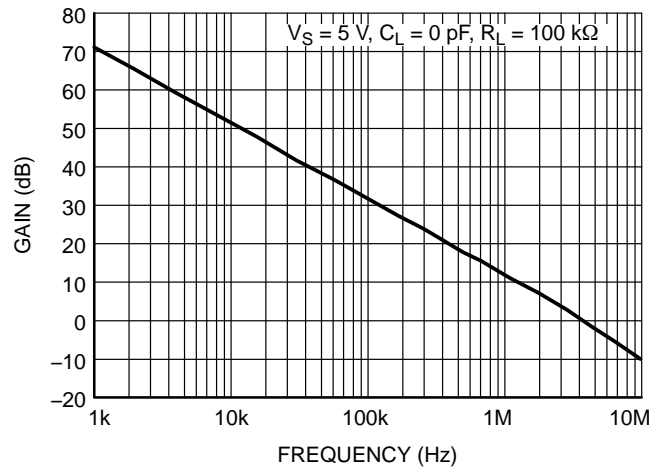

Figure 6. Gain vs. Frequency

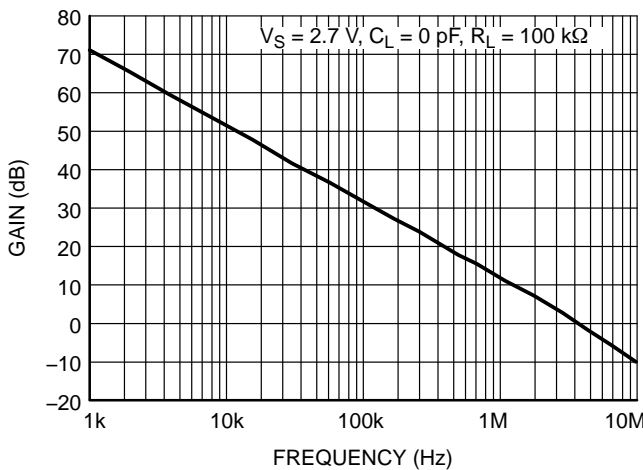

Figure 7. Gain vs. Frequency

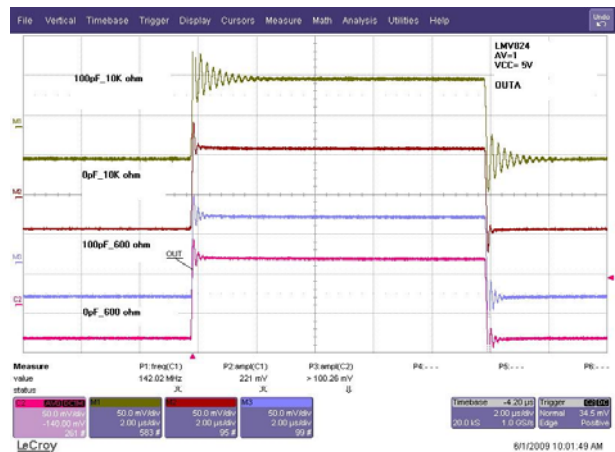

Figure 8. Non-Inverting Stability vs. Capacitive Load

LMV821, LMV824

TYPICAL PERFORMANCE CHARACTERISTICS

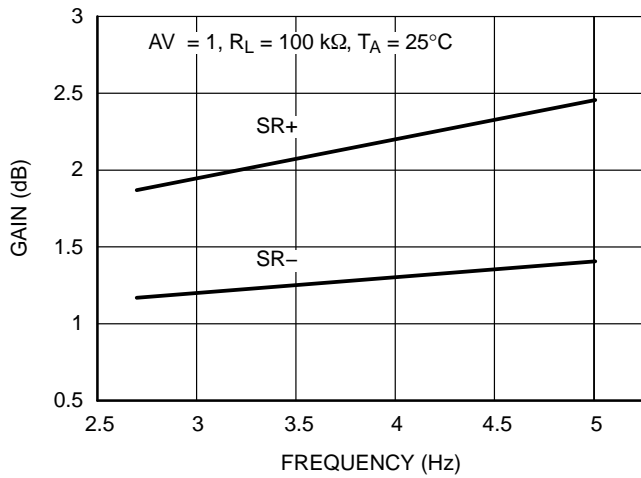

Figure 9. Gain vs. Frequency



Figure 10. Non-Inverting Large Signal Step Response

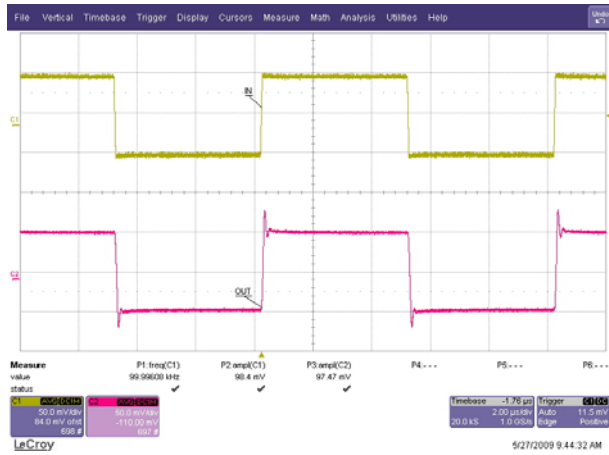

Figure 11. Non-Inverting Small Signal Step Response

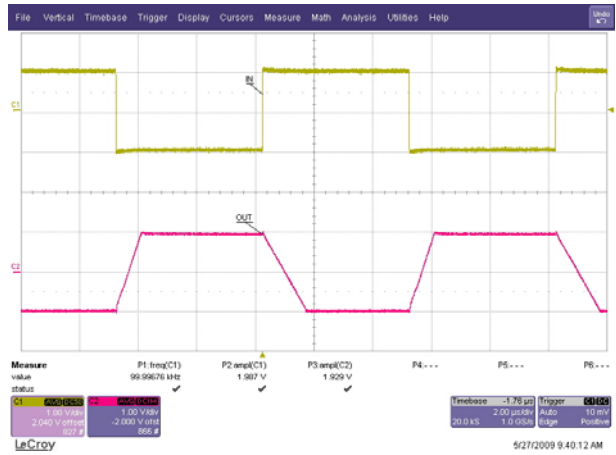

Figure 12. Inverting Large Signal Step Response



Figure 13. Inverting Small Signal Step Response

LMV821, LMV824

APPLICATIONS INFORMATION

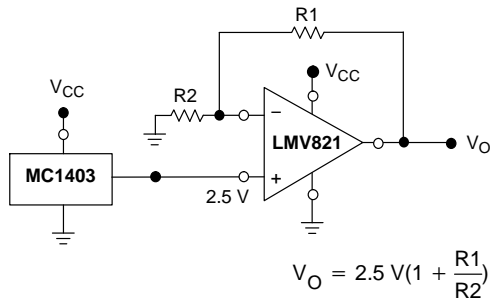

Figure 14. Voltage Reference

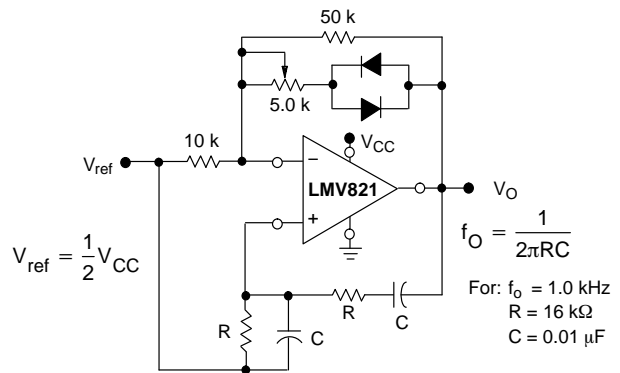

Figure 15. Wien Bridge Oscillator

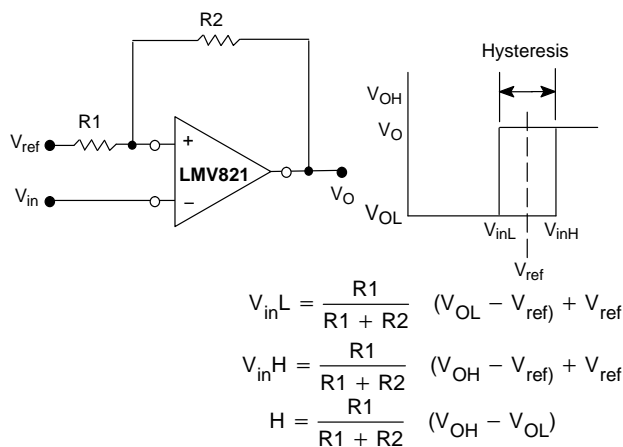
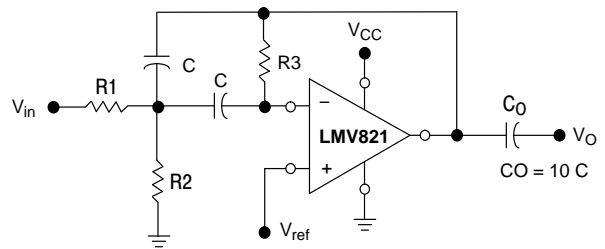

Figure 16. Comparator with Hysteresis



Given: f_o = center frequency
 $A(f_o)$ = gain at center frequency

Choose value f_o, C

$$\text{Then: } R_3 = \frac{Q}{\pi f_o C}$$

$$R_1 = \frac{R_3}{2 A(f_o)}$$

$$R_2 = \frac{R_1 R_3}{4Q^2 R_1 - R_3}$$

For less than 10% error from operational amplifier,
 $((Q_o f_o)/BW) < 0.1$ where f_o and BW are expressed in Hz.
 If source impedance varies, filter may be preceded with
 voltage follower buffer to stabilize filter parameters.

Figure 17. Multiple Feedback Bandpass Filter

MECHANICAL CASE OUTLINE

PACKAGE DIMENSIONS

ON Semiconductor®



SCALE 2:1

SC-88A (SC-70-5/SOT-353)
CASE 419A-02
ISSUE L

DATE 17 JAN 2013

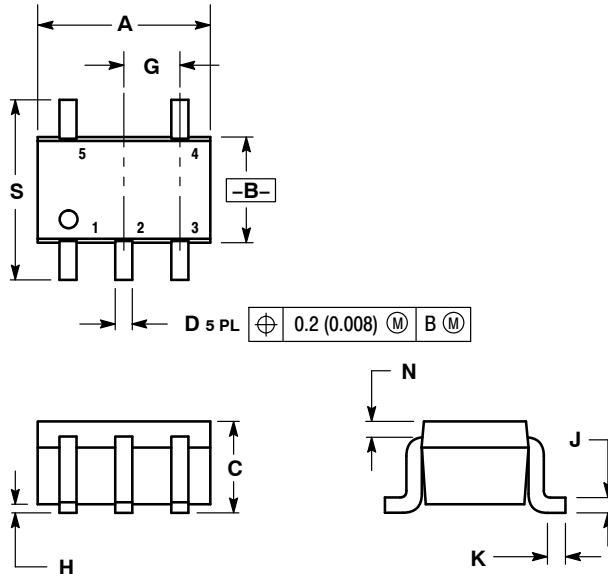

SOLDER FOOTPRINT

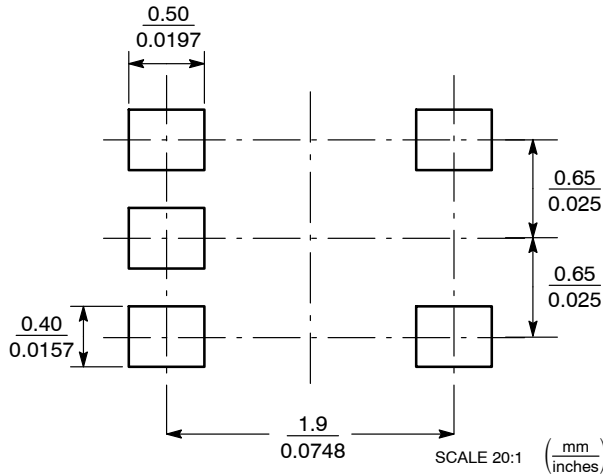

NOTES:

1. DIMENSIONING AND TOLERANCING PER ANSI Y14.5M, 1982.
2. CONTROLLING DIMENSION: INCH.
3. 419A-01 OBSOLETE. NEW STANDARD 419A-02.
4. DIMENSIONS A AND B DO NOT INCLUDE MOLD FLASH, PROTRUSIONS, OR GATE BURRS.

DIM	INCHES		MILLIMETERS	
	MIN	MAX	MIN	MAX
A	0.071	0.087	1.80	2.20
B	0.045	0.053	1.15	1.35
C	0.031	0.043	0.80	1.10
D	0.004	0.012	0.10	0.30
G	0.026 BSC		0.65 BSC	
H	---	0.004	---	0.10
J	0.004	0.010	0.10	0.25
K	0.004	0.012	0.10	0.30
N	0.008 REF		0.20 REF	
S	0.079	0.087	2.00	2.20

GENERIC MARKING DIAGRAM*

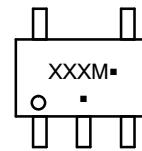

- XXX = Specific Device Code
- M = Date Code
- = Pb-Free Package

(Note: Microdot may be in either location)

*This information is generic. Please refer to device data sheet for actual part marking. Pb-Free indicator, "G" or microdot "■", may or may not be present. Some products may not follow the Generic Marking.

- | | | | | |
|--|--|--|--|--|
| <p>STYLE 1:
PIN 1. BASE
2. EMITTER
3. BASE
4. COLLECTOR
5. COLLECTOR</p> | <p>STYLE 2:
PIN 1. ANODE
2. EMITTER
3. BASE
4. COLLECTOR
5. CATHODE</p> | <p>STYLE 3:
PIN 1. ANODE 1
2. N/C
3. ANODE 2
4. CATHODE 2
5. CATHODE 1</p> | <p>STYLE 4:
PIN 1. SOURCE 1
2. DRAIN 1/2
3. SOURCE 1
4. GATE 1
5. GATE 2</p> | <p>STYLE 5:
PIN 1. CATHODE
2. COMMON ANODE
3. CATHODE 2
4. CATHODE 3
5. CATHODE 4</p> |
| <p>STYLE 6:
PIN 1. EMITTER 2
2. BASE 2
3. EMITTER 1
4. COLLECTOR
5. COLLECTOR 2/BASE 1</p> | <p>STYLE 7:
PIN 1. BASE
2. EMITTER
3. BASE
4. COLLECTOR
5. COLLECTOR</p> | <p>STYLE 8:
PIN 1. CATHODE
2. COLLECTOR
3. N/C
4. BASE
5. EMITTER</p> | <p>STYLE 9:
PIN 1. ANODE
2. CATHODE
3. ANODE
4. ANODE
5. ANODE</p> | <p>Note: Please refer to datasheet for style callout. If style type is not called out in the datasheet refer to the device datasheet pinout or pin assignment.</p> |

DOCUMENT NUMBER:	98ASB42984B	Electronic versions are uncontrolled except when accessed directly from the Document Repository. Printed versions are uncontrolled except when stamped "CONTROLLED COPY" in red.
DESCRIPTION:	SC-88A (SC-70-5/SOT-353)	PAGE 1 OF 1

ON Semiconductor and ON are trademarks of Semiconductor Components Industries, LLC dba ON Semiconductor or its subsidiaries in the United States and/or other countries. ON Semiconductor reserves the right to make changes without further notice to any products herein. ON Semiconductor makes no warranty, representation or guarantee regarding the suitability of its products for any particular purpose, nor does ON Semiconductor assume any liability arising out of the application or use of any product or circuit, and specifically disclaims any and all liability, including without limitation special, consequential or incidental damages. ON Semiconductor does not convey any license under its patent rights nor the rights of others.

MECHANICAL CASE OUTLINE PACKAGE DIMENSIONS



SCALE 1:1

SOIC-14 NB
CASE 751A-03
ISSUE L

DATE 03 FEB 2016

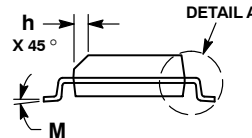

- NOTES:
1. DIMENSIONING AND TOLERANCING PER ASME Y14.5M, 1994.
 2. CONTROLLING DIMENSION: MILLIMETERS.
 3. DIMENSION b DOES NOT INCLUDE DAMBAR PROTRUSION. ALLOWABLE PROTRUSION SHALL BE 0.13 TOTAL IN EXCESS OF AT MAXIMUM MATERIAL CONDITION.
 4. DIMENSIONS D AND E DO NOT INCLUDE MOLD PROTRUSIONS.
 5. MAXIMUM MOLD PROTRUSION 0.15 PER SIDE.

DIM	MILLIMETERS		INCHES	
	MIN	MAX	MIN	MAX
A	1.35	1.75	0.054	0.068
A1	0.10	0.25	0.004	0.010
A3	0.19	0.25	0.008	0.010
b	0.35	0.49	0.014	0.019
D	8.55	8.75	0.337	0.344
E	3.80	4.00	0.150	0.157
e	1.27 BSC		0.050 BSC	
H	5.80	6.20	0.228	0.244
h	0.25	0.50	0.010	0.019
L	0.40	1.25	0.016	0.049
M	0°	7°	0°	7°

SOLDERING FOOTPRINT*



DIMENSIONS: MILLIMETERS

*For additional information on our Pb-Free strategy and soldering details, please download the ON Semiconductor Soldering and Mounting Techniques Reference Manual, SOLDERRM/D.

GENERIC MARKING DIAGRAM*



- XXXXXX = Specific Device Code
- A = Assembly Location
- WL = Wafer Lot
- Y = Year
- WW = Work Week
- G = Pb-Free Package

*This information is generic. Please refer to device data sheet for actual part marking. Pb-Free indicator, "G" or microdot "▪", may or may not be present. Some products may not follow the Generic Marking.

STYLES ON PAGE 2

DOCUMENT NUMBER:	98ASB42565B	Electronic versions are uncontrolled except when accessed directly from the Document Repository. Printed versions are uncontrolled except when stamped "CONTROLLED COPY" in red.
DESCRIPTION:	SOIC-14 NB	PAGE 1 OF 2

onsemi and onsemi are trademarks of Semiconductor Components Industries, LLC dba onsemi or its subsidiaries in the United States and/or other countries. onsemi reserves the right to make changes without further notice to any products herein. onsemi makes no warranty, representation or guarantee regarding the suitability of its products for any particular purpose, nor does onsemi assume any liability arising out of the application or use of any product or circuit, and specifically disclaims any and all liability, including without limitation special, consequential or incidental damages. onsemi does not convey any license under its patent rights nor the rights of others.

SOIC-14
CASE 751A-03
ISSUE L

DATE 03 FEB 2016

STYLE 1:
 PIN 1. COMMON CATHODE
 2. ANODE/CATHODE
 3. ANODE/CATHODE
 4. NO CONNECTION
 5. ANODE/CATHODE
 6. NO CONNECTION
 7. ANODE/CATHODE
 8. ANODE/CATHODE
 9. ANODE/CATHODE
 10. NO CONNECTION
 11. ANODE/CATHODE
 12. ANODE/CATHODE
 13. NO CONNECTION
 14. COMMON ANODE

STYLE 2:
 CANCELLED

STYLE 3:
 PIN 1. NO CONNECTION
 2. ANODE
 3. ANODE
 4. NO CONNECTION
 5. ANODE
 6. NO CONNECTION
 7. ANODE
 8. ANODE
 9. ANODE
 10. NO CONNECTION
 11. ANODE
 12. ANODE
 13. NO CONNECTION
 14. COMMON CATHODE

STYLE 4:
 PIN 1. NO CONNECTION
 2. CATHODE
 3. CATHODE
 4. NO CONNECTION
 5. CATHODE
 6. NO CONNECTION
 7. CATHODE
 8. CATHODE
 9. CATHODE
 10. NO CONNECTION
 11. CATHODE
 12. CATHODE
 13. NO CONNECTION
 14. COMMON ANODE

STYLE 5:
 PIN 1. COMMON CATHODE
 2. ANODE/CATHODE
 3. ANODE/CATHODE
 4. ANODE/CATHODE
 5. ANODE/CATHODE
 6. NO CONNECTION
 7. COMMON ANODE
 8. COMMON CATHODE
 9. ANODE/CATHODE
 10. ANODE/CATHODE
 11. ANODE/CATHODE
 12. ANODE/CATHODE
 13. NO CONNECTION
 14. COMMON ANODE

STYLE 6:
 PIN 1. CATHODE
 2. CATHODE
 3. CATHODE
 4. CATHODE
 5. CATHODE
 6. CATHODE
 7. CATHODE
 8. ANODE
 9. ANODE
 10. ANODE
 11. ANODE
 12. ANODE
 13. ANODE
 14. ANODE

STYLE 7:
 PIN 1. ANODE/CATHODE
 2. COMMON ANODE
 3. COMMON CATHODE
 4. ANODE/CATHODE
 5. ANODE/CATHODE
 6. ANODE/CATHODE
 7. ANODE/CATHODE
 8. ANODE/CATHODE
 9. ANODE/CATHODE
 10. ANODE/CATHODE
 11. COMMON CATHODE
 12. COMMON ANODE
 13. ANODE/CATHODE
 14. ANODE/CATHODE

STYLE 8:
 PIN 1. COMMON CATHODE
 2. ANODE/CATHODE
 3. ANODE/CATHODE
 4. NO CONNECTION
 5. ANODE/CATHODE
 6. ANODE/CATHODE
 7. COMMON ANODE
 8. COMMON ANODE
 9. ANODE/CATHODE
 10. ANODE/CATHODE
 11. NO CONNECTION
 12. ANODE/CATHODE
 13. ANODE/CATHODE
 14. COMMON CATHODE

DOCUMENT NUMBER:	98ASB42565B	Electronic versions are uncontrolled except when accessed directly from the Document Repository. Printed versions are uncontrolled except when stamped "CONTROLLED COPY" in red.
DESCRIPTION:	SOIC-14 NB	PAGE 2 OF 2

onsemi and **ONSEMI** are trademarks of Semiconductor Components Industries, LLC dba **onsemi** or its subsidiaries in the United States and/or other countries. **onsemi** reserves the right to make changes without further notice to any products herein. **onsemi** makes no warranty, representation or guarantee regarding the suitability of its products for any particular purpose, nor does **onsemi** assume any liability arising out of the application or use of any product or circuit, and specifically disclaims any and all liability, including without limitation special, consequential or incidental damages. **onsemi** does not convey any license under its patent rights nor the rights of others.

MECHANICAL CASE OUTLINE PACKAGE DIMENSIONS



TSSOP-14 WB
CASE 948G
ISSUE C

DATE 17 FEB 2016

SCALE 2:1



NOTES:

1. DIMENSIONING AND TOLERANCING PER ANSI Y14.5M, 1982.
2. CONTROLLING DIMENSION: MILLIMETER.
3. DIMENSION A DOES NOT INCLUDE MOLD FLASH, PROTRUSIONS OR GATE BURRS. MOLD FLASH OR GATE BURRS SHALL NOT EXCEED 0.15 (0.006) PER SIDE.
4. DIMENSION B DOES NOT INCLUDE INTERLEAD FLASH OR PROTRUSION. INTERLEAD FLASH OR PROTRUSION SHALL NOT EXCEED 0.25 (0.010) PER SIDE.
5. DIMENSION K DOES NOT INCLUDE DAMBAR PROTRUSION. ALLOWABLE DAMBAR PROTRUSION SHALL BE 0.08 (0.003) TOTAL IN EXCESS OF THE K DIMENSION AT MAXIMUM MATERIAL CONDITION.
6. TERMINAL NUMBERS ARE SHOWN FOR REFERENCE ONLY.
7. DIMENSION A AND B ARE TO BE DETERMINED AT DATUM PLANE -W-.

DIM	MILLIMETERS		INCHES	
	MIN	MAX	MIN	MAX
A	4.90	5.10	0.193	0.200
B	4.30	4.50	0.169	0.177
C	---	1.20	---	0.047
D	0.05	0.15	0.002	0.006
F	0.50	0.75	0.020	0.030
G	0.65 BSC		0.026 BSC	
H	0.50	0.60	0.020	0.024
J	0.09	0.20	0.004	0.008
J1	0.09	0.16	0.004	0.006
K	0.19	0.30	0.007	0.012
K1	0.19	0.25	0.007	0.010
L	6.40 BSC		0.252 BSC	
M	0°	8°	0°	8°

GENERIC MARKING DIAGRAM*



- A = Assembly Location
- L = Wafer Lot
- Y = Year
- W = Work Week
- = Pb-Free Package

(Note: Microdot may be in either location)

*This information is generic. Please refer to device data sheet for actual part marking. Pb-Free indicator, "G" or microdot "▪", may or may not be present. Some products may not follow the Generic Marking.

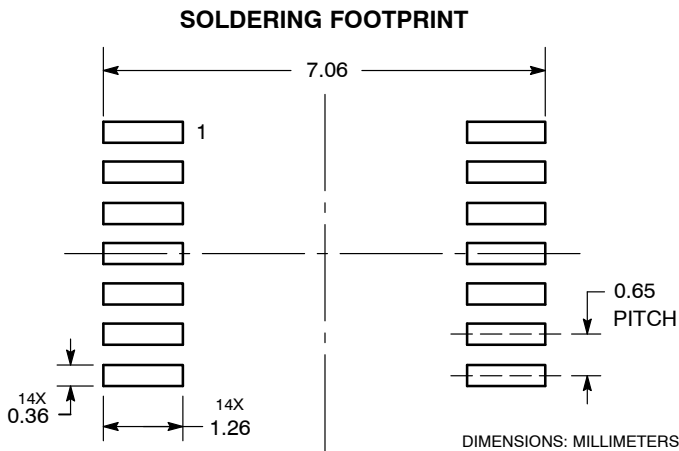

DOCUMENT NUMBER:	98ASH70246A	Electronic versions are uncontrolled except when accessed directly from the Document Repository. Printed versions are uncontrolled except when stamped "CONTROLLED COPY" in red.
DESCRIPTION:	TSSOP-14 WB	PAGE 1 OF 1

onsemi and onsemi are trademarks of Semiconductor Components Industries, LLC dba onsemi or its subsidiaries in the United States and/or other countries. onsemi reserves the right to make changes without further notice to any products herein. onsemi makes no warranty, representation or guarantee regarding the suitability of its products for any particular purpose, nor does onsemi assume any liability arising out of the application or use of any product or circuit, and specifically disclaims any and all liability, including without limitation special, consequential or incidental damages. onsemi does not convey any license under its patent rights nor the rights of others.

onsemi, **Onsemi**, and other names, marks, and brands are registered and/or common law trademarks of Semiconductor Components Industries, LLC dba "**onsemi**" or its affiliates and/or subsidiaries in the United States and/or other countries. **onsemi** owns the rights to a number of patents, trademarks, copyrights, trade secrets, and other intellectual property. A listing of **onsemi**'s product/patent coverage may be accessed at www.onsemi.com/site/pdf/Patent-Marking.pdf. **onsemi** reserves the right to make changes at any time to any products or information herein, without notice. The information herein is provided "as-is" and **onsemi** makes no warranty, representation or guarantee regarding the accuracy of the information, product features, availability, functionality, or suitability of its products for any particular purpose, nor does **onsemi** assume any liability arising out of the application or use of any product or circuit, and specifically disclaims any and all liability, including without limitation special, consequential or incidental damages. Buyer is responsible for its products and applications using **onsemi** products, including compliance with all laws, regulations and safety requirements or standards, regardless of any support or applications information provided by **onsemi**. "Typical" parameters which may be provided in **onsemi** data sheets and/or specifications can and do vary in different applications and actual performance may vary over time. All operating parameters, including "Typicals" must be validated for each customer application by customer's technical experts. **onsemi** does not convey any license under any of its intellectual property rights nor the rights of others. **onsemi** products are not designed, intended, or authorized for use as a critical component in life support systems or any FDA Class 3 medical devices or medical devices with a same or similar classification in a foreign jurisdiction or any devices intended for implantation in the human body. Should Buyer purchase or use **onsemi** products for any such unintended or unauthorized application, Buyer shall indemnify and hold **onsemi** and its officers, employees, subsidiaries, affiliates, and distributors harmless against all claims, costs, damages, and expenses, and reasonable attorney fees arising out of, directly or indirectly, any claim of personal injury or death associated with such unintended or unauthorized use, even if such claim alleges that **onsemi** was negligent regarding the design or manufacture of the part. **onsemi** is an Equal Opportunity/Affirmative Action Employer. This literature is subject to all applicable copyright laws and is not for resale in any manner.

PUBLICATION ORDERING INFORMATION

LITERATURE FULFILLMENT:

Email Requests to: orderlit@onsemi.com

onsemi Website: www.onsemi.com

TECHNICAL SUPPORT

North American Technical Support:

Voice Mail: 1 800-282-9855 Toll Free USA/Canada

Phone: 011 421 33 790 2910

Europe, Middle East and Africa Technical Support:

Phone: 00421 33 790 2910

For additional information, please contact your local Sales Representative