



College of Engineering and Applied Science
Department of Civil Engineering and Mechanics

Structural Engineering Laboratories

Load Tests on New PSA Slotted Inserts Anchored in Concrete Slabs

Report on Test Results
February 7, 2007

by:

A. Fattah Shaikh, P.E., Ph.D.
Fellow, Distinguished Educator, and Titan: PCI
Fellow: ASCE, ACI
Emeritus Professor: University of Wisconsin-Milwaukee

and

Jeffrey Gehlhoff, M.S. (Candidate)
University of Wisconsin-Milwaukee

I. PREFACE

This report documents results of shear and pullout load tests on 78 JVI, Inc. NEW PSA Slotted Inserts. The tests were carried out at the Metromont Corporation plant in Hiram, GA during July 17-21, 2006. This test program also included load tests of JVI's Spider Plate; the results of those tests are summarized in a separate report.

The NEW PSA inserts were embedded in 5" thick concrete slabs. Slabs were cast on site at the Metromont Corporation plant during a normal day's production. The tests were carried out under monotonic pullout and shear loading conditions.

II. ACKNOWLEDGEMENTS

The writers are pleased to have participated in this program sponsored by JVI. It is an excellent example of cooperation between a precast producer—Metromont, connection materials manufacturer/supplier—JVI, and an education and research organization—University of Wisconsin- Milwaukee. We believe that such cooperation can produce highly authentic results for the benefit of the precast/prestressed concrete industry.

The JVI team included Mr. David Jablonsky, PE.—his expertise and energy were instrumental in establishing the test program and in developing many details included in this report. The other member of the JVI team intimately involved in this project was Mr. Charles Magnesio; his leadership in steering this test program is gratefully acknowledged. The writers also wish to thank Chuck and Dave for their “southern hospitality” over the duration of the test program.

The excellent and cordial cooperation of the Metromont Corporation’s Hiram, GA plant staff played a vital role in the success of this program. A special thanks to Harry Gleich, PE – VP Engineering and John Wenkel – VP/General Manager for design testing input and plant usage and assistance.

Finally, the writers wish to recognize the guidance of Professor Al Ghorbanpoor, Director of the UWM Structural Engineering Laboratory and the invaluable cooperation of Mr. Rahim Reshadi, Supervising Technician of the Laboratory. Mr. Reshadi not only assisted with the pre-planning of the test program and calibration of the equipment but also helped with the set-up of the instrumentation and the test equipment at the test site.

II. TEST SPECIMENS

SLABS

All details of test specimens were developed by JVI in consultation with the writers. The fabrication of the test specimens was supervised by the JVI team, and actual testing was done in the presence of both the UWM and JVI teams. Slabs were cast during a normal production run using a Metromont 6000psi concrete mix design. Concrete cylinder strength tests were performed by Metromont quality control personnel, the results of which are shown in Tables A-1 and A-1a of the Appendix. A total of four slabs were cast, labeled A, B, C, and D. Slabs A and B were used for testing JVI New PSA Inserts, as summarized in this report. Slabs C and D were used for Spider plate testing, results of which are summarized in a separate report. Production drawings of slabs A and B are shown in Figures A-1 and A-2 of the Appendix.

Slab A had overall dimensions of 10'-0" x 12'-0", with uniform thickness of 5". The slab was nominally reinforced with 4x4 – W4/W4 wire mesh with a bottom clear cover of 1 1/2". Thirty-four (34) New PSA inserts, hereafter referred to as 1A through 34A, respectively, were cast in the slab. Further details of each insert setup in slab A are described below and summarized in Tables A-2 and A-3 of the Appendix.

Slab B had overall dimensions of 13'-3" x 14'-6", with uniform thickness of 5". The slab was nominally reinforced with 4x4 – W4/W4 wire mesh with a bottom clear cover of 1 1/2". Wire mesh certifications can be found in Figure A-3 of the Appendix. PVC pipe with inside diameter of 1" was used to cast several holes in the slab for tie-down of bracing in the shear test setup (see Figure A-14 of the Appendix). Forty-four (44) New PSA inserts, hereafter referred to as 1B through 44B, respectively, were cast in the slab. Further details of each insert setup in slab B are described below and summarized in Tables A-4 and A-5 of the Appendix.

PSA INSERTS

Production details of all hardware used in these tests can be found in Figures A-4 through A-9 of the Appendix. Inserts tested were the recently re-designed PSA Slotted Inserts, with total depths varying between 2 1/2", 3 1/2", and 4 1/2". Loads were introduced to the inserts using either the new T-notch strap or the standard strap, rod, and nut assembly. Straps were tested both at locations centered and at the end of the New PSA strap slot. Inserts were tested both at locations near the slab edge as well as at locations deemed a sufficient distance from the slab edge such that edge conditions were not a factor in performance. A brief summary of testing variables are shown in Tables 1 and 2; a more robust summary of details is shown in Tables A-2 through A-5 of the Appendix.

Table 1: Summary of Insert Details for Slab A.

Test #	Insert & Strap	Load Applied	Slab	Edge Test (Y or N)	Strap Location In Slot
1A, 2A	N6025; 3/4" rod w/small nut	Pullout	5"	N	Centered
3A, 4A	N6025; 3/4" rod w/small nut	Pullout	5"	N	End
5A, 6A, 7A	N6035; 3/4" rod w/small nut	Pullout	5"	N	Centered
8A, 9A, 10A	N6035; 3/4" rod w/small nut	Pullout	5"	N	End
11A, 12A	N6045; 3/4" rod w/large nut	Pullout	5"	N	Centered
13A, 14A	N6045; 3/4" rod w/large nut	Pullout	5"	N	End
15A, 16A, 19A	N6045; 3/8" T-Notch	Pullout	5"	N	Centered
17A, 18A, 20A	N6045; 3/8" T-Notch	Pullout	5"	N	End
21A, 22A, 23A	N6025; 3/4" rod w/small nut	Pullout	5"	Y	Centered
24A, 25A, 26A	N6025; 3/4" rod w/small nut	Pullout	5"	Y	End
27A, 28A, 29A	N6035; 3/4" rod w/small nut	Pullout	5"	Y	Centered
30A, 31A, 32A	N6035; 3/4" rod w/small nut	Pullout	5"	Y	End
33A, 34A	N6045; 3/4" rod w/large nut	Pullout	5"	Y	Centered

Table 2: Summary of Insert Details for Slab B.

Test #	Insert & Strap	Load Applied	Slab	Edge Test (Y or N)	Strap Location In Slot	Eccentricity
1B, 2B, 28B	N6025; 3/8" T-Notch	Shear	5"	N	Centered	1"
3B, 4B, 29B	N6025; 3/8" T-Notch	Shear	5"	N	Centered	2"
5B, 6B, 30B	N6025; 3/8" T-Notch	Shear	5"	N	Centered	3"
7B, 8B	N6025; std. strap 3/4" thrd. w/small nut	Shear	5"	N	Centered	1"
9B, 10B	N6025; std. strap 3/4" thrd. w/small nut	Shear	5"	N	Centered	2"
11B, 12B, 31B	N6025; std. strap 3/4" thrd. w/small nut	Shear	5"	N	Centered	3"
13B, 14B	N6045; std. strap 3/4" thrd. w/large nut	Shear	5"	N	Centered	1"
15B, 16B	N6045; std. strap 3/4" thrd. w/large nut	Shear	5"	N	Centered	2"
17B, 18B	N6045; std. strap 3/4" thrd. w/large nut	Shear	5"	N	Centered	3"
19B, 20B, 21B	N6035; std. strap 3/4" thrd. w/small nut	Shear	5"	N	Centered	1"
22B, 23B, 24B	N6035; std. strap 3/4" thrd. w/small nut	Shear	5"	N	Centered	2"
25B, 26B, 27B	N6035; std. strap 3/4" thrd. w/small nut	Shear	5"	N	Centered	3"
32B	N6045; 3/8" T-Notch	Pullout	5"	N	Centered	--
33B	N6045; 3/4" rod w/large nut	Pullout	5"	Y	Centered	--
34B, 35B, 36B	N6045; 3/4" rod w/large nut	Pullout	5"	Y	End	--
37B, 38B, 39B, 43B	N6045; 3/8" T-Notch	Pullout	5"	Y	Centered	--
40B, 41B, 42B, 44B	N6045; 3/8" T-Notch	Pullout	5"	Y	End	--

III. TEST SETUP

Test setup for each type of load test is illustrated in Figures A-10 through A-16 of the Appendix.

For all tests, the load was applied with an Enerpac P-391 (10 ksi) hand pump coupled with an Enerpac 30 kip cylinder with 4" stroke, combined hereafter referred to as the "load jack". The load jack was calibrated at the UWM laboratory against a Tinius Olsen 300 kN universal testing machine. Calibration and cylinder pressure-load conversion chart is shown in Figure A-17 of the Appendix.

For tests where displacement measurements were taken, a 0.001" precision dial gage was use.

Setups for specific load test types are described below:

PULLOUT TESTS

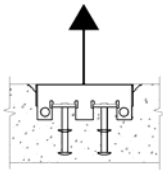

For pullout tests, a threaded rod was attached either to the T-notch strap with a splicing nut or directly to the nut in the PSA slot. The rod extended vertically through the center gap between two welded steel channels, the load cylinder, and several 1/2" steel plates. A rod nut was then placed at the top end of the rod and hand tightened against the steel plates. Load was applied by the load cylinder by extending vertically and compressing between the steel plates and the steel channels, applying a tension load to the rod that transferred to the PSA insert. The load cylinder was braced against the channels, which rested on wood blocks on both ends. The wood blocks transferred the reaction load back to the concrete slab a sufficient distance from the insert test, and the slab was braced against the ground from below where necessary. Pullout test setup is shown in Figures A-10 through A-13 of the Appendix.

Where applicable, displacement was measured in the vertical direction, with the dial gage extension placed on a steel extension clamped to the T-notch strap or rod within 1 1/2" vertically of the insert.

SHEAR TESTS

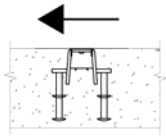

For shear tests, load was transferred to a load plate with a welded double-channel steel load beam. The load plate was welded to either the T-notch strap or the standard strap/rod/nut assembly, which was engaged with the insert slot. Welded steel blocks between the load beam channels were spaced at 6" edge to edge. The beam was lowered onto the load plate, with the load plate positioned in the 6" space. This arrangement applied a rotational fixity to the field plate to simulate field conditions. Eccentricity varied, and was measured as the distance from top of slab to the bottom of the load plate.

The load was applied horizontally (load parallel to the top of slab) by the load jack to one end of the load beam. The jack was braced against a tubular steel beam, which ran perpendicular to the load path and was tied down to the slab with a rod and nut assembly. The rod protruded through to the bottom of the slab via 1" diameter PVC knockouts cast into the slab. Shear test setup is shown in Figures A-14 through A-16 of the Appendix.

Where applicable, horizontal displacement was measured at the load beam end opposite to the load jack end.

IV. TEST RESULTS

Test results are given in Tables 3 through 6, and load-displacement plots are given in Figures 1 through 28. It should be noted that not all load-displacement plots show the full behavior of the PSA inserts through failure. For most tests, dial gages had to be removed after concrete cracked to prevent damage to the gages during failure.

Of special note is that several inserts had cracking in the immediately surrounding concrete prior to being load tested. This was due to crack propagation from other insert tests in the vicinity on the slab. Where such "pre-existing" cracks were observed it is noted in the results tables, and cracks were highlighted with red marker on the slab for easy identification in photographs.

Additionally for test 39B, which chronologically was the first test conducted, the test was stopped short due to slab failure. This condition was due to a lack of support beneath the cantilevered corner of the slab where the insert was located. Careful measures were taken on all following tests that sufficient support existed below the slab in the location of the tests.

Table 3: JVI PSA Slotted Insert Pullout Load Test Results

July 2006

Test #	Specimen Designation ¹ W-X-Y-Z	Slab ² Thickness	Pre-existing Crack	Cracking		Peak Load (lb)	Failure Mechanism	Comments				
				Load (lb)	Displace- ment (in)			Concrete	Age (days)	Slot Lips	Strap / Rod	Misc.
1A	25-A-Rs-C	5"	N	10,217	0.057	10,217	concrete	cone failure	14	OK	--	
2A	25-A-Rs-C	5"	N	11,145	0.037	12,539	concrete	cone failure	14	OK	--	
3A	25-A-Rs-E	5"	N	10,217	*	10,217	concrete	cone failure nut end	14	OK	--	
4A	25-A-Rs-E	5"	N	11,145	0.054	12,074	concrete	cone failure nut end	14	OK	--	
5A	35-A-Rs-C	5"	N	14,860	0.050	14,860	concrete	spalling one side (side of low end of nut)	14	OK	--	insert and nut set tilted to one side when cast
6A	35-A-Rs-C	5"	N	13,003	0.081	16,718	lips	small crack	14	shear rupture one side of slot	--	
7A	35-A-Rs-C	5"	N	17,647	0.057	20,433	concrete	cracked both ends	14	OK	--	
8A	35-A-Rs-E	5"	N	14,860	0.032	15,325	concrete	cone failure nut end	14	OK	--	concrete spalling spread to affect test 31A
9A	35-A-Rs-E	5"	N	13,003	*	13,932	concrete	cone failure nut end	14	slight bow	--	
10A	35-A-Rs-E	5"	N	13,003	*	15,789	concrete	cone failure nut end	14	OK	--	
11A	45-A-RI-C	5"	N	20,898	*	21,362	concrete	cracking	14	OK	--	
12A	45-A-RI-C	5"	N	18,576	0.073	20,433	concrete	spall one side; cracks both ends	14	OK	--	
32B	45-A-T-C	5"	Y	11,378	0.185	11,378	lips	cracked	12	lips yielded	OK	
13A	45-A-RI-E	5"	N	13,003	*	13,932	concrete	cracks both sides nut end	14	OK	--	
14A	45-A-RI-E	5"	N	14,860	0.047	17,182	concrete	cone failure nut end	14	OK	--	
15A	45-A-T-C	5"	N	**	**	11,145	lips	OK	14	yield, bowed up, no rupture	some yielding one notch corner	
16A	45-A-T-C	5"	N	12,074	*	12,074	lips	slight spalling one end	14	shear rupture one side of slot	yielding both notches	t-notch previously used for test 40B
19A	45-A-T-C	5"	N	**	**	13,003	lips	OK	14	yield, bowed up, no rupture	OK	
17A	45-A-T-E	5"	N	10,217	0.086	10,217	concrete	crack / spall strap end	14	slight bow	one notch yielded	
18A	45-A-T-E	5"	N	**	**	11,145	lips	OK	14	rupture both sides	both notches yielded	
20A	45-A-T-E	5"	Y	11,145	*	11,145	concrete	cone failure notch end	14	slight bow	one notch yielded	
21A	25-N-Rs-C	5"	Y	7,430	0.021	8,823	concrete	cracked one side top of slab and edge face	14	OK	--	
22A	25-N-Rs-C	5"	N	10,217	0.109	10,217	concrete	cracking edge face	14	OK	--	
23A	25-N-Rs-C	5"	N	9,288	*	9,288	concrete	cracking edge face	14	OK	--	
24A	25-N-Rs-E	5"	Y	7,430	*	7,430	concrete	cone failure	14	OK	--	

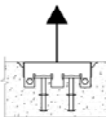

Pullout

NOTES: 1/ Specimen designation nomenclature:

W: 25 = Insert N6025 (2.5" total depth)
 35 = Insert N6035 (3.5" total depth)
 45 = Insert N6045 (4.5" total depth)

X: A = away from slab edge Y: T = T-notch strap
 N = near slab edge Rs = rod w/ small nut
 RI = rod w/ large nut

Z: C = strap or rod engaged at center of slot
 E = strap or rod engaged at end of slot

2/ Concrete strength: 6314 psi @ 11 days, 6558 psi @ 12 days, 6802 psi @ 13 days, 7046 psi @ 14 days

3/ Mesh (WWF) was not cut at any insert location.

* / Cracking displacement not available for this test

** / No observable concrete cracking occurred during test.

Table 4: JVI PSA Slotted Insert Pullout Load Test Results (Cont.)

July 2006

Test #	Specimen Designation ¹ W-X-Y-Z	Slab ² Thickness	Pre-existing Crack	Cracking		Peak Load (lb)	Failure Mechanism	Comments				
				Load (lb)	Displacement (in)			Concrete	Age (days)	Slot Lips	Strap / Rod	Misc.
25A	25-N-Rs-E	5"	N	10,217	*	10,217	concrete	cracks perpendicular to slot	14	OK	--	
26A	25-N-Rs-E	5"	N	6,501	*	6,501	concrete	cracking edge face	14	OK	--	nut at end of slot closest to slab edge
27A	35-N-Rs-C	5"	N	10,217	*	13,932	concrete	cone failure	14	OK	--	
28A	35-N-Rs-C	5"	Y	6,501	0.025	9,752	concrete	cone slab edge	14	OK	--	
29A	35-N-Rs-C	5"	N	6,501	0.008	12,539	concrete	cone failure	14	OK	--	
30A	35-N-Rs-E	5"	N	7,430	0.028	10,217	concrete	cone failure	14	OK	--	
31A	35-N-Rs-E	5"	N	10,217	0.037	11,145	concrete	cracked 45 deg. to edge	14	OK	--	
32A	35-N-Rs-E	5"	N	7,430	0.036	9,288	concrete	cone slab edge	14	OK	--	nut at end of slot closest to slab edge
33A	45-N-RI-C	5"	N	11,145	0.056	14,860	concrete	cracks slab top and edge face	14	OK	--	
34A	45-N-RI-C	5"	N	9,288	0.046	13,003	concrete	cone slab edge	14	OK	--	
33B	45-N-RI-C	5"	N	9,056	0.047	12,074	concrete	global slab cracking; local cracking both ends	12	OK	--	
34B	45-N-RI-E	5"	N	11,145	0.110	11,145	concrete	cone inside end; cracking both ends	12	OK	--	
35B	45-N-RI-E	5"	Y	11,145	*	11,145	concrete	cone inside end; cracking both ends	12	OK	--	
36B	45-N-RI-E	5"	N	7,895	0.108	11,145	concrete	spall one side; cracks both ends	12	OK	--	
37B	45-N-T-C	5"	Y	7,662	0.079	11,610	lips	cracking edge face	12	rupture both sides	OK	
38B	45-N-T-C	5"	Y	6,734	0.087	10,681	concrete	cracking edge face	12	shear rupture one side of slot	OK	
39B	45-N-T-C	5"	***	***	***	***	***	***	11	***	***	cantilevered slab corner cracked...test cancelled
43B	45-N-T-C	5"	N	5,573	0.059	12,539	lips	cracked top of slab and edge face	13	shear rupture one side of slot	OK	
40B	45-N-T-E	5"	Y	2,786	0.071	7,895	lips	some cracking	13	rupture both sides	OK	
41B	45-N-T-E	5"	Y	6,501	0.055	11,145	lips	cracked top of slab and edge face	13	rupture both sides	OK	
42B	45-N-T-E	5"	N	6,501	0.074	10,681	concrete	cracked top of slab and edge face	13	yield both sides no rupture	OK	
44B	45-N-T-E	5"	Y	6,966	0.095	9,288	concrete	cracked top of slab	13	slight bow	OK	cracked slab section

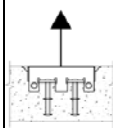

Pullout

NOTES: 1/ Specimen designation nomenclature:

W: 25 = Insert N6025 (2.5" total depth)
 35 = Insert N6035 (3.5" total depth)
 45 = Insert N6045 (4.5" total depth)

X: A = away from slab edge Y: T = T-notch strap
 N = near slab edge Rs = rod w/ small nut
 RI = rod w/ large nut

Z: C = strap or rod engaged at center of slot
 E = strap or rod engaged at end of slot

2/ Concrete strength: 6314 psi @ 11 days, 6558 psi @ 12 days, 6802 psi @ 13 days, 7046 psi @ 14 days
 3/ Mesh was not cut at any insert location

* / Cracking displacement not available for this test

** / No observable concrete cracking occurred during test.

*** / Test stopped due to slab failure. See 'Misc. Comments'.

Table 5: JVI PSA Slotted Insert Shear Load Test Results

July 2006

Test #	Specimen Designation ¹ W-X-Y-Z	Slab ² Thickness	Pre-existing Crack	Cracking		Peak Load (lb)	Failure Mechanism	Comments				
				Load (lb)	Displace- ment (in)			Concrete	Age (days)	Slot Lips	Strap / Rod	Misc.
1B	25-A-T-1	5"	N	12,771	0.290	12,771	strap	cracked tension side	12	bent	cracked near top of lip opposite load	load side notch slipping out of slot
2B	25-A-T-1	5"	N	12,306	0.221	13,932	strap	cracked tension side	12	bent	cracked near top of lip opposite load	
28B	25-A-T-1	5"	N	13,467	0.352	13,467	strap	global slab cracks, small local cracks	12	bent	bent and yielded; load side notch starting to slip	
3B	25-A-T-2	5"	N	**	**	13,003	strap	OK	12	bent	complete shear near top of lips	
4B	25-A-T-2	5"	N	13,003	0.481	13,003	strap	some cracking	12	bent	bent and yielded, no crack	
29B	25-A-T-2	5"	N	11,610	0.362	11,610	strap	some cracking	13	bent	cracked near top of lip opposite load side; slipped out of lips load side	
5B	25-A-T-3	5"	N	10,217	0.399	10,217	strap	cracking	12	bent	bent and yielded, no crack	
6B	25-A-T-3	5"	N	**	**	10,217	strap	OK	12	bent	bent and yielded, no crack	
30B	25-A-T-3	5"	N	7,430	0.409	9,288	strap	some cracking	12	bent	bent and yielded; slipping out of slot	
7B	25-A-Rs-1	5"	N	12,306	0.237	12,306	concrete	cracked and spalling tension side	12	OK	thread bent, strap OK	
8B	25-A-Rs-1	5"	N	11,610	0.305	11,610	concrete	cracked and spalling tension side	12	OK	thread bent, strap OK	
9B	25-A-Rs-2	5"	N	13,700	*	13,700	lips	small crack tension side	12	bent	thread bent, strap OK	
10B	25-A-Rs-2	5"	N	**	**	14,860	lips	OK	12	bent	thread bent, strap OK	
11B	25-A-Rs-3	5"	N	13,700	0.503	13,700	concrete	cracked and spalling tension side	12	OK	strap bent	
12B	25-A-Rs-3	5"	N	13,932	*	13,932	concrete	cracked and spalling tension side	12	OK	strap bent	
31B	25-A-Rs-3	5"	N	7,430	0.026	8,823	concrete	anchorage blowout tension side	12	bent	thread bent, strap OK	
13B	45-A-RI-1	5"	N	**	**	16,718	strap	OK	12	bent, cracked	thread bent, sheared	
14B	45-A-RI-1	5"	N	**	**	17,647	strap	OK	12	bent	thread bent, cracked near weld	
15B	45-A-RI-2	5"	N	**	**	15,789	strap	OK	12	OK	thread stripped, sheared	
16B	45-A-RI-2	5"	N	18,576	0.539	18,576	lips	cracked tension side	12	bent, cracked	thread bent, strap OK	
17B	45-A-RI-3	5"	N	7,430	0.327	10,217	strap	cracking tension side	11	OK	thread stripped, bent; strap OK	full thread not engaged on nut
18B	45-A-RI-3	5"	Y	12,771	0.469	14,860	concrete	cracked tension side	12	OK	strap bent	pre-existing slab cracked section
19B	35-A-Rs-1	5"	Y	**	**	12,539	nut slipped out of lips	OK	12	bent and cracked	threads bent strap OK	pre-existing slab cracked section
20B	35-A-Rs-1	5"	Y	**	**	12,306	nut slipped out of lips	OK	12	bent	threads bent strap OK	pre-existing slab cracked section
21B	35-A-Rs-1	5"	N	**	**	14,860	nut slipped out of lips	OK	12	bent	threads bent strap OK	



Shear

NOTES: 1/ Specimen designation nomenclature:
W: 25 = Insert N6025 (2.5" total depth) X: A = away from slab edge Y: T = T-notch strap
35 = Insert N6035 (3.5" total depth) N = near slab edge Rs = std. strap with threaded rod end & small nut
45 = Insert N6045 (4.5" total depth) RI = std. strap with threaded rod end & large nut
Z: 1 = 1" eccentricity (distance from top of slab to bottom of load plate)
2 = 2" eccentricity
3 = 3" eccentricity

2/ Concrete strength: 6314 psi @ 11 days, 6558 psi @ 12 days, 6802 psi @ 13 days, 7046 psi @ 14 days
3/ Mesh was not cut at any insert location.
4/ All straps were centered in the slot length.
*/ Cracking displacement not available for this test
**/ No observable concrete cracking occurred during test.

Table 6: JVI PSA Slotted Insert Shear Load Test Results (Cont.)

July 2006

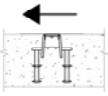
Test #	Specimen Designation ¹ W-X-Y-Z	Slab ² Thickness	Pre-existing Crack	Cracking		Peak Load (lb)	Failure Mechanism	Comments					
				Load (lb)	Displacement (in)			Concrete	Age (days)	Slot Lips	Strap / Rod	Misc.	
 <p>Shear</p>	22B	35-A-Rs-2	5"	N	**	**	14,860	strap	OK	12	bent	thread sheared	nut slipped out of lips after thread shear
	23B	35-A-Rs-2	5"	N	**	**	13,003	nut slipped out of lips	OK	12	bent and cracked	thread bent, strap OK	
	24B	35-A-Rs-2	5"	N	15,093	*	15,093	strap	cracked tension side	12	bent	thread sheared	nut slipped out of lips after thread shear
	25B	35-A-Rs-3	5"	N	13,932	*	15,325	concrete	global slab cracking to test 39B	11	OK	thread OK, strap bent	
	26B	35-A-Rs-3	5"	Y	**	**	16,254	slot lips	OK	11	bent	thread OK, strap bent	pre-existing slab cracked section
	27B	35-A-Rs-3	5"	N	11,145	*	11,145	concrete	cracked; see 'Misc. Comments'	12	bent	thread sheared	concrete global slab cracking was primary failure

NOTES: 1/ Specimen designation nomenclature:

W: 25 = Insert N6025 (2.5" total depth) X: A = away from slab edge Y: T = T-notch strap
 35 = Insert N6035 (3.5" total depth) N = near slab edge Rs = std. strap with threaded rod end & small nut
 45 = Insert N6045 (4.5" total depth) RI = std. strap with threaded rod end & large nut

Z: 1 = 1" eccentricity (distance from top of slab to bottom of load plate)
 2 = 2" eccentricity
 3 = 3" eccentricity

2/ Concrete strength: 6314 psi @ 11 days, 6558 psi @ 12 days, 6802 psi @ 13 days, 7046 psi @ 14 days

*/ Cracking displacement not available for this test

**/ No observable concrete cracking occurred during test.

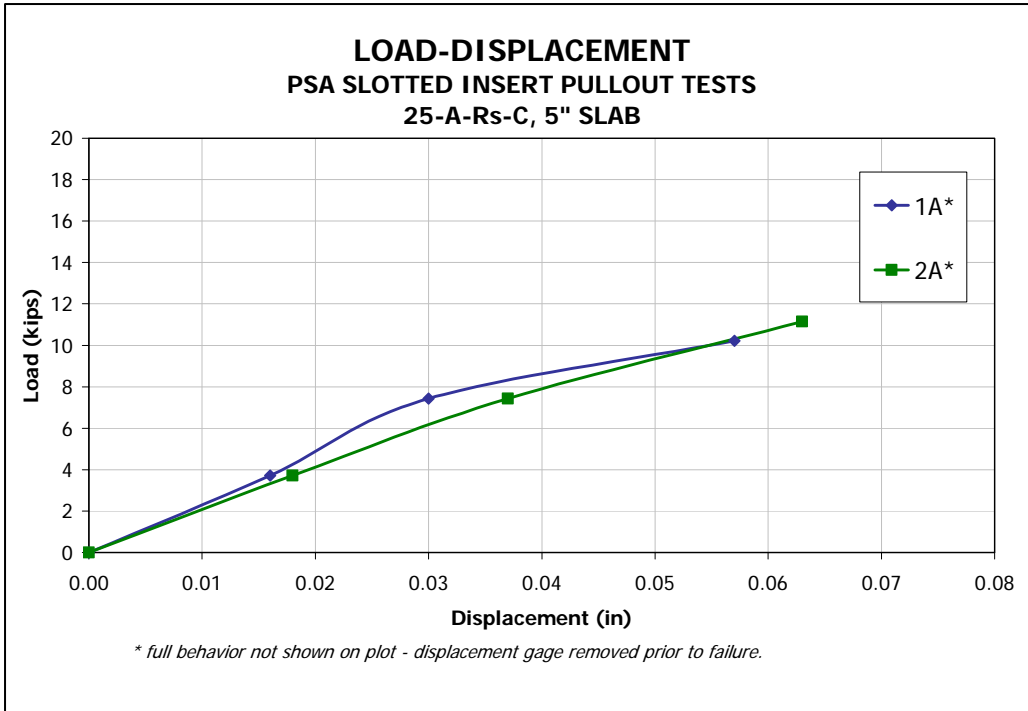

Figure 1: Load-displacement of tests 1A and 2A.

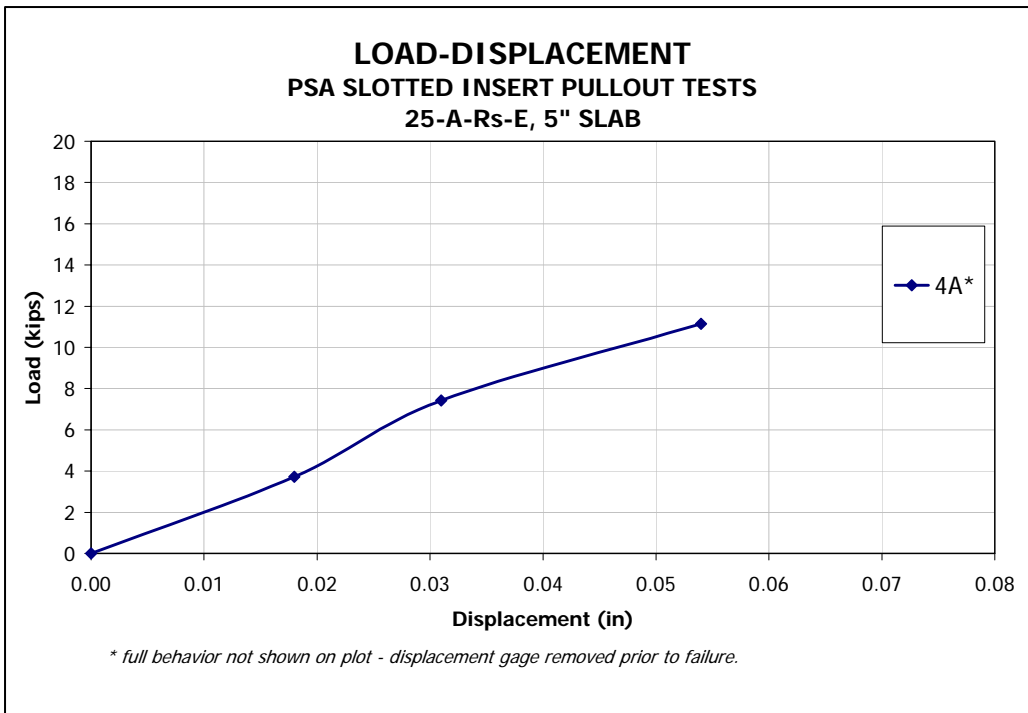

Figure 2: Load-displacement of test 4A.
NOTE: displacement measurements not taken for test #3A.

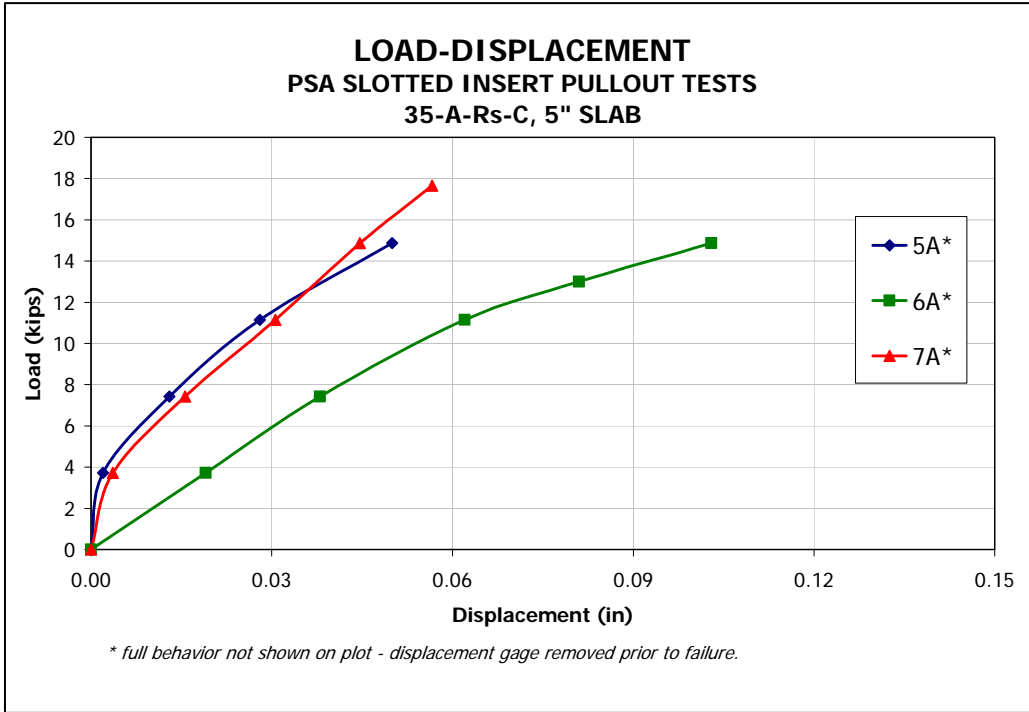

Figure 3: Load-displacement of tests 5A – 7A.

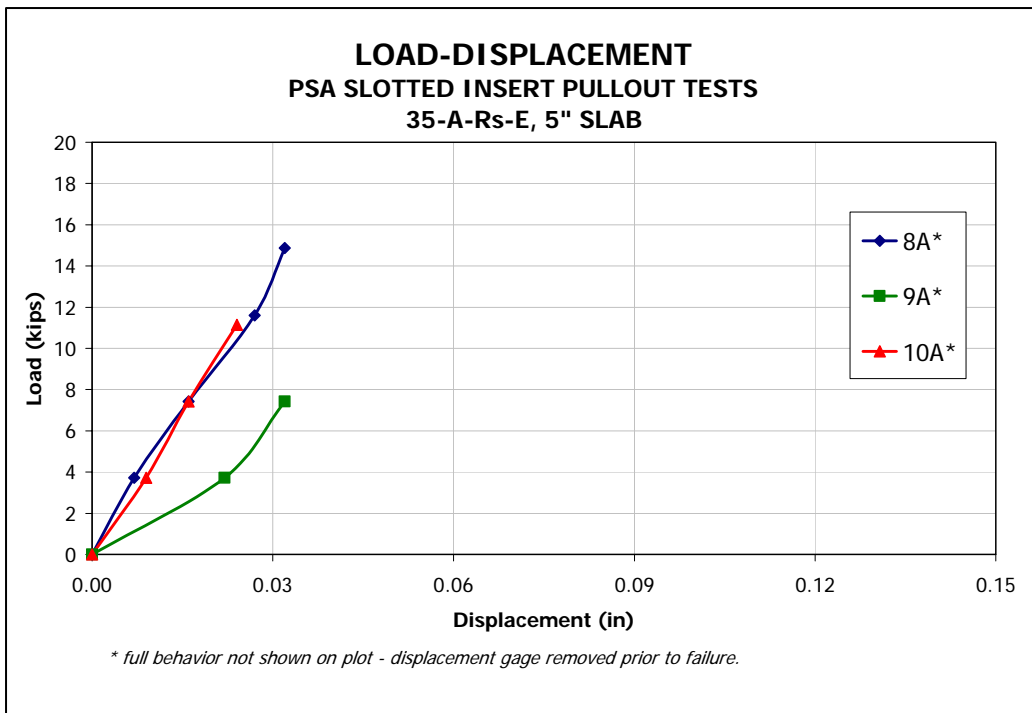

Figure 4: Load-displacement of tests 8A – 10A.

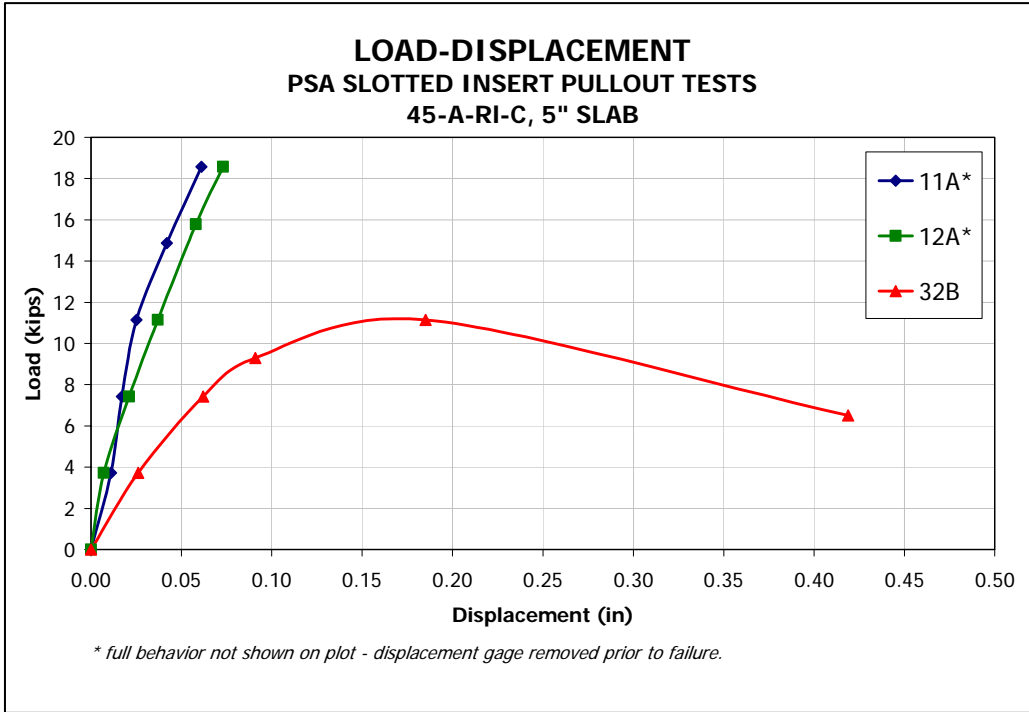

Figure 5: Load-displacement of tests 11A, 12A and 32B.

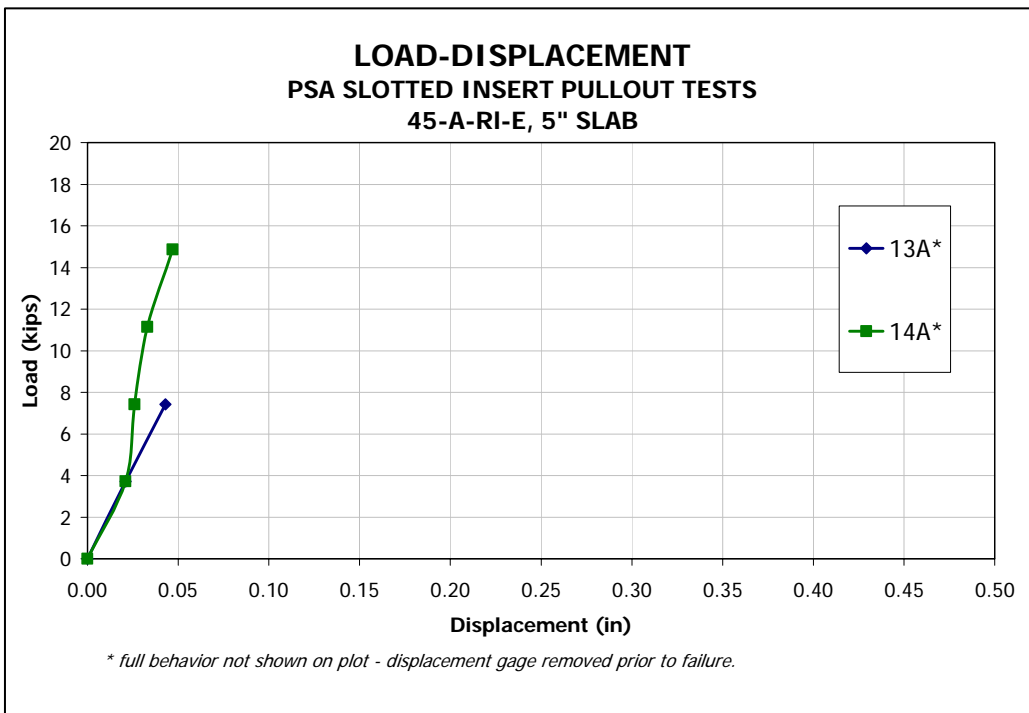

Figure 6: Load-displacement of tests 13A and 14A.

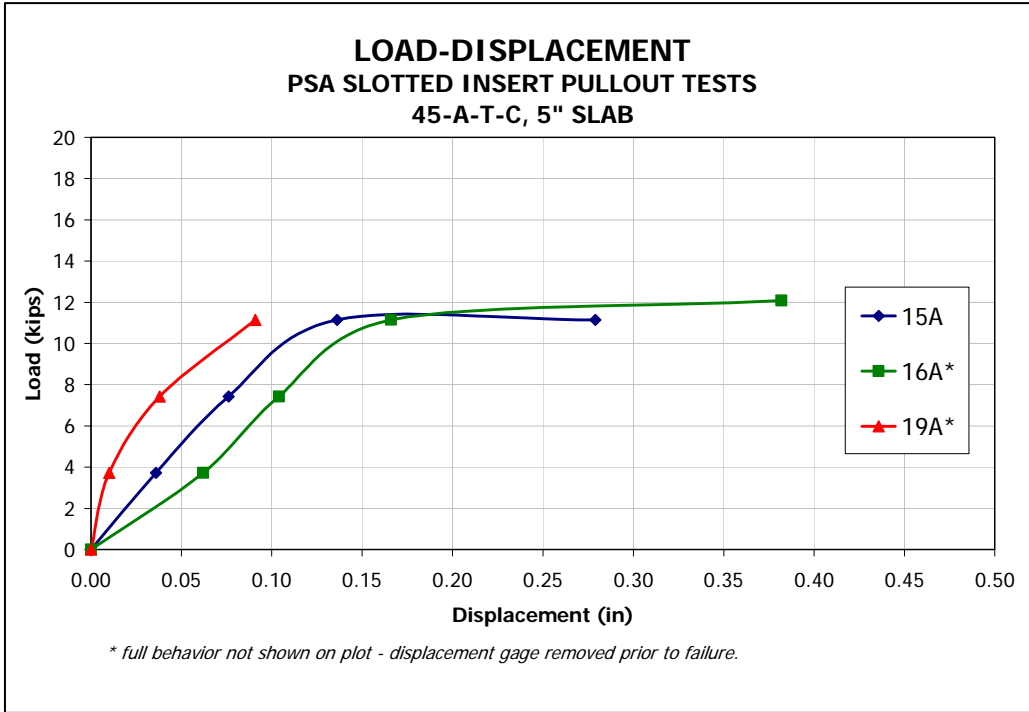

Figure 7: Load-displacement of tests 15A, 16A and 19A.

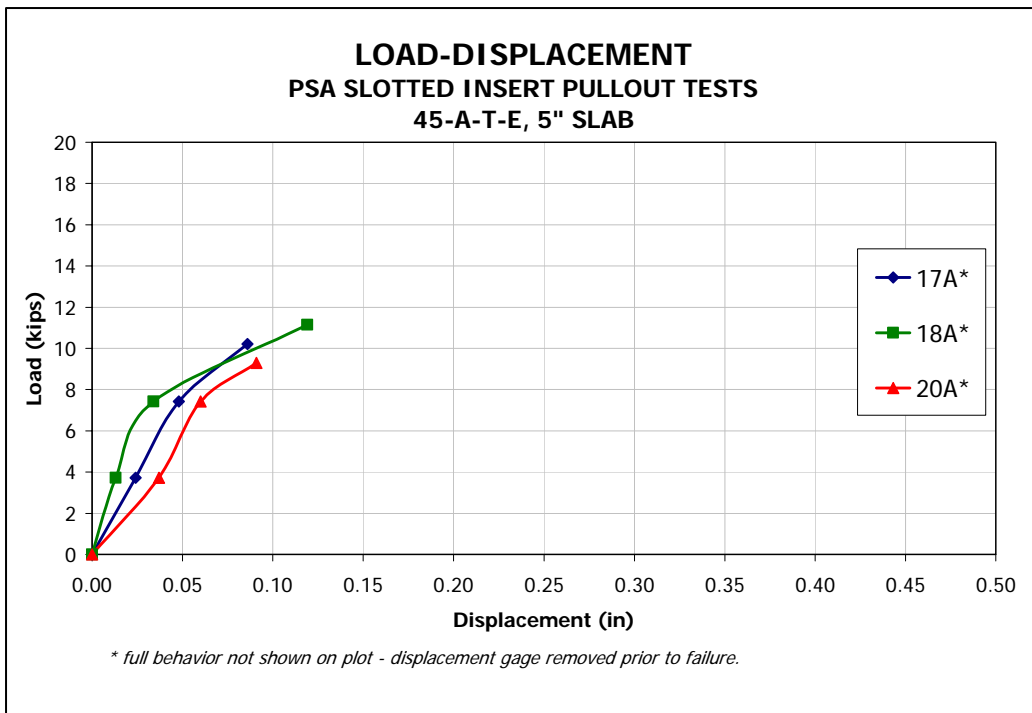

Figure 8: Load-displacement of tests 17A, 18A and 20A.

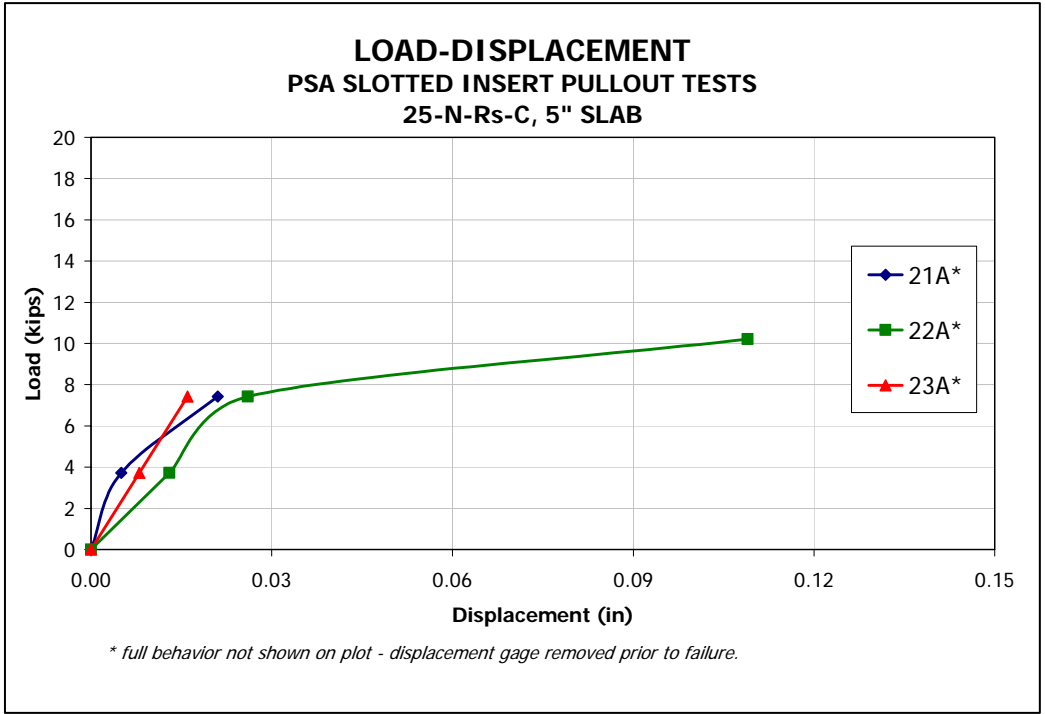

Figure 9: Load-displacement of tests 21A – 23A.

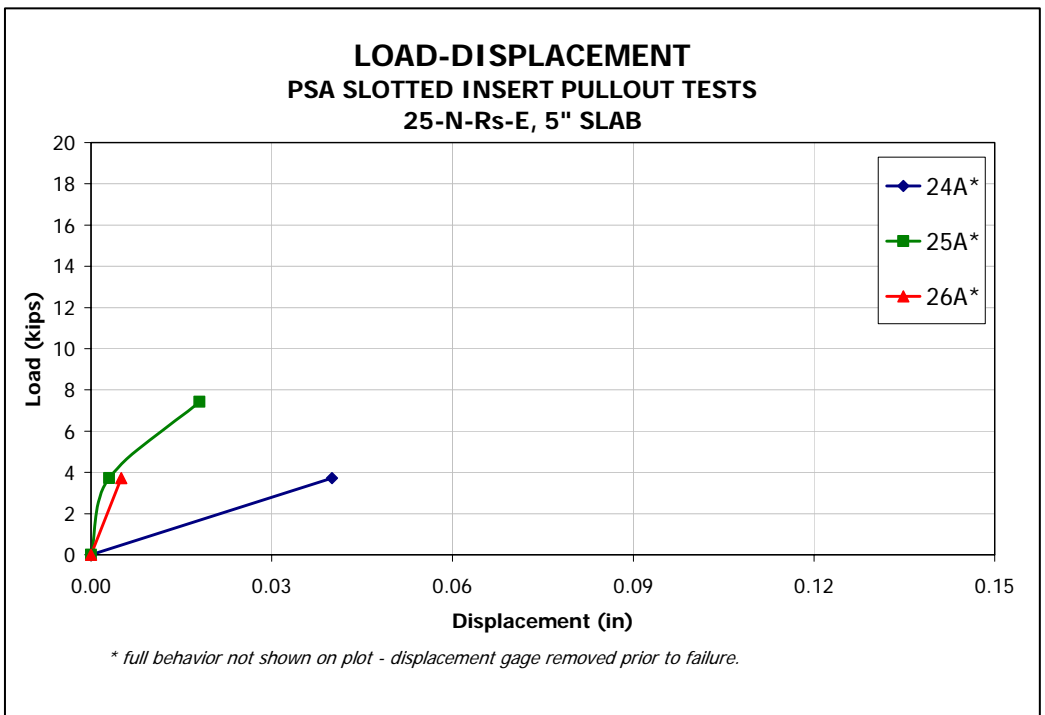

Figure 10: Load-displacement of tests 24A – 26A.

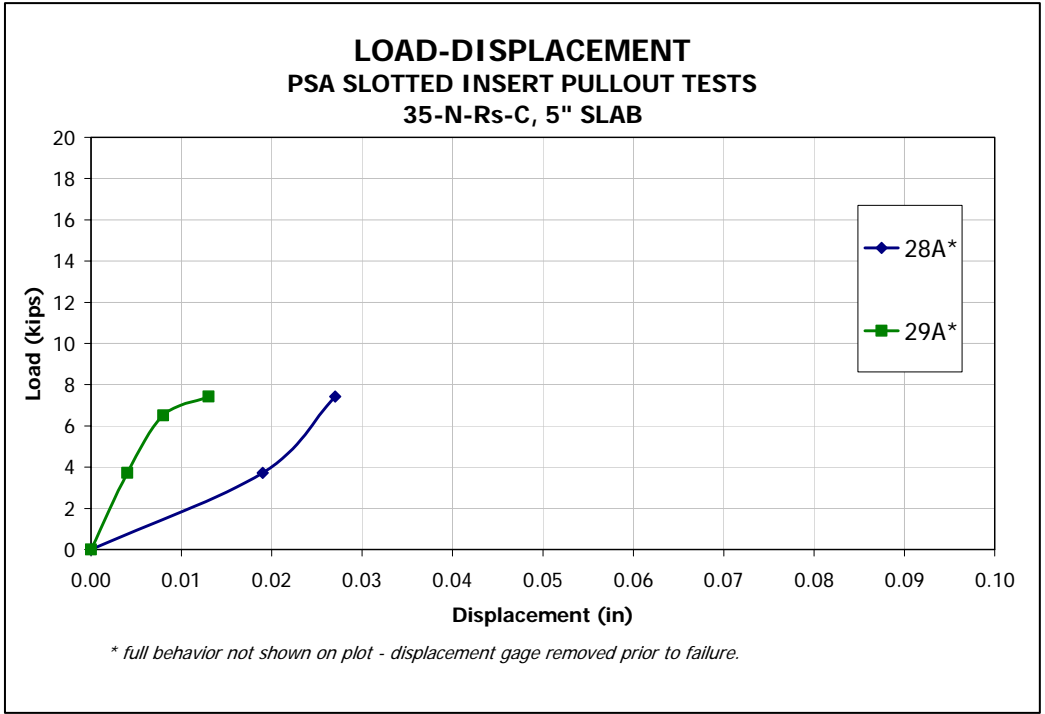

Figure 11: Load-displacement of tests 28A and 29A.

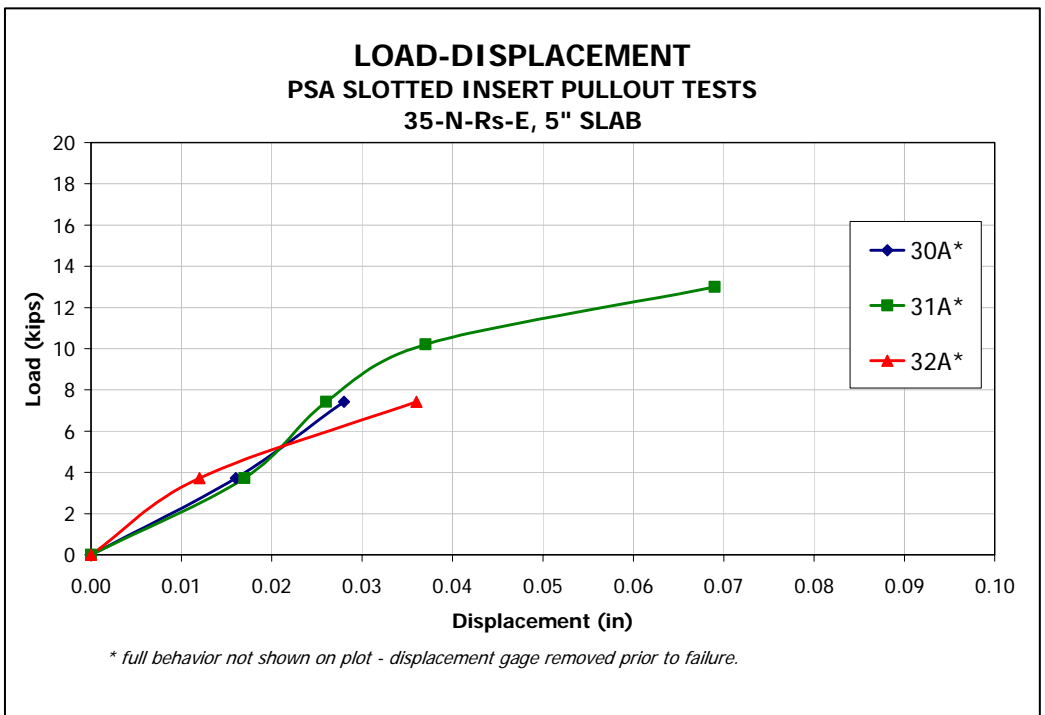

Figure 12: Load-displacement of tests 30A – 32A.

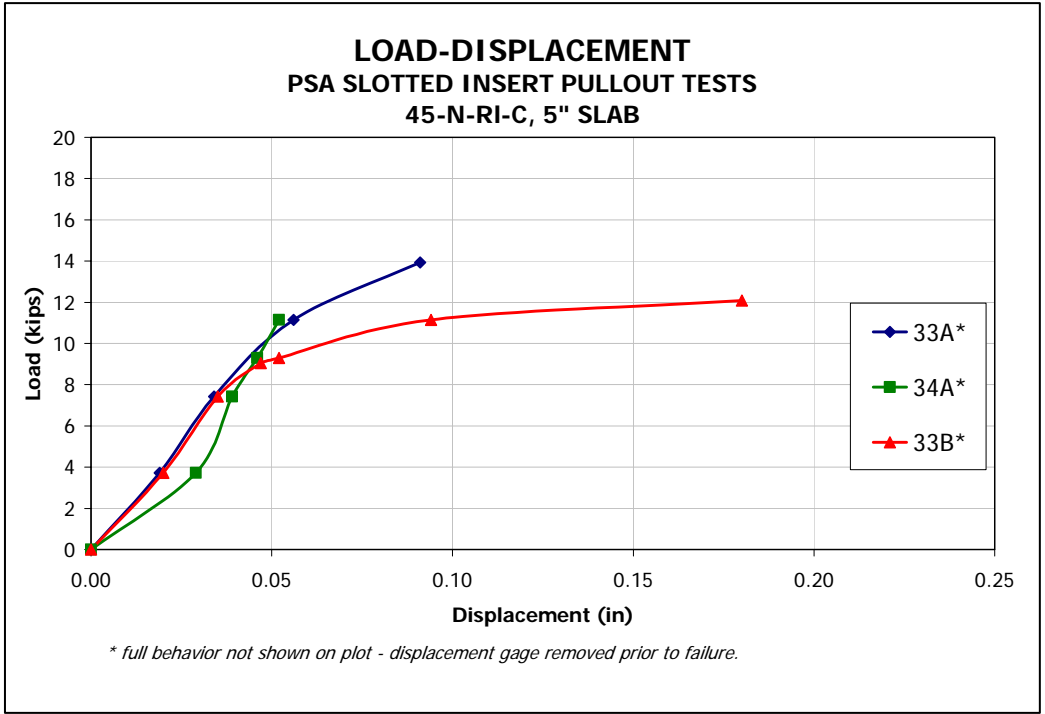

Figure 13: Load-displacement of tests 33A, 34A and 33B.

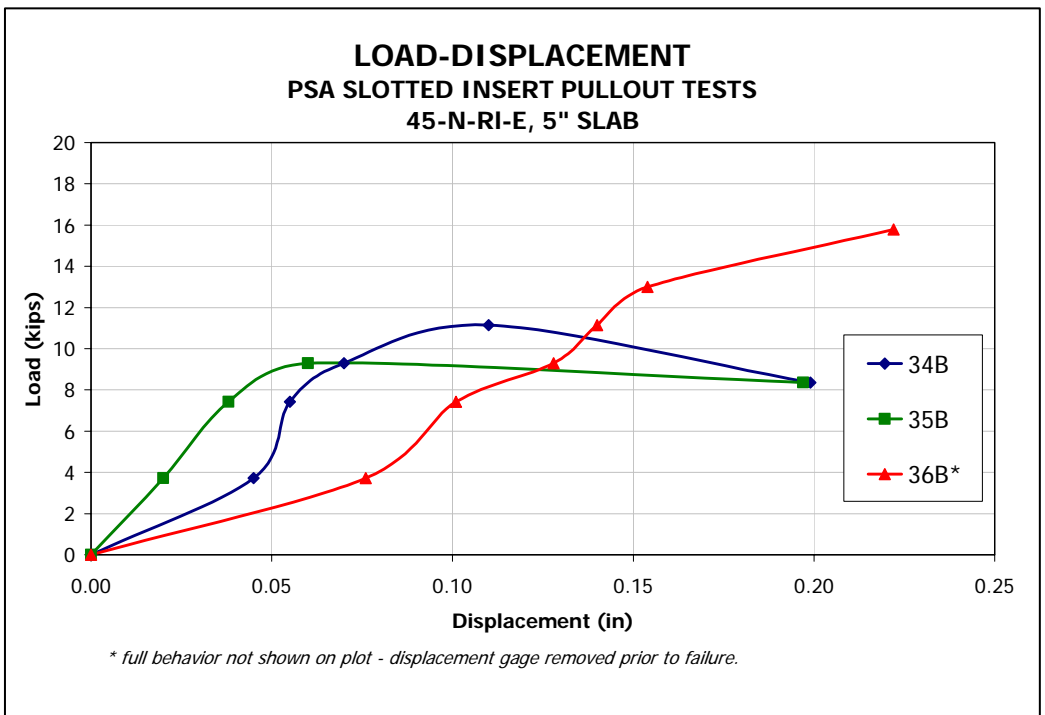

Figure 14: Load-displacement of tests 34B – 36B.

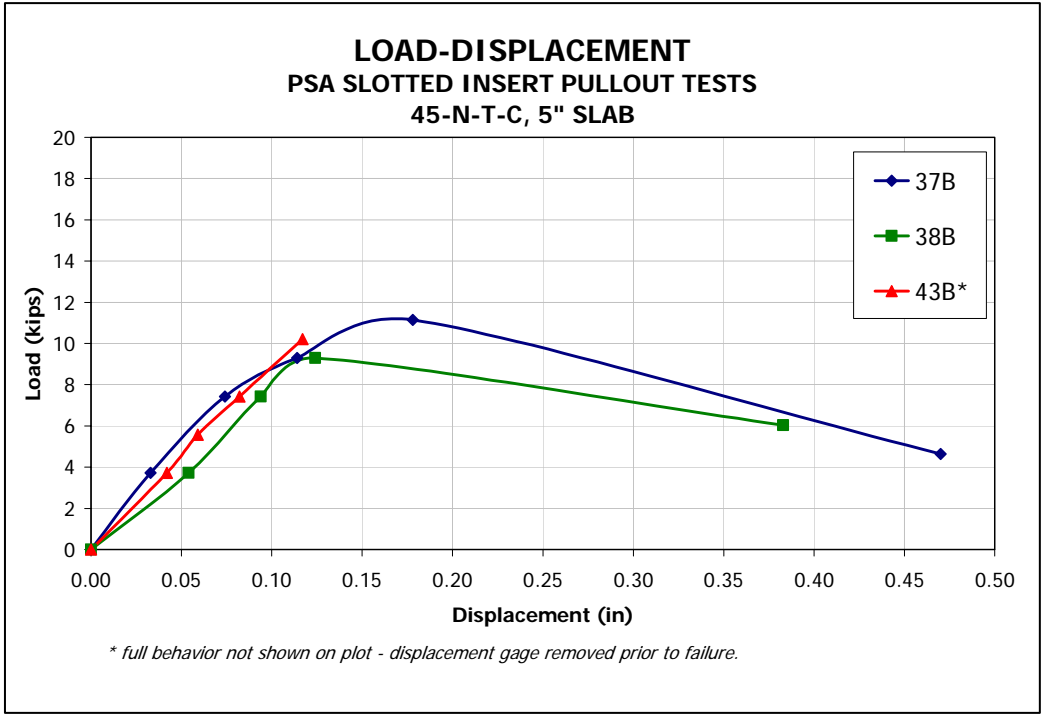

Figure 15: Load-displacement of tests 37B, 38B and 43B.

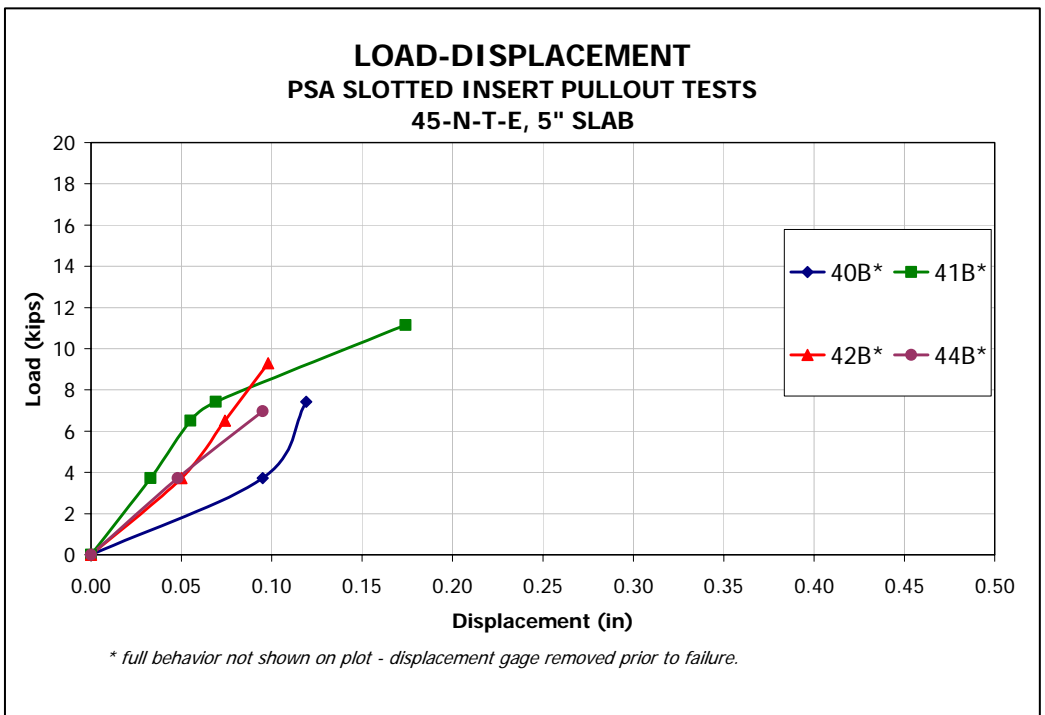

Figure 16: Load-displacement of tests 40B – 42B and 44B.

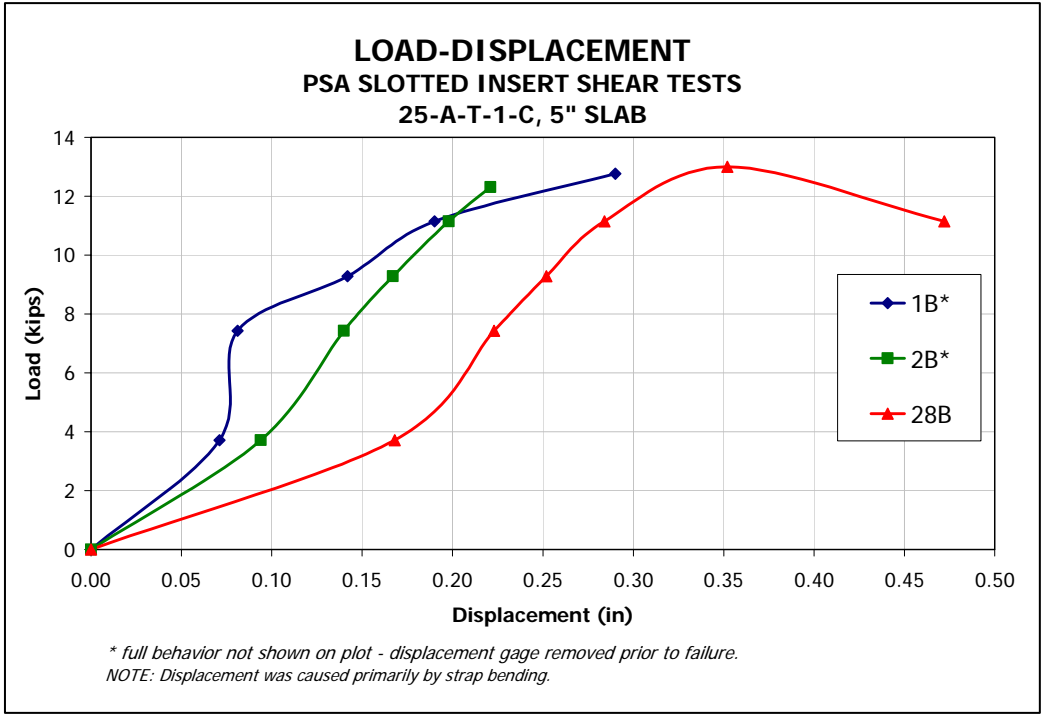

Figure 17: Load-displacement of tests 1B, 2B and 28B.

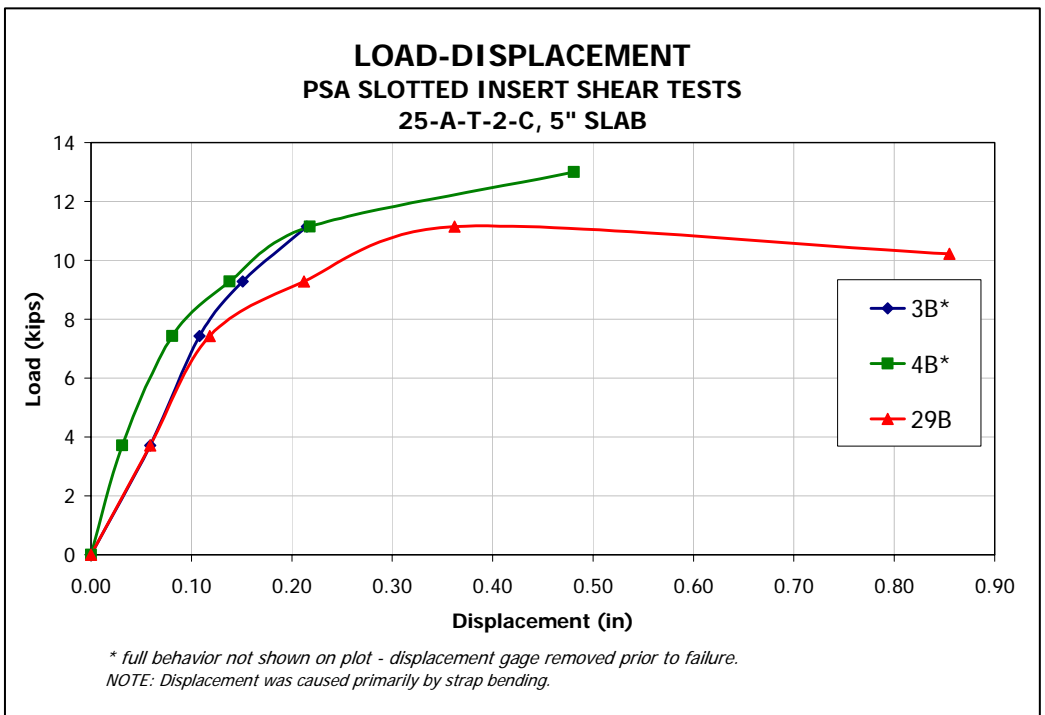

Figure 18: Load-displacement of tests 3B, 4B and 29B.

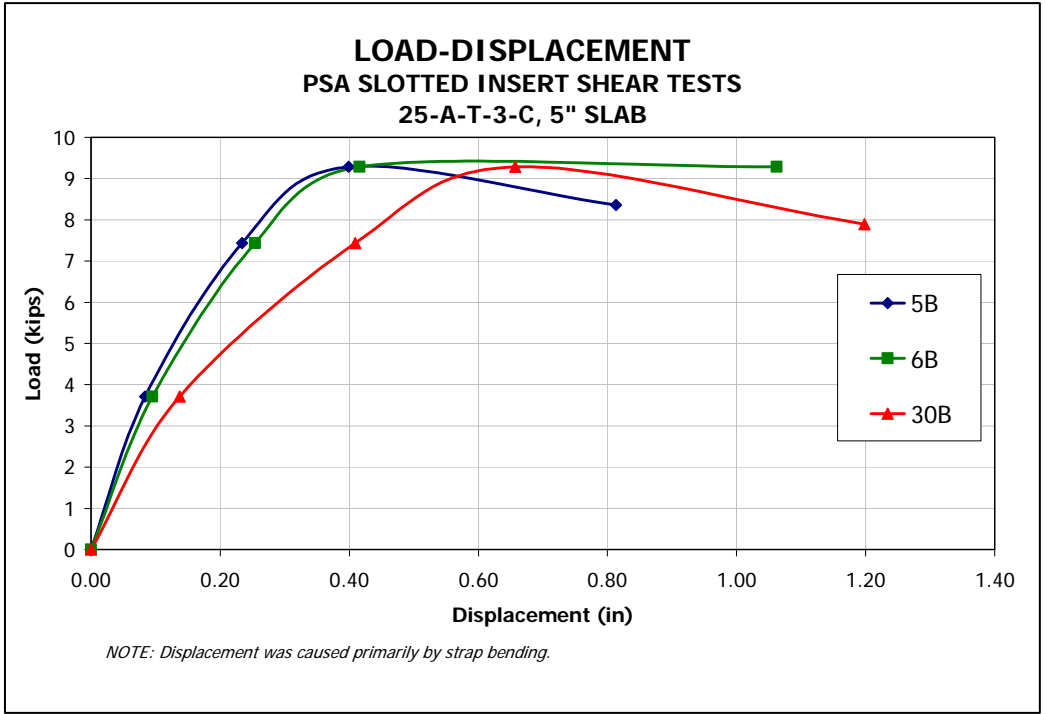

Figure 19: Load-displacement of tests 5B, 6B and 30B.

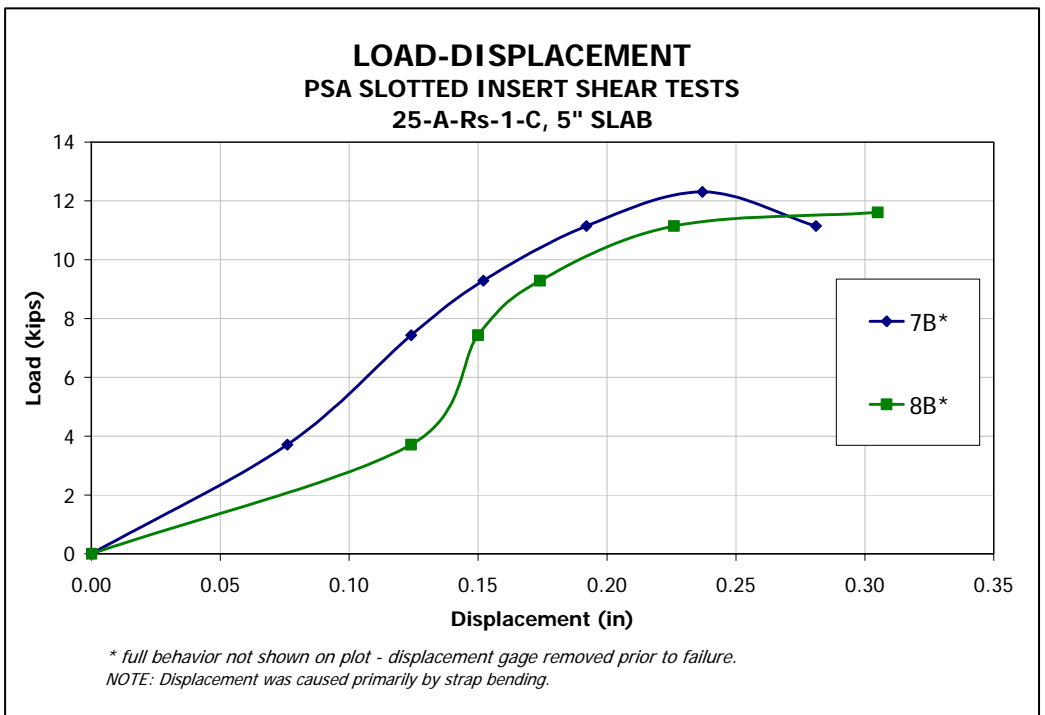

Figure 20 Load-displacement of tests 7B and 8B.

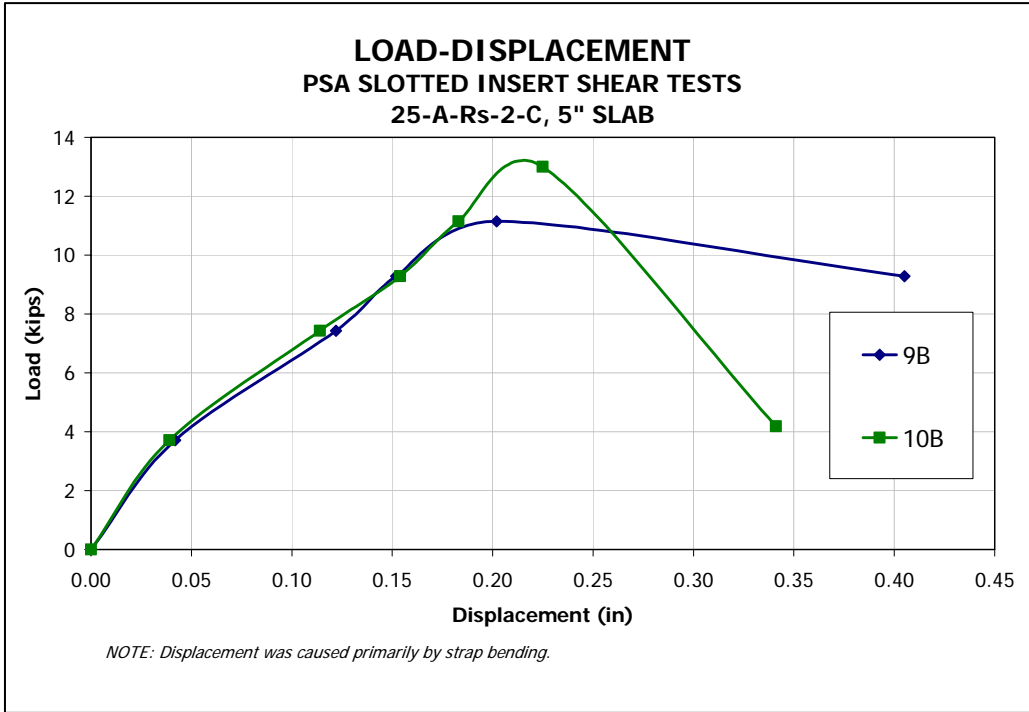

Figure 21: Load-displacement of tests 9B and 10B.

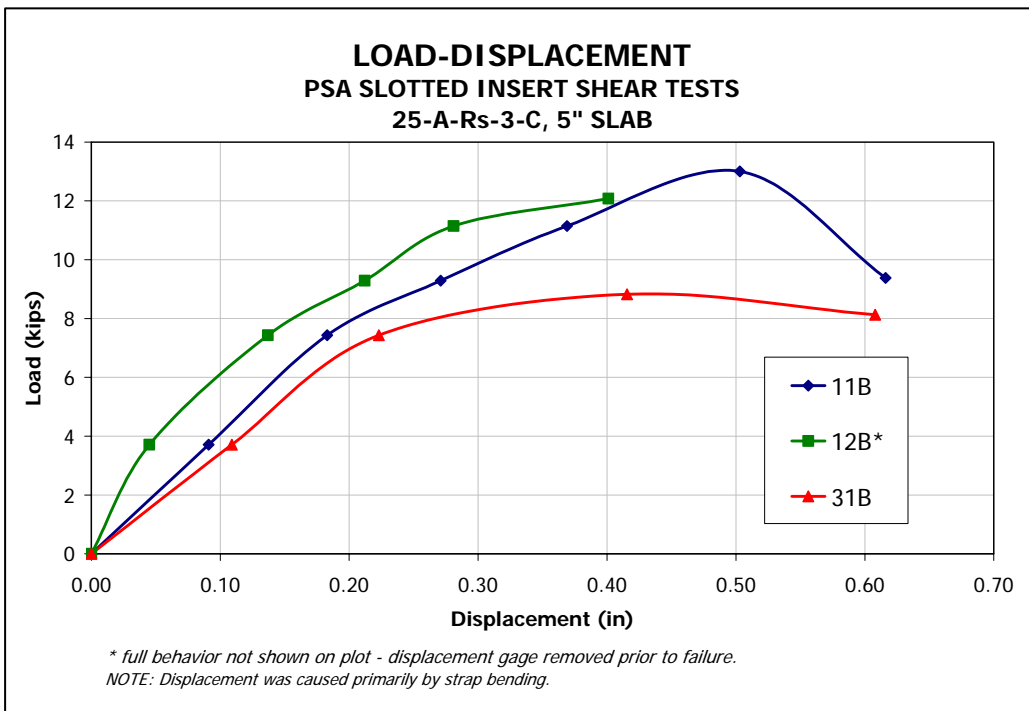

Figure 22: Load-displacement of tests 11B, 12B and 31B.

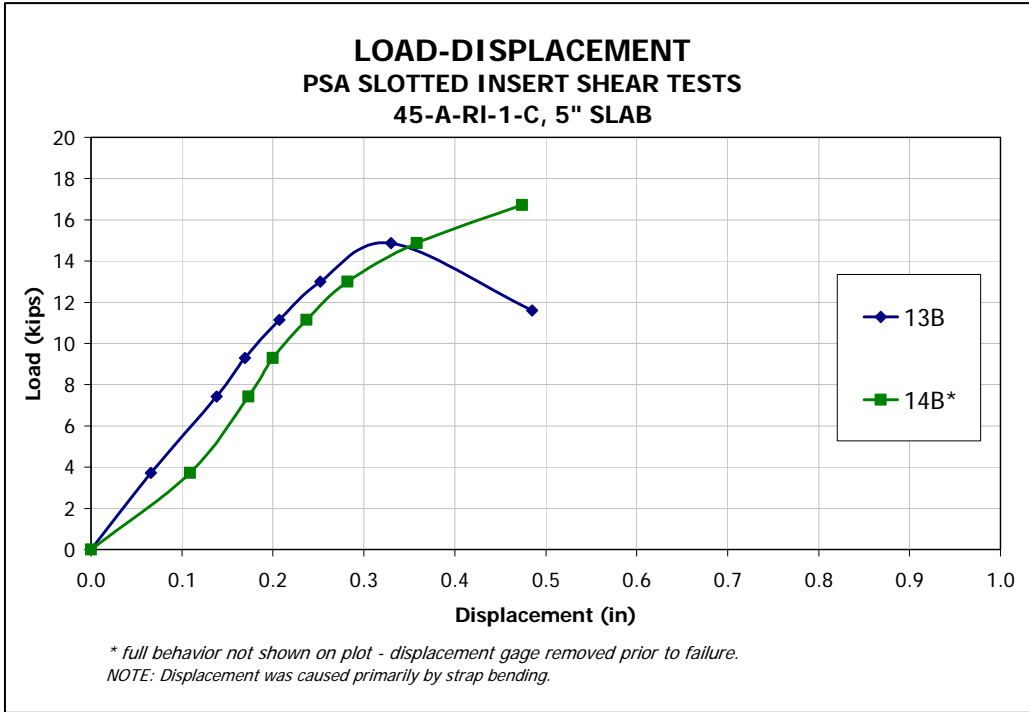

Figure 23: Load-displacement of tests 13B and 14B.

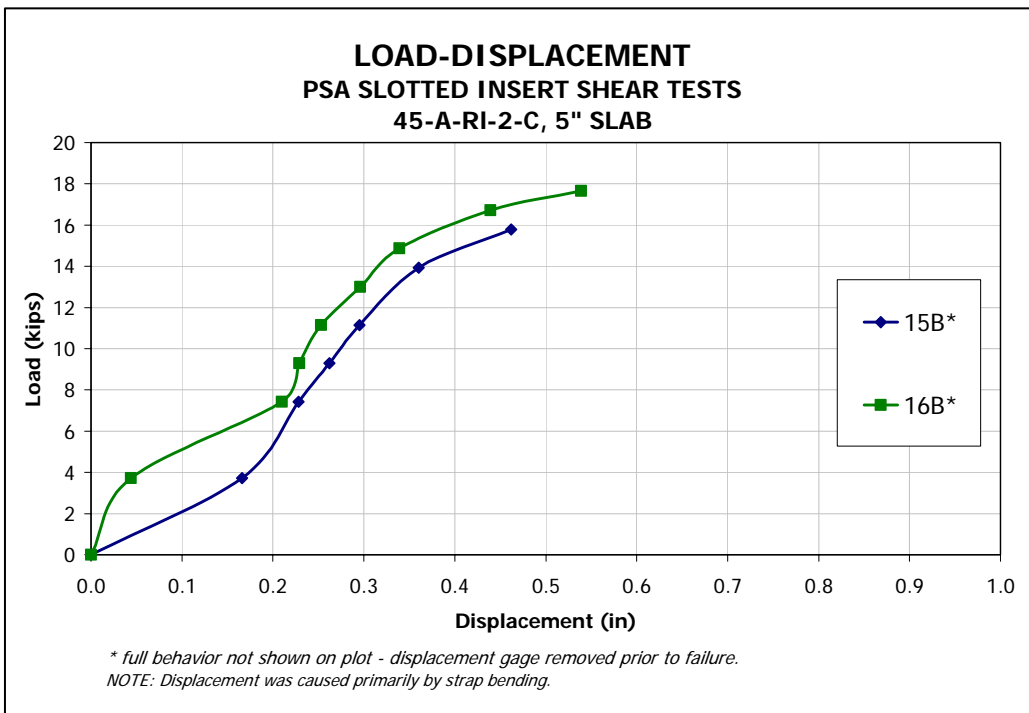

Figure 24: Load-displacement of tests 15B and 16B.

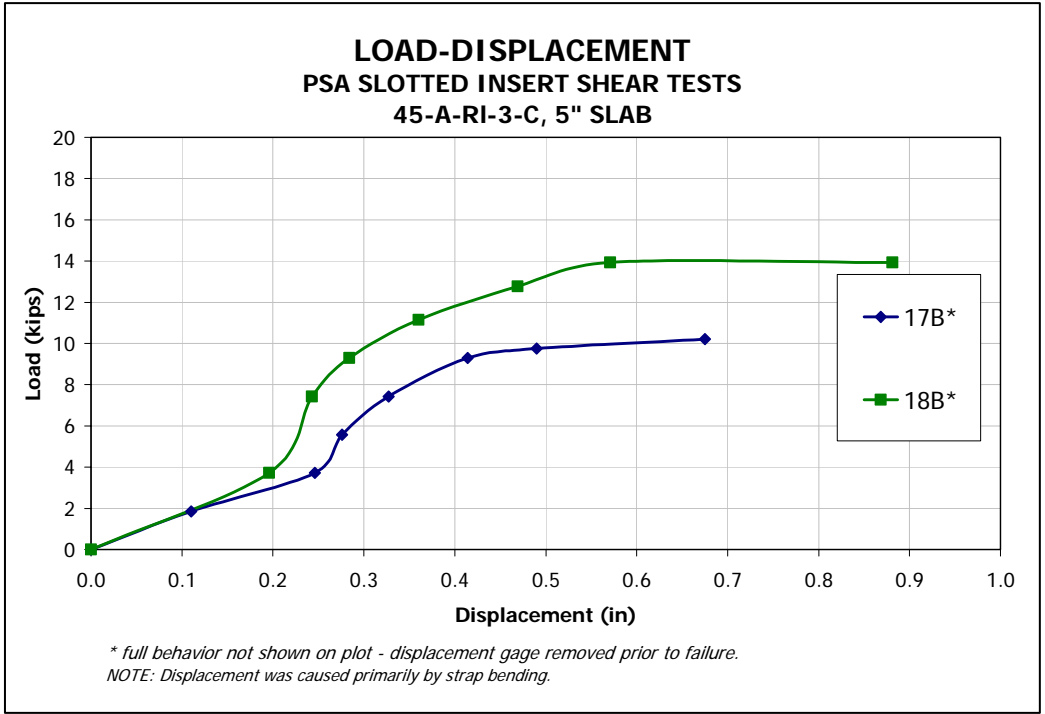

Figure 25: Load-displacement of tests 17B and 18B.

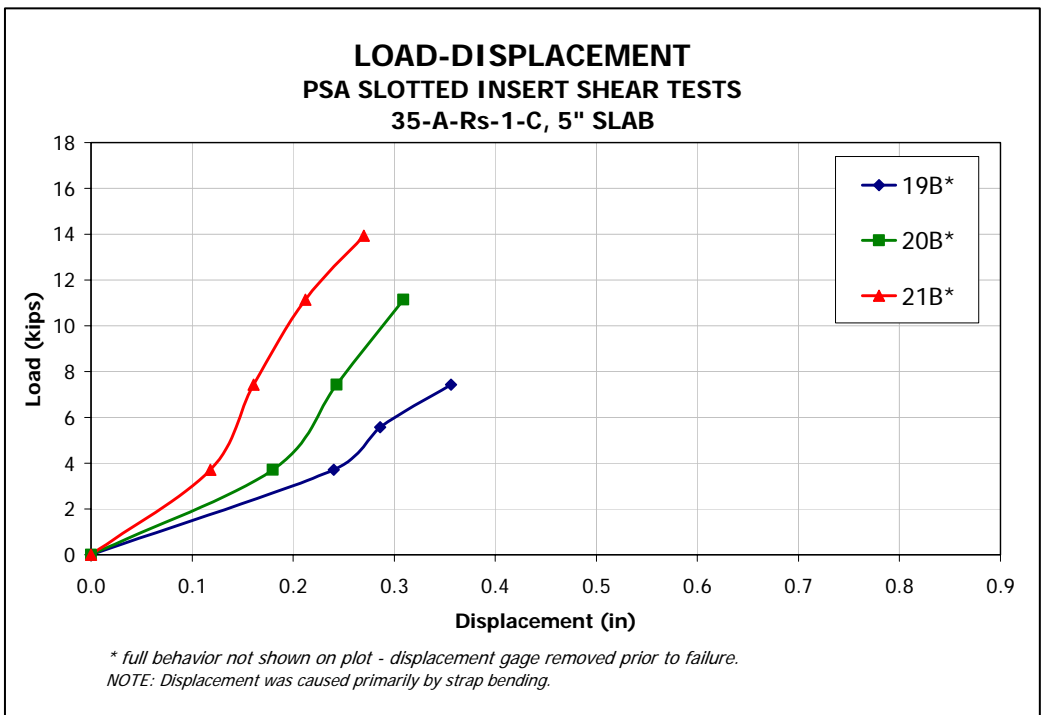

Figure 26: Load-displacement of test 19B – 21B.

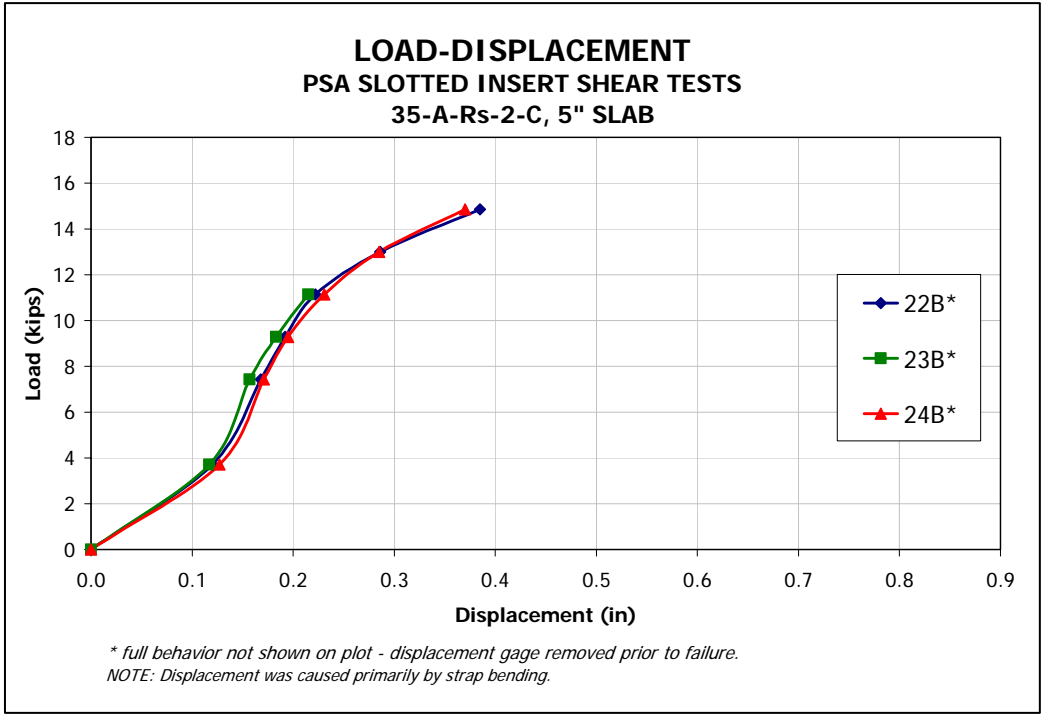

Figure 27: Load-displacement of tests 22B – 24B.

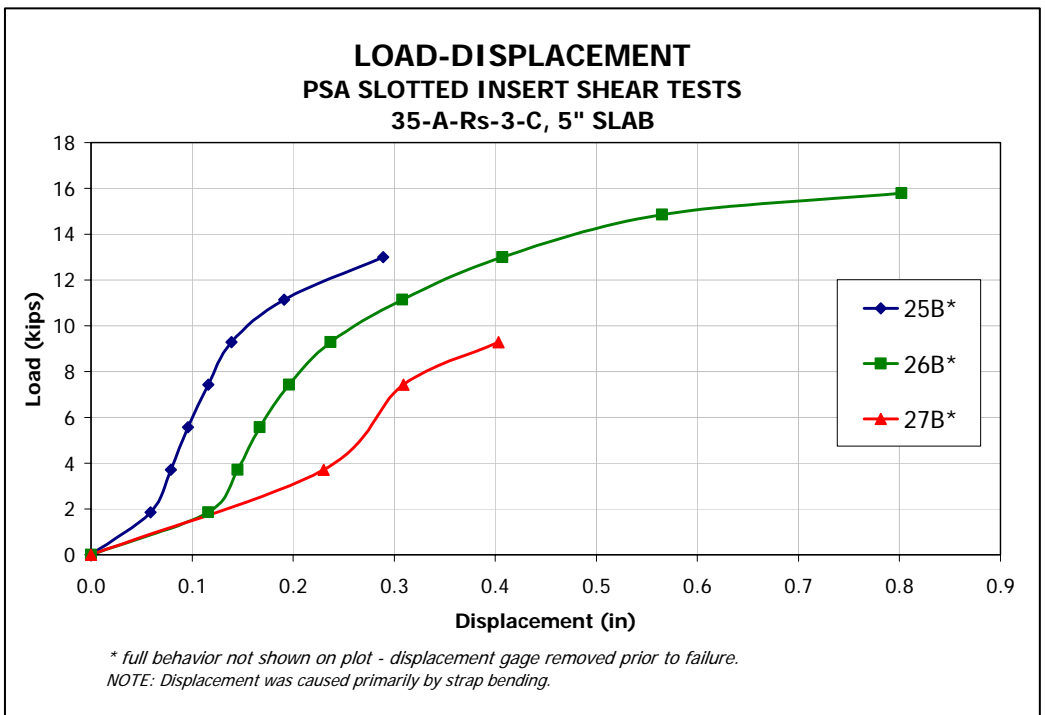

Figure 28: Load-displacement of tests 25B – 27B.

V. APPENDIX

Table A-1: Concrete strength test results¹.

Test Panel(s)	Production Date ²	Cylinder	Cylinder Break Date	Age (days)	Load (lb)	Ram Area (in ²)	Concrete Strength (psi)
A,B,C,D	7/6/2006	# 1	7/7/2006	1	45,500	12.5602	3,623
		# 2	7/7/2006	1	45,000	12.5602	3,583
		Average	7/7/2006	1			3,603
A,B,C,D	7/6/2006	# 3	7/17/2006	11	80,500	12.5602	6,409
		# 4	7/17/2006	11	78,100	12.5602	6,218
		Average	7/17/2006	11			6,314
A,B,C,D	7/6/2006	# 5	7/20/2006	14	88,500	12.5602	7,046
		# 6	7/20/2006	14	88,500	12.5602	7,046
		Average	7/20/2006	14			7,046

Table A-1a: Interpolated results for test dates.

Cylinder Break Date	Age (days)	Concrete Strength (psi)
7/17/2006	11	6,314
7/18/2006	12	6,558
7/19/2006	13	6,802
7/20/2006	14	7,046

NOTES: 1/ Tests performed by Metromont quality control personel.

2/ Metromont mix design #703250, design $f_c = 6,000$ psi @ 28 days

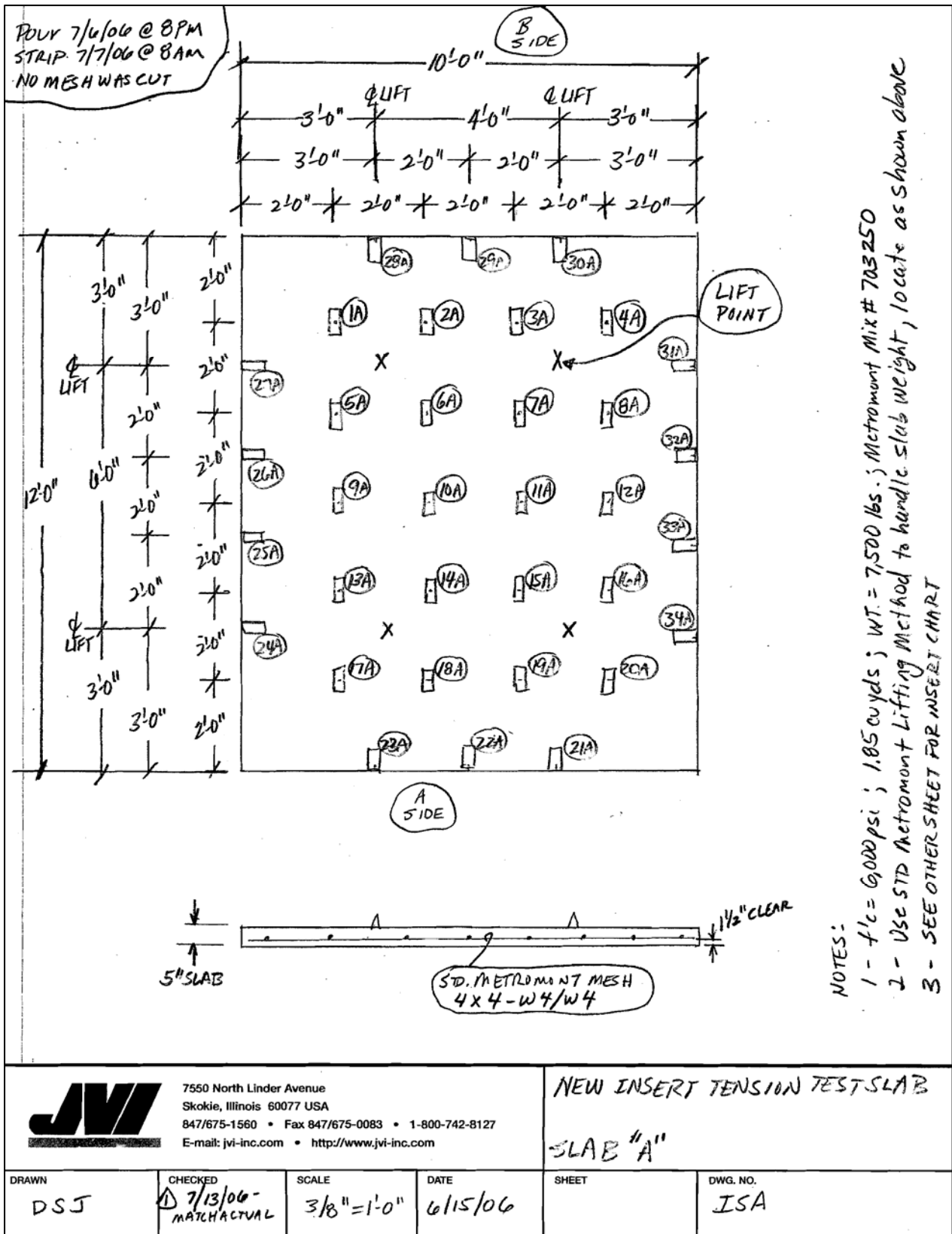

Figure A-1: Production drawing for slab A.

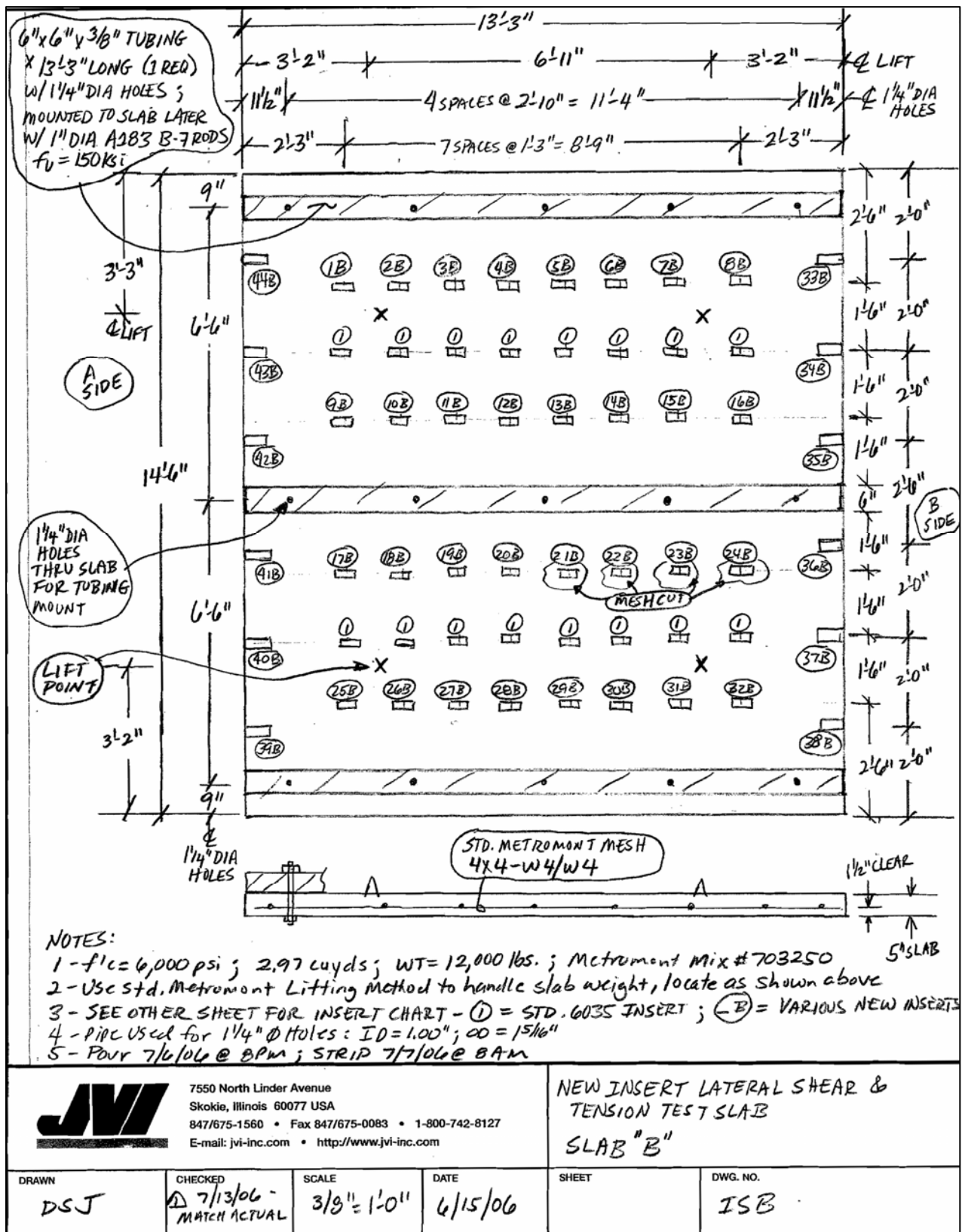

Figure A-2: Production drawing for slab B.

Table A-2: Partial insert schedule for slab A.

Test #	Load Applied	Specimen Designation	Insert	Location in Slab	Slab	Insert Nut	Strap	Strap Location In Slot	Setting Method	Test Date	Concrete Strength
1A	Pullout	25-A-Rs-C	N6025	Away from Edge	5"	small	3/4" rod	Centered	Wood Jig	7/20/2006	7046
2A	Pullout	25-A-Rs-C	N6025	Away from Edge	5"	small	3/4" rod	Centered	Wood Jig	7/20/2006	7046
3A	Pullout	25-A-Rs-E	N6025	Away from Edge	5"	small	3/4" rod	End	Wood Jig	7/20/2006	7046
4A	Pullout	25-A-Rs-E	N6025	Away from Edge	5"	small	3/4" rod	End	Wood Jig	7/20/2006	7046
5A	Pullout	35-A-Rs-C	N6035	Away from Edge	5"	small	3/4" rod	Centered	Wood Jig	7/20/2006	7046
6A	Pullout	35-A-Rs-C	N6035	Away from Edge	5"	small	3/4" rod	Centered	Wood Jig	7/20/2006	7046
7A	Pullout	35-A-Rs-C	N6035	Away from Edge	5"	small	3/4" rod	Centered	Wood Jig	7/20/2006	7046
8A	Pullout	35-A-Rs-E	N6035	Away from Edge	5"	small	3/4" rod	End	Wood Jig	7/20/2006	7046
9A	Pullout	35-A-Rs-E	N6035	Away from Edge	5"	small	3/4" rod	End	Wood Jig	7/20/2006	7046
10A	Pullout	35-A-Rs-E	N6035	Away from Edge	5"	small	3/4" rod	End	Wood Jig	7/20/2006	7046
11A	Pullout	45-A-RI-C	N6045	Away from Edge	5"	large	3/4" rod	Centered	Wood Jig	7/20/2006	7046
12A	Pullout	45-A-RI-C	N6045	Away from Edge	5"	large	3/4" rod	Centered	Wood Jig	7/20/2006	7046
13A	Pullout	45-A-RI-E	N6045	Away from Edge	5"	large	3/4" rod	End	Wood Jig	7/20/2006	7046
14A	Pullout	45-A-RI-E	N6045	Away from Edge	5"	large	3/4" rod	End	Wood Jig	7/20/2006	7046
15A	Pullout	45-A-T-C	N6045	Away from Edge	5"	NA	3/8" T-Notch	Centered	Wood Jig	7/20/2006	7046
16A	Pullout	45-A-T-C	N6045	Away from Edge	5"	NA	3/8" T-Notch	Centered	Wood Jig	7/20/2006	7046
17A	Pullout	45-A-T-E	N6045	Away from Edge	5"	NA	3/8" T-Notch	End	Wood Jig	7/20/2006	7046
18A	Pullout	45-A-T-E	N6045	Away from Edge	5"	NA	3/8" T-Notch	End	Wood Jig	7/20/2006	7046
19A	Pullout	45-A-T-C	N6045	Away from Edge	5"	NA	3/8" T-Notch	Centered	Wood Jig	7/20/2006	7046
20A	Pullout	45-A-T-E	N6045	Away from Edge	5"	NA	3/8" T-Notch	End	Wood Jig	7/20/2006	7046

Table A-3: Partial insert schedule for slab A.

Test #	Load Applied	Specimen Designation	Insert	Location in Slab	Slab	Insert Nut	Strap	Strap Location In Slot	Setting Method	Test Date	Concrete Strength
23A	Pullout	25-N-Rs-C	N6025	Near Edge	5"	small	3/4" rod	Centered	Hand Set Wet	7/20/2006	7046
24A	Pullout	25-N-Rs-E	N6025	Near Edge	5"	small	3/4" rod	End	Hand Set Wet	7/20/2006	7046
25A	Pullout	25-N-Rs-E	N6025	Near Edge	5"	small	3/4" rod	End	Hand Set Wet	7/20/2006	7046
26A	Pullout	25-N-Rs-E	N6025	Near Edge	5"	small	3/4" rod	End (@ panel edge)	Hand Set Wet	7/20/2006	7046
27A	Pullout	35-N-Rs-C	N6035	Near Edge	5"	small	3/4" rod	Centered	Hand Set Wet	7/20/2006	7046
28A	Pullout	35-N-Rs-C	N6035	Near Edge	5"	small	3/4" rod	Centered	Hand Set Wet	7/20/2006	7046
29A	Pullout	35-N-Rs-C	N6035	Near Edge	5"	small	3/4" rod	Centered	Hand Set Wet	7/20/2006	7046
30A	Pullout	35-N-Rs-E	N6035	Near Edge	5"	small	3/4" rod	End	Hand Set Wet	7/20/2006	7046
31A	Pullout	35-N-Rs-E	N6035	Near Edge	5"	small	3/4" rod	End	Hand Set Wet	7/20/2006	7046
32A	Pullout	35-N-Rs-E	N6035	Near Edge	5"	small	3/4" rod	End (@ panel edge)	Hand Set Wet	7/20/2006	7046
33A	Pullout	45-N-RI-C	N6045	Near Edge	5"	large	3/4" rod	Centered	Hand Set Wet	7/20/2006	7046
34A	Pullout	45-N-RI-C	N6045	Near Edge	5"	large	3/4" rod	Centered	Hand Set Wet	7/20/2006	7046

Table A-4: Partial insert schedule for slab B.

Test #	Load Applied	Specimen Designation	Insert	Location in Slab	Slab	Insert Nut	Strap	Eccentricity	Strap Location In Slot	Setting Method	Test Date	Concrete Strength
1B	Shear	25-A-T-1-C	N6025	Away from Edge	5"	NA	3/8" T-Notch	1"	Centered	Wood Jig	7/18/2006	6558
2B	Shear	25-A-T-1-C	N6025	Away from Edge	5"	NA	3/8" T-Notch	1"	Centered	Wood Jig	7/18/2006	6558
3B	Shear	25-A-T-2-C	N6025	Away from Edge	5"	NA	3/8" T-Notch	2"	Centered	Wood Jig	7/18/2006	6558
4B	Shear	25-A-T-2-C	N6025	Away from Edge	5"	NA	3/8" T-Notch	2"	Centered	Wood Jig	7/18/2006	6558
5B	Shear	25-A-T-3-C	N6025	Away from Edge	5"	NA	3/8" T-Notch	3"	Centered	Wood Jig	7/18/2006	6558
6B	Shear	25-A-T-3-C	N6025	Away from Edge	5"	NA	3/8" T-Notch	3"	Centered	Wood Jig	7/18/2006	6558
7B	Shear	25-A-Rs-1-C	N6025	Away from Edge	5"	small	3/4" Threaded	1"	Centered	Wood Jig	7/18/2006	6558
8B	Shear	25-A-Rs-1-C	N6025	Away from Edge	5"	small	3/4" Threaded	1"	Centered	Wood Jig	7/18/2006	6558
9B	Shear	25-A-Rs-2-C	N6025	Away from Edge	5"	small	3/4" Threaded	2"	Centered	Wood Jig	7/18/2006	6558
10B	Shear	25-A-Rs-2-C	N6025	Away from Edge	5"	small	3/4" Threaded	2"	Centered	Wood Jig	7/18/2006	6558
11B	Shear	25-A-Rs-3-C	N6025	Away from Edge	5"	small	3/4" Threaded	3"	Centered	Wood Jig	7/18/2006	6558
12B	Shear	25-A-Rs-3-C	N6025	Away from Edge	5"	small	3/4" Threaded	3"	Centered	Wood Jig	7/18/2006	6558
13B	Shear	45-A-RI-1-C	N6045	Away from Edge	5"	large	3/4" Threaded	1"	Centered	Wood Jig	7/18/2006	6558
14B	Shear	45-A-RI-1-C	N6045	Away from Edge	5"	large	3/4" Threaded	1"	Centered	Wood Jig	7/18/2006	6558
15B	Shear	45-A-RI-2-C	N6045	Away from Edge	5"	large	3/4" Threaded	2"	Centered	Wood Jig	7/18/2006	6558
16B	Shear	45-A-RI-2-C	N6045	Away from Edge	5"	large	3/4" Threaded	2"	Centered	Wood Jig	7/18/2006	6558
17B	Shear	45-A-RI-3-C	N6045	Away from Edge	5"	large	3/4" Threaded	3"	Centered	Wood Jig	7/17/2006	6314
18B	Shear	45-A-RI-3-C	N6045	Away from Edge	5"	large	3/4" Threaded	3"	Centered	Wood Jig	7/18/2006	6558
19B	Shear	35-A-Rs-1-C	N6035	Away from Edge	5"	small	3/4" Threaded	1"	Centered	Wood Jig	7/18/2006	6558
20B	Shear	35-A-Rs-1-C	N6035	Away from Edge	5"	small	3/4" Threaded	1"	Centered	Wood Jig	7/18/2006	6558

Table A-5: Partial insert schedule for slab B.

Test #	Load Applied	Specimen Designation	Insert	Location in Slab	Slab	Insert Nut	Strap	Eccentricity	Strap Location In Slot	Setting Method	Test Date	Concrete Strength
23B	Shear	35-A-Rs-2-C	N6035	Away from Edge	5"	small	3/4" Threaded	2"	Centered	Wood Jig	7/18/2006	6558
24B	Shear	35-A-Rs-2-C	N6035	Away from Edge	5"	small	3/4" Threaded	2"	Centered	Wood Jig	7/18/2006	6558
25B	Shear	35-A-Rs-3-C	N6035	Away from Edge	5"	small	3/4" Threaded	3"	Centered	Wood Jig	7/17/2006	6314
26B	Shear	35-A-Rs-3-C	N6035	Away from Edge	5"	small	3/4" Threaded	3"	Centered	Wood Jig	7/17/2006	6314
27B	Shear	35-A-Rs-3-C	N6035	Away from Edge	5"	small	3/4" Threaded	3"	Centered	Wood Jig	7/18/2006	6558
28B	Shear	25-A-T-1-C	N6025	Away from Edge	5"	NA	3/8" T-Notch	1"	Centered	Wood Jig	7/18/2006	6558
29B	Shear	25-A-T-2-C	N6025	Away from Edge	5"	NA	3/8" T-Notch	2"	Centered	Wood Jig	7/19/2006	6802
30B	Shear	25-A-T-3-C	N6025	Away from Edge	5"	NA	3/8" T-Notch	3"	Centered	Wood Jig	7/18/2006	6558
31B	Shear	25-A-Rs-3-C	N6025	Away from Edge	5"	small	3/4" Threaded	3"	Centered	Wood Jig	7/18/2006	6558
32B	Pullout	45-A-T-C	N6045	Away from Edge	5"	large	3/8" T-Notch	--	Centered	Wood Jig	7/18/2006	6558
33B	Pullout	45-N-RI-C	N6045	Near Edge	5"	large	3/4" rod	--	Centered	Hand Set Wet	7/18/2006	6558
34B	Pullout	45-N-RI-E	N6045	Near Edge	5"	large	3/4" rod	--	End	Wood Jig	7/18/2006	6558
35B	Pullout	45-N-RI-E	N6045	Near Edge	5"	large	3/4" rod	--	End	Hand Set Wet	7/18/2006	6558
36B	Pullout	45-N-RI-E	N6045	Near Edge	5"	large	3/4" rod	--	End	Hand Set Wet	7/18/2006	6558
37B	Pullout	45-N-T-C	N6045	Near Edge	5"	NA	3/8" T-Notch	--	Centered	Wood Jig	7/18/2006	6558
38B	Pullout	45-N-T-C	N6045	Near Edge	5"	NA	3/8" T-Notch	--	Centered	Hand Set Wet	7/18/2006	6558
39B	Pullout	45-N-T-C	N6045	Near Edge	5"	NA	3/8" T-Notch	--	Centered	Hand Set Wet	7/17/2006	6314
40B	Pullout	45-N-T-E	N6045	Near Edge	5"	NA	3/8" T-Notch	--	End	Wood Jig	7/19/2006	6802
41B	Pullout	45-N-T-E	N6045	Near Edge	5"	NA	3/8" T-Notch	--	End	Hand Set Wet	7/19/2006	6802
42B	Pullout	45-N-T-E	N6045	Near Edge	5"	NA	3/8" T-Notch	--	End	Hand Set Wet	7/19/2006	6802
43B	Pullout	45-N-T-C	N6045	Near Edge	5"	NA	3/8" T-Notch	--	Centered	Wood Jig	7/19/2006	6802
44B	Pullout	45-N-T-E	N6045	Near Edge	5"	NA	3/8" T-Notch	--	End	Hand Set Wet	7/19/2006	6802

INSTEEL WIRE PRODUCTS

DISCRETE JOB# 198309

Mount Airy, North Carolina

This is to certify that the manufacturing processes for the reinforcement material described below occurred in the United States of America and was made in accordance with and conforms to the following specifications:

ASTM-A 82 Tensile & Bend Tests
 ASTM-A 185 Weld Shear Test

Conf. Number: **219071**Lot Number: **20050910**

Sales Order Number: _____

Item **533-103250**
 Number: _____

Product **4X4-W4/W4-96" (2+2) X 11'10" (1+1)**
 Style: _____

W4/W4

TENSILE TESTS

WIRE SIZES		Test No.	Pounds/Foot "Deformed Wire Only"		WIRE DIA. (Inches)	Actual Area (Sq. In.)	Tensile Pounds/ Sq. In.	ROA %	Yield Strength P.S.I.
Longitudinal	Transverse		Actual	Nominal					
W4	XXXXXX	1			0.224	0.03941	104356	61%	
W4	XXXXXX	2			0.224	0.03941	103946	61%	
XXXXXX	W4	1			0.227	0.04047	103889	63%	
XXXXXX	W4	2			0.227	0.04047	104117	63%	

ALL WIRES LISTED ABOVE MEET A.S.T.M. A-82 OR A-496 BEND TEST REQUIREMENTS

WELD SHEAR TESTS

WIRE SIZES: W4 / W4

Test Number	1	2	3	4
Break Load (Lbs. Of Force)	3934	3781	3887	3775

MINIMUM BREAK LOAD REQUIRED 1400 LBS. OF FORCE

RAW MATERIALS – HEAT NUMBER INFORMATION

Longitudinal Wires	Heat No's:
Code: W23932	J5-4456

Transverse Wires	Heat No's:
Code: W23932	J5-4442

Date: 9/15/2005

Quality Assurance
 Insteel Wire Products

D. Baker
 D Baker

Figure A-3: Wire mesh certification for slabs A and B.

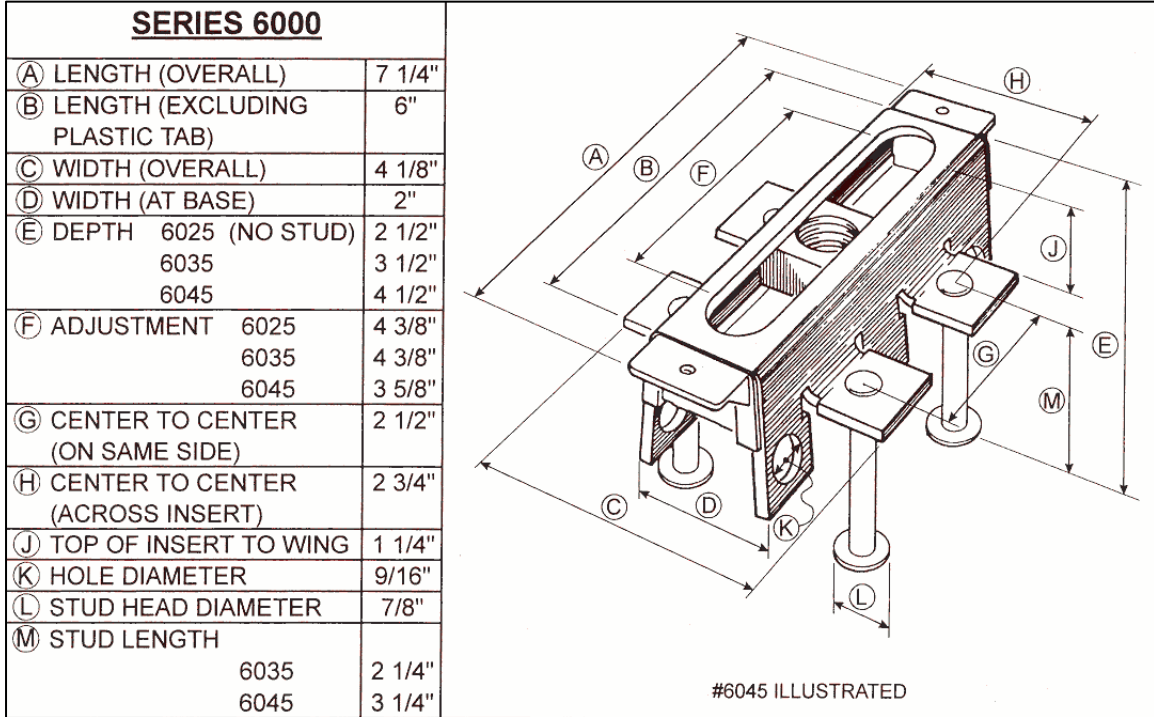

Figure A-4: Old PSA Slotted Insert detail shown for stud dimensions used in testing. See Figure A-5 for detail of New PSA Slotted Insert without studs.

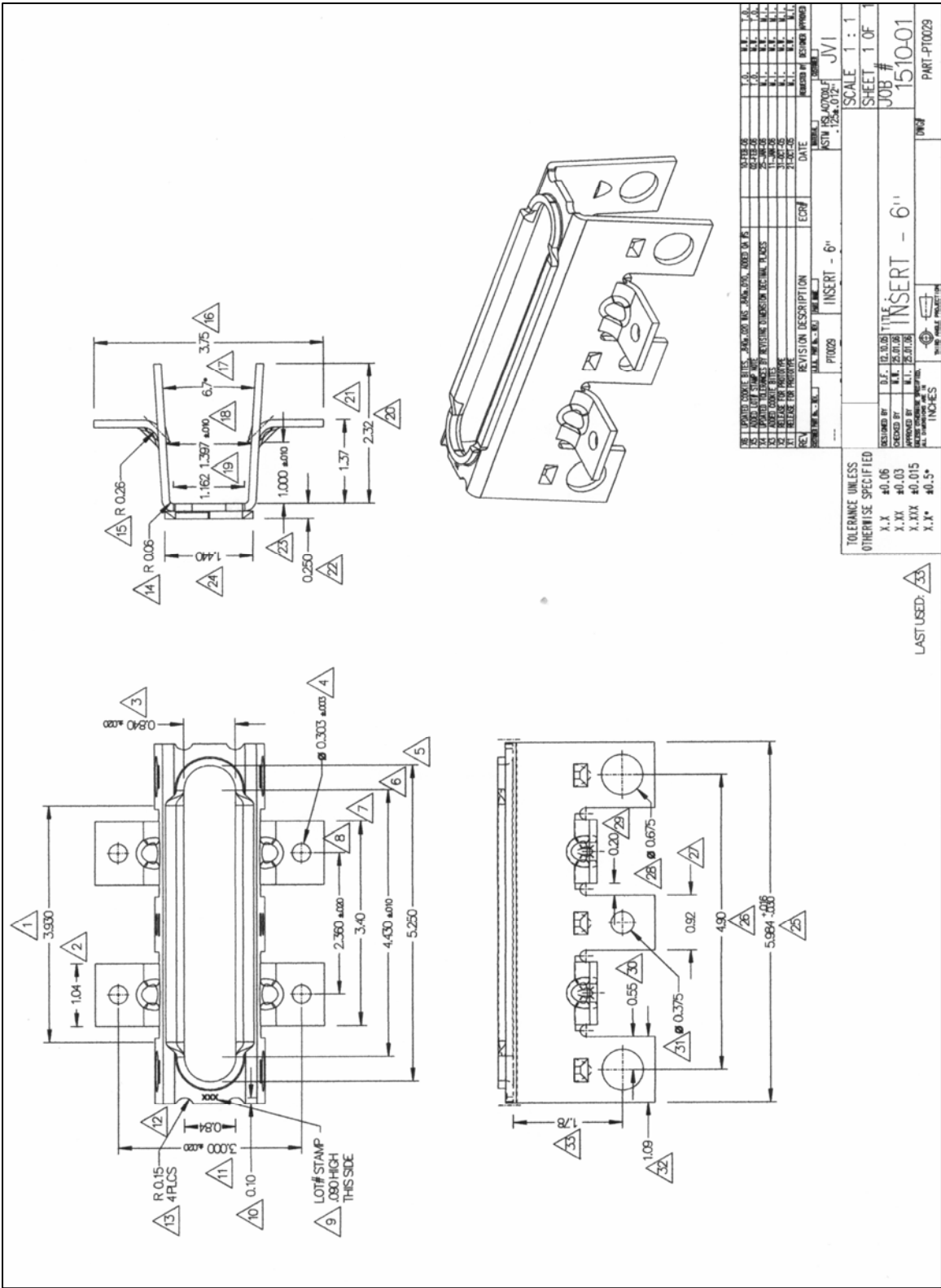

Figure A-4a: New PSA Slotted Insert detail.

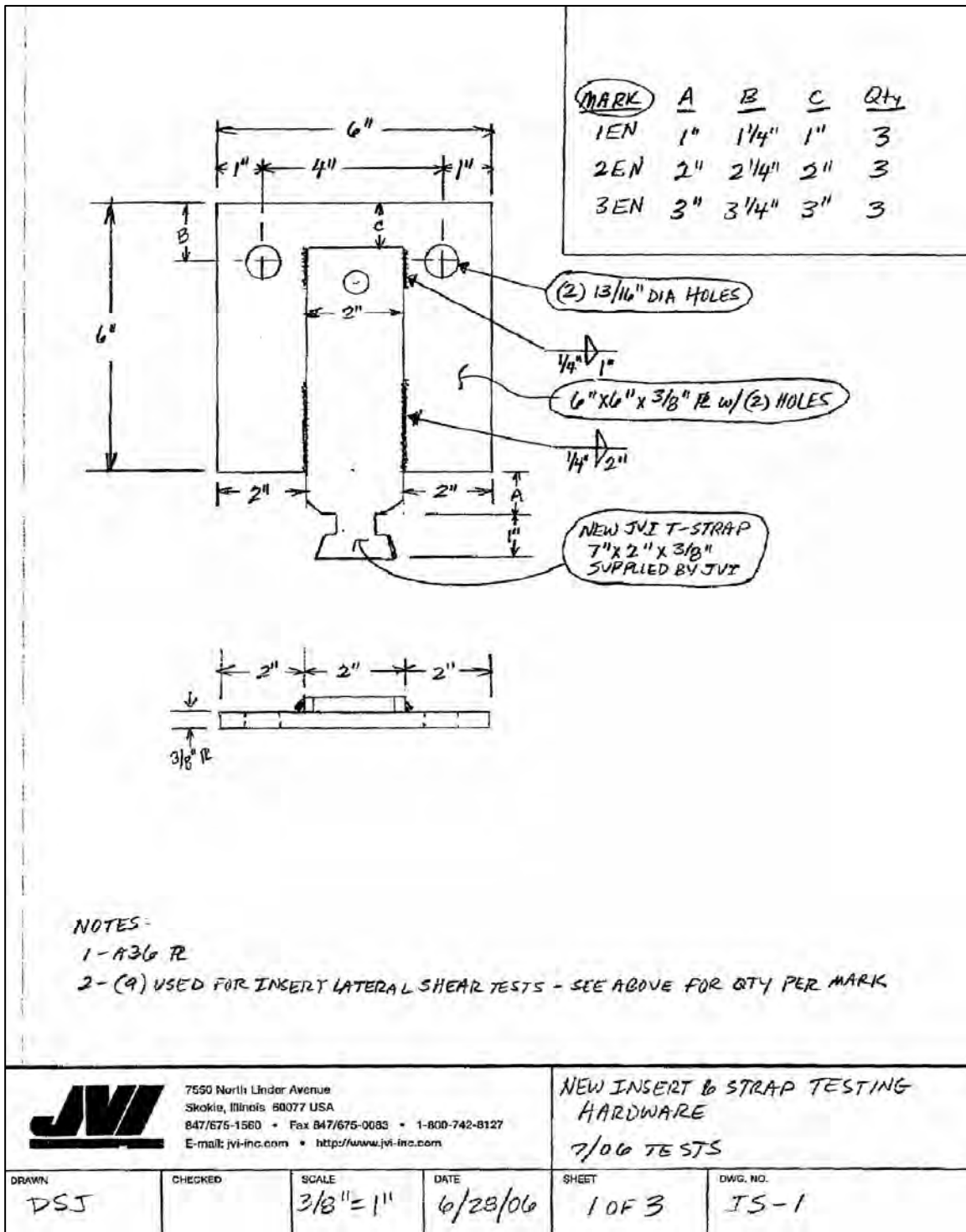

Figure A-5: Production detail for T-notch strap with load plate for shear test.

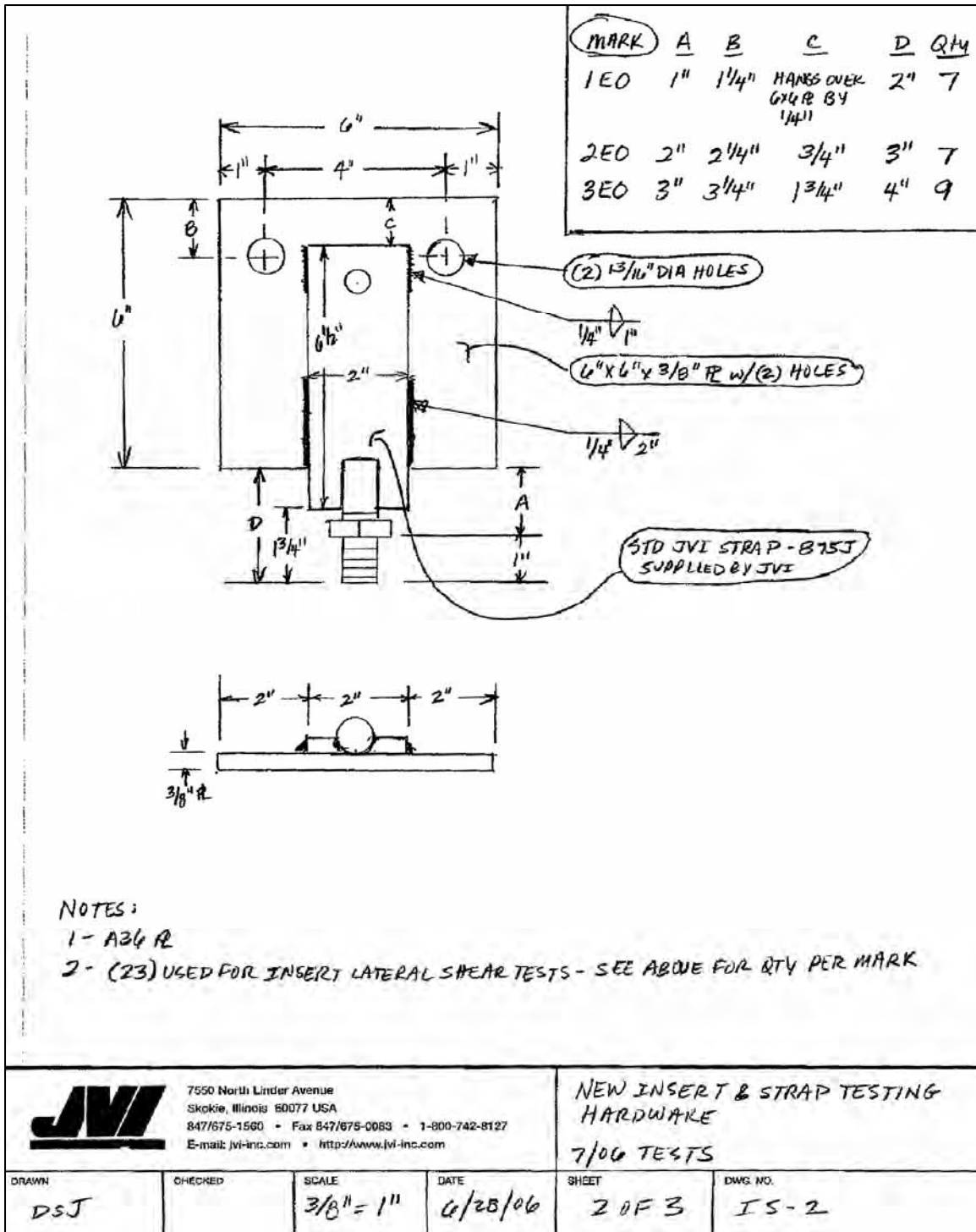

Figure A-6: Production detail for standard strap and rod assembly with load plate for shear tests.

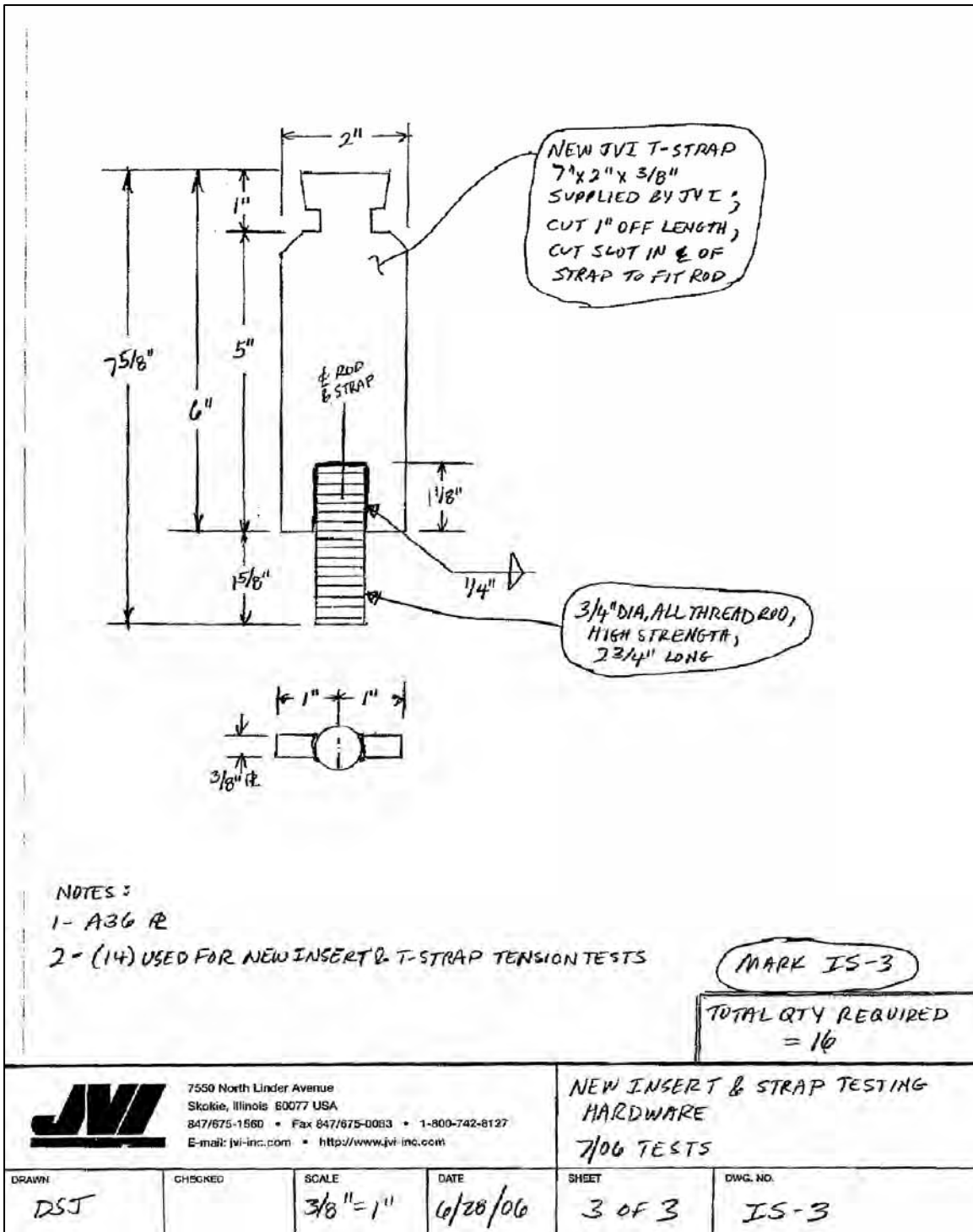

Figure A-7: T-notch strap with modification to accept tension rod for pullout tests.

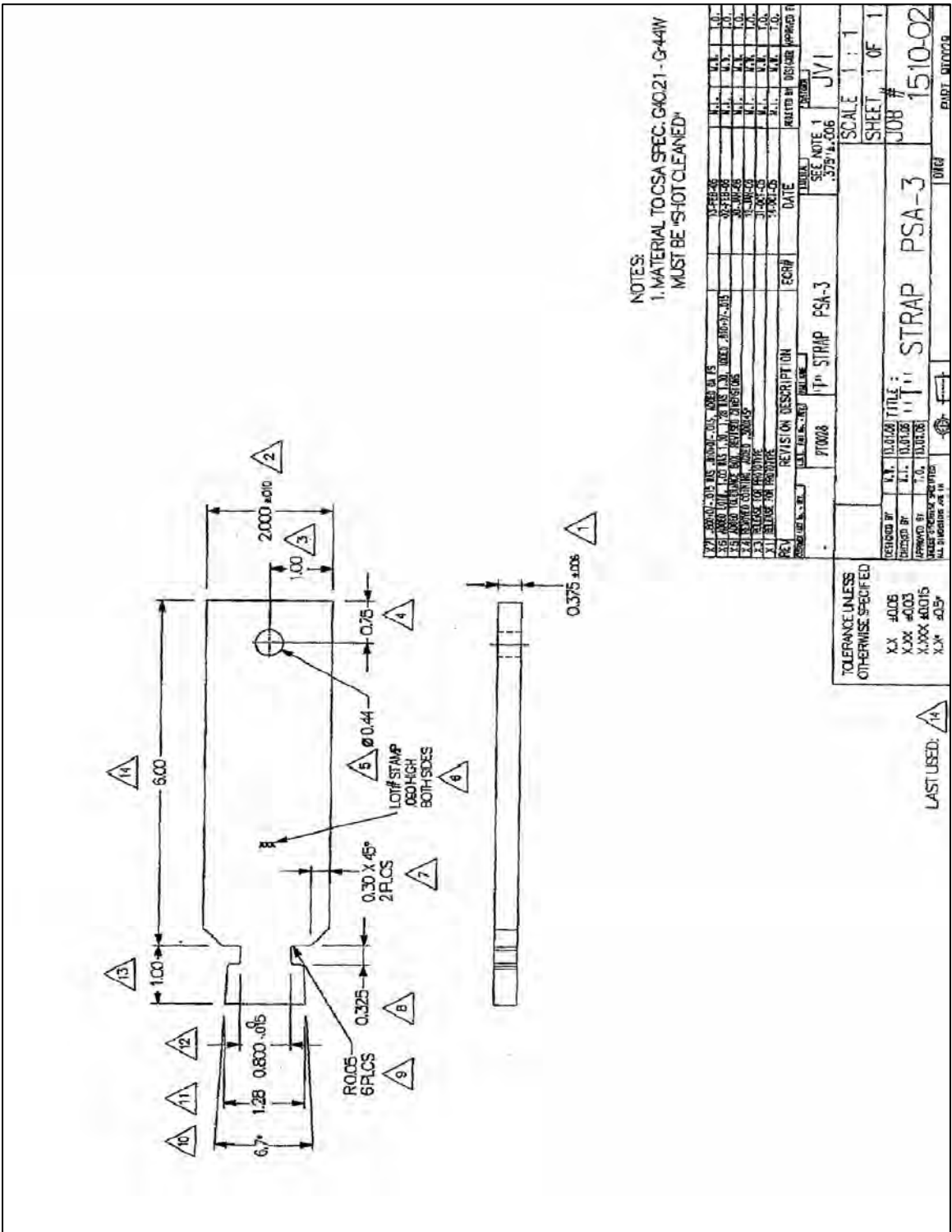

Figure A-8: T-notch strap detail.

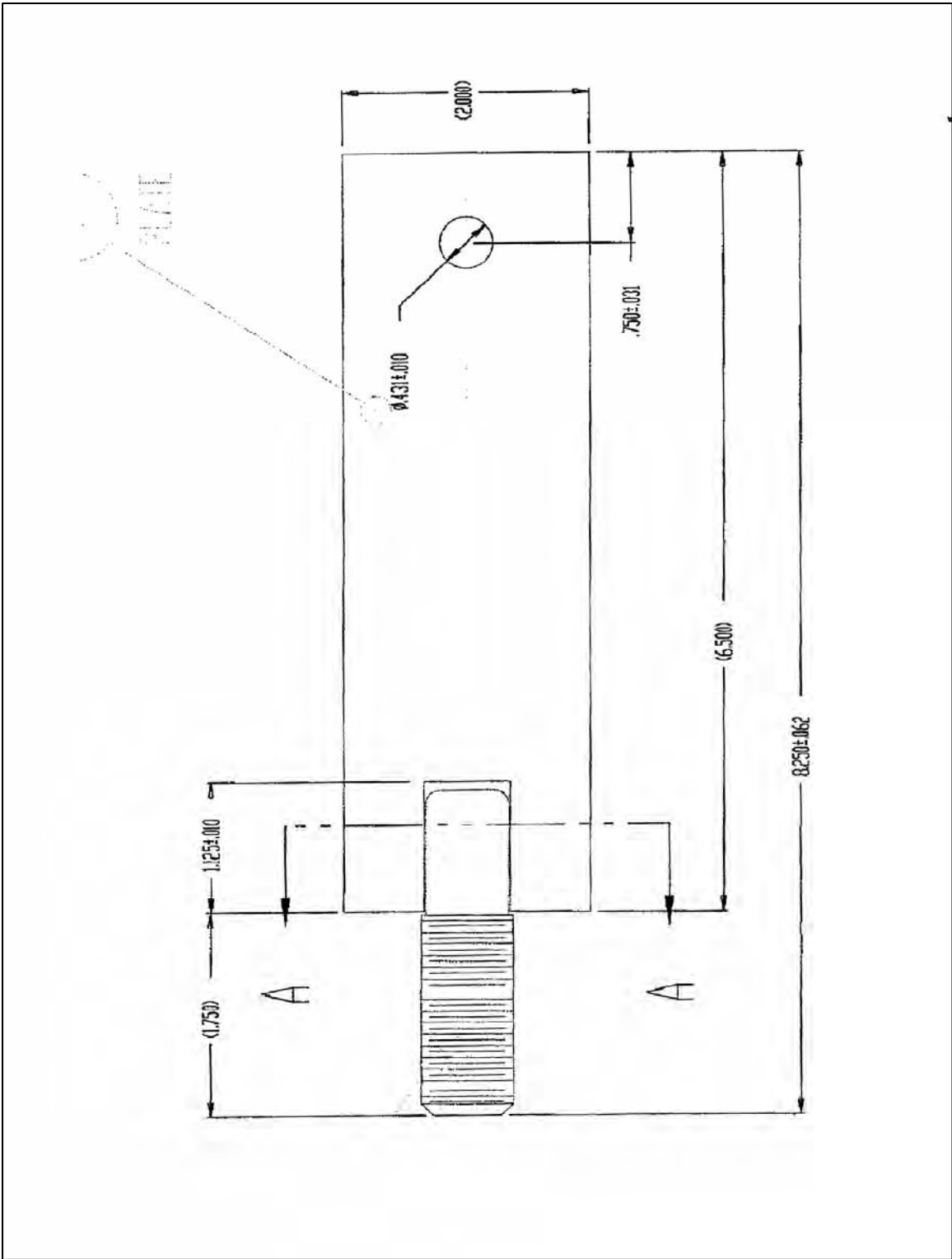

Figure A-9: Standard threaded strap detail.

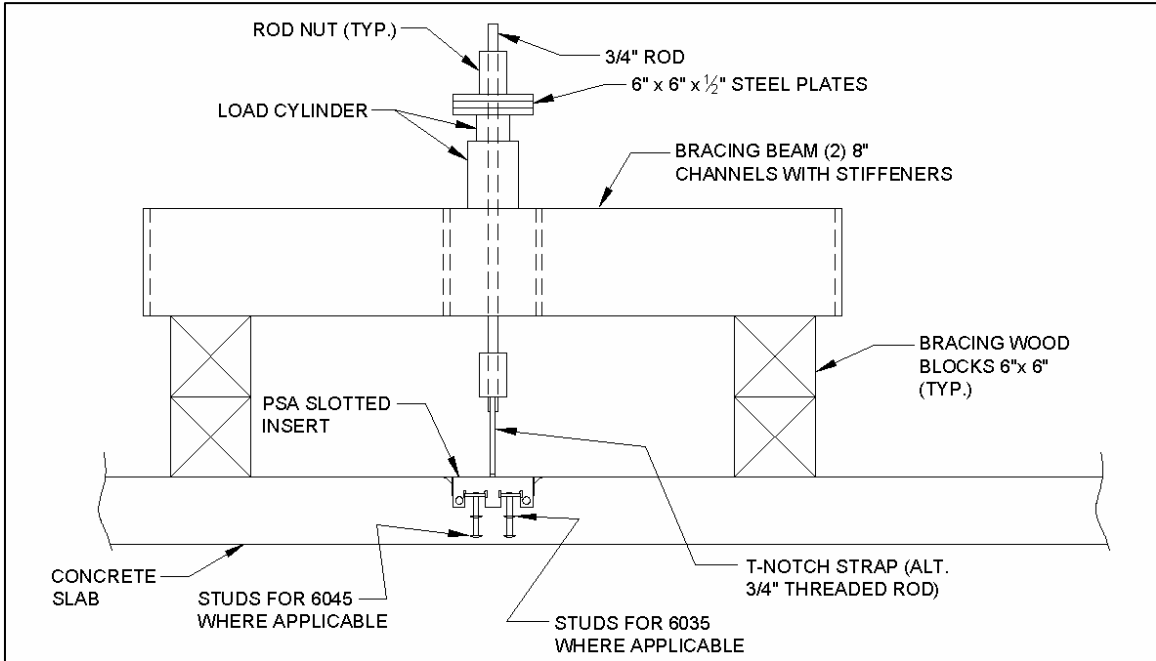

Figure A-10: Schematic (section profile) of pullout test setup.



Figure A-11: Photo (front profile) of pullout test setup.



Figure A-12: Photo (side profile) of pullout test setup.



Figure A-13: Close-up photo of dial gage setup for pullout test.

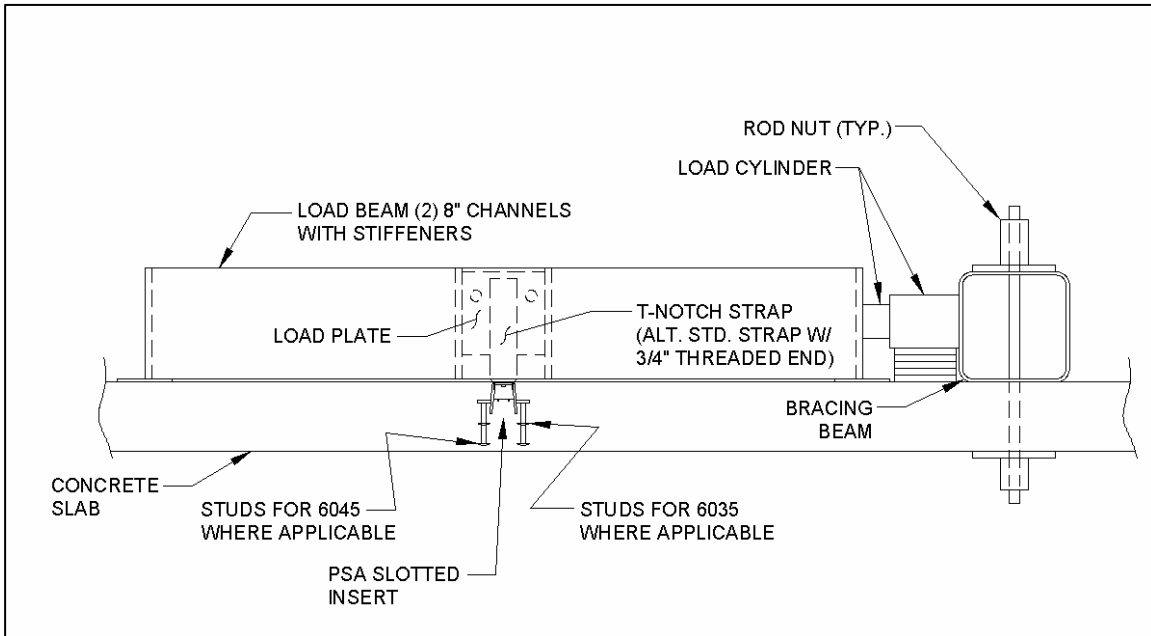

Figure A-14: Schematic (section profile) of lateral shear test setup.



Figure A-15: Photo of lateral shear test setup.



Figure A-16: Close-up photo of lateral shear test setup.

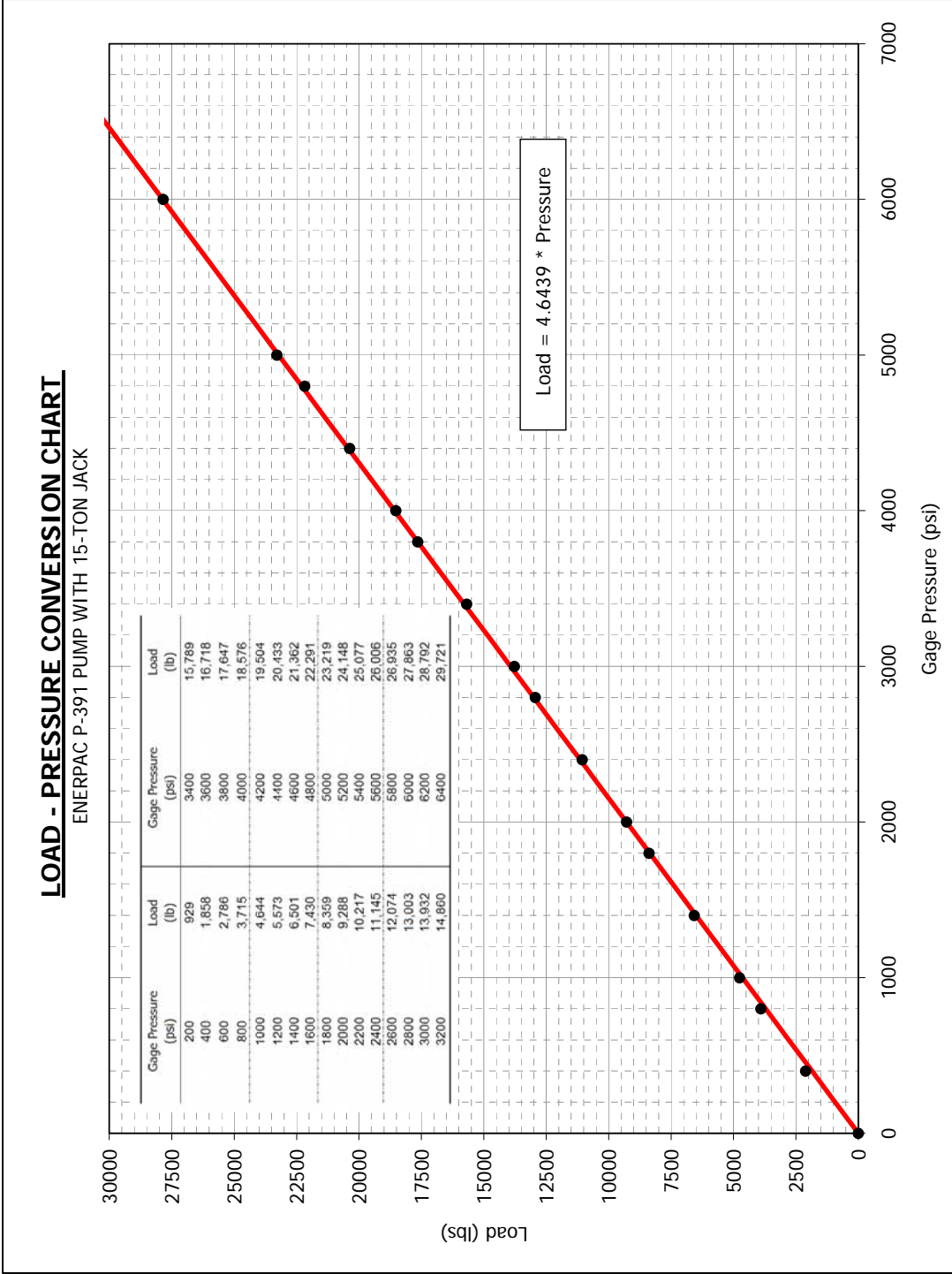

Figure A-17: Calibration and cylinder pressure-load conversion chart.

Load Tests on Redesigned JVI/PSA Slotted Inserts Anchored in Concrete Slabs