

Locks & File Frame for wood furniture & cabinets



Welcome to CompX Timberline



What are we all about?

- **Locks for Wood Furniture and Cabinets**

We can lock desks, credenzas, files, store fixtures, lockers, and cabinets of all types.

- **File Frame System for Hanging Files**

Completely engineered, attractive system which maximizes filing capabilities.

- **StealthLock®**

The 1st Keyless, Invisible Cabinet Locking System

- **Made in the USA**

Manufactured and assembled in Grayslake, IL.

- **High Quality & Great Service**

All locks are made from the finest materials ... Our customer service is the best!

- **Next Day Shipment**

Most items ship within one business day.



Want Samples?
Need Help?
Don't See What You Need?

Call Us Today
1-800-LOCKBAR
or Email Us at
timberlineorders@compX.com



LOCKING SYSTEMS FOR WOOD FURNITURE

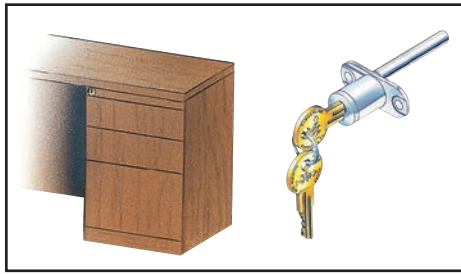

Front Gang Lock
.....Page 6



Side Gang Locks & Central Locks
.....Page 10

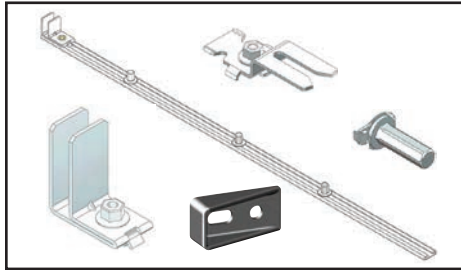

Gang Lock Components and Custom Lockbar
.....Page 12



Lateral File Locks and Anti-Tip Systems
.....Page 14

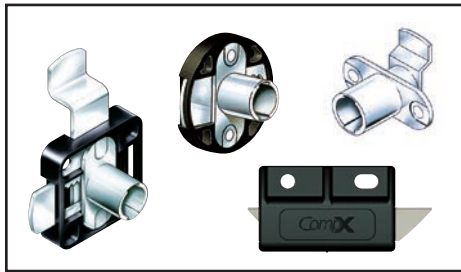

Deadbolt Locks, Cam Locks and Double Door Latch
.....Page 19

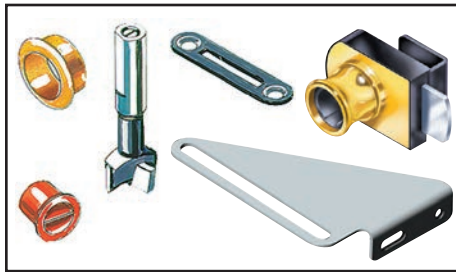

Glass Door Locks, Accessories and Strike Plates
.....Page 27



StealthLock®
.....Page 30



File Frame System
.....Page 33

Lock Finishes:



Polished Nickel
LP-100



Old English
LP-200



Black
LP-300



Statuary Bronze
LP-400



Polished Brass
LP-500



Satin Nickel
LP-700



White
LP-800

Lock Features:

- Small Diameter
- High Quality/Long Life
- 5 Disk Tumbler Lock Plug
- Solid Brass Keys
- Numbered on Face & Keys
- Over 500 Changes
- Master-Keyed
- Removable Lock Plug



TIMBERLINE REMOVABLE LOCK PLUG SYSTEM

Complete Keying Versatility

- In Plant...furniture can be keyed easily to the customer's requirements at any time.
- In Field...key numbers can be readily changed by your customer.

Ease of Finishing

- Furniture may be finished without lock plug installed, eliminating need for masking.

Simplified Inventory Management

- One stock of lock plugs fulfills all locking requirements.

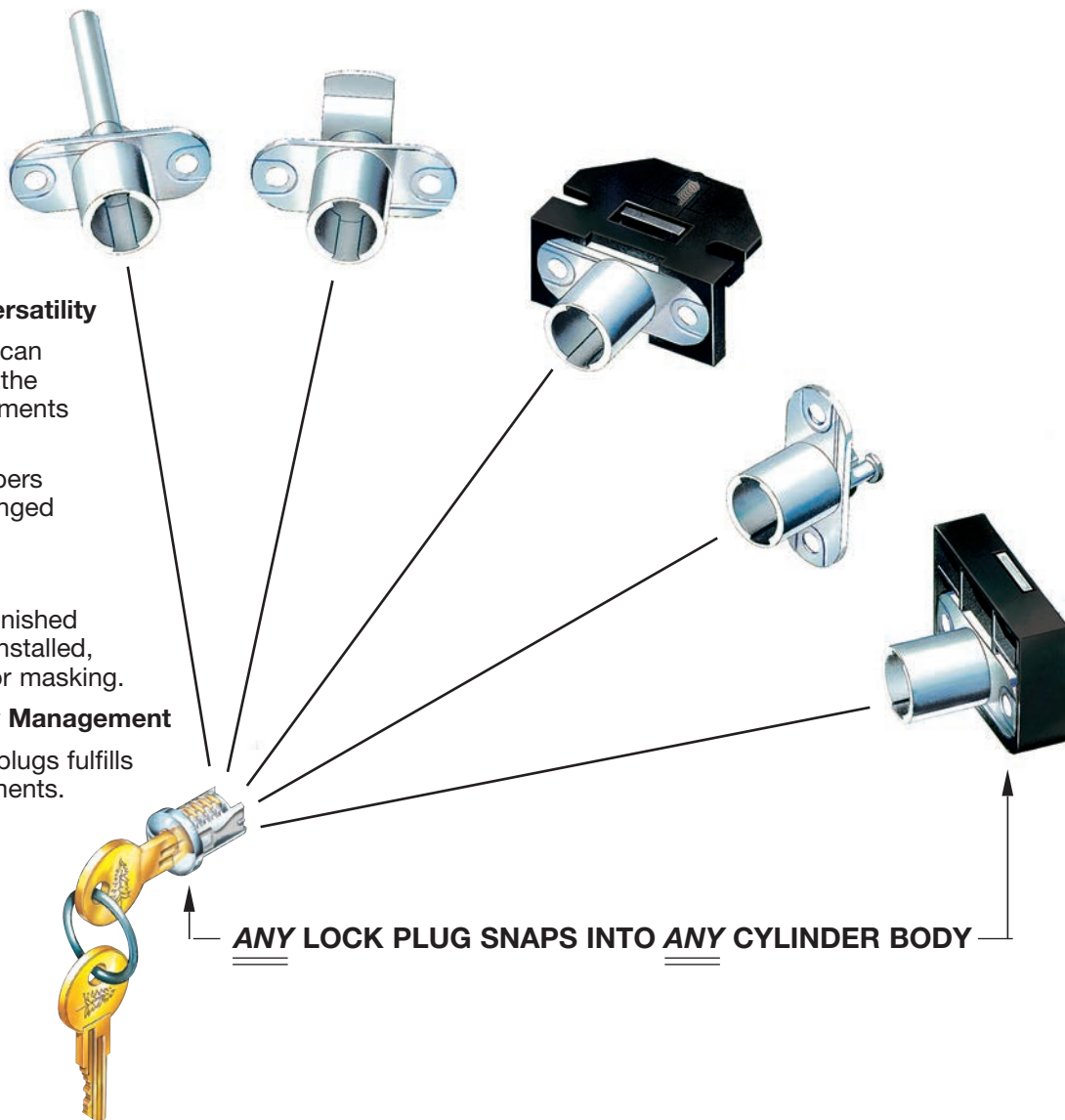

Lock Plug + Cylinder Body = Assembled Lock



A change tool (P/N KY-500) is required to remove plugs. A firm clockwise turn removes the plug.

WHEN ASSEMBLED, MOST TIMBERLINE LOCKS ARE DESIGNED FOR MOUNTING IN 3/4" OR 1" PANELS ... CHECK PRODUCT REQUIRED FOR APPLICATION OPTIONS

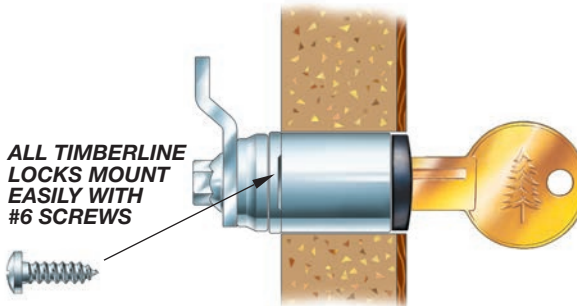

ADJUSTABLE PIN INSTALLATION

LR-100 Lockbar Retainer holds the lockbar in its groove when drawer slides alone are not sufficient.

AP-037 3/8" Adjustable Pins may be installed or moved easily with a 1/4" hex tool to any position along the length of the lockbar.

See page 12 for additional Adjustable Pin lengths.

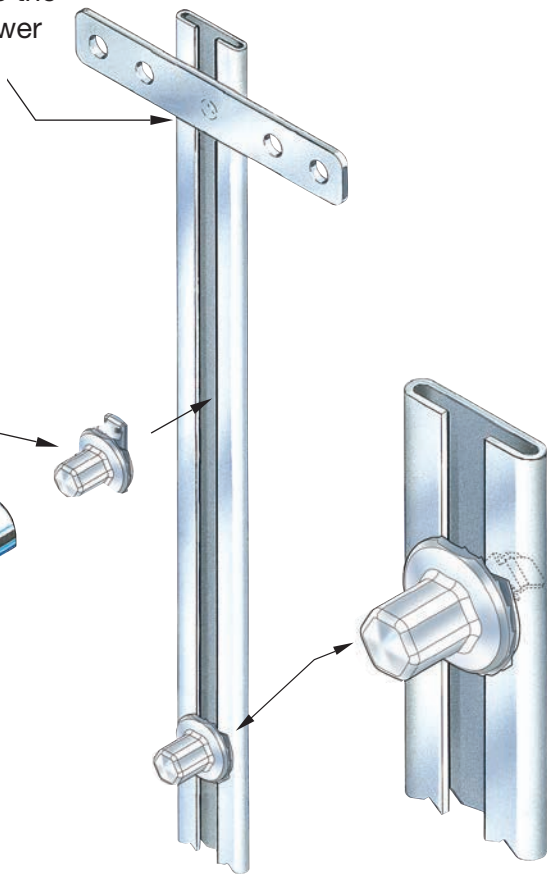
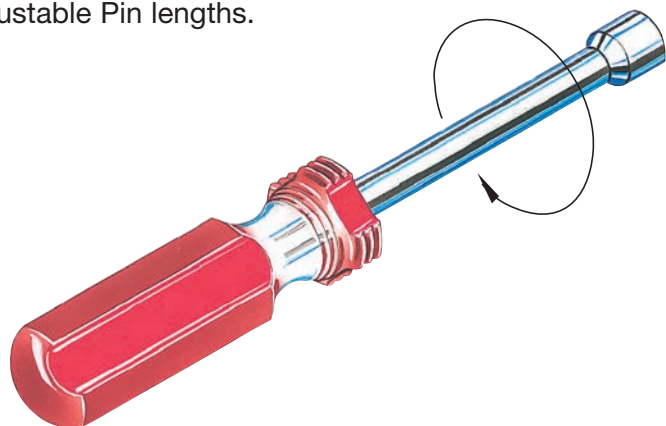

DRAWER LOCKING

DC-500 Drawer Locking Clips provide the preferred method of locking drawers with 1/2" drawer side clearance. When used with the AP-037 3/8" Adjustable Pin, a strong, rigid lock is provided. See page 12 for Drawer Clips designed for 3/4" or 7/8" drawer side clearance and for undermount slides.

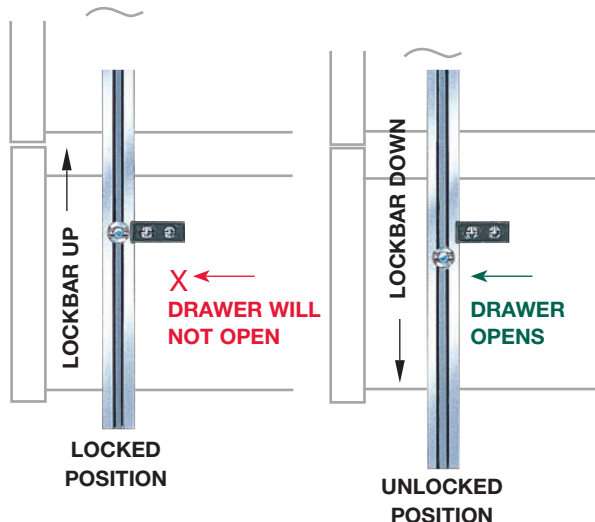
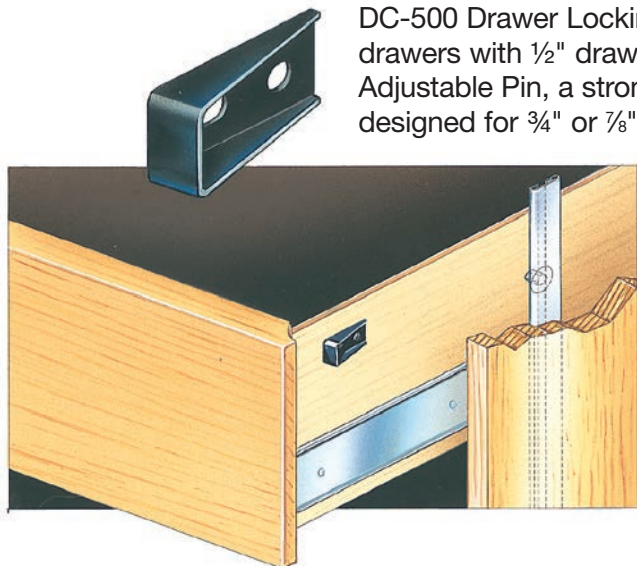

SYSTEM 101

FRONT MOUNTED GANG LOCK FOR MULTIPLE DRAWERS

- LOCK MOUNTED IN DRAWER FRONT
- MINIMIZES INTERFERENCE WITH HANGING FILES

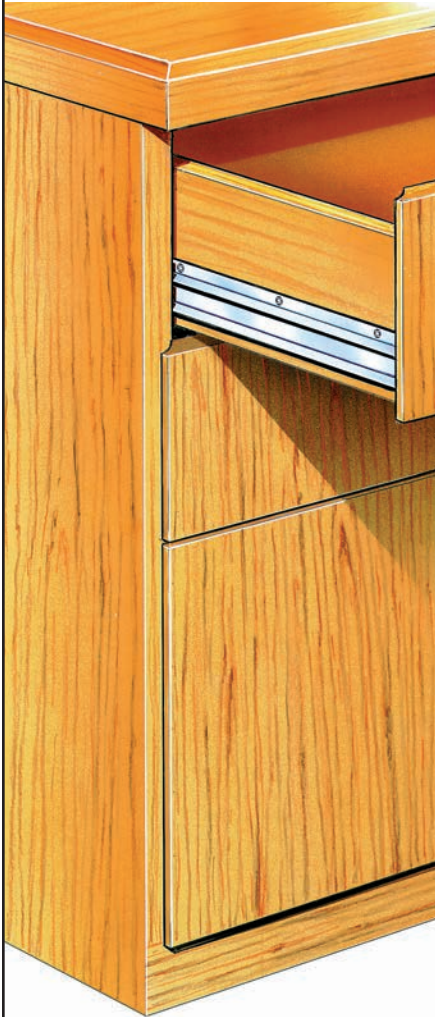

- FULL 1/2" LOCKBAR THROW
- FITS WITHIN 1/2" DRAWER SLIDE CLEARANCE
- MINIMAL MACHINING REQUIRED:
 - HOLE FOR LOCK
 - GROOVE FOR LOCKBAR
- SEE PAGE 12 WHEN USING SLIDES OTHER THAN 1/2"

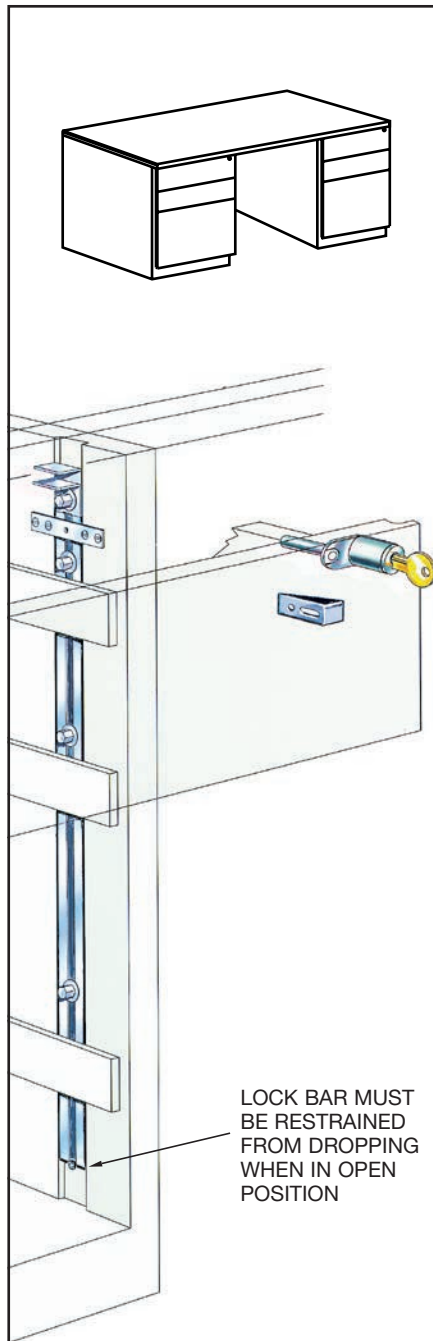

TYPICAL INSTALLATION DETAILS

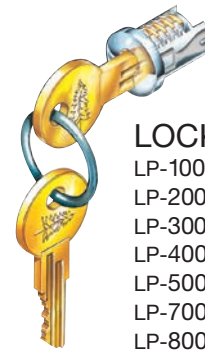
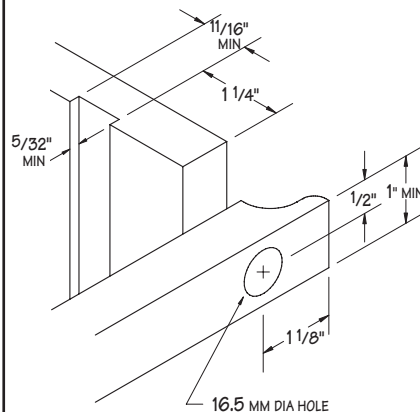

LOCK PLUGS

- LP-100 Nickel
- LP-200 Old English
- LP-300 Black
- LP-400 Statuary Bronze
- LP-500 Brass
- LP-700 Satin Nickel
- LP-800 White

CB-101
3/4" MATERIAL

CB-101-1
1" MATERIAL

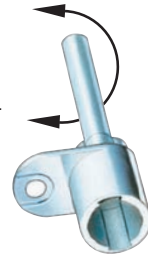

LC-106
TYPE 106
LOCKBAR CLIP

LB-240
LOCKBAR
24" STANDARD
OR CUT TO SIZE



AP-037 3/8"
ADJUSTABLE PIN



LR-100
LOCKBAR RETAINER



DC-500 DRAWER LOCKING CLIP



SYSTEM 100



- LOCK MOUNTED IN FIXED RAIL

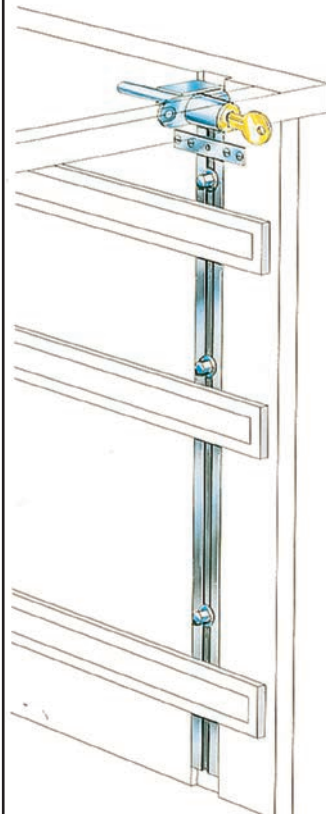

CB-100
3/4" MATERIAL

CB-100-1
1" MATERIAL

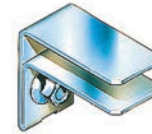
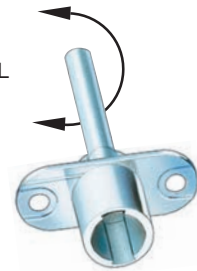

LC-100
TYPE 100
LOCKBAR CLIP

TYPICAL INSTALLATION DETAILS

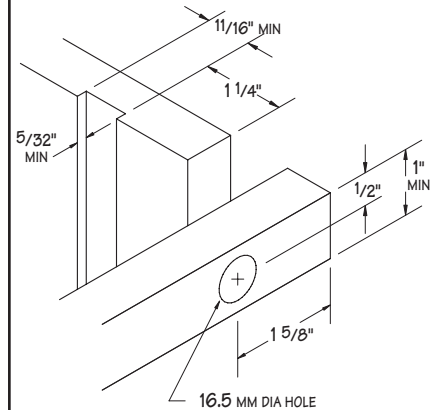

SYSTEM 104

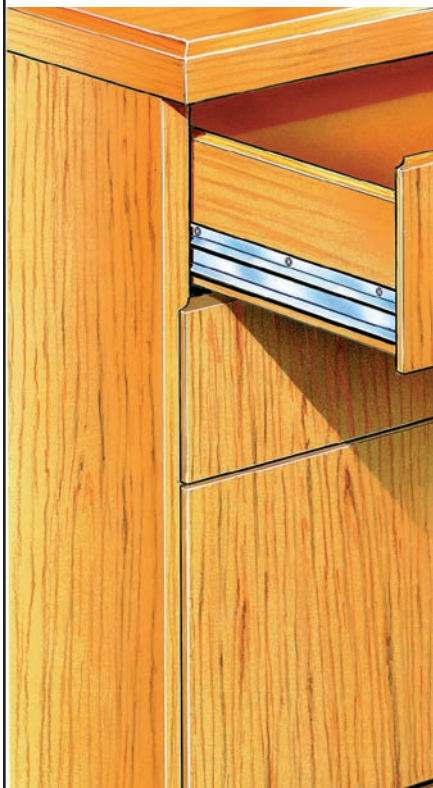

- LOCKBAR LOCATED FURTHER BACK IN CASE
- FOR USE WITH 32MM CABINET CONSTRUCTION

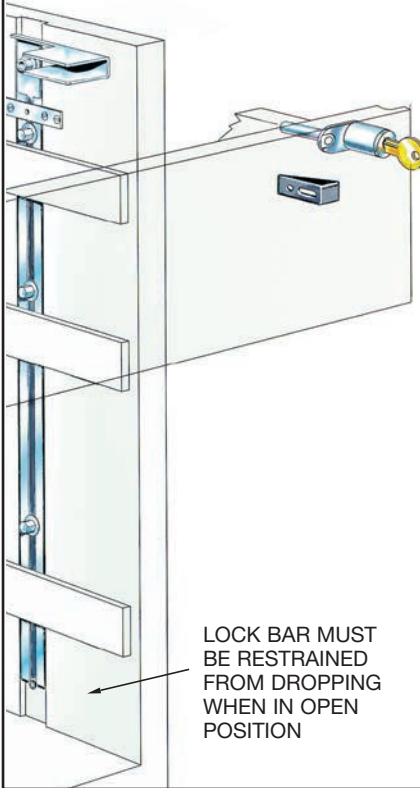

CB-101
3/4" MATERIAL

CB-101-1
1" MATERIAL

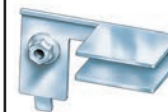
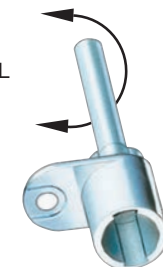

EXTENDED
LOCKBAR CLIP
LC-104 (RIGHT HAND)
LC-114 (LEFT HAND)

TYPICAL INSTALLATION DETAILS

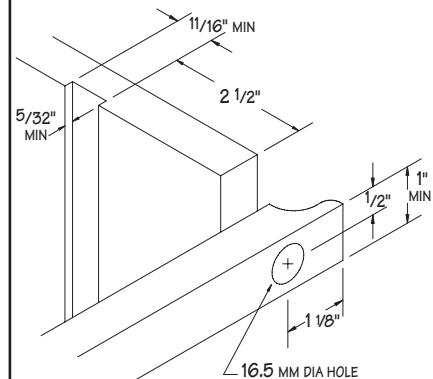

SYSTEM 120

SINGLE SIDED

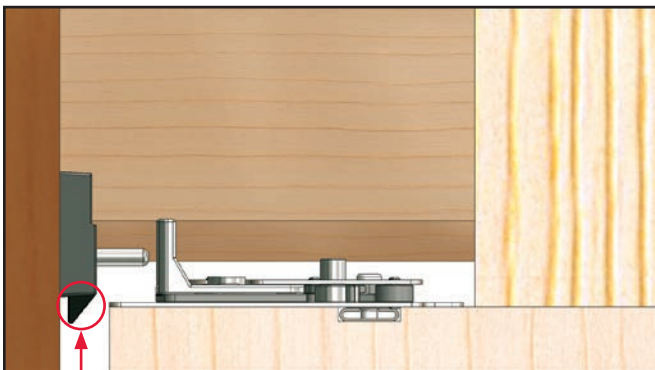
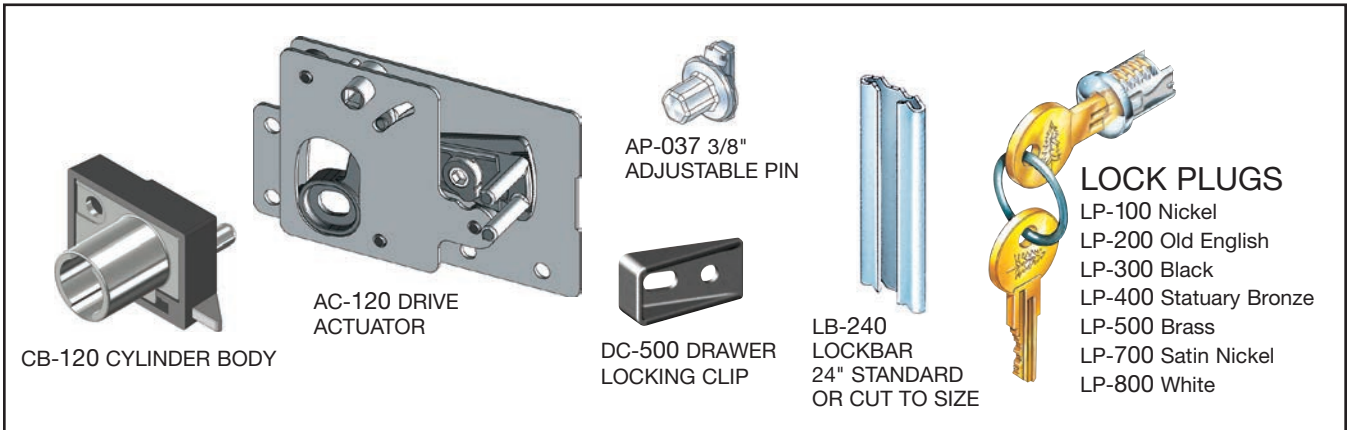
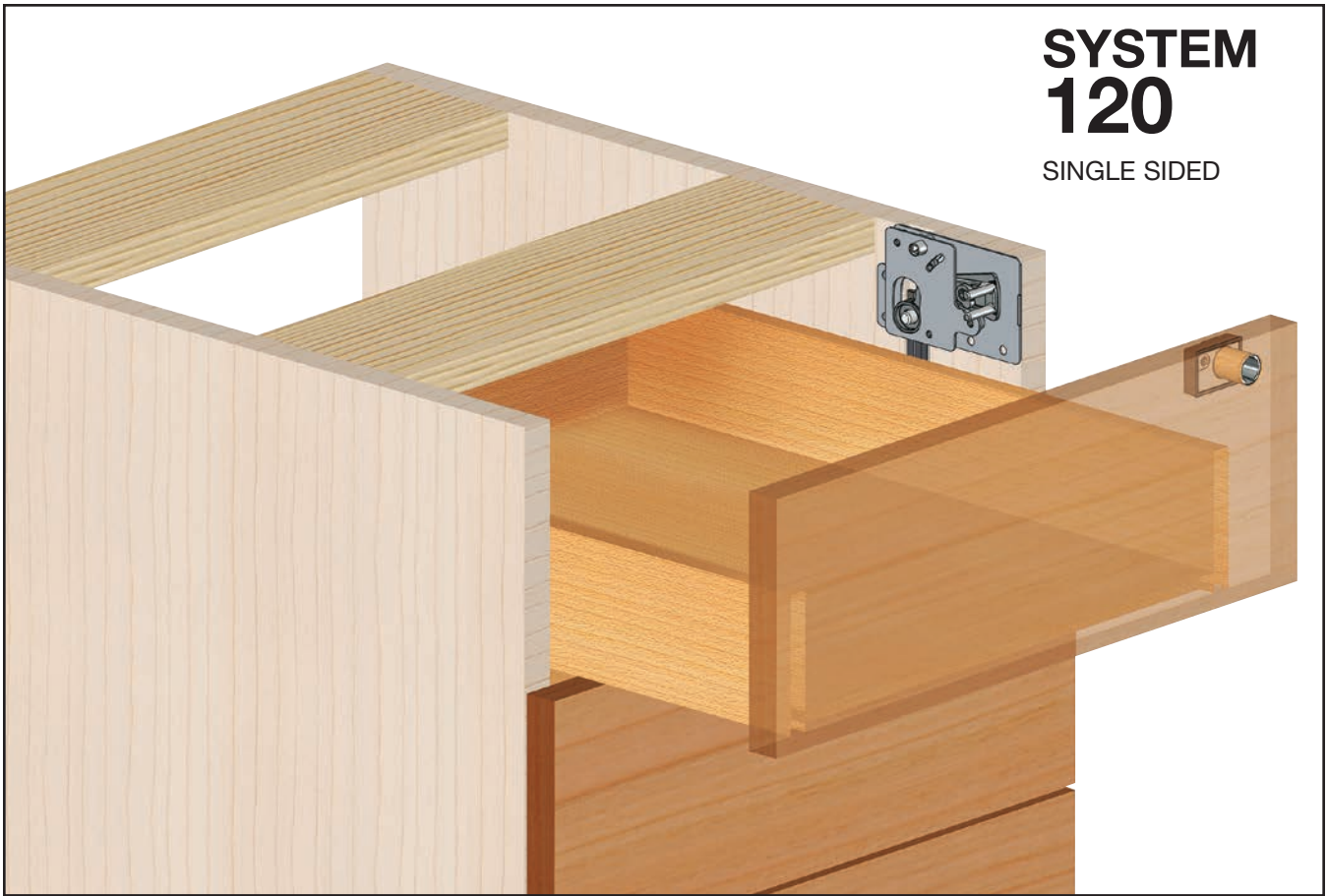

Assure-Sync feature keeps the lock and actuator position synchronized. Low profile pin cam keeps lock from interfering with the drawer box.

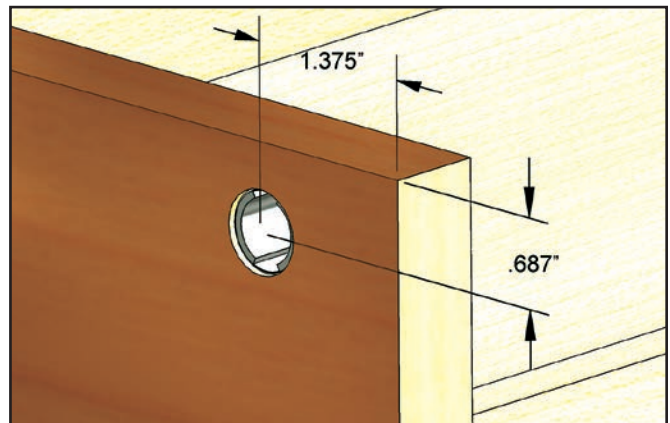

Reference dimensions for lock hole with full overlay drawer and 3/4" end panel.



SYSTEM 120

DOUBLE SIDED

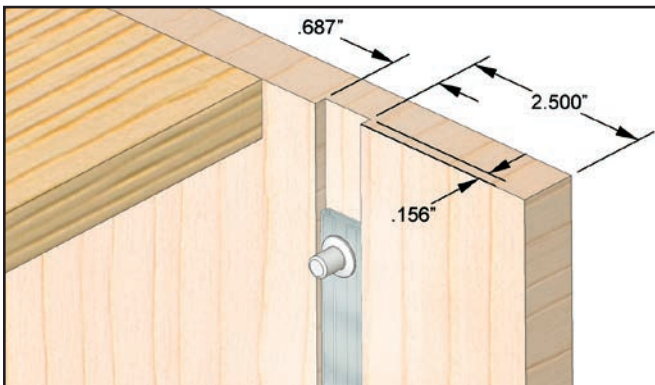
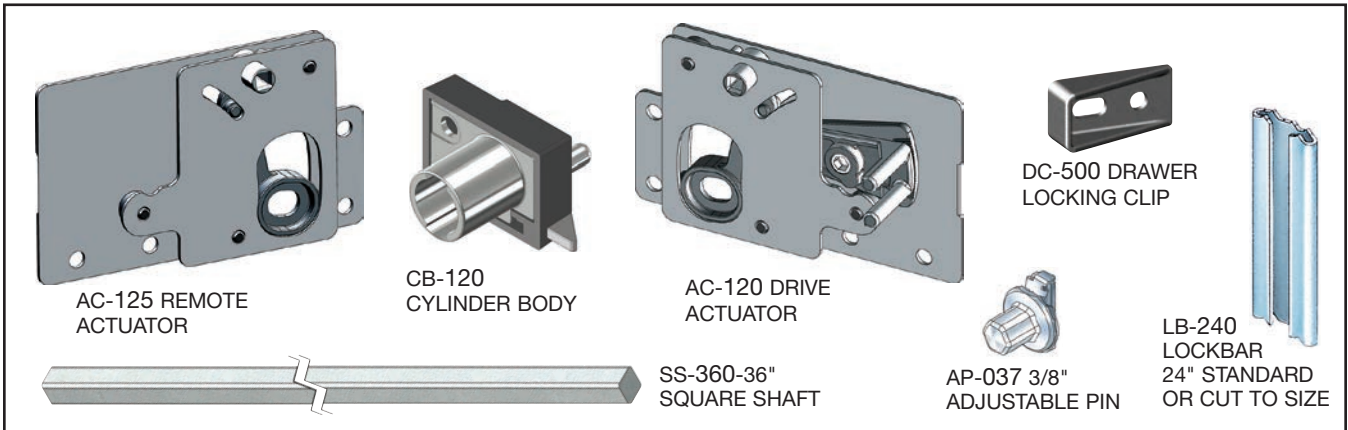
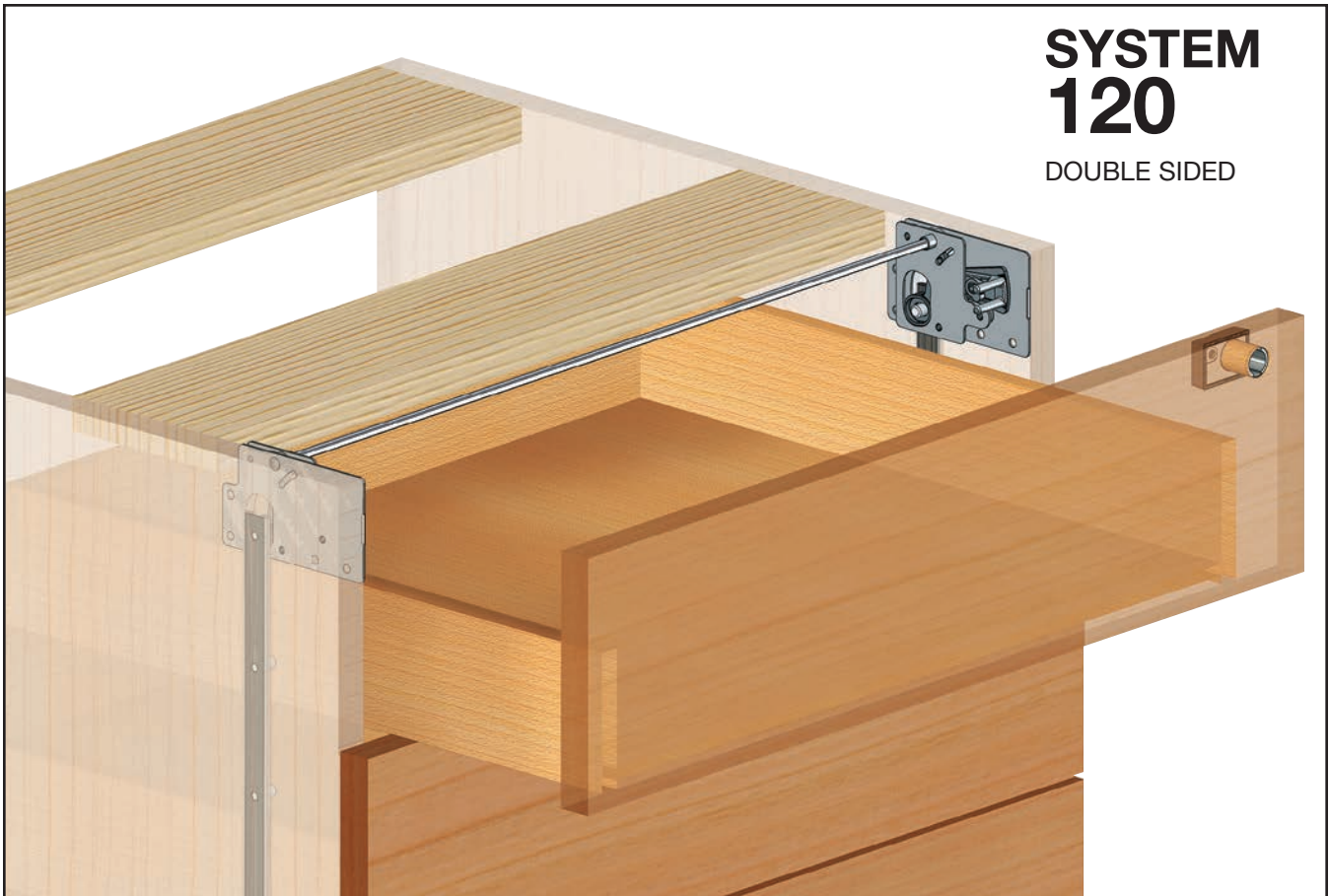

Reference dimensions for end panel with full overlay drawer. Lockbar location is the same for the AC-120 & AC-125 actuators.

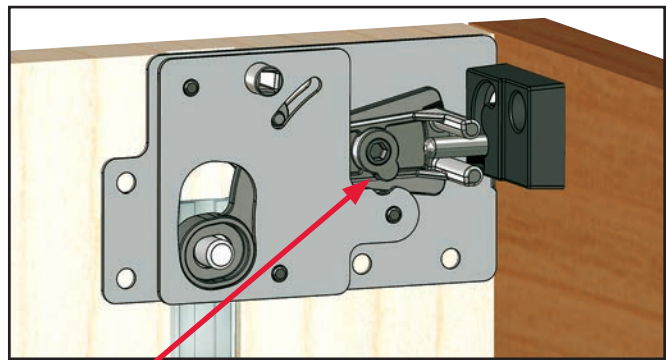

Lock arm adjusts vertically +/- 3/16" for ease of alignment. Lock arm adjusts with 5/32" hex wrench. Low profile actuator fits within 1/2" drawer suspension.



SYSTEM 270

SIDE MOUNTED GANG LOCK FOR TWO DRAWERS

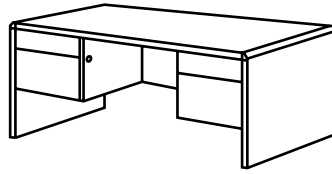

DC-500
DRAWER
LOCKING
CLIP

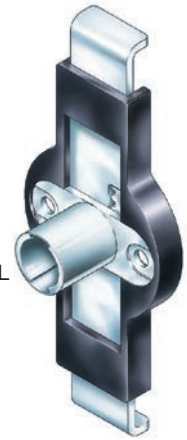

CB-270
3/4" MATERIAL

CB-270-1
1" MATERIAL

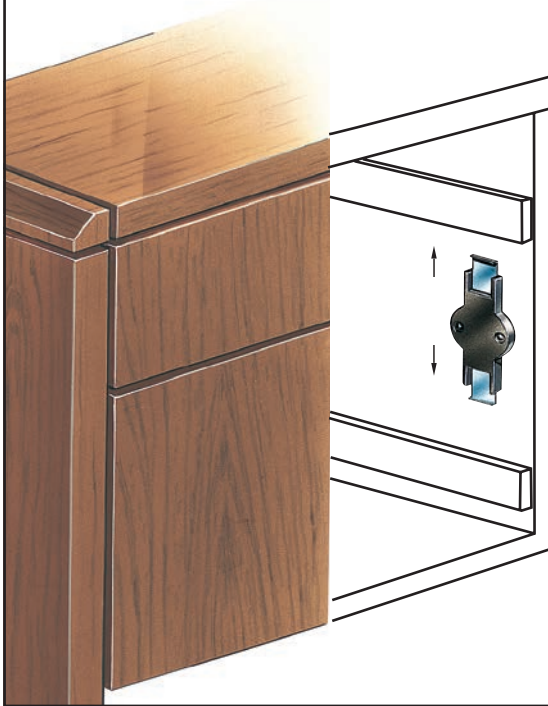

TYPICAL INSTALLATION DETAILS

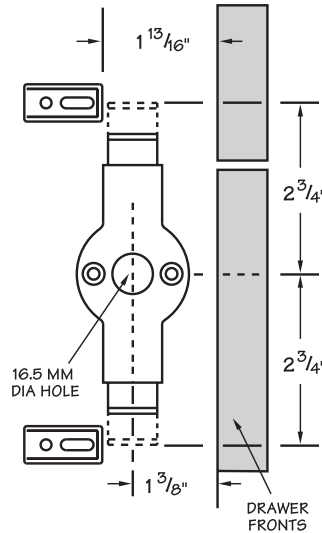

- FULL 1/2" THROW
- FITS WITHIN 1/2" DRAWER SLIDE CLEARANCE
- LOCK HOLE ONLY MACHINING REQUIRED

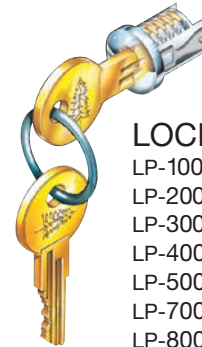

LOCK PLUGS

- LP-100 Nickel
- LP-200 Old English
- LP-300 Black
- LP-400 Statuary Bronze
- LP-500 Brass
- LP-700 Satin Nickel
- LP-800 White

SYSTEM 150

SIDE MOUNTED GANG LOCK FOR MULTIPLE DRAWERS

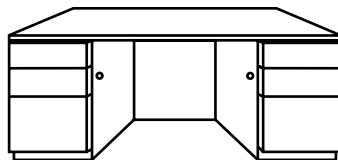

DC-500
DRAWER
LOCKING
CLIP

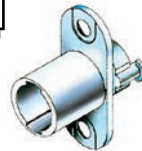

LC-150
TYPE 150
LOCKBAR CLIP

CB-150
3/4" MATERIAL

CB-150-1
1" MATERIAL

LB-240
LOCKBAR
24" STANDARD
OR CUT TO
SIZE

AP-037 3/8"
ADJUSTABLE
PIN



LR-100
LOCKBAR RETAINER

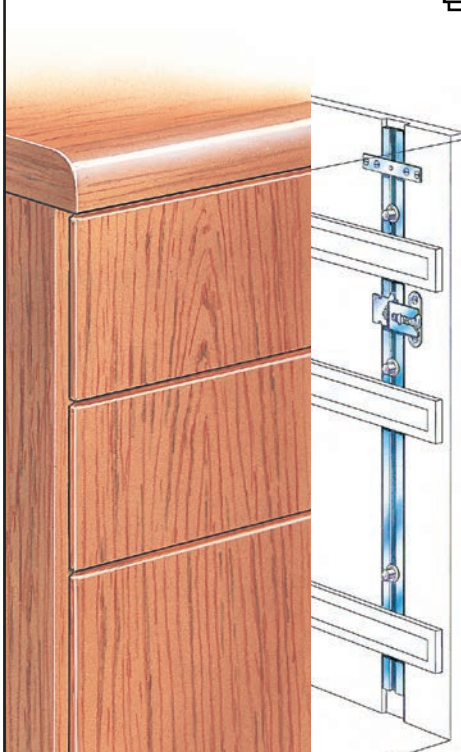

TYPICAL INSTALLATION DETAILS

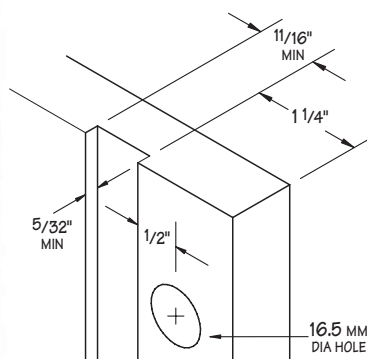

- FULL 1/2" LOCKBAR THROW
- FITS WITHIN 1/2" DRAWER SLIDE CLEARANCE
- MINIMAL MACHINING REQUIRED:
 - HOLE FOR LOCK
 - GROOVE FOR LOCKBAR
- SEE PAGE 12 IF USING SLIDES OTHER THAN 1/2"



CENTRAL LOCKING SYSTEM 500



A COMPLETE SYSTEM FOR CENTRAL LOCKING BOTH DESKS AND CREDENZAS.

Components are available for single sided units and credenzas with double doors.



Special cylinder bodies and flexible shafts available for single sided desks and double door credenzas.

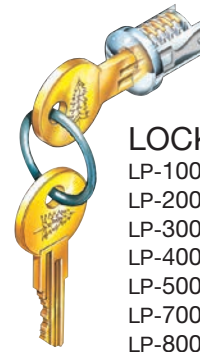

LOCK PLUGS

- LP-100 Nickel
- LP-200 Old English
- LP-300 Black
- LP-400 Statuary Bronze
- LP-500 Brass
- LP-700 Satin Nickel
- LP-800 White

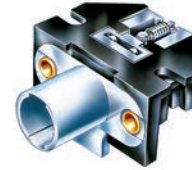

- CB-550
3/4" MATERIAL
- CB-550-1
1" MATERIAL

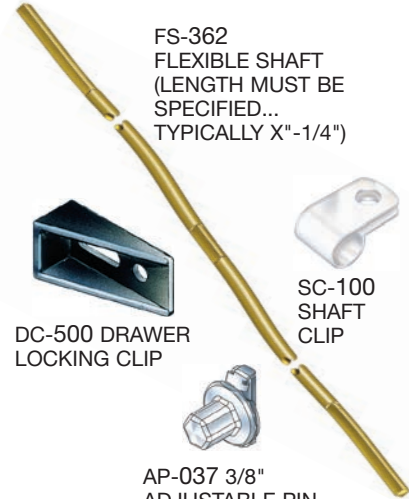

FS-362
FLEXIBLE SHAFT
(LENGTH MUST BE SPECIFIED...
TYPICALLY X"-1/4")



DC-500 DRAWER
LOCKING CLIP



SC-100
SHAFT
CLIP



AP-037 3/8"
ADJUSTABLE PIN



LB-240
LOCKBAR
24" STANDARD
OR CUT TO SIZE



SP-250
STRIKE
PLATE



LR-100
LOCKBAR
RETAINER

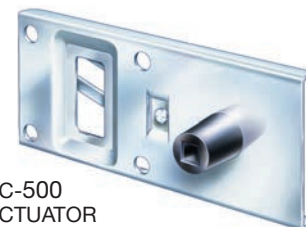

AC-500
ACTUATOR

TYPICAL INSTALLATION

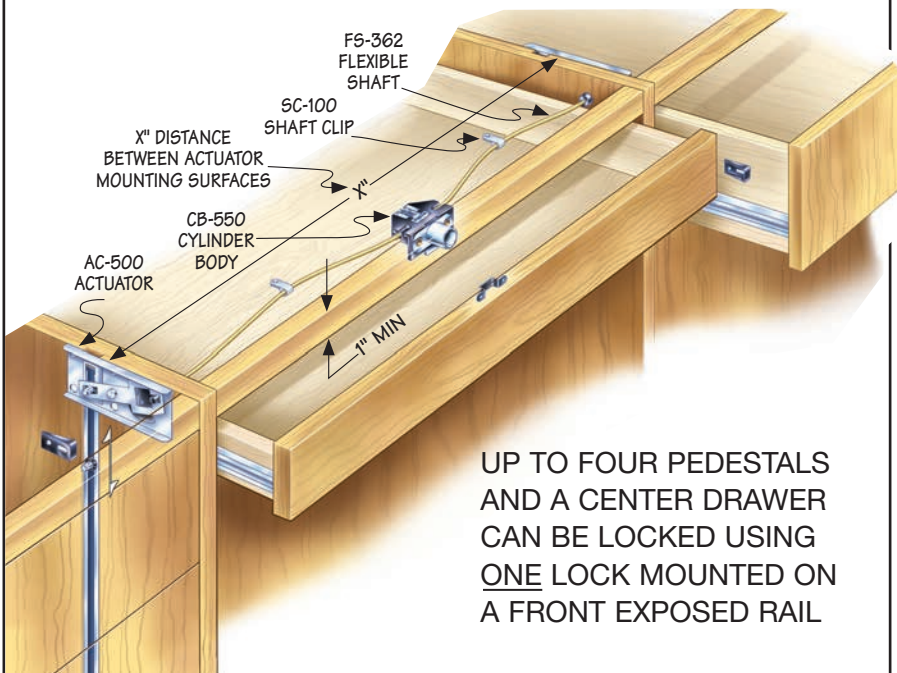

UP TO FOUR PEDESTALS AND A CENTER DRAWER CAN BE LOCKED USING ONE LOCK MOUNTED ON A FRONT EXPOSED RAIL

ADJUSTABLE PINS

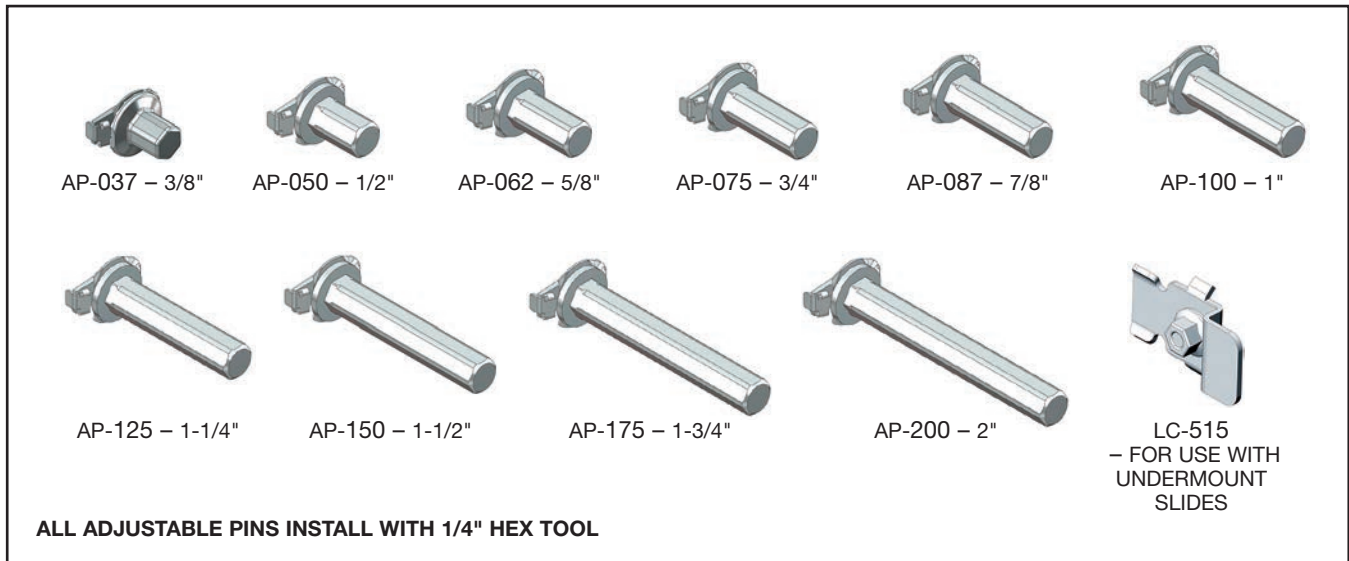

DRAWER CLIPS

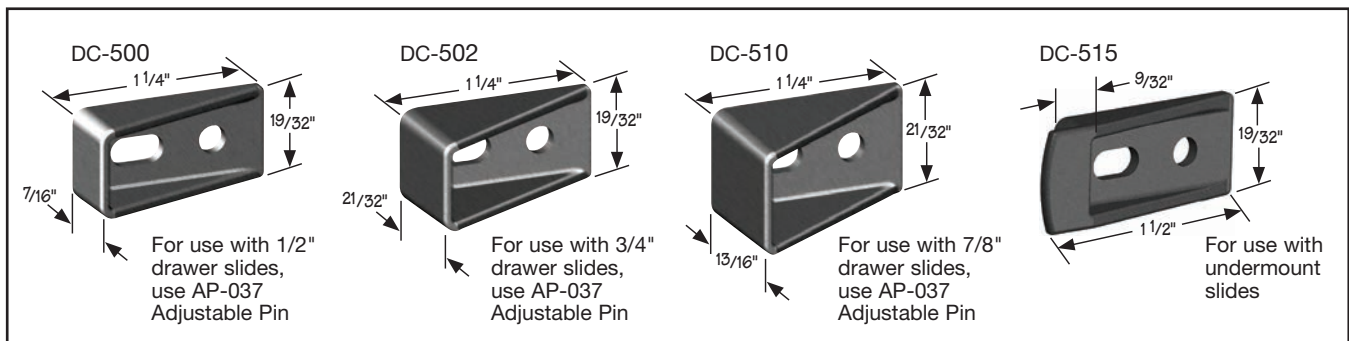

CUSTOM LOCKBARS

- Manufactured using any CompX Timberline Lockbar Clip, Adjustable Pin or Fixed Pin
- Reduces labor and scrap costs
- Assures Lockbar Clips and locking pins are properly installed
- Custom Lockbar can be manufactured in lengths 11.000" – 60.000"

LOCKBAR ASSEMBLIES CAN INCLUDE BUT ARE NOT LIMITED TO:

FIXED PIN ONLY LOCKBAR CLIP & FIXED PINS FIXED & ADJUSTABLE PIN REVERSE MOUNTED LOCKING PIN

To order Custom Lockbar:

- Requires customer supplied print detailing location of each locking pin or lockbar clip
- 50 piece minimum order quantity



COMPX REGULATOR FOR GANG LOCKING

- Allows keyless control of gang lock SYS-100, 101 and 104
- See page B140 at comp.com/sheets/timberline_app/B-140.pdf for further information

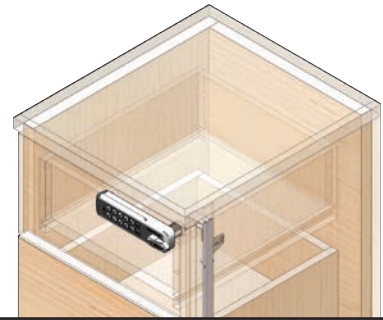

LOCKBAR CLIPS

For more information and installation specifications for Lockbar Clips, visit <http://comp.com/instructions.html> and view the CompX Timberline Application Drawings B-100 – C-115

FRONT MOUNT – STANDARD CASE CONSTRUCTION:



LC-100
1-1/4" LEG LENGTH

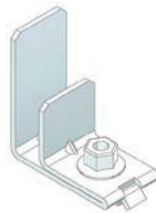

LC-105
1-1/4" & 7/8"
LEG LENGTH

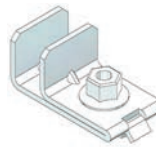

LC-106
1/2" LEG LENGTH

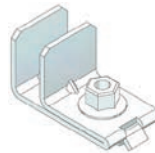

LC-107
5/8" LEG LENGTH

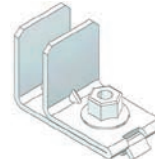

LC-109
3/4" LEG LENGTH

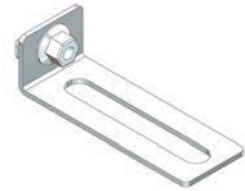

LC-102
REVERSE
MOUNT CLIP

FRONT MOUNT – 32MM CASE CONSTRUCTION:

LEFT HAND MOUNT:

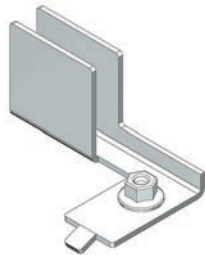

LC-114
1" LEG LENGTH

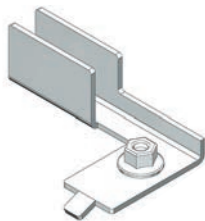

LC-214
5/8" LEG LENGTH

RIGHT HAND MOUNT:

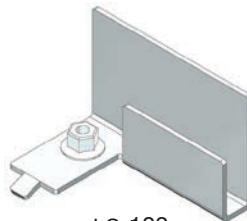

LC-103
1-1/4" & 11/16"
LEG LENGTH

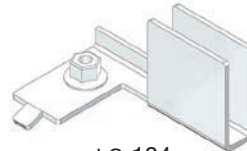

LC-104
1" LEG LENGTH

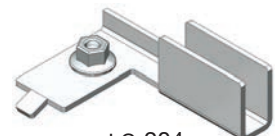

LC-204
5/8" LEG LENGTH

SIDE MOUNT:

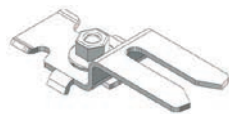

LC-150
FOR 3/4" - 1" PANELS

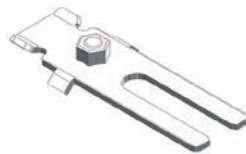

LC-152
FOR 1-1/8" - 2-1/8"
PANELS
MUST BE USED WITH
CB-110



CB-110
CYINDER BODY

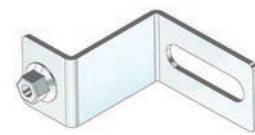

LC-101
FOR 2-1/8" - 3-1/4"
PANELS
MUST BE USED WITH
CB-110



ANTI-TIP INTERLOCK SYSTEM 400

2-DRAWER LATERAL (NO LOCK)

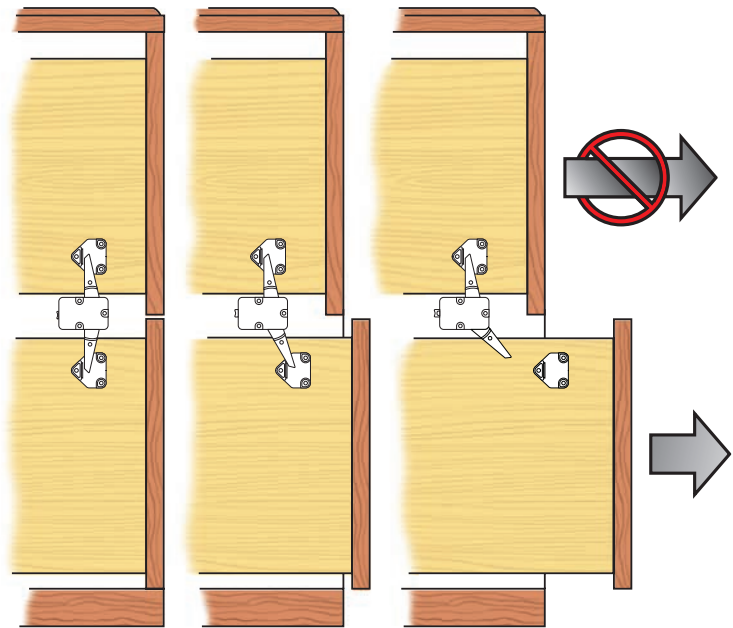

WHEN EITHER DRAWER IS PULLED OPEN, THE DRAWER CLIP ON THAT DRAWER MOVES THE SNAPPER INTO A LOCKED POSITION... THEREBY PREVENTING ANY FURTHER DRAWERS FROM BEING OPENED

TYPICAL INSTALLATION DETAILS

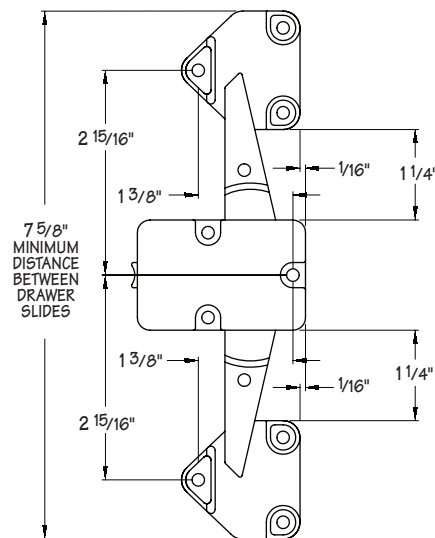

- PREVENTS MORE THAN ONE DRAWER FROM BEING OPENED AT A TIME
- MEETS BIFMA STANDARDS FOR STRENGTH AND DURABILITY
- ALL COMPONENTS ARE SURFACE MOUNTED
- WIDE TOLERANCE ACCOMMODATION
- EASY TO MOUNT AND LOW COST
- 1/2" DRAWER SLIDE CLEARANCE REQUIRED

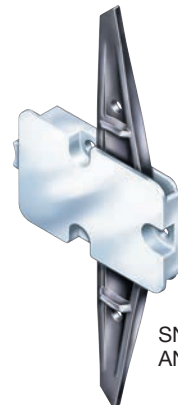

SN-400
ANTI-TIP SNAPPER



DC-400
DRAWER CLIP



ANTI-TIP INTERLOCK SYSTEM 400

3 OR 4-DRAWER LATERAL (NO LOCK)

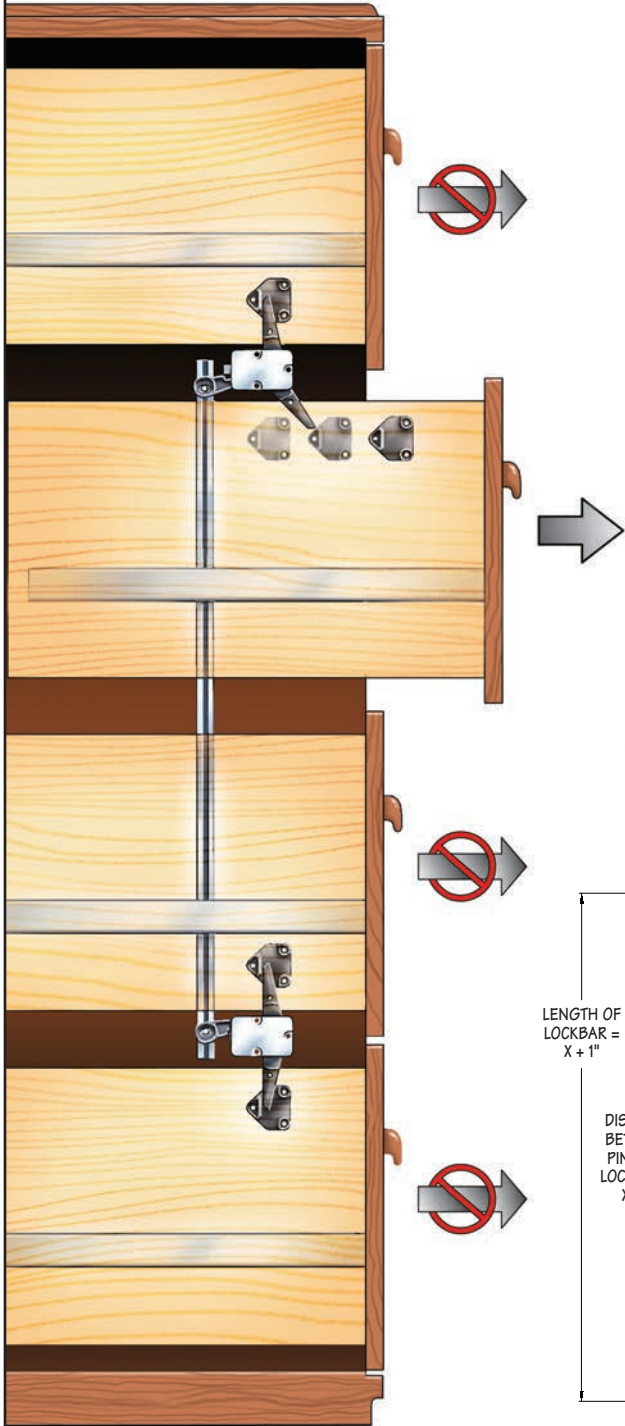

DC-410 NARROW DRAWER CLIP

FOR USE WHEN LESS SPACE IS ALLOWABLE BETWEEN DRAWER SLIDES

DC-410
NARROW
DRAWER CLIP

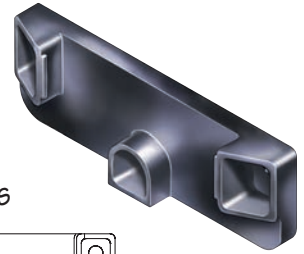

TYPICAL INSTALLATION DETAILS

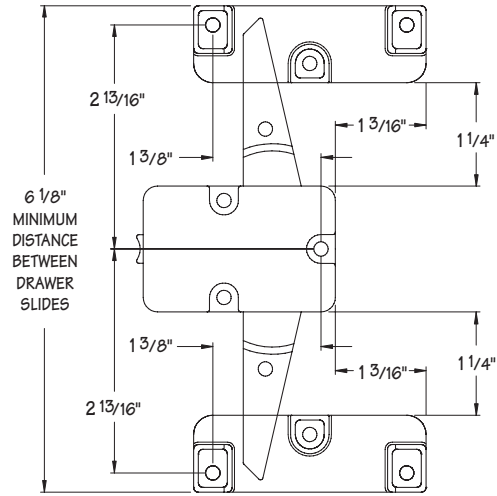

LINKAGE COMPONENTS

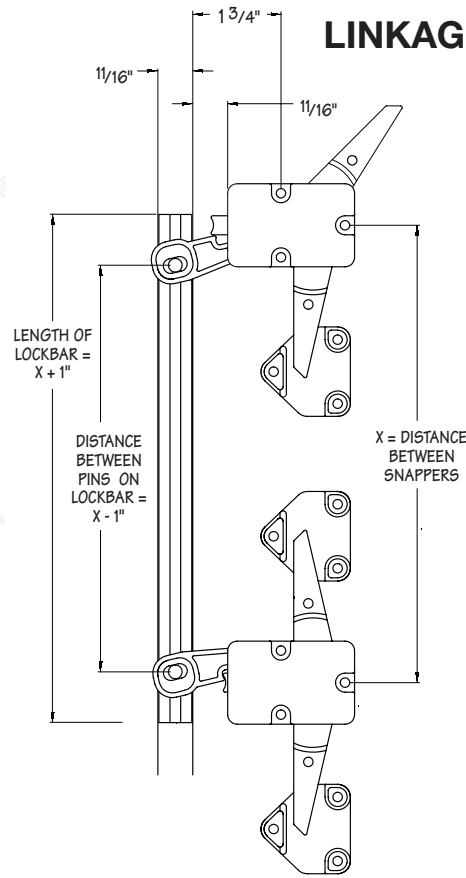

SN-410
LINKAGE ARM



LOCKBAR
FIXED PIN
(SEE DRAWING
FOR SIZING
INSTRUCTIONS)

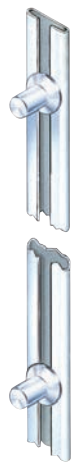

ANTI-TIP INTERLOCK SYSTEM 350

(NO LOCK)

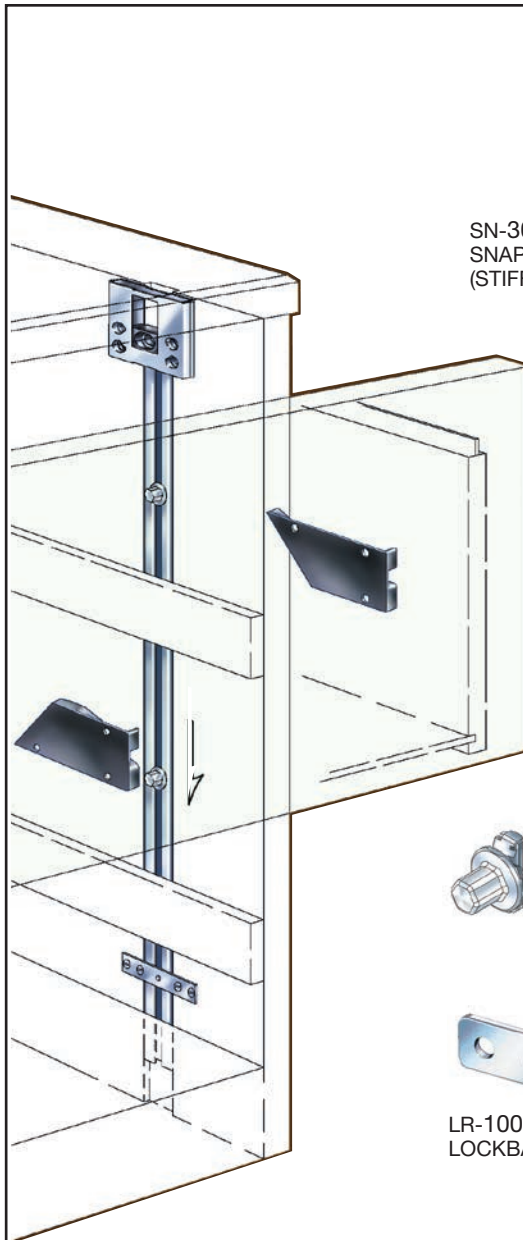

SN-300
SNAPPER
(STIFF ACTION)

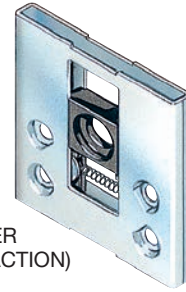

LB-240
LOCKBAR
24" STANDARD
OR CUT TO SIZE



AP-037 3/8"
ADJUSTABLE PIN



LR-100
LOCKBAR RETAINER

WD-21A
ANTI-TIP
WEDGE TYPE A



WD-21B
ANTI-TIP
WEDGE TYPE B

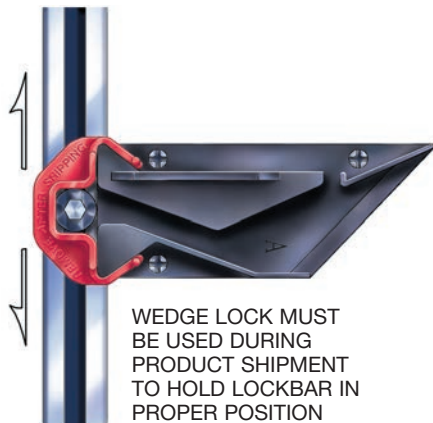

WEDGE LOCK MUST
BE USED DURING
PRODUCT SHIPMENT
TO HOLD LOCKBAR IN
PROPER POSITION



WD-100
WEDGE LOCK



ANTI-TIP INTERLOCK FUNCTION

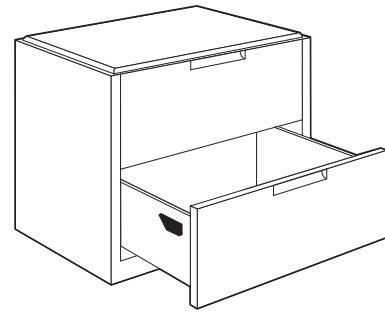
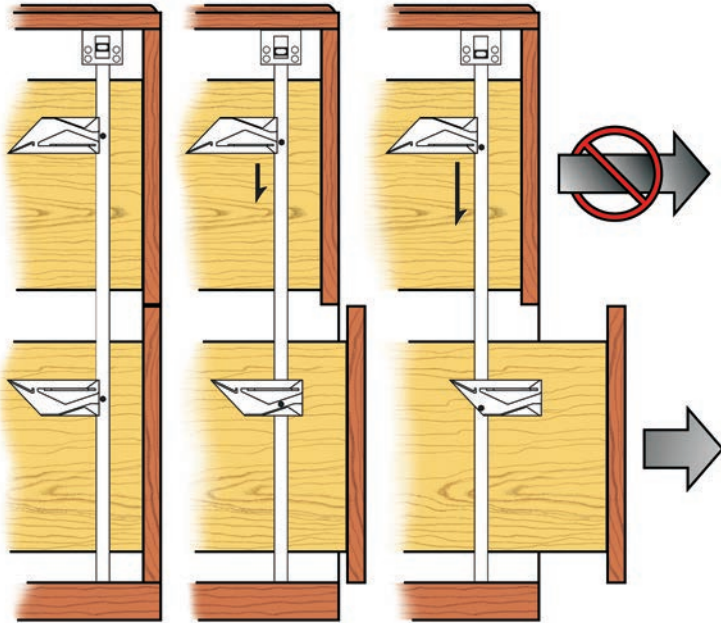

WHEN ANY DRAWER IS PULLED OPEN, THE WEDGES ON THAT DRAWER MOVE THE LOCKBAR INTO A LOCKED POSITION... THEREBY PREVENTING ANY FURTHER DRAWERS FROM BEING OPENED

PROPER WEDGE CONFIGURATION

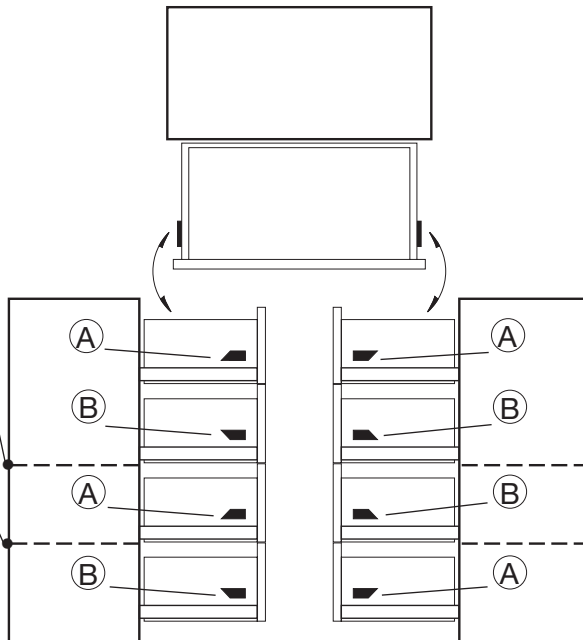

WHEN WEDGES ARE INSTALLED IN THE PROPER POSITIONS AS SHOWN ABOVE, ONLY ONE DRAWER MAY EVER BE OPEN AT ANY ONE TIME... EVEN IF TWO DRAWERS ARE PULLED AT EXACTLY THE SAME TIME!

TL-200 WEDGE/PIN MARKING TOOL

REQUIRED FOR PROPER INSTALLATION

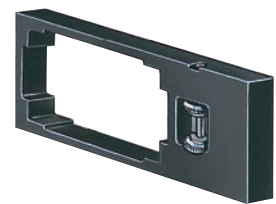

ACCURATELY MARKS PIN POSITION FOR PROPER WEDGE ACTION

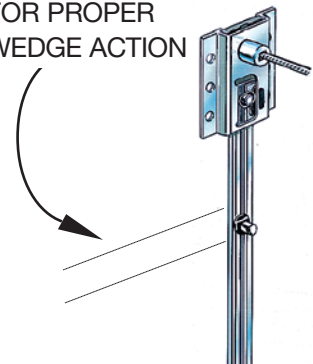

LATERAL FILE LOCK/INTERLOCK SYSTEM 300

LOCKS WIDE
DRAWERS ON
BOTH SIDES AND
PROVIDES ANTI-
TIP INTERLOCK

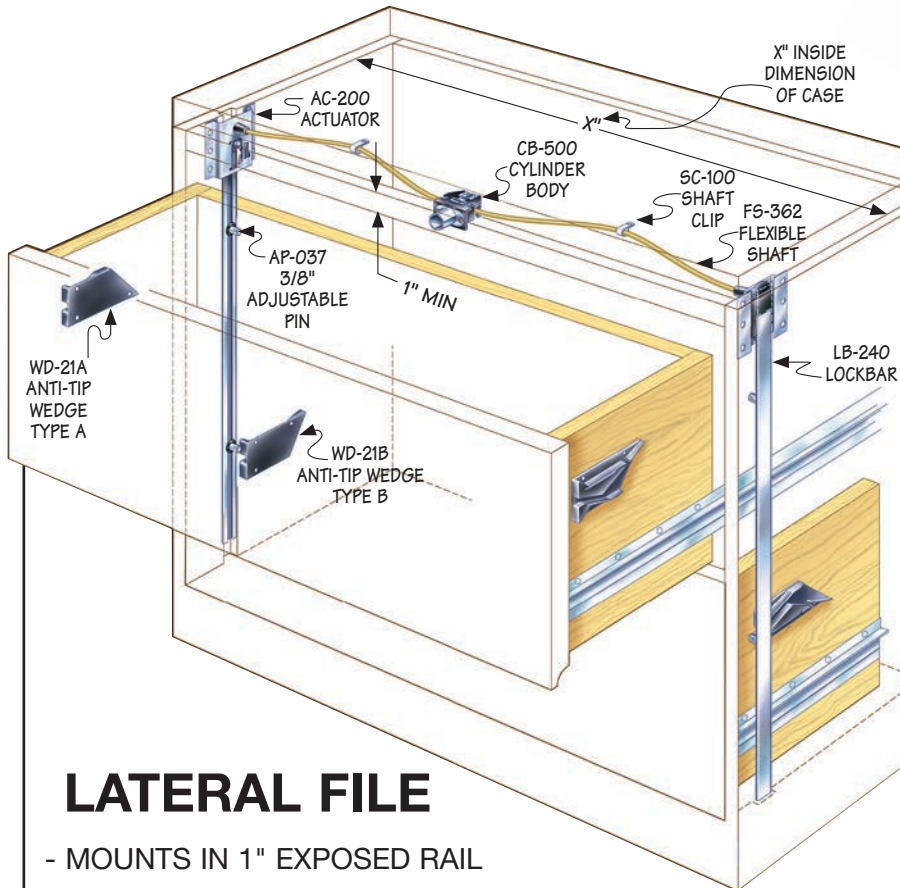

LATERAL FILE

- MOUNTS IN 1" EXPOSED RAIL
- ANTI-TIP INTERLOCK HELPS PREVENT ACCIDENTAL TIPPING OF FILE UNIT
- SEE PROPER WEDGE CONFIGURATION ON PAGE 14

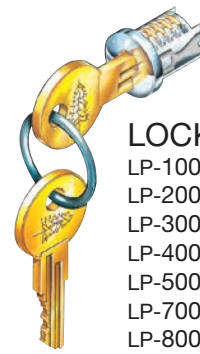
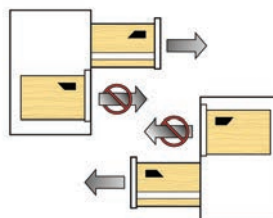

LOCK PLUGS

- LP-100 Nickel
- LP-200 Old English
- LP-300 Black
- LP-400 Statuary Bronze
- LP-500 Brass
- LP-700 Satin Nickel
- LP-800 White



- CB-500
3/4" MATERIAL
- CB-500-1
1" MATERIAL

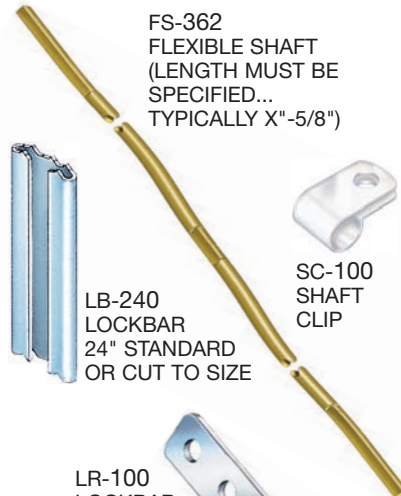

- FS-362
FLEXIBLE SHAFT
(LENGTH MUST BE SPECIFIED...
TYPICALLY X"-5/8")



- LB-240
LOCKBAR
24" STANDARD
OR CUT TO SIZE



- SC-100
SHAFT
CLIP

- LR-100
LOCKBAR
RETAINER

- WD-21A
ANTI-TIP
WEDGE TYPE A



- AP-037 3/8"
ADJUSTABLE PIN

- WD-21B
ANTI-TIP
WEDGE TYPE B



- AC-200
ACTUATOR



DOUBLE DOOR LOCK TYPE 250

- REQUIRES 16.5 MM DIAMETER HOLE
- MOUNTS IN 3/4" MATERIAL

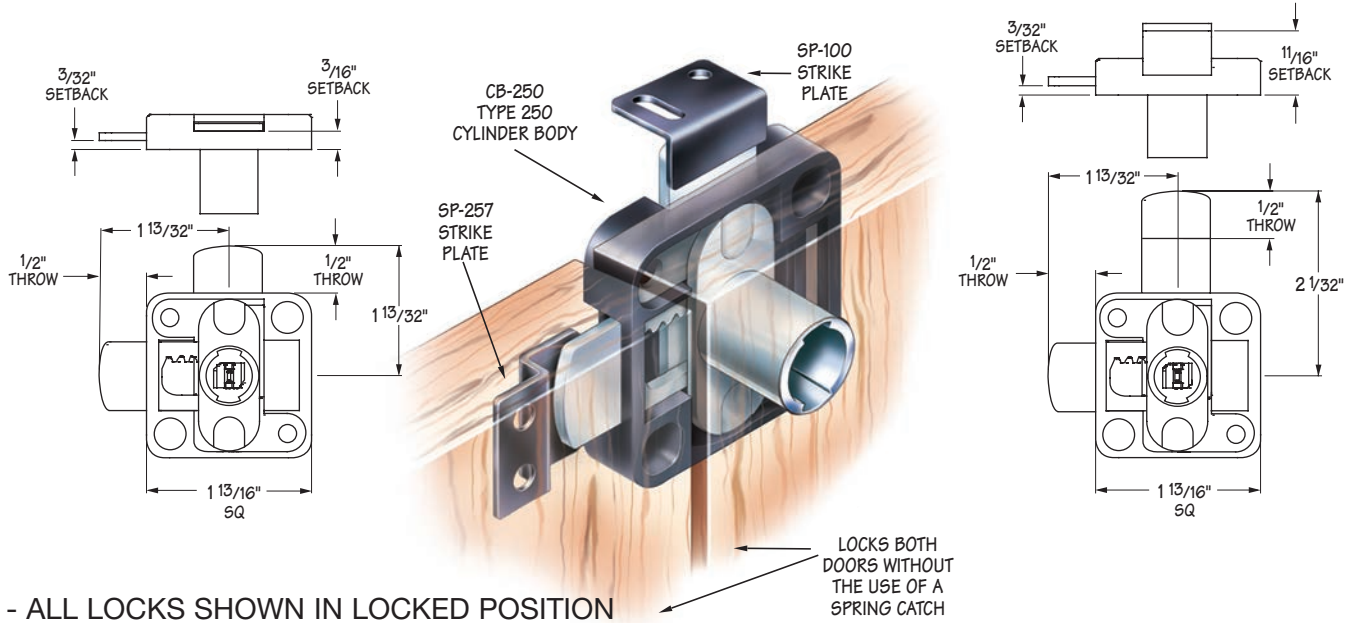

- ALL LOCKS SHOWN IN LOCKED POSITION

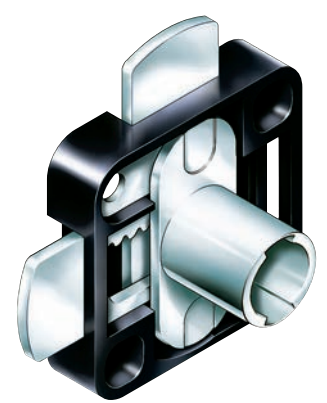
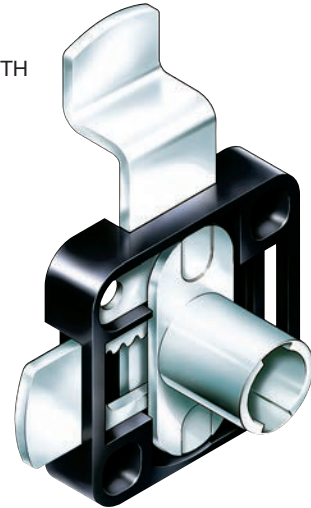
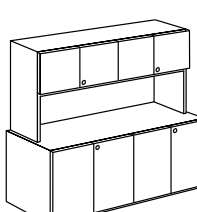
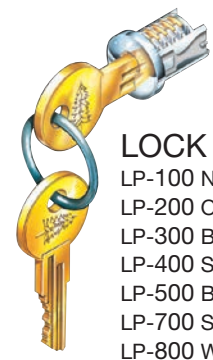
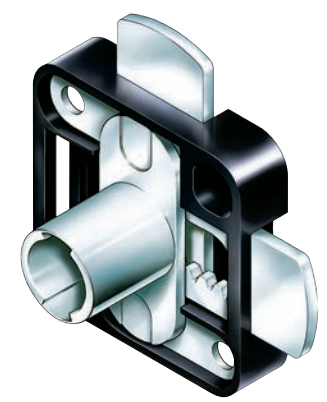
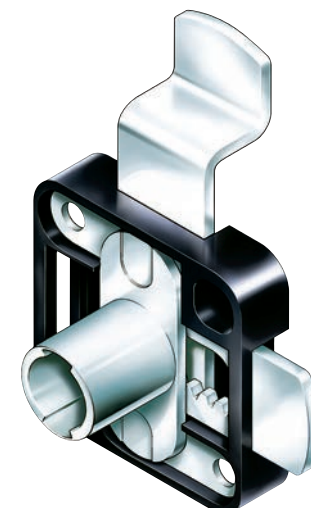
<p>CB-250 TYPE 250 DOUBLE DOOR LOCK</p> 	<p>CB-251 TYPE 251 DOUBLE DOOR LOCK WITH 11/16" OFFSET</p> 
 <p>LOCK PLUGS</p> <ul style="list-style-type: none"> LP-100 Nickel LP-200 Old English LP-300 Black LP-400 Statuary Bronze LP-500 Brass LP-700 Satin Nickel LP-800 White 	
<p>CB-255 TYPE 255 OPPOSITE MOUNT DOUBLE DOOR LOCK</p> 	<p>CB-256 TYPE 256 OPPOSITE MOUNT DOUBLE DOOR LOCK WITH 11/16" OFFSET</p> 



DEADBOLT LOCKS HORIZONTAL MOUNT

- TWO STYLES AVAILABLE
- REQUIRES 16.5 MM DIAMETER HOLE
- ATTRACTIVE TOUGH NYLON HOUSING
- MOUNTS IN 3/4" OR 1" MATERIAL



CB-230
3/4" MATERIAL
CB-230-1
1" MATERIAL

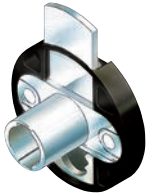
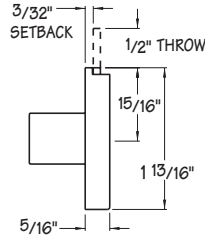

CB-231
3/4" MATERIAL
CB-231-1
1" MATERIAL

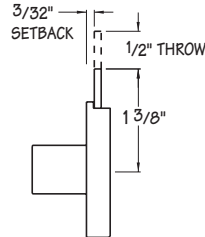

SP-250
STRIKE
PLATE
CB-232
3/4" MATERIAL
CB-232-1
1" MATERIAL

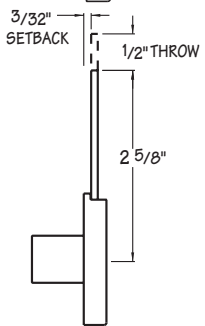

CB-234
3/4" MATERIAL
CB-234-1
1" MATERIAL

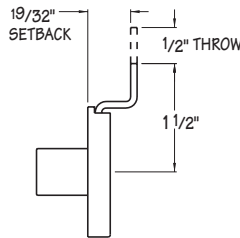

CB-235
3/4" MATERIAL
CB-235-1
1" MATERIAL

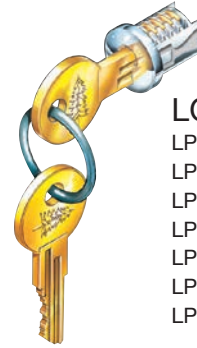
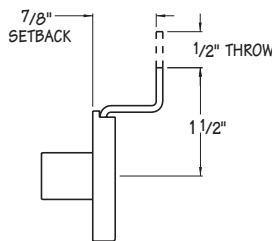

LOCK PLUGS

- LP-100 Nickel
- LP-200 Old English
- LP-300 Black
- LP-400 Statuary Bronze
- LP-500 Brass
- LP-700 Satin Nickel
- LP-800 White

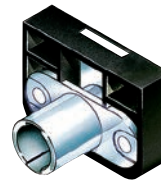

CB-280
3/4" MATERIAL
CB-280-1
1" MATERIAL

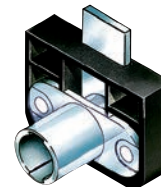
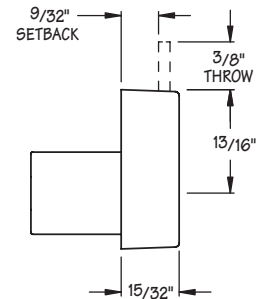

CB-281
3/4" MATERIAL
CB-281-1
1" MATERIAL

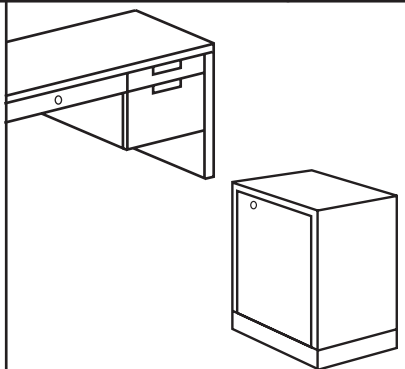
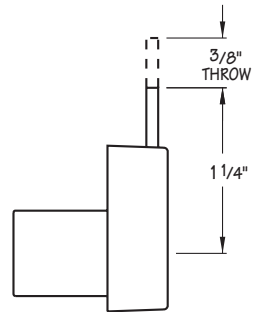

DEADBOLT LOCKS VERTICAL MOUNT

- TWO STYLES AVAILABLE
- REQUIRES 16.5 MM DIAMETER HOLE
- ATTRACTIVE TOUGH NYLON HOUSING
- MOUNTS IN 3/4" OR 1" MATERIAL

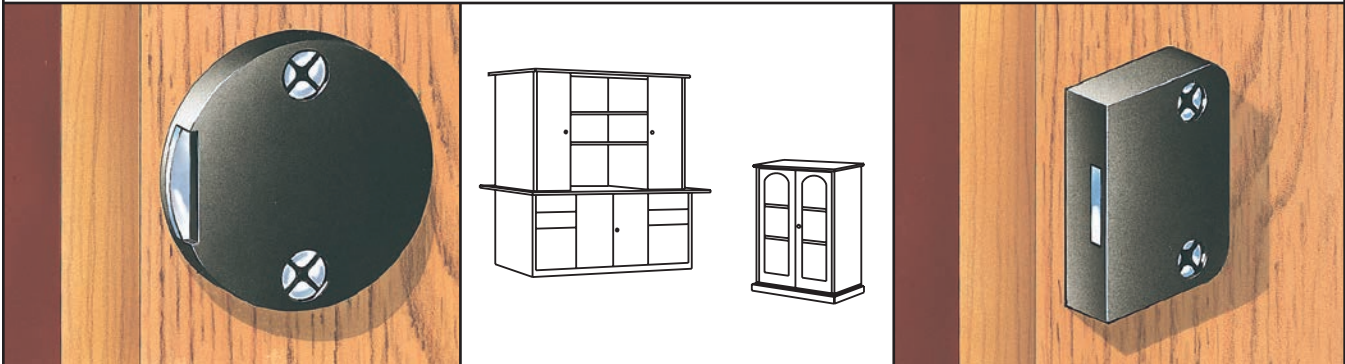

CB-240
3/4" MATERIAL
CB-240-1
1" MATERIAL

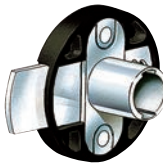
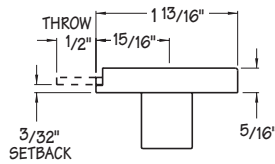

CB-241
3/4" MATERIAL
CB-241-1
1" MATERIAL

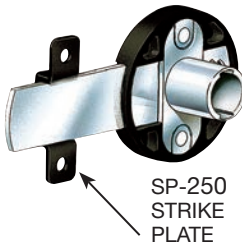
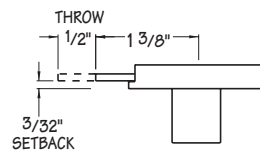

CB-242
3/4" MATERIAL
CB-242-1
1" MATERIAL

SP-250
STRIKE
PLATE

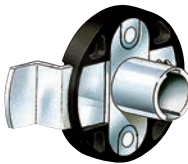
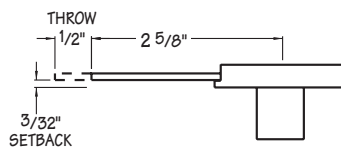

CB-244
3/4" MATERIAL
CB-244-1
1" MATERIAL

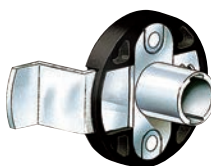
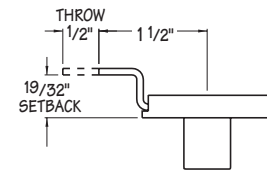

CB-245
3/4" MATERIAL
CB-245-1
1" MATERIAL

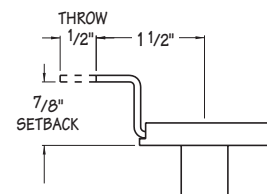

CB-290
3/4" MATERIAL
CB-290-1
1" MATERIAL

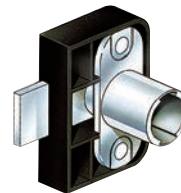
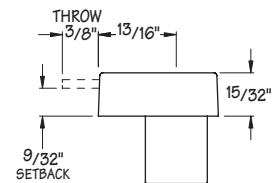

CB-291
3/4" MATERIAL
CB-291-1
1" MATERIAL

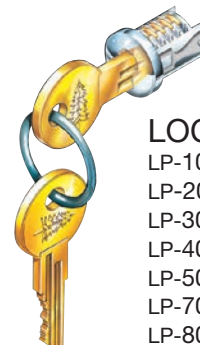
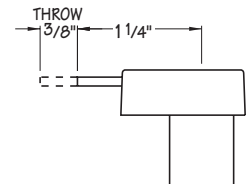

LOCK PLUGS

- LP-100 Nickel
- LP-200 Old English
- LP-300 Black
- LP-400 Statuary Bronze
- LP-500 Brass
- LP-700 Satin Nickel
- LP-800 White



CAM LOCK CYLINDER BODY

- 90° ROTATION
- REQUIRES 16.5 MM DIAMETER HOLE
- MOUNTS IN 3/4" MATERIAL

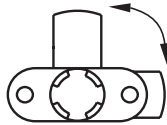

90° ROTATION

HORIZONTAL MOUNT

CB-080

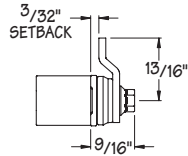

CB-083

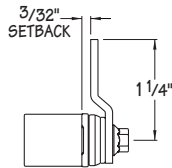
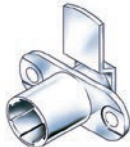

CB-084

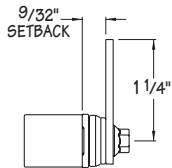
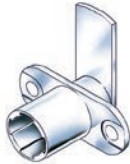

CB-087

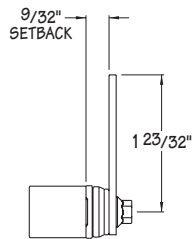

CB-085

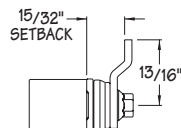

CB-088

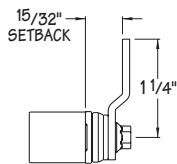
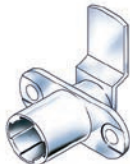

CB-089

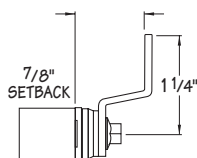
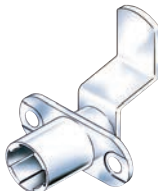

VERTICAL MOUNT

CB-090

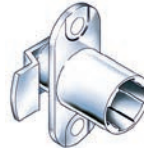

CB-093

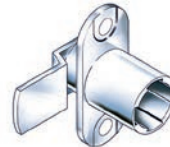

CB-094

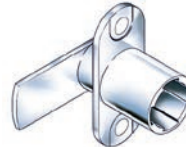

CB-097

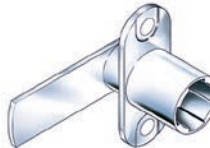

CB-095



CB-098

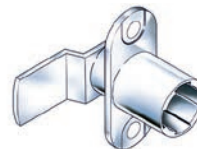

CB-099

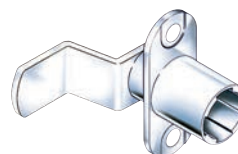

**NOTE:
CAM LOCKS
MUST BE
INSTALLED SO
THAT THEY
LOCK IN THE
COUNTER-
CLOCKWISE
POSITION!**



LOCK PLUGS

- LP-100 Nickel
- LP-200 Old English
- LP-300 Black
- LP-400 Statuary Bronze
- LP-500 Brass
- LP-700 Satin Nickel
- LP-800 White

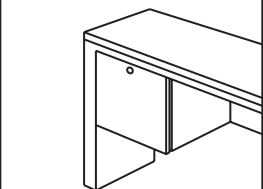
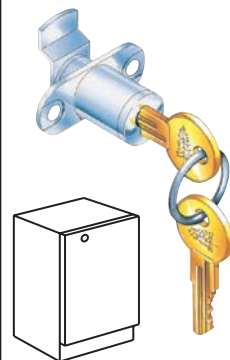

CAM LOCK CYLINDER BODY

- 180° ROTATION
- REQUIRES 16.5 MM DIAMETER HOLE
- MOUNTS IN 3/4" OR 1" MATERIAL

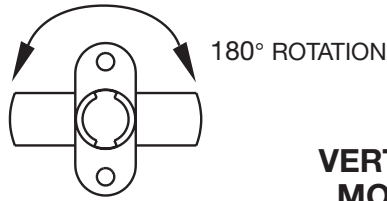

HORIZONTAL MOUNT



CB-180
3/4" MATERIAL
CB-180-1
1" MATERIAL

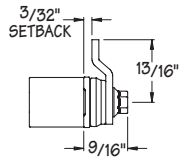

CB-183
3/4" MATERIAL
CB-183-1
1" MATERIAL

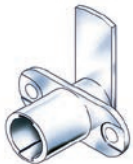
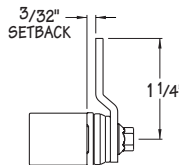

CB-184
3/4" MATERIAL
CB-184-1
1" MATERIAL

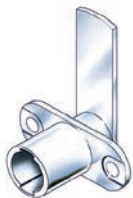
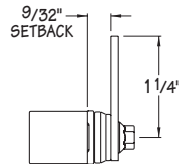

CB-187
3/4" MATERIAL
CB-187-1
1" MATERIAL

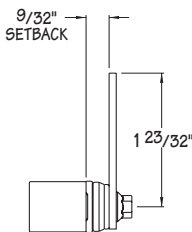

CB-185
3/4" MATERIAL
CB-185-1
1" MATERIAL

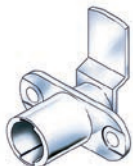
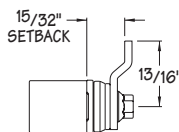

CB-188
3/4" MATERIAL
CB-188-1
1" MATERIAL

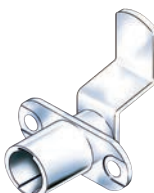
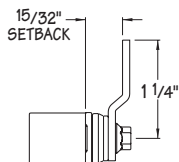

CB-189
3/4" MATERIAL
CB-189-1
1" MATERIAL

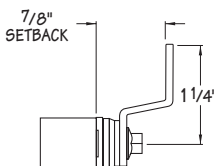

VERTICAL MOUNT

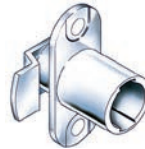

CB-190
3/4" MATERIAL
CB-190-1
1" MATERIAL

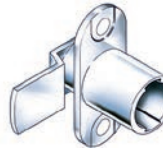

CB-193
3/4" MATERIAL
CB-193-1
1" MATERIAL

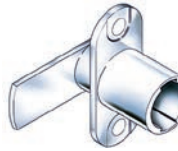

CB-194
3/4" MATERIAL
CB-194-1
1" MATERIAL

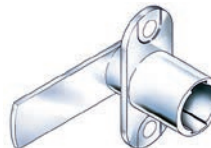

CB-197
3/4" MATERIAL
CB-197-1
1" MATERIAL



CB-195
3/4" MATERIAL
CB-195-1
1" MATERIAL

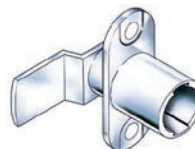

CB-198
3/4" MATERIAL
CB-198-1
1" MATERIAL

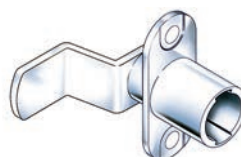

CB-199
3/4" MATERIAL
CB-199-1
1" MATERIAL

**NOTE:
CAM LOCKS
MUST BE
INSTALLED SO
THAT THEY
LOCK IN THE
COUNTER-
CLOCKWISE
POSITION!**

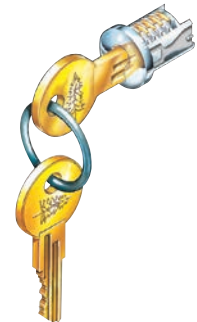

LOCK PLUGS

- LP-100 Nickel
- LP-200 Old English
- LP-300 Black
- LP-400 Statuary Bronze
- LP-500 Brass
- LP-700 Satin Nickel
- LP-800 White

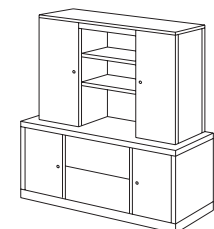
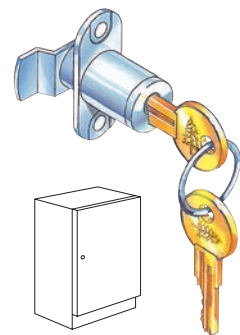

CAM LOCK KITS CB-165, CB-168, CB-169

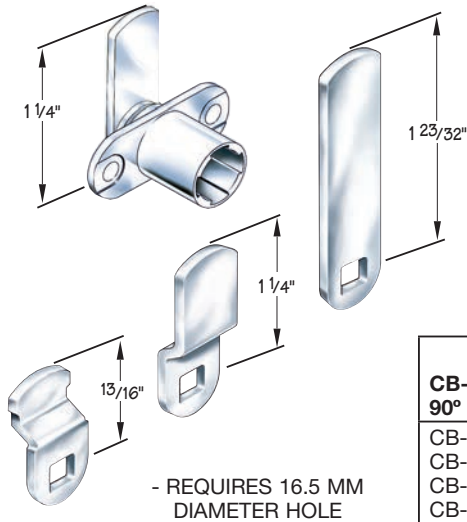

Application - Universal lock for either doors or drawers. Each kit contains a variety of easily switched cams to accommodate most locking situations.

Operation - 90° or 180° cam rotation. Counter clockwise to lock.

Keying - Order lock plug separately.

Packaging - Cylinder supplied with two straight and two bent cams. Bent cams have setback of 15/32". Cam plates are zinc plated.

These Kits will Replace the Following Timberline Cam Locks:

CB-165 90° Rotation			CB-168 180° Rotation (Horizontal)		CB-169 180° Rotation (Vertical)	
CB-080	CB-083	CB-084	CB-180	CB-183	CB-190	CB-193
CB-085	CB-087	CB-088	CB-184	CB-185	CB-194	CB-195
CB-090	CB-093	CB-094	CB-187	CB-188	CB-197	CB-198
CB-095	CB-097	CB-098				

THREADED BARREL CAM LOCK KIT

CB-141 – Nickel Plated Cylinder
CB-143 – Black Plated Cylinder (shown)

Application – Universal type lock for either doors or drawers. Kit will accommodate most locking applications for material thickness 1/16" – 1/2". Requires 3/4" mounting hole.

Industry-standard Double D hole can be used in metal applications.

Operation – 90 degree cam rotation. Counter clockwise to lock.

Keying – Order lock plugs separately.

Packaging Contents – Cylinder supplied with one straight cam, two bent cams, flange nut, hex nut and spur washer. Cam plates are zinc plated.

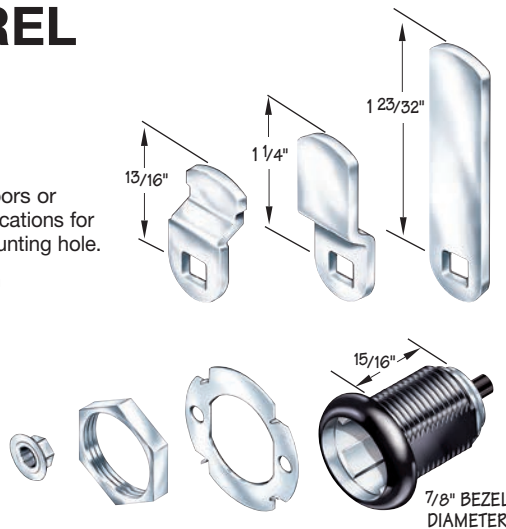

LOCK PLUGS

- LP-100 Nickel
- LP-200 Old English
- LP-300 Black
- LP-400 Statuary Bronze
- LP-500 Brass
- LP-700 Satin Nickel
- LP-800 White

FLIPPER/TAMBOUR DOOR LOCK CB 181 & CB 191

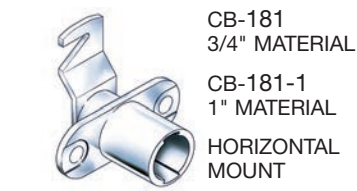

CB-181
3/4" MATERIAL
CB-181-1
1" MATERIAL
HORIZONTAL MOUNT

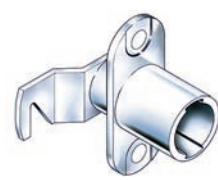

CB-191
3/4" MATERIAL
CB-191-1
1" MATERIAL
VERTICAL MOUNT

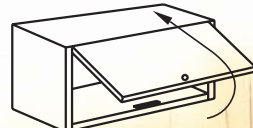
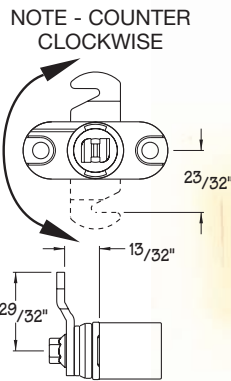

- REQUIRES 16.5 MM DIAMETER HOLE

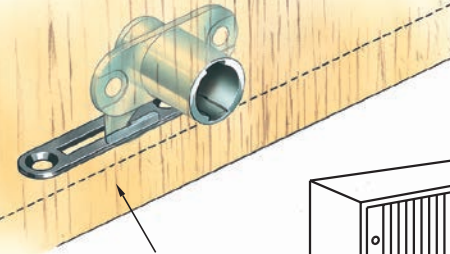

5P-181 STRIKE PLATE



PUSH LOCK TYPE 175

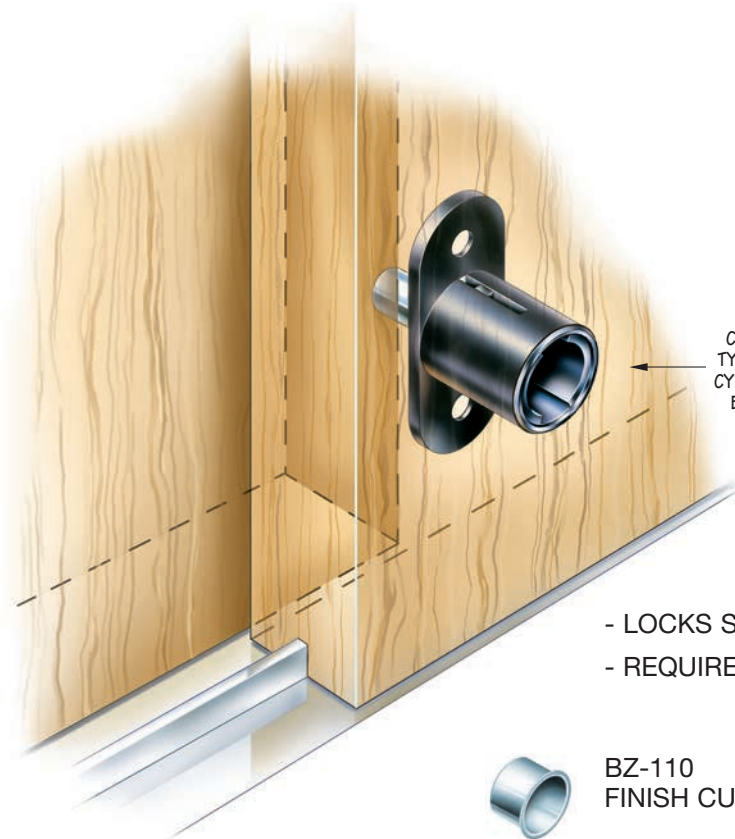

CB-175
TYPE 175
CYLINDER
BODY

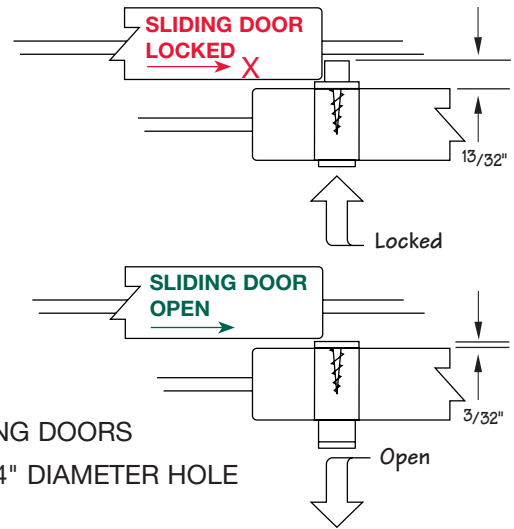

- LOCKS SLIDING DOORS
- REQUIRES 3/4" DIAMETER HOLE



BZ-110
FINISH CUP

- OPTIONAL FINISH CUP FOR BACK DOOR
- REQUIRES 1/2" HOLE
- NICKEL FINISH

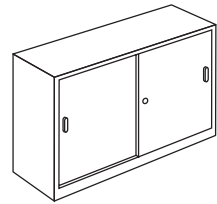

LOCK PLUGS
 LP-100 Nickel
 LP-200 Old English
 LP-300 Black
 LP-400 Statuary Bronze
 LP-500 Brass
 LP-700 Satin Nickel
 LP-800 White

THICK PANEL LOCK TYPE 170

MOUNTING FLANGE
ADJUSTS TO ALLOW
LOCK TO BE MOUNTED
IN PANELS FROM 7/8"
THICK UP
TO 1 3/8" THICK

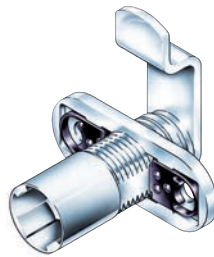

CB-170
TYPE 170
CYLINDER
BODY

- REQUIRES 16.5 MM DIAMETER HOLE
- 90° ROTATION ONLY
- COUNTER CLOCKWISE

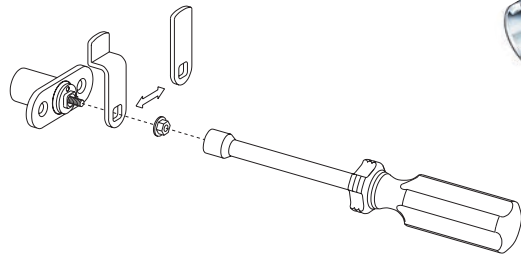
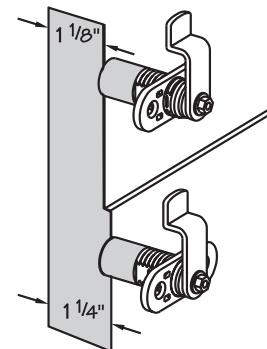
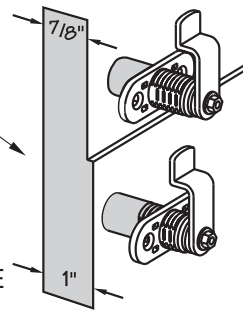

THE 'THICK PANEL LOCK' COMES PACKAGED WITH 2 DIFFERENT CAMS WHICH CAN BE ASSEMBLED TO THE LOCK IN ANY OF THE 3 ORIENTATIONS ILLUSTRATED TO THE RIGHT. THIS OFFERS SUFFICIENT FLEXIBILITY TO ADAPT TO MOST LOCKING SITUATIONS.

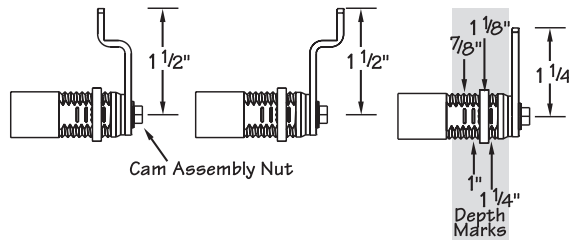

DOUBLE DOOR LATCH

 Watch the Double Door Latch video at comp.com/ddl

Patented.



EASY TO INSTALL AND CAN WORK WITH ANY STYLE OF CABINET LOCK

NOTE: DEPENDING ON SIZE OF CABINET, TWO LATCHES (ONE AT TOP AND ONE AT BOTTOM) MIGHT BE REQUIRED

Lock Placement	Top Mount Kit	Bottom Mount Kit
Lock on Right Door	DL-200 Black Finish	DL-300 Black Finish
	DL-200-W White Finish	DL-300-W White Finish
Lock on Left Door	DL-300 Black Finish	DL-200 Black Finish
	DL-300-W White Finish	DL-200-W White Finish

Application – Allows two or three point locking for standard or wardrobe double door cabinets.

Operation – Secures doors with deadbolt or cam locks. Either door can be closed at anytime.

Finish – Black (shown) or White.

Packaging – Kits include parts below and mounting instructions.

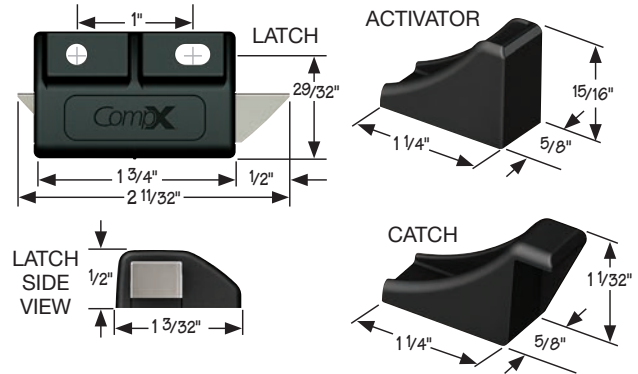

CATCH ON THE SECOND DOOR ACTS AS A SLAM LATCH AND DOES NOT REQUIRE REACHING INTO THE CABINET TO RELEASE

SIGNIFICANT ENGAGEMENT BETWEEN THE CATCH AND LATCH INCREASES SECURITY

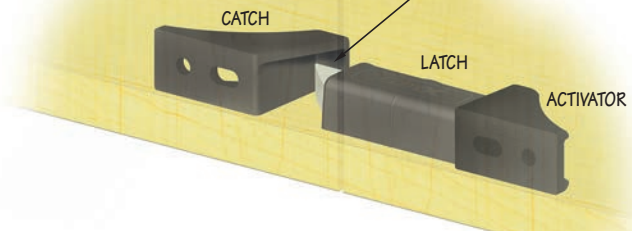

SYSTEM 260 WARDROBE LOCK

CB-260
3/4" MATERIAL

CB-260-1
1" MATERIAL

VERTICAL
MOUNT

FOR
HORIZONTAL
MOUNTING USE
CB-265 TYPE 265
CYLINDER BODY



- FULL 1/2" WARDROBE BAR THROW
- 16.5 MM LOCK HOLE ONLY MACHINING REQUIRED

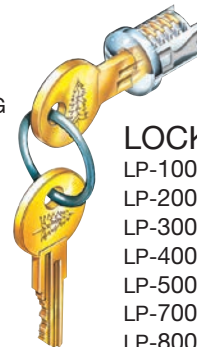

LOCK PLUGS

- LP-100 Nickel
- LP-200 Old English
- LP-300 Black
- LP-400 Statuary Bronze
- LP-500 Brass
- LP-700 Satin Nickel
- LP-800 White

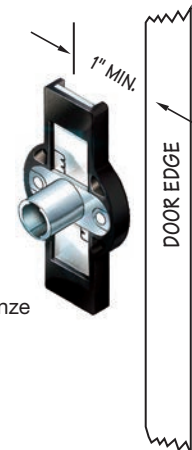

GLASS DOOR LOCK BORE THROUGH STYLE

- FOR SWING STYLE DOORS
- MOUNTS IN GLASS DOORS UP TO 3/8" THICK

TYPE 300 SERIES
HORIZONTAL MOUNT

TYPE 310 SERIES
VERTICAL MOUNT



GLASS DOOR LOCK COMPRESSION MOUNT STYLE

- NON-BORE GLASS DOOR LOCKS
- FULLY CUSHIONED TO AVOID GLASS DAMAGE
- MOUNTS ON GLASS DOORS 1/4" TO 5/16" THICK

TYPE 350 SERIES
HORIZONTAL MOUNT

TYPE 360 SERIES
VERTICAL MOUNT



CAM MUST ROTATE COUNTER-CLOCKWISE TO LOCK

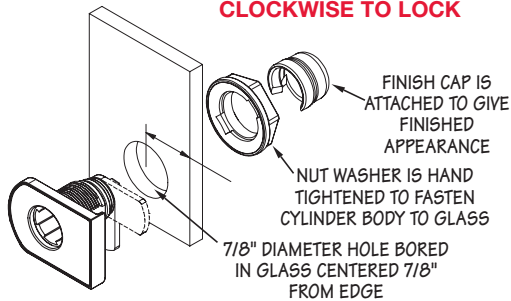

LOCK PLUGS

- LP-100 Nickel
- LP-500 Brass
- LP-700 Satin Nickel

LOCK SLIPS ONTO EDGE OF GLASS DOOR AT ANY LOCATION
NO BORING REQUIRED

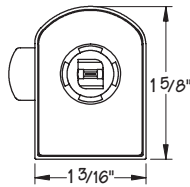
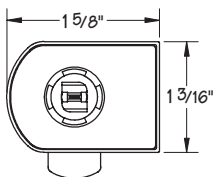
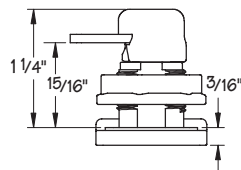
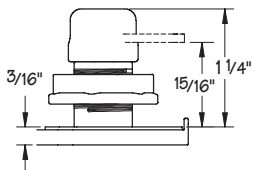
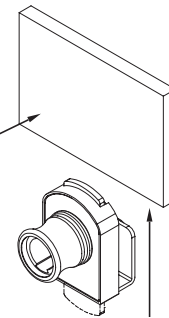

HORIZONTAL MOUNT

PART NUMBER	FINISH
CB-301	NICKEL
CB-305	BRASS
CB-307	SATIN NICKEL

VERTICAL MOUNT

PART NUMBER	FINISH
CB-311	NICKEL
CB-315	BRASS
CB-317	SATIN NICKEL

HORIZONTAL MOUNT

PART NUMBER	FINISH
CB-351	NICKEL
CB-355	BRASS
CB-357	SATIN NICKEL

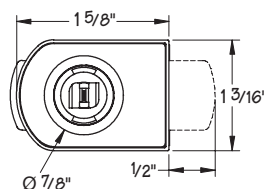
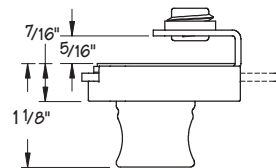

VERTICAL MOUNT

PART NUMBER	FINISH
CB-361	NICKEL
CB-365	BRASS
CB-367	SATIN NICKEL

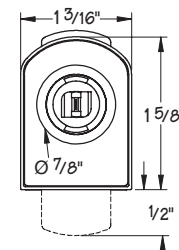
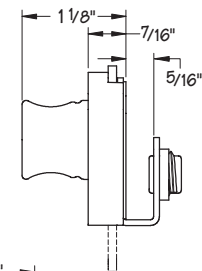

GLASS DOOR LOCK DOUBLE DOOR STYLE

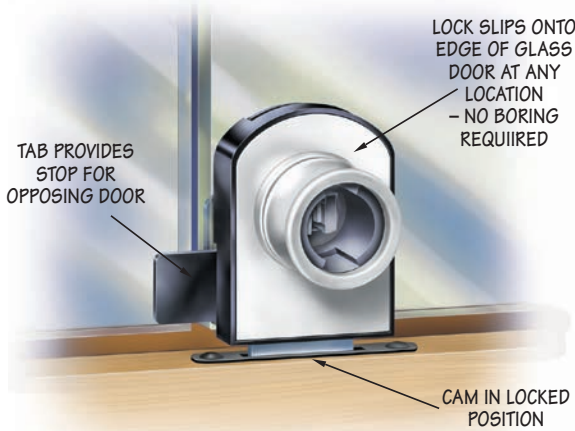

TYPE 370 SERIES VERTICAL COMPRESSION MOUNT

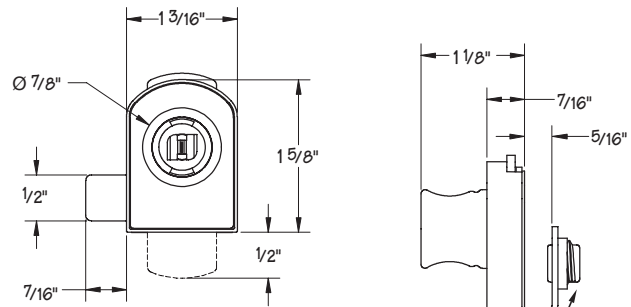

PART NUMBER	FINISH
CB-371	NICKEL
CB-375	BRASS
CB-377	SATIN NICKEL

SET SCREW TIGHTENS LOCK TO GLASS DOOR

SLIDING GLASS DOOR LOCK

- For glass 1/4" and thinner
- TA series master keyed
- Key codes 100TA - 129TA, others available upon request
- Finish bright nickel

Plastisol coating and felt pad eliminate rattling on glass doors

NEW!

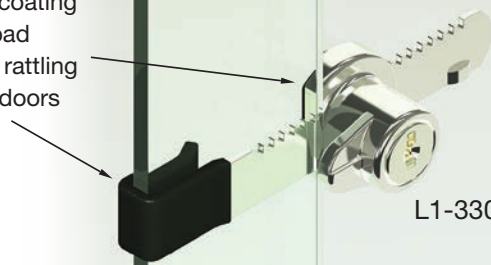

L1-330

LOCK PLUG NOT REMOVABLE

ACCESSORIES

ALLOWS CYLINDER BODIES TO BE USED WITH 3/4" THROUGH 7/8" DIAMETER HOLES AND PERMITS USE OF LOCKS IN 7/8" THICK PANELS



- BZ-100 - Bezel Nickel
- BZ-200 - Bezel Old English
- BZ-300 - Bezel Black
- BZ-400 - Bezel Statuary Bronze
- BZ-500 - Bezel Brass
- BZ-700 - Bezel Satin Nickel
- BZ-800 - Bezel White



NEW!

LP-TK-03 THUMB KNOB

- FOR USE WITH ALL COMPX TIMBERLINE CYLINDER BODIES
- WORKS AS A GENERAL THUMB LATCH WHEN KEYED LOCK PLUGS ARE NOT REQUIRED, AS A SHIPPING PLUG OR AS AN INSERT FOR TESTING LOCKS DURING MANUFACTURING



KY-500 CHANGE TOOL

REQUIRED TO REMOVE LOCK PLUGS IN CYLINDER BODIES

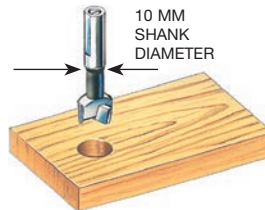

DB-165
16.5MM DRILL BIT

DRILLS THE PROPER DIAMETER HOLE FOR MOST CYLINDER BODIES



CC-100
CYLINDER FINISH CAP

COVERS CYLINDER BODY DURING FINISHING BEFORE LOCK PLUGS ARE INSTALLED



SP-300
SPACER FOR 5/8" PANEL

ALLOWS CAM LOCK CYLINDER BODIES FOR 3/4" MATERIAL TO BE USED IN 5/8" THICK PANELS



STRIKE PLATES

SP-500

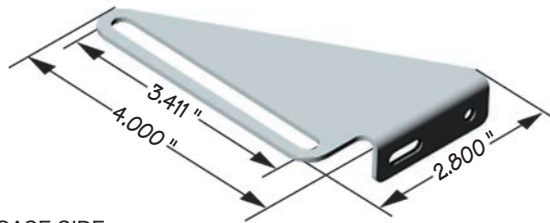

SCREWS TO CASE SIDE.
USE WHEN NO STRINGER AVAILABLE.

**Need a strike plate
for another lock?**

*CompX Timberline strike
plates can be used for any
CompX brand!*

STRIKE PLATES – NICKEL

SP-185-1

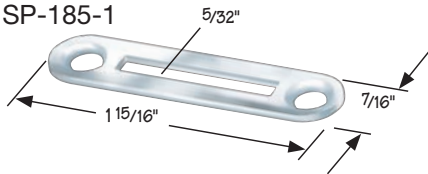

SP-181-1

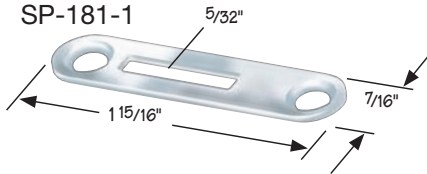

SP-100-1

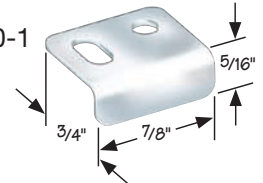

SP-250-1

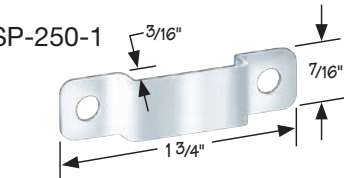

SP-251-1

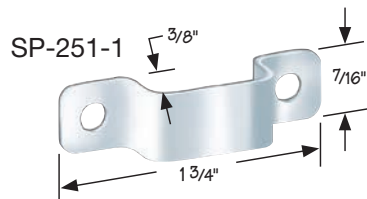

SP-101-1

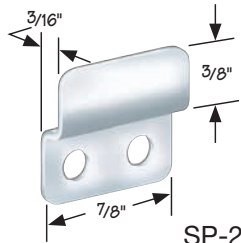
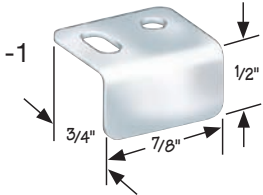

SP-255-1

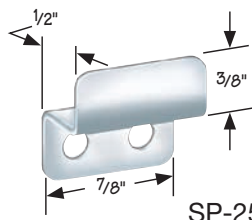

SP-256-1

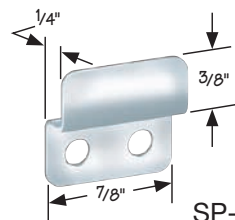

SP-257-1

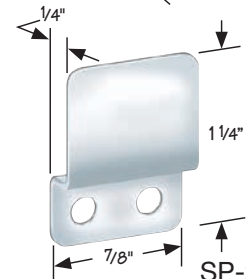

SP-258-1

STRIKE PLATES – BLACK

SP-185-3

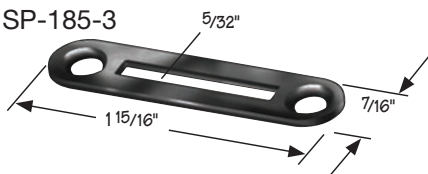

SP-181-3

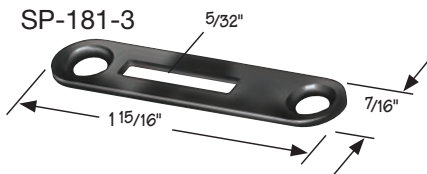

SP-100-3

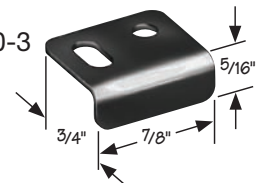

SP-250-3

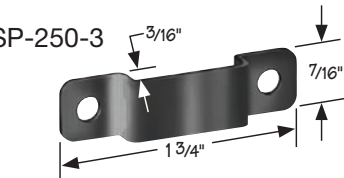

SP-251-3

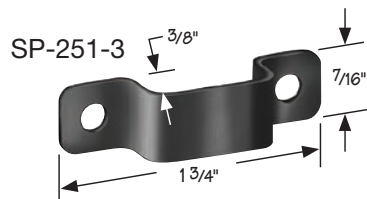

SP-101-3

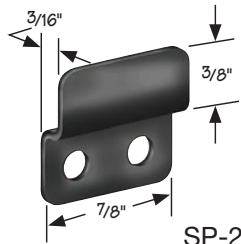
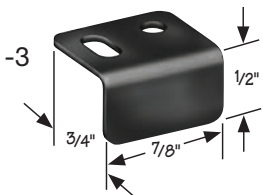

SP-255-3

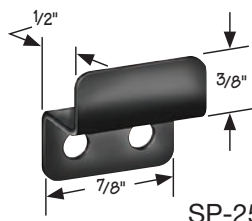

SP-256-3

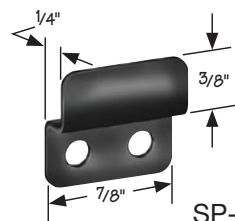

SP-257-3

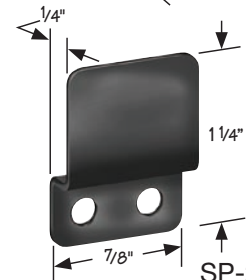

SP-258-3

StealthLock))) - Keyless, Invisible Electronic Cabinet Lock

stealthlock.com

StealthLock works via radio frequency which allows wireless locking of multiple cabinet openings.

The **Transmitter Pad** broadcasts the code entered to lock or unlock the cabinet door or drawer.



The Transmitter Pad can mount anywhere within 15 feet of the Receiver Latch without wires.

StealthLock is recommended for use on cabinets made from:

- Wood and wood products
- Phenolic Resin
- Glass

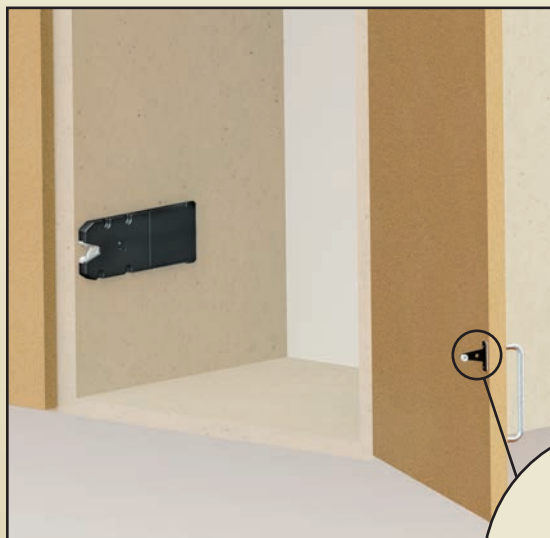

The **Strike Plate** is mounted on the door or drawer to be locked and interfaces with the Receiver Latch.



The **Receiver Latch** mounts inside the cabinet, hidden from view and receives lock or unlock instruction from the Transmitter Pad.



COMPONENTS

TP-100 – Transmitter Pad

- Operates with CR2032 coin battery, included
- Low battery indicator

Available in two versions:

Standard – Use for most residential and general commercial applications

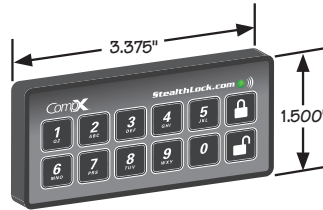

Dedicated – Use part number TP-150, special factory order, unique Transmitter Pad ID mates a Transmitter Pad to specific Receiver Latches. Ideal for lockers or users within close proximity of each other.

RL-100 – Receiver Latch

- Programmable using Transmitter Pad
- One required per door or drawer
- Mounts within 1/2" drawer suspension
- Operates with 4 AAA batteries

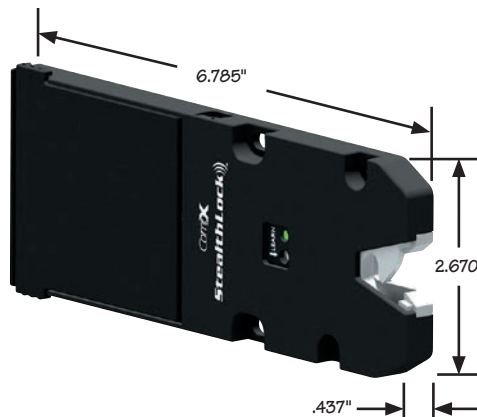

SP-600 – Strike Plate

- For door and drawer use
- Fits within 1/2" drawer suspension

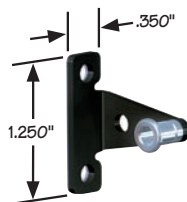

TL-600 – Installation Tool

- Use to mount Receiver Latch and Strike Plate
- Included with the SL-100 and RL-110 kits

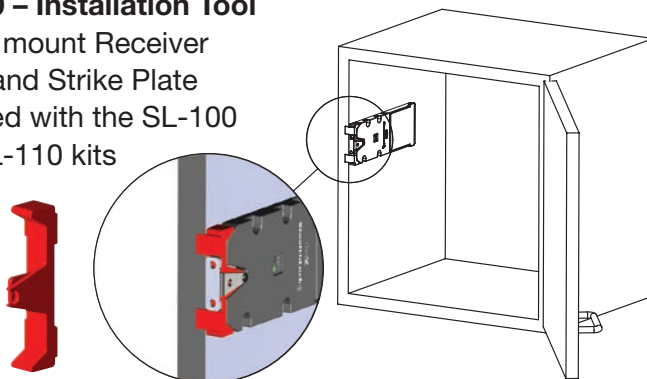

KITS

Standard version

SL-100 – StealthLock Kit

- Contains all parts necessary to lock one door or drawer
- Kit includes:
 - ♦ RL-100 – Receiver Latch
 - ♦ TP-100 – Transmitter Pad
 - ♦ SP-600 – Strike Plate
 - ♦ TL-600 – Installation Tool
 - ♦ required mounting screws

RL-110 – Receiver Latch Kit

- Contains all parts necessary to lock additional doors or drawers operated by existing Transmitter Pad
- Kit includes:
 - ♦ RL-100 – Receiver Latch
 - ♦ SP-600 – Strike Plate
 - ♦ TL-600 – Installation Tool
 - ♦ required mounting screws

Dedicated version

SL-150 Dedicated Preprogrammed Kits

For medium to large projects

Transmitter pads and receiver latches can be programmed at the factory to a customer-provided schedule. They are then ready for installation. If needed, StealthLock's modes (passage, self-locking and single use) can be reprogrammed after installation.

To download the *SL-150 Preprogrammed Kit: How to Order* sheet, go to **stealthlock.com** or contact us for more information.

StealthLock))) - Keyless, Invisible Electronic Cabinet Lock

ACCESSORIES

stealthlock.com

MP-700 Satin Nickel (shown)
MP-300 Black
Mounting Plates

- Mounting screws and template included

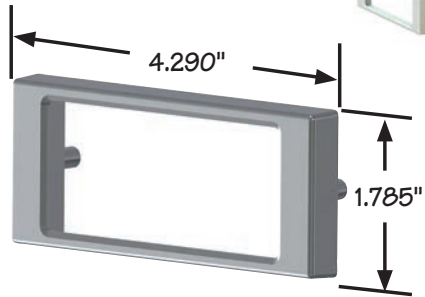

Mounting screws fit material 5/8" - 7/8" thick



MP-700-WM Satin Nickel (shown)
MP-300-WM Black
Wall-Mounting Plates

Allows mounting plate to be affixed to wall or other surfaces where rear access is unavailable.

AUXILIARY POWER SYSTEM

RL-AP1 - Power Supply

- Connects Receiver Latch to 120 VAC power
- Includes 5-1/2 foot cord



RL-APC-9VJ-10 - Power Cord - 9V Jump

- Provides emergency power to Receiver Latch using a 9 volt battery
- 10 foot cord length

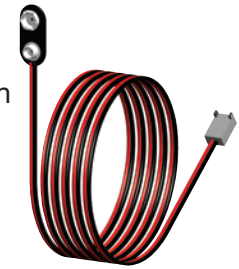

RL-APC - Power Cord

- Use to daisy chain Receiver Latches

Available lengths

- RL-APC-3 Power Cord - 3 ft.
- RL-APC-5 Power Cord - 5 ft.
- RL-APC-10 Power Cord - 10 ft.

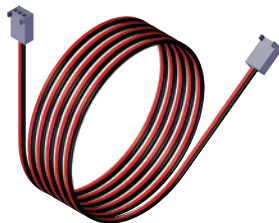

RL-AP1 and RL-APC-9VJ-10 can power up to 10 Receiver Latches using the RL-APC Power Cords.

Visit stealthlock.com for programming and installation videos, frequently asked questions and more.



FILE FRAME SYSTEMS

DESK FILE DRAWERS

FILE DRAWER

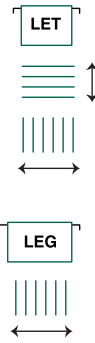

WIDE FILE DRAWER

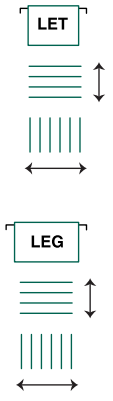

LATERAL FILE DRAWERS

LATERAL FILE DRAWER



LATERAL FILE DRAWER WITH SIDE TO SIDE FILING

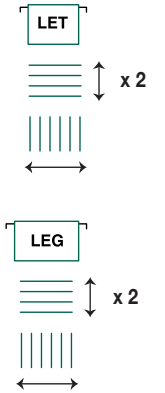

DEEP FILE DRAWERS

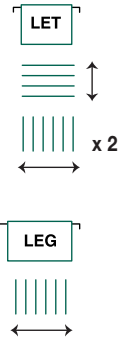

PLAIN DRAWER SYSTEMS

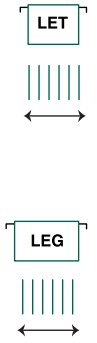

METAL DRAWER SYSTEMS

LETTER WIDTH FILES

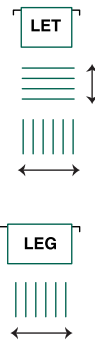

LEGAL WIDTH FILES

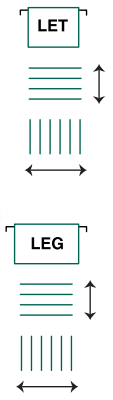
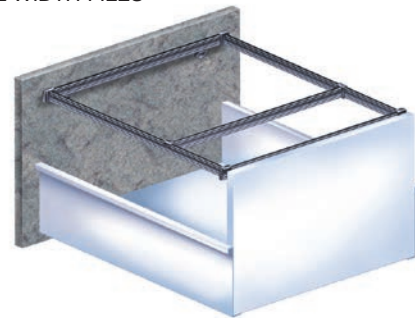

FILING ACCOMMODATIONS BASED ON TYPICAL DRAWER SIZE - ACTUAL FILING CAPABILITIES WILL VARY



FILE FRAME CUT TO SIZE KITS

Available in black or white finish!

Step 1: Determine kit needed

INSIDE WIDTH BETWEEN 12" AND 15"

letter kit

- Front and back rail; FF-1FL-13.153; 2 per kit
- Cut to size bracket; FF-R25; 2 per kit
- Cut to size cross rail; FF-SKA-25.000; 2 per kit
- Side-to-side rail; FF-LET; 1 per kit

INSIDE WIDTH GREATER THAN 15"

legal kit

- Front and back rail; FF-1FL-16.153; 2 per kit
- Cut to size bracket; FF-R25; 2 per kit
- Cut to size cross rail; FF-SKA-25.000; 2 per kit
- Side-to-side rail; FF-LEG; 1 per kit

Step 2: Attach fixed rail

TOP OF RAIL SHOULD BE 9.5" MINIMUM ABOVE BOTTOM OF DRAWER

Step 3: Size, cut & install rails

CUT TO SIZE BRACKET AT REAR

Step 4: Install side-to-side rail

PRE-POSITIONED HOLES IN FRONT-TO-BACK RAILS

ALLOW FOR LETTER OR LEGAL SIDE-TO-SIDE FILING

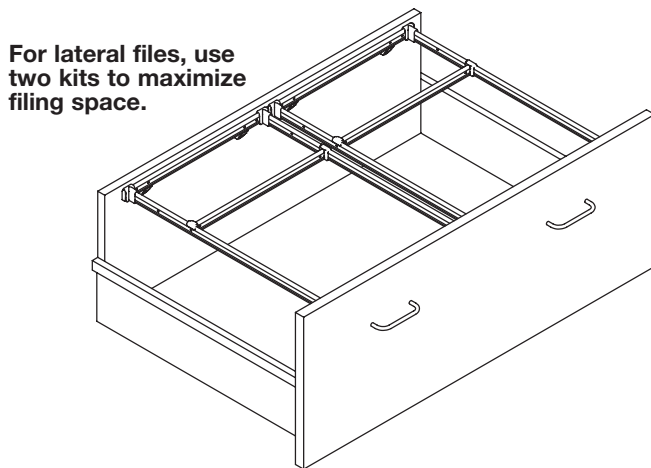

File Frame part numbers		
Finish color	Drawer width: Letter	Drawer width: Legal
Black	FF-SK2	FF-SK3
White	FF-SK2-W	FF-SK3-W

KITS CONTAIN ALL COMPONENTS NEEDED TO FILE FRONT-TO-BACK OR SIDE-TO-SIDE IN PROPERLY SIZED DRAWERS. FILE FRAME KITS CAN BE USED IN EITHER FULL WOOD DRAWERS OR METAL DRAWER BOX SYSTEMS.



FILE FRAME SYSTEM ADVANTAGES

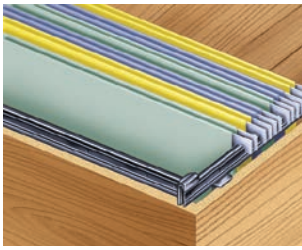

Typical file frame corner

Great Appearance... Functional Design

- Attractive, black or white material
- Files slide smoothly
 - Will not slide out of position when using files
 - Will not pull out when removing files
- Easy to adjust between filing configurations
 - Rails snap in and out of position without tools



Proven durable during load testing

Proven Design and Durability

- Easily supports twice the fully loaded weight of paper
- Weight is supported by the top of the drawer, not screws
- Withstands 50,000 back and forth cycles without paint wear or other degradation

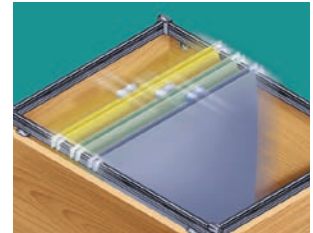

Fits easily into place and slides smoothly to desired lock-in filing configuration

Cost Effective, Easy to Install, and Reliability of Supply

- Easy to install using only screws
- No machining required
- No need to tape frame system in place during shipping
- Easy to purchase directly from manufacturer
- One week typical lead time



File frame generally ships within one week

FILE FRAME FACTS

LETTER FILES

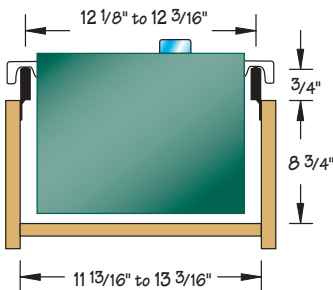

FILE FRAME SYSTEM CAN PROVIDE PERFECT LETTER FILING WITHIN THESE DIMENSIONS

LEGAL FILES

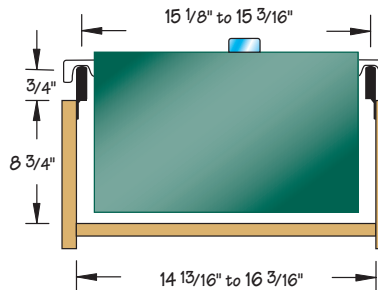

FILE FRAME SYSTEM CAN PROVIDE PERFECT LEGAL FILING WITHIN THESE DIMENSIONS

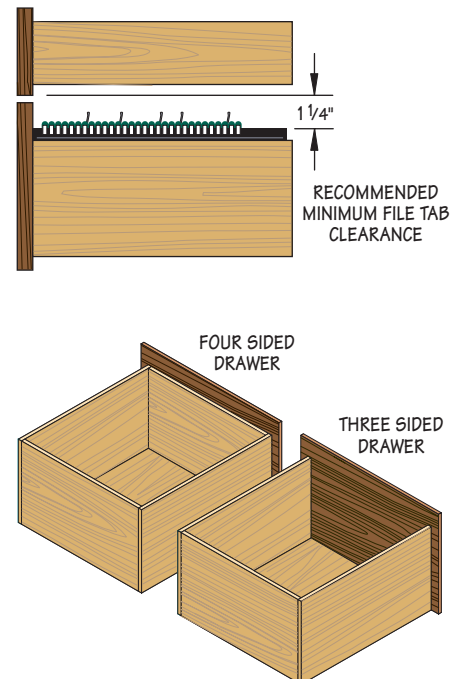

CompX[®]

TIMBERLINE

715 Center Street
Grayslake, IL 60030
1-800-LOCKBAR
PH: 1-847-752-2600 FAX: 1-847-752-2420
email: timberlineorders@compX.com
compX.com

CompX[®]

SECURITY PRODUCTS



The products contained in this catalog are protected by the following patents:
1,331,036; 6,109,708; 6,550,874; 7,665,812; 8,516,864; 9,388,613.

© 2016 CompX Timberline

Catalog #0816