

LOCTITE®

“Do It Right” User’s Guide

The “When, Where & How” to Use LOCTITE®
Automotive Maintenance Products

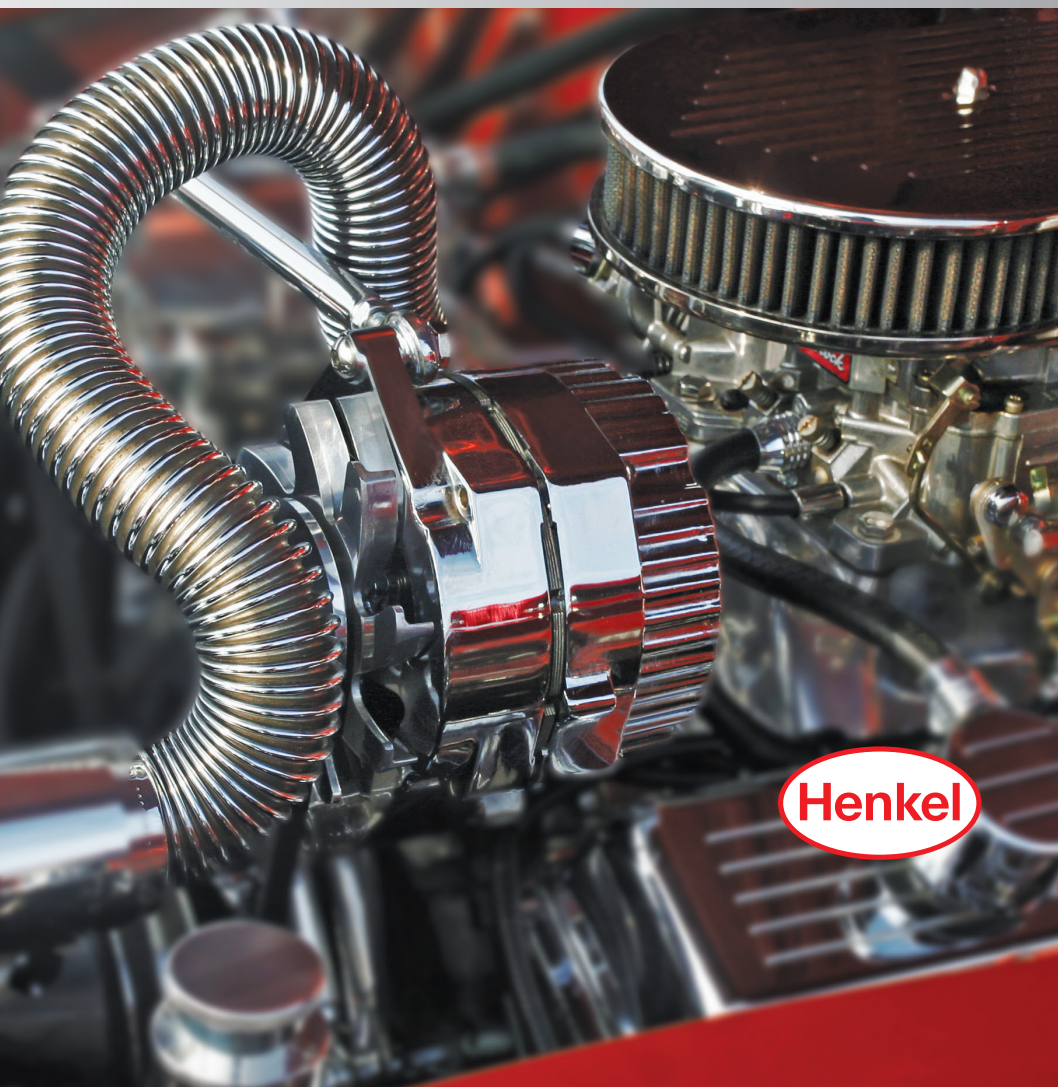

Henkel

CONTENTS

The primary function of this User's Guide is to help you, the automotive professional, with the proper selection and use of LOCTITE® products. A wide variety of preventative maintenance, as well as repair techniques, are explained in step-by-step detail. Consider this a supplemental service manual for every vehicle in your shop. Our goal is to make it easier for you to use our products, to your benefit, for faster repair times, reduced downtime and extended vehicle life.

Additional information on these products, as well as others, is available by contacting us at **1.855.436.5359** or **1.800.263.5043** in Canada.



CONTENTS		PAGE
INTRODUCTION	Introduction to Anaerobic Adhesives and Sealants	4
	Why Use a Primer?	4
THREADLOCKING	Thru Holes (Bolts and Nuts)	5
	Blind Holes (Cap Screws, etc.)	5
	Blind Holes (Studs, etc.)	6
	Adjustment Screws	6
	Pre-Assembled Fasteners	7
	LOCTITE® Threadlocker Quick Selector	7
THREAD REPAIR	Stripped Thread Repair	8
	Standard Fittings – Pipes, Hydraulic or Air	9
	Pipe Unions	9
	Compression Fittings	10
	Flared/Swaged Fittings	10
	Hose Ends – Air & Hydraulic	11
	LOCTITE® Thread Sealant Quick Selector	11
POROSITY SEALING	Existing Weld Porosities and Castings	12
FORM-IN-PLACE	Sealing Cast Rigid Flanges	13
GASKETING	LOCTITE® Gasketing Quick Selector	13
GASKET DRESSING	Sealed Flanges	14
FORM-IN-PLACE	Stamped or Sheet Metal Flanges	15
SILICONES		
STRENGTHEN KEYED ASSEMBLIES	Standard Duty	16
	Heavy Duty	17
	Repairing Badly Wallowed Keyway	18
SHAFT MOUNTED ASSEMBLIES	Repairing Badly Worn Shaft	19
	Slip Fit – Light/Heavy Duty	20
	Press Fit	21
	Shrink Fit	22
HOUSED COMPONENTS	Slip Fit	23
	Sealing/Retaining – Metallic Seal	24
	LOCTITE® Retaining Compound Quick Selector	25
DISASSEMBLY	LOCTITE® Threadlocking, Thread Sealing and Retaining	26
	Gasketing	26
	Optimum Use of LOCTITE® Extend® Rust Treatment	27
TROUBLESHOOTING	Checklist	28
ORDERING	Product Listing/Order Information	29

INTRODUCTION

INTRODUCTION TO ANAEROBIC ADHESIVES AND SEALANTS

Anaerobic adhesives and sealants were developed by the founder of the Loctite Corporation, now the Henkel Corporation, in 1953 and, since then, they have significantly evolved to meet the highest requirements of vehicle manufacturers and vehicle maintenance and repair.

Anaerobic adhesives and sealants are resins that convert from liquid to a tough structural solid in the absence of air and the presence of metal.

The primary functions of anaerobic resins are:

Threadlocking

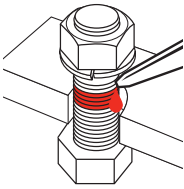

Thread Sealing

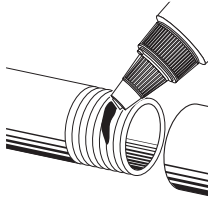

Gasketing

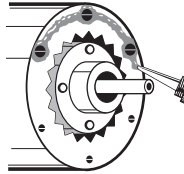

Retaining

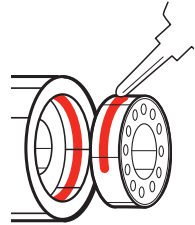

Each one of these functions is based upon control of five major variables: strength, viscosity, adhesion, flexibility and temperature resistance. These five parameters give anaerobic users considerable latitude in adjusting properties for optimum performance in specific application areas.

Another variable that should be considered is the surface on which the adhesive will be applied. For certain surfaces or other special requirements, the use of a primer is recommended.

WHY USE A PRIMER?

1. Primers activate inactive surfaces.
2. Primers speed cure times for faster return to service.
3. Primers speed curing through larger gaps and deep threads.
4. Primers substantially speed cure times on cold parts.
5. Primers act as cleaning agents.

Active surfaces (Primer optional): Brass, copper, bronze, iron, soft steel, nickel.

Inactive surfaces (Primer required): Aluminum, stainless steel, magnesium, zinc, black oxide, cadmium, titanium, others.

THREADLOCKING

THRU HOLES (BOLTS AND NUTS)

LIQUID, SEMI-SOLIDS AND DRY-TO-TOUCH TAPE

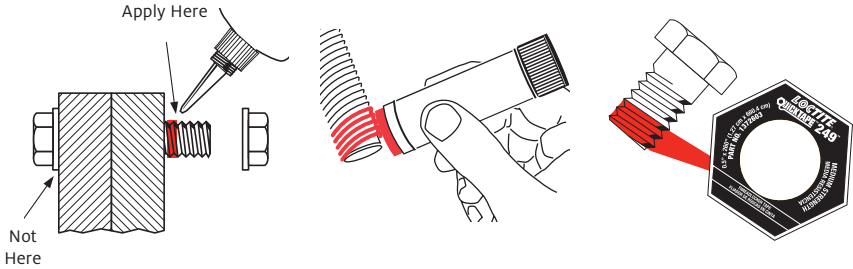

1. Clean all threads (bolt and nut) with a cleaner.
2. If necessary, spray all threads with LOCTITE® Primer. Allow to dry.
3. Select the proper strength LOCTITE® threadlocker.
4. Insert bolt into thru hole assembly.
5. Apply several drops of liquid threadlocker onto bolt at targeted, tightened nut engagement area or, when using the stick product, completely fill the root of the threads at the area of engagement.
6. Assemble and tighten nut as usual.

BLIND HOLES (CAP SCREWS, ETC.)

LIQUID ONLY

1. Clean all threads (bolt and hole) with a cleaner.
2. If necessary, spray (bolt and hole) with LOCTITE® Primer. Allow 30 to 70 seconds to dry.
3. Select the proper strength LOCTITE® threadlocker.
4. Squirt several drops down the sides of the female threads.
5. Apply several drops to bolt.
6. Tighten as usual.

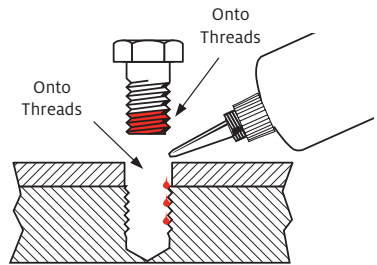

NOTE: Using LOCTITE® threadlockers will virtually eliminate stripped threads, in aluminum or magnesium housings, caused by galvanic corrosion.

THREADLOCKING

BLIND HOLES (STUDS, ETC.)

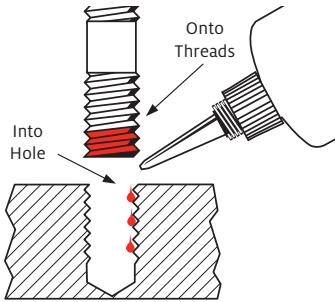

LIQUID ONLY

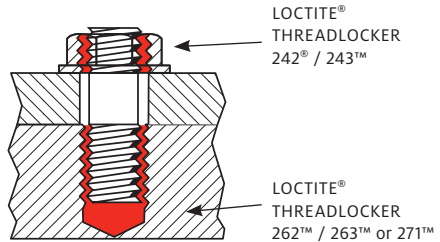

1. Clean all threads (bolt and hole) with a cleaner.
2. If necessary, spray all threads with LOCTITE® Primer. Allow to dry.
3. Squirt several drops of LOCTITE® Threadlocker 262™ / 263™ or 271™ down the sides of the female threads.

NOTE: Use LOCTITE® Threadlocker 277™ if stud is over 1" diameter.

4. Apply several drops of LOCTITE® Threadlocker 262™ / 263™ or 271™ onto stud threads.
5. Install studs.
6. Position cover, head, etc.
7. Apply drops of LOCTITE® Threadlocker 242® / 243™ onto exposed threads.
8. Tighten nuts as required.*

*243™ may be used in place of 242® and 263™ may be used in place of 262™. Their primerless formulations eliminate the need for LOCTITE® Primer in most applications.

ADJUSTMENT SCREWS

1. Adjust screw to proper setting.
2. Apply several drops of LOCTITE® Threadlocker 290™ at screw and body juncture.
3. Avoid touching bottle tip to metal.

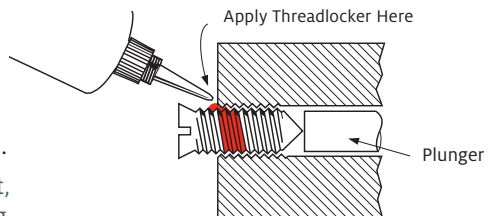

NOTE: If re-adjustment is difficult, apply heat to screw with soldering gun (500°F).

PRE-ASSEMBLED FASTENERS

LIQUID ONLY

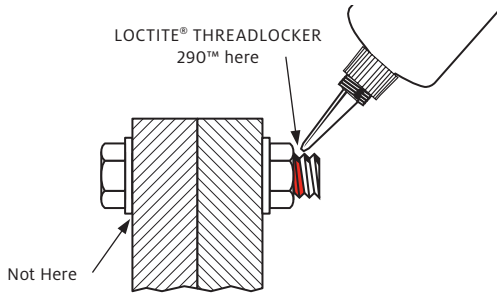

1. Clean bolts and nuts with a cleaner.
2. Assemble components.
3. Tighten nuts.
4. Apply several drops of LOCTITE® Threadlocker 290™ at the nut and bolt juncture.
5. Avoid touching bottle tip to metal.

NOTE: For preventive maintenance on existing equipment: RETIGHTEN nuts and apply LOCTITE® Threadlocker 290™ at the nut and bolt juncture.

LOCTITE® THREADLOCKER QUICK SELECTOR

USE	STRENGTH	LOCTITE® PRODUCT	COLOR
Small Screws	Low	222™	Purple
Nuts & Bolts	Medium	242® / 243™ / Blue Threadlocker Stick	Blue
Pre-Assembled*	Medium	290™	Green
Overhead	Medium	249™ Tape or Stick	Blue
Pre-Applied up to 30 days	Medium	249™ Tape	Blue
Nuts & Bolts	High	262™ / 263™ / Red Threadlocker Stick	Red
Studs (up to 1½")	High	271™	Red
Studs (up to 1")	High	272™	Red
Studs (over 1")	High	277™	Red

* Wicking Grade

THREAD REPAIR

STRIPPED THREAD REPAIR

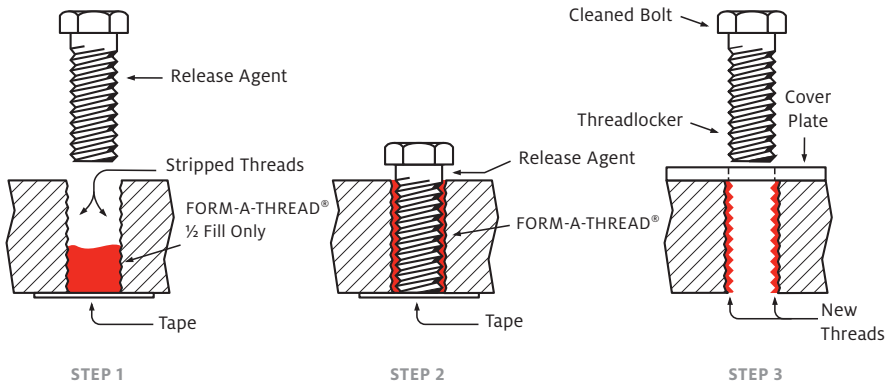

STANDARD THREAD REPAIR

1. Follow instructions on LOCTITE® FORM-A-THREAD® package.
2. If cover plate is used for bolt alignment:
 - (a) Apply release agent to mating faces around repair area.
 - (b) Use “waxed” paper or similar film between faces.
3. A “jiggling/twisting” motion, when initially inserting bolt improves the thread conformation.

NOTE: NOT intended for engine stud repair.

SMALL HOLE/FINE THREAD REPAIR

- OPTION 1.** Drill out damaged hole to oversize, then follow STANDARD THREAD REPAIR.
- OPTION 2.** Apply LOCTITE® FORM-A-THREAD® to screw and insert into damaged hole. Clamp in place, while product cures.

STUD INSTALLATION — PERMANENT (LIGHT DUTY)

1. Use stud or cut “all threads” to desired length.
2. Do NOT apply release agent to stud.
3. Proceed as with standard thread repair.
4. Allow 30 minutes to cure.
5. Assemble as required.

THREAD SEALING

STANDARD FITTINGS – PIPES, HYDRAULIC OR AIR

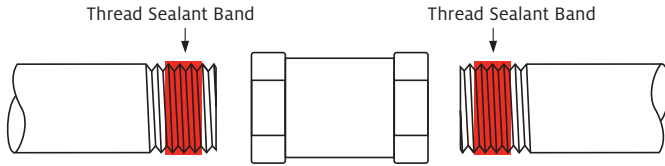

1. Clean parts of contamination. If necessary, spray LOCTITE® Primer™ onto threaded parts (male and female). Allow to dry.

Note: Primer is not required for brass parts.

2. Apply a band of LOCTITE® Thread Sealant 592™ or 565™ to male threads starting one to two threads from end of pipe.
3. Assemble parts snugly. Do not overtighten.
4. If initial pressure exceeds 1000 psi*, wait 30 minutes before pressurizing.

- NOTE:**
- For stainless steel components, use LOCTITE® Thread Sealant 565™.
 - For general purpose thread sealing, use LOCTITE® Thread Sealant 565™ or LOCTITE® Pipe Sealant Stick.
 - For fine filtration systems requiring zero contamination, use LOCTITE® Thread Sealant 545™ for hydraulic/pneumatic fittings.
 - Do not use on oxygen or strong oxidizers (chlorine).
 - For applications requiring temperature range above 300°F (no higher than 400°F), use LOCTITE® Thread Sealant 592®.

* Depending on conditions

PIPE UNIONS

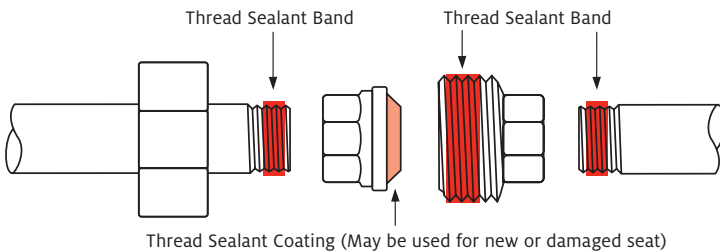

1. Disassemble and, if necessary, spray all components with LOCTITE® Primer. Allow to dry.
2. Apply a thin coating of LOCTITE® Thread Sealant to union face.
3. Apply a band of LOCTITE® Thread Sealant to male threads.
4. Assemble parts snugly.

THREAD SEALING

COMPRESSION FITTINGS

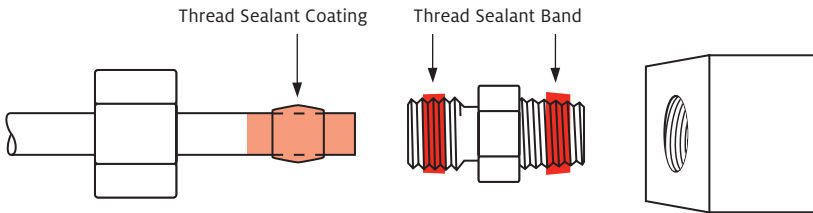

1. Slide fitting nut and ferrule back approximately $\frac{3}{4}$ " from end of tubing.
2. If necessary, spray the entire assembly with LOCTITE® Primer. Allow to dry.
NOTE: Primer is not required for brass parts.
3. Apply a thin coating of LOCTITE® Thread Sealant to tubing, where ferrule will be located.
4. Slide ferrule forward over LOCTITE® Thread Sealant coated tubing, then apply a thin bead of LOCTITE® Thread Sealant coating to ferrule.
5. Slide ferrule forward over LOCTITE® Thread Sealant coated tubing.
6. Apply a small band of LOCTITE® Thread Sealant to male threads.
7. Assemble and tighten normally.
NOTE: Do not use on plastic fittings or tubing.

FLARED/SWAGED FITTINGS

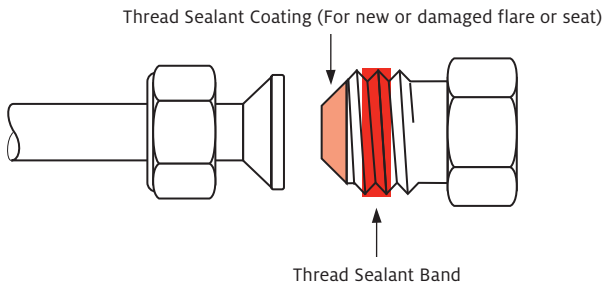

1. Disassemble and, if necessary, spray all components with LOCTITE® Primer. Allow to dry.
2. Apply a thin coating of LOCTITE® Thread Sealant to fitting face.
3. Apply a band of LOCTITE® Thread Sealant to male threads.
4. Assemble parts snugly.

THREAD SEALING

HOSE ENDS – AIR & HYDRAULIC

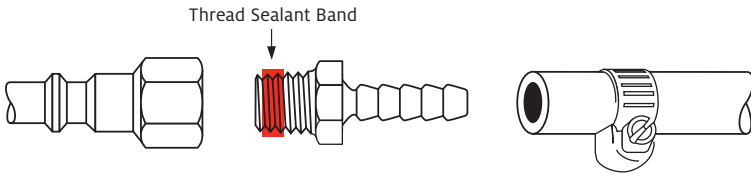

1. If necessary, spray adapter threads with LOCTITE® Primer. Allow to dry.
2. Insert barbed hose stem into hose inner diameter (I.D.), with slight twisting motion.
3. Install appropriate hose clamp.
4. Apply a band of LOCTITE® Thread Sealant to male hose stem threads upon installation or when adding the accessory device. Tighten snugly.

NOTE: LOCTITE® Thread Sealant may attack synthetic rubber tubing.

LOCTITE® THREAD SEALANT QUICK SELECTOR (TAPERED THREADS)

APPLICATION	LOCTITE® PRODUCT	PRIMER	INSTANT SEAL	MAX. PRESSURE	STEAM PRESSURE	TEMP. RANGE
Most Metal Fittings	Thread Sealant Stick or Thread Sealant 565™	Yes	500 psi	10,000 psi (24 hours)	n/a	-65°F to 300°F
High Filtration/ Zero Contamination Systems	Thread Sealant 545™ Hydraulic/ Pneumatic	Yes	500 psi (10 min.)	10,000 psi (24 hours)	n/a	-65°F to 300°F
Most Metal Fittings	Thread Sealant 592™ - High Temperature	Yes	500 psi (10 min.)	10,000 psi (24 hours)	n/a	-65°F to 400°F

Do not use these products on oxygen or strong oxidizers.

POROSITY SEALING

EXISTING WELD POROSITIES AND CASTINGS

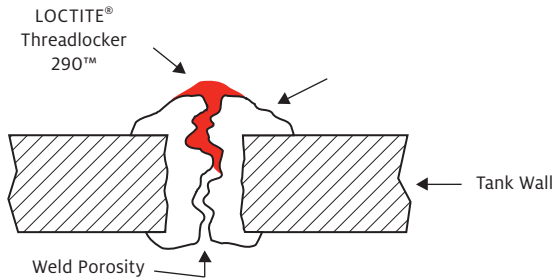

1. **IMPORTANT!** TAKE PROPER SAFETY PRECAUTIONS IF WORKING WITH FLAMMABLE LIQUID TANKS. AVOID USE WITH COMPRESSIBLE GASSES.
2. Wire brush to remove paint, rust, etc. from repair area.
3. Clean repair area with a cleaner.
4. Apply localized heat to bring repair area to approximately 250°F.
5. Allow repair area to cool to approximately 185°F.
6. Brush or spray sealant on repair area.

- NOTE:**
- Steel – Use LOCTITE® Threadlocker 290™ at 185°F.
 - Aluminum/Stainless Steel – Use LOCTITE® Threadlocker 290™ at 120°F.
 - Not recommended for “blowholes”.
 - Maximum porosity sealed – .005”.

7. Allow to cure for 30 minutes (high pressure, above 150 psi — 1 hour).
8. Clean with a cleaner to remove excess sealant. Do not grind.
9. Paint as required.

NOTE: Casting repair uses the same procedure.

SEALING NEW WELDS — PREVENTIVE MAINTENANCE

1. Remove all slag and scale while hot.
2. Apply sealant when weld is 185°F and falling.
3. Follow information above.

FORM-IN-PLACE GASKETING

SEALING CAST RIGID FLANGES

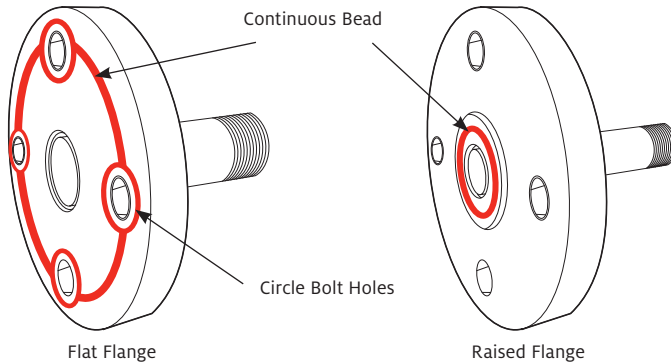

1. Remove old gasketing material and other heavy contaminants. Use mechanical removal technique if required.

NOTE: Avoid grinding.

2. Clean both flanges with a cleaner.
3. Spray LOCTITE® Primer on only one surface. Allow 1-2 minutes to dry.
4. Apply a continuous bead of LOCTITE® Gasket Maker to the other surface.

NOTE: Circle all bolt holes with sealant, if appropriate.

5. Mate Parts. Assemble and tighten as required.

NOTE: Immediate assembly not required; however avoid delays over 45 minutes.

6. Allow to cure:
 - a. No pressure – immediate service
 - b. Low pressure (up to 500 psi) – 30 to 45 minutes
 - c. High pressure (500 to 2500 psi) – 4 hours
 - d. Extreme high pressure (2500 to 5000 psi) – 24 hours

LOCTITE® GASKETING QUICK SELECTOR

USE	LOCTITE® PRODUCT	GAP FILL	TEMP. RANGE
General	Gasket Maker 518™	.050"	-65°F to 300°F
General	Gasket Maker 515™	.050"	-65°F to 300°F

GASKET DRESSING

SEALED FLANGES

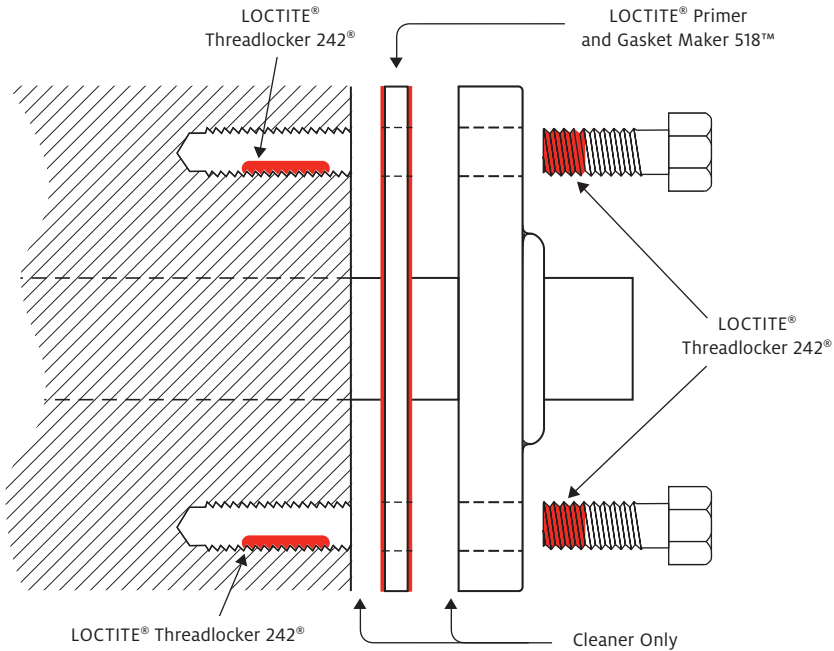

1. Remove old gasketing material and other heavy contaminants. Use mechanical removal technique if required.
NOTE: Avoid grinding.
2. Clean both flanges with a cleaner.
3. Spray LOCTITE® Primer on both flange faces and both sides of the precut gasket. Allow 1 to 2 minutes to dry.
4. Smear LOCTITE® Gasket Maker on both sides of precut gasket with a clean applicator.
5. Place coated gasket on flange surface and assemble parts immediately.
NOTE: • If cover bolts into blind holes (as above), apply LOCTITE® Threadlocker 242® into hole and on threads. Tighten normally.
• If it is a through bolt assembly, apply LOCTITE® Threadlocker 242®.
6. Tighten normally.

FORM-IN-PLACE SILICONES

STAMPED OR SHEET METAL FLANGES

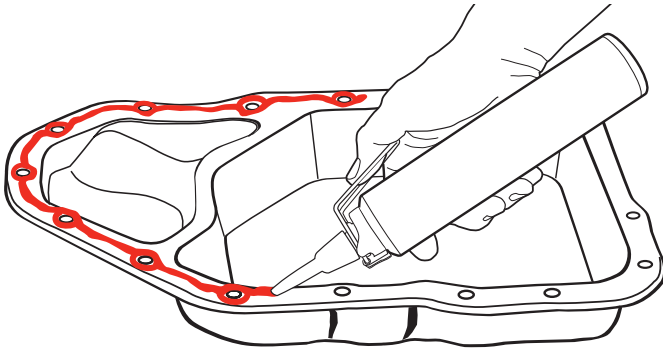

1. Remove old gasketing material and other heavy contaminants.
2. Clean both flanges with a cleaner.
3. Apply a continuous bead of LOCTITE® Ready Gasket or LOCTITE® High Performance silicones to sealing surface. Circle all bolt holes.

NOTE:

- Use proper bead diameter to seal flange width and depth.
- Minimize excessive material “squeeze in.”

4. Assemble within 10 minutes by pressing together. Tighten as required.
5. Clean up any excess or squeeze out.
6. Cure times will vary with temperature, humidity and gap. Typical full cure time is 24 hours.

	LOCTITE® READY GASKET*	LOCTITE® 587™ BLUE
Color	Black	Blue
Viscosity, cP	Paste	Paste
Gap Fill	¼"	¼"
Cure Method	Moisture/Oxime	Moisture/Oxime
Cure Speed		
Tack-Free	30 minutes	30 minutes
Full Cure	24 hours	24 hours
Service Temp. Range		
Intermittent	-75°F to 500°F -59°F to 260°C	-75°F to 500°F -59°F to 260°C

*LOCTITE® Ready Gasket provides a low pressure instant seal (100 psi at zero gap).

STRENGTHEN KEYED ASSEMBLIES

STANDARD DUTY

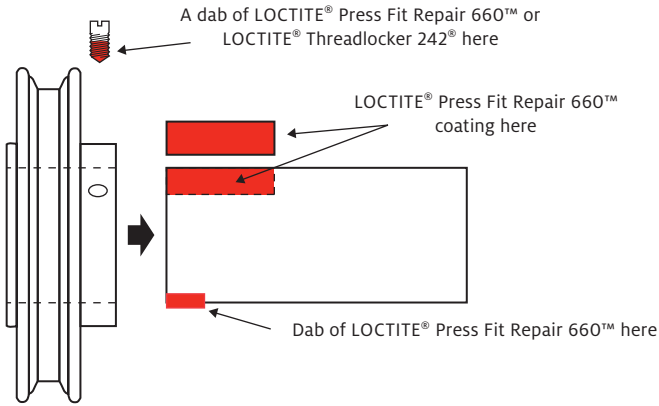

ASSEMBLY

1. Clean all parts with a cleaner.
2. If necessary, spray all parts, inner diameter (I.D.) and outer diameter (O.D.), with LOCTITE® Primer.
3. Apply a coating of LOCTITE® Press Fit Repair 660™ into keyway and on key.
4. Apply dab(s) of LOCTITE® Press Fit Repair 660™ onto shaft opposite keyway or evenly spaced around shaft.
5. Assemble parts. Wipe off excess.
6. Apply a dab of LOCTITE® Press Fit Repair 660™ to set screw.
7. Tighten set screw.
8. Allow 5 to 10 minutes prior to service.

- NOTE:**
- LOCTITE® Press Fit Repair 660™ is NOT recommended for radial gaps exceeding .010" on shaft or keyway.
 - See REPAIRING BADLY WALLOVED KEYWAY on page 18 for procedure.

DISASSEMBLY

1. Tap component and key with hammer.
2. Pull as usual.

STRENGTHEN KEYED ASSEMBLIES

HEAVY DUTY

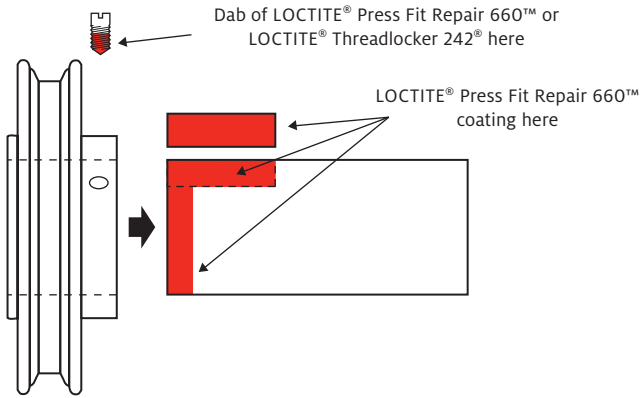

ASSEMBLY

1. Clean all parts with a cleaner.
2. Apply a LOCTITE® Press Fit Repair **660™** coating around shaft, into keyway, and on key.
3. Assemble parts. Wipe off excess.
4. Apply a dab of LOCTITE® Press Fit Repair **660™** to screw.
5. Tighten set screw.
6. Allow 30 minutes prior to service.

- Note:
- If gap exceeds .005", use LOCTITE® Primer™ on appropriate area (shaft or keyway).
 - LOCTITE® Press Fit Repair **660™** is NOT recommended for radial gaps exceeding .010" on shaft or keyway.
 - See REPAIRING BADLY WALLOVED KEYWAY on page 18 for procedure.

DISASSEMBLY

1. Tap component and key with hammer.
2. If necessary, apply localized heat (500°F for five minutes).
3. Pull while hot.

STRENGTHEN KEYED ASSEMBLIES

REPAIRING BADLY WALLOWED KEYWAY

LOCTITE® Press Fit Repair
660™ coated keyway

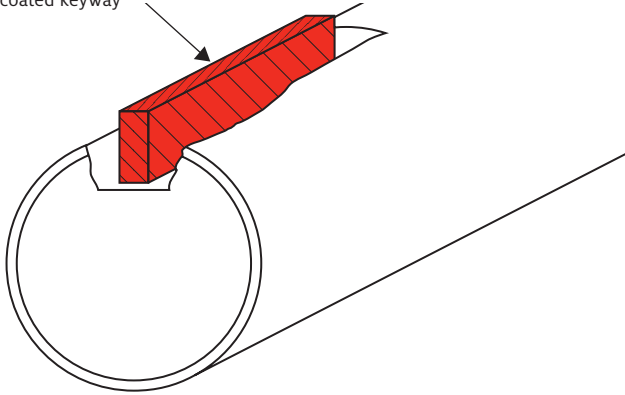

1. Clean all parts with a cleaner.
2. If necessary, spray all parts with LOCTITE® Primer. Allow to dry.
3. Apply a LOCTITE® Press Fit Repair 660™ coating into keyway.
4. Assemble as required using LOCTITE® Press Fit Repair 660™.
5. Allow 30 to 60 minute cure time.

- NOTE:**
- LOCTITE® Press Fit Repair 660™ is NOT recommended for lateral gaps exceeding .010".
 - Higher strengths are obtained by NOT using LOCTITE® Primer with small (.002" to .004") gap, and allowing longer cure (4 to 24 hours).

SHAFT MOUNTED ASSEMBLIES

REPAIRING BADLY WORN SHAFT

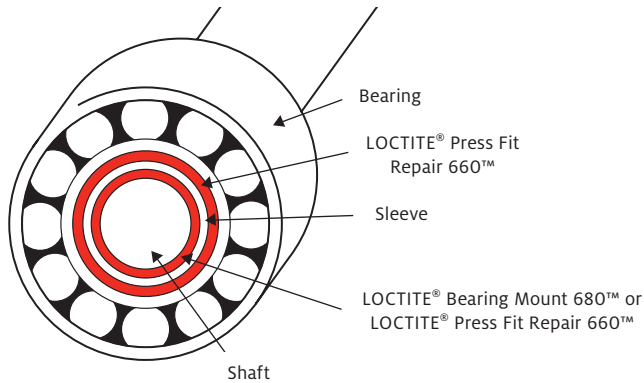

1. Determine a minimum radial gap.
2. Select and trim appropriate sleeve to allow component slip fit.
3. Roughen sleeve O.D. with emery cloth.
4. Clean all parts with a cleaner.
5. Apply a LOCTITE® Bearing Mount 680™ or LOCTITE® Press Fit Repair 660™ coating around the shaft.
6. Install sleeve.
7. Apply a coating of LOCTITE® Press Fit Repair 660™ to sleeve O.D.
8. Install component as required onto sleeved shaft.
9. Allow 30 to 60 minute cure.

- NOTE:**
- LOCTITE® Press Fit Repair 660™ is NOT recommended for radial gaps exceeding .010".
 - Higher strengths are obtained by NOT using LOCTITE® Primer with small (.002" to .004") gap, and allowing longer cure (4 to 24 hours).

SHAFT MOUNTED ASSEMBLIES

SLIP FIT – LIGHT/HEAVY DUTY

ORIGINAL

1. Machine shaft to .002" radial slip fit with 50-80 rms finish (second cut).
2. Clean all parts with a cleaner.
3. Spray all parts (I.D. and O.D.) with LOCTITE® Primer. Do NOT use primer for heavy duty applications.
4. Apply a LOCTITE® Press Fit Repair 660™ coating around shaft and engagement area.
5. Assemble parts with rotating motion.
6. Wipe off excess.
7. Allow 2 hours prior to service.

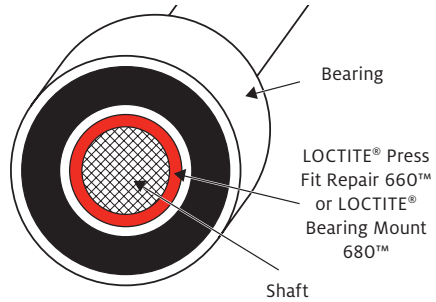

WORN SHAFT

Follow directions above except:

1. Determine radial gap.
2. If radial gap exceeds .005", LOCTITE® Primer must be used.
3. Take steps to maintain concentricity with large gaps.
4. Larger gaps require longer cure times (30 to 60 minutes).
5. LOCTITE® Press Fit Repair 660™ is NOT recommended for radial gaps exceeding .010".
6. See procedure for BADLY WORN SHAFT on page 19.

NOTE: LOCTITE® Press Fit Repair 660™ is very fast fixturing (30 seconds or less) with LOCTITE® Primer.

MAXIMUM STRENGTH

1. Same as previous, except use LOCTITE® Bearing Mount 680™ with LOCTITE® Primer or no primer.
2. Allow 4 to 24 hours to cure.

MAXIMUM TEMPERATURE (400°F CONTINUOUS)

1. Same as above, except use LOCTITE® Bearing Mount 620™ or LOCTITE® Sleeve Retainer 640™ with LOCTITE® Primer.

SHAFT MOUNTED ASSEMBLIES

PRESS FIT

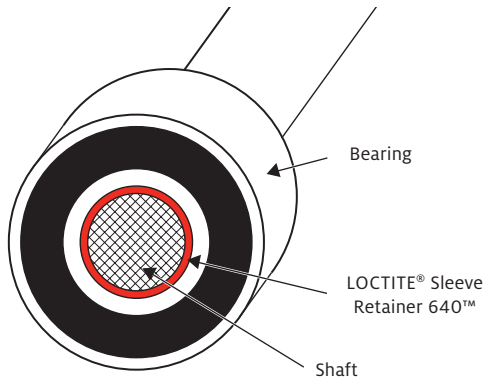

STANDARD

1. Clean shaft O.D. and component I.D.
2. Apply a bead of LOCTITE® Sleeve Retainer 640™ to the circumference of the shaft at leading edge of insertion or leading area of engagement.

- NOTE:**
- Bearing Mounts will always be squeezed to the outside, when applied to shaft.
 - Do NOT use with LOCTITE® Anti-Seizes or similar products.

3. Press as usual. Wipe off excess.
4. No cure time required.

- NOTE:** LOCTITE® Sleeve Retainer 640™ is used due to low viscosity and wetting properties.

TANDEM MOUNT

1. Apply bearing mount to the bore of the inside component.
2. Continue assembly as above.

SHAFT MOUNTED ASSEMBLIES

SHRINK FIT

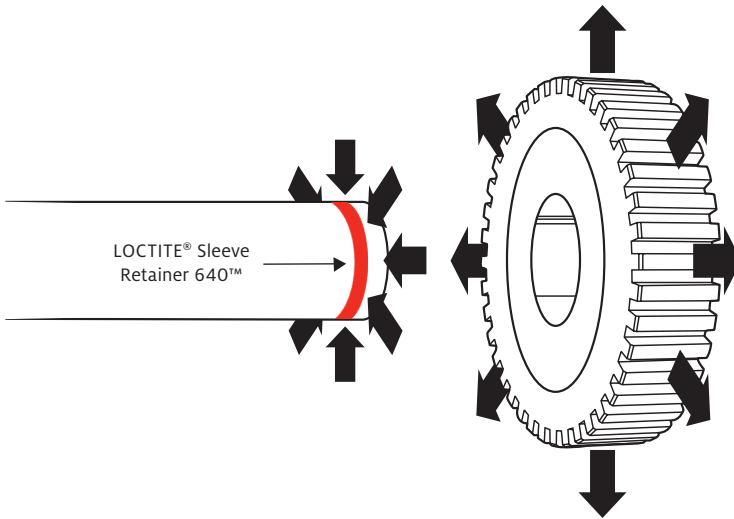

ASSEMBLY

1. Clean the shaft O.D. and component I.D.
2. Cool the shaft to cause contraction, or heat the component to cause expansion.
3. Apply a brush film of LOCTITE® Sleeve Retainer 640™ to the shaft or lower temperature part.
4. Install component and allow temperatures to equilibrate.
5. Wipe off excess.

NOTE: LOCTITE® Retaining Compound will add lubricity for easier assembly, while sealing and protecting the bond area from environmental exposure and filling gaps for a more complete contact area.

HOUSED COMPONENTS

SLIP FIT

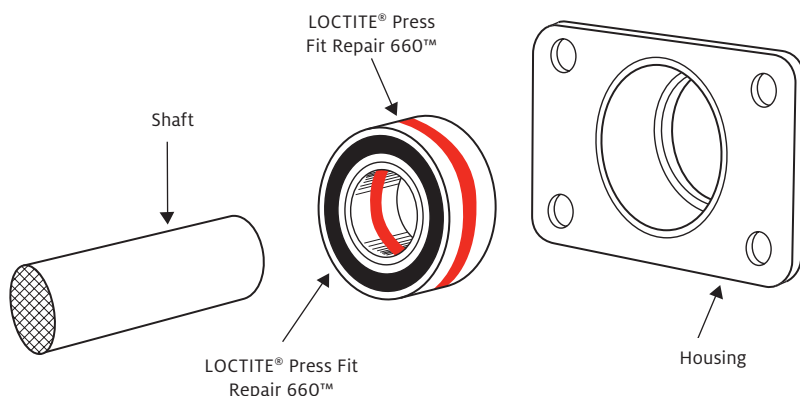

ORIGINAL

1. Select component to fit shaft.
2. Machine to reduce component O.D. or increase housing I.D. to permit approximate .002" to .004" diametral slip fit.
3. Clean all parts with a cleaner and spray with LOCTITE® Primer.
4. Apply LOCTITE® Press Fit Repair 660™ to component O.D.
5. Install component. Do not rotate.
6. Wipe off excess.
7. Allow five minutes prior to service.

WORN

Procedures identical to original slip fit, except:

1. Determine the maximum radial gap.
2. If the maximum gap exceeds .005", LOCTITE® Primer must be used.
3. Take steps to maintain concentricity on large gaps.
4. Large gaps require longer cure times (30 to 60 minutes).
5. LOCTITE® Press Fit Repair 660™ is NOT recommended for radial gaps exceeding .020".

HOUSED COMPONENTS

SEALING/RETAINING — METALLIC SEAL

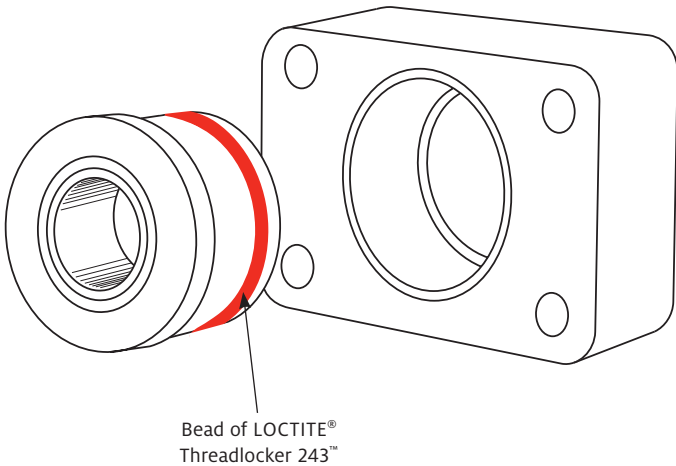

1. Clean the housing I.D. and seal O.D. with a cleaner.
2. Spray both the housing and seal with LOCTITE® Primer.
3. Apply a bead of LOCTITE® Threadlocker 243™ or LOCTITE® Blue Threadlocker Stick to the leading edge of metallic seal O.D.

NOTE: Virtually any LOCTITE® Threadlocking product will work here. Medium strength liquid is recommended due to normal gap and strength requirement.

4. Install as usual.
5. Wipe off excess.
6. Allow to cure 30 minutes.

NOTE:

- LOCTITE® Threadlocker 243™ or LOCTITE® Blue Threadlocker Stick is normally used with worn seal housings to prevent leakage or slippage.
- It is not generally necessary to remove pre-applied sealant from seal O.D.

RETAINING COMPOUNDS

LOCTITE® RETAINING COMPOUNDS QUICK SELECTOR

APPLICATION	LOCTITE® PRODUCT	LOCTITE® PRIMER
Shaft Mount – Press Fit		
Medium Strength	Sleeve Retainer 640™	YES
Shaft Mount – Shrink Fit		
Medium Strength	Sleeve Retainer 640™	NO
Shaft Mount – Shrink Fit		
Small Gap (.002" Radial max.)	Sleeve Retainer 640™	YES
Larger Gap (.010" Radial max.)	Press Fit Repair 660™	YES
Maximum Strength (.010" Radial max.)	Bearing Mount 680™	YES
Maximum Temperature (400°F) (.008" Radial max.)	Bearing Mount 620™	YES
Housing Mount – Press Fit		
Maximum Strength	Sleeve Retainer 640™	NO
Low Strength	Threadlocker 243™	NO
Housing Mount – Slip Fit		
Maximum Strength	Bearing Mount 680™	NO
High Strength	Press Fit Repair 660™	NO
Controlled Strength	Press Fit Repair 660™	YES
Low Strength	Threadlocker 243™ Blue Threadlocker Stick	YES

- NOTE:**
- Softer metals (Aluminum, Bronze, etc.) provide lower shear strengths than ferrous components.
 - Excessive gap reduces shear strengths.
 - Ideal surface finish — 50 to 80 rms.

Refer to **Technical Data Sheets** for more information.

DISASSEMBLY

THREADLOCKING, THREAD SEALING AND RETAINING

LOW AND MEDIUM STRENGTH PRODUCTS

Disassemble with hand tools.

HIGH STRENGTH PRODUCTS

- Apply localized heat (500°F or higher) to assembly for 5 minutes.
- Disassemble with hand tools while hot.

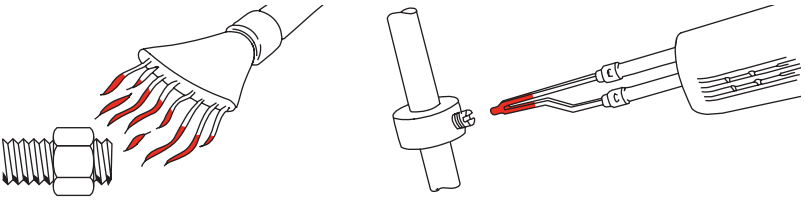

GASKETING

- Disassemble flange using hand tools. Remove material with a gasket remover.

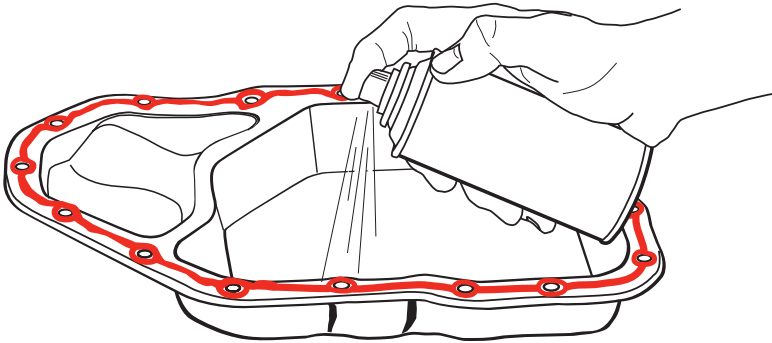

OPTIMUM USE OF LOCTITE® EXTEND® RUST TREATMENT

SURFACE PREPARATION — OLD STEEL:

Loose or “flaky” rust must be removed. Only conversion of firmly bonded rust will result in durable protection. Oil, grease, old paint, mill scale, form oil, fingerprints, water soluble surfaces and chlorides must be removed to allow LOCTITE® Extend® Rust Treatment to react with rust. Ideal surfaces will show light rust as well as bare metal surfaces.

RUST CONVERSION TIME AND APPEARANCE:

Two coats of LOCTITE® Extend® Rust Treatment are recommended. The first coat should develop a purple-black color within seconds. The second coat should dry to a black color. The second coat should be applied within 15-30 minutes of the first coat.

APPLICATION CONDITIONS:

LOCTITE® Extend® Rust Treatment may be applied when surface and air temperatures are between 50°F and 90°F. Reaction is slower at lower temperatures. If temperature is too hot, film may surface dry and bubble. High humidity is beneficial; it slows drying but assists rust conversion. LOCTITE® Extend® Rust Treatment should not be applied in conditions of condensing humidity (e.g. fog, dew), on ice, in rain or in heavy sea (salt) spray atmospheres. Steel surface may be damp but not wet (i.e. continuous visible film of water). DO NOT APPLY LOCTITE® EXTEND® RUST TREATMENT TO SURFACES IN DIRECT SUNLIGHT.

APPLICATION EQUIPMENT METHODS:

LOCTITE® Extend® Rust Treatment may be applied by brush, roller or spray. Brush or roller is suitable for small areas. Avoid sags and ridges and keep edges wet by coating about a square yard at a time. Roll away from previously coated area and then roll back. Do not pour unused material back into the original container. NEVER add solvents to LOCTITE® Extend® Rust Treatment.

Spray application is recommended for larger areas. Airless spray equipment is faster, and provides more effective conversion due to improved surface penetration. Conventional air-spray equipment may be used, but LOCTITE® Extend® Rust Treatment may require thinning up to 10% with water for proper spraying.



TROUBLESHOOTING

CHECKLIST

1. What type of failure is occurring? Has the application worked before?
2. Was proper and adequate adhesive/sealant used?
3. Was proper and adequate primer/activator used?
4. Do service conditions exceed the capability of the adhesive sealant?
 - (a) operating temperature
 - (b) excessive pressure too soon
 - (c) fluid compatibility
 - (d) impact on environment
5. Were parts adequately cleaned prior to applying adhesive?

NOTE: If adhesive failure, is cured residue on one or both parts?
If one part is bare, check that part for contamination.
6. Were proper assembly techniques utilized?
7. Was adhesive/sealant allowed adequate cure time prior to service?
8. Do assembly/part conditions exceed capability of the adhesive/sealant?
 - (a) excessive gaps
 - (b) component materials
 - (c) improper joint design
 - (d) inadequate clamping/fixturing
9. If additional assistance is required, please call our HENKEL TECHNICAL INFORMATION LINE. See back cover for the Henkel Technical Information number in your area.

LIMITATION OF WARRANTY

The data contained herein are furnished for information only and are believed to be reliable. We cannot assume responsibility for the results obtained by others over whose methods we have no control. It is the user's responsibility to determine suitability for the user's purpose of any production methods mentioned herein and to adopt such precautions as may be advisable for the protection of property and of persons against any hazards that may be involved in the handling and use thereof.

In light of the foregoing, HENKEL CORPORATION SPECIFICALLY DISCLAIMS ALL WARRANTIES OF MERCHANTABILITY OR FITNESS FOR A PARTICULAR PURPOSE ARISING FROM SALE OR USE OF HENKEL CORPORATION'S PRODUCTS. HENKEL CORPORATION

SPECIFICALLY DISCLAIMS ANY LIABILITY FOR CONSEQUENTIAL OR INCIDENTAL DAMAGES OF ANY KIND, INCLUDING LOST PROFITS. The discussion herein of various processes or compositions is not to be interpreted as representation that they are free from domination of patents owned by others or as a license under any Henkel Corporation patents which may cover such processes or compositions. We recommend that each prospective user test the proposed application to determine its suitability for the purposes intended prior to incorporating any product or application in its manufacturing process using this data as a guide. Some products may be covered by one or more United States or foreign patents or patent applications.

PRODUCT LISTING/ORDER INFORMATION

LOCTITE® GASKETING PRODUCTS		SIZE	ITEM NO.
Gasket Maker 515™		50 ml tube	38655
Gasket Maker 518™		6 ml tube	2203452
		50 ml tube	2096059
		300 ml cartridge	2096063
Ready Gasket		5 oz. cartridge	37512
		7 oz. can	37510
		190 ml power can	40480
RTV 587™ Blue Silicone Gasket Maker		80 ml tube	37465
		190 ml power can	2093364
		300 ml cartridge	37516
RTV 598™ Black Silicone Gasket Maker		8.75 oz. can	37519
		11 ml tube	37472
		80 ml tube	37467
		190 ml power can	2093362
		300 ml cartridge	37518
RTV 5920™ Copper Silicone Gasket Maker		80 ml tube	37466
RTV 5699™ Grey Silicone Gasket Maker		80 ml tube	37464
		190 ml power can	2093363
LOCTITE® GENERAL MAINTENANCE PRODUCTS		SIZE	ITEM NO.
Extend® Rust Treatment		10.25 oz. aerosol	633877
		8 fl. oz. bottle	1381192
Form-A-Thread® Stripped Thread Repair		12.9 ml	28654
LOCTITE® PRIMERS		SIZE	ITEM NO.
Primer		4.5 oz. aerosol	37509
LOCTITE® RETAINING COMPOUNDS		SIZE	ITEM NO.
Bearing Mount 620™	High Temperature	36 ml bottle	38652
Sleeve Retainer 640™	High Strength	6 ml tube	37424
		36 ml bottle	37484
Press Fit Repair 660™	For Worn Parts	50 ml tube	38651
Bearing Mount 680™	Relaxed Fits	36 ml bottle	37485

ORDERING

PRODUCT LISTING/ORDER INFORMATION

LOCTITE® THREADLOCKERS		SIZE	ITEM NO.
Threadlocker 222™	Low Strength	6 ml tube	38653
Threadlocker 242®	Medium Strength	6 ml tube	37418
		36 ml bottle	37418
Threadlocker 243™	Oil Tolerant / Med. Strength	6 ml tube	330799
		36 ml bottle	1330906
Blue Threadlocker Stick	Medium Strength	9 g stick	37643
		19 g stick	37614
Quicktape® 249™ Threadlocker Tape	Medium Strength	260" Roll	1372603
Threadlocker 262™	High Strength	6 ml tube	37420
		36 ml bottle	37478
Threadlocker 263™	Oil Tolerant / High Strength	6 ml tube	2203451
		36 ml bottle	2205310
Threadlocker 271™	Heavy Duty	0.5 ml ampule	27105
		6 ml tube	37421
		36 ml bottle	37479
Threadlocker 272™	High Temperature	6 ml tube	37422
		36 ml bottle	37480
Red Threadlocker Stick	High Strength	9 g stick	37701
		19 g stick	37700
Threadlocker 277™	Heavy Duty/Large Bolts	36 ml tube	38656
Threadlocker 290™	Penetrating	6 ml bottle	37423
LOCTITE® THREAD SEALANTS		SIZE	ITEM NO.
Thread Sealant 545™	Pneumatic/Hydraulic	36 ml bottle	37482
Thread Sealant Stick	High Performance	19 g stick	37615
Thread Sealant 565™	High Performance	50 ml tube	37396
Thread Sealant 592™	High Performance	6 ml tube	37398
		50 ml tube	37397

NOTES





Henkel – Your worldwide partner

For technical information and/or product availability, call:

USA

Henkel Corporation
Engineering Adhesives
One Henkel Way
Rocky Hill, CT 06067 USA
Tel: 1.855.436.5359
Tel: 860.571.5100
Fax: 860.571.5465

MEXICO

Henkel Capital, S.A. de C.V.
Blvd. Magnocentro No. 8 Piso 2
Centro Urbano Interlomas
52760 Huixquilucan, Estado de México
Tel: 01.800.436.5357 (within Mexico)
Tel: +52.55.3300.3644
Fax: +52.55.3300.3019

CANADA

Henkel Canada Corporation
Engineering Adhesives
2515 Meadowpine Blvd.
Mississauga, Ontario L5N 6C3
Tel: 1.800.263.5043 (within Canada)
Tel: 905.814.6511
Fax: 905.814.5391

www.na.henkel-adhesives.com