

LogiCORE IP SelectIO Interface Wizard v3.1

Getting Started Guide

UG700 March 1, 2011



Xilinx is providing this product documentation, hereinafter “Information,” to you “AS IS” with no warranty of any kind, express or implied. Xilinx makes no representation that the Information, or any particular implementation thereof, is free from any claims of infringement. You are responsible for obtaining any rights you may require for any implementation based on the Information. All specifications are subject to change without notice.

XILINX EXPRESSLY DISCLAIMS ANY WARRANTY WHATSOEVER WITH RESPECT TO THE ADEQUACY OF THE INFORMATION OR ANY IMPLEMENTATION BASED THEREON, INCLUDING BUT NOT LIMITED TO ANY WARRANTIES OR REPRESENTATIONS THAT THIS IMPLEMENTATION IS FREE FROM CLAIMS OF INFRINGEMENT AND ANY IMPLIED WARRANTIES OF MERCHANTABILITY OR FITNESS FOR A PARTICULAR PURPOSE.

Except as stated herein, none of the Information may be copied, reproduced, distributed, republished, downloaded, displayed, posted, or transmitted in any form or by any means including, but not limited to, electronic, mechanical, photocopying, recording, or otherwise, without the prior written consent of Xilinx.

© 2009-2011 Xilinx, Inc. XILINX, the Xilinx logo, Virtex, Spartan, ISE, and other designated brands included herein are trademarks of Xilinx in the United States and other countries. All other trademarks are the property of their respective owners.

Revision History

The following table shows the revision history for this document.

Date	Version	Revision
09/16/09	1.1	Initial Xilinx release.
12/02/09	1.2	Updated tool versions. Added Phase Detector Interface Ports to Table 3-2 . Added Phase Detector in Chapter 5 . Replaced the following: IODELAY with IODELAY2; ISERDES with ISERDES2; OSERDES with OSERDES2; IDDR with IDDR2; ODDR with ODDR2.
04/19/10	1.3	Updated Wizard and tool versions. Miscellaneous edits for clarification.
07/23/10	1.4	Revised LogiCORE IP Facts table’s format and content. Added support for Virtex-6 FPGAs. Added Chapter 4, Generating the Core - 7 Series and Virtex-6 FPGAs .
12/14/10	1.5	Updated Wizard and tool versions. In Chapter 5, Generating the Core - Spartan-6 FPGAs : Added Interface for I/O Configuration, page 32 , expanded Data Bus Direction, page 32 , Clock Forwarding, page 34 , and added Summary Page, page 38 . In Chapter 4, Generating the Core - 7 Series and Virtex-6 FPGAs : Added Interface for IO Configuration, page 24 , expanded Data Bus Direction, page 24 , Clock Forwarding, page 26 , and added Summary Page, page 29 .
03/01/11	2.0	Added support for Virtex-7 and Kintex-7 device support. Updated GUI screens. Support for ISE software and tools v13.1.

Table of Contents

Revision History	2
Preface: About This Guide	
Guide Contents	7
Additional Resources	7
Conventions	8
Typographical	8
Online Document	9
Chapter 1: Introduction	
About the Core	11
Recommended Design Experience	11
Related Xilinx Documents	11
Additional Core Resources	12
Technical Support	12
Ordering Information	12
Feedback	12
SelectIO Interface Wizard	12
Document	12
Chapter 2: Installation	
Supported Tools and System Requirements	15
Operating Systems	15
Tools and Simulation	15
Before You Begin	16
Installing the Wizard	16
Verifying Your Installation	16
Chapter 3: Core Architecture	
Clock Buffering and Manipulation	17
Datapath	18
I/O Signals	19
Chapter 4: Generating the Core - 7 Series and Virtex-6 FPGAs	
Data Bus Setup	23
Component Name	24
Interface for IO Configuration	24
Data Bus Direction	24
I/O Signaling	24
Data Bus Setup 2	25
Data Rate	25

Serialization	25
External Data Width	26
Input Interface Type	26
Clock Forwarding	26
Data Delay	26
Delay Type	27
Tap Setting	27
Clock Setup	27
Clock Signaling	28
Clocking Strategy	28
Input and Output DDR Data Alignment	28
Clock Delay	28
Summary Page	29
Generating the Core	30

Chapter 5: Generating the Core - Spartan-6 FPGAs

Data Bus Setup	31
Component Name	32
Interface for I/O Configuration	32
Data Bus Direction	32
I/O Signaling	32
Data Bus Setup 2	33
Phase Detector	33
Serialization	33
External Data Width	34
Input Interface Type	34
Clock Forwarding	34
Data Delay	35
Delay Type	35
Tap Setting	35
Tap Behavior	35
Clock Setup	36
Clock Signaling	36
Clock Buffer	36
Active Clock Edge	36
DDR Data Alignment	37
Clock Delay	37
Summary Page	38
Generating the Core	38

Chapter 6: Detailed Example Design

Directory and File Structure	39
Directory and File Contents	40
<project directory>	40
<project directory>/<component name>	40
<component name>/example design	40
<component name>/doc	41
<component name>/implement	41
implement/results	41

<component name>/simulation	41
simulation/functional	42
Implementation Scripts	42
Simulation Scripts	43
Functional Simulation	43
Example Design	43
Top Level Example Design	43
Customizing the Example Design	43
Demonstration Test Bench	44

About This Guide

The guide provides information about the Xilinx® LogiCORE™ IP SelectIO™ Interface Wizard core. Information is provided to step you through the graphical user interface (GUI) options and for using the provided example design and test bench.

Guide Contents

This guide contains the following chapters:

- [Preface, “About this Guide”](#) introduces the organization and purpose of this guide, a list of additional resources, and the conventions used in this document.
- [Chapter 1, Introduction](#) describes the core and related information, including recommended design experience, additional resources, technical support, and submitting feedback to Xilinx.
- [Chapter 2, Installation](#) provides instructions for installing the LogiCORE IP SelectIO Interface Wizard in the Xilinx® CORE Generator™ tool.
- [Chapter 3, Core Architecture](#) describes the generated I/O circuit, including the datapath and clock generators.
- [Chapter 4, Generating the Core - 7 Series and Virtex-6 FPGAs](#) provides information about the GUI selections for Virtex-7, Kintex-7, and Virtex-6 FPGAs to generate the desired I/O circuit.
- [Chapter 5, Generating the Core - Spartan-6 FPGAs](#) provides information about GUI selections to generate the desired I/O circuit for Spartan-6 FPGAs.
- [Chapter 6, Detailed Example Design](#) describes the provided example design and test bench.

Additional Resources

To find additional documentation, see the Xilinx website at:

<http://www.xilinx.com/support/documentation/index.htm>.

To search the Answer Database of silicon, software, and IP questions and answers, or to create a technical support WebCase, see the Xilinx website at:

<http://www.xilinx.com/support/mysupport.htm>.

Conventions

This document uses the following conventions. An example illustrates each convention.

Typographical

The following typographical conventions are used in this document:

Convention	Meaning or Use	Example
Courier font	Messages, prompts, and program files that the system displays	<code>speed grade: - 100</code>
Courier bold	Literal commands that you enter in a syntactical statement	ngdbuild <i>design_name</i>
Helvetica bold	Commands that you select from a menu	File → Open
	Keyboard shortcuts	Ctrl+C
<i>Italic font</i>	Variables in a syntax statement for which you must supply values	ngdbuild <i>design_name</i>
	References to other manuals	See the <i>User Guide</i> for more information.
	Emphasis in text	If a wire is drawn so that it overlaps the pin of a symbol, the two nets are <i>not</i> connected.
Dark Shading	Items that are not supported or reserved	This feature is not supported
Square brackets []	An optional entry or parameter. However, in bus specifications, such as bus [7:0] , they are required.	ngdbuild [<i>option_name</i>] <i>design_name</i>
Braces { }	A list of items from which you must choose one or more	lowpwr = { on off }
Vertical bar	Separates items in a list of choices	lowpwr = { on off }
Angle brackets < >	User-defined variable or in code samples	<directory name>
Vertical ellipsis	Repetitive material that has been omitted	IOB #1: Name = QOUT' IOB #2: Name = CLKIN' . . .
Horizontal ellipsis ...	Repetitive material that has been omitted	allow block <i>block_name</i> <i>loc1</i> <i>loc2</i> ... <i>locn</i> ;

Convention	Meaning or Use	Example
Notations	The prefix '0x' or the suffix 'h' indicate hexadecimal notation	A read of address 0x00112975 returned 45524943h.
	An '_n' means the signal is active low	usr_teof_n is active low.

Online Document

The following conventions are used in this document:

Convention	Meaning or Use	Example
Blue text	Cross-reference link to a location in the current document	See the section " Additional Resources " for details. Refer to " Title Formats " in Chapter 1 for details.
Blue, underlined text	Hyperlink to a website (URL)	Go to http://www.xilinx.com for the latest speed files.

Introduction

This chapter introduces the LogiCORE™ IP SelectIO™ Interface Wizard core and provides related information, including recommended design experience, additional resources, technical support, and submitting feedback to Xilinx. The SelectIO Interface Wizard core generates source code to implement an I/O circuit matched to your requirements and is designed to support both Verilog and VHDL design environments. In addition, the example design delivered with the core is provided in both Verilog and VHDL.

About the Core

The SelectIO Interface Wizard core is an ISE® CORE Generator™ IP core that automates the configuration of the SelectIO resources in Virtex-7, Kintex-7, Virtex-6, and Spartan-6 FPGAs.

Recommended Design Experience

The SelectIO Interface Wizard is designed to be used by those with some level of experience with Xilinx FPGA I/Os. It is the easiest way to create your I/O circuit. Advanced users may choose to modify the generated source code directly. Although the SelectIO Interface Wizard provides a fully verified solution, understanding the Xilinx I/O primitives will help in making design trade-off decisions.

Related Xilinx Documents

UG471: *7 Series FPGAs SelectIO Resources User Guide*

UG472: *7 Series FPGAs Clocking Resources User Guide*

UG361: *Virtex-6 FPGA SelectIO Resources User Guide*

UG362: *Virtex-6 FPGA Clocking Resources User Guide*

UG381: *Spartan-6 FPGA SelectIO Resources User Guide*

UG382: *Spartan-6 FPGA Clocking Resources User Guide*

DS709: *LogiCORE IP Clocking Wizard Data Sheet*

UG521: *LogiCORE IP Clocking Wizard Getting Started Guide*

ISE® documentation at <http://www.xilinx.com/ise>

Additional Core Resources

For detailed information and updates about the SelectIO Interface Wizard core, see the following documents, located on the [Architecture Wizards product page](#):

- DS746: *LogiCORE IP SelectIO Interface Wizard v3.1 Data Sheet*
- SelectIO Interface Wizard Release Notes
- This guide

Technical Support

For technical support, go to www.xilinx.com/support. Questions are routed to a team with expertise using the SelectIO Interface Wizard core.

Xilinx will provide technical support for use of this product as described in this guide. Xilinx cannot guarantee timing, functionality, or support of this product for designs that do not follow these guidelines.

Ordering Information

The LogiCORE IP SelectIO Wizard is provided free of charge under the terms of the Xilinx End User License Agreement. The Wizard can be generated using the Xilinx ISE CORE Generator software, which is a standard component of the Xilinx ISE Design Suite. This version of the core can be generated using the ISE CORE Generator system v13.1. For more information, please visit the [Architecture Wizards web page](#).

Information about additional Xilinx LogiCORE modules is available at the [Xilinx IP Center](#). For pricing and availability of other Xilinx LogiCORE modules and software, please contact your local [Xilinx sales representative](#).

Feedback

Xilinx welcomes comments and suggestions about the SelectIO Interface Wizard core and the accompanying documentation.

SelectIO Interface Wizard

For comments or suggestions about the SelectIO Interface Wizard core, please submit a WebCase from www.xilinx.com/support/clearxpress/websupport.htm. Be sure to include the following information:

- Product name
- Core version number
- Explanation of your comments

Document

For comments or suggestions about the SelectIO Interface Wizard core, please submit a WebCase from www.xilinx.com/support/clearxpress/websupport.htm. Be sure to include the following information:

- Document title
- Document number

- Page number(s) to which your comments refer
- Explanation of your comments

Installation

This chapter provides information about installing the LogiCORE™ IP SelectIO™ Interface Wizard. It is not necessary to obtain a license to use the Wizard.

Supported Tools and System Requirements

Operating Systems

Windows

- Windows XP Professional 32-bit/64-bit
- Windows Vista Business 32-bit/64-bit

Linux

- Red Hat Enterprise Linux WS v4.0 32-bit/64-bit
- Red Hat Enterprise Desktop v5.0 32-bit/64-bit (with Workstation Option)
- SUSE Linux Enterprise (SLE) desktop and server v10.1 32-bit/64-bit

Tools and Simulation

- ISE® Design Suite 13.1 or later software
- Mentor Graphics ModelSim 6.6d
- Cadence Incisive Enterprise Simulator (IES) 10.2
- Synopsys VCS and VCS MX 2010.06
- Synopsys Synplify Pro D-2010.06

Check the release notes for the required Service Pack; ISE Service Packs can be downloaded from www.xilinx.com/xlnx/xil_sw_updates_home.jsp?update=sp.

Before You Begin

Before installing the Wizard, you must have an account. To create an account, Click **Login** at the top of the Xilinx.com home page then follow the on screen instructions to create an account.

Installing the Wizard

The SelectIO Interface Wizard is included with the 11.3 and later versions of ISE software and can be accessed from the ISE CORE Generator tool.

For detailed ISE software installation instructions, see the ISE Design Suite Release Notes and Installation Guide available in the ISE software section of the Documentation Center under “Design Tools” at www.xilinx.com/support/documentation.

Verifying Your Installation

Use the following procedure to verify that you have successfully installed the LogiCORE IP SelectIO Interface Wizard in the CORE Generator tool.

1. Start the CORE Generator tool.
2. The IP core functional categories appear at the left side of the window, as shown in [Figure 2-1](#).

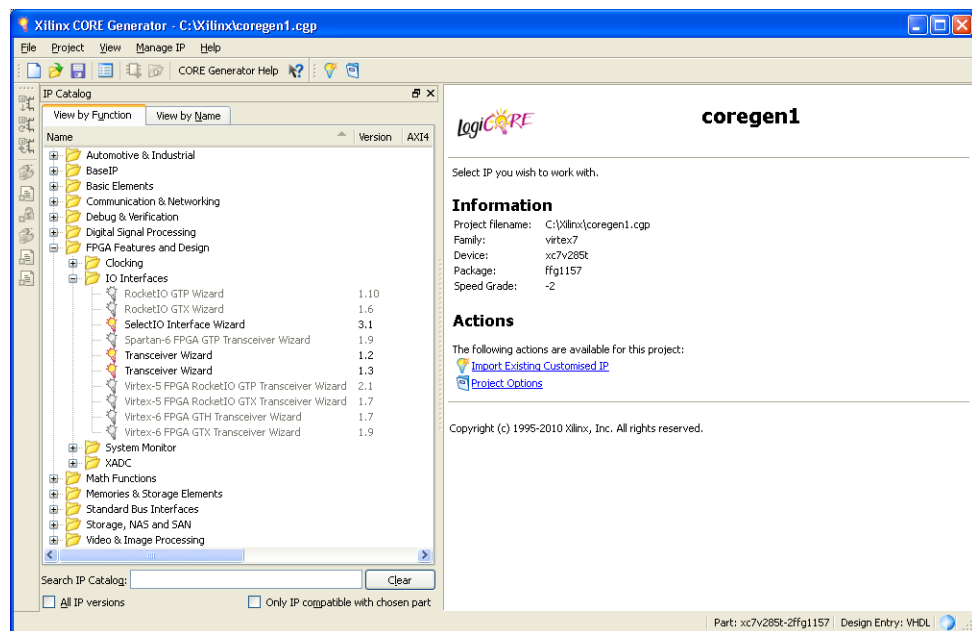

Figure 2-1: CORE Generator Tool Window

3. Click to expand or collapse the view of individual functional categories, or click the **View by Name** tab at the top of the list to see an alphabetical list of all cores in all categories.
4. Determine if the installation was successful by verifying that SelectIO Interface Wizard v3.1 appears at the following location in the Functional Categories list:
/FPGA Features and Design/IO Interfaces

Core Architecture

The SelectIO™ Interface Wizard provides source HDL that implements an I/O circuit for an input, output or bidirectional bus, including the buffer, any required delay elements, ISERDES and OSERDES elements, registers, and the I/O clock driver. The circuit is designed in two major components: a) clock buffering and manipulation, and b) datapath, which is implemented per-pin.

Clock Buffering and Manipulation

The wizard supports the use of a BUFG, BUFIO, BUFIO2, or BUFPLL for clocking the I/O logic. An example circuit illustrating a BUFIO2 primitive with input data is illustrated in Figure 3-1.

Insertion delay can be added for the input clock (except in the case of a BUFPLL, which is driven from a PLL_BASE in fabric).

For serialization or deserialization of the datapath, the slower divided fabric clock is created and/or aligned to the input clock on behalf of the user (except in the case of a BUFG, which does not support serialized/deserialized data).

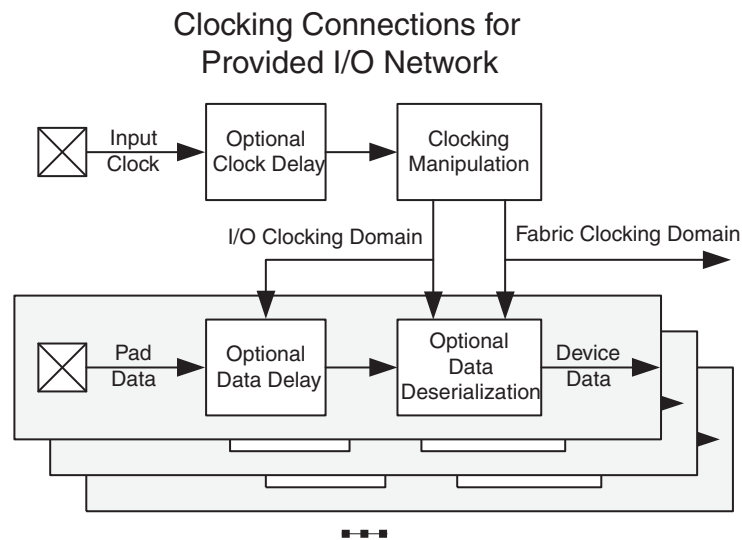

Figure 3-1: Provided I/O Circuit

Datapath

The wizard assists the user in instantiating and configuring the components within the I/O interconnect block.

The user can choose to:

- Use or bypass the delay insertion functionality
- Use serialization/deserialization through use of Input SERDES or Output SERDES
- Register double data-rate data
- Use the I/O registers for single rate data
- Drive directly into the fabric

The dataflow graph for an input bus is shown in [Figure 3-2](#). For an output bus, the components will be similar, but the data will flow in the other direction. For a bidirectional bus, there will be both an input and output path, although there is only one IODELAY2 or IODELAYE1 element.

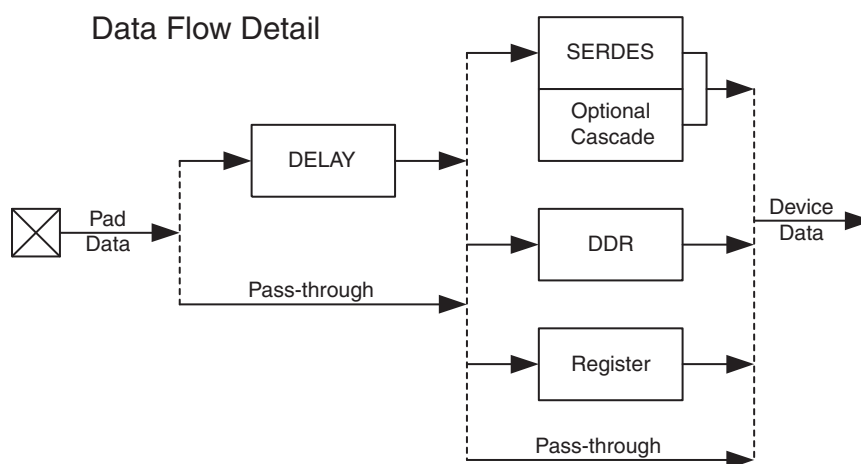

Figure 3-2: Flow in the I/O Input Datapath

I/O Signals

Table 3-2 describes the input and output ports provided by the I/O circuit. All ports are optional, although there will be at least one input clock, one signal tied to a pin connection, and one signal tied to a device connection. Availability of the ports is controlled by user-selected parameters. For example, when a variable delay is selected, the delay programming ports are exposed to the user.

Table 3-1 provides a list of resources for specific I/O interconnect and clock primitives.

Table 3-1: SelectIO and Clock Resources

I/O Primitives	Document
Interconnect	<i>Spartan-6 FPGA SelectIO Resources User Guide</i> <i>Virtex-6 FPGA SelectIO Resources User Guide</i>
Clock	<i>Virtex-6 FPGA Clocking Resources User Guide</i> <i>Spartan-6 FPGA Clocking Resources User Guide</i>

Table 3-2 defines the I/O circuit input and output ports.

Table 3-2: I/O Circuit Input and Output Port Descriptions

Port	I/O	Description
Clock Ports (1)		
CLK_IN	Input	Clock in: Single-ended input clock. Available when a single-ended clock is selected.
CLK_IN_P	Input	Clock in Positive and Negative. Available when a differential clock source is selected.
CLK_IN_N		
CLK_OUT	Output	Clock out: Buffered and/or delayed output clock to connect to fabric. Available when no serialization is selected, and the clock primitive is not a BUFPLL or MMCM.
CLK_DIV_IN	Input	Clock divided in: Input clock for serialization in the I/O Logic. Available when serialization is chosen, and the clock primitive is BUFPLL/MMCM.
CLK_DIV_OUT	Output	Clock divided out: Buffered and divided output clock to connect to fabric. Available when serialization is selected, and the clock primitive is a BUFIO2 or BUFIO.
Reset Ports		
CLK_RESET	Input	Clock reset: Reset connected to clocking elements in the circuit.
IO_RESET	Input	I/O reset: Reset connected to all other elements in the circuit.
Pin Data Bus Ports		
DATA_IN_FROM_PINS	Input	Data in from pins: Single-ended input bus on the side of the pins.

Table 3-2: I/O Circuit Input and Output Port Descriptions (Cont'd)

Port	I/O	Description
DATA_IN_FROM_PINS_P	Input	Data in from pins positive and negative: Differential input bus on the side of the pins.
DATA_IN_FROM_PINS_N		
DATA_OUT_TO_PINS	Output	Data out to pins: Single-ended output bus on the side of the pins.
DATA_OUT_TO_PINS_P	Output	Data out to pins positive and negative: Differential output bus on the side of the pins.
DATA_OUT_TO_PINS_N		
DATA_TO_AND_FROM_PINS	Input/ Output	Data to and from pins: Single-ended bidirectional data bus on the side of the pins
DATA_TO_AND_FROM_PINS_P	Input/ Output	Data to and from pins positive and negative: Differential bidirectional data bus on the side of the pins.
DATA_TO_AND_FROM_PINS_N		
Device Data Bus Ports		
DATA_IN_TO_DEVICE	Output	Data in to device: Input bus on the side of the device.
DATA_OUT_FROM_DEVICE	Input	Data out from device: Output bus on the side of the device.
Control and Status Ports		
BITSLIP	Input	Bit slip: Enable bit slip functionality on input data. Available on a input datapath and when enabled. For Virtex-6 based designs, this functionality is present for ISERDESE1 in NETWORKING mode.
TRAIN	Input	Train: Enable the training pattern. The train function is a means of specifying a fixed output pattern that can be used to calibrate the receiver of the signal. This port allows the FPGA logic to control whether the output is the fixed training pattern or the output data from the pins. Available on a output datapath and when enabled.
TRISTATE_OUTPUT	Input	3-state Output: Disables the output path. This signal is synchronized with the input data. Available with a bidirectional datapath.
LOCKED_IN	Input	Locked In: The input clock generator has locked. Available with a BUFPLL. Connect to locked indicator from the PLL in the fabric.
LOCKED_OUT	Output	Locked Out: The BUFPLL has locked. Use this signal as the PLL locked indicator.
Variable Delay Ports		
DELAY_BUSY	Output	Delay busy: The variable delay circuitry is still busy- don't change current state.

Table 3-2: I/O Circuit Input and Output Port Descriptions (Cont'd)

Port	I/O	Description
DELAY_CLK	Input	Delay clock: The clock used to control the variable delay circuitry. Most designs will have this connected to the divided/buffered clock for the I/O logic.
DELAY_DATA_CAL	Input	Delay data calibrate: Trigger calibration on the delay for the datapath.
DELAY_DATA_CE	Input	Delay data clock enable: Enable a delay change event for the datapath. In case of Virtex-6 family devices, this pin is provided for each of the IODELAYE1 components.
DELAY_DATA_INC	Input	Delay data increment: Controls whether the delay is incremented (when asserted) or decremented (when deasserted) when the delay clock is enabled. In case of Virtex-6 family devices, this pin is provided for each of the IODELAYE1 components.
DELAY_RESET	Input	IODELAYE1 reset signal: Controls the loading of initial delay value
DELAY_TAP_IN [4:0]	Input	IODELAYE1 tap in signal: Counter value from FPGA logic for dynamically loadable tap value (CNTVALUEIN). This is provided for each of the IODELAYE1 components.
DELAY_TAP_OUT[4:0]	Output	IODELAYE1 tap out signal: Counter value going to FPGA logic for monitoring tap value (CNTVALUEOUT). This is provided for each of the IODELAYE1 components.

Notes:

1. Only a single-ended or differential input clock is required. For a BUFG or BUFIO2, this comes from a pin. For a BUFPLL, this comes from fabric.

Generating the Core - 7 Series and Virtex-6 FPGAs

This chapter describes how to generate the core for Kintex-7, Virtex-7, and Virtex-6 FPGA designs, and describes the GUI options. Tool tips are available for most features. You can access them by placing your mouse over the relevant text.

For information about designs using a Spartan-6 device, please see [Chapter 5, Generating the Core - Spartan-6 FPGAs](#).

Data Bus Setup

Page 1 of the GUI (Figure 4-1) allows you to set up some general features for the data bus.

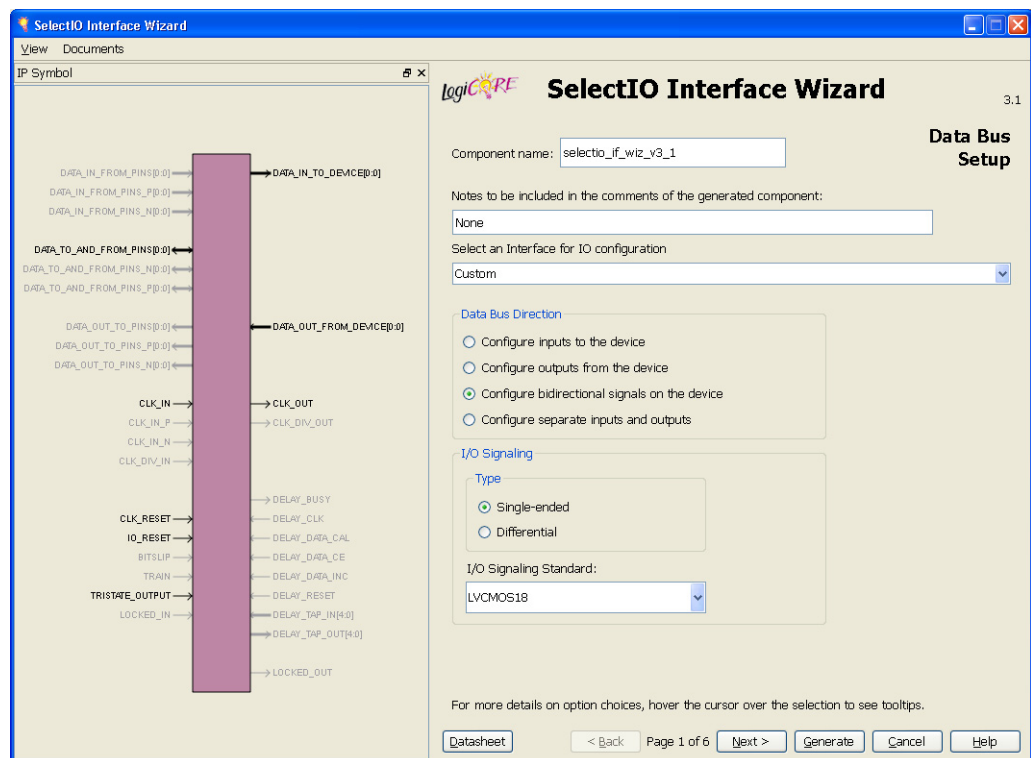

Figure 4-1: Main Screen- Data Bus Setup - Page 1

Component Name

The component name is user selectable. Component names must not contain any reserved words in Verilog or VHDL. Blank spaces are not allowed; use an underscore character instead as a separator between multiple words specified as the component name.

Interface for IO Configuration

SelectIO Wizard has some pre-configured IO interfaces available in the drop-down menu. Choosing one of these interfaces automatically sets the necessary parameters, such as data bus direction, I/O signalling, and the serialization factor.

The SelectIO wizard supports SGMII, DVI receiver, DVI transmitter, Camera link receiver, Camera link transmitter, and Chip-to-Chip interface, and only configures the data pins for these interfaces.

The listed options vary, based on the selected device family.

Data Bus Direction

Use this screen to select the direction of the bus. SelectIO Wizard supports Inputs, Outputs, Bidirectional and Separate IO buses. Choose bidirectional only if your bus must be bidirectional. Be aware that selecting this option will cause restrictions later on in the configuration process.

Separate Inputs and Outputs create independent Inputs and Outputs pins. Other configurable settings, such as Serialization factor, data width, and delays are common to both Inputs and Outputs. For example, if Separate Inputs and Outputs is chosen and the serialization factor is set to "5," that serialization factor would apply to both Input SERDES and Output SERDES.

I/O Signaling

This screen allows you to choose whether your bus is single-ended or differential.

- For Kintex-7 and Virtex-7 devices, a single ended signal with a serialization factor of 8 or less will occupy half of an I/O pair, whereas a signal with serialization of more than 8 will occupy the entire I/O pair. Differential signals will be created as I/O pairs.
- For Virtex-6 devices, single-ended signals with a serialization factor of 6 or less will occupy half of an I/O pair. Single-ended signals with a serialization factor of 7 or more will occupy an entire I/O pair.

All I/O signaling standards are shown for the I/O signaling type selected. This value will appear in the generated HDL code. Not all devices in the Kintex-7 and Virtex-7 device families support the 2.5 and 3.3v I/O standard. See the 7 Series FPGAs Data Sheet (DS182) for more information.

Data Bus Setup 2

Page 2 of the GUI (Figure 4-2) allows you to specify the configuration for the I/O interconnect datapath.

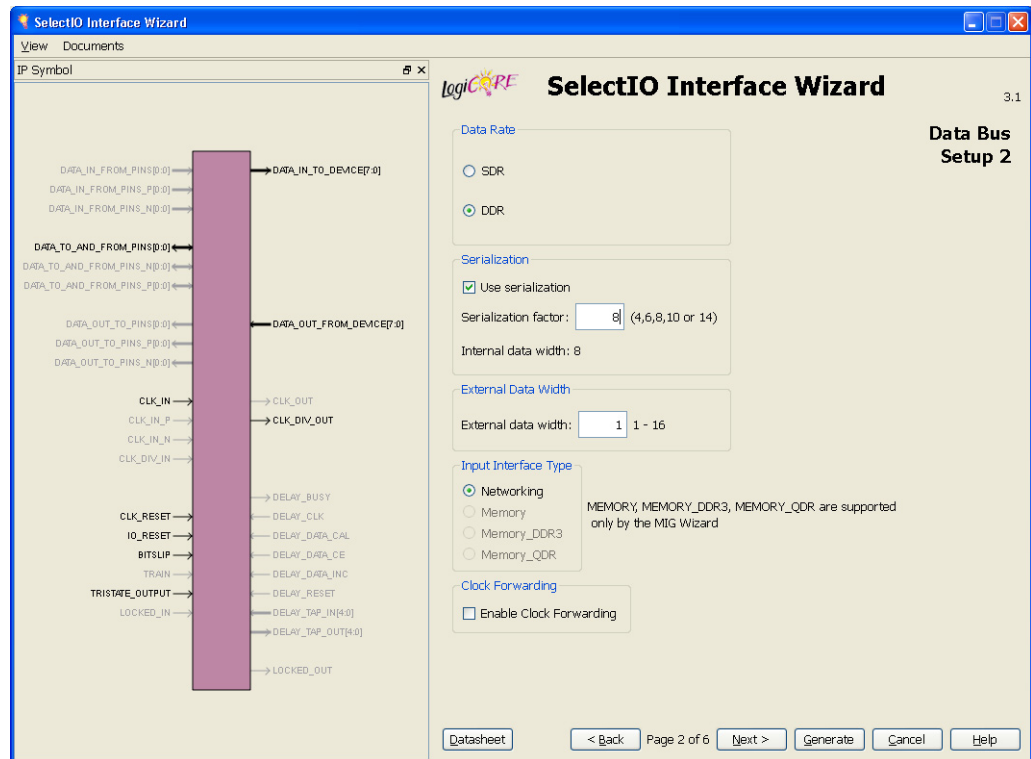

Figure 4-2: Data Bus Setup - Page 2

Data Rate

Select "SDR" if the data is clocked on rising edge. If the incoming or outgoing data is clocked on both the edges, then select "DDR." The selection of Data Rate affects the serialization factor limits. These are displayed dynamically on the page.

Serialization

If "Use Serialization" is selected, an ISERDESE1 and/or OSERDESE1 is instantiated. The bus on the device side increases by the serialization factor. All data is collected by timeslice and concatenated from right to left. For example, assume that the output data bus is 8-bits wide with a serialization factor of 4. If the data is presented on the pins as 00, 01, 02, and 03, the data is presented to the device as 03020100.

- For Kintex-7 and Virtex-7 devices, two SERDES blocks per I/O are instantiated if the serialization factor is more than 8. When the Data Rate is "SDR," the possible values for serialization factor are 2–8.
- For a Virtex-6 device, selecting a serialization factor of 7–10 will cause two SERDES blocks per I/O to be instantiated, as each SERDES is capable of a maximum serialization of 6:1. Even if a single-ended bus was chosen, the entire I/O pair is now occupied.

When Data Rate is "DDR," the serialization factor can be set to 4, 6, 8, 10, or 14, based on the device family selected.

External Data Width

You can configure the number of bits on the system side, and automatically bits are set up on the device side. Note that differential signals occupy two pins for each data bit.

Input Interface Type

If "Serialization" is selected, the interface type can be configured to specify the timing of the data on the device side. The SelectIO Interface Wizard only supports the NETWORKING type of Input Interface. For other interfaces, such as MEMORY, MEMORY_QDR and MEMORY_DDR3, refer to the MIG tool. Bit-slip functionality is always enabled for NETWORKING mode. If not required, tie this pin to logic 0.

Clock Forwarding

Select this option if you want the SelectIO wizard to generate a clock forwarding logic. This option is only available when the bus direction is Output, Bidirectional, or Separate Inputs and Outputs.

Data Delay

Page 3 of the GUI (Figure 4-3) allows you to specify the type of delay for the data bus.

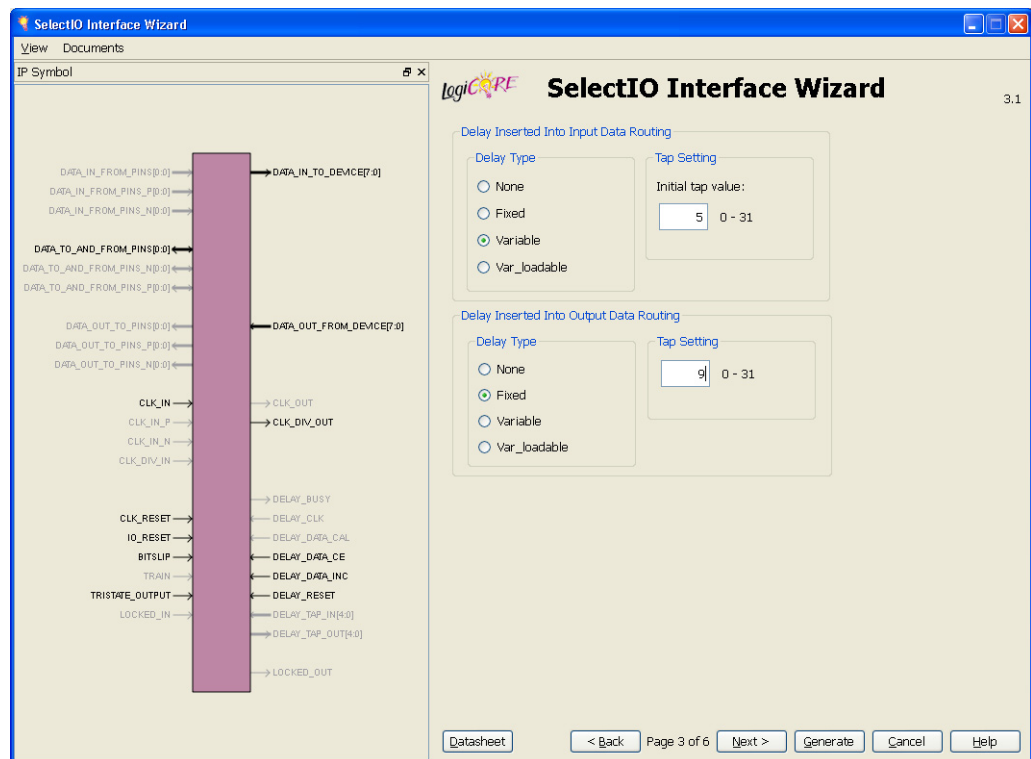

Figure 4-3: Data Delay - Page 3

Delay Type

An IODELAYE1 is instantiated if “Default,” “Fixed,” “Variable” or “Var_loadable delay” is chosen. Generally, if data is delayed with Fixed or Variable, delay will also be desired for the clock, given the high amount of insertion delay for the IODELAYE1 primitive. For a bidirectional bus, only specific combinations of Input and Output delay are possible.

Selecting “Variable” or “Var_loadable delay” option enables you to control each delay element individually. This means that the control signals of each delay element (for example, CE, INC, CNTVALUEIN, CNTVALUEOUT) are now accessible. If you want to control all delay elements in same way and at the same time, the signals such as CE, INC and CNTVALUEIN can be driven together from a common logic.

Tap Setting

If delay type chosen is “FIXED, VARIABLE,” the tap value can be specified. The allowed value for tap is 0–31.

Clock Setup

Page 4 of the GUI (Figure 4-4) allows you to configure the behavior of the clock.

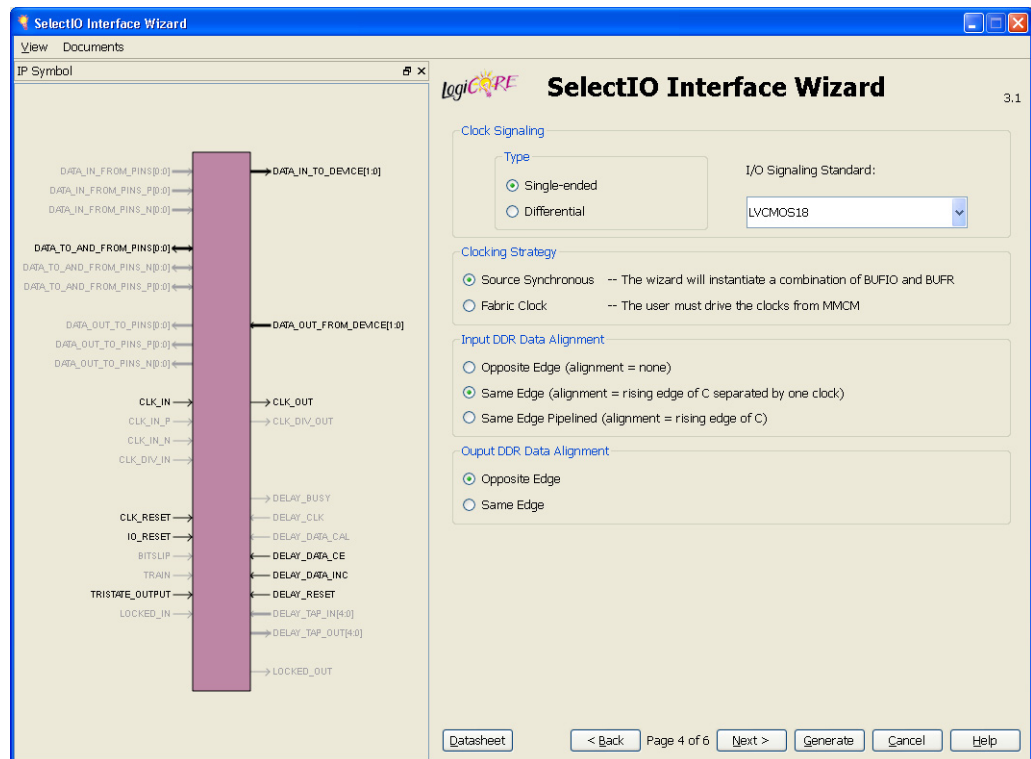

Figure 4-4: Clock Setup - Page 4

Clock Signaling

You can specify the signaling type and standard for the input clock. The I/O signaling standard will be embedded in the provided HDL source. For any design configured, the clock I/O signalling standard is the same as that of the bus I/O standard.

Clocking Strategy

If your clock comes from a pin, leave the input buffer as "Source Synchronous" for the most flexible functionality. Selecting this option instantiates the necessary circuitry of BUFIO and BUFR and configures them.

If the clock comes from fabric, choose "Fabric Clock" and instantiate a MMCM in the fabric to drive the clock. Selecting the "Fabric Clock" option overrides the "Clock Signaling" section. See the *LogiCORE IP Clocking Wizard Getting Started Guide* (UG521) for more information about MMCM instantiation and configuration.

Input and Output DDR Data Alignment

If serialization is not selected and DDR data is, the ODDR and IDDR primitives can be configured to align data to the rising, falling, or to both edges of the input clock. Note that the internal data width will double, and that data rate will be grouped by timeslice, just as is it for serialization.

The Input DDR Data Alignment option is available when bus direction is input or bidirectional. The Output DDR Data Alignment option is available when bus direction is output or bidirectional.

Clock Delay

Page 5 ([Figure 4-5](#)) allows you to specify the type of delay for the clock bus. See [Data Delay](#) for the definitions of the clock delay configuration fields.

- If there is no delay in the datapath, there should not be any delay in the clock path, so choose None.
- If there is delay in the datapath, you'll generally want to match the insertion delay in the clock path, so choose Fixed with a tap value of 0.

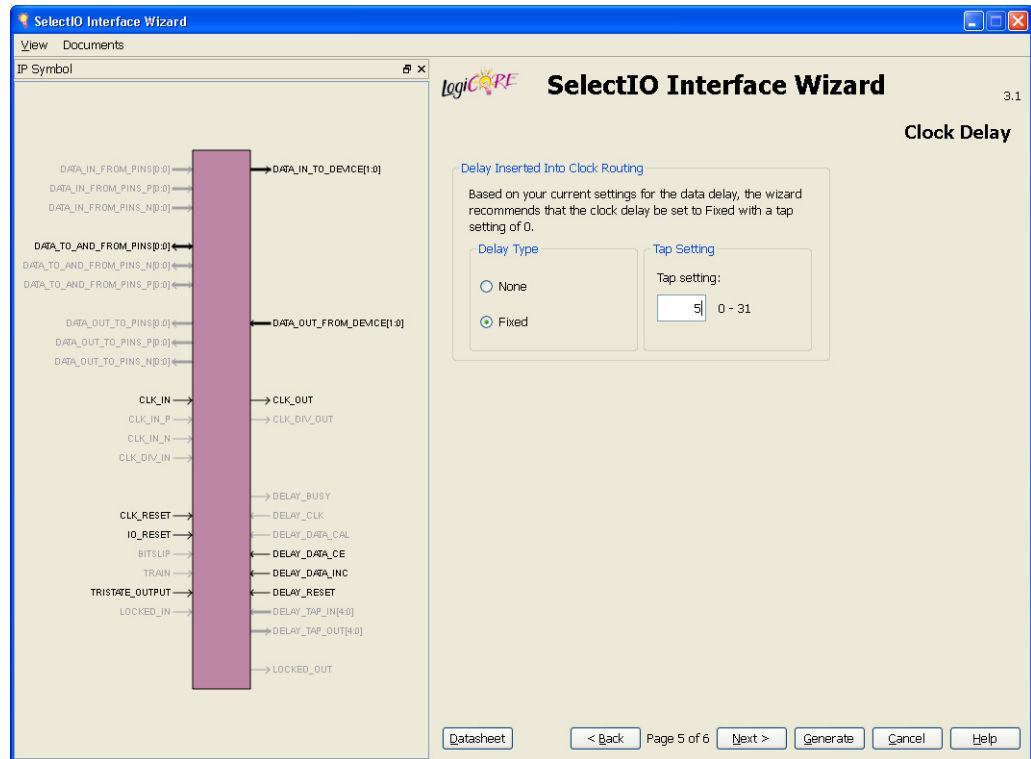

Figure 4-5: Clock Delay - Page 5

Summary Page

The summary page lists all the key parameters that you selected, such as the number of data I/Os, bus direction, serialization factor, buffers used, and the bus I/O standard.

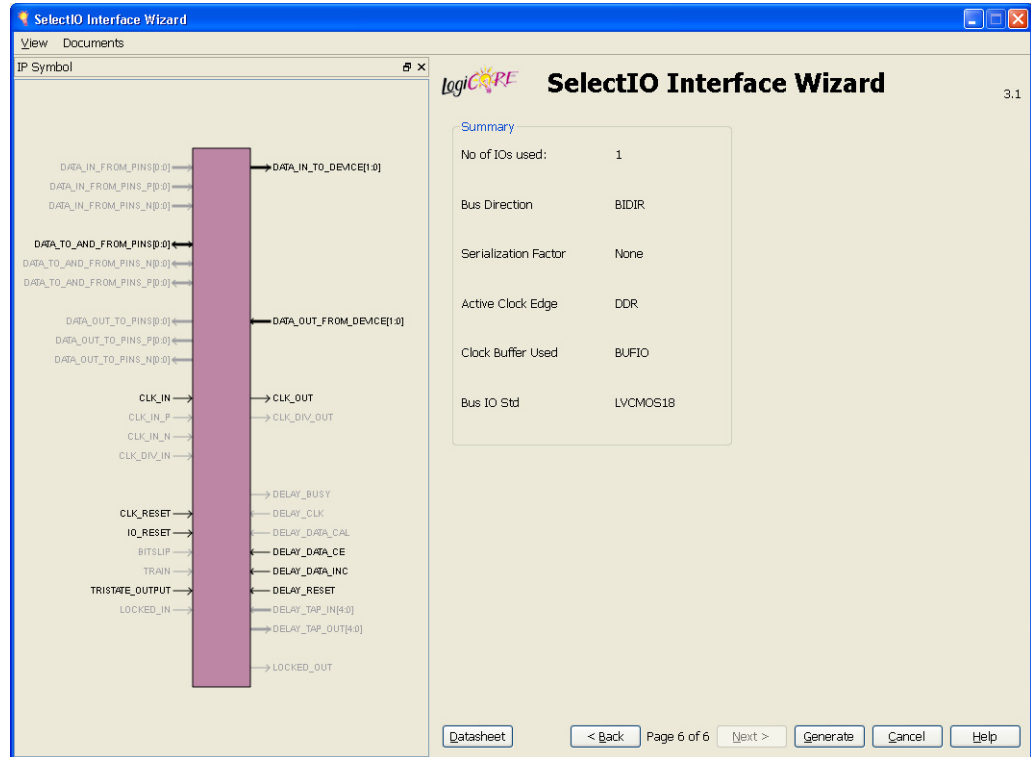

Figure 4-6: Summary - Page 6

Generating the Core

After the desired configuration parameters have been selected, you can generate the SelectIO Wizard Interface core. To do so, click the “Generate” button option that is located at the bottom of the Summary page.

Generating the Core - Spartan-6 FPGAs

This chapter describes the GUI and follows the same flow required to set up the I/O circuit, using a Spartan-6 FPGA as the target device. Tool tips are available in the GUI for most features. To access them, place your mouse over the relevant text.

For information about configuration options for Virtex-7, Kintex-7, and Virtex-6 devices, please see [Chapter 4, Generating the Core - 7 Series and Virtex-6 FPGAs](#).

Data Bus Setup

Page 1 of the GUI (Figure 5-1) allows you to set up some general features for the data bus.

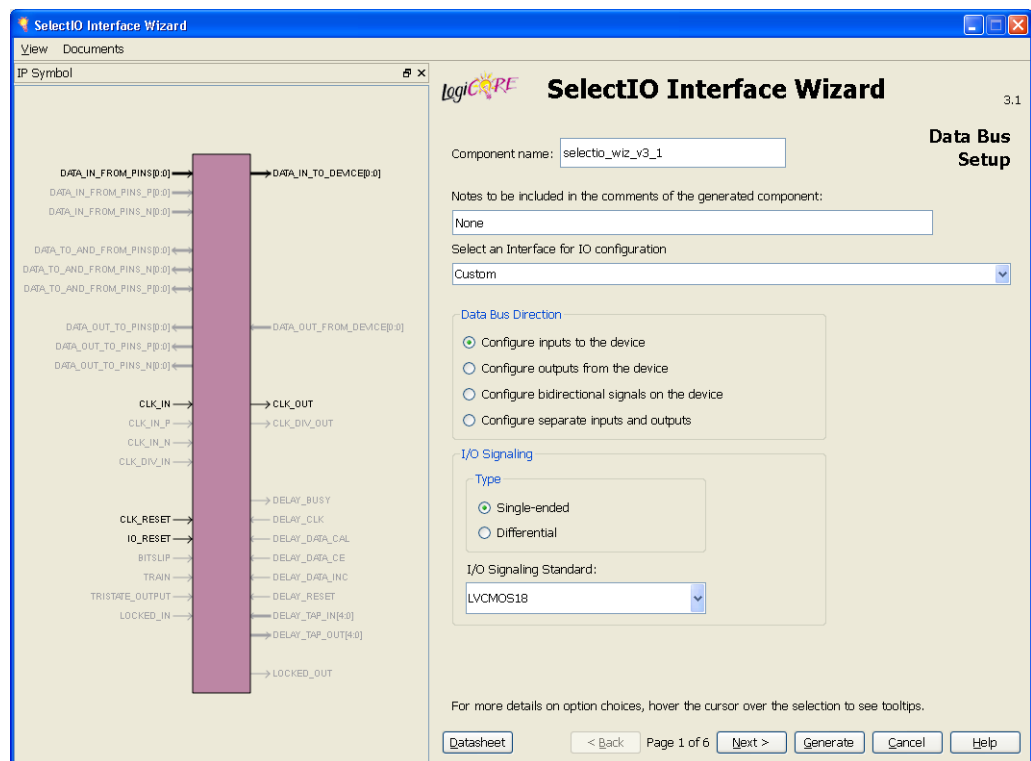

Figure 5-1: Main Screen- Data Bus Setup - Page 1

Component Name

The component name is user selectable. Component names must not contain any reserved words in Verilog or VHDL. Blank spaces are not allowed; use an underscore character instead as a separator between multiple words specified as the component name.

Interface for I/O Configuration

SelectIO Wizard has some pre-configured I/O interfaces. Choosing one of these interfaces from the drop-down menu automatically sets the necessary parameters such as data bus direction, I/O signalling, and serialization factor.

Currently the wizard supports SGMII, DVI receiver, DVI transmitter, Camera link receiver, Camera link transmitter and Chip-to-Chip interface. SelectIO Interface Wizard would only configure the data pins for all the interfaces mentioned above.

The listed options vary based on the device family selected.

Data Bus Direction

The direction of the bus can be chosen here. Only choose bidirectional if you need your bus to be bidirectional: selecting it will cause restrictions later on in the configuration process. SelectIO Wizard supports Inputs, Outputs, Bidirectional and Separate IO buses.

Separate Inputs and Outputs create independent Inputs and Outputs pins. Other configurable settings such as Serialization factor, data width, delays are common to both Inputs and Outputs i.e. if Separate Inputs and Outputs is chosen and the serialization factor is set to "5" then this serialization factor of "5" would apply to both Input SERDES as well as Output SERDES.

I/O Signaling

Choose whether your bus is single-ended or differential. Single-ended signals with a serialization factor of 4 or less will occupy half of an I/O pair. Single-ended signals with a serialization factor of 5 or more will occupy an entire I/O pair. Differential signals will be created as I/O pairs.

All I/O signaling standards are shown for the I/O signaling type that has been selected. This value will appear in the generated HDL code.

Data Bus Setup 2

Page 2 of the GUI (Figure 5-2) allows you to specify the configuration for the I/O interconnect datapath.

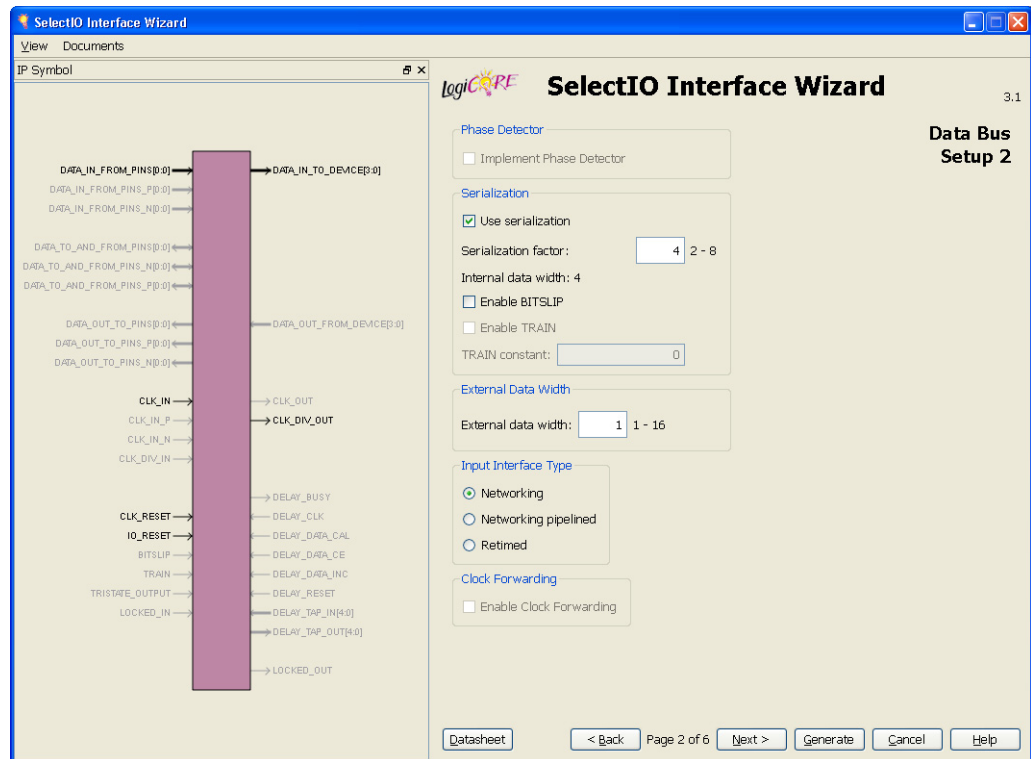

Figure 5-2: Data Bus Setup - Page 2

Phase Detector

If Implement Phase Detector is selected, the IODELAY2 and ISERDES2 will be configured for phase detector. The bus on the device side will increase by the serialization factor. Selecting this feature will instantiate a reference logic that would implement the Phase detector functionality. Selecting this option makes the wizard skip the Data Delay and Clock Delay pages. The Phase Detector box is available only when I/Os are configured as Inputs with differential I/O standard.

Serialization

If Use Serialization is selected, an ISERDES2 and/or OSERDES2 will be instantiated for the user. The bus on the device side will increase by the serialization factor. All data is collected by timeslice, then concatenated from right to left. For example, assume that the output data bus is 8-bits wide, with a serialization factor of 4. If the data is presented on the pins as: 00, 01, 02, and 03, the data presented to the device will be 03020100.

If a serialization factor of 5-8 is selected, two SERDES blocks per I/O will be instantiated for a user because each SERDES is capable of a maximum serialization of 4:1. Even if a single-ended bus was chosen, the entire I/O pair is now occupied. Once serialization is selected, BITSLLIP and TRAIN can be chosen depending on the presence of an input or output datapath. The TRAIN constant will be configured in the source code.

If the Phase Detector interface is chosen, then both ISERDES2 are instantiated.

External Data Width

You can configure the number of bits on the system side, and this will automatically be set up on the device side. Note that differential signals will occupy two pins for each data bit.

Input Interface Type

If serialization is chosen, the interface type can be configured to set to specify the timing of the data on the device side.

Clock Forwarding

Select this option if you want the SelectIO wizard to generate a clock forwarding logic. This option is only available when bus direction is Output, Bidirectional or Separate Inputs and Outputs.

Data Delay

Page 3 of the GUI (Figure 5-3) allows you to specify the type of delay for the data bus.

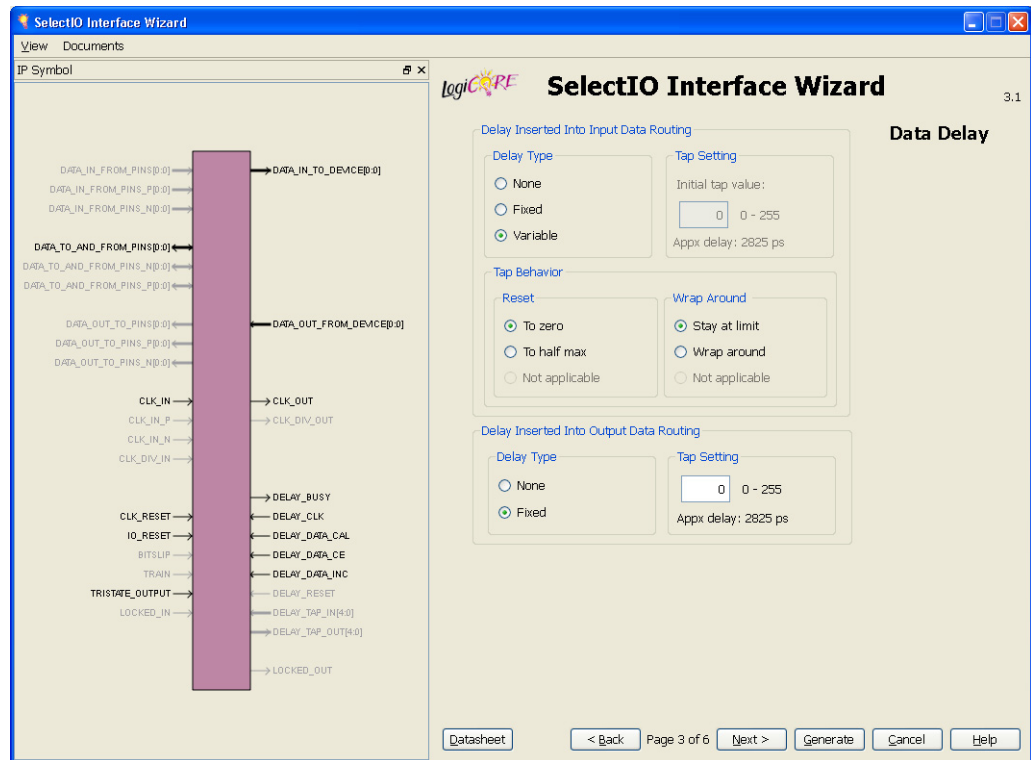

Figure 5-3: Data Delay - Page 3

Delay Type

An IODELAY2 will be instantiated if Fixed or Variable delay is chosen. Generally, if data is delayed with Fixed or Variable, delay will also be desired for the clock, given the high amount of insertion delay for the IODELAY2 primitive. The wizard will suggest delay settings for the clock based on the Data Delay settings. The tool will instantiate two IODELAY2 components when phase detector interface is chosen.

Tap Setting

If a delay is chosen, the tap value can be specified. A typical insertion delay for the value specified is shown under the Tap value box. For a variable delay, the tap value is for the initial programming. The GUI also shows the approximate delay value for tap setting. The user is expected to refer to the trace report for exact values.

Tap Behavior

If a Variable delay is chosen, the user can specify the behavior during a reset/calibration sequence, and the behavior in the event the user attempts to go past the final value in the counter.

Clock Setup

Page 4 of the GUI (Figure 5-4) allows you to configure the behavior of the clock.

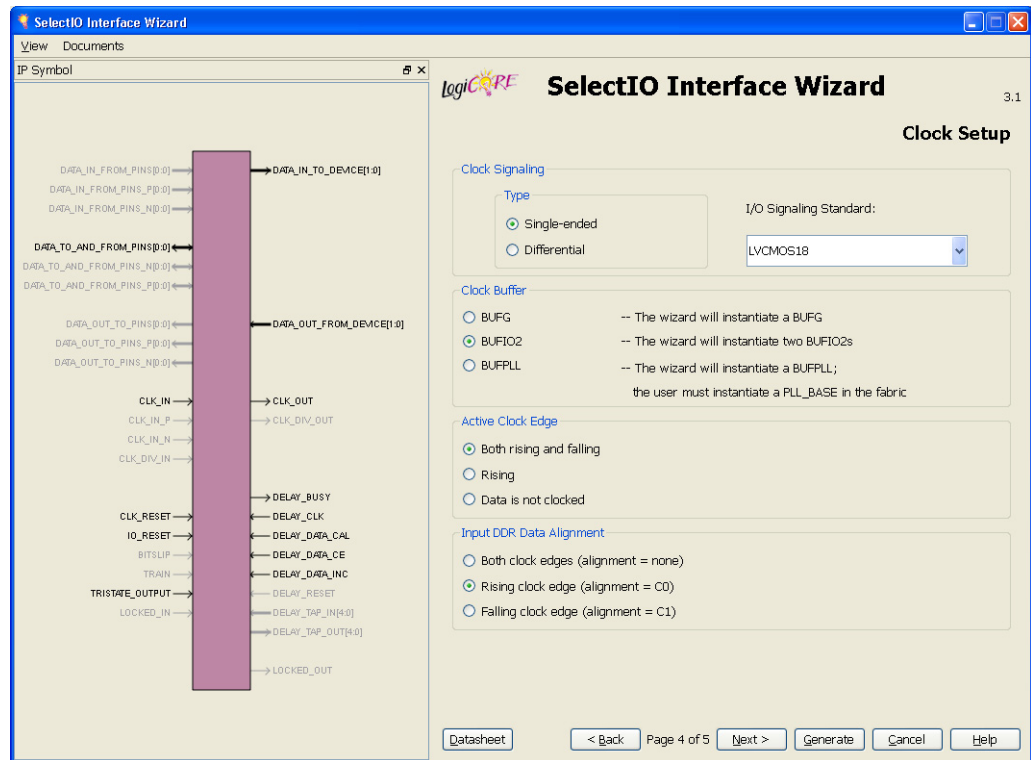

Figure 5-4: Clock Setup - Page 4

Clock Signaling

You can specify the signaling type and standard for the input clock. The I/O signaling standard will be embedded in the provided HDL source. Using double-data rate (DDR) data places some restrictions on clocks.

Clock Buffer

If your clock comes from a pin, you should leave the input buffer as a BUFIO2 for the most flexible functionality. In the event your clock comes from fabric, you will want to choose a BUFPLL, but you will need to be sure to instantiate a PLL_BASE in fabric to drive the BUFPLL. See the LogiCORE IP Clocking Wizard core and the *LogiCORE IP Clocking Wizard Getting Started Guide* for assistance with PLL_BASE instantiation and configuration.

Active Clock Edge

If using DDR data, select Both Rising And Falling. If the data requires an asynchronous delay only, select Data Is Not Clocked. In all other circumstances, leave it at the default value of Rising. If a topology is not available, you will not be able to select it. See the *Spartan-6 FPGA SelectIO Resources User Guide* and the *Spartan-6 FPGA Clocking Resources User Guide* for more information on clocking requirements.

DDR Data Alignment

If serialization is not chosen, but DDR data is chosen, the ODDR2 and IDDR2 primitives can be configured to align data to the rising, falling, or both edges of the input clock. Note that the internal data width will double, and that data will be grouped by timeslice just as is it for serialization.

Clock Delay

Page 5 of the GUI (Figure 5-5) allows you to specify the type of delay for the clock bus. Please see [Data Delay](#) for more information on the meanings of the fields within the clock delay configuration page. When using the Phase detector feature, the clock delay is set to FIXED with a tap value of 0.

- If there is no delay in the datapath, there generally should not be any delay in the clock path, choose None.
- If there is delay in the datapath, you'll generally want to match the insertion delay in the clock path, choose Fixed with a tap value of 0.

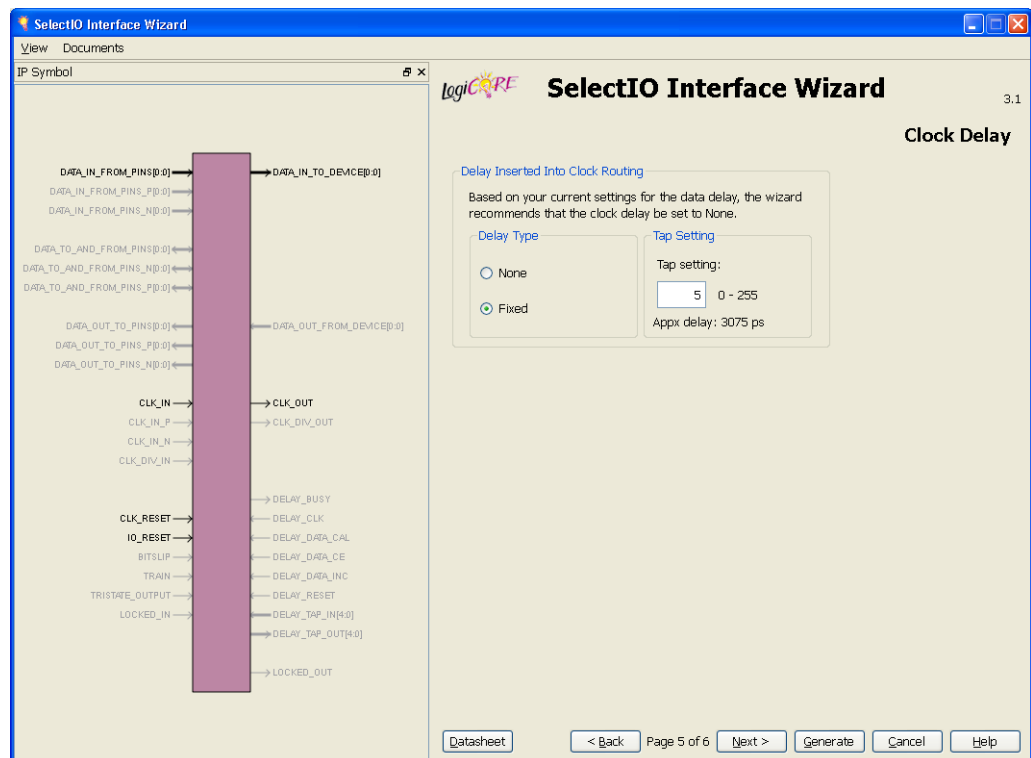

Figure 5-5: Clock Delay - Page 5

Summary Page

The summary page lists all the key parameters selected, such as the number of data I/Os, bus direction, serialization factor, buffers used, and the bus I/O standard.

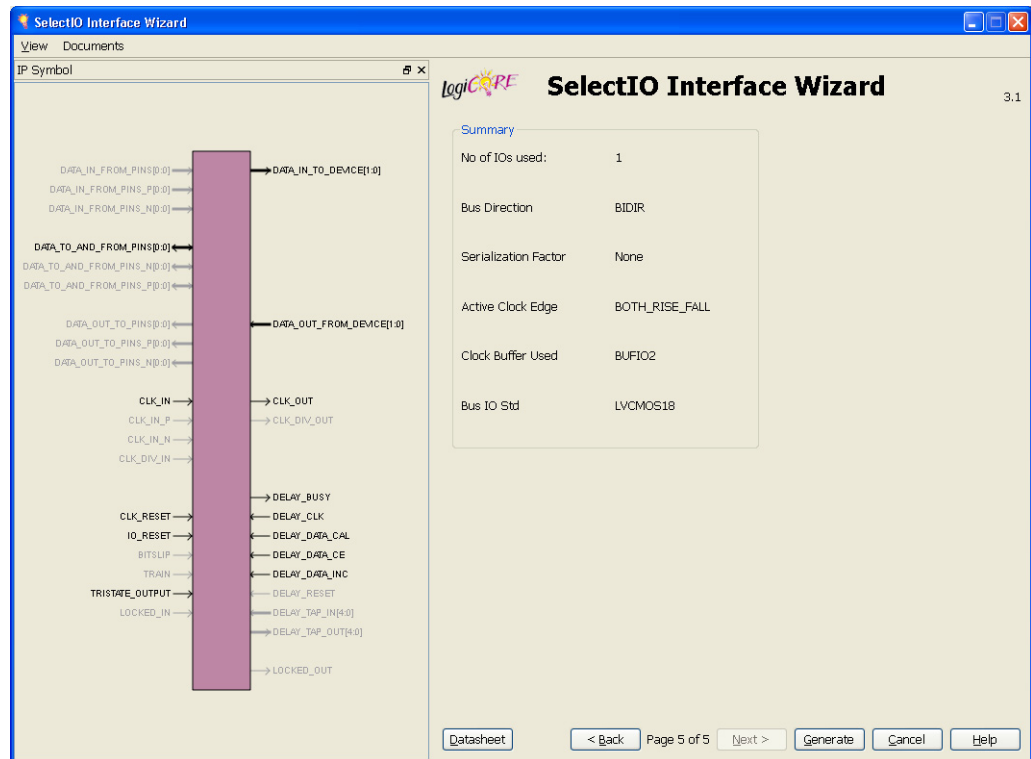

Figure 5-6: Summary - Page 6









Generating the Core

After the desired configuration parameters have been selected, you can generate the SelectIO Wizard Interface core. To do so, click the “Generate” button option that is located at the bottom of the Summary page.

Detailed Example Design

This chapter provides detailed information about the example design, including a description of files and the directory structure generated by the Xilinx CORE Generator™ tool, the purpose and contents of the provided scripts, the contents of the example HDL wrappers, and the operation of the demonstration test bench.

Directory and File Structure

-  **<project directory>**
Top-level project directory; name is user-defined
 -  **<project directory>/<component name>**
Core release notes file
 -  **<component name>/doc**
Product documentation
 -  **<component name>/example design**
Verilog and VHDL design files
 -  **<component name>/implement**
Implementation script files
 -  **implement/results**
Results directory, created after implementation scripts are run, and contains implement script results
 -  **<component name>/simulation**
Simulation scripts
 -  **simulation/functional**
Functional simulation files

Directory and File Contents

The SelectIO Interface Wizard core directories and their associated files are defined below.

<project directory>

The <project directory> contains all the CORE Generator tool project files.

Table 6-1: Project Directory

Name	Description
<project_dir>	
<component_name>.v[hd]	Verilog or VHDL source code.
phase_detector.v[hd]	Verilog or VHDL source code of phase detector implementation logic.
<component_name>.xco	CORE Generator tool project-specific option file; can be used as an input to the CORE Generator tool.
<component_name>_flist.txt	List of files delivered with the core.
<component_name>.{veo vho}	VHDL or Verilog instantiation template.
<component_name>.ise	Files used to incorporate the core into an ISE® software project.

[Back to Top](#)

<project directory>/<component name>

The <component name> directory contains the readme file provided with the core, which may include last-minute changes and updates.

Table 6-2: Component Name Directory

Name	Description
<project_dir>/<component_name>	
selectio_wizard_readme.txt	SelectIO Interface Wizard readme file.

[Back to Top](#)

<component name>/example design

The example design directory contains the example design files provided with the core.

Table 6-3: Example Design Directory

Name	Description
<project_dir>/<component_name>/example_design	
<component_name>_exdes.v[hd]	Implementable Verilog or VHDL example design, connecting the I/O circuit to a RAM.

[Back to Top](#)

<component name>/doc

The doc directory contains the PDF documentation provided with the core.

Table 6-4: Doc Directory

Name	Description
<project_dir>/<component_name>/doc	
selectio_wiz_ds746.pdf	<i>LogiCORE IP SelectIO Interface Wizard v1.5 Data Sheet</i>
selectio_wiz_gsg700.pdf	<i>LogiCORE IP SelectIO Interface Wizard v1.5 Getting Started Guide</i>

[Back to Top](#)

<component name>/implement

The implement directory contains the core implementation script files.

Table 6-5: Implement Directory

Name	Description
<project_dir>/<component_name>/implement	
Scripts and projects to implement the example design	

[Back to Top](#)

implement/results

The results directory is created by the implement script, after which the implement script results are placed in the results directory.

Table 6-6: Results Directory

Name	Description
<project_dir>/<component_name>/implement/results	
Implement script result files.	

[Back to Top](#)

<component name>/simulation

The simulation directory contains the simulation test bench for the example design.

Table 6-7: Simulation Directory

Name	Description
<project_dir>/<component_name>/simulation	
<component_name>_tb.v[hd]	Demonstration test bench.

[Back to Top](#)

simulation/functional

The functional directory contains functional simulation scripts provided with the core.

Table 6-8: Functional Directory

Name	Description
<project_dir>/<component_name>/simulation/functional	
	Contains simulation scripts and waveform formats.

[Back to Top](#)

Implementation Scripts

The implementation script is either a shell script or batch file that processes the example design through the Xilinx tool flow. It is located at:

UNIX

```
<project_dir>/<component_name>/implement/implement.sh
```

Windows

```
<project_dir>/<component_name>/implement/implement.bat
```

The implement script performs the following steps:

- Synthesizes the HDL example design files using XST
- Runs Ngdbuild to consolidate the core netlist and the example design netlist into the NGD file containing the entire design
- Maps the design to the target technology
- Place-and-routes the design on the target device
- Performs static timing analysis on the routed design using Timing Analyzer (TRCE)
- Generates a bitstream
- Enables Netgen to run on the routed design to generate a VHDL or Verilog netlist (as appropriate for the Design Entry project setting) and timing information in the form of SDF files

The Xilinx tool flow generates several output and report files. These are saved in the following directory which is created by the implement script:

```
<project_dir>/<component_name>/implement/results
```

Simulation Scripts

Functional Simulation

The test scripts are a ModelSim, IUS, VCS, or ISIM macro that automate the simulation of the test bench. They are available from the following location:

```
<project_dir>/<component_name>/simulation/functional/
```

The test script performs the following tasks:

- Compiles the structural UniSim simulation model
- Compiles HDL Example Design source code
- Compiles the demonstration test bench
- Starts a simulation of the test bench
- Opens a Wave window and adds signals of interest
- Runs the simulation to completion

Example Design

Top Level Example Design

The following files describe the top-level example design for the SelectIO Interface Wizard core.

VHDL

```
project_dir>/<component_name>/example_design/<component_name>_exdes.vh  
d
```

Verilog

```
project_dir>/<component_name>/example_design/<component_name>_exdes.v
```

The top-level example design adds a RAM on the user side of the I/O. In the event that a BUFPLL is chosen as the clocking primitive, it also instantiates and configures the required PLL_BASE. This allows the entire design to be synthesized and implemented in a target device to provide post place-and-route gate-level simulation.

Customizing the Example Design

The example design features parameters such as RAM size. By changing the parameters, the RAM can be increased or decreased in size. Initialization values can also be added to the RAM in the example design, rather than requiring that the RAM be loaded with values during operation.

Demonstration Test Bench

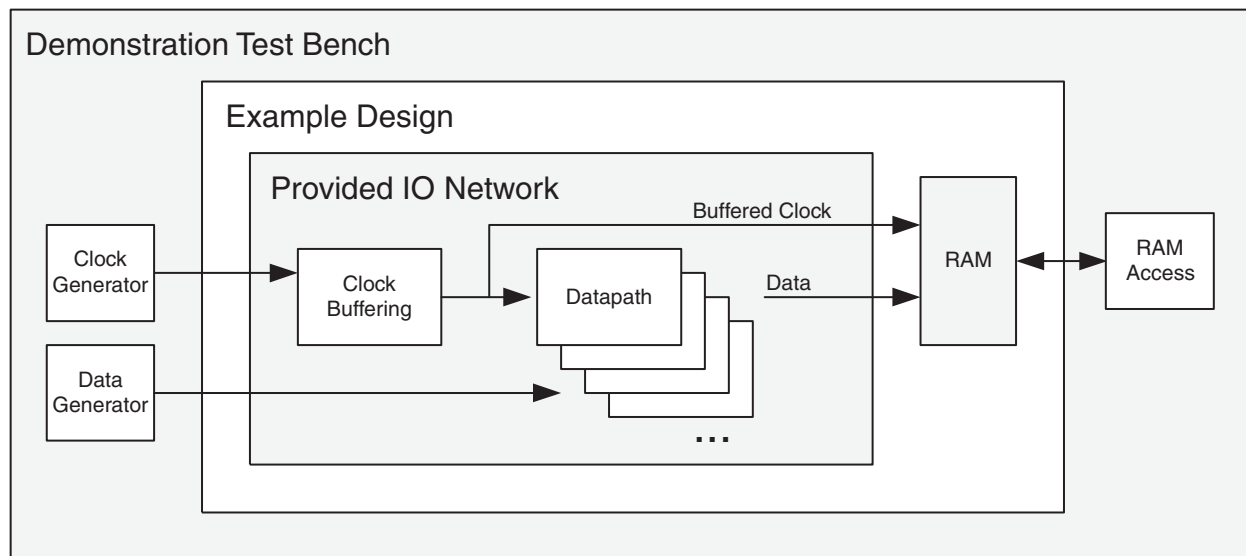

Figure 6-1: Demonstration Test Bench for the SelectIO Interface Wizard Core and Example Design

The following files describe the demonstration test bench.

VHDL

```
project_dir>/<component_name>/simulation/<component_name>_tb.vhd
```

Verilog

```
project_dir>/<component_name>/simulation/<component_name>_tb.v
```

The demonstration test bench is a simple VHDL or Verilog program to exercise the example design and the core.

The demonstration test bench performs the following tasks:

- Generates input clock signals
- Applies a reset to the example design
- For an output only design, the example design memory is pre-loaded with data
- For a design with an input path, data is driven onto the pins and received in the memory
- For a design with bidirectional ports, the I/O input logic is reconfigured to be outputs
- For a design with an output path, data read from the memory and driven out on the pins