

Mälardalen University Press Dissertations  
No. 200

# **LOW ENERGY BUILDINGS EQUIPPED WITH HEAT PUMPS FOR HIGH SELF-CONSUMPTION OF PHOTOVOLTAIC ELECTRICITY**

**Richard Thygesen**

**2016**



School of Business, Society and Engineering

Copyright © Richard Thygesen, 2016  
ISBN 978-91-7485-255-4  
ISSN 1651-4238  
Printed by Arkitektkopia, Västerås, Sweden

Mälardalen University Press Dissertations  
No. 200

LOW ENERGY BUILDINGS EQUIPPED WITH HEAT PUMPS FOR  
HIGH SELF-CONSUMPTION OF PHOTOVOLTAIC ELECTRICITY

Richard Thygesen

Akademisk avhandling

som för avläggande av teknologie doktorsexamen i energi- och miljöteknik vid  
Akademin för ekonomi, samhälle och teknik kommer att offentligen försvaras  
fredagen den 29 april 2016, 09.15 i Delta, Mälardalens högskola, Västerås.

Fakultetsopponent: Docent Joakim Widén, Uppsala Universitet



Akademin för ekonomi, samhälle och teknik

## Abstract

The building sector is a prioritized area in the European Unions (EU) ambition to reduce the total final energy use by 20 %; lower the emission of greenhouse gases by 20 % and using energy 20 % more efficient by 2020. The residential sector in the European Union accounts for 27% of the union's final energy use and the EU views decentralized energy generation and heat pumps as important measures in reducing the energy demand in the building sector.

In recent years a rapid decrease in photovoltaic system prices has led to a growing popularity in Sweden. This fact in combination with a large increase of heat pump systems in residential buildings the last decade makes a combination of heat pumps and solar energy systems an interesting system configuration to analyze. In addition, the electricity price structure in Sweden and the uncertainty of the sustainability of the Swedish solar energy support schemes makes the topic of self-consumption an important research area.

Different solar energy systems for residential buildings and two different storage technologies, batteries and hot water storage tanks, have been analyzed with regards to profitability, solar energy fraction and self-consumption levels.

The results suggest that the system with a heat pump in combination with a photovoltaic system can be profitable and have high solar energy fractions and high levels of self-consumption and that the systems with storage are not profitable but give high levels of self-consumption and relatively high solar energy fractions. The hot water storage gives almost as high level of self-consumption as batteries but have half of the batteries leveled cost of electricity.

A system with a ground source heat pump and a solar thermal system are ineffective, unprofitable and give low solar energy fractions.

A system with a weather forecast controller gives a small increase in self-consumption and is unprofitable.

The proposed near energy zero building definition proposed by the Swedish National Board of Housing, Building and Planning in 2015 is unclear in terms of what electrical load the PV electricity reduces in the building. This has a fairly large impact on the building specific energy demand.

*Till Annica , Wilmer och Nora*

# Summary

The building sector is a prioritized area in the European Union's (EU) ambition to reduce total final energy use by 20 %; lower the emission of greenhouse gases by 20 % and use energy 20 % more efficiently by 2020, with 1990 as the starting year. The residential sector in the European Union accounts for 27% of the Union's final energy use and the EU views decentralised energy generation and heat pumps as important measures in reducing the energy demand in the building sector, despite an increasing building construction rate.

In recent years a rapid decrease in photovoltaic system prices has led to a growing popularity in Sweden. This fact, in combination with a large increase of heat pump systems in residential buildings in the last decade, makes a combination of heat pumps and solar energy systems an interesting system configuration to analyze. In addition, the electricity price structure in Sweden and the uncertainty of the sustainability of the Swedish solar energy support schemes makes the topic of self-consumption an important research area.

Different solar energy systems for residential buildings and two different storage technologies, batteries and hot water storage tanks, have been analysed with regards to profitability, solar energy fraction and self-consumption levels.

The results suggest that a system with a heat pump in combination with a photovoltaic system can be profitable and have high solar energy fractions and high levels of self-consumption. The systems with storage are not profitable but give high levels of self-consumption and relatively high solar energy fractions. The hot water storage gives almost as high level of self-consumption as batteries but have half of the batteries levelized cost of electricity.

A system with a ground source heat pump and a solar thermal system is ineffective, unprofitable and gives low solar energy fractions. The main reason for this is that the solar thermal energy delivered to the building during the summer covers the domestic hot water demand and the heat pump is then switched off. The solar thermal energy then saves the electricity that would have been used by the heat pump if it supplied the domestic hot water and also heat that would have been extracted from the ambience would be saved. The latter part is regarded as costless energy and reduces profitability of the system combination.

A system with a weather forecast controller gives a small increase in self-consumption and is unprofitable. This is due to the fact that the cost for the controller and data subscriptions is higher than the cost saved.

The proposed near zero energy building definition is unclear in terms of what electrical load the PV electricity reduces in the building. If it is assumed that the PV electricity saves electricity purchased for heating every kWh of PV electricity is reducing 2.5 kWh of the building specific energy demand. If it is assumed that the PV electricity saves electricity purchased to be used for building services, 1 kWh of PV electricity reduces the building specific energy demand by 1 kWh. This difference in the electricity value and what electricity usage the PV electricity is assumed to save has a fairly large impact on the building specific energy demand.

# Sammanfattning

Byggsektorn är ett prioriterat område inom EU som planerar att sänka den totala energianvändningen med 20 %, utsläppen av växthusgaser med 20 % och använda energi 20 % mer effektivt till 2020. Bostadssektorn i EU står för 27 % av unionens slutliga energianvändning.

Under senare år har en snabb minskning av solcellssystempriset resulterat i en växande popularitet i Sverige och detta faktum i kombination med att det har skett en stor ökning av värmepumpsystem i bostäder i Sverige det senaste årtiondet leder till att värmepump i kombination med solenergisystem är intressanta systemkombinationer att analysera.

Olika solenergisystem för bostadshus och två olika lagringstekniker, batterier och ackumulatortank för lagring av solel, har analyserats med avseende på lönsamhet, solenergiandel och egenanvändning och analysen visar att ett lågenergihus med en bergvärmepump i kombination med ett solcellssystem kan vara lönsamt och ha hög solenergiandel och höga nivåer av egenanvändning. Analysen visar också att systemen med energilagring inte är lönsamma men ger höga nivåer av egenanvändning och relativt höga solenergiandelar. Ackumulatortanksystemet ger nästan lika hög nivå av egenanvändning som batterisystemet men har hälften av batteriernas produktionskostnad. Ett system med en bergvärmepump och en solvärmeanläggning är ineffektiv, olönsam och ger låg solenergiandel. Den främsta orsaken till detta är att den solvärme som levereras till byggnaden under sommaren täcker hela varmvattenbehovet vilket leder till att värmepumpen är avstängd. Solvärmens sparar då den el som skulle ha använts av värmepumpen om den levererade tappvarmvatten och även värme som skulle ha hämtats från omgivningen. Den senare delen betraktas som gratisenergi och minskar systemkombinationens lönsamheten.

Ett värmepumpsystem som styr med via väderprognosstyrning ger låg ökning av egenanvändning av solel och är olönsam.

Den föreslagna nära nollenergibyggnadsdefinitionen leder till osäkerhet om vilken elektrisk last solelen minskar. Om solelen antas spara köpt el för uppvärmning reducerar varje kWh solel byggnadens specifika energibehov med 2.5 kWh. Om det antas att solelen sparar köpt el som används till fastighetsel reducerar 1 kWh solel byggnadens specifika energibehov med 1 kWh. Denna skillnad i hur el värderas för olika användningsområden och vad solelen antas reducera resulterar i en relativt stor skillnad i specifik energianvändning.



# Acknowledgements

I would like to express my deepest gratitude to my supervisor Björn Karlsson for all his support, sharing of knowledge and interesting discussions during these 4 ½ years. Iana Vassileva, Fredrik Wallin and Robert Öman my three co-supervisors, should also be acknowledged and thanked for all their support.

All colleagues at The School of Business, Society and Engineering also deserve a huge thank you for making these 4 ½ years a period full of laughter and interesting discussions.

The generous funding for my doctoral studies has been obtained from the Swedish Energy Agency. For this I am deeply grateful.

Last, but not least, I would like to thank my dear family for all their support and love. Without you this journey would not have been possible. Utan ert stöd skulle denna resa varit omöjlig att slutföra!

# List of Papers

This thesis is based on the following papers, which are referred to in the text by their Roman numerals.

- I. Thygesen, R., Karlsson, B. (2013) Economic and energy analysis of three solar assisted heat pump systems in near zero energy buildings. *Energy and Buildings*, 66:77–87.
- II. Thygesen, R., Karlsson, B. (2014) Simulation and analysis of a solar assisted heat pump system with two different storage types for high levels of PV electricity self-consumption. *Solar Energy*, 103:19–27.
- III. Thygesen R., Karlsson B. (2016) Simulation of a proposed novel weather forecast control for ground source heat pumps as a mean to evaluate the feasibility of forecast controls' influence on the photo-voltaic electricity self-consumption. *Applied Energy*, 164:579–589.
- IV. An analysis on how the proposed Swedish requirements for near zero energy buildings manages PV electricity in combination with two different types of heat pumps. Submitted to journal.

Reprints were made with permission from the respective publishers.

## Author's contribution

In paper I to IV all of the simulations, simulation data processing, data analysis and most of the writing were performed by the author of this thesis.

# Contents

1.	Introduction .....	1
1.1	Background.....	1
1.2	Objectives and research questions.....	2
1.3	Short summary of appended papers.....	3
2.	The Swedish Energy system.....	4
3.	Buildings as energy systems.....	5
3.1	Buildings and Swedish regulations.....	5
3.2	Heating, ventilation and air-conditioning (HVAC) systems .....	8
3.2.1	Heat pump systems.....	8
3.2.2	Ventilation systems .....	10
3.3	Solar energy systems .....	12
3.3.1	Regulations and incentives in Sweden .....	12
3.3.2	PV systems .....	12
3.3.3	Solar thermal systems.....	15
3.4	Energy storage systems .....	16
3.4.1	Battery systems.....	16
3.4.2	Hot water storage.....	17
3.5	Swedish electricity price structure.....	17
4.	Literature review.....	19
4.1	Knowledge gaps .....	21
5.	Methodology.....	22
5.1	Transient simulations.....	22
5.2	Energy balance for the simulated reference building .....	23
5.3	Economic calculations.....	23
6.	Description of scenarios and simulation models .....	26
6.1	Scenarios.....	26
6.2	Simulation models .....	27
7.	Results and discussion .....	32
7.1	Analysis and evaluation of different solar energy systems.....	32
7.2	Analysis and evaluation of different energy storage systems.....	37
7.3	Analysis of a weather forecast control for GSHP .....	39
7.3.1	Reference control.....	39

7.3.2	Weather forecast control.....	39
7.4.	Analysis of how the proposed Swedish definition of near zero energy buildings manages PV electricity .....	43
8.	Conclusions .....	49
9.	Future work.....	51
	References.....	52
	Appendices.....	56
	Appendix 1: Trnsys types .....	56
	Appendix 2: Building description.....	59
	Papers.....	61

# List of figures

Figure 1.	Building regulation boundary.....	6
Figure 2.	Heat pump cycle.....	9
Figure 3.	Different types of ventilation systems.....	11
Figure 4.	PV system schematics.....	13
Figure 5.	Annual installed PV and solar thermal power in Sweden. .....	14
Figure 6.	Solar thermal system schematics.....	16
Figure 7.	Electricity cost divided into its different parts.....	18
Figure 8.	Energy balance of the studied system.....	23
Figure 9.	System schematics of one of the simulated systems.....	28
Figure 10.	DHW energy and household electricity demand.....	30
Figure 11.	Household electricity demand.....	30
Figure 12.	Installed PV power in relation to saved electricity in the building with different metering schemes.....	33
Figure 13.	Monthly electricity demand of the building and PV system yield.....	34
Figure 14.	PV electricity self-consumption in relation to installed battery capacity.....	38
Figure 15.	Weather forecast controller mathematical flow chart.....	40
Figure 16.	Reference and forecast control output values.....	41
Figure 17.	Annual duration of PV electricity self-consumption.....	42
Figure 18.	Sensitivity analysis of the discount rate, annual cost and annual electricity price change.....	43
Figure 19.	Different electricity loads in the building.....	45
Figure 20.	Specific energy demand with different PV-system sizes.....	46
Figure 21.	Fraction of annual electricity usage for heat pump operation.....	47

# List of tables

Table 1.	Current building regulations (BBR) and proposed NZEB definition.....	7
Table 2.	Main components and metering schemes of the simulated scenarios. ....	27
Table 3.	Building component's U-value.....	29
Table 4.	Annual energy demand for the simulated building.....	29
Table 5.	Annual yield in comparison with tilt 45° and azimuth south (%). ....	31
Table 6.	Building purchased energy demand with different system configurations. ....	35
Table 7.	Profitability and solar energy fraction of all system configurations. ....	36
Table 8.	LCOE, self-consumption and solar energy fraction for the different storage systems. ....	39
Table 9.	Self-consumption, self-consumption fraction and solar energy fraction of the models with different control strategies and DHW storage sizes.....	42
Table 10.	Specific energy demand, self-consumption fraction and solar energy fraction for the different heat pump types and cases with a 5.29 kWp PV system. ....	48

# Abbreviations

BBR	Swedish building regulations (Boverkets Byggregler)
COP <sub>1</sub>	Coefficient of performance for heating
COP <sub>2</sub>	Coefficient of performance for cooling
DF	Discount factor
DHW	Domestic hot water
DOD	Depth of discharge
DSM	Demand side management
EAHP	Exhaust air heat pump
EU	European Union
EUR	Euro, €
GSHP	Ground source heat pump
HRV	Heat recovery ventilation
HVAC	Heating, ventilation and air-conditioning
LCOE	Levelized cost of electricity (EUR/kWh)
NPV	Net present value
NZEB	Net Zero Energy Building
PV	Photovoltaic
PV/T system	Photovoltaic/thermal system
SCOP	Seasonal coefficient of performance
VAT	Value added tax

# Nomenclature

$A_{temp}$	Living area heated to 10 °C or more
$C_t$	Net cost of project for year t (EUR)
$d$	Annual degradation of PV modules (%)
$DF$	Discount factor
$E_{building\ services}$	Other energy than electricity used for building services, eg. fans and pumps etc.
$E_{cooling}$	Other energy than electricity used for cooling
$E_{DHW}$	Other energy than electricity used for domestic hot water
$E_{Elec, building\ services}$	Electricity used for building services, eg. fans and pumps etc.
$E_{Elec, cooling}$	Electricity used for cooling
$E_{Elec, DHW}$	Electricity used for DHW
$E_{Elec, heating}$	Electricity used for heating
$E_{heating}$	Other energy than electricity used for heating
$E_k$	Electricity to the compressor (kW)
$EP_t$	Electricity price at year t (EUR)
$E_{spec}$	Building specific energy demand
$I$	Inflation (%)
$I_c$	Investment cost (EUR)
$Q_1$	Heat power output (kW)
$Q_2$	Heat power absorption (kW)
$R$	Nominal discount rate (%)
$r_r$	Real discount rate (%)
$S_t$	PV system energy output of year t (kWh)
$T$	Life time of the system (Year)
$t$	Year t



# 1. Introduction

## 1.1 Background

Research and development in the topics of low energy buildings and solar energy systems have gained a lot of attention during the last few years, mainly due to national and international directives and policies combined with more affordable prices. One of the most important targets European countries have committed to is the 20-20-20 goal: 20 % reduction in greenhouse gas emissions, 20 % increase in use of renewable energy sources and 20 % cut in energy consumption through improved energy efficiency by the year 2020 compared to 1990 (EU, 2009a, EU, 2009b and EU, 2012a).

One of the main prioritized areas for the EU in meeting these goals is residential buildings that account for almost 27% of the EU's final energy demand (EU, 2012b). In order to limit a growing energy demand in buildings the EU has implemented the directive on the energy performance of buildings in 2002 (EU, 2010) which strongly focuses on decentralized renewable energy production. The directive also demands that every member country develops its own near zero energy building (NZEB) definition and implements it in the national building regulations.

In order to promote renewable sources of energy, some of the European countries have started generous incentive programs for installation and energy production from renewable energy sources, mainly solar and wind power.

However, due to the recent financial crisis and a larger than expected growth of renewable energy sources, many EU countries have been forced to reduce the incentives and in some cases even terminate such programs. Denmark, for example, changed its net metering policy from annual net metering to hourly net metering in 2013. Additionally, concerns about the impact that many small scale electricity production systems might have on the electricity grid has made research on self-consumption relevant.

In Sweden, self-consumption will be an important topic in the future when the tax deduction incentive program is phased out. In addition, the system investment cost incentive for photovoltaics (PV) has gradually been lowered as system prices have decreased and the sustainability of the incentive program is difficult to assess.

During the last decade there has been a significant increase in the number of heat pumps installed in residential buildings in Sweden (Swedish Heat Pump Association (SVEP), 2013). The most common heat pumps installed are

the air/air type which are mainly used as complementary heating. Air/water and Ground source heat pumps (GSHP) are also frequently used but as the main heat source in buildings.

Due to all the previously mentioned reasons, the combination of heat pumps and PV systems becomes an important way of reducing the purchased energy in residential buildings, especially in new buildings, where the energy demands with regards to heating and domestic hot water (DHW) are low and investment costs for other heating technologies are high.

## 1.2 Objectives and research questions

The first objective of this thesis was to find the solar energy system that can be combined with a GSHP in a low-energy, one-family residential building with different metering schemes. The chosen system is referred to as the reference system and it was chosen based on profitability and solar energy fraction of the system. The different systems examined are a PV-system, a solar thermal system and a combination of the two.

The second objective was to compare the reference system supplemented with two different storage systems and find out which gives the highest profitability in combination with the highest level of PV electricity self-consumption.

The third objective was to analyze how a GSHP with a weather forecast control affects the self-consumption of the reference system and if the controller is profitable and the fourth objective was to compare how the proposed Swedish NZEB definition manages PV electricity in the reference system building and in a modified reference system where the GSHP has been substituted with an exhaust air heat pump (EAHP).

The following specific research questions were addressed in the included papers:

**RQ 1:** Which solar energy system (PV or solar thermal) is the most profitable and has the highest solar energy fraction with the different metering schemes? (Paper I)

**RQ 2:** Which storage system gives the highest level of self-consumption and is it profitable? (Paper II)

**RQ 3:** How much will the self-consumption increase due to the weather forecast control of the ground source heat pump and is it profitable? (Paper III)

**RQ 4:** Which of the analyzed heat pump types has the highest self-consumption- and solar energy-fraction of PV electricity and how does it affect the building specific energy demand? (Paper IV)

**RQ 5:** What factors affect the self-consumption of PV electricity in buildings with heat pumps? (Paper IV)

## 1.3 Short summary of appended papers

Abstracts of all appended papers are included in this chapter.

### **Paper I:**

In this paper a GSHP system was complemented with three different solar energy system configurations and three different net metering schemes. The different configurations are, a PV-system, a solar thermal system and a combination of a PV and a solar thermal system.

An analysis of the systems with focus on economics and energy suggested that the PV system configuration was the only system that had profitability potential if combined with a monthly net metering scheme. The profitable system has a GSHP with a heating capacity of 5.8 kW and a PV-system of 5.19 kW<sub>p</sub> tilted 70° and facing south.

### **Paper II:**

In paper II the system from paper I with a GSHP and a PV system was complemented with two different storage systems, lead acid batteries and hot water storage and the self-consumption of the systems was analyzed. The battery system was sized to store PV electricity surplus from one day.

The analysis of the system suggested that both storage technologies had almost the same self-consumption fraction but that the hot water storage had half the levelized cost of electricity (LCOE) compared to the lead acid battery system.

### **Paper III:**

The system from paper I that was also slightly modified and used in paper II was also used in this paper.

The system is complemented with a weather forecast controller that manipulates the hot water set point in the GSHP. The objective of this paper is, among other things to analyze how much the self-consumption is increased because of the controller. The results suggest only a modest increase of 7 percentage points compared to the system without the novel controller.

### **Paper IV:**

The system used in paper I and modified in paper II was also used in this paper. In this paper an analysis was conducted on how the proposed Swedish near zero energy building handles PV electricity and how the specific energy demand of the building is affected.

The result suggests that different assumptions can affect the specific energy demand in a fairly substantial way.

## 2. The Swedish Energy system

The total energy usage in Sweden 2013 amounted to 375 TWh of which 140 TWh was electricity usage. Of the total delivered energy during 2013, 34 % came from nuclear power, 30 % from fossil fuels, 23 % from bio fuels, 11 % from hydro power and 2 % from wind power. The total delivered electricity during 2013 was divided between 43 % nuclear power, 43 % hydro power, 7 % wind power and 10 % combustion based power.

In the building and service sector a total of 147 TWh was used, of which 80 TWh was used for heating and DHW. 19 Of the 80 TWh used for heating and DHW, 19 TWh was electricity.

In one-family buildings electricity heating is most common and this can in part be explained by the large increase in heat pumps. Just above 50 % of all one-family buildings in Sweden have a heat pump installed and around 35 % have a heat pump installed that acts as the main heating system. Approximately 20 % of all one family buildings have a GSHP installed.

If buildings with a GSHP are also equipped with a PV-system, the purchased electricity can be decreased by up to 28 %. If the building is also equipped with an energy storage system, the purchased energy can be decreased by up to 45%. This is presented in more detail in chapter 7.2.

A rough estimate of the potential saving on a national scale suggests that between 1 TWh and 1.7 TWh of purchased energy can be saved if all GSHPs were combined with a PV-system. This is equal to between 0.8 % and 1.4 % of the total electricity use in Sweden.

If the results for GSHPs are also valid for other types of heat pumps the potential reduction in purchased energy is between 1.9 TWh and 3 TWh, which is equivalent to between 1.5 % to 2.4 % of the total electricity use in Sweden. However, the majority of the reduction in purchased energy occurs during summer when energy is abundant.

Both potential savings for GSHP's and all forms of heat pumps is high and it should only be seen as a best case potential. For the potential to be realized, the installed PV peak power has to be increased between 15 and 70 times in comparison with the total cumulative installed PV peak power in December 2014. The probability of this potential being realized in the near future is small.

### 3. Buildings as energy systems

#### 3.1 Buildings and Swedish regulations

In the current Swedish building regulations (BBR) the term specific energy demand of the building is used as the main requirement. It is defined as the building energy demand divided by the area of the building that is heated to at least 10 °C. Included in the building energy demand is the energy used for heating, DHW production, cooling and building services (fans, pumps etc.). Only purchased energy is included in the specific energy demand and the system boundaries for the building regulations are presented in figure 1.

The specific energy demand calculation in the current BBR is presented in equation 1.

$$E_{spec} = (E_{Heating} + E_{DHW} + E_{Cooling} + E_{building\ Services})/A_{temp} \quad (1)$$

where

$E_{spec}$	Building specific energy demand
$E_{heating}$	Electricity used for heating
$E_{DHW}$	Electricity used for DHW
$E_{cooling}$	Electricity used for cooling
$E_{building\ services}$	Electricity used for building services, eg. fans and pumps etc.
$A_{temp}$	Living area in the building heated to 10 °C or more.

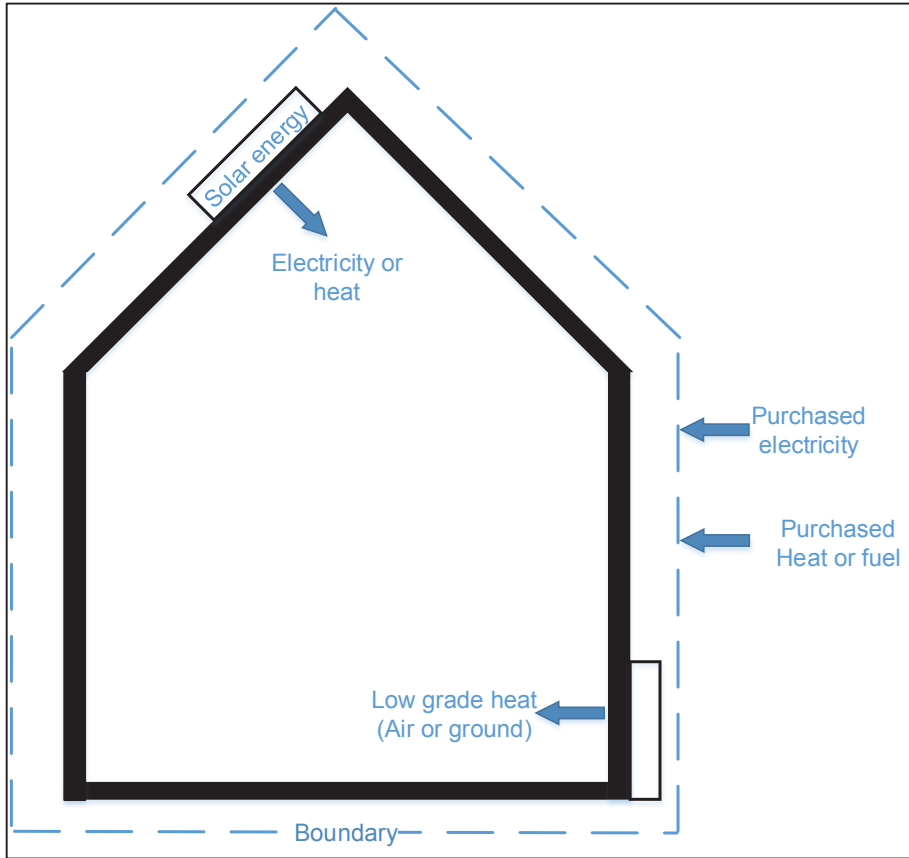

Figure 1. Building regulation boundary.

All requirements included in the energy chapter of the current building regulation and in the proposed NZEB definition are presented in table 1.

Table 1. Current building regulations (BBR) and proposed NZEB definition.

	BBR	Proposed NZEB definition	Simulated building
Specific energy demand (kWh/m <sup>2</sup> )	55	80*	37(73)**
Installed electrical power for heating (kW)	4.5	Unknown	3
Overall average heat transfer coefficient of the building (W/m <sup>2</sup> K)	0.4	0.4	0.13

\*80 kWh/m<sup>2</sup> is the new limit but it is calculated differently than current regulations and therefore the old and new values should not be compared.

\*\*37 kWh/m<sup>2</sup> is the value if calculated as defined in the present BBR and 73 kWh/m<sup>2</sup> as calculated with the new NZEB definition.

According to the directive on the energy performance of buildings, all public authority used or owned buildings built after 2018, and all other buildings built after 2020, must be near zero energy buildings (EU, 2010) and therefore the Swedish National Board of Housing, Building and Planning has developed a proposal on a national NZEB definition. As with the current building regulations the new proposal is based on purchased energy (Boverket, 2013).

The proposed NZEB definition is based on different weighing factors for different usages of energy. Electricity used for heating, cooling or DHW has a weighing factor of 2.5, electricity used for building services (fans in the HRV etc.) has a weighing factor of 1 and household electricity is not included in the specific energy demand. Fuel used in the building has a weighing factor of 1 as all other energy, except electricity, used for heating, cooling or DHW.

The specific energy demand is calculated in accordance with equation 2.

$$E_{spec} = ((E_{Elec,heating} + E_{Elec,DHW} + E_{Elec,Cooling}) \times 2.5 + E_{Elec,building\ Services} + E_{Heating} + E_{DHW} + E_{Cooling})/A_{temp} \quad (2)$$

where

$E_{spec}$	Building specific energy demand
$E_{Elec,heating}$	Electricity used for heating
$E_{Elec,DHW}$	Electricity used for DHW
$E_{Elec,cooling}$	Electricity used for cooling

$E_{\text{Elec, building services}}$	Electricity used for building services, eg. fans and pumps etc.
$E_{\text{heating}}$	Other energy than electricity used for heating
$E_{\text{DHW}}$	Other energy than electricity used for DHW
$E_{\text{cooling}}$	Other energy than electricity used for cooling
$A_{\text{temp}}$	Living area heated to more than 10°C

The simulated building in this thesis achieves the requirements according to the proposed NZEB definition and to the present BBR. The BBR and proposed NZEB requirements is presented in table 1.

Details regarding the simulated building can be found in chapters 5 and 6 and in appendix 2.

## 3.2 Heating, ventilation and air-conditioning (HVAC) systems

### 3.2.1 Heat pump systems

A heat pump utilizes heat at low temperatures by heating a refrigerant with a low boiling point. When the refrigerant is heated in the evaporator, it evaporates and is circulated through the compressor where the pressure and temperature are increased. After the compressor, the evaporated refrigerant is then transported to a condenser where the heat is exchanged with the fluid in the hydronic system. The refrigerant liquefies in the condenser but still has a fairly high pressure. It is transported through an expansion valve where the pressure of the refrigerant is reduced. The thermostatic expansion valve expansion valve controls the flow to the evaporator. This kind of expansion valve is common in smaller heat pumps for one-family buildings. The principle heat pump cycle is presented in figure 2.



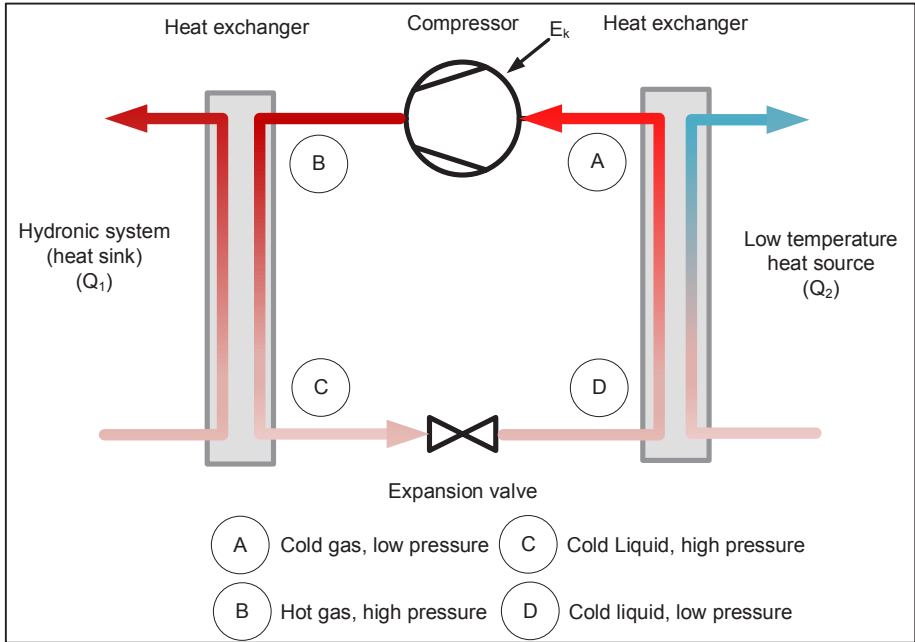

Figure 2. Heat pump cycle.

Compressor cooling machines work with the same cycle as the heat pump. The only difference is that the heat is released to the environment instead of extracted from the environment.

Depending on the heat source, the heat pumps are classified into, air/air-, air/water-, exhaust air- and ground source heat pumps.

The heat pumps use outdoor air, exhaust air and ground (vertical or horizontal) as heat sources respectively. GSHPs can also utilize ground water or lake water as its heat source.

The heat pump's coefficient of performance for heating ( $COP_1$ ) is defined as the ratio of delivered heat to electricity used by the heat pump as presented in equation 3.

$$COP_1 = \frac{Q_1}{E_k} \quad (3)$$

Cooling coefficient of performance ( $COP_2$ ) is presented in equation 4.

$$COP_2 = \frac{Q_2}{E_k} \quad (4)$$

In the simulation which this thesis is based on, a GSHP was used with a R410A refrigerant.

This type of heat pump utilizes heat at low temperatures, typically around 5 to -2°C, in the ground through a mixture of water and alcohol, which is circulated in a U-tube heat exchanger located in the borehole. The heated mixture is then circulated through an internal heat exchanger called an evaporator in the heat pump where the heat is transferred to a refrigerant. When the refrigerant is heated, it evaporates and is circulated through the compressor where the pressure is increased. After the compressor, the evaporated refrigerant is then transported to a condenser. As the refrigerant is condensing the heat released is transferred to the hydronic system of the building.

### 3.2.2 Ventilation systems

All new buildings in Sweden must have mechanical ventilation installed. The current Swedish building regulations specify a minimum ventilation flow rate of 0.35 l/s, m<sup>2</sup> (Boverket, 2013).

The most common types of mechanical ventilation systems today are exhaust air-, supply- and exhaust air-, supply- and exhaust air -ventilation with heat recovery and EAHP.

In buildings constructed before 1980 natural ventilation was common and this ventilation is driven by the temperature difference between the interior and exterior of the building. In addition, the wind around the building also contributes to the natural ventilation. Modern buildings have a higher air tightness than older buildings and therefore need mechanical ventilation.

In the exhaust air ventilation system, a fan draws air via exhaust air diffusers located in the kitchen, laundry room and bathrooms. The air flows out of the building and gives a lower pressure in the building than outside. This gives a flow of outside air into the building via inlet diffusers and leakages.

The supply and exhaust air ventilation has two fans, one for each flow. As with exhaust air ventilation the air is drawn from the kitchen, laundry room and bathrooms and in addition air is supplied to the bedroom and living room.

Heat recovery ventilation works on the same principle as the supply and exhaust air ventilation but has a heat exchanger in the system that exchanges the heat in the exhaust air to the supply air. This exchange heats the supply air into the building and it will reach a temperature only a few degrees centigrade lower than the indoor temperature.

To comply with the ventilation and energy regulations in the BBR the majority of new buildings are equipped with either a supply- and exhaust air -ventilation system with heat recovery, which is referred to as a heat recovery ventilation system (HRV) in the rest of this thesis, or an exhaust air heat pump.

The different ventilation system types are presented in figure 3.

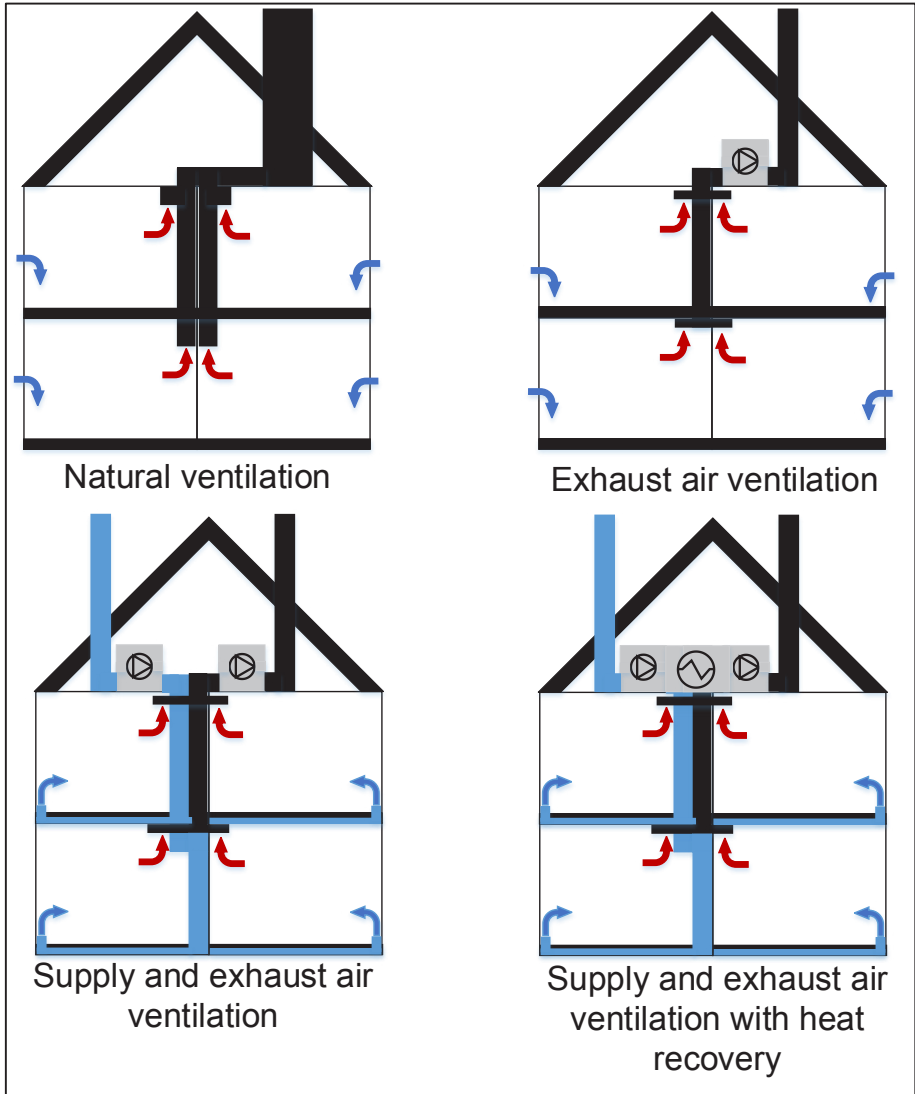

Figure 3. Different types of ventilation systems

In this thesis, the simulated systems have a supply- and exhaust air ventilation system equipped with heat recovery or are equipped with an EAHP.

This type of ventilation system consists of two fans, one for the supply air and one for the exhaust air, and a heat exchanger.

The HRV has a rotary heat exchanger where the heat in the exhaust air is transferred to the supply air.

The exchanger has an annual efficiency of 80 % and the ventilation system is continuously trying to maintain a supply air temperature of 17 °C.

### 3.3 Solar energy systems

In Europe and other parts of the industrialized world solar energy is seen as a viable way of lowering the need for purchased energy in buildings.

This can be achieved by employing passive methods, e.g. large window areas facing south in buildings, which gives a heat contribution to the building, or active systems.

The active systems can be divided into two; electricity and thermal systems and these are described below.

#### 3.3.1 Regulations and incentives in Sweden

The PV system investment support level is 30 % of the total PV system investment cost for companies and 20 % for all others with a maximum level of 126 000 EUR. It was introduced in 2009 with a support level of 60% of the total PV system investment cost. Investment support has gradually been lowered as PV system prices have decreased and the sustainability of it is hard to assess.

The tax deduction system, introduced in 2015, has a support of 6.3 EUR cent per kWh fed into the electricity grid up to 30 000 kWh per system in 2016.

Self-consumption has always been exempt from energy tax. This will, however change in 2016. The energy tax exemption will be limited and only apply to homeowners and companies that install a maximum of 255 kW<sub>p</sub> of PV power (Swedish Riksdag, 2016). This reduces the profitability of larger systems as the monetary saving of reducing purchased electricity decreases. In 2016 the government will initiate an investigation into the possibility of reducing the effect of the limited tax exemption. The energy tax in 2016 is 3.8 EUR cent.

Solar thermal systems get no financial support since an earlier support system was terminated in 2011.

#### 3.3.2 PV systems

A grid connected PV system consists of a PV array, a DC and an AC breaker and an inverter. If the system is not connected to the grid it must be complemented with a battery storage system and a charge controller. A system schematic is presented in figure 4. Solar electricity systems in Sweden are mainly used to reduce the need for purchased household electricity in residential buildings.

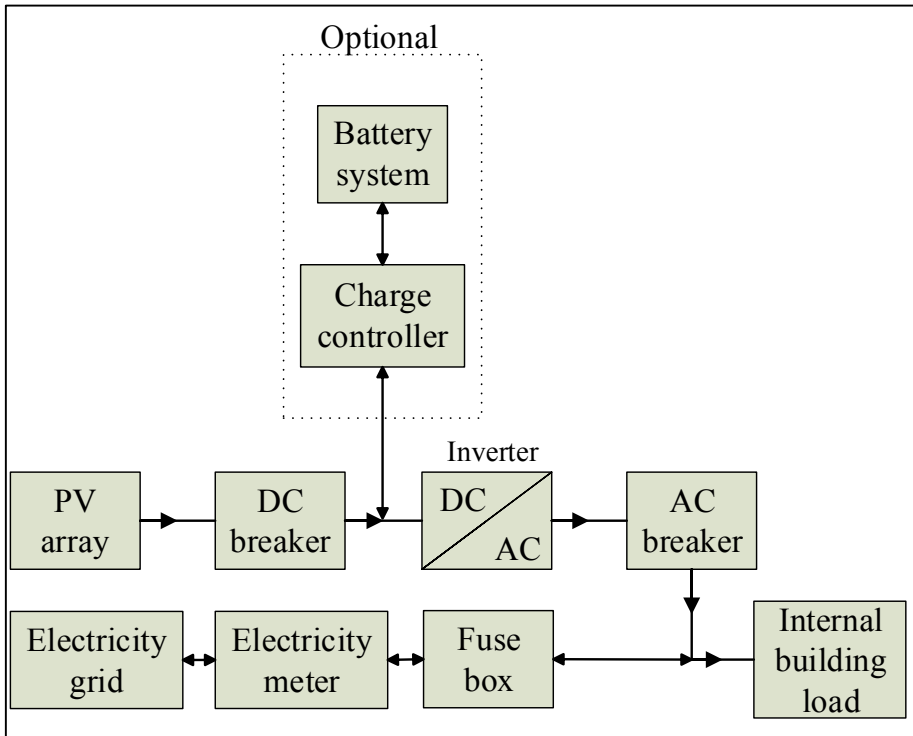

Figure 4. PV system schematics.

The electricity not used in the building can be fed into the electricity grid and sold at a substantial lower price than the purchased electricity.

A total of 80 MWp PV power had been installed in Sweden at the end of 2014, of which 36 MWp was installed during 2014 (IEA-PVPS Task 1, 2015). Almost twice as much capacity was installed during 2014 compared to 2013. The majority of the installed capacity in Sweden is grid-connected (IEA-PVPS Task 1, 2015). The annual installed PV power is presented in figure 5.

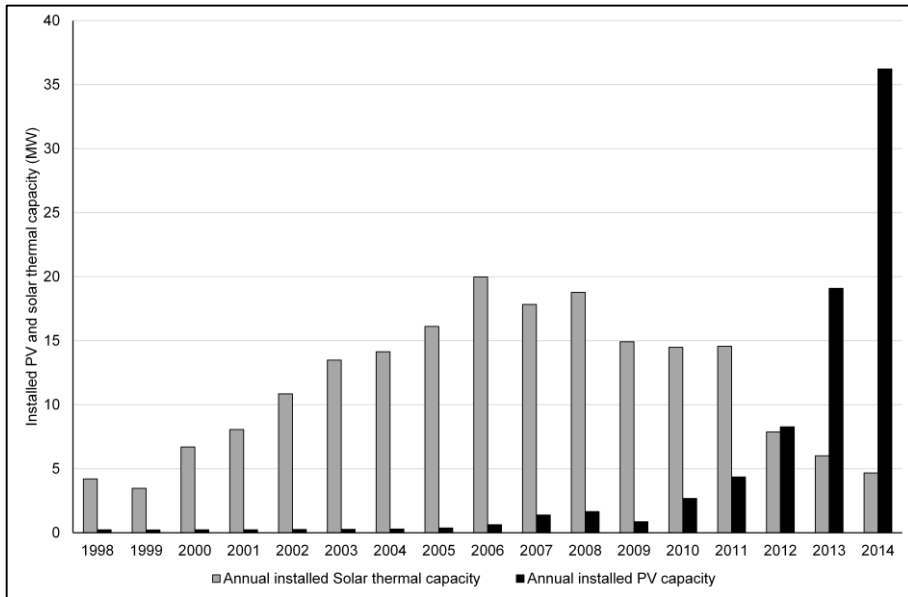

Figure 5. Annual installed PV and solar thermal power in Sweden. (Svensk Solenergi, 2015).

A grid-connected PV system can feed the electricity surplus of the PV system to the electricity grid. This gives larger flexibility in terms of PV system size and grid-connected systems almost always have some overproduction. With an off-grid system, storage is needed when installing a system larger than the actual building electricity load. All PV electricity from an off-grid system must be self-consumed.

### 3.3.2.1 Net metering and self-consumption of electricity from PV systems

Net metering is an administrative way of making PV systems more profitable and also allowing larger PV systems to be profitable. With net metering, a net between electricity demand and PV electricity generation is calculated for a certain period, for example a day. This means that the PV electricity surplus that has to be fed into the grid during the day can be used for free during hours of no PV electricity generation in the same day. A net metering solution will administratively increase the value of a larger part of the generated PV electricity and the electricity grid can be viewed as a means of electricity storage for the consumer.

Self-consumption can be defined as the PV electricity that is used directly as it is generated or stored for later use in a building. The conversion and storage losses in the inverter and battery system and the electricity fed into the grid are not considered self-consumption.

The topic of self-consumption is becoming more and more interesting in many countries because of reduced incentives and electricity grid issues, mainly overvoltage problems.

From the electricity grid operator perspective, one of the main advantages with self-consumption is that the more electricity that is used directly in the building, the less impact the PV-system might have on the electricity grid. In Sweden, however, this might not be an issue until a really high distributed PV system penetration occurs (Widén, Wäckelgård and Paatero, 2010) This is partly due to the fact that parts of the grid have been dimensioned to handle heating of buildings by electricity.

### 3.3.3 Solar thermal systems

In Sweden the largest area of application for solar thermal systems is related to the production of domestic hot water (DHW) in residential buildings equipped with a boiler.

This is a viable way of saving fuel in residential boiler systems or electricity in residential buildings with electrical DHW production which is fairly common in Sweden.

The solar thermal systems market decreased by 22.5 % during 2014 compared with 2013. A total of 347 MW<sub>t</sub> of glazed solar collectors were in operation in Sweden at the end of 2014 (European Solar Thermal Industry Federation, 2015). The annual installed capacity is presented in figure 4.

Figure 6 displays a schematic with the main components of a standard active solar thermal system. The controller starts the pump when the fluid temperature in the solar collector is higher, usually 3-6 °C, than the temperature in the tank.

The pump is in operation until the temperature in the tank is higher, usually 2 °C, than the solar thermal collector fluid temperature.

The heat exchanger for the solar thermal system is placed in the lower part of the tank. This gives a lower average working temperature of the collector which gives a higher annual yield than if the heat exchanger were placed higher in the tank.

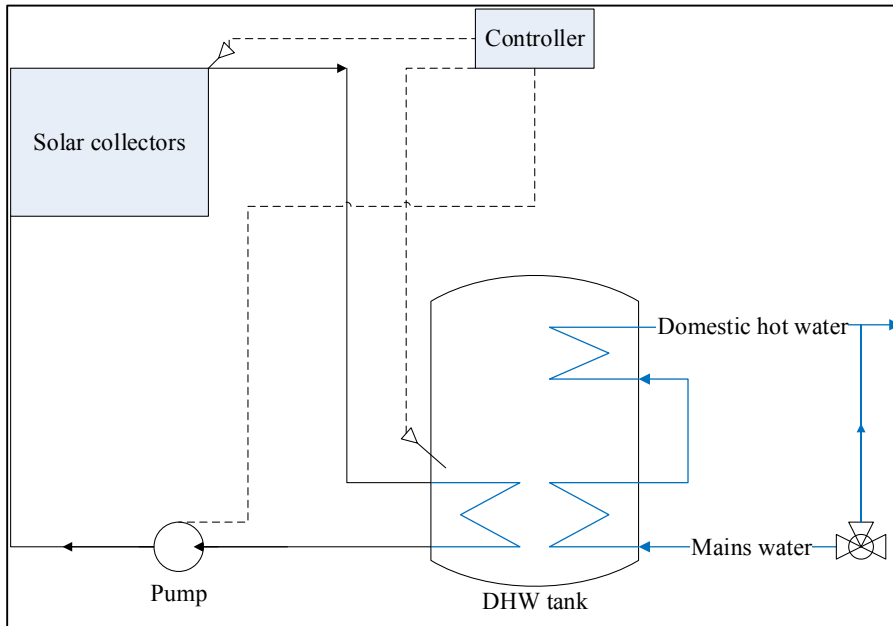

Figure 6. Solar thermal system schematics.

## 3.4 Energy storage systems

### 3.4.1 Battery systems

The most used types of rechargeable (secondary) batteries are lead acid-, nickel cadmium-, nickel metal-hydride and lithium ion batteries.

The lead acid battery is the oldest and most extensively used battery type and can be attributed to its relatively low cost.

It has many advantages besides its low cost and also some disadvantages, for example a low cycle life.

Nickel-cadmium batteries come in three different main types but the most widely used is the sealed battery. This type is used in portable consumer electronics. It has a long cycle life and can be stored uncharged without any deteriorating of its function. However, there are some disadvantages including memory effects and relatively high cost.

The nickel-metal hydride battery is extensively used in consumer electronics and to some extent in hybrid electric vehicles. It has a long cycle life and shell life and has a high energy density. One disadvantage is its high cost.

The lithium ion battery is a fairly new technology; the first commercial battery was made available in 1991. It is used in many consumer electronic



devices and in electric vehicles. It has many advantages and the most important are long cycle and shell life and no memory effect. Its biggest disadvantage is the cost.

A valve-regulated lead acid battery with a gelled electrolyte is used in the simulated system due to its high level of development and suitability for PV applications. The main advantages linked to this type of battery are the low investment cost and low levels of self-discharge. Due to the batteries being completely sealed except for the valve, they are maintenance free. One of the main disadvantages with this type of batteries is their sensitivity to being stored uncharged and their sensitivity to high temperatures.

Advantages and disadvantages of the different battery types are taken from Reddy (2011).

To enhance the battery life, a depth of discharge (DOD) restriction of 50% is implemented in the simulated system giving a battery life of 1700 full cycles. The end of life is reached when the battery capacity has fallen below 80 % of its specified capacity.

### 3.4.2 Hot water storage

The simulated tank is a double jacketed tank with a total volume of 225 L and an inner volume of 185 L. The inner volume contains the DHW. The heated water from the GSHP is circulated through the outer jacket which in turn heats the DHW. An electrical heater is also placed in the GSHP and in order to prevent the possible growth of Legionella the DHW is heated to 65°C by the internal electrical heater once a week.

## 3.5 Swedish electricity price structure

The Swedish electricity market has been deregulated since 1996 and customers can choose between around 120 electricity suppliers. Electricity distribution is, however, still a monopoly.

The Swedish electricity price is decided by the Nord Pool power market depending on the balance between supply and demand. In reality this means that the most expensive production unit in operation at every given moment decides the electricity price.

The total electricity cost per kWh in Sweden is divided into two major parts with several subparts.

The first major part is the electricity price itself, which is based on the Nordpool power market, and the second major part is the electricity grid fees.

An energy tax and a value added tax (VAT) are added to the electricity price.

The relative size of the different parts can be seen in Figure 7.

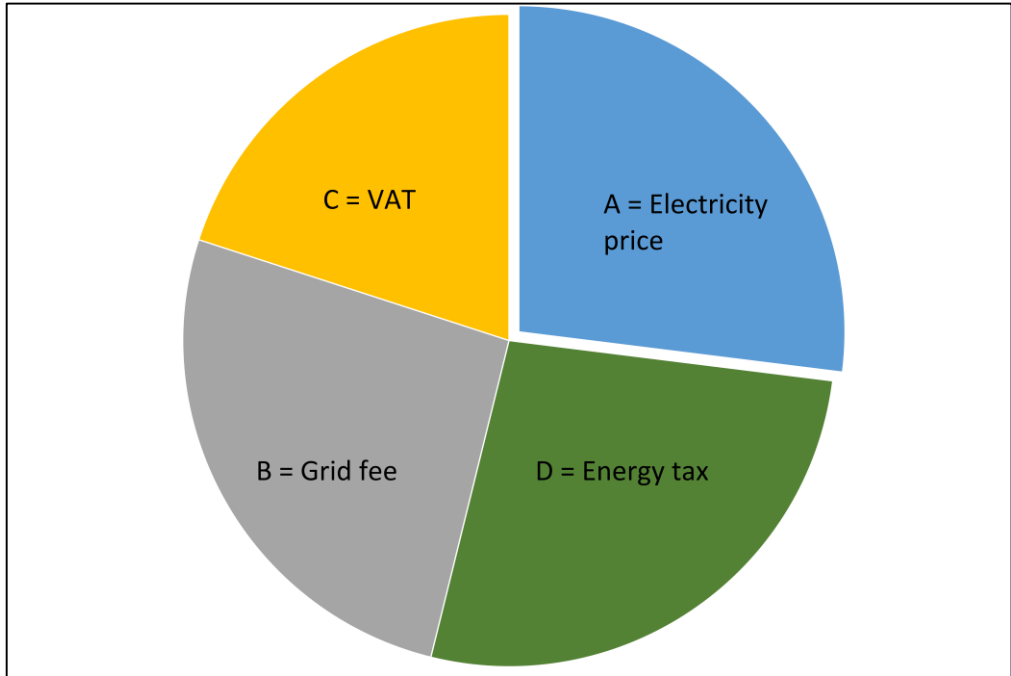

Figure 7. Electricity cost divided into its different parts.

The electricity grid fees are normally divided into a variable cost (EUR/kWh) and a fixed cost. VAT is added to the total electricity grid fee amount.

When the generated electricity from a PV system is fed into the grid and sold to an electricity vendor, the revenue for the system owner is the electricity price itself, but when the electricity is used in the building the revenues are the electricity price itself, the energy tax and the variable part of the electricity grid fee including VAT.

## 4. Literature review

This chapter includes a literature review regarding general research on solar assisted heat pump systems, PV electricity self-consumption in buildings with and without GSHPs, smart control of heat pumps in order to increase self-consumption and on the topic of low energy buildings (near zero energy and net zero energy buildings).

Earlier research literature relating to solar assisted heat pump systems has described non-commercial complex systems with both PV/T and solar thermal systems integrated with heat pumps (Xu, et al., 2009, Chena, et al., 2011, Eicher, et al., 2012 and Kjellsson, 2012).

In Xu, et al. (2009) the PV cells are placed on top of an absorber that is used as the heat pump evaporator. A solution like this makes it possible to utilize lower temperatures from the thermal system into the heat pump and hence utilize the solar thermal system for longer periods during a year.

Similar solutions have been tested in Chena, et al. (2011) and Eicher, et al. (2012). No previous literature regarding energy and economic comparison of heat pumps for DHW and heat production in combination with different types of solar energy systems have been found. However, some research on compressor chillers with different solar energy systems can be found in Hartmann, Glueck and Schmidt (2011).

The system presented in paper I is a simple system based on commercially available components where no direct connection exists between the heat pump and the solar energy system. In Kjellsson (2012) the author analyzed six different system solutions, with GSHP and solar thermal system, of different complexity, from a simple system where the solar thermal system only produces DHW to a system where the solar thermal system can produce DHW or heat the borehole. Part of the conclusion from Kjellsson (2012) was used for deciding which solar thermal system solution was to be analyzed in paper I. The conclusion from Kjellsson (2012):

If the depth of the borehole is not undersized, the natural increase of the temperature in the borehole during summertime is enough. It is more energy efficient to use the solar heat during summer for domestic hot water, compared to recharging the borehole during summer.

Research on self-consumption of PV electricity and how to increase it is still a small research area (Luthander et al., 2015). Existing work includes energy storage and/or demand side management (DSM) Castillo-Cagigal et al. (2011a), Castillo-Cagigal et al., (2011b) and Zong et al. (2012) and short time forecasting of irradiation in combination with DSM and energy storage (Masa-Bote et al., 2014). In Riffonneau et al. (2011), Purvins, Papaioannou, and Debarberis (2013), Salvador and Grieu, (2012) and Daud, Mohamed and Hannan (2013) the authors focused on different strategies to lower the impact of PV systems on the electricity grid.

Earlier research on PV electricity self-consumption in buildings with heat pumps has focused on cost minimization control (Candanedo and Dehkordi, 2014, and Riesen et al., 2013), peak shaving (Vanhoudt et al., 2014) and increased self-consumption with and without weather forecast control (Riesen et al., 2013, Vrettos et al., 2013, Williams, Binder and Kelm, 2012, Ikegami et al., 2012 and Ijaz Dar et al., 2014)

In Williams, Binder and Kelm (2012) the authors have focused their work on increasing self-consumption via heat pump systems with thermal and electrical storage. This work is similar to paper II but with the following differences; in paper II the PV electricity was fed into the thermal storage tank via an electrical resistance heater, in contrast to Williams, Binder and Kelm (2012) where the heat pump supplied the PV electricity as heat to the thermal storage and the charge control strategies for the electrical storage was different.

Only in Ijaz Dar et al. (2014) have the authors considered weather forecast controlled heat pumps as a way of increasing PV electricity self-consumption. The authors in Ijaz Dar et al. (2014) have analyzed a system with a non-commercial air/water heat pump and they have a different approach on the control and operating strategies.

Research on near zero energy and net zero energy buildings have mostly focused on framework, definitions, requirements, building regulations, calculation methods and barriers to implement said buildings (Annunziata, Frey and Rizzi, 2013, Blomsterberg, 2011, Dall'O', 2013, Deng S, et.al, 2011, Desideri U. et al., 2013, Gann, Wang and Hawkins, 1998, Tsalikis and Martinopoulos, 2015, Marszal et.al, 2010, Marszal et.al, 2011, Szalay and Zöld, 2014 and Sartori, Napolitano and Voss, 2012).

However, the works mentioned above regarding near zero and net zero energy buildings have not considered how PV electricity is managed and how different assumptions of usage affect the specific energy demand of buildings according to different NZEB definitions.

In addition, some research regarding renovating strategies, control strategies and evaluations of existing buildings is to be found in earlier literature (Magrini, Magnani and Perneti, 2012, Dabaieh, 2016, Morelli et al., 2012, Obyn, van Moeseke, 2014, Voll, Kosonen and Kurnitski, 2013 and Yuehong

Lu, Shengwei Wang and Kui Shan, 2015), but no consideration has been taken to PV electricity yield and different assumptions of electricity demand.

## 4.1 Knowledge gaps

Research and articles concerning combinations of heat pumps and solar energy systems have, as described in the literature review, focused on complex systems and paper I partially bridges this knowledge gap by presenting a thorough energy and economic analysis of GSHP in combination with solar energy systems (PV and solar thermal).

Articles on grid-connected PV system and self-consumption of PV electricity is rapidly increasing, Luthander et al. (2015). However, research and articles regarding self-consumption in low energy buildings equipped with PV systems and heat pumps are still scarce and articles concerning weather forecast controlled heat pumps are even scarcer. Papers I, II and III partially bridge these knowledge gaps. Paper I contributes with an analysis on how different metering schemes affect the profitability of PV systems and papers II and III contribute with analyses of how different technical solutions, energy storages and control strategies, increase self-consumption.

Research regarding PV electricity and assumptions and calculations on how it is used and how this affects the specific energy demand of buildings in NZEB definitions is non-existent, and paper IV contributes to new new knowledge by an analysis on how different assumptions on PV electricity usage affect the specific energy demand of buildings.

# 5. Methodology

## 5.1 Transient simulations

The system simulations presented in this thesis have been carried out in the transient simulation program TRNSYS (Klein, et al., 2010).

TRNSYS is an equation based simulation program and its source code consists of two parts: the kernel and the components (types) used in the simulation. The kernel reads and processes the input file and solves the system iteratively. TRNSYS was developed more than 35 years ago and has been extensively used since then. It is a flexible and transparent simulation program that is particularly suited for energy system simulations.

The modeled system is solved by calculating outputs for a component which in turn will act as the next components input and continue through all interconnected components in a system. This process will continue in every time step until the changes in the output are smaller than the tolerances specified in TRNSYS.

In addition to input, types also have one or more parameters that need to be specified before the output from the type can be calculated.

Mathematical descriptions of all standard types are included in the TRNSYS manual (Klein, et al., 2010). It is also possible to develop new types, which adds to the program flexibility.

Several earlier studies have validated the standard TRNSYS types. For example, in Timothy and Thornton (2008) the authors simulated and calibrated a model of a large-scale solar seasonal storage system and in Desoto, Klein and Beckman (2006) a new five-parameter PV array model was developed and validated. The climate data for the location of the simulated building is provided by the program Meteonorm (Remund et.al, 2015).

Meteonorm is a metrological database program. It outputs climatological data of different formats. In this thesis the typical metrological year 3 (TMY3) is used. A typical metrological year is based on measurement data from 20 years. Meteonorm only holds interpolated monthly global radiation data and uses stochastic models to generate hourly data (Remund et.al, 2015).

## 5.2 Energy balance for the simulated reference building

The energy balance for the simulated reference building is described in Figure 8. All the energy purchased to be used in the building is in the form of electricity. In addition to the supply of electricity by the electricity grid, energy in the form of heat is supplied via the borehole and solar energy through the windows and as electricity through the PV system.

The recovered heat from the HRV is not represented in Figure 8 because it only recovers energy already supplied to the building.

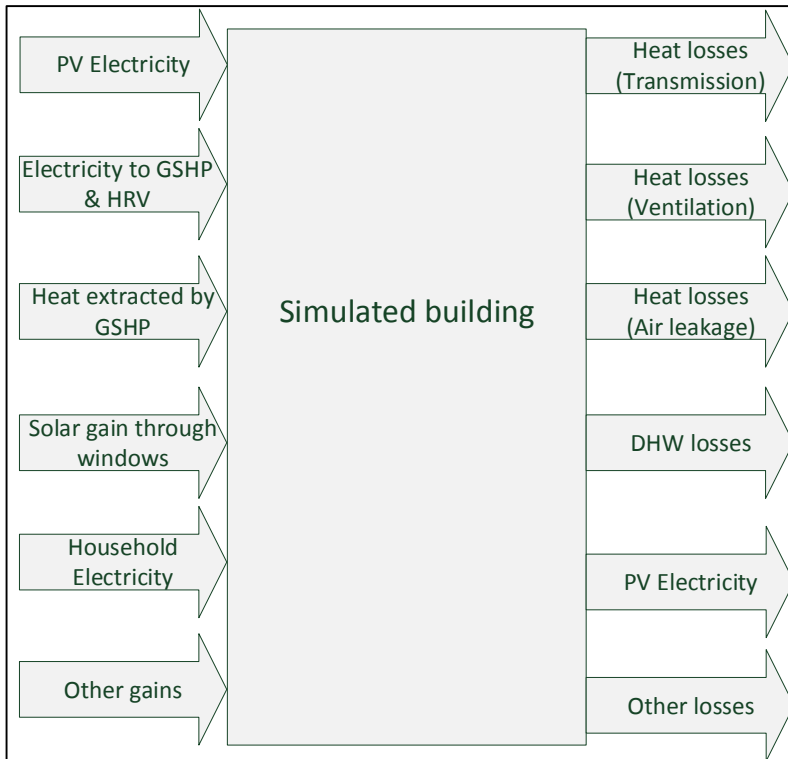

Figure 8. Energy balance of the studied system.

## 5.3 Economic calculations

Two different types of economic calculations were used in the included papers. In papers I and III the annuity method was used to calculate the profitability of the different system alternatives.

The revenues are converted to net present values by multiplying them by the discount factor (DF) which is defined in equation 5. R is the nominal discount rate and T is the lifetime of the system.

$$DF = \frac{1}{(1+R)^T} \quad (5)$$

The net present value (NPV) is in turn converted to an annual surplus, as presented in equation 6.  $I_c$  is the investment cost.

$$(NPV - I_c) * \frac{R*(1+R)^T}{(1+R)^T - 1} \quad (6)$$

If the annual surplus is positive, the investment is considered profitable.

The following assumptions and data were used in the annuity calculations in paper I:

- Nominal discount rate 6%; the annual electricity price change was assumed to be 4.7% which is based on the change 10 years back in time.
- The starting electricity price for the calculation was set to 0.18 EUR/kWh (Statistics Sweden, 2014).

In paper III: Real discount rate is 2.36 % which is equivalent to a nominal discount rate of 5.7 %. The real discount rate takes inflation into account. No annual electricity price change, the price for a consumer that purchases and sells electricity is assumed to be 0.11 EUR/kWh and 0.033 EUR/ kWh respectively.

The LCOE method used in paper II is represented by equation 7. This method is based on the net present value method, which discounts the investment and operations cost to the same year.

The upper part of the equation describes the total cost which is the investment cost ( $I_c$ ) and the net cost of the project for every year of the life time of the system ( $C_t$ ).

The lower part of the equation describes the sum of the PV system electricity output every year during the system life time. An annual degradation of the PV modules is also included in the equation.

$$LCOE = \frac{I_c + \sum_{t=1}^T \frac{C_t}{(1+r_r)^t}}{\sum_{t=1}^T \frac{St*(1-d)^t}{(1+r_r)^t}} \quad (7)$$

The obtained results are given in EUR/kWh which represent the average production cost of electricity during the system life time.



If the LCOE is lower than the electricity cost during the system life time, the system would then be profitable.

An investment cost for the PV system (PV modules, inverter, cables, breakers, installation, etc.) of 2660 EUR/kWp is used in paper II.

The investment cost for the battery system and the weather forecast controller is estimated to be 225 EUR/kWh and 630 EUR respectively. In addition, the weather forecast controller have an annual cost of 202 EUR for forecast data and telematics subscription.

The PV modules are assumed to have an annual degradation of 0.5% of the annual yield and a technical lifetime of 30 years.

In the economic calculations, the battery system is replaced every 7 years and the inverter and the weather forecast controller every 15 years, as defined in papers II and III.

## 6. Description of scenarios and simulation models

In this chapter the simulated scenarios are described in detail, including a brief description of the simulation models.

### 6.1 Scenarios

Ten different scenarios were simulated throughout this thesis. The first three scenarios are based on the same technical system which consists of PV system, GSHP and a HRV. This system is evaluated with real-time, daily net and monthly net metering. Net metering is described in chapter 3.4.2.1.

The fourth scenario is based on a system with a solar thermal system, a GSHP and a HRV.

Scenario five is based on a system with a PV system, a solar thermal system, a GSHP and a HRV and with monthly net metering.

Scenario six is based on the system from scenario three but with real-time metering and complemented with a lead acid battery storage.

The seventh scenario is based on the third one, but with real-time metering and supplemented with a hot water storage tank where the PV electricity is stored as heat and used for DHW.

Scenario eight is based on the third one but complemented with a weather forecast controller.

Scenario 9a is identical with the third scenario and 9b is also based on the third scenario but has an EAHP instead of a GSHP and a HRV. In addition, a larger DHW storage volume, 470 L, is compared with the standard one.

The main components and metering schemes of the different scenarios are presented in table 2.

Table 2. Main components and metering schemes of the simulated scenarios.

Scenario	1	2	3*	4	5	6	7	8	9a	9b
GSHP	x	x	x	x	x	x	x	x	x	
EAHP										x
PV	x	x	x		x	x	x	x	x	x
Solar thermal				x	x					
HRV	x	x	x	x	x	x	x	x	x	x
Real time	x					x	x	x	x	x
Daily net		x								
Monthly net			x		x					
Battery storage						x				
Thermal storage							x			
Weather forecast control								x		

\*Reference system.

## 6.2 Simulation models

The models simulated in this thesis consist of the following main components as presented in figure 9: Low energy building, space heating system, GSHP / EAHP, borehole, DHW-tank, PV-system and heat recovery ventilation. The GSHP heating capacity is 5.8 kW in paper I and this is changed to 3 kW in paper II and also used in paper III and IV. The EAHP has a heating capacity of 5 kW.

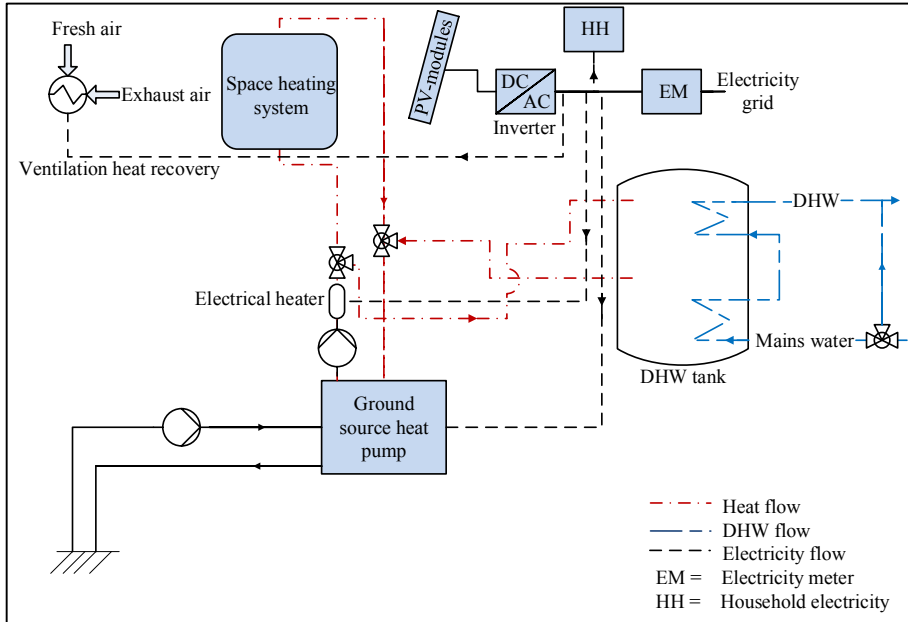

Figure 9. System schematics of one of the simulated systems.

In addition to the specified main components, 15 different Trnsys types are part of the reference model. All types are specified in appendix 1.

The simulation considers two years with a time step of 3 minutes, although due to a full winter period only affecting the simulation of the second year, only the second year has been further analyzed.

The low energy building has a heated living area of 138 m<sup>2</sup> which is based on the average living area for one-family buildings built in 2012 with four rooms in the county of Västmanland where the chosen simulation location is situated (Statistics Sweden, 2013). It is inhabited by four people. The U-values of the different building components can be seen in table 3 and a detailed description of the building can be found in appendix 2.

Table 3. Building component's U-value.

<i>Building component</i>	<i>U-value (W/m<sup>2</sup>, K)</i>
Ceiling	0.106
Outer walls	0.102
Ground floor	0.103
Windows	0.81

The total building energy demand without any technical installations and divided into heating, DHW and household electricity can be seen in table 4.

Table 4. Annual energy demand for the simulated building.

	<i>Annual energy demand (kWh)</i>
Heat and DHW	19 880
Household electricity	5 155

The energy load profile for the building and especially the DHW load profile and household electricity load profile is extremely important in terms of how much PV electricity can be utilized in the building. The DHW load profile and the household electricity load profile used in all simulations are presented in figure 10 and 11 respectively.

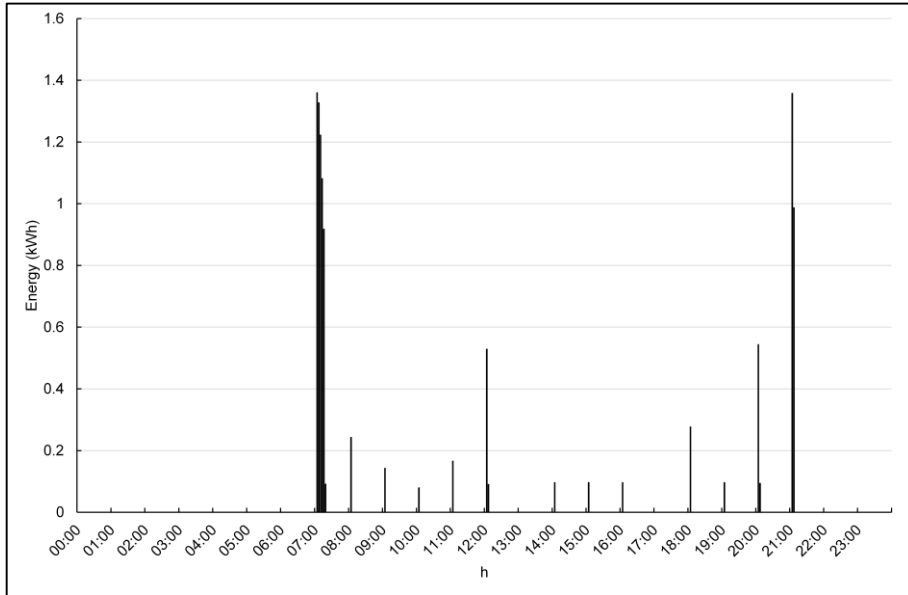

Figure 10. DHW energy and household electricity demand.

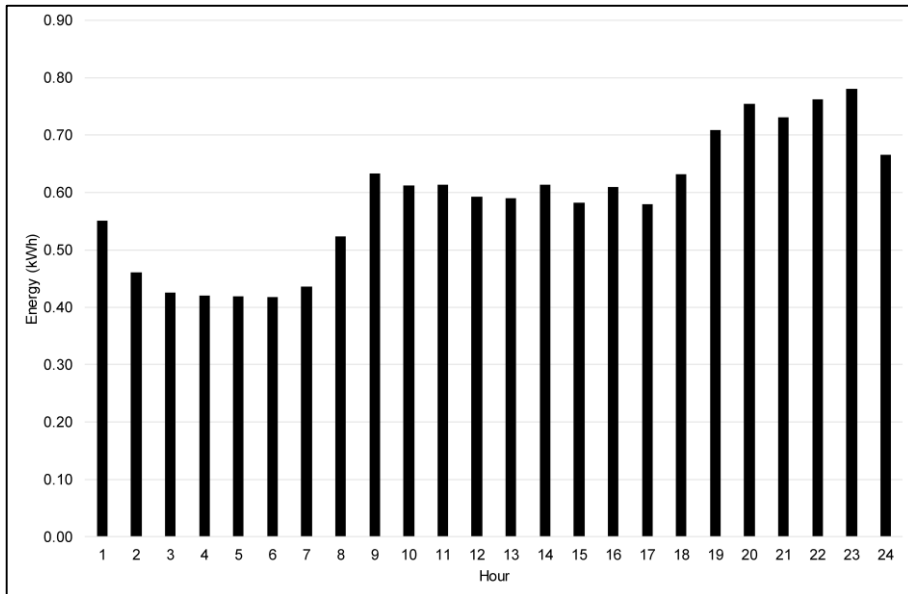

Figure 11. Household electricity demand.

The main difference between the reference system model developed in paper I and the other models is that the others have energy storage systems and are controlled in more advanced ways, which are needed to utilize the storage

systems effectively. The energy storage systems analyzed in paper II include a battery storage and a storage of electricity in the form of heat in a hot water storage tank.

The PV system size is 5.19 kW<sub>p</sub> in paper I and 5.29 kW<sub>p</sub> in papers II to IV and is facing south. The system is tilted 70°, which is more than the usual 45°, increasing in this way the PV system size and producing less electricity in the summer months and more during the spring and fall. This was done in order to install a larger PV system without overproduction and get a higher solar energy fraction in the building energy system. The annual yield from the PV system is approximately 5100 kWh. How different tilts and azimuths affect the annual yield is presented in table 5.

*Table 5. Annual yield in comparison with tilt 45° and azimuth south (%).*

<i>Azimuth / tilt</i>	<i>0°</i>	<i>45°</i>	<i>90°</i>
East	78.7	74.7	56.2
South	78.7	100	75.5
West	78.7	74.3	56

## 7. Results and discussion

This chapter presents the results from papers I–IV, which this thesis is based on and combines them in order to give a system model with high levels of self-consumption of PV electricity and relatively large solar energy fraction. A detailed sensitivity analysis regarding electricity price change can be found in paper I and regarding investment cost and real discount rate in paper II.

### 7.1 Analysis and evaluation of different solar energy systems

In paper I the building energy system with three different solar energy systems was modeled, simulated and evaluated with different metering schemes. Profitability and solar energy fraction were the factors evaluated.

The three solar energy systems that were evaluated are a PV system, a solar thermal system and a combination of both, in combination with three different metering schemes, monthly net, daily net and real-time metering (scenarios 1–5).

The PV system was sized to avoid overproduction with monthly net metering and the same size was also used to evaluate the profitability of the other net metering schemes. In addition, the PV system was tilted to  $70^\circ$  instead of the normal  $45^\circ$ , which is optimal for the simulated location in terms of yield per installed peak power of the PV system. Different metering schemes allow the installation of different PV systems sizes before overproduction is reached as seen in Figure 12.



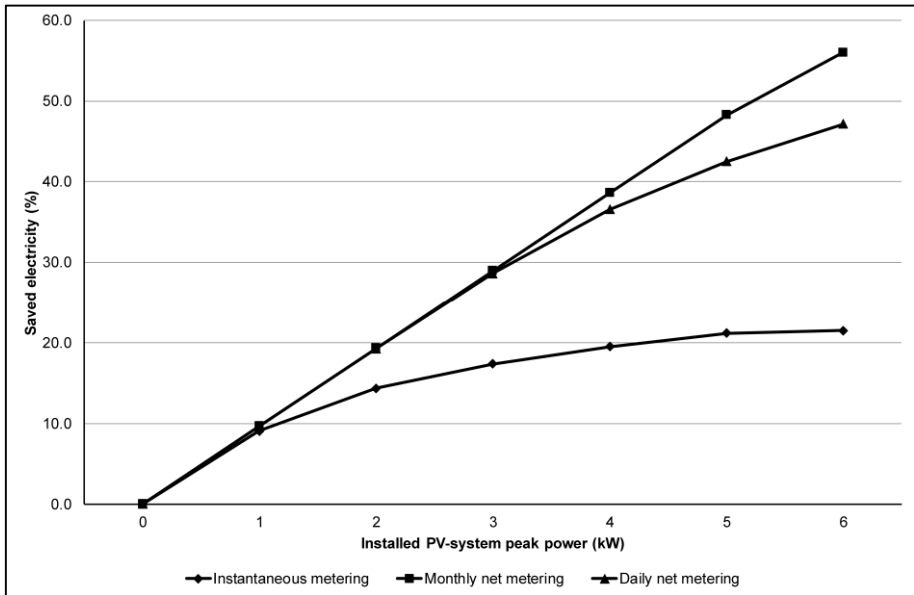

Figure 12. Installed PV power in relation to saved electricity in the building with different metering schemes.

The system size was chosen so one month (June) would have a zero net and all other months would have a negative net, i.e. the PV production is smaller than the building electricity demand.

When this system is evaluated using daily net (scenario two) and real-time metering (scenario one), an electricity surplus has to be fed into the electricity grid and sold. As mentioned earlier, the price for selling electricity is much lower than the one purchased from the grid, which negatively affects the profitability of the system scenarios.

Figure 13 shows the PV system electricity yield and the building energy demand.

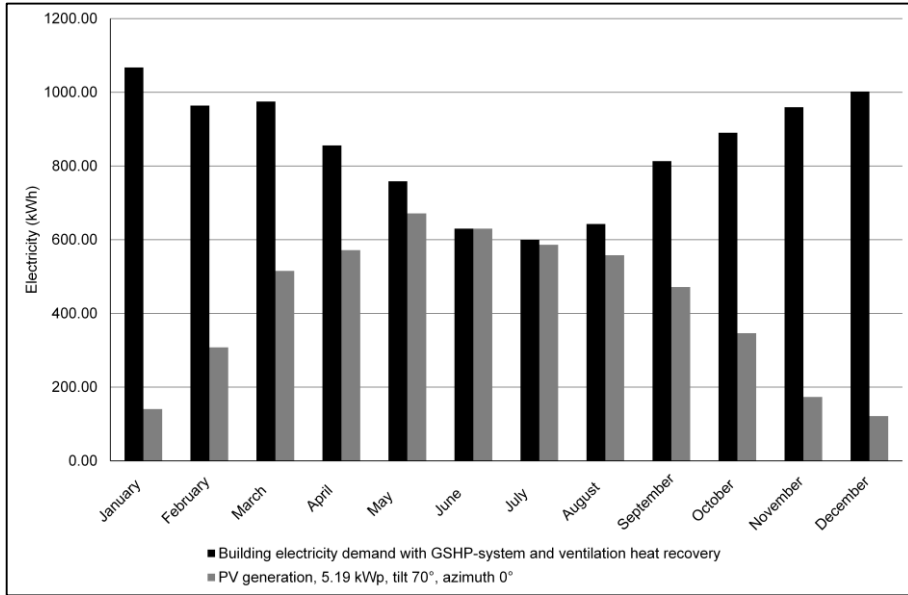

Figure 13. Monthly electricity demand of the building and PV system yield.

When it comes to the profitability of the system, the main drawback with a higher tilt than optimal is that the PV electricity output per kWp is lower than for a system with optimal tilt, which negatively affects the profitability of the system. The most profitable system is the one with monthly net metering and this is the system chosen to be the reference system in this thesis

The purchased energy including household electricity for the building with its different technical installations can be seen in table 6.

Table 6. Building purchased energy demand with different system configurations.

<i>Building with technical installations</i>	<i>Energy demand (kWh)</i>	<i>Energy demand (kWh/m<sup>2</sup>)</i>
Without technical installations	19 880	144
With HRV	16 920	123
With HRV and GSHP	10 157	74
With HRV, GSHP and PV system	5 064	37
With HRV, GSHP and PV- and solar thermal system*	5 351	39
With HRV, GSHP and solar thermal system	9 410	68

\* PV system size is 4.6 kW<sub>p</sub> in this scenario.

As seen in table 6, the need for purchased energy is reduced by 75 % with all technical installations in operation including the PV system and the PV system itself reduces the need for purchased energy by almost 26 %.

The solar thermal system was sized to comply with general sizing recommendations that state that the volume of the storage tank should be at least 50 liters per installed square meter of solar thermal modules (Kovács 1998). The GSHP standard DHW storage tank then gives a total aperture area of 4.2 m<sup>2</sup> and the modules are tilted by 45°. The analysis of the simulation data for this system configuration suggests that this is an inefficient system configuration in regards to both profitability and solar energy fraction (table 7).

During the summer, when the solar thermal system delivers energy to the DHW, the GSHP is out of operation, meaning that the solar thermal system replaces the purchased electricity needed for GSHP operation and energy extracted from the ground by the heat pump.

Only the purchased part of the energy saved because of the standstill of the heat pump can be included in the profitability and solar energy fraction calculations. A COP of 2.5, when producing DHW, gives that 40% of the energy from the solar thermal system reduces the electricity needed to be purchased. This means that 60% of the energy delivered from the solar thermal system reduces the extraction of energy from the borehole, which is energy without a monetary cost. The system is therefore, considered not profitable, even if a longer life (due to the standstill of the GSHP) is included in the calculations.

The solar thermal system in combination with HRV and GSHP reduces the need for purchased energy by 47 %, and the solar thermal system itself contributes with a reduction of 3 %.

The total reduction for this configuration is slightly larger than the direct contribution from the solar thermal system, mainly because the heat pump is off during the period when it would produce DHW at a lower COP than the seasonal coefficient of performance (SCOP). However, the low amount of electricity saved with this configuration is not specific to the solar thermal system, as all systems that compete with heat pumps for the same load has this challenge.

*Table 7. Profitability and solar energy fraction of all system configurations.*

<i>System configuration</i>	<i>Metering scheme</i>	<i>Annual surplus (EUR/year)</i>	<i>Solar energy fraction (%)</i>
PV system	Monthly	105	50
PV system	Daily	22	43.5
PV system	Real-time	-427	21.5
Solar thermal system	n/a	-166	5.7
PV and solar thermal system	Monthly	-212	49

The profitability and the solar energy fraction of the solar thermal system is presented in table 7.

The analysis of the system configuration with both PV and solar thermal system and monthly net metering scheme (scenario 5) suggests that it is not profitable and this is due to the problem of combining a heat pump and a solar thermal system, described earlier in this chapter. Another problem with the system is that the solar thermal system limits the size of the PV system by lowering the building electricity load. A lower building load results in a smaller PV system in order to avoid a surplus of PV electricity.

Therefore, the system configuration from scenario 5 limits the purchased energy demand slightly less, because of the smaller PV system.

## 7.2 Analysis and evaluation of different energy storage systems

As described in paper II, the reference system was analyzed and evaluated with two different energy storage systems and the one with a high level of self-consumption and best profitability was chosen for further analysis.

System scenario three was chosen as the reference system in paper I and supplemented, as described in paper II, with energy storage (scenarios 6-7). The system was then analyzed and evaluated with only real-time metering. The heat pump heating capacity and the PV system size were modified in paper II, as discussed in chapter 6.2.

The lead acid battery system was sized so it had a capacity to store one day of surplus electricity from the PV system and the capacity needed for this is 48 kWh. With a DOD restriction of 50 %, only 24 kWh can be utilized. A sensitivity analysis with regards to the battery capacity and self-consumption suggests that a battery capacity larger than 10 kWh is not utilized efficiently and this has been presented in Figure 14 where the slope of the curve starts to decline at 10 kWh. When the slope of the curve in figure 14 starts to decline the self-consumption of PV electricity per kWh battery capacity is decreasing. This means that battery system sizes above 10 kWh are used less efficiently with regard to increasing self-consumption than a smaller battery system.

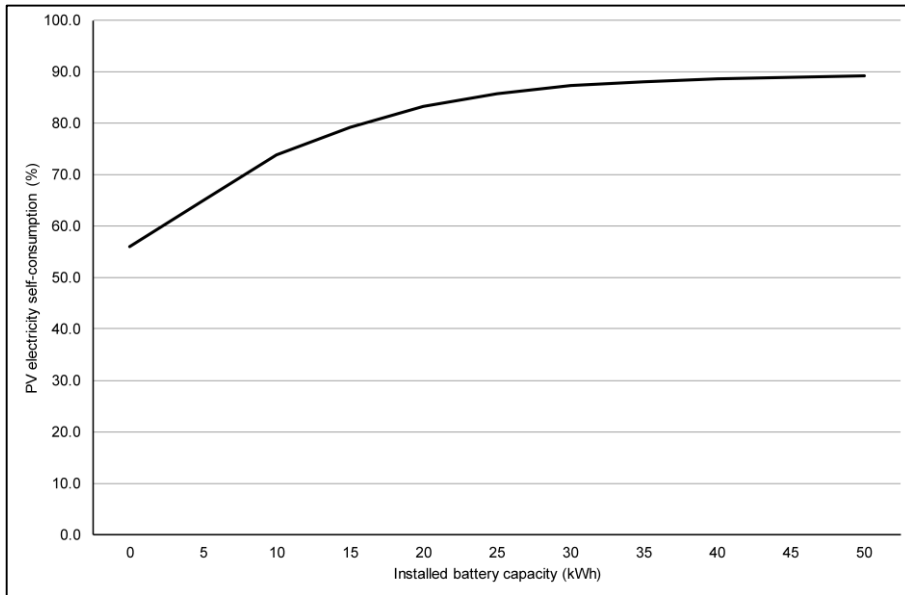

Figure 14. PV electricity self-consumption in relation to installed battery capacity.

With a battery size of 48 kWh almost 90 % of the PV electricity is utilized in the building, and with a size of 10 kWh almost 75 % can be utilized. This should be compared to the reference system which has a self-consumption fraction of 56%.

Neither of these systems is profitable. This can be related to the high price of batteries, short lifespan and system losses. All these issues affect the profitability of the system.

The reference system with a hot water storage tank has a self-consumption fraction of 88 % and half the LCOE compared to the 48 kWh battery system.

The LCOE, self-consumption- and solar energy fraction of the reference system with and without storage are shown in table 8.

All assumptions on which the LCOE calculations are based can be found in chapter 5.3.

At first the system with hot water storage seems to be the most effective one if profitability and the self-consumption fraction are considered. However, there are some disadvantages that make the system inefficient, such as the PV electricity not used directly in the building being used to power an electrical heater in the storage tank, causing the same challenges as with the system with GSHP and solar thermal system described in chapter 7.1.

In order to avoid the previously described problem, in future model configurations the surplus PV power will be used to operate the GSHP to heat the storage, even though the GSHP will not be able to heat the storage to 95°C and utilize all PV surplus production.

Table 8. *LCOE, self-consumption and solar energy fraction for the different storage systems.*

<i>System configuration</i>	<i>LCOE (EUR/kWh)</i>	<i>Self-consumption fraction (%)</i>	<i>Solar energy fraction (%)</i>
Reference system	0.16	56	28
Reference with battery	0.4	89	44.5
Reference with storage tank	0.2	88	44.4

### 7.3 Analysis of a weather forecast control for GSHP

The reference system of paper I, which was modified in paper II in terms of heat pump size and PV system size, was complemented with a weather forecast control.

#### 7.3.1 Reference control

In most commercial available GSHPs the supply temperature to the hydronic system of the building is decided based on the ambient temperature, and in some cases also in combination with the indoor temperature. A linear curve is used to specify the supply temperature to the hydronic system at each given ambient temperature. This control strategy is referred to as the reference control.

The DHW temperature is based on a fixed temperature set point that is compared with a temperature measurement taken from a sensor in the DHW tank. DHW production is prioritized before heating and this means that heating is turned off if a DHW demand exists. The hysteresis of the controller is set to  $2.5\text{ }^{\circ}\text{C}/5\text{ }^{\circ}\text{C}$  which gives a maximum temperature of  $47 + 5 = 52\text{ }^{\circ}\text{C}$  in the DHW tank and a minimum temperature of  $47 - 2.5 = 44.5\text{ }^{\circ}\text{C}$ . The DHW tank is heated to  $65\text{ }^{\circ}\text{C}$  for one hour every week in order to reduce the risk of legionella growth in the tank.

#### 7.3.2 Weather forecast control

The proposed novel forecast control manipulates the GSHP ordinary reference control by altering the DHW temperature set point based on the forecasted

intensity of the total irradiance in the PV array plane, the PV electricity generation and the electricity demand of the building. The set point is changed from 47 °C to 34 °C if the forecasted intensity of the irradiation is over a certain specified value and there is no PV electricity surplus. If a surplus exists, the set point is changed to 54 °C in order to increase self-consumption. The hysteresis remains unchanged.

One major limitation in the analysis of the weather forecast control potential is that the forecast is 100% accurate.

More details on the control can be found in paper III and the flow chart of the controller is presented in figure 15.

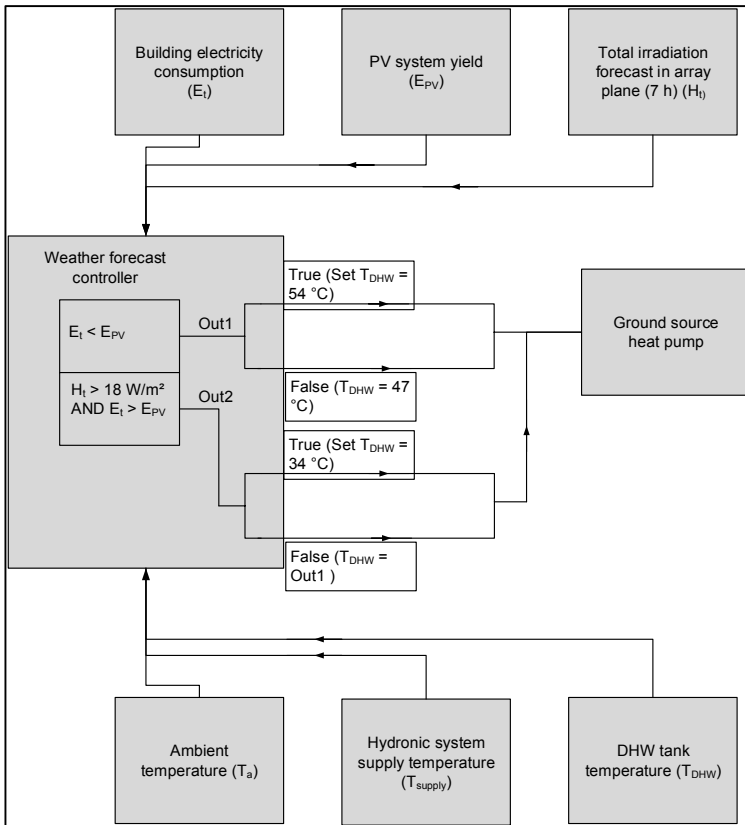

Figure 15. Weather forecast controller mathematical flow chart.

In order to test the control function, a summer day with high irradiation is analyzed. As presented in figure 16 the simulated control works as expected.



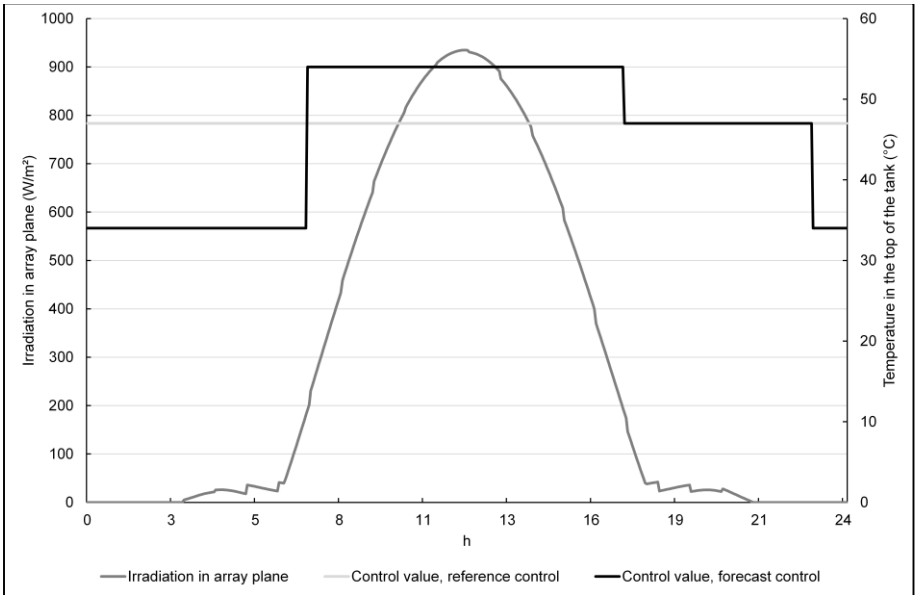

Figure 16. Reference and forecast control output values.

In the evening the day before the analyzed day, the forecast suggests high irradiation intensity during the next day and the set point temperature is changed to 34 °C. When the intensity increases in combination with a PV electricity surplus the set point is changed to 54 °C and when the PV system no longer generates an electricity surplus and the forecast suggests irradiation values below a specific set point, the temperature set point changes to the normal, as specified in the reference control. As soon the forecast suggests a high irradiation intensity, the temperature set point is changed to 34 °C and this occurs in hour 23 of the analyzed day.

The weather forecast controller increases annual self-consumption by 7 percentage points in the system with the standard DHW storage tank size. If the standard tank is replaced with a larger tank of 470 L, the self-consumption increases by an additional 1 percentage point and this suggests that the storage size has a small influence on the increase in self-consumption. Self-consumption, self-consumption fraction and solar energy fraction are presented in table 9.

Table 9. Self-consumption, self-consumption fraction and solar energy fraction of the models with different control strategies and DHW storage sizes.

	Self-consumption (%)	Self-consumption (kWh)	Solar energy fraction (%)
Reference control	56	2 900	28
Forecast, 225 L	63	3 260	31.5
Forecast, 470 L	64	3 328	31.8

Self-consumption is increased during 2 150 hours of the total 4 280 hours of self-consumption that occurs annually as presented in figure 17.

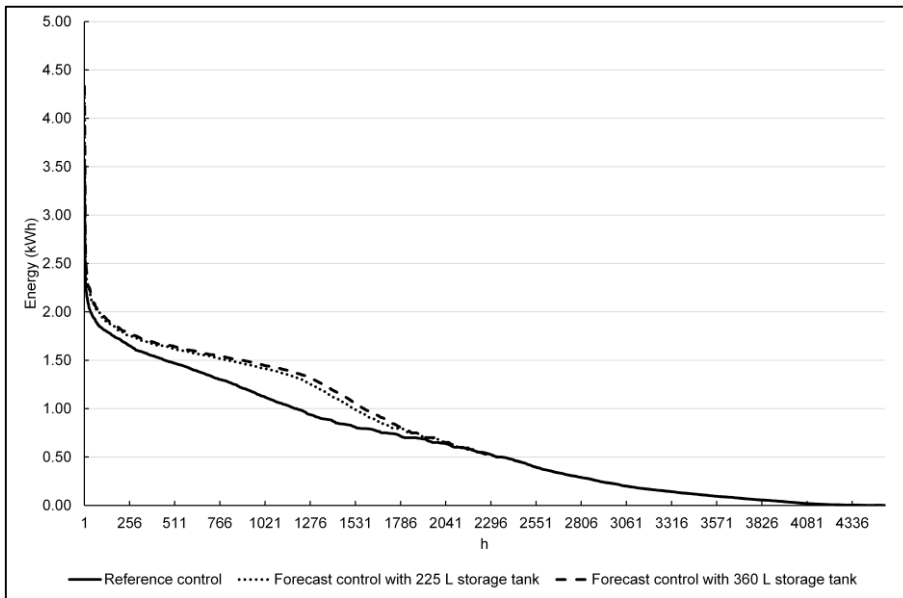

Figure 17. Annual duration of PV electricity self-consumption.

Due to the small increase in self-consumption, the weather forecast controller is not profitable with the assumptions used in the calculations and specified in chapter 5.3.

Sensitivity analysis of the discount rate, annual cost and annual electricity price change reveals, as presented in figure 18, that the weather forecast controller is not profitable with the chosen minimum and maximum values used

in the sensitivity analysis. As an example, the annual electricity price change would have to be 25 % in order to make the controller profitable.

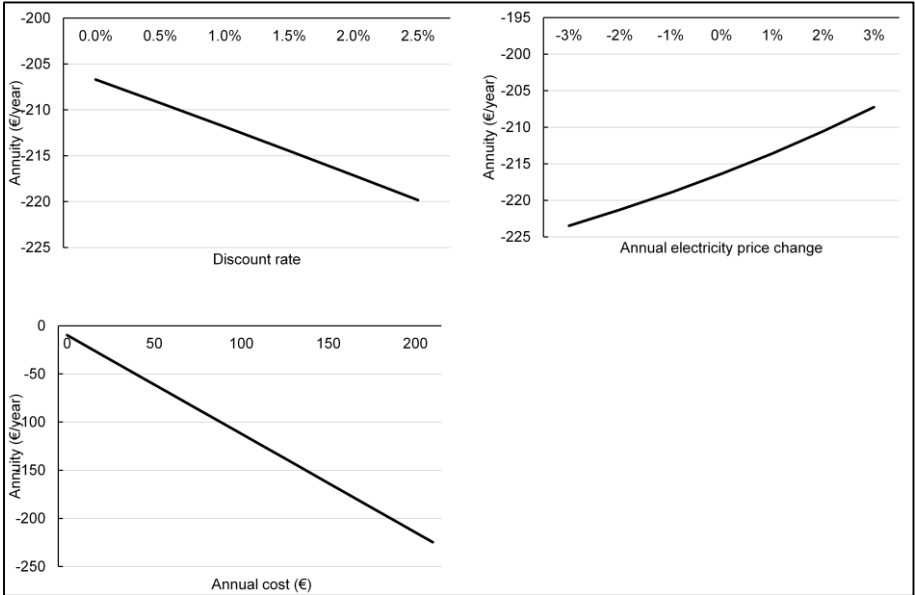

Figure 18. Sensitivity analysis of the discount rate, annual cost and annual electricity price change.

#### 7.4. Analysis of how the proposed Swedish definition of near zero energy buildings manages PV electricity

The Swedish National Board of Housing, Building and Planning has developed a proposal for a national NZEB definition. This definition is based on the current Swedish building regulations which focus on purchased energy. This is discussed in detail in chapter 3.2.

The proposed definition focuses on different weighing factors for fuels and different usages of energy as presented in equation 4.

$$E_{spec} = ((E_{Elec,heating} + E_{Elec,DHW} + E_{Elec,Cooling}) \times 2.5 + E_{Elec,building\ Services} + E_{Heating} + E_{DHW} + E_{Cooling})/A_{temp} \quad (2)$$

where

$E_{\text{spec}}$	Building specific energy demand
$E_{\text{Elec,heating}}$	Electricity used for heating
$E_{\text{Elec,DHW}}$	Electricity used for DHW
$E_{\text{Elec,cooling}}$	Electricity used for cooling
$E_{\text{Elec, building services}}$	Electricity used for building services, eg. fans and pumps etc.
$E_{\text{heating}}$	Other energy than electricity used for heating
$E_{\text{DHW}}$	Other energy than electricity used for DHW
$E_{\text{cooling}}$	Other energy than electricity used for cooling
$A_{\text{temp}}$	Living area heated to 10°C or more

If electricity is used for heating, cooling or DHW production, the electricity has a weighing factor of 2.5, and if it is used for building services it has a weighing factor of 1. Household electricity is not part of the building specific energy demand.

PV electricity is considered an energy efficiency measure in the proposal. This means that PV electricity used in the building will reduce the specific energy demand of the building.

Without weighing factors, the different cases presented further down in this chapter would give the same specific energy demand. With the proposed NZEB definition, PV electricity used for the heating, DHW and cooling is 2.5 times more valuable than PV electricity used for building services.

This proposal leads to uncertainties during the modelling and simulation phase of building projects and might lead to large differences in measured and simulated specific energy demand. Different electrical loads can be active at the same time as PV electricity is generated. It is hard to know which of the loads the electricity from the PV system reduces, especially if the PV electricity generation at a given moment is lower than the total electricity load demand in the building.

Two different cases for a building with both types of heat pumps, GSHP and EAHP, with different assumptions of PV electricity usage are compared.

In  $SC1_{\text{GSHP}}$  it is assumed that the PV electricity first reduces the need for purchased electricity used by the HRV and secondarily reduces the purchased electricity used by the GSHP. For  $SC1_{\text{EAHP}}$  it is assumed that the PV electricity first reduces the amount of purchased electricity to the EAHP.

In  $SC2_{\text{GSHP}}$  it is assumed that the PV electricity first reduces the need for household electricity and secondarily the electricity used for the HRV and lastly the electricity used by the GSHP. In  $SC2_{\text{EAHP}}$  the PV electricity first reduces the need for household electricity and the EAHP last. Different electricity loads in the building are presented graphically in figure 19.

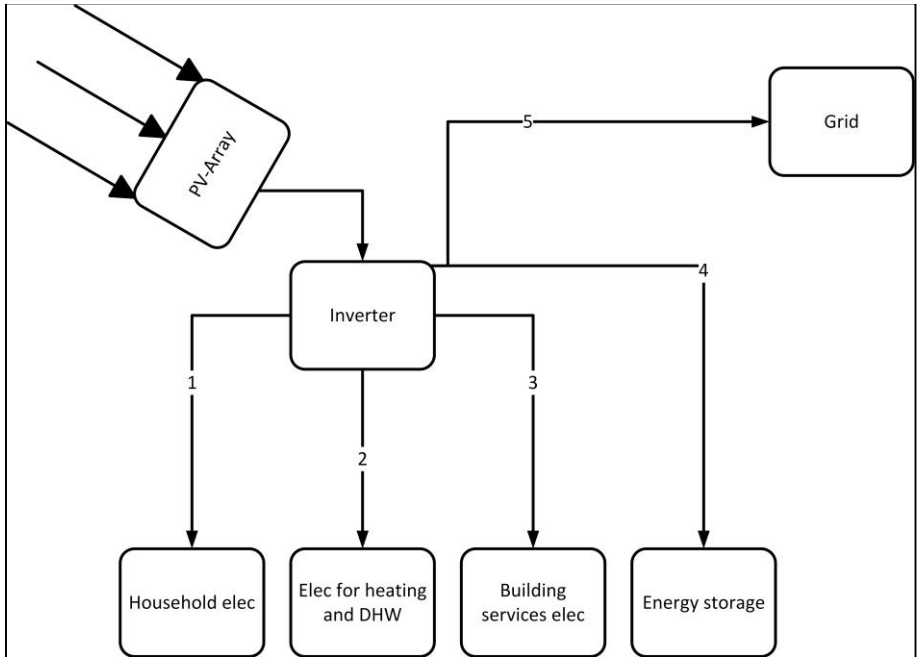

Figure 19. Different electricity loads in the building.

The buildings with GSHP and EAHP but without a PV system have a specific energy demand of 73 kWh/m<sup>2</sup> and 101 kWh/m<sup>2</sup> respectively. This is below the limit of 80 kWh/m<sup>2</sup> for the GSHP building and above the limit for the EAHP building.

With the PV system described in chapter 6.2, together with the SC1 assumptions, the specific energy demand of the GSHP and EAHP buildings is 47 kWh/m<sup>2</sup> and 82 kWh/m<sup>2</sup> respectively and 53 kWh/m<sup>2</sup> and 88 kWh/m<sup>2</sup> respectively for case SC2.

The difference between the cases is 6 kWh/m<sup>2</sup> for both the GSHP and EAHP buildings equivalent to a difference in specific energy demand of 13% and 7% respectively between case SC1 and SC2. This is a fairly large difference and is especially challenging for buildings that are close to the demand limit as specified in the NZEB definition proposal. It can even be possible to pass the limit by slightly changing the assumptions of PV electricity usage in the building simulations.

How PV system size affects the specific energy demand of the two heat pump buildings and cases is presented in figure 20.

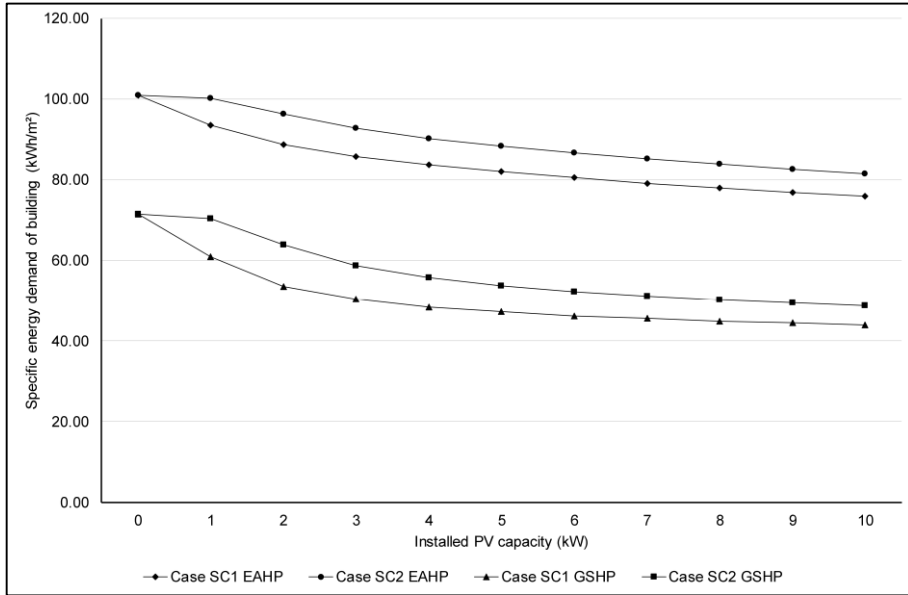

Figure 20. Specific energy demand with different PV-system sizes.

As presented in figure 20 the effect of the PV system's size on the specific energy demand rapidly decreases and above 2 – 3 kW<sub>p</sub> it has a marginal effect. The additional electricity from a larger PV system will reduce the purchased household electricity demand to some extent and the rest will be fed into the grid. The reason for the small effect of PV systems larger than 3 kW<sub>p</sub> is that the electricity demand during the day has a low match with the PV electricity generation as presented in figure 21.

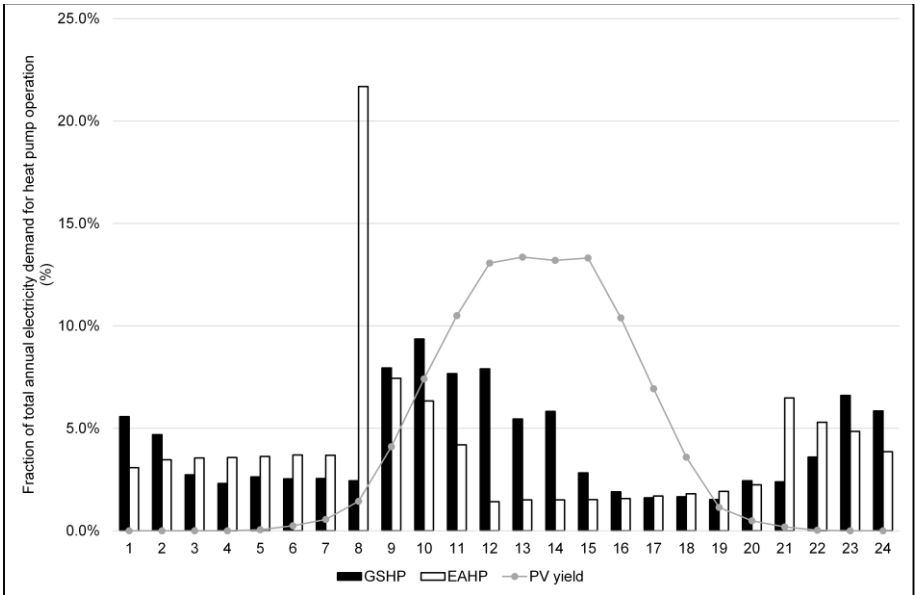

Figure 21. Fraction of annual electricity usage for heat pump operation.

The reason for the large electricity demand of the EAHP during the morning is the large DHW and heating demand of the building in combination with the fact that the ambient temperature is at its lowest during hours 2 – 7. The GSHP has an easier task supplying the heat and DHW demand because the heat recovery of the ventilation air lowers the peak load for heating.

Self-consumption of PV electricity will be affected by the distribution of the electricity demand during the day. Higher electricity demand during hours of PV electricity generation will lead to higher self-consumption. This is the reason for the GSHP building having a higher self-consumption and solar energy fraction than the EAHP building.

The specific energy demand, self-consumption fraction and solar energy fraction are presented in table 10.

Table 10. Specific energy demand, self-consumption fraction and solar energy fraction for the different heat pump types and cases with a 5.29 kWp PV system.

	<i>GSHP</i>	<i>EAHP</i>
Specific energy demand w/o PV-system (kWh/m <sup>2</sup> )	73	101
Specific energy demand, SC1 (kWh/m <sup>2</sup> )	47	82
Specific energy demand, SC2 (kWh/m <sup>2</sup> )	53	88
Self-consumption fraction, SC1 (%)	21	21
Self-consumption fraction, SC2 (%)	16	14
Solar energy fraction, SC1 (%)	30	19
Solar energy fraction, SC2 (%)	23	13



## 8. Conclusions

In this thesis different solar energy systems and metering schemes have been simulated and analyzed. For each system the profitability and solar energy fraction have been analyzed and in addition the level of self-consumption has been evaluated for the systems with energy storage and the systems in the NZEB analysis.

It was demonstrated that a system with a GSHP, a PV system and a monthly net metering scheme is the most profitable system and has the highest level of solar energy fraction of all the systems evaluated (RQ1).

The degree of profitability depends mainly on the cost of the PV system, the electricity price and the metering scheme used by the electricity grid owner.

If the grid owner uses real-time metering a complementary storage system is needed to enhance the solar energy fraction and the level of self-consumption (RQ1).

A correctly dimensioned GSHP in combination with a solar thermal system is considered an ineffective system due to the low solar energy fraction in the building and the profitability (RQ1).

A hot water storage system is almost as effective as battery storage if the solar energy fraction and the level of self-consumption are considered.

From all the evaluated storage systems, the only one close to being profitable was the hot water storage one. Due to the high system losses, the high costs and the short life span lead acid battery systems are for the moment considered not profitable (RQ2).

From the consumers' side, one of the most effective ways of increasing the profitability of PV systems is the implementation of net metering. In addition, the most effective way of maximizing self-consumption is the use of hot water storage.

The weather forecast control increases self-consumption by seven percentage points and this increase is too small to make the controller profitable (RQ3).

Self-consumption fractions are equal for the different heat pumps in case SC1 but the GSHP has a higher fraction in case SC2 (RQ4). The GSHP has the highest solar energy fraction for both cases (RQ4).

The distribution of the heat pump electrical load during the day has the largest effect on self-consumption of PV electricity (RQ5). This also have a large effect on the building specific energy demand. Assumptions made on

what load the PV electricity reduce have a fairly large impact on the building specific energy demand and this will affect buildings close to the limit in the NZEB definition (RQ5).

The main conclusion of this thesis is that from all the evaluated systems the GSHP in combination with a PV system is the most optimal system configuration in terms of profitability, self-consumption and solar energy fraction if monthly net metering is implemented. In case monthly net metering is not implemented, the system needs to be complemented with a hot water storage system, making this solution almost profitable (RQ1, 2 and 3).

## 9. Future work

Future work will focus on measurements in real buildings, validation and improvement of the simulation model. The work will also be expanded to include multi-family buildings and other commercial buildings, both regular and low energy buildings. In addition, general sizing strategies for PV systems on buildings will be developed. The focus of these strategies is high self-consumption in combination with high solar energy fractions. This is lacking in Sweden today.

Furthermore, net zero energy buildings will be evaluated and theoretical analyses will be conducted on how different heating systems affect a building's possibility to achieve net plus energy status and how the term net plus energy should be defined.

# References

- Annunziata, Eleonora., Frey, Marco., Rizzi, Francesco. 2013. Towards nearly zero-energy buildings: The state-of-art of national regulations in Europe. *Energy* 57:125–133
- Blomsterberg, Åke. 2011. Barriers to implementation of very low energy residential buildings and how to overcome them. NorthPass – Promotion of the Very low-energy house Concept to the North European Building Market – Report. Boverkets Byggregler: Boverket 2013
- Candanedo, Jose., Dehkordi Vahid, R. 2014. Simulation of model-based predictive control applied to a solar-assisted cold climate heat pump system. 3rd International High Performance Buildings Conference at Purdue, July 14–17, 2014
- Castillo-Cagigal, M., Gutiérrez, A., Monasterio-Huelin, F., Caamaño-Martín, E., Masa, D, Jiménez-Leube, J. 2011. A semi-distributed electric demand-side management system with PV generation for self-consumption enhancement. *Energy Conversion and Management* 52:2659–2666
- Castillo-Cagigal, M., Caamaño-Martín, E., Matallanas, E., Masa-Bote, D., Gutiérrez, A., Monasterio-Huelin, F., Jiménez-Leube, J. 2011. PV self-consumption optimization with storage and Active DSM for the residential sector. *Solar Energy* 85:2338–2348
- Chen, Hongbing., Ping, Wei. 2011. Numerical study on a novel photovoltaic/thermal heat pump system, *Energy Procedia* 12:547–553
- Dabaieh, Marwa., Makhlof Nahla N., Hosny, Omar M. 2016. Roof top PV retrofitting: A rehabilitation assessment towards nearly zero energy buildings in remote off-grid vernacular settlements in Egypt. *Solar Energy* 123:160–173.
- Dall'O', Giuliano., Belli, Valentina., Brolis, Mauro., Mozzi, Ivan., Fasano, Mauro. 2013. Nearly Zero-Energy Buildings of the Lombardy Region (Italy), a Case Study of High-Energy Performance Buildings. *Energies* 6:3506–3527
- Daud, Muhamad Zalani., Mohamed, Azah., Hannan, M.A. 2013. An improved control method of battery energy storage system for hourly dispatch of photovoltaic power sources. *Energy Conversion and Management* 73:256–270
- Deng S., et.al. 2011. Energy supply concepts for zero energy residential buildings in humid and dry climate. *Energy Conversion and Management* 52:2455–2460.
- Desideri, Umberto., Arcioni, Livia., Leonardi, Daniela., Cesaretti, Luca., Perugini, Perla., Agabitini, Elena., Evangelisti, Nicola. 2013. Design of a multipurpose “zero energy consumption” building according to European Directive 2010/31/EU: Architectural and technical plants solutions. *Energy* 58:157–167.
- Desoto, W., Klein, S.A., Beckman, W.A. 2006. Improvement and validation of a model for photovoltaic array performance. *Solar Energy* 80:78–88
- Eicher, Sara., Hildbrand, Catherine., Bony, Jacques., Bunea, Mircea., Hadorn, Jean-Christophe., Citherlet, Stéphane. 2012. Solar assisted heat pump for domestic hot water production. *Energy Procedia* 30:571–579.
- European Commission, EU Energy in Figures, Statistical Pocketbook. Doi: 10.2833/11169, 2012.

- European Solar Thermal Industry Federation. Solar Thermal Markets in Europe. Trends and Market Statistics 2014
- European Union. Directive 2009/28/EC of the European parliament and of the council of 23 April 2009 on the promotion of the use of energy from renewable sources and amending and subsequently repealing Directives 2001/77/EC and 2003/30/EC. 2009
- European Union. Directive 2009/29/EC of the European parliament and of the council of 23 April 2009 amending Directive 2003/87/EC so as to improve and extend the greenhouse gas emission allowance trading scheme of the Community. 2009
- European Union. Directive 2010/31/EU of the European Parliament and of the Council of 19 May 2010 on the energy performance of buildings.
- European Union. Directive 2012/27/ of the European parliament and of the council of 25 October 2012 on energy efficiency, amending Directives 2009/125/EC and 2010/30/EU and repealing Directives 2004/8/EC and 2006/32/EC. 2012
- Gann, David M., Wang, Yusi., Hawkins, Richard. 1998. Do regulations encourage innovation? - the case of energy efficiency in housing. *Building Research & Information* 26(4):280–296
- Hartmann N., Glueck C. and Schmidt F.P. 2011. Solar cooling for small office buildings: Comparison of solar thermal and photovoltaic options for two different European climates. *Renewable Energy* 36: 1329 - 1338.
- Ikegami, Takashi., Kataoka, Kazuto., Iwafune, Yumiko., Ogimoto, Kazuhiko. 2012. Optimal Demand Controls for a Heat Pump Water Heater under Different Objective Functions. 2012 IEEE International Conference on Power System Technology (POWERCON). 1-5
- Ijaz Dar, Usman., Sartori, Igor., Georges, Laurent., Novakovic, Vojislav. 2014. Advanced control of heat pumps for improved flexibility of Net-ZEB towards the grid. *Energy and Buildings* 69:74–84
- Kjellsson, Elisabeth. 2009. Solar Collectors Combined with Ground-Source Heat Pumps in Dwellings, Analyses of System Performance. Lund University, Sweden, Ph.D. Thesis
- Klein, S.A. et al., TRNSYS 17, A Transient System Simulation Program, User Manual Solar Energy Laboratory, University of Wisconsin-Madison, Madison, 2010
- Kovács, P., Solvärmsystem för småhus : kursmaterial för installatörer. 1998, Stockholm, Sweden: Byggeforskningsrådet, Svensk byggtjänst. ISBN: 91-540-5802-3.
- Lindahl, J., National Survey Report of PV Power Applications in Sweden 2015. International Energy Agency Co-operative programme on photovoltaic power systems, Task 1
- Luthander, Rasmus., Widén, Joakim., Nilsson, Daniel., Palm, Jenny. 2015. Photo-voltaic self-consumption in buildings: A review. *Applied Energy* 142:80–94
- Magrini, Anna., Magnani, Lorenza., Pernetti, Roberta. 2012. The effort to bring existing buildings towards the A class: A discussion on the application of calculation methodologies. *Applied Energy* 97:438–450.
- Marszal, Anna Joanna., Bourrelle, Julien S., Musall, Eike., Heiselberg, Per., Gustavsen, Aril., Voss, Karsten. 2010. Net Zero Energy Buildings: Calculation Methodologies versus National Building Codes. In *EuroSun: Book of Abstracts*. (pp. 22). EuroSun 2010.
- Marszal, Anna Joanna., Heiselberg, Per., Bourrelle, Julien S., Musall, Eike., Voss, Karsten., Sartori, I., Napolitano, A. 2011. Zero Energy Building – A review of definitions and calculation methodologies. *Energy and Buildings* 43:971–979.
- Masa-Bote, D., Castillo-Cagigal, M., Matallanas, E., Caamaño-Martín, E., Gutiérrez, A., Monasterio-Huelín, F., Jiménez-Leubec, J. 2014. Improving photovoltaics

- grid integration through short time forecasting and self-consumption. *Applied Energy* 125:103–113
- Morelli, Martin., Rønby, Leif., Mikkelsen, Svend Erik., Minzari, Maja G. Kilde-moes, Troels., Tommerup, Henrik M. 2012. Energy retrofitting of a typical old Danish multi-family building to a “nearly-zero” energy building based on experiences from a test apartment. *Energy and Buildings* 54:395–406.
- Obyn, Sophie., van Moeseke, Geoffrey. 2014. Comparison and discussion of heating systems for single-family homes in the framework of a renovation. *Energy Conversion and Management* 88:153–167.
- Purvins, Arturs., Papaioannou, Ioulia T., Debarberis, Luigi. 2013. Application of battery based storage systems in household-demand smoothing in electricity distribution grids. *Energy Conversion and Management* 65:272–284
- Reddy, Thomas. B. (ed.) 2011. *Linden’s Handbook of Batteries*. McGraw Hill
- Remund, Jan., Müller, Stefan., Kunz, Stefan., Huguenin-Landl, Barbara., Studer, Christian., Klauser, Daniel., Schilter, Christoph., Lehnherr, Reto. 2013. *Meteorom Global Meteorological Database Version 7*.
- Riesen, Yannick., Ding, Pengcheng., Monnier, Samuel., Wyrsh, Nicolas., Ballif, Christophe. 2013. PEAK SHAVING CAPABILITY OF HOUSEHOLD GRID-CONNECTED PV-SYSTEM WITH LOCAL STORAGE: A CASE STUDY. 28th European Photovoltaic Solar Energy Conference and Exhibition. Paris, France
- Riffonneau, Yann., Bacha, Seddik, Barruel, Franck, Ploix, Stephane. 2011. Optimal Power Flow Management for Grid Connected PV Systems with Batteries, *IEEE TRANSACTIONS ON SUSTAINABLE ENERGY* 2(3):309–320
- Salvador, Michaël., Grieu, Stéphane. 2012. Methodology for the design of energy production and storage systems in buildings: Minimization of the energy impact on the electricity grid. *Energy and Buildings* 47:659–673
- Sartori, Igor., Napolitano, Assunta., Voss, Karsten. 2012. Net zero energy buildings: A consistent definition framework. *Energy and Buildings* 48:220–232.
- Szalay, Zsuzsa., Zöld, András. 2014. Definition of nearly zero-energy building requirements based on a large building sample. *Energy Policy* 74:510–521.
- Statistics Sweden 2013. *Construction: New construction – completed residential buildings 2012*. BO 20 SM 1301.
- Statistics Sweden, *Prices on Electricity and Transmission of Electricity (Network Tariffs)*, 2013. [http://www.scb.se/en\\_/Finding-statistics/Statistics-by-subject-area/Energy/Price-trends-in-the-energy-sector/Prices-on-electricity-and-transmission-of-electricity-network-tariffs/Aktuell-Pong/6429/Tables-over-annual-values/Prices-on-electricity-for-different-kind-of-consumers-and-agreements-time-serie/](http://www.scb.se/en_/Finding-statistics/Statistics-by-subject-area/Energy/Price-trends-in-the-energy-sector/Prices-on-electricity-and-transmission-of-electricity-network-tariffs/Aktuell-Pong/6429/Tables-over-annual-values/Prices-on-electricity-for-different-kind-of-consumers-and-agreements-time-serie/) Last visited 2014-06-16
- Swedish Heat Pump Association (SVEP), 2013, <http://www.svepinfo.se/> (in Swedish). (2014-03-25)
- SwedishParliament, 2016, Law (1994:1776) on tax on energy.
- Timothy, P, Thornton, J.W. 2008. Simulation and model calibration of a large-scale solar seasonal storage system. Third National Conference of IBPSA-USA Berkeley, California, 2008
- Tsalikis, Georgios., Martinopoulos, Georgios. 2015. Solar energy systems potential for nearly net zero energy residential buildings. *Solar Energy* 115:743–756.
- Vanhoudt, D, Geysen, D, Claessens, B, Leemans, F, Jespers, L, Van Bael, J. 2014. An actively controlled residential heat pump: Potential on peak shaving and maximization of self-consumption of renewable energy. *Renewable Energy* 63:531–543

- Voll, Hendrik., Kosonen, Risto., Kurnitski, Jarek. 2013. Cost Optimal and Nearly Zero-Energy Buildings (nZEB) Definitions, Calculation Principles and Case Studies: London, Springer-Verlag London. Chapter 6, Basic Design Principles of nZEB Buildings in Scoping and Conceptual Design.
- Vrettos, Evangelos., Witzig, Andreas., Kurmann Roland., Koch, Stephan., Andersson, Göran. 2013. Maximizing Local PV Utilization Using Small-scale Batteries and Flexible Thermal Loads, 28th European PV Solar Energy Conference and Exhibition, Paris, France, 30 September–4 October 2013.
- Widén, Joakim., Wäckelgård, Ewa., Paatero, Jukka., Lund, Peter. 2010. Impacts of distributed photovoltaics on network voltages: Stochastic simulations of three Swedish low-voltage distribution grids. *Electric Power Systems Re-search* 80:1562–1571.
- Williams, C.J.C, Binder, J.O, Kelm, T. 2012. Demand Side Management through Heat Pumps, Thermal Storage and Battery Storage to Increase Local Self-Consumption and Grid Compatibility of PV Systems. 2012 3rd IEEE PES Innovative Smart Grid Technologies Europe (ISGT Europe), Berlin, 1-6.
- Xu, Guoying., Deng, Shiming., Zhang, Xiaosong., Yang, Lei., Zhang, Yuehong. 2009. Simulation of a photovoltaic/thermal heat pump system having a modified collector/evaporator, *Solar Energy* 83:1967–1976.
- Yuehong, Lu., Shengwei, Wang., Kui, Shan. 2015. Design optimization and optimal control of grid-connected and standalone nearly/net zero energy buildings. *Applied Energy* 155:463–477.
- Zong, Yi., Mihet-Popa, Lucian., Kullmann, Daniel., Thavlov, Anders., Gehrke, Oliver, Bindner, Henrik W. 2012. Model Predictive Controller for Active Demand Side Management with PV self-consumption in an intelligent building. 2012 3rd IEEE PES Innovative Smart Grid Technologies Europe (ISGT Europe), Berlin

# Appendices

## Appendix 1: Trnsys types

In this appendix all Trnsys types used in the simulations are briefly described.

### **Type 2, differential controller**

This controller outputs 0 or 1. The output is decided based on the difference between two temperatures compared to two dead band differences. The output is also dependent on the previous controller output.

### **Type 3b, variable speed pump**

The pump takes a variable control input and converts this to a mass flow rate based on a fixed user specified maximum mass flow rate.

This type can also calculate the power consumption, but that is not used in the simulations described in this thesis. This is because the power consumption of the pump is calculated in the GSHP type.

### **Type 11h, tee piece, mode 1**

This tee piece mixes two inlet flows of the same fluid but often different temperatures into one outlet flow.

### **Type 14h, time dependent forcing function**

This type is used in the simulations described in this thesis to force the heating of the DHW to 65 °C once a week.

One week is specified in the type which is repeated every week during the simulation period.

### **Type 15, weather data processor**

This type reads weather data files and calculates total radiation, beam radiation, sky diffuse radiation, ground reflected solar radiation, the angle of incidence of beam radiation, the slope and azimuth of many surfaces.

### **Type 31, Pipe or duct**

The pipe or duct type models the fluid flow in a pipe or duct.

This type is used to increase the thermal mass in the system, which leads to an increase in the convergence stability.



**Type 33, psychrometrics**

This type calls the TRNSYS Psychrometrics utility subroutine and calculates humidity ratio, wet bulb temperature, enthalpy, density of the air-water mixture, density of dry air only, relative humidity, dry bulb temperature and dew point temperature. These calculated outputs are used as inputs to the building type 56.

**Type 56, multizone building.**

This type models a building and its thermal behavior

**Type 69, effective sky temperature**

This type calculates the effective sky temperature that is used in type 56 to calculate amongst other things the long-wave radiation exchange from external building surfaces.

**Type 112b, single speed fan with humidity effects**

This type models an on/off controlled fan with a single speed. The inlet mass flow is only used for mass balance checks and the outlet mass flow is based on the user specified mass flow.

**Type 114, Constant speed pump**

This type models an on/off controlled single speed pump. The inlet mass flow is only used for mass balance checks and the outlet mass flow is based on the user specified mass flow.

**Type 194, photovoltaic array**

This type is based on a five parameter model which calculates current and power at a specified voltage and the same outputs at the maximum power point.

**Type 557a, vertical ground heat exchanger**

This type models a borehole with a vertical ground heat exchanger. The temperatures handled by the type are calculated by superposition.

**Type 647, flow diverter with up to 100 ports**

This type models a diverter valve that diverts a single mass flow to up to 100 flows.

The diverted flow is specified for every port by a fraction.

**Type 649, flow mixer with up to 100 ports**

This type models a mixing valve. The mixed flow is calculated by an energy balance.

**Type 760, air to air sensible heat exchanger**

This type models an air to air heat exchanger by effectiveness – minimum capacitance approach.

This means that the minimum capacitance air stream is calculated and then the sensible energy transfer at the minimum capacitance air stream is calculated.

**Type 917, air – water heat pump**

This type models an on/off controlled single stage heat pump and is used to simulate the EAHP. The type is based on external data files.

**Type 927, water – water heat pump**

This type models an on/off controlled single stage heat pump. The type is based on external data files. The data file for the simulations in this thesis was prepared by the author and based on a commercial available GSHP.

**Type 953, tempering valve controller**

This type models a controller that tempers a flow. Based on a set temperature it calculates the fraction of the flow that will go through the heater and the fraction that will bypass it.

In the simulations described in this thesis it is used for limiting the maximum DHW temperature that can be drawn from the DHW tank.

**Type 1243, water draw profile**

The inputs for this type are the total daily water draw and fractions for all hours of a day. The type calculates draws for time steps shorter than one hour.

**Type 1250, outside air reset controller**

This type outputs a temperature value based on two ambient temperatures and two temperature set point. This gives the possibility of specifying a supply temperature to a hydronic system.

It is possible to specify heating or cooling mode and the type also outputs an on/off signal.

**Type 1265, tank in tank**

This type models a storage tank with an internal immersed tank with two ports.

## Appendix 2: Building description

The simulated building, placed in Västerås, Sweden, is a simplified building with one thermal zone. The building has the dimensions 13.8 x 10 m and a flat roof. The average building U-value is 0.13 W/m<sup>2</sup>, K

In total there are 8 windows in the building, 2 in every direction. The area of a single window is 2.5 m<sup>2</sup> and the ratio of window area to wall area is 14 % and the ratio of window area to floor area is 14.5 %.

The larger outer walls with a length of 13.8 m are facing south and north.

The foundation is a slab on grade with internal floor heating. The spacing of the floor heating pipes in the foundation is 300 mm from center to center, the outside diameter of the pipe is 20 mm and the thickness of the pipes is 2 mm. The heating system covers the entire building area.

