

LSAR – The missing link for performance-based logistics

www.siemens.com/plm

white paper



- ▶ Drawing dispersed logistics data together into a single managed environment drives information both upstream and downstream to provide effective lifecycle management.

PLM Software

Answers for industry.

SIEMENS

Table of contents

Introduction 1

The purpose of LSAR 2

LSA methodology 3

Evolution of standards 5

U.S. Department of Defense 5

The European military 5

The alphabet soup of product after-market support: 6

The migration from organic to ICS to CLS to PBL 6

ICS: Interim contractor support 6

CLS: Contractor logistics support 7

PBL: Performance-based logistics 7

Teamcenter – Product lifecycle management 7

The Role of LSAR in product lifecycle management 8

How the ILS process gets done 8

The series of LSA tasks 9

Logistics control number (LCN) 10

Two types of LCNs: functional and physical 10

How Teamcenter could support LSAR 11

LSAR tables 12

Populating the data tables 12

Performance-based logistics (PBL) policy update 14

New U.S. DoD management initiative decision 917 (MID 917) 14

Lessons learned from PBL programs: Focus on the metrics 15

Summary 17

List of figures and tables

Figure 1: Where LSAR fits into the high level business flow: the bridge to PBL 2

Figure 2: The defense acquisition management framework, DoDI 5000.2, 12 May 03 2

Figure 3: LSA data documentation process 3

Figure 4: LSA data 4

Figure 5: Integration can provide total product lifecycle support 6

Figure 6: Logistics data model 7

Figure 7: ILS Department of Defense methodology 8

Figure 8: LSAR data flow and system engineering interface 9

Figure 9: Classical LCN assignment method 10

Figure 10: Physical vs. functional LCN assignment 11

Figure 11: LSAR data tables 12

Figure 12: Integrated logistics support program 13

Figure 13: PBL emphasis 14

Table 1: Lockheed Martin’s F-117 TSPR contract profile and metric results 15

Table 2: Boeing’s C-17 PBL contract profile and metric results 16

Historically the logistics data has been created and managed in a range of specialized niche solutions. Interaction between these solutions is invariably done manually by highly trained logistics personnel. While cumbersome, this system has been shown to work for many years. It does however have one major flaw – management of change. Due to the time it takes to collate and manipulate this data, the current approach is more of a snapshot in time to satisfy a data deliverable. As support models shift more towards industry, this limitation comes to the fore. For organizations to cross the chasm between delivering data and using it, a different more integrated approach is required.

This white paper explores the data complexity for logistics and the standards that underlie the whole process. It shows the significance of the LSAR and how with the use of modern software platforms it can be used to draw all this data together into a single managed environment. When this platform is used across the enterprise by all the business functions, including engineering, purchasing and manufacturing, the opportunity exists to have a single change process that can effectively drive information both upstream and downstream to provide effective lifecycle management.

► The purpose of LSAR

The logistics support analysis record (LSAR) is a major component of the logistics support analysis (LSA) process for military weapons systems acquisition and sustainment. This includes modern sustainment programs like performance-based logistics (PBL) which are performed by original equipment manufacturers. LSA provides a comprehensive means for identifying, defining, analyzing, qualifying and quantifying logistics requirements to achieve balance among performance, operational readiness, reliability, maintainability, vulnerability, survivability, operating and support costs, supportability and logistics requirements, thereby optimizing the overall support system.

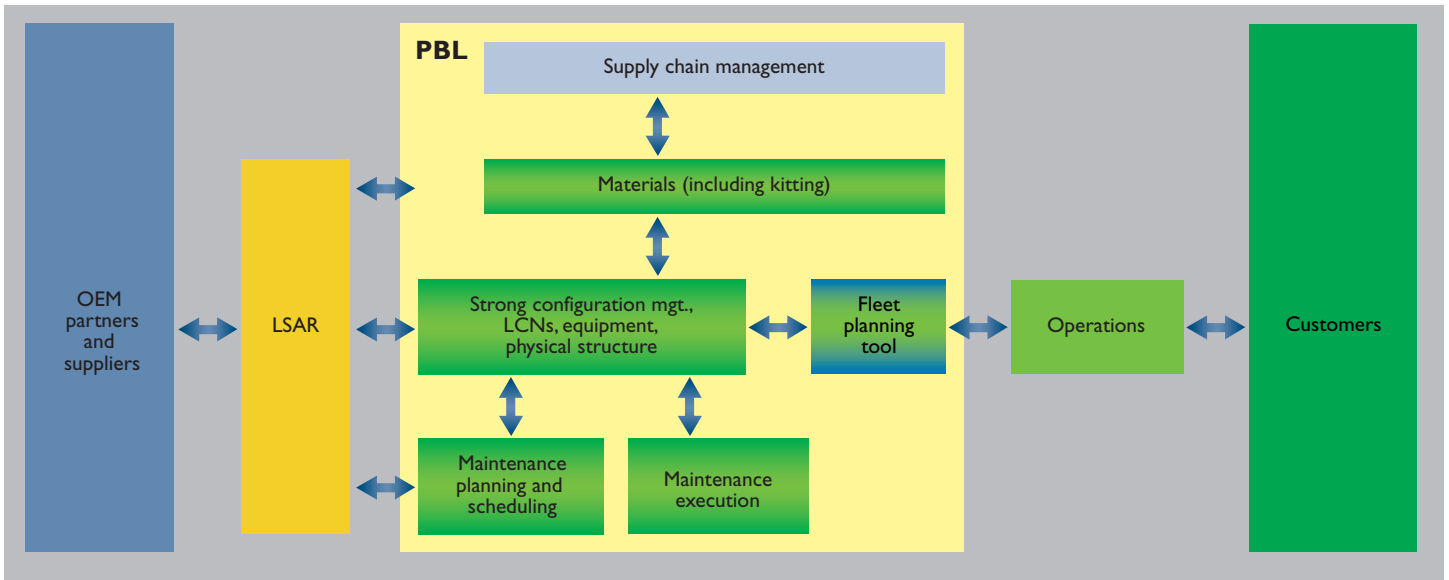

Figure 1: Where LSAR fits into the high-level business flow: the bridge to PBL

DoD 5000.1, The Defense Acquisition System requires program managers to develop and implement performance-based logistics (PBL) strategies that optimize total system availability while minimizing cost and logistic footprints.

The five major phases of the military acquisition process as defined in DoD Directive 5000.1 and DoD Instruction 5000.2 standards are shown in Figure 2:

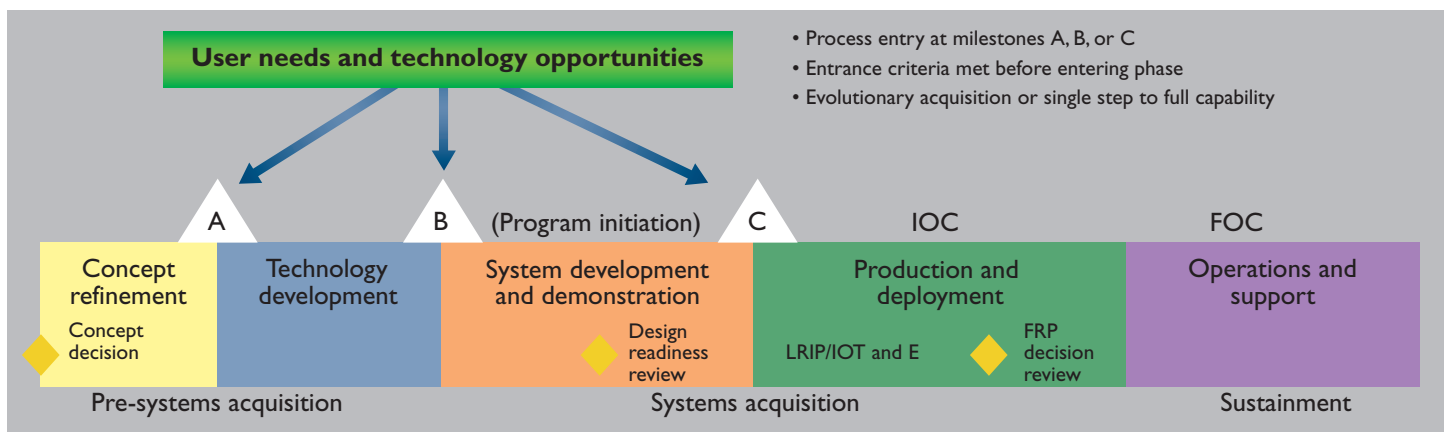

Figure 2: The defense acquisition management framework, DoDI 5000.2, 12 May 03

► LSA methodology

The objective of LSA is to provide a single, uniform approach by the military services for conducting those activities necessary to:

- 1 Cause supportability requirements to be an integral part of system requirements and design
- 2 Define support requirements that are optimally related to the design and to each other
- 3 Define the required support during the operation phase
- 4 Prepare associated data products such as the LSAR which is defined by MIL-STD-I388. The LSA Process is shown in Figure 3

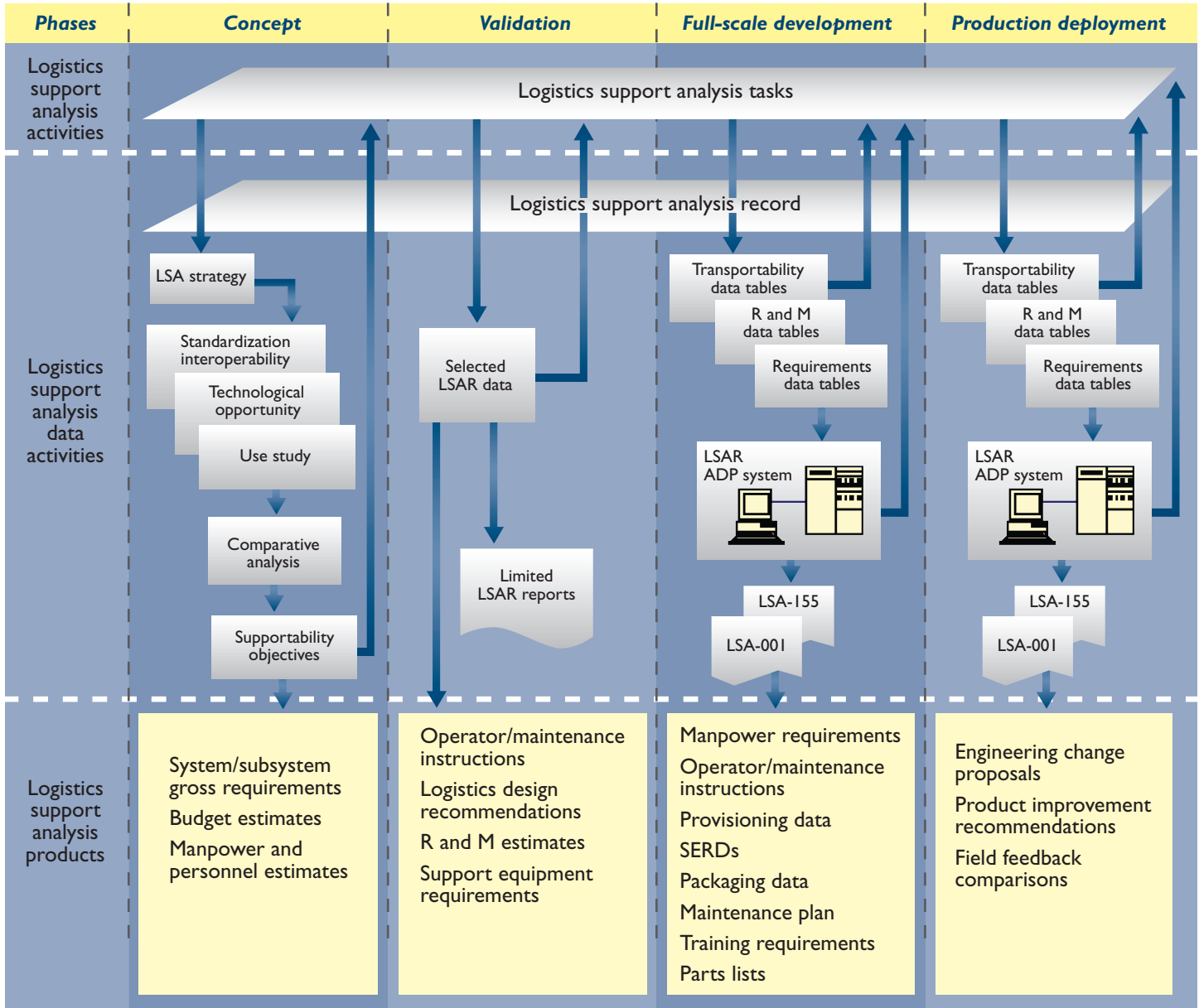

Figure 3: LSA data documentation process

This paper explores how the LSAR is developed as part of the LSA process and why the data elements created and maintained in its associated database are needed for an OEM to achieve minimal risk in executing performance-based logistics contracts for the military services (for example Air Force, Navy, Army, Marines) and thereby receiving maximum incentive fee (i.e., profit) on PBL revenues. Over the lifetime of the product, this after-market revenue can provide 3-5 times more revenue than the OEM was originally paid for the design and production of the original weapons system. The LSA data is shown in Figure 4.

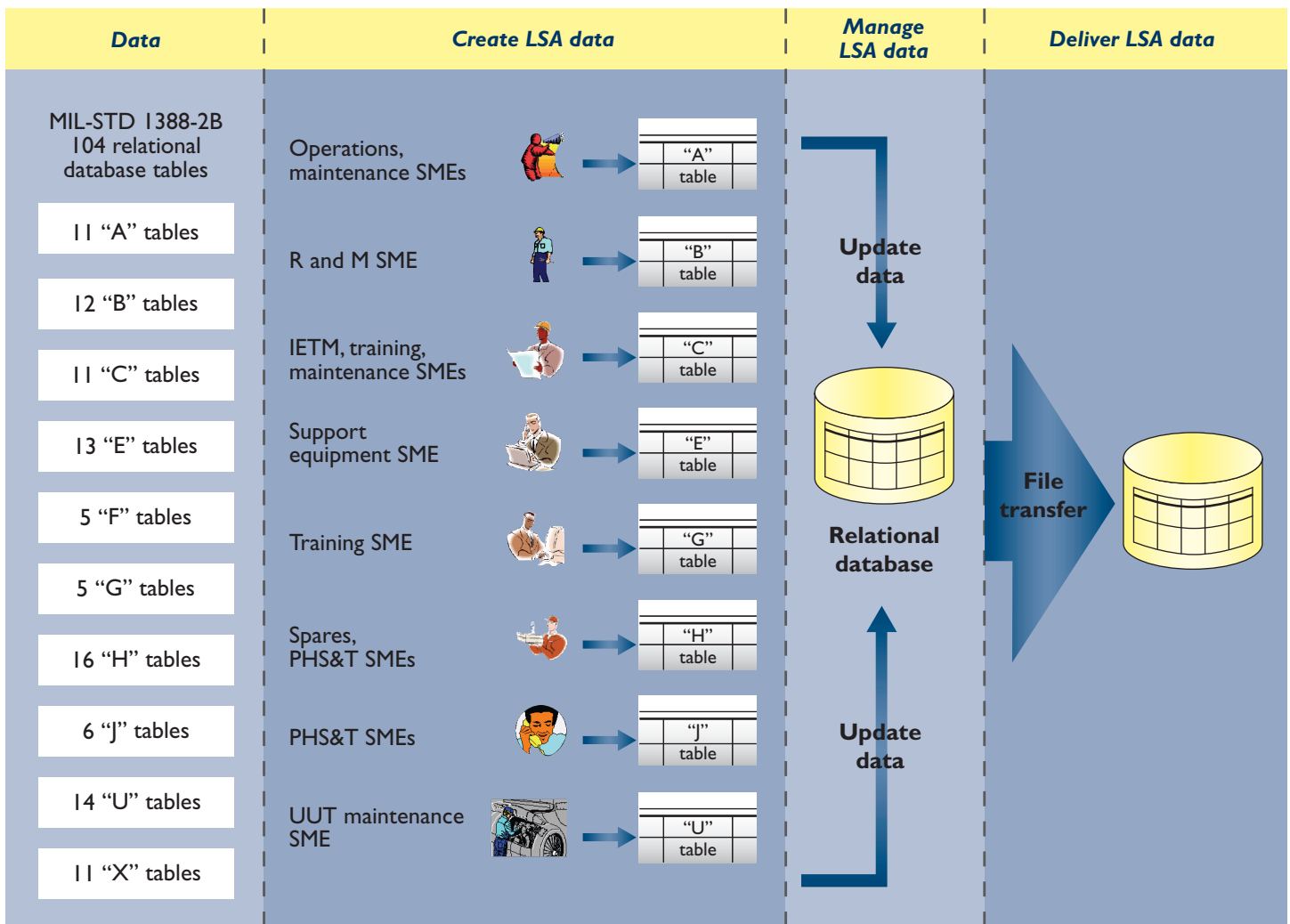

Figure 4: LSA data

LSAR largely owes its heritage to the CALS initiative begun by the U.S. Defense Department in 1985. In later years, NATO (the North Atlantic Treaty Organization) also took up the CALS banner and started its own program called NATO CALS. The acronym “CALS” has taken on many word combinations over the years, but the meaning has remained the same. Its purpose is and was to facilitate the integration of digital information for weapons system acquisition, design, manufacture and support functions. In the digital age of the 21st century, this may seem to be “business as usual,” but in the computer mainframe era of the 1980s military programs consisted of mainly paper processes and data accompanied by federated systems of “batch programs.” Considering that CALS first meaning was “Computer Aided Logistics Support,” which changed to “Continuous Acquisition Lifecycle Support,” the concept of using Information Technology to manage Product Lifecycle Management throughout the lifetime of a military asset seems to be a natural evolution.

U.S. Department of Defense

CALS was released by the DoD as MIL-HDBK-59B and the U.S. Deputy Under Secretary of Defense mandated CALS implementation in August 1988. Military programs of that era, including the Northrop B-2 Stealth Bomber (now Northrop Grumman), the McDonnell Douglas C-17 Globemaster (now Boeing) and V-22 Osprey (Bell-Boeing) began employing CALS including LSAR. The U.S. Army Materiel Readiness Support Activity initially sponsored MIL-STD-1388-2A for LSAR, and in March 1991 the combined services of the U.S. Army, Navy, Air Force and Marines and Federal Aviation Administration collaborated to author and publish MIL-STD-1388-2B. At that same time, the DoD and Joint Services along with the Defense Logistics Agency (DLA) established JCALS (Joint Computer Aided Acquisition and Logistics Support) and created JEDMICS (Joint Engineering Document Management Information Control System) which is a database for weapons systems engineering drawings. In addition CALS required the U.S. Prime Contractor OEM to create a MIL-STD-974 Contractor Integrated Technical Information System (CITIS) which

requires LSAR data to be included with Interactive Electronic Technical Manual (IETMs), Support Equipment Recommendation Data (SERDs) and Training Data. IETMs were based on MIL-M-87268 and MIL-D-87269 using MIL-D-28001 for SGML authoring of text and MIL-R-28002 CCITT Group 4 and MIL-D-28003 CGM for Graphics.

The European military

In Europe, the Association Europeenne Des Constructeurs De Material Aerospatiale (AECMA) developed their own related standards, one for IETMs (AECMA 1000D) and one for Illustrated Parts Catalog and Provisioning (AECMA 2000M). Also in Europe, NATO Headquarters in Brussels, Belgium began addressing CALS in 1991. Subsequently, the NATO CALS Organization was formed in 1994 with a memorandum of understanding between 12 NATO nations. Military and civilian personnel began serving full-time onsite at NATO Headquarters in Brussels from the U.K, Spain, France, Germany, Italy, Norway and the United States. The member nations performed studies, workshops and development projects which were managed out of the NATO CALS Program Office at NATO Headquarters staffed by member nations. As a result, NATO CALS Data Model Version 3.0 was published in May 1998 and Version 4.0 in January 2000. The NATO CALS Data Model is based on three standards: MIL-STD-1388-2B for LSAR, AECMA 1000D for IETMs and AECMA 2000M for Illustrated Parts Catalog and Provisioning.

The U.K. Ministry of Defense has also created their version of MIL-STD-1388-2B which is called Def Stn 00-60. The U.K. standard has some minor additions. To support large international new aircraft and other weapons system development opportunities, NATO CALS is viewed not only as an Information Technology strategy but also as a means of business process transition for programs like the NH90 Helicopter. Applying the newer concepts of NATO CALS enables OEMs to take part in the global marketplace, work effectively with their international partners, increase efficiency, attain higher output in the business process and take on new roles such as performance-based logistics.

► The alphabet soup of product after-market support

The migration from organic to ICS to CLS to PBL

The military services today require high availability of expensive assets (those worth tens to hundreds of millions of dollars each) with long lifecycles (for example over 20 years) to be mission capable for quick deployment all over the globe which requires an “agile logistics” concept.

Traditionally, the after-market support infrastructure has been based on the original equipment manufacturers providing spare parts and data for 3-level organic support for the maintenance and supply aspects (organizational, intermediate and depot). This has led to low mission-capable rates (MICAP), inadequate spare parts for repair and “depot possessed” weapons systems whose programmed depot maintenance (PDM) cycle, for example, grounded KC-135 and C-5 aircraft for up to one year and more in government-owned hangers. Much of the data for out-of-production aircraft, for example, is paper based and the systems that manage the maintenance, repair and overhaul processes at all three levels are 1970’s-1980’s vintage mainframe applications.

Aircraft based on CALS have now entered service and the digital data processes used in their development can now be leveraged to address improving their sustainment and field upgrades (i.e. engineering changes and modifications). Digital LSAR data developed and updated during the military weapons system requirements concept definition and

acquisition planning stage through to the design, development, manufacturing, flight testing and delivery can now be utilized for the operations and use stages. The LSAR along with associated items like IETMS produced from it will support the entire product lifecycle for the four major product data configurations of the “as defined,” “as planned,” “as built,” and “as maintained” configurations as shown in Figure 5.

ICS: Interim contractor support

ICS contracts have been awarded by the military services to the prime contractors to provide initial maintenance on weapon systems. ICS contractors provide maintenance services to fill the time gap between the initial delivery of low-rate initial production (LRIP) weapons systems (for example aircraft) and the completion of infrastructure upgrades to government-owned intermediate and depot maintenance facilities (buildings, equipment, tooling, personnel skills) needed for government to take over repair and overhaul of those systems. The prime contractor serves in an interim capacity to maintain a weapons system on behalf of the military, while at the same time ramping up for full-scale production and deliveries of larger quantities of that weapons system. Eventually, the government-owned facilities on U.S. Air Force Air Bases and Air Logistics Centers (ALCs), U.S. Navy Naval Bases and Naval Depots (NADEPs), etc. assume MRO responsibility from the prime contractor.

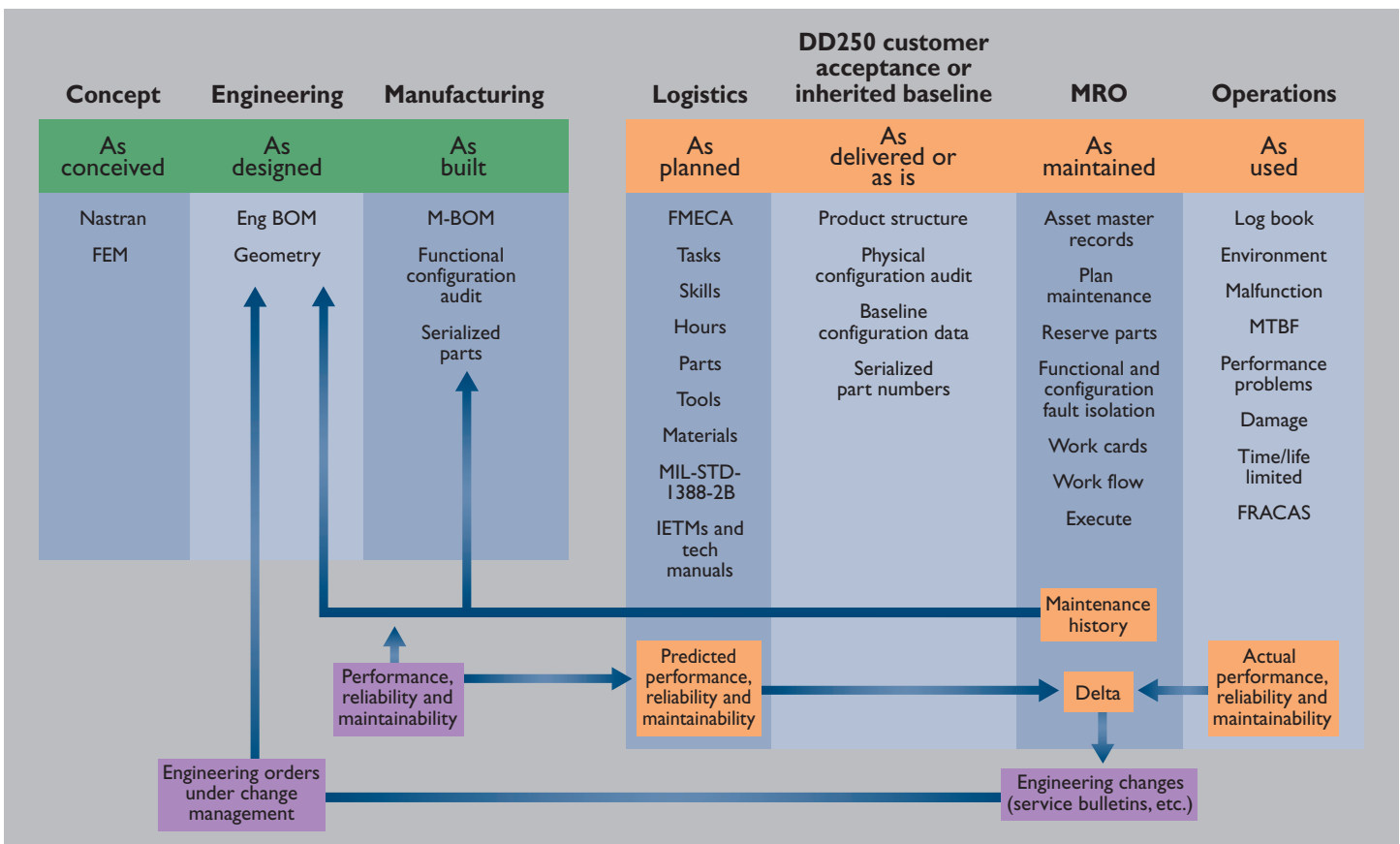

Figure 5: Integration can provide total product lifecycle support

CLS: Contractor logistics support

CLS is another after-market contract type which appeared in the late 1990s. One well-documented success of CLS is the 8-year program awarded to Lockheed Martin Skunk Works (LMSW) in FY 1999. The full name of the program is “F-117 Nighthawk CLS TSPR (total systems program responsibility).” Other CLS programs include Northrop Grumman’s B-2 Stealth Bomber and the Joint Strike Fighter. More details on CLS will be described in the last section of this paper.

PBL: Performance-based logistics

PBL is the most recent contract vehicle, with demonstrated successes in the F-117 and other programs. The recent \$4.9 billion award to Boeing for the C-17 Globemaster performance-based logistics is for 8 years of support leading up to a fleet size of 180 aircraft with annual pre-priced options for FY 04-FY 08. These contracts came about through a progression of incremental steps leading to the prime contractor OEM assuming higher levels of responsibility and risk, along with higher performance levels for aircraft sustainment. More details will be described in the last section of this paper.

Teamcenter – Product lifecycle management

The key to effectively achieving the above is configuration and change management. To achieve this across the complexity of data structures across each stage of the lifecycle shown is very problematic, as the data is usually stored in a myriad of different systems. While it is possible to develop integrations between these systems or link them via middleware, the problem of tight configuration management is extremely difficult to resolve.

Certain organizations have tried to build from scratch solutions that manage these data structures, however invariably this has been done by niche vendors who have not had the critical mass to make the appropriate investment. Siemens’ Teamcenter® software solution leverages the thousands of man-years spent to date developing the core capability to provide a solution that can manage the data, not just in-service, but across the whole product lifecycle, making the vision of a single threaded change/configuration management solution a reality.

Figure 6 shows an example of a Teamcenter data model that is being used in production to configuration manage logistics data.

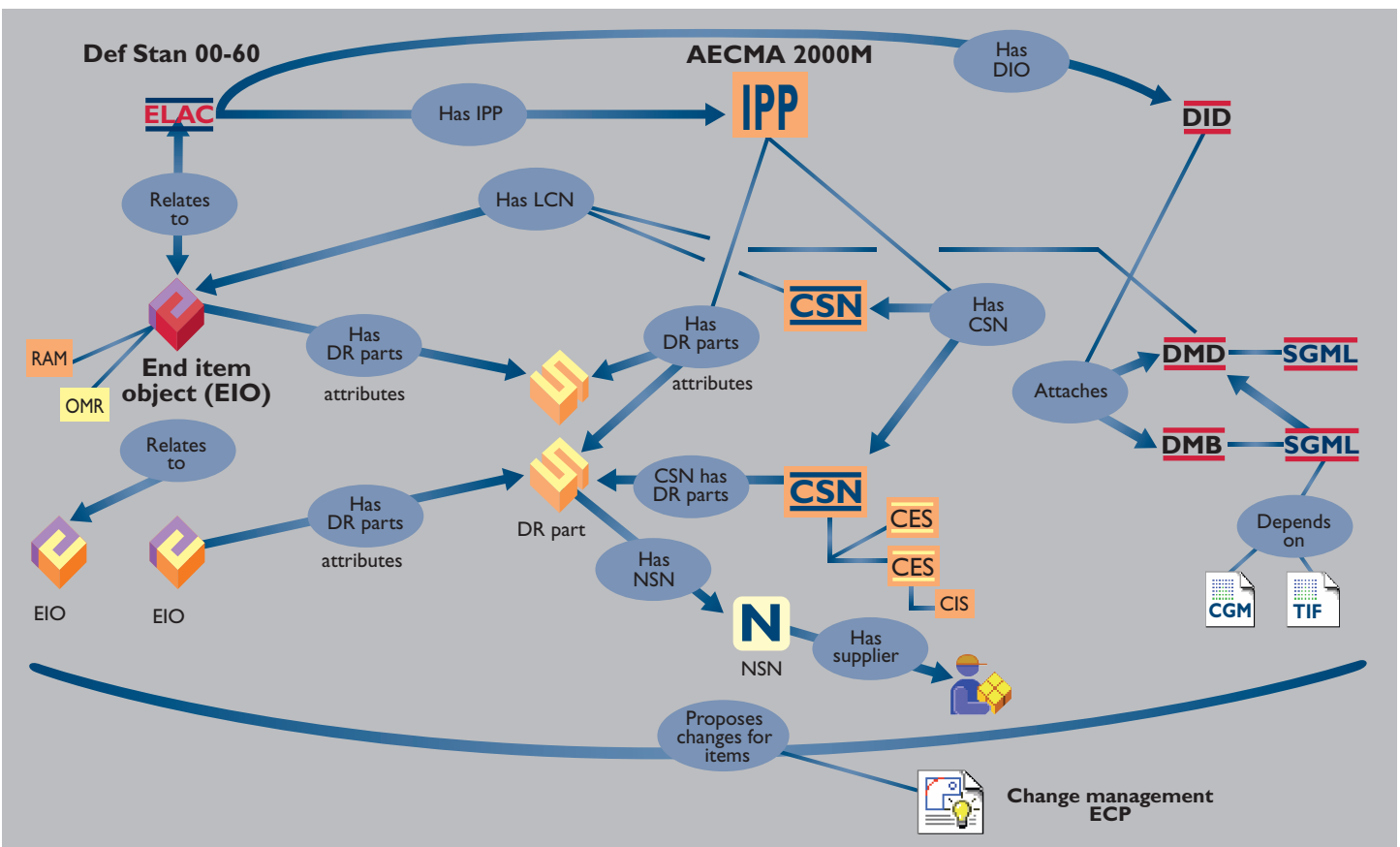

Figure 6: Logistics data model

► The role of LSAR in product lifecycle management

The last, and longest phase of any weapons system's lifecycle is its operations and use stage, which may continue for well over twenty years. In recent years, the military has been exceeding the design life by almost unbelievable numbers of years, as witnessed by aircraft such as the B-52 which was first produced more than fifty years ago. As with all weapons systems, engineering changes continue throughout the product lifecycle. The requirement for lifecycle maintenance, repair and overhaul including modifications brought about by changes, whether due to reliability or performance improvements, ripple throughout the entire military and industrial base of OEM organizations, thus creating the need for a product lifecycle management capability to track the

product data in the "as delivered" and subsequent "as maintained" configurations by part serial number and date effectivity for controlled components. The bridge between the "as built" configuration and the "as maintained" configuration is the LSAR.

How the ILS process gets done

Integrated logistics support (ILS) is traditionally accomplished using the methodology originally developed by the U.S. Department of Defense comprising MIL-STD-1388-1A, MIL-STD-1388-2A and MIL-STD-1388-2B as shown in Figure 7.

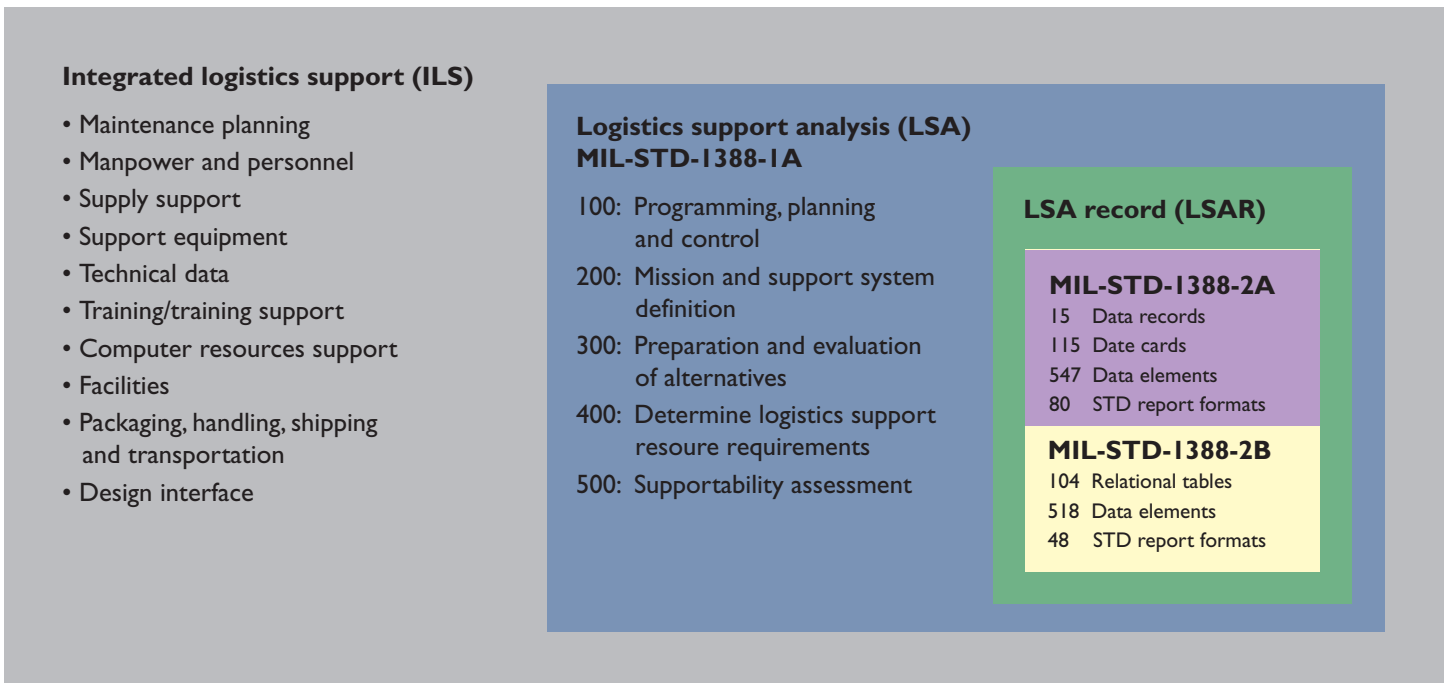

Figure 7: ILS Department of Defense methodology

The logistics support analysis/logistics support analysis record (LSA/LSAR) approach shown in Figure 7 provides an excellent disciplined process to perform LSA analysis, but it must be combined with product lifecycle management to obtain the level of configuration management needed today for performance-based logistics. The classical techniques of integrated logistics support analysis via MIL-STD-1388-2B can effectively be enhanced by more modern information technology techniques than was traditionally available during the 1980s-1990s to achieve a superior integrated logistics system for the 21st century.

ILS is based on the fundamental concept that ILS includes all the coordinated and iterative management and technical tasks required to accomplish the following:

- Make sure that the support is taken into consideration in the requirements concerning the defense system and its design
- Specify and design the support system
- Implement the support system
- Maintain the support system throughout the equipment lifecycle

In order to implement ILS, the OEM sets up an integrated logistics program including the organizational structure to implement it. The main focus from an ILS point of view is to have logistics element managers (LEMs) which cover all of the required subject matter expert areas: maintenance planning; manpower and personnel; supply support; support equipment; technical data; training/training support; computer resources support; facilities; packaging, handling, storage and transportation; and design interface.

Military logistics engineering is the range of activities associated with the flow of materials, information and payments among the suppliers and operators (customers) of weapons systems. The pipeline of activities ranges from the origin of the concept and design of the weapons system, to the continuing period of operations and use of the weapons system (including design modifications), to the end of the lifecycle with retirement and disposition of the weapons system. Important skills and academic backgrounds for logistics engineers include industrial engineering, systems engineering, information sciences and decision technologies. Logistics support analysis is a systematic and comprehensive analytical process that is conducted on an iterative basis through all lifecycle phases of the product. LSA is for quantifying and measuring supportability objectives. LSA information consists of all data resulting from the analysis tasks and is intended to be the primary source of validated, integrated, design-related product support information pertaining to an acquisition program. The LSA process requires systems engineering effort using a planned series of tasks to:

- Examine all elements of a proposed system to determine the logistic support resources required to keep that system usable for its intended purpose
- Influence the design so that both the system and support can be provided at an affordable cost

As logisticians say: “Design to support. Support the design.”

The series of LSA tasks

The planned series of tasks to be accomplished in LSA are as follows:

- Series 100 – Program planning and control
- Series 200 – Mission and support system definition
- Series 300 – Preparation and evaluation of alternatives. This includes Task 301 – Functional requirements identification
- Series 400 – Determine logistic support resource requirements. This includes Task 401 – Task analysis
- Series 500 – Supportability assessment

The LSAR, in compliance with MIL-STD-1388-2B, is created during the LSA process as shown in Figure 8.

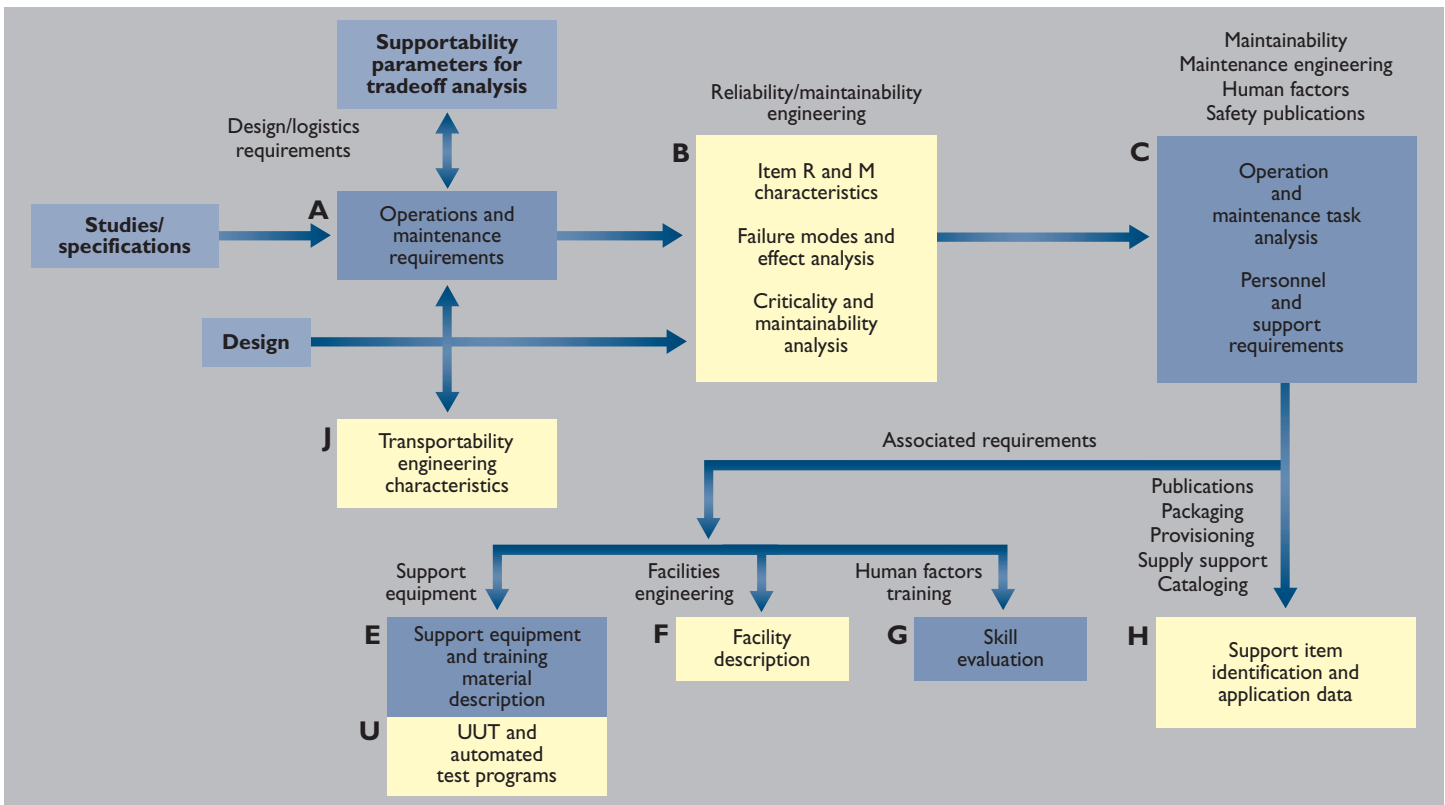

Figure 8: LSAR data flow and system engineering interface

Logistics control number (LCN)

One of the first steps in LSA is the creation of the logistics control number (LCN) which is assigned to each part-position combination. The classical LCN assignment method assigns a unique LCN number to every application of a part-numbered item in the weapons system. If the same part is used in three different positions, then it has three unique LCNs. Figure 9 shows the classical LCN assignment method for an aircraft part, for example door plate.

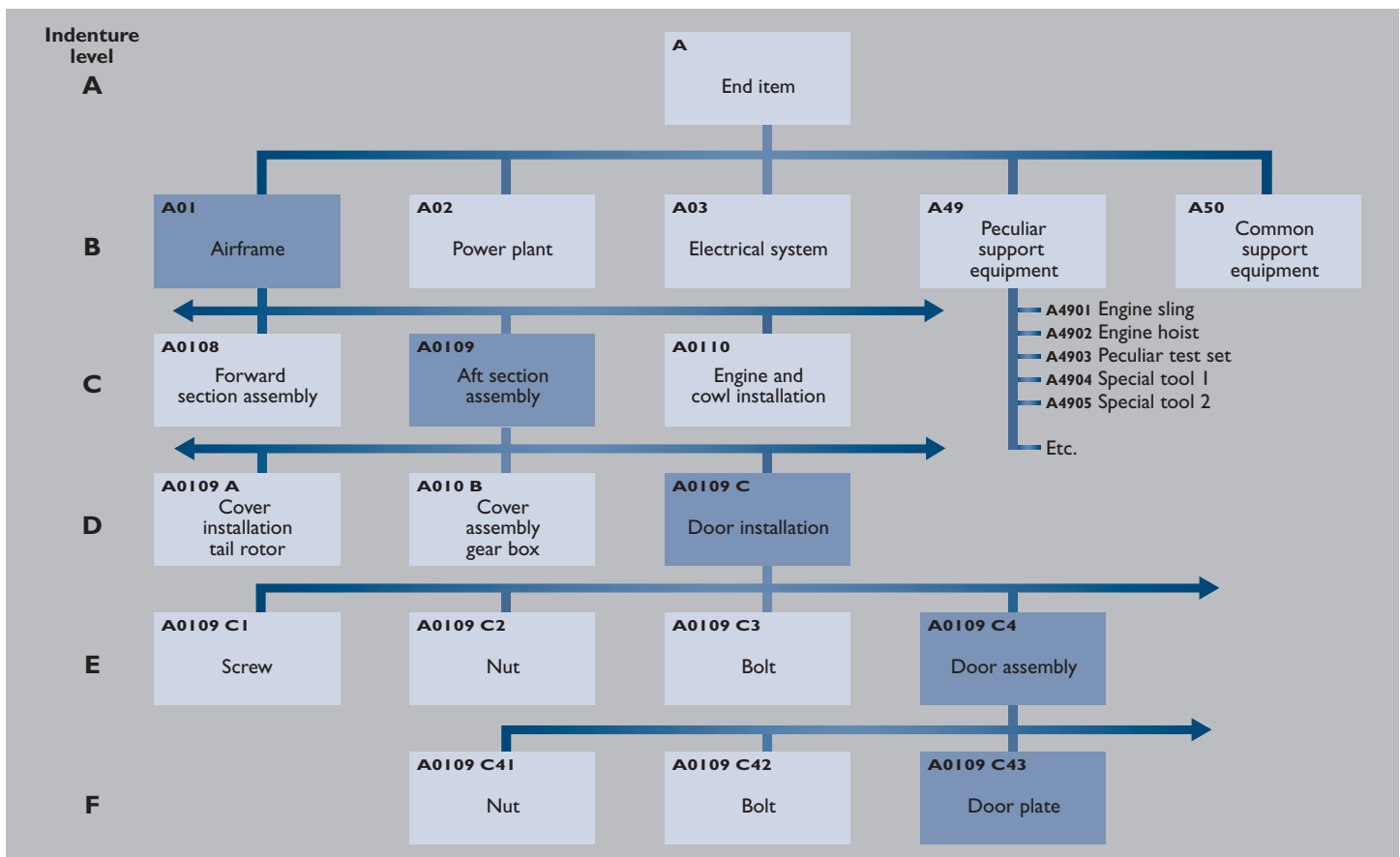

Figure 9: Classical LCN assignment method

Two types of LCNs: functional and physical

The biggest advantage in using MIL-STD-1388-2B over the earlier version-2A is that -2B contains an extra attribute – LCN Type – so that both functional and physical configurations are managed as two independent product structures. This dual structure is essential for the reliability and maintainability area where analysts must “roll up” failure rates, reliability times and maintainability frequencies to a higher functional system (for analysis and troubleshooting) while maintenance planners roll up to a higher physical position (for work card consolidation and access planning).

For example, if an antenna connected to a wing tip fails, the failure should be rolled to the communication system and not the wing structure on which it is physically attached. The physical and functional structures are necessarily independent, and a mixing of structures for a system/end item is not permitted. The LCN type data element is used as a key in LSAR and is required where all LCN-oriented data resides. This one-position code has two values: either “F” for functional or “P” for physical.

How Teamcenter could support LSAR

Teamcenter manages all the product design data at the “front-end” of the weapons system acquisition process. Each part number established in the engineering design is subjected to a logistics support analysis (LSA) and becomes one or more LSA candidates managed in the Teamcenter LSAR process.

During the manufacturing process, a single part number in the Teamcenter manufacturing bill of materials (BOM) can be specified to be assembled in multiple locations in the weapons system. This same part number can be used to perform one or more functions in various systems in the end product. During the engineering design process, each such use could be assigned a logistics control number (LCN) in Teamcenter. To be able to perform configuration control, execute maintenance activities and track the lifetime utilization of these various usages of a single part number, two product structures would be created in Teamcenter – one for the physical LCN and one for the functional LCN. For example, Figure 10 shows the functional and physical views for a radio, part of the end item, a Howitzer weapon.

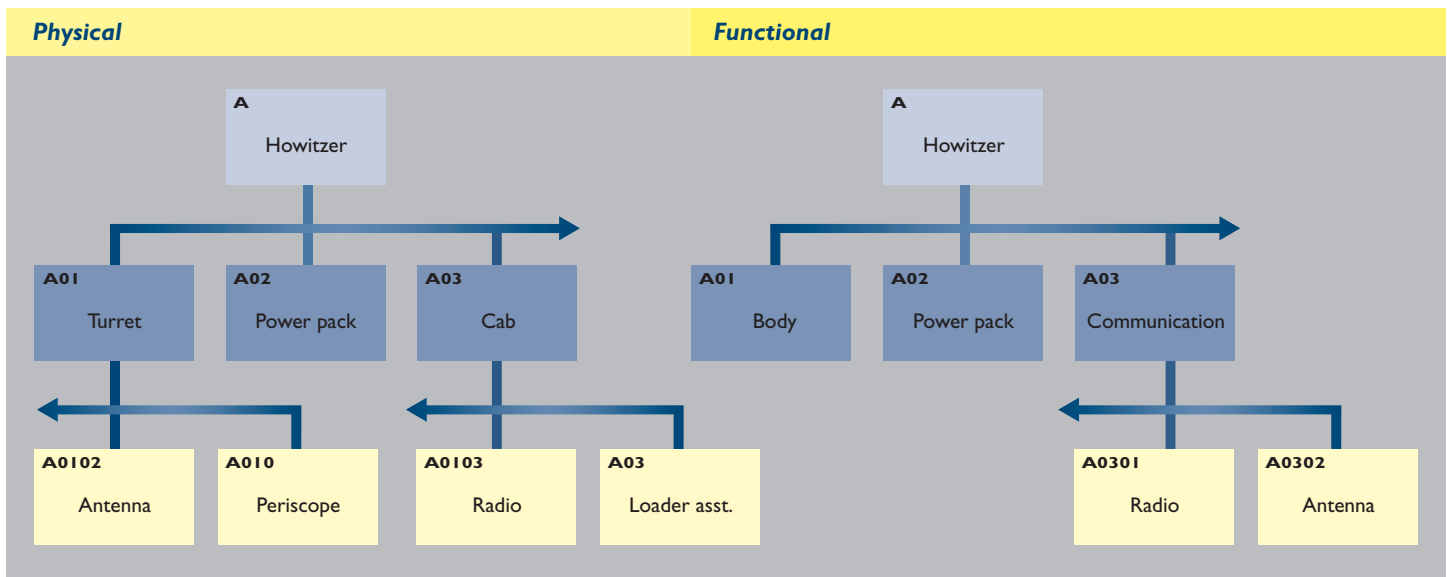

Figure 10: Physical vs. functional LCN assignment

The LCN node can be used as the key to link other logistics structures, such as AECMA 1000D and 2000M. Also, having established the relationship between the “as maintained” product structure parts and the LCN number, View Networks within Teamcenter can be used to link the “as maintained” view back to upstream views, such as the “as designed”.

All the above could be managed within a single change control environment.

LSAR tables

LSA tasks populate the 104 relational data tables, grouped into 10 types, as shown below in Figure 11.

Typically, the logistics support analysis record is LSA data that resides in a specified format in a database system. MIL-STD-1388-2B defines 48 standard LSAR reports and, if needed, ad hoc reports can be produced from these tables.

<i>LSAR data tables</i>		<i>No. of tables</i>
A Tables	Operations and maintenance requirements	11
B Tables	RMA data, FMECA and maintainability analyses	12
C Tables	Task inventory, task analyses, personnel and support	11
E Tables	Support equipment and training material	13
F Tables	Facilities considerations	5
G Tables	Personnel skill considerations	5
H Tables	Initial provisioning and spares	18
J Tables	Transportability requirements	6
U Tables	Unit under test requirements and description	14
X Tables	Cross reference requirements	9
Total		104

Figure 11: LSAR data tables

Populating the data tables

The sequence of population of the 104 relational tables is accomplished through the LSA task series as follows:

- *Series 100* – Program planning and control
- *Series 200* – Mission and support system definition. Task 205 requires data to be entered into “A,” “B,” and “G” tables.
- *Series 300* – Preparation and evaluation of alternatives. This includes Task 301 – Functional requirements identification data to be entered into “A,” “B,” “C” and “G” tables
- *Series 400* – Determine logistic support resource requirements. This includes Task 401 – Task analysis data to be entered into “C,” “E,” “U,” “F,” “G,” “H,” and “J” tables
- *Series 500* – Supportability assessment

In order to complete data in the LSAR data tables, the following processes are performed by ILS engineers which include detailed analysis and calculations which reside in logistics databases as shown in Figure 12 and described on the next page.

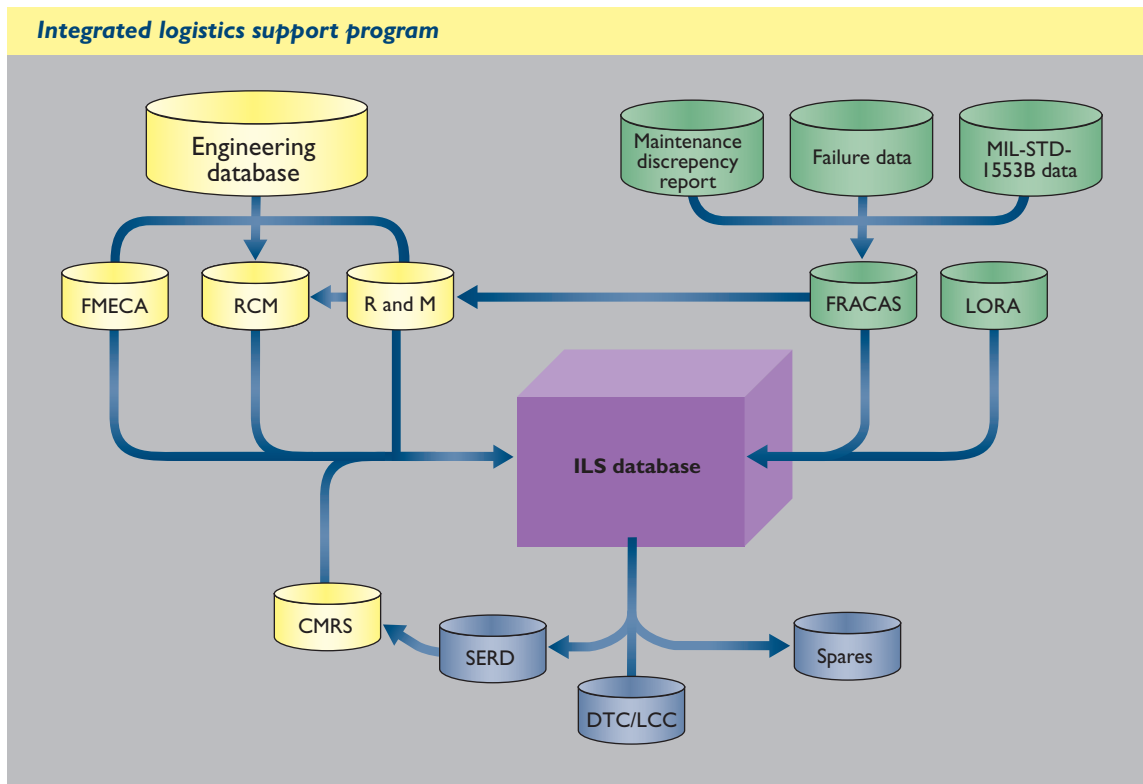

Figure 12: Integrated logistics support program

- **FMECA** – Procedures for performing a failure mode effects and criticality analysis based on MIL-STD-1629A
- **RCM** – Reliability centered maintenance for aircraft, weapons systems and support equipment based on MIL-STD-2173(AS)
- **R and M** – Reliability and maintainability calculates reliability predictions using LSA Tasks 201 through 203 of MIL-STD-1388-2B. The reliability prediction data is based upon design controllable failure rates and maintenance times. MIL-STD-785 is used for the reliability program for systems and equipment development and production. MIL-STD-470 is used for the maintainability program for systems and equipment
- **LORA** – Level of repair analysis using MIL-STD-1390C
- **CMRS** – Calibration measurement requirements summary for support equipment and systems based on MIL-STD-1839A
- **SERD** – Support equipment recommendation data
- **Spares** – The MIL-STD-1388-2B “H” tables are used to develop initial provisioning and subsequent order administration in accordance with AECMA Spec 2000M
- **DTC/LCC** – Design to cost and lifecycle cost

Once the weapons systems are manufactured and begin their lifecycle's operations, use and maintenance stages, these additional processes are

used to update the predictive data with actual field and in-service actual data:

- **FRACAS** – Failure reporting and corrective action system
- Maintenance discrepancy reporting and failure data
- MIL-STD-1553B data bus parameters downloaded from aircraft
- Update to initial provisioning with usage data
- Update of design to cost and lifecycle cost data

The comparison of calculated, predicted and actual supportability metrics includes: technical (fleet) mean time to repair; mean time between maintenance actions, direct maintenance man-hours/flight hours, operational readiness, technical (fleet) mean time between failure, maximum corrective maintenance time, annual unscheduled maintenance man-hours (O and I levels), annual scheduled maintenance man-hours (O and I levels) and lifecycle cost considerations.

Supportability assessment is the last of the series, namely the 500 Series specified in MIL-STD-1388-1A. Supportability test, evaluation and verification is Task 501. This task provides for the continuous evaluation, validation and feedback assessment of supportability parameters and characteristics. The key is continuous feedback and assessment throughout the lifecycle.

► Performance-based logistics (PBL) policy update

Early PBL applications included the FY 99 Lockheed Martin Skunk Works total system performance responsibility (TSPR) contract

described in the next section. Figure 13 summarizes recent history of DoD policy and the growing emphasis on PBL.

“DoD will implement performance-based logistics to compress the supply chain and improve readiness...”

QDR (2001)

“PBL is the preferred support strategy within the Department of Defense whenever practical, and PMs are to work directly with users...”

DoDD 5000.1; DoDI 5000.2 (12 May 2003)

Provided BCA guidance for PBL programs.

Wynn Memo, January 2004

Directed USD (AT&L) to issue clear guidance on purchasing using performance criteria. Also directed the Services to provide plan to aggressively implement PBL.

Wolfowitz Memo, February 2004

Identifies JSF as a potential PBL pilot program and requires BCA within 180 days of MID 917 signature.

MID 917

Figure 13: PBL emphasis¹

New U.S. DoD management initiative decision 917 (MID 917), dated 18 October 2004

Mr. Brad Berkson, the Deputy Undersecretary of Defense (Logistics and Materiel Readiness), recently issued Management Initiative Decision 917, dated October 18, 2004, that requires a business case analysis within 180 days, on the merits of pilot PBL programs for six military weapons systems, including the B-2 Stealth Bomber and the Joint Strike Fighter F-35.

The example quoted from the MID 917 for the reason for these pilot programs is “to develop an acquisition strategy to execute a true performance agreement for sustainment.” For example, the F-18 Super Hornet PBL contract involves multiple line items associated with repairable parts, maintenance, technical services and consumable parts. Each line item is funded by specific appropriations, with limited flexibility across the contract. In essence, the Department of Defense

is buying a collection of elements on a single contract, but it is not buying output.”

The MID 917 requires these programs to develop pilot programs “which test revised contracting, programming, budgeting and financial processes to facilitate the cultural shift from buying specific products (such as individual spare parts, maintenance, actions or technical data) to buying performance levels.” In the next section, we review the published data on the F-117 CLS TSPR and C-17 PBL to obtain relevant lessons learned.

¹ F-35 JSF Global Sustainment, presented 30 November 2004, by Colonel Shaugn Reynolds, USMC, Autonomic Logistics Director and Mr. Luke Gill, VP, JSF Global Sustainment, LM Aero, at the Defense Logistics 2004 Conference, Washington, D.C.

▶ Lessons learned from PBL programs: focus on the metrics

The table below summarizes published financial incentives, program requirements and performance metrics for the Lockheed Martin Skunk works total system performance responsibility (TSPR) contract.^{2,3} This

FY 1999 contract requires LMSW's Palmdale, California "depot" to provide PBL-type support for 52 aircraft in the 49th Fighter Wing at Holloman Air Force Base.

Contract profile:

Cost plus incentive fee with an Award fee

- Award fee (3 percent)
- Performance incentive fee (7 percent)
- Cost incentive share with U.S. Air Force (50/50)

FY 99-06 Contract ceiling price ranges from \$223M per year in FY 99 to \$234M per year in FY 06, for a total of \$1.97B

Modification, integration and sustainment requirements for 52 aircraft in the F-117 fleet

- System engineering
- Subcontractor management
- System/subsystem integration
- Configuration management
- Item/materiel management
- Warehousing/transportation
- Direct supply support to 49th Fighter Wing
- Reporting requirements to the U.S. Air Force

Contract line items reduced

4 CLINS, reduced from 33

Contractor data requirements list reduced

11 CDRLs, reduced from 180



<i>PBL performance metrics</i>	<i>Points</i>	<i>Metric standard</i>	<i>FY 99 actuals</i>
Non-mission capable supply (NMCS)	250	5 percent	2.3 percent
Mission capable delivery rate (MICAP)	150	72 hours	30.2 hours
Readiness spares provisioning kit fill	150	96 percent	99 percent
Depot quality	150	0-20 points	12 points
Depot delivery	150	0 days	0 days
Delinquent deficiency reports	100	1 report	0 reports
Weapons systems trainer availability	50	99 percent	99.7 percent
Total points	1000		"Excellent," 98 percent award fee

Table 1: Lockheed Martin's F-117 TSPR contract profile and metric results

² F-117 CLSTPSR Cost Reduction Strategy and Lessons Learned, 17 Jan 2000, F-117 System Program Office

³ F-117A Nighthawk, at <http://www.globalsecurity.org/military/systems/aircraft/f-117.htm>

The table below shows the financial incentives, program requirements and the performance metrics which were established in FY 2004 for Boeing to meet for the C-17 Globemaster Sustainment Partnership

deployed worldwide and based in several CONUS and OCONUS locations.⁴

Contract Profile:

Annual pre-priced options for five years, annual un-priced options for subsequent three years. FY 04-08 Contract ceiling total price is \$4.9 billion

Modification, integration and sustainment requirements for 125 C-17 aircraft in FY 04 rising to 180 C-17 aircraft in FY 08

- Program management
- Sustaining logistics
- Material management
- Sustaining engineering
- Depot level maintenance
- Engineering changes
- Engine management
- Partnership planning



<i>PBL performance metrics</i>	<i>Metric standard minimum</i>	<i>FY 2004 actuals</i>
MICAP delivery rate services within 48 hours (MICAP)	80 percent within 48 hours	88 percent YTD CUM with average response: 25 hours
Issue effectiveness repairables (percent of demands satisfied immediately)	82 percent	86 percent YTD CUM
Issue effectiveness consumables (percent of demands satisfied immediately)	67 percent	76 percent YTD CUM
Globemaster sustainment aircraft availability (GSAA) Definition: GSAA=I-(possessed NMC + non-possessed NMC (depot))/fleet inventory	70 percent	72 percent 81 aircraft available out of 114 aircraft total

Table 2: Boeing's C-17 PBL contract profile and metric results

⁴ C-17 Globemaster III Sustainment Partnership (GSP), presented 1 December 2004, by Colonel Janet Wolfenbarger, USAF, Program Director, C-17, System Program Office, Aeronautical Systems Center Globemaster III and Mr. David Bowman, Vice President and C-17 Program Manager, USAF Airlift and Tanker Programs, Integrated Defense Systems, Boeing, at the Defense Logistics 2004 Conference, Washington, D.C.

Performance-based logistics contracts require the contractor (usually the OEM) to fix weapons systems within prescribed turnaround times. Therefore, the OEM must constantly focus on the metrics by measuring his internal reaction times and having immediate access to accurate, up-to-date engineering, logistics and configuration data to feed his maintenance planning and analysis tasks. The business process for accomplishing this access is the framework of integrated logistics support as specified by MIL-STD-1388 IA, 2A and 2B along with AECMA 1000D or MIL-PRF-876268 and MIL-PRF-876269 for Technical Documentation, and AECMA 2000M or U.S. DLA planning for initial provisioning and recurring procurement of materials including spare parts.

In addition, the OEM needs a world-class integrated MRO and PLM system to perform product modification and maintenance planning, conduct maintenance execution and retain history of all corrective actions. LSAR bridges the gap between the traditional PDM “as designed,” “as built” product configurations and the PBL/MRO system.

LSAR contains the data needed for the MRO planning and execution processes that will store the “as maintained” configuration. The logistics support analysis record data is a subset of LSA information and is a structured means of creating and aggregating LSA data. The LSAR is the primary means of storing logistics support data in digital form. The LSAR database serves as the center of the ILS technical support database, which can interface with both the design side and sustainment side of the OEM’s operation.

Reliable weapons systems require total lifecycle support with strong configuration management. The Siemens product lifecycle management environment – Teamcenter – can be leveraged to provide an integrated 21st century solution to enable PBL operations. Siemens, with more installed seats in the aerospace and defense industry than any other company, will be happy to discuss its solutions for optimizing OEM performance for PBL through an integrated logistics data repository approach using its Teamcenter products.

About Siemens PLM Software

Siemens PLM Software, a business unit of the Siemens Industry Automation Division, is a leading global provider of product lifecycle management (PLM) software and services with 4.6 million licensed seats and 51,000 customers worldwide. Headquartered in Plano, Texas, Siemens PLM Software's open enterprise solutions enable a world where organizations and their partners collaborate through Global Innovation Networks to deliver world-class products and services. For more information on Siemens PLM Software products and services, visit www.siemens.com/plm.

SIEMENS

Division headquarters

United States

Granite Park One
5800 Granite Parkway
Suite 600
Plano, TX 75024
972 987 3000
Fax 972 987 3398

Regions

Americas

Granite Park One
5800 Granite Parkway
Suite 600
Plano, TX 75024
800 498 5351
Fax 972 987 3398

Europe

Norwich House Knoll Road
Camberley, Surrey
GU15 3SY
United Kingdom
44 (0) 1276 702000
Fax 44 (0) 1276 705150

Asia-Pacific

Suites 6804-8, 68/F Central Plaza
18 Harbour Road, Wan Chai
Hong Kong
852 2230 3333
Fax 852 2230 3210