

# NETGEAR<sup>®</sup>

## LTE Modem Model LB2120 User Manual

November 2017  
202-11658-02

350 E. Plumeria Drive  
San Jose, CA 95134  
USA

## Support

Thank you for purchasing this NETGEAR product. You can visit [www.netgear.com/support](http://www.netgear.com/support) to register your product, get help, access the latest downloads and user manuals, and join our community. We recommend that you use only official NETGEAR support resources.

## Conformity

For the current EU Declaration of Conformity, visit [http://kb.netgear.com/app/answers/detail/a\\_id/11621](http://kb.netgear.com/app/answers/detail/a_id/11621).

## Compliance

For regulatory compliance information, visit <http://www.netgear.com/about/regulatory>.

See the regulatory compliance document before connecting the power supply.

## Trademarks

© NETGEAR, Inc., NETGEAR, and the NETGEAR Logo are trademarks of NETGEAR, Inc. Any non-NETGEAR trademarks are used for reference purposes only.

# Contents

## Chapter 1 Introduction and Hardware Overview

Introduction.....	7
Supported Mobile Broadband Bands.....	7
Package Contents.....	8
Install the Micro SIM Card.....	8
Top Panel With Status LEDs.....	11
Back Panel With Ports, Connectors, and Button.....	12
Modem Label.....	12
Position the Modem.....	13
Optional External Antenna.....	14

## Chapter 2 Get Started

Internet Connection Over Mobile Broadband.....	16
Connect the Modem to a Wireline Broadband Modem.....	16
Connect a Computer, Switch, Hub, Router, or WiFi Router to the Modem.....	17
Connect a Computer to the LAN Port of the Modem.....	17
Connect a Router or WiFi Router to the LAN Port of the Modem.....	17
Access the Modem's Web Pages for the First Time.....	17
Change the Language.....	20
Manage Automatic Failover Detection.....	20

## Chapter 3 Manage the Modem LAN Settings

Change the LAN Settings.....	24
Manage Router Mode and Bridge Mode.....	26
Change the DHCP Server Settings.....	27
Disable the DHCP Server.....	29
Enable the DMZ.....	30
Disable VPN Pass-Through.....	31

## Chapter 4 Manage the Mobile Broadband Connection

Manage Mobile Broadband Auto Connect Options.....	33
Manually Connect to or Disconnect From the Mobile Broadband Network.....	34
Manage APN Profiles for Mobile Broadband Connections.....	34
View APN Profiles or Add a Custom APN Profile.....	35
Select an APN Profile.....	37
Change an APN Profile.....	38
Remove an APN Profile.....	39

## Chapter 5 Secure Your Network

Change the Modem Password.....	41
Manage Port Forwarding for Incoming Traffic.....	41
Enable Port Forwarding and Add a Service or Application.....	42

Remove a Service or Application for Port Forwarding.....43  
Disable Port Forwarding.....44  
Manage Port Filtering for Outgoing Traffic.....45  
Block Specific Services and Applications From Accessing the Internet and Allow All Other Services and Applications.....45  
Allow Specific Services and Applications to Access the Internet and Block All Other Services and Applications.....47  
View Services and Applications on the Blacklist and Remove a Service or Application From the List.....48  
View Services and Applications on the Whitelist and Remove a Service or Application From the List.....49  
Disable Port Filtering.....50  
Manage SIM Card Security.....51  
Enable SIM Card Security.....51  
Enter the SIM PIN to Enable the Modem to Connect to the Internet.....53  
Personalize the SIM PIN.....54  
Disable SIM Card Security.....55  
Unlock the SIM Card With a PUK.....57

**Chapter 6 Manage the Modem and Monitor Usage and the Network**

Upgrade the Firmware of the Modem.....60  
Back Up and Restore the Modem Settings.....61  
Back Up the Settings.....61  
Restore the Settings.....62  
Return the Modem to Its Factory Default Settings.....62  
Use the Reset Button.....63  
Use the Modem’s Web Pages to Reset the Modem to Factory Defaults.....63  
View Monthly Data and Session Data Usage.....64  
Set a Plan Limit for the Data Counter.....65  
Change the Billing Cycle Counter or Reset the Data Counter.....66  
View Service Provider, Type of Service, and Signal Strength.....66  
View Account Details and Other Details About Your Modem.....68  
View Information About the Mobile Broadband Connection.....69  
Set Up SMS Alert Messages.....70  
Set the Data Limit for SMS Alert Messages.....72  
View Alerts.....73  
Turn Off the LEDs.....74

**Chapter 7 Manage SMS Messages**

Manage Incoming SMS Messages.....76  
Send an SMS Message.....77

**Chapter 8 Frequently Asked Questions**

What do I do when I can’t connect a device to the modem?.....79  
What do I do when I can’t access the Internet?.....79  
What do I do when the No Signal icon displays?.....79  
Why does the Signal Strength LED show only a few bars?.....79  
Why is the download or upload speed slow?.....79

## LTE Modem Model LB2120

Can I connect multiple LAN devices to the modem?.....	80
How do I access the modem's web pages?.....	80
What do I do if I forget my admin login password?.....	80
How do I disconnect from the mobile broadband network?.....	80
How do I find my computer's IP address?.....	81
How do I find a device's MAC address?.....	82
How do I find my mobile phone number?.....	84
Where can I find more information?.....	84

### Chapter 9 Alerts and Troubleshooting

Alert Messages.....	86
Quick Tips for Troubleshooting.....	86
Verify Normal Behavior With the LED Bars.....	87
Troubleshoot With the LED Bars.....	87
Power LED Bar Is Off.....	87
Power LED Bar Blinks Amber Fast and an Individual Signal and Strength LED Bar Lights Solid Green.....	88
LAN LED Is Off.....	88
You Cannot Log In to the Modem.....	89
Troubleshoot the Mobile Broadband Internet Connection.....	89
Obtain an Internet IP Address From Your Service Provider.....	90
Troubleshoot Internet Browsing.....	90
Changes Not Saved on the Modem's Web Pages.....	90
TCP/IP Network Not Responding.....	91
Test the LAN Path to Your Modem.....	91
Test the Path From Your Computer to a Remote Device.....	91

### Appendix A Default Settings and Specifications

Factory Default Settings.....	94
Technical and Environmental Specifications.....	95

### Appendix B Wall-Mount the Modem

Position Your Modem.....	98
Mount Your Modem.....	99

# Introduction and Hardware Overview

---

# 1

This manual is for the following NETGEAR® LTE Modem LB2120 models:

- **LB2120-100AUS.** Data model with one LAN and one WAN Gigabit Ethernet port and with band support for the Australia, New Zealand, and Oceania region.
- **LB2120-100EUS.** Data model with one LAN and one WAN Gigabit Ethernet port and with band support for the Europe, South Africa, and Middle East region.
- **LB2120-100NAS.** Data model with one LAN and one WAN Gigabit Ethernet port and with band support for the North America region.

The LTE Modem LB2120 provides two Gigabit Ethernet ports: one LAN port for connection to a router, switch, hub, or computer and one WAN port for connection to a wireline broadband modem in support of automatic failover to mobile broadband if the wireline broadband modem goes down.

This chapter provides an introduction and hardware overview of the LTE Modem LB2120 and contains the following sections:

- *Introduction* on page 7
- *Supported Mobile Broadband Bands* on page 7
- *Package Contents* on page 8
- *Install the Micro SIM Card* on page 8
- *Top Panel With Status LEDs* on page 11
- *Back Panel With Ports, Connectors, and Button* on page 12
- *Modem Label* on page 12
- *Position the Modem* on page 13
- *Optional External Antenna* on page 14

---

**Note** For more information about the topics that are covered in this manual, visit the support website at [netgear.com/support](http://netgear.com/support).

---

---

**Note** Firmware updates with new features and bug fixes are made available from time to time at [downloadcenter.netgear.com](http://downloadcenter.netgear.com). You can check for and download new firmware manually. If the features or behavior of your product does not match what is described in this guide, you might need to update your firmware.

---

## Introduction

The NETGEAR LTE Modem LB2120, in this manual referred to as the *modem*, can provide broadband data services to areas where wired Internet is not readily available or is difficult, costly, or time-consuming to install. The modem uses existing 4G LTE mobile networks with automatic fallback to 3G mobile networks to provide broadband data services. The LB2120-100AUS and LB2120-100EUS models also support fallback to 2G mobile networks.

If you connect a WiFi router to the modem's Gigabit Ethernet port, the mobile network connection can provide high-speed Internet access for multiple users and devices in homes and offices.

The modem provides wireline broadband pass-through for automatic failover support so you can connect the modem to an existing DSL, cable, or fiber optics gateway. If the wireline broadband connection goes down, the modem automatically and seamlessly switches over to the backup Internet connection over mobile broadband for continuous connectivity. This capability is enabled by default, but you might want to customize the IP addresses for failover detection (see [Manage Automatic Failover Detection](#) on page 20).

Professional installation and configuration are not required. If a SIM card is installed and activated, by default, the modem automatically searches for and connects to your network provider's mobile broadband network.

For information about installing the modem, see the quick start guide, which you can download from [downloadcenter.netgear.com](http://downloadcenter.netgear.com).

In the unlikely situation that the modem does not automatically connect to your network provider's mobile broadband network, you might need to add an access profile name (APN) profile. For information about adding an APN profile, see [View APN Profiles or Add a Custom APN Profile](#) on page 35.

## Supported Mobile Broadband Bands

The following table describes the mobile broadband bands that are supported for each modem model.

**Table 1. Mobile broadband bands**

Model	LTE Category 4	3G UMTS	2G GSM
LB2120-100AUS	Bands 1, 2, 3, 5, 7, 8, 20, 28, 38, and 40	Bands 1, 2, 5, and 8	Quad band
LB2120-100EUS	Bands 1, 2, 3, 5, 7, 8, 20, 28, 38, and 40	Bands 1, 2, 5, and 8	Quad band
LB2120-100NAS	Bands 2, 4, 5, and 12	Bands 2 and 5	Not applicable

## Package Contents

Your package contains the following items. The power adapter is localized to the country of sale. For some countries, a converter is included.

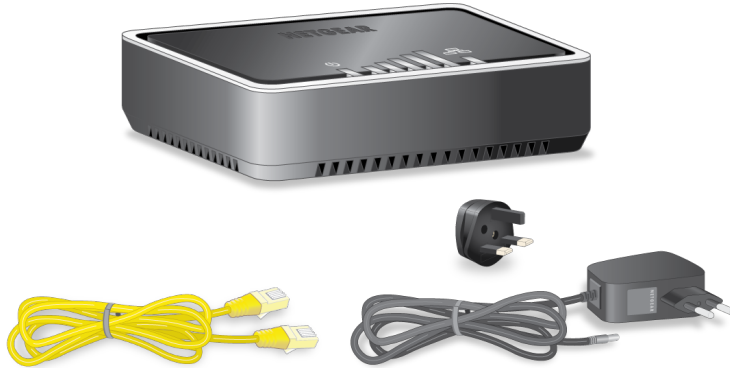

Figure 1. Package contents

## Install the Micro SIM Card

A micro SIM card (that is, a 3FF SIM card) might be preinstalled in the modem or you might need to obtain a micro SIM card and install it yourself. To obtain a micro SIM card, contact your mobile broadband Internet service provider.

If you want to use a nano SIM card (that is, a 4FF SIM card), an adapter is required.

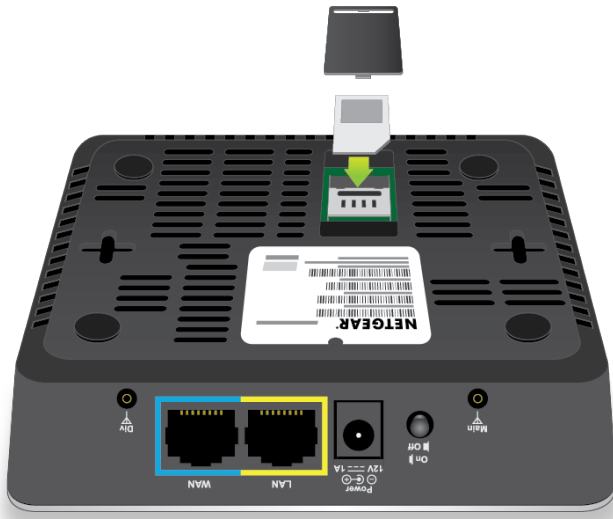
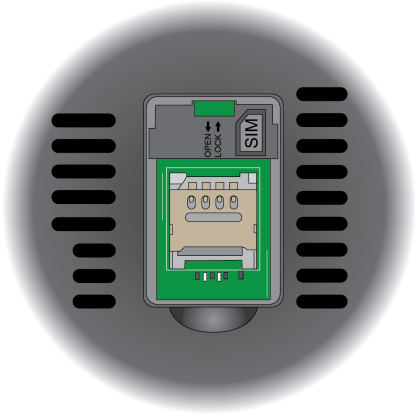

Figure 2. Overview of installing the micro SIM card



► **To install the micro SIM card in the modem:**

1. Ensure that power to the modem is off.
2. Place the modem horizontally with the bottom panel facing you.
3. Remove the black plastic SIM slot cover so that you can access the metal SIM card slot.



4. Unlock the metal SIM card door by sliding it downward.

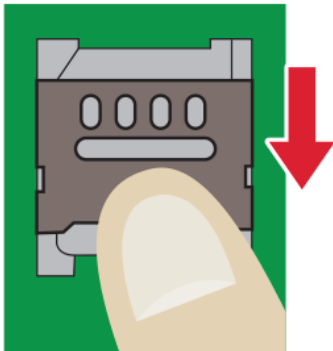

5. Open the metal SIM card door.

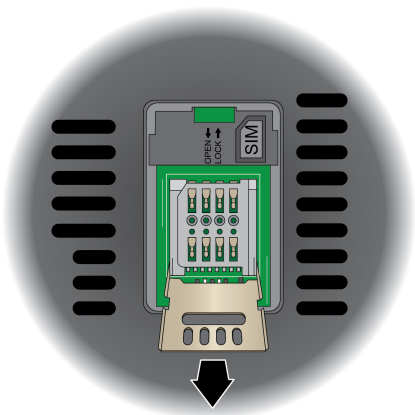

- Carefully slide the micro SIM card into the metal slot.

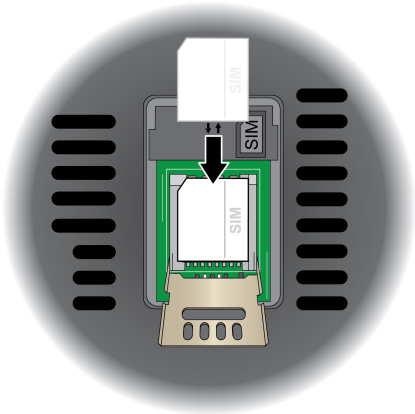

- Close the metal SIM card door.

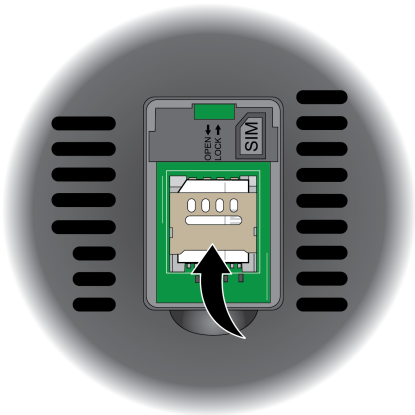

- Lock the metal SIM card door by sliding it upward.

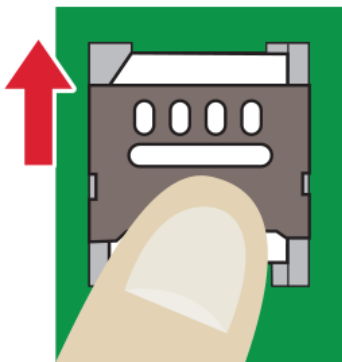

- Close the black plastic SIM slot cover.
- Turn on power to the modem.

## Top Panel With Status LEDs

The modem displays status LED bars on the top panel.

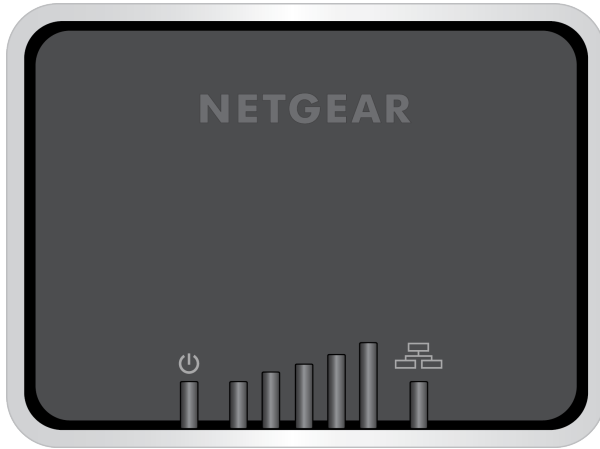





Figure 3. Modem top view with LED bars

The following table describes the LED bars and icons from left to right.

**Table 2. LED descriptions (normal behavior)**

Designation	Icon or LED Bars	Description
Power		<p><b>Solid green bar.</b> The modem is receiving power and is connected to the Internet. The type of Internet connection (wireline or broadband) depends on the failover detection setting. By default, this setting is wireline broadband with automatic failover support to mobile broadband. (For more information, see <a href="#">Manage Automatic Failover Detection</a> on page 20.)</p> <p><b>Blinking green bar.</b> The modem uses mobile data because the wireline connection is down and the modem failed over to the backup Internet connection over the mobile broadband network.</p> <p><b>Solid amber bar.</b> The mobile broadband connection is down. The modem is not connected to the Internet and no failover connection is available.</p> <p><b>Blinking amber bar.</b> A SIM card is not installed or not correctly installed, the modem is overheating, or another system error occurred. For more information, see <a href="#">Troubleshoot With the LED Bars</a> on page 87.</p> <p><b>Off.</b> The modem is not receiving power.</p>
Signal Strength		<p><b>Solid green bar or bars.</b> The five LED bars indicate the signal strength of the mobile broadband service that the modem is connected to. Five green bars indicate the strongest signal. One green bar (that is, the shortest bar) indicates the weakest signal.</p> <p><b>Off.</b> The modem is not connected to a mobile broadband service.</p>
LAN		<p><b>Solid green bar.</b> The Gigabit Ethernet port is connected to a powered-on LAN device.</p> <p><b>Off.</b> The modem does not detect a powered-on LAN device.</p>

## Back Panel With Ports, Connectors, and Button

The following figure shows the ports, connectors, and button on the back panel of the modem.

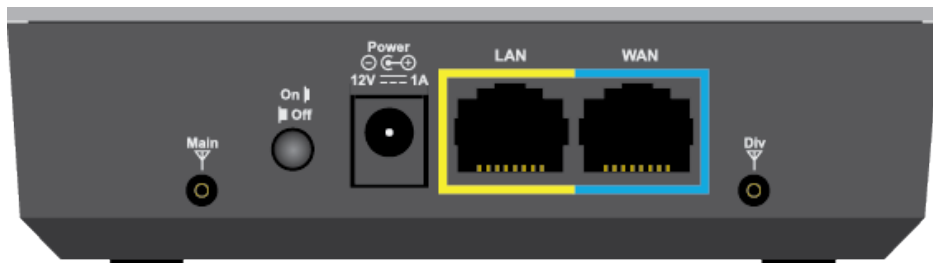

Figure 4. Modem components on the back panel

From left to right, the back panel of the modem provides the following components:

- **Connector for an external antenna.** One switched RF connector for an optional external antenna (the external antenna requires two inputs).
- **On/Off button.** An **On/Off** button to control power to the modem.

---

**Note** After you press the **On/Off** button, wait about 30 seconds for the modem to complete the boot process.

---

- **DC connector.** A DC connector to connect the AC power supply that is included in the package.
- **Gigabit Ethernet LAN port.** One yellow RJ-45 Gigabit Ethernet LAN port to connect a router, WiFi router, Ethernet switch or hub, or single computer.
- **Gigabit Ethernet WAN port.** One blue RJ-45 Gigabit Ethernet WAN port to connect a wireline broadband modem, such as a DSL, cable, or fiber optics modem.
- **Connector for an external antenna.** Another switched RF connector for an optional external antenna (the external antenna requires two inputs).

---

**Note** A recessed **Reset** button is located on the bottom panel of the modem. The **Reset** button lets you return the modem to factory default settings.

---

## Modem Label

In addition to the default URL and password to access the modem's web pages, the modem label on the bottom panel shows the following information:

- Serial number (SN)
- Stockkeeping unit (SKU) number
- MAC address
- IMEI (International Mobile Station Equipment Identity)

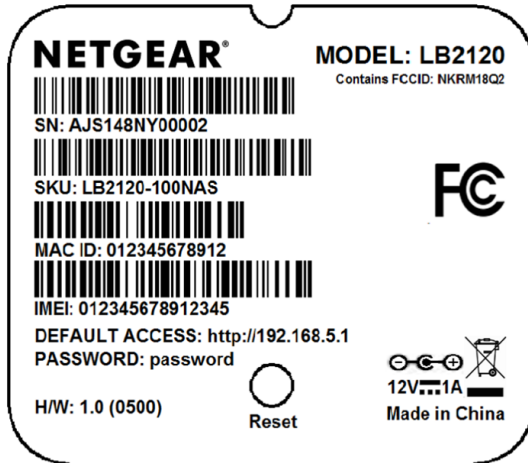



Figure 5. Modem label

## Position the Modem

Use the Signal Strength LED bars  on the top panel to position the modem for best signal strength in relation to the mobile broadband network. Also for best results, place your modem according to the following guidelines:

- Place your modem close to a window but avoiding direct sunlight. A window location gives the best conditions for receiving a strong 4G LTE signal.
- Make sure that the modem is within reach of an AC power outlet and near Ethernet cables for wired computers.
- Place the modem away from electrical devices such as the following:
  - Ceiling fans
  - Home security systems
  - Microwaves
  - Computers
  - Base of a cordless phone
  - 2.4 GHz cordless phone
  - 5 GHz cordless phone
- Place the modem away from large metal surfaces, large glass surfaces, insulated walls, and items such as the following:
  - Solid metal doors
  - Aluminum studs
  - Fish tanks

- Mirrors
- Brick walls or surfaces
- Concrete walls or surfaces

For information about wall-mounting the modem, see [Wall-Mount the Modem](#) on page 97.

## Optional External Antenna

You can purchase an external multiple input, multiple output (MIMO) antenna for the modem to extend the mobile broadband signal range indoors or in fringe network areas.

The external antenna plugs into the two antenna connectors on the modem to boost speeds and extend coverage in buildings or vehicles, or in remote sites where network coverage is sparse. You could, for example, attach the external antenna on a window with a suction cup.

This chapter describes how to connect to the modem. To get started, you do not need to configure the mobile broadband connection.

The chapter contains the following sections:

- *Internet Connection Over Mobile Broadband* on page 16
- *Connect the Modem to a Wireline Broadband Modem* on page 16
- *Connect a Computer, Switch, Hub, Router, or WiFi Router to the Modem* on page 17
- *Access the Modem's Web Pages for the First Time* on page 17
- *Change the Language* on page 20
- *Manage Automatic Failover Detection* on page 20

## Internet Connection Over Mobile Broadband

Whether or not the mobile broadband Internet connection functions as a backup connection, by default, when the modem powers up with a SIM card installed, it automatically searches for and connects to your network provider's mobile broadband network. This process might take several minutes. The SIM card that is installed determines the mobile broadband network to which the modem connects.

---

**Note** Even though the modem might connect to the mobile broadband network of the same service provider each time that you start the modem, the type of mobile broadband service (LTE, 4G, 3G, 2G, or another type of service) to which the modem connects might differ.

---

If the modem does not automatically connect to the mobile broadband network after 10 minutes, the Power LED remains solid amber, and you might need to contact your mobile service provider to get the access point name (APN) profile information and add (see [View APN Profiles or Add a Custom APN Profile](#) on page 35) and activate (see [Select an APN Profile](#) on page 37) a custom APN profile in the modem. If your mobile service provider informs you that your APN profile is correct but the modem still does not connect to the mobile broadband network, see [Troubleshoot the Mobile Broadband Internet Connection](#) on page 89.

If you do not want the modem to connect automatically to the mobile broadband network, change the default autoconnect option (see [Manage Mobile Broadband Auto Connect Options](#) on page 33).

For information about your mobile service provider and the broadband connection, see [View Service Provider, Type of Service, and Signal Strength](#) on page 66 and [View Information About the Mobile Broadband Connection](#) on page 69.

## Connect the Modem to a Wireline Broadband Modem

The modem is designed to provide a primary Internet connection through a wireline broadband modem, such as a DSL, cable, or fiber optics modem, and a backup Internet connection over the mobile broadband network.

Unless you want to use the mobile broadband connection as your only Internet connection, you must connect the modem to a wireline broadband modem. If you configure automatic failover detection (see [Manage Automatic Failover Detection](#) on page 20), the modem can automatically switch over to the mobile broadband Internet connection if the primary Internet connection over the wireline broadband modem goes down.

### ► To connect the modem to a wireline broadband modem:

1. Make sure that the modem is powered on.
2. Connect one end of an Ethernet cable to the blue WAN Gigabit Ethernet port on the modem.
3. Connect the other end of the Ethernet cable to a wireline broadband modem, such as a DSL, cable, or fiber optics modem, that provides an Internet connection.



## Connect a Computer, Switch, Hub, Router, or WiFi Router to the Modem

By default, the modem functions in Router mode with the DHCP server enabled and IP pass-through (IPPT) disabled. This means that you can connect multiple devices to the modem, for example, through an Ethernet switch or hub, and that each device can receive an IP address from the modem.

If you want to connect a router or WiFi router to the modem, change the operation mode of the modem to Bridge mode, in which IP pass-through (IPPT) is enabled and only a single device can be connected to the Internet through the modem. (The single device that is connected to the modem *is* the router or WiFi router, but depending on the capabilities of the router or WiFi router, you can connect multiple devices to the router or WiFi router.)

If you want to connect a computer only to the modem, the modem can function either in Router mode or in Bridge mode.

For information about changing the operation mode of the modem, see *Manage Router Mode and Bridge Mode* on page 26.

## Connect a Computer to the LAN Port of the Modem

You can add a single computer to the Ethernet local area network (LAN) of the modem.

### ► To connect a computer to the Ethernet LAN of the modem:

1. Attach one end of the Ethernet cable that came in the product package to an Ethernet port on your computer.
2. Attach the other end of the cable to the yellow Gigabit Ethernet LAN port on the back panel of the modem.

## Connect a Router or WiFi Router to the LAN Port of the Modem

You can add a router or WiFi router to the Ethernet local area network (LAN) of the modem.

### ► To connect a router or WiFi router to the Ethernet LAN of the modem:

1. Attach one end of the Ethernet cable that came in the product package to an Ethernet port on your router or WiFi router.
2. Attach the other end of the cable to the yellow Gigabit Ethernet LAN port on the back panel of the modem.

## Access the Modem's Web Pages for the First Time

The modem comes configured and ready to use. You can use the modem's web pages to monitor data usage and change basic settings.

You can log in to the modem's web pages over an Ethernet cable (see *Connect a Computer, Switch, Hub, Router, or WiFi Router to the Modem* on page 17).

The modem's web pages run on any device with a web browser such as Google Chrome, Mozilla Firefox, and Microsoft Internet Explorer.

### ▶ To access the modem's web pages:

1. Launch a web browser from a device that is connected to the modem.  
The device can be a computer that is directly connected to the modem or a client from a router that is connected to the modem.
2. In the address field of your browser, enter **http://192.168.5.1**.  
The limited Dashboard page displays.
3. To access the full Dashboard page and other pages, do the following:
  - a. In the **Sign In** field, enter the modem's admin password.  
See the modem label for the default password.

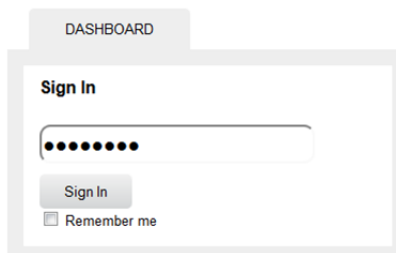

The image shows a screenshot of a web browser displaying the modem's 'Sign In' page. At the top, there is a tab labeled 'DASHBOARD'. Below the tab, the page title is 'Sign In'. There is a text input field for the password, which is currently filled with ten black dots. Below the input field is a 'Sign In' button and a 'Remember me' checkbox.

---

**Note** While the password that you enter is unique to your modem and is secure, we recommend that you change it to a password that you want to use. For more information, see [Change the Modem Password](#) on page 41.

---

- b. If you do not want to enter your password each time that you access the modem's web pages, select the **Remember me** check box.
- c. Click the **Sign In** button.

## LTE Modem Model LB2120

The full Dashboard page displays. You are now ready to monitor the modem and manage the settings.

The screenshot shows the Netgear AirCard dashboard. At the top left is the Netgear AirCard logo. At the top right are links for Support, About, Logout, and a language dropdown menu set to English. Below the logo is a navigation menu with Overview, Messaging, and Settings. A status bar shows 'Internet Connected' with a green checkmark. The main dashboard area is titled 'DASHBOARD' and contains three panels. The top-left panel shows a connection diagram: 'WIRELINE Connected' (green globe icon) and 'Operator (4G) Standby' (grey signal icon) are connected to 'LTE MODEM LB2120' (purple modem icon). The top-right panel is titled 'Monthly Usage' and shows '0.01 GB USED' and '25 DAYS REMAINING'. Below this is a note: 'Displayed data usage is intended to help manage usage. The amounts shown are approximate and may vary.' There are controls for 'Billing start date' (set to 'Day 1 each month') and 'Plan Limit' (set to 'MB'). The bottom panel is titled 'Session' and shows '0.5 MB USED' and '1h 15m ELAPSED TIME'.

If the modem is not connected to a wireline broadband modem and the mobile broadband connection is active, the full Dashboard page displays a different connection graph.

The screenshot shows the Netgear AirCard dashboard with a different connection state. The navigation and status elements are the same as in the previous screenshot. The main dashboard area is titled 'DASHBOARD' and contains three panels. The top-left panel shows a connection diagram: 'WIRELINE Unavailable' (red globe icon with a red 'X') and 'Operator (4G) Connected' (green signal icon) are connected to 'LTE MODEM LB2120' (purple modem icon). The top-right panel is titled 'Monthly Usage' and shows '0.01 GB USED' and '25 DAYS REMAINING'. Below this is the same usage note and controls as in the previous screenshot. The bottom panel is titled 'Session' and shows '0.1 MB USED' and '7m ELAPSED TIME'.

4. To change the language, from the language menu in the upper right of the page, select a language. The language adjusts.

If you cannot log in to the modem or your browser does not display the Dashboard page, check the following:

- Make sure that the computer, router, or WiFi router is connected to the yellow LAN Gigabit Ethernet port of the modem.
- Make sure that your browser does not cache the previous page by closing and reopening the browser.
- If your computer is set to a static or fixed IP address (this type of setting is uncommon), change the setting to obtain an IP address automatically from the modem (see [Change the LAN Settings](#) on page 24). For more troubleshooting information, see [You Cannot Log In to the Modem](#) on page 89.

## Change the Language

You can change the language of the modem's web pages.

### ► To change the language:

1. Launch a web browser from a device that is connected to the modem.  
The device can be a computer that is directly connected to the modem or a client from a router that is connected to the modem.
2. In the address field of your browser, enter **http://192.168.5.1**.  
The limited Dashboard page displays.
3. If you did not select the **Remember me** check box when you logged in previously, enter the modem password in the **Sign In** field.  
See the modem label for the default password.
4. Click the **Sign In** button.  
The full Dashboard page displays.
5. Select **Settings**.  
The page displays the general settings.
6. In the Language section, from the **Default Language** menu, select a language.  
The **Submit** button displays after you select the language.
7. Click the **Submit** button.  
Your settings are saved and the language changes.

## Manage Automatic Failover Detection

The modem provides wireline broadband pass-through with automatic failover support so that you can connect the modem to an existing DSL, cable, or fiber optics modem (see [Connect the Modem to a Wireline Broadband Modem](#) on page 16). If the wireline broadband connection goes down, the modem can automatically and seamlessly switch over to the backup Internet connection over the mobile broadband network for continuous connectivity. This capability is enabled by default. You can manage the IP addresses that are used in failover detection.

## LTE Modem Model LB2120

If you change the default connection to wireline broadband only or mobile broadband only, you effectively disable automatic failover.

### ► To manage automatic failover detection:

1. Launch a web browser from a device that is connected to the modem.  
The device can be a computer that is directly connected to the modem or a client from a router that is connected to the modem.
2. In the address field of your browser, enter **http://192.168.5.1**.  
The limited Dashboard page displays.
3. If you did not select the **Remember me** check box when you logged in previously, enter the modem password in the **Sign In** field.  
See the modem label for the default password.
4. Click the **Sign In** button.  
The full Dashboard page displays.
5. Select **Settings > Advanced > Failover**.

Default Connection  Auto - Use wireline broadband by default and failover to mobile broadband.  
 Wireline Broadband only.  
 Mobile Broadband only.

### Failover Detection

Define one or more IP addresses that the bridge attempts to ping successfully before failing over to mobile broadband.

IPv4 Addresses    
   
IPv6 Addresses

By default, the **Auto** radio button is selected and automatic failover to the mobile broadband connection occurs if the wireline broadband connection goes down.

6. To manage IP addresses that the modem attempts to ping, do the following:
  - To add an IP address, in the IPv4 Addresses list or IPv6 Addresses list, enter an IP address, and click the **+** button.

## LTE Modem Model LB2120

The IP address is added to the list. If the modem cannot successfully ping any of the IP addresses in the list, an automatic failover occurs. If the modem can successfully ping a single IP address in the list, no automatic failover occurs.

- To remove an IP address from the list, in the IPv4 Addresses list or IPv6 Addresses list, click the **x** button next to the IP address that you want to remove. The IP address is removed from the list.

7. To change the default connection, do the following:

a. Select one of the following radio buttons:

- **Auto.** The modem uses wireline broadband by default and fails over to mobile broadband. This is the default setting.
- **Wireline Broadband only.** The modem uses wireline broadband only. This setting effectively disables automatic failover.
- **Mobile Broadband only.** The modem uses mobile broadband only. This setting effectively disables automatic failover.

If you select a radio button, the **Submit** button displays.

b. Click the **Submit** button.  
Your settings are saved.

# Manage the Modem LAN Settings

---

# 3

This chapter describes how to manage the LAN settings that the modem provides.

The chapter contains the following sections:

- *Change the LAN Settings* on page 24
- *Manage Router Mode and Bridge Mode* on page 26
- *Change the DHCP Server Settings* on page 27
- *Disable the DHCP Server* on page 29
- *Enable the DMZ* on page 30
- *Disable VPN Pass-Through* on page 31

## Change the LAN Settings

The modem is preconfigured to use private IP addresses on the LAN side. The modem's default LAN IP configuration is as follows:

- **LAN IP address.** 192.168.5.1
- **Subnet mask.** 255.255.255.0

This address and subnet mask are part of the designated private address range for use in private networks and are suitable for most applications. The IP address and subnet mask identify which addresses are local to a specific device and which must be reached through a gateway or router.

Although you can change the IP address of the modem, this is rarely necessary. However, if you establish a VPN connection to a server that assigns IP addresses in the same range as the one that is used by the modem, you must change the IP address of the modem to prevent network problems.

### ▶ To change the LAN settings:

1. Launch a web browser from a device that is connected to the modem.  
The device can be a computer that is directly connected to the modem or a client from a router that is connected to the modem.
2. In the address field of your browser, enter **http://192.168.5.1**.  
The limited Dashboard page displays.
3. If you did not select the **Remember me** check box when you logged in previously, enter the modem password in the **Sign In** field.  
See the modem label for the default password.
4. Click the **Sign In** button.  
The full Dashboard page displays.



## 5. Select **Settings > Advanced > LAN**.

IP Address	<input type="text" value="192.168.5.1"/>
Netmask	<input type="text" value="255.255.255.0"/>
Operation Modes	<input type="radio"/> Bridge <input checked="" type="radio"/> Router
<p>When set to Bridge, this option turns off the router function of the device and assigns the network IP address directly to the attached host. This option can be useful for implementing secure, enterprise VPNs.</p>	
VPN Passthrough	<input checked="" type="radio"/> On <input type="radio"/> Off
DHCP Server	<input checked="" type="radio"/> Enabled <input type="radio"/> Disabled
DHCP IP Range	<input type="text" value="192.168.5.20"/> - <input type="text" value="192.168.5.99"/>
DHCP lease time (minutes)	<input type="text" value="720"/>
DNS mode	<input type="radio"/> Manual <input checked="" type="radio"/> Auto
<b>DMZ</b>	
DMZ Enabled	<input type="radio"/> On <input checked="" type="radio"/> Off

---

**Note** The diagnostics feature on the LAN page is intended for NETGEAR technical support only. By default, the Enable Diagnostics **Off** radio button is selected.

---

## 6. In the **IP address** field, enter a new IP address.

The default IP address is 192.168.5.1.

The **Submit** button displays after you change the IP address.

## 7. In the **Netmask** field, enter a new network mask.

The default network mask is 255.255.255.0.

## 8. Click the **Submit** button.

Your settings are saved and the modem restarts. A device that is connected to the modem is disconnected when the modem restarts. You can reconnect the device to the modem using the new IP address of the modem.

## Manage Router Mode and Bridge Mode

By default, Router mode is enabled on the modem. By connecting the modem to an Ethernet switch or hub, you can connect multiple Ethernet devices such as printers, credit card terminals, and computers to the modem.

In Router mode, Network Address Translation (NAT) is enabled, the built-in Dynamic Host Configuration Protocol (DHCP) server is enabled to assign a LAN IP address to each connected device, and IP pass-through (IPPT) is disabled.

In Bridge mode, only a single device can be connected to the Internet through the modem. This device can be a computer, router, or WiFi router. In Bridge mode, Network Address Translation (NAT) is disabled, the DHCP server is disabled, and IPPT is enabled.

Because IPPT is enabled in Bridge mode, Bridge mode can be useful for implementing a virtual private network (VPN), point-to-point, or remote management connection to a single device that is connected to the modem. Such connections usually require that a public IP address is assigned to the modem's WAN port, and through IPPT, to the device that is connected to the modem. For Bridge mode, you can also specify the LTE netmask.

### ► To change the modem from Router mode to Bridge mode, or the other way around:

1. Launch a web browser from a device that is connected to the modem.  
The device can be a computer that is directly connected to the modem or a client from a router that is connected to the modem.
2. In the address field of your browser, enter **http://192.168.5.1**.  
The limited Dashboard page displays.
3. If you did not select the **Remember me** check box when you logged in previously, enter the modem password in the **Sign In** field.  
See the modem label for the default password.
4. Click the **Sign In** button.  
The full Dashboard page displays.
5. Select **Settings > Advanced > LAN**.  
The LAN page displays.

---

**Note** The diagnostics feature on the LAN page is intended for NETGEAR technical support only. By default, the Enable Diagnostics **Off** radio button is selected.

---

6. Do one of the following:
  - To enable Bridge mode, select the **Bridge** radio button. As an option, enter a different IP address in the **IP Address** field and an LTE network mask in the **Netmask (LTE)** field.  
When the modem functions in Bridge mode, the default LTE network mask setting (255.255.255.0) works with most routers. If the modem and router do not operate together, adjust LTE network mask.
  - To enable Router mode, select the **Router** radio button.

By default, the **Router** radio button is selected.

7. Click the **Submit** button.

Your settings are saved and the modem restarts. Any devices that are connected to the modem are disconnected when the modem restarts.

Enabling Bridge mode automatically disables the modem's DHCP server. You can connect only a single device to the modem.

Enabling Router mode automatically enables the modem's DHCP server, which assigns a LAN IP address to each connected device.

## Change the DHCP Server Settings

---

**Note** You can change the DHCP server settings only when the modem functions in Router mode (see *Manage Router Mode and Bridge Mode* on page 26).

---

The modem is preconfigured to function as a DHCP server when Router mode is enabled. The modem's default DHCP IP address range is 192.168.5.20–192.168.5.99.

Although you can change the DHCP address range of the modem, this is rarely necessary. However, if you establish a VPN connection to a server that assigns IP addresses in the same range as the one that is used by the modem, you must change the DHCP range of the modem to prevent network problems.

The modem's DHCP server assigns IP, DNS server, and default gateway addresses to all computers connected to the LAN. The assigned default gateway address is the LAN address of the modem. The modem assigns IP addresses to the attached computers from a predefined pool of addresses. (You can change the pool of addresses.) Each pool address is tested before it is assigned to avoid duplicate addresses on the LAN. For most applications, the default DHCP and TCP/IP settings of the modem work well.

The modem delivers the following parameters to any LAN device that requests DHCP:

- An IP address from the range that you defined
- Subnet mask
- Gateway IP address (the modem's LAN IP address)
- DNS server IP address (the modem's LAN IP address)

► **To change the DHCP server settings when the modem functions in Router mode:**

1. Launch a web browser from a device that is connected to the modem.  
The device can be a computer that is directly connected to the modem or a client from a router that is connected to the modem.
2. In the address field of your browser, enter **http://192.168.5.1**.  
The limited Dashboard page displays.
3. If you did not select the **Remember me** check box when you logged in previously, enter the modem password in the **Sign In** field.  
See the modem label for the default password.

## LTE Modem Model LB2120

- Click the **Sign In** button.  
The full Dashboard page displays.

- Select **Settings > Advanced > LAN**.

IP Address	<input type="text" value="192.168.5.1"/>
Netmask	<input type="text" value="255.255.255.0"/>
Operation Modes	<input type="radio"/> Bridge <input checked="" type="radio"/> Router
<small>When set to Bridge, this option turns off the router function of the device and assigns the network IP address directly to the attached host. This option can be useful for implementing secure, enterprise VPNs.</small>	
VPN Passthrough	<input checked="" type="radio"/> On <input type="radio"/> Off
DHCP Server	<input checked="" type="radio"/> Enabled <input type="radio"/> Disabled
DHCP IP Range	<input type="text" value="192.168.5.20"/> - <input type="text" value="192.168.5.99"/>
DHCP lease time (minutes)	<input type="text" value="720"/>
DNS mode	<input type="radio"/> Manual <input checked="" type="radio"/> Auto

---

**DMZ**

DMZ Enabled	<input type="radio"/> On <input checked="" type="radio"/> Off
-------------	--

---

**Note** The diagnostics feature on the LAN page is intended for NETGEAR technical support only. By default, the Enable Diagnostics **Off** radio button is selected.

---

- Make sure that next to DHCP Server, the **Enabled** radio button is selected.  
By default, when the modem functions in Router mode, the DHCP server is enabled.
- In the **DHCP IP Range** fields, enter the start and end IP addresses for the DHCP pool.  
The IP addresses must be in the same network as the LAN IP address of the modem. By default, the DHCP pool consists of addresses in the 192.168.5.20–192.168.5.99 range.  
The **Submit** button displays after you enter IP addresses for the DHCP pool.
- To change the period that the leased DHCP address remains effective, in the **DHCP lease time** field, enter a time in minutes.  
By default, the lease time is 720 minutes (12 hours).
- To change the DNS settings, next to DNS mode, select the **Manual** radio button.  
The **DNS 1** and **DNS 2** fields display.

---

## Manage the Modem LAN Settings

By default, the **Auto** radio button is selected and the modem uses the DNS servers that are specified by the mobile broadband service provider.

10. If you select the **Manual** radio button next to DNS mode, in the **DNS 1** and **DNS 2** fields, enter the IP addresses of the custom DNS servers.

11. Click the **Submit** button.

Your settings are saved.

When you change the DHCP server settings, the modem resets. Any devices that are connected to the modem are disconnected when the modem resets and must obtain a new IP address when they reconnect to the modem.

## Disable the DHCP Server

---

**Note** You can disable the DHCP server only when the modem functions in Router mode (see *Manage Router Mode and Bridge Mode* on page 26).

---

If you do not need the modem to issue IP addresses to connected devices through its DHCP server, you can disable the DHCP server.

### ► To disable the modem's DHCP server when the modem functions in Router mode:

1. Launch a web browser from a device that is connected to the modem.  
The device can be a computer that is directly connected to the modem or a client from a router that is connected to the modem.
2. In the address field of your browser, enter **http://192.168.5.1**.  
The limited Dashboard page displays.
3. If you did not select the **Remember me** check box when you logged in previously, enter the modem password in the **Sign In** field.  
See the modem label for the default password.
4. Click the **Sign In** button.  
The full Dashboard page displays.
5. Select **Settings > Advanced > LAN**.  
The LAN page displays.

---

**Note** The diagnostics feature on the LAN page is intended for NETGEAR technical support only. By default, the Enable Diagnostics **Off** radio button is selected.

---

6. Next to DHCP Server, select the **Disable** radio button.  
The **Submit** button displays after you select the radio button.

By default, the **Enable** radio button is selected and the DHCP server issues IP addresses to connected devices.

7. Click the **Submit** button.  
Your settings are saved.

## Enable the DMZ

---

**Note** You can enable the DMZ settings only when the modem functions in Router mode (see *Manage Router Mode and Bridge Mode* on page 26).

---

In a demilitarized zone (DMZ) network configuration, a designated computer runs outside the firewall in the DMZ. This computer intercepts incoming Internet traffic, providing an extra layer of protection for the rest of the network, and sending all incoming data to a particular IP address.

### ▶ To enable the DMZ when the modem functions in Router mode and to designate a computer to receive incoming traffic:

1. Launch a web browser from a device that is connected to the modem.  
The device can be a computer that is directly connected to the modem or a client from a router that is connected to the modem.
2. In the address field of your browser, enter **http://192.168.5.1**.  
The limited Dashboard page displays.
3. If you did not select the **Remember me** check box when you logged in previously, enter the modem password in the **Sign In** field.  
See the modem label for the default password.
4. Click the **Sign In** button.  
The full Dashboard page displays.
5. Select **Settings > Advanced > LAN**.  
The LAN page displays.

---

**Note** The diagnostics feature on the LAN page is intended for NETGEAR technical support only. By default, the Enable Diagnostics **Off** radio button is selected.

---

6. Scroll down to the bottom of the page.
7. In the DMZ section, next to DMZ Enabled, select the **On** radio button.  
The **Submit** button and the **IP Address** field display after you select the radio button.  
By default, the **Off** radio button is selected and the DMZ server is disabled.
8. In the **DMZ Address** field, enter the IP address of the computer to which you want all data sent.

By default, the IP address for the DMZ computer is 192.168.5.4.

9. Click the **Submit** button.

Your settings are saved and the modem restarts.

## Disable VPN Pass-Through

---

**Note** You can disable VPN pass-through only when the modem functions in Router mode (see *Manage Router Mode and Bridge Mode* on page 26).

---

If a device that is connected to the modem functions as a VPN client for a VPN endpoint on the Internet, encrypted VPN packets are sent to the modem. Because the modem filters the encrypted packets through Network Address Translation (NAT), the packets become invalid if you do not enable VPN pass-through. By default, when the modem functions in Router mode, VPN pass-through is enabled.

Situations might occur in which you want to disable VPN pass-through.

### ► To disable VPN pass-through when the modem functions in Router mode:

1. Launch a web browser from a device that is connected to the modem.  
The device can be a computer that is directly connected to the modem or a client from a router that is connected to the modem.
2. In the address field of your browser, enter **http://192.168.5.1**.  
The limited Dashboard page displays.
3. If you did not select the **Remember me** check box when you logged in previously, enter the modem password in the **Sign In** field.  
See the modem label for the default password.
4. Click the **Sign In** button.  
The full Dashboard page displays.
5. Select **Settings > Advanced > LAN**.  
The LAN page displays.

---

**Note** The diagnostics feature on the LAN page is intended for NETGEAR technical support only. By default, the Enable Diagnostics **Off** radio button is selected.

---

6. Next to VPN Passthrough, select the **Off** radio button.  
The **Submit** button displays after you select the radio button.  
By default, the **On** radio button is selected and VPN pass-through is enabled.
7. Click the **Submit** button.  
Your settings are saved and the modem restarts. Any devices that are connected to the modem are disconnected when the modem restarts.

# Manage the Mobile Broadband Connection

---

# 4

This chapter describes how to manage the mobile broadband connection of the modem.

The chapter contains the following sections:

- *Manage Mobile Broadband Auto Connect Options* on page 33
- *Manually Connect to or Disconnect From the Mobile Broadband Network* on page 34
- *Manage APN Profiles for Mobile Broadband Connections* on page 34



## Manage Mobile Broadband Auto Connect Options

By default, the modem automatically connects to your service provider's mobile broadband network, except when roaming.

### ► To change the Auto Connect options for the mobile broadband network:

1. Launch a web browser from a device that is connected to the modem.  
The device can be a computer that is directly connected to the modem or a client from a router that is connected to the modem.
2. In the address field of your browser, enter **http://192.168.5.1**.  
The limited Dashboard page displays.
3. If you did not select the **Remember me** check box when you logged in previously, enter the modem password in the **Sign In** field.  
See the modem label for the default password.
4. Click the **Sign In** button.  
The full Dashboard page displays.
5. Select **Settings > Mobile > Preferences**.

Auto Connect	<input type="radio"/> Never (connect manually each use) <input checked="" type="radio"/> Always except when roaming <input type="radio"/> Always
Network selection mode	Automatic

6. Select an Auto Connect option:
  - **Never (connect manually each use)**. The modem does not attempt to automatically connect to the mobile broadband network when powered on.  
For information about how to connect to the network manually, see *Manually Connect to or Disconnect From the Mobile Broadband Network* on page 34.
  - **Always except when roaming**. The modem automatically attempts to connect only to your network provider's mobile broadband network when powered on. When roaming, the modem does not attempt to automatically connect. This is the default setting.
  - **Always**. The modem automatically attempts to connect to the mobile broadband network when powered on.

---

**Note** You might incur roaming charges if you are outside your network provider's coverage area.

---

7. Click the **Submit** button.  
Your settings are saved.

## Manually Connect to or Disconnect From the Mobile Broadband Network

If you do not want to let the modem autoconnect to the mobile broadband network, you can disable the Auto Connect option (see *Manage Mobile Broadband Auto Connect Options* on page 33) and connect the modem to the mobile broadband network.

► **To manually connect the modem to or disconnect it from the mobile broadband network:**

1. Launch a web browser from a device that is connected to the modem.  
The device can be a computer that is directly connected to the modem or a client from a router that is connected to the modem.
2. In the address field of your browser, enter **http://192.168.5.1**.  
The limited Dashboard page displays.
3. If you did not select the **Remember me** check box when you logged in previously, enter the modem password in the **Sign In** field.  
See the modem label for the default password.
4. Click the **Sign In** button.  
The full Dashboard page displays.
5. Take one of the following actions:
  - To connect the modem to the mobile broadband network, click the **Connect** link.

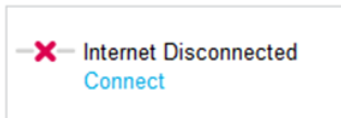

The modem attempts to connect to the mobile broadband network.

- To disconnect the modem from the mobile broadband network, click the **Disconnect** link.



The modem disconnects from the mobile broadband network.

## Manage APN Profiles for Mobile Broadband Connections

The access point name (APN) is the name of the service provider's server that provides access to the mobile broadband network. When you access a mobile broadband network, an APN profile is automatically downloaded from the service provider and configured on your modem. If you connect to different mobile broadband networks, the modem includes various APN profiles.

Although rarely required, you can create a custom APN profile manually, using information that your mobile broadband service provider gave you, and select the custom APN profile manually. The modem uses the selected APN profile to establish a connection with the mobile broadband network of the service provider.

The following sections provide information about managing APN profiles:

- [View APN Profiles or Add a Custom APN Profile](#) on page 35
- [Select an APN Profile](#) on page 37
- [Change an APN Profile](#) on page 38
- [Remove an APN Profile](#) on page 39

## View APN Profiles or Add a Custom APN Profile

To add a custom APN profile manually, use the information that your mobile broadband service provider gave you.

### ► To view APN profiles or add a custom APN profile for a service provider network:

1. Launch a web browser from a device that is connected to the modem.  
The device can be a computer that is directly connected to the modem or a client from a router that is connected to the modem.
2. In the address field of your browser, enter **http://192.168.5.1**.  
The limited Dashboard page displays.
3. If you did not select the **Remember me** check box when you logged in previously, enter the modem password in the **Sign In** field.  
See the modem label for the default password.
4. Click the **Sign In** button.  
The full Dashboard page displays.
5. Select **Settings > Mobile > APN**.  
The APN page displays.
6. To see details about the active APN profile, click the **Details** button.



If you did not yet add a custom APN profile, the default profile is the active APN profile.

## LTE Modem Model LB2120

7. To add a custom APN profile, click the **Add** button.

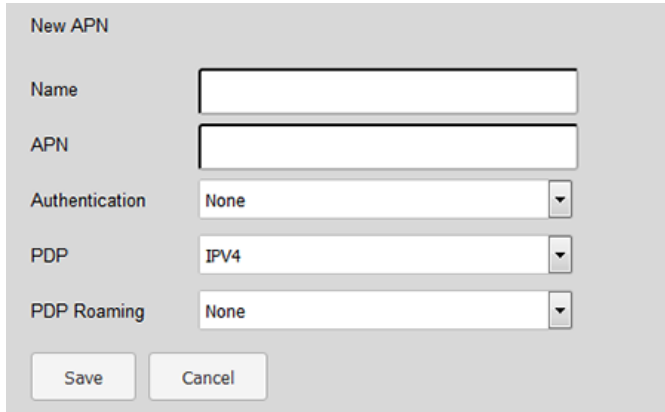

New APN

Name

APN

Authentication  ▼

PDP  ▼

PDP Roaming  ▼

8. Enter the settings for the new APN profile as described in the following table.

Field	Description
Name	Enter the name or acronym of the mobile broadband service provider or any other information that might help you to identify the APN profile.
APN	Enter the APN that provides access to the mobile broadband network. Use the information that your mobile broadband service provider gave you.
Authentication	From the menu, select the authentication mode to access the mobile broadband network: <ul style="list-style-type: none"><li>• <b>None.</b> The service provider does not require authentication. This setting is the default setting.</li><li>• <b>PAP.</b> The service provider uses Password Authentication Protocol (PAP).</li><li>• <b>CHAP.</b> The service provider uses Challenge Handshake Authentication Protocol (CHAP).</li><li>• <b>PAP or CHAP.</b> The service provider uses either PAP or CHAP.</li></ul>
Username	If you select an authentication mode, enter the user name to access the mobile broadband network.
Password	If you select an authentication mode, enter the password to access the mobile broadband network.

(Continued)

Field	Description
PDP	<p>From the menu, select the packet data protocol (PDP):</p> <ul style="list-style-type: none"> <li>• <b>IPV4.</b> The mobile broadband network uses IPv4 only. This is the default setting.</li> <li>• <b>IPV6.</b> The mobile broadband network uses IPv6 only.</li> <li>• <b>IPV4V6.</b> The mobile broadband network uses either IPv4 or IPv6.</li> </ul>
PDP Roaming	<p>From the menu, select the PDP that is used for roaming:</p> <ul style="list-style-type: none"> <li>• <b>None.</b> The modem does not use the specified PDP for roaming. This is the default setting.</li> <li>• <b>IPV4.</b> The mobile broadband network uses IPv4 only for roaming.</li> <li>• <b>IPV6.</b> The mobile broadband network uses IPv6 only for roaming.</li> <li>• <b>IPV4V6.</b> The mobile broadband network uses either IPv4 or IPv6 for roaming.</li> </ul>

9. Click the **Save** button.

The new APN profile displays on the page but is not the active profile until you select it as such (see [Select an APN Profile](#) on page 37).

## Select an APN Profile

Although rarely required, you can select an APN profile manually. The modem uses the selected APN profile to establish a connection with the mobile broadband network of the service provider.

### ► To select an APN profile as the active profile:

1. Launch a web browser from a device that is connected to the modem.  
The device can be a computer that is directly connected to the modem or a client from a router that is connected to the modem.
2. In the address field of your browser, enter **http://192.168.5.1**.  
The limited Dashboard page displays.
3. If you did not select the **Remember me** check box when you logged in previously, enter the modem password in the **Sign In** field.  
See the modem label for the default password.
4. Click the **Sign In** button.  
The full Dashboard page displays.
5. Select **Settings > Mobile > APN**.  
The APN page displays the available APN profiles.  
  
If you did not yet add a custom APN profile, the default profile is the active APN profile and you cannot select another profile until you add a custom profile (see [View APN Profiles or Add a Custom APN Profile](#) on page 35).

6. To see details about the active APN profile, click the **Details** button.  
If you did not yet add a custom APN profile, the default profile is the active APN profile.
7. Select the radio button next to the APN profile that must become the active profile.  
The APN profile is selected. The modem uses the selected APN profile to establish a connection with the mobile broadband network of the service provider.

## Change an APN Profile

You can change an existing APN profile.

### ► To change an APN profile:

1. Launch a web browser from a device that is connected to the modem.  
The device can be a computer that is directly connected to the modem or a client from a router that is connected to the modem.
2. In the address field of your browser, enter **http://192.168.5.1**.  
The limited Dashboard page displays.
3. If you did not select the **Remember me** check box when you logged in previously, enter the modem password in the **Sign In** field.  
See the modem label for the default password.
4. Click the **Sign In** button.  
The full Dashboard page displays.
5. Select **Settings > Mobile > APN**.  
The APN page displays the available APN profiles.
6. Click the **Details** button for the APN profile.  
The settings for the APN profile display, along with the **Edit** and **Delete** buttons.
7. Click the **Edit** button.  
The fields and menus become accessible, and the **Save** and **Cancel** buttons display.
8. Change the settings as needed.  
For more information about the APN profile settings, see [View APN Profiles or Add a Custom APN Profile](#) on page 35.
9. Click the **Save** button.  
Your settings are saved.

## Remove an APN Profile

You can remove an APN profile for a service provider that you no longer use. You cannot remove the default APN profile.



**WARNING:**

**Do not remove an APN profile for an active broadband session. If you do, the session is disconnected and you must either select another APN profile and establish another broadband session or restart the modem to reinstate the APN profile that you removed.**

▶ **To remove an APN profile:**

1. Launch a web browser from a device that is connected to the modem.  
The device can be a computer that is directly connected to the modem or a client from a router that is connected to the modem.
2. In the address field of your browser, enter **http://192.168.5.1**.  
The limited Dashboard page displays.
3. If you did not select the **Remember me** check box when you logged in previously, enter the modem password in the **Sign In** field.  
See the modem label for the default password.
4. Click the **Sign In** button.  
The full Dashboard page displays.
5. Select **Settings > Mobile > APN**.  
The APN page displays the available APN profiles.
6. Click the **Details** button for the APN profile.  
The settings for the APN profile display, along with the **Edit** and **Delete** buttons.
7. Click the **Delete** button.  
The APN profile is removed.

This chapter describes how to make your network more secure.

The chapter contains the following sections:

- *Change the Modem Password* on page 41
- *Manage Port Forwarding for Incoming Traffic* on page 41
- *Manage Port Filtering for Outgoing Traffic* on page 45
- *Manage SIM Card Security* on page 51



## Change the Modem Password

We recommend that you change the default password that you use to access the modem's web pages to a more secure password. See the modem label for the default password.

### ► To change the password for the modem's web pages:

1. Launch a web browser from a device that is connected to the modem.  
The device can be a computer that is directly connected to the modem or a client from a router that is connected to the modem.
2. In the address field of your browser, enter **http://192.168.5.1**.  
The limited Dashboard page displays.
3. If you did not select the **Remember me** check box when you logged in previously, enter the modem password in the **Sign In** field.  
See the modem label for the default password.
4. Click the **Sign In** button.  
The full Dashboard page displays.
5. Select **Settings**.  
The page displays the general settings.
6. In the Homepage section, in the **Admin login** field, enter a new password.  
Enter a maximum of 31 characters.  
The **Submit** button displays after you enter a password.
7. Click the **Submit** button.  
Your settings are saved.
8. Write down your new password and store it in a safe place or use a password management application to store your new password.

## Manage Port Forwarding for Incoming Traffic

---

**Note** You can enable and manage port forwarding only when the modem functions in Router mode (see *Manage Router Mode and Bridge Mode* on page 26).

---

By default, the modem blocks inbound traffic from the Internet to your computers except for replies to your outbound traffic. To allow remote computers on the Internet to access a computer on your local network, you might need to create exceptions to this rule.

Port forwarding is an advanced feature that affects the behavior of the firewall in the modem. By enabling port forwarding, you can make local computers or servers available to the Internet for different services. Port forwarding is designed for FTP servers, HTTP web servers, and other server-based applications and services. After you set up port forwarding, requests from the Internet are forwarded to the specified server.

Before you start, determine which type of service or application you want to provide and the local IP address of the computer that must provide the service.

The following sections provide information about managing port forwarding for incoming traffic:

- *Enable Port Forwarding and Add a Service or Application* on page 42
- *Remove a Service or Application for Port Forwarding* on page 43
- *Disable Port Forwarding* on page 44

## Enable Port Forwarding and Add a Service or Application

Before you add a service or application, first determine which port number and protocol the service or application uses. You can usually find this information by contacting the publisher of the service or application or searching the Internet.



### **WARNING:**

**Enabling port forwarding creates a security risk. If you do not need port forwarding, keep it disabled, which is the default setting.**

### ► **To enable port forwarding and add a service or application for port forwarding:**

1. Launch a web browser from a device that is connected to the modem.  
The device can be a computer that is directly connected to the modem or a client from a router that is connected to the modem.
2. In the address field of your browser, enter **http://192.168.5.1**.  
The limited Dashboard page displays.
3. If you did not select the **Remember me** check box when you logged in previously, enter the modem password in the **Sign In** field.  
See the modem label for the default password.
4. Click the **Sign In** button.  
The full Dashboard page displays.
5. Select **Settings > Advanced > Port Forwarding**.  
The page displays the Port Forwarding radio buttons.
6. Select the **Enable** radio button.

The Port Forwarding table displays.

Port Forwarding  Enable  
 Disable

Label	IP	Port	Protocol
<input type="text"/>	<input type="text"/>	<input type="text"/>	TCP <input type="button" value="+"/>

7. Add a service or application for port forwarding:
  - a. In the **Label** field, enter a name for the service or application.
  - b. In the **IP** field, enter the IP address for the computer that provides the service or runs the application.
  - c. In the **Port** field, enter the port number that is associated with the service or application.
  - d. From the **Protocol** menu, select the protocol (**TCP** or **UDP**) that is associated with the service or application.
  - e. Click the **+** button.  
Your settings are saved and the service or application is added to the Port Forwarding table.
8. To add another service or application for port forwarding, repeat [Step 7](#).
9. Click the **Submit** button.  
The modem resets to activate the new settings. Any devices that are connected to the modem are disconnected when the modem resets.

## Remove a Service or Application for Port Forwarding

You can remove a service or application that you no longer need for port forwarding.

### ► To remove a a service or application for port forwarding:

1. Launch a web browser from a device that is connected to the modem.  
The device can be a computer that is directly connected to the modem or a client from a router that is connected to the modem.
2. In the address field of your browser, enter **http://192.168.5.1**.  
The limited Dashboard page displays.
3. If you did not select the **Remember me** check box when you logged in previously, enter the modem password in the **Sign In** field.  
See the modem label for the default password.
4. Click the **Sign In** button.  
The full Dashboard page displays.

5. Select **Settings > Advanced > Port Forwarding**.

The Port Forwarding table displays.

6. To the right of the service or application that you want to remove from the Port Forwarding table, click the **x** button.

The service or application is removed from the Port Forwarding table.

---

**Note** To remove a service or application from the Port Forwarding table, you do not need to click the **Submit** button.

---

## Disable Port Forwarding

You can disable port forwarding. If you do so, the entries in the Port Forwarding table become hidden but are not removed. For information about removing entries, see *Remove a Service or Application for Port Forwarding* on page 43.

► **To disable port forwarding:**

1. Launch a web browser from a device that is connected to the modem.

The device can be a computer that is directly connected to the modem or a client from a router that is connected to the modem.

2. In the address field of your browser, enter **http://192.168.5.1**.

The limited Dashboard page displays.

3. If you did not select the **Remember me** check box when you logged in previously, enter the modem password in the **Sign In** field.

See the modem label for the default password.

4. Click the **Sign In** button.

The full Dashboard page displays.

5. Select **Settings > Advanced > Port Forwarding**.

The Port Forwarding table displays.

6. Select the **Disable** radio button.

7. Click the **Submit** button.

The modem resets to activate the new settings. Any devices that are connected to the modem are disconnected when the modem resets.

## Manage Port Filtering for Outgoing Traffic

---

**Note** You can enable and manage port filtering only when the modem functions in Router mode (see *Manage Router Mode and Bridge Mode* on page 26).

---

As an added security measure, you can specify which services and applications (for example, HTTP, FTP, an email server) can access or are blocked from the Internet.

Before you add a service or application, first determine which port number and protocol the service or application uses. You can usually find this information by contacting the publisher of the service or application or searching the Internet.

The following sections provide information about managing port filtering for outgoing traffic:

- *Block Specific Services and Applications From Accessing the Internet and Allow All Other Services and Applications* on page 45
- *Allow Specific Services and Applications to Access the Internet and Block All Other Services and Applications* on page 47
- *View Services and Applications on the Blacklist and Remove a Service or Application From the List* on page 48
- *View Services and Applications on the Whitelist and Remove a Service or Application From the List* on page 49
- *Disable Port Forwarding* on page 44

### Block Specific Services and Applications From Accessing the Internet and Allow All Other Services and Applications

You can set up a blacklist of services and applications that are blocked from accessing the Internet. All other services and applications are allowed to access the Internet.

---

**Note** The blacklist and whitelist are mutually exclusive. You can enable either one or the other.

---

**IMPORTANT:**

**For you to be able to set up a blacklist, the modem must be connected to the Internet. If the modem is not connected to the Internet, the configuration fails.**

► **To set up a blacklist of applications and services:**

1. Launch a web browser from a device that is connected to the modem.  
The device can be a computer that is directly connected to the modem or a client from a router that is connected to the modem.
2. In the address field of your browser, enter **http://192.168.5.1**.  
The limited Dashboard page displays.

## LTE Modem Model LB2120

- If you did not select the **Remember me** check box when you logged in previously, enter the modem password in the **Sign In** field.  
See the modem label for the default password.
- Click the **Sign In** button.  
The full Dashboard page displays.
- Select **Settings > Advanced > Port Filtering**.  
The Port Filtering page displays.
- From the **Port Filtering** menu, select **Black List**.

The screenshot shows the 'Port Filtering' section of the modem's web interface. At the top, there is a dropdown menu currently set to 'Black List'. Below this are two buttons: 'Submit' (in blue) and 'Cancel' (in grey). Underneath the buttons is a section titled 'Black List' which contains a table with three columns: 'Label', 'Port', and 'Protocol'. The 'Label' and 'Port' columns have empty text input fields. The 'Protocol' column has a dropdown menu currently showing 'TCP' and a purple '+' button to the right of it, used for adding new entries to the list.

If this is the first time that you set up the blacklist, the table is empty.

- Add a service or application to the blacklist:
  - In the **Label** field, enter a name for the service or application.
  - In the **Port** field, enter the port number that is associated with the service or application.
  - From the **Protocol** menu, select the protocol (**TCP** or **UDP**) that is associated with the service or application.
  - Click the **+** button.  
The device is added to the Black List table.
- To add another service or application to the Black List table, repeat [Step 7](#).
- Click the **Submit** button.  
Your settings are saved. The modem resets to activate the new settings. Any WiFi devices that are connected to the modem are disconnected when the modem resets.  
  
Any services and applications that are in the blacklist are blocked from accessing the Internet. Any services and applications that are not on the blacklist are allowed to access the Internet.

## Allow Specific Services and Applications to Access the Internet and Block All Other Services and Applications

You can set up a whitelist of services and applications that are allowed to access the Internet. All other services and applications are blocked from accessing the Internet.

---

**Note** The blacklist and whitelist are mutually exclusive. You can enable either one or the other.

---

**IMPORTANT:**

**For you to be able to set up a whitelist, the modem must be connected to the Internet. If the modem is not connected to the Internet, the configuration fails.**

► **To set up a whitelist of applications and services:**

1. Launch a web browser from a device that is connected to the modem.  
The device can be a computer that is directly connected to the modem or a client from a router that is connected to the modem.
2. In the address field of your browser, enter **http://192.168.5.1**.  
The limited Dashboard page displays.
3. If you did not select the **Remember me** check box when you logged in previously, enter the modem password in the **Sign In** field.  
See the modem label for the default password.
4. Click the **Sign In** button.  
The full Dashboard page displays.
5. Select **Settings > Advanced > Port Filtering**.  
The Port Filtering page displays.
6. From the **Port Filtering** menu, select **White List**.

The screenshot shows the 'Port Filtering' configuration page. At the top, there is a dropdown menu with 'White List' selected. Below this are two buttons: 'Submit' (in blue) and 'Cancel' (in grey). Underneath the buttons is a section titled 'White List' which contains a table with three columns: 'Label', 'Port', and 'Protocol'. The 'Label' and 'Port' columns have empty text input fields. The 'Protocol' column has a dropdown menu currently set to 'TCP' and a purple '+' button to its right for adding new entries.

If this is the first time that you set up the whitelist, the table is empty.

7. Add a service or application to the whitelist:

- a. In the **Label** field, enter a name for the service or application.
  - b. In the **Port** field, enter the port number that is associated with the service or application.
  - c. From the **Protocol** menu, select the protocol (**TCP** or **UDP**) that is associated with the service or application.
  - d. Click the **+** button.  
The device is added to the White List table.
8. To add another service or application to the White List table, repeat *Step 7*.
9. Click the **Submit** button.  
Your settings are saved. The modem resets to activate the new settings. Any WiFi devices that are connected to the modem are disconnected when the modem resets.
- Any services and applications that are on the whitelist are allowed to access the Internet. Any services and applications that are not on the whitelist are blocked from accessing the Internet.

## View Services and Applications on the Blacklist and Remove a Service or Application From the List

If you enabled the blacklist, you can view services and applications on the blacklist and remove a service or application from the blacklist.

### ► To view services and applications on the blacklist or remove a service or application from the blacklist:

1. Launch a web browser from a device that is connected to the modem.  
The device can be a computer that is directly connected to the modem or a client from a router that is connected to the modem.
2. In the address field of your browser, enter **http://192.168.5.1**.  
The limited Dashboard page displays.
3. If you did not select the **Remember me** check box when you logged in previously, enter the modem password in the **Sign In** field.  
See the modem label for the default password.
4. Click the **Sign In** button.  
The full Dashboard page displays.
5. Select **Settings > Advanced > Port Filtering**.  
The Port Filtering page displays.



- From the **Port Filtering** menu, select **Black List**.



### Black List

Label	Port	Protocol	
BTLFLD	16567	UDP	x
WRMS	17011	TCP	x
BSW	7670	TCP	x
<input type="text"/>	<input type="text"/>	TCP	+

- To remove a service or application from the table, to the right of the entry, click the **x** button.  
Your settings are saved and the modem resets to activate the new settings. Any WiFi devices that are connected to the modem are disconnected when the modem resets. The service or application that you removed from the blacklist is once again allowed to access the Internet.

## View Services and Applications on the Whitelist and Remove a Service or Application From the List

If you enabled the whitelist, you can view services and applications on the whitelist and remove a service or application from the whitelist.

### ► To view services and applications on the whitelist or remove a service or application from the whitelist:

- Launch a web browser from a device that is connected to the modem.  
The device can be a computer that is directly connected to the modem or a client from a router that is connected to the modem.
- In the address field of your browser, enter **http://192.168.5.1**.  
The limited Dashboard page displays.
- If you did not select the **Remember me** check box when you logged in previously, enter the modem password in the **Sign In** field.  
See the modem label for the default password.
- Click the **Sign In** button.  
The full Dashboard page displays.
- Select **Settings > Advanced > Port Filtering**.  
The Port Filtering page displays.

- From the **Port Filtering** menu, select **White List**.



### White List

Label	Port	Protocol	
HTTP	80	TCP	<input type="button" value="x"/>
HTTP	8080	TCP	<input type="button" value="x"/>
HTTPS	443	TCP	<input type="button" value="x"/>
HTTPS HyperVM	8888	TCP	<input type="button" value="x"/>
<input type="text"/>	<input type="text"/>	TCP ▼	<input type="button" value="+"/>

- To remove a service or application from the table, to the right of the entry, click the **x** button.  
Your settings are saved and the modem resets to activate the new settings. Any WiFi devices that are connected to the modem are disconnected when the modem resets. The service or application that you removed from the whitelist is now blocked from accessing the Internet.

## Disable Port Filtering

You can disable port filtering. If you do so, the entries on the blacklist and whitelist become hidden but are not removed. For information about removing entries, see [View Services and Applications on the Blacklist and Remove a Service or Application From the List](#) on page 48 or [View Services and Applications on the Whitelist and Remove a Service or Application From the List](#) on page 49.

### ► To disable port filtering:

- Launch a web browser from a device that is connected to the modem.  
The device can be a computer that is directly connected to the modem or a client from a router that is connected to the modem.
- In the address field of your browser, enter **http://192.168.5.1**.  
The limited Dashboard page displays.
- If you did not select the **Remember me** check box when you logged in previously, enter the modem password in the **Sign In** field.  
See the modem label for the default password.
- Click the **Sign In** button.  
The full Dashboard page displays.
- Select **Settings > Advanced > Port Filtering**.  
Depending on the list that you enabled, the page displays either the Black List table or the White List table.

6. From the **Port Filtering** menu, select **None**.

7. Click the **Submit** button.

Your settings are saved and the modem resets to activate the new settings. Any WiFi devices that are connected to the modem are disconnected when the modem resets. No services or applications are blocked from accessing the Internet.

## Manage SIM Card Security

You can create another level of security by establishing a PIN that you must enter before modem can access the mobile broadband connection and before you can make changes to the mobile broadband connection.

---

**Note** If you enable SIM card security, you must enter the SIM PIN each time that you turn on the modem before the modem can access the mobile broadband network.

---

The following sections provide information about managing SIM card security:

- *Enable SIM Card Security* on page 51
- *Enter the SIM PIN to Enable the Modem to Connect to the Internet* on page 53
- *Personalize the SIM PIN* on page 54
- *Disable SIM Card Security* on page 55
- *Unlock the SIM Card With a PUK* on page 57

## Enable SIM Card Security

Before you can use the PIN to enable SIM card security, you must obtain the default SIM PIN from your mobile broadband service provider. If you do not know your SIM PIN or your SIM card did not come with a PIN, you can try any of the following PINs:

- 0000
- 1111
- 1234
- Last four digits of the phone number that is associated with the SIM card



**WARNING:**

Be careful entering the SIM PIN multiple times because you can enter only a limited number of incorrect PINs before the SIM card is blocked. The number of allowed attempts depends on the SIM card. If the SIM card is blocked, you must obtain a PIN unlock key (PUK) from your mobile broadband service provider to unblock the PIN (see *Unlock the SIM Card With a PUK* on page 57).

### ► To enable SIM card security:

1. Launch a web browser from a device that is connected to the modem.  
The device can be a computer that is directly connected to the modem or a client from a router that is connected to the modem.
2. In the address field of your browser, enter **http://192.168.5.1**.  
The limited Dashboard page displays.
3. If you did not select the **Remember me** check box when you logged in previously, enter the modem password in the **Sign In** field.  
See the modem label for the default password.
4. Click the **Sign In** button.  
The full Dashboard page displays.
5. Select **Settings > Mobile > SIM Security**.  
The page displays the SIM security options.
6. Click the **Activate** button.

SIM Security: Inactive

Activating SIM Security will require you to enter a SIM PIN each time you power on the device.

Enter your PIN to activate SIM security. Obtain the default PIN from your carrier.

SIM PIN

7. In the **SIM PIN** field, enter the PIN.  
The **Submit** button displays after you enter the PIN.  
You are allowed only a limited number of attempts to enter the correct PIN. The number of allowed attempts depends on the SIM card. If you run out of available attempts, the SIM card is blocked. If the SIM card is blocked, contact your mobile broadband service provider to receive a PIN unlock key (PUK) to unblock the PIN.
8. Click the **Submit** button.  
Your settings are saved. Now, when you turn on the modem, you must enter the SIM PIN before the modem can access the mobile broadband network.

## Enter the SIM PIN to Enable the Modem to Connect to the Internet

If you enable SIM card security, you must enter the SIM PIN each time that you turn on the modem before the modem can access the mobile broadband network.



**WARNING:**

Be careful entering the SIM PIN multiple times because you can enter only a limited number of incorrect PINs before the SIM card is blocked. The number of allowed attempts depends on the SIM card. If the SIM card is blocked, you must obtain a PIN unlock key (PUK) from your mobile broadband service provider to unblock the PIN (see *Unblock the SIM Card With a PUK* on page 57).

► **To enter the SIM PIN:**

1. Launch a web browser from a device that is connected to the modem.  
The device can be a computer that is directly connected to the modem or a client from a router that is connected to the modem.
2. In the address field of your browser, enter **http://192.168.5.1**.  
The limited Dashboard page displays.
3. If you did not select the **Remember me** check box when you logged in previously, enter the modem password in the **Sign In** field.  
See the modem label for the default password.
4. Click the **Sign In** button.  
The full Dashboard page displays.  
The Alerts section of the Dashboard page displays a message about the SIM card being locked (not blocked) with a link to a pop-up window.

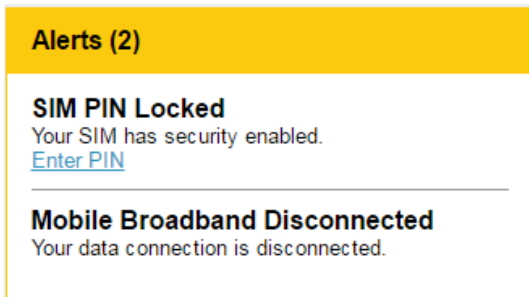

5. Click the **Enter PIN** link.

A pop-up window similar to the following one displays.

**SIM PIN Locked**

Your SIM has security enabled.

Enter SIM PIN

Retries remaining 5

6. In the **Enter SIM PIN** field, enter the PIN.  
You are allowed only a limited number of attempts to enter the correct PIN. If you run out of available attempts, the SIM card is blocked. The number of allowed attempts depends on the SIM card. If the SIM card is blocked, contact your mobile broadband service provider to receive a PIN unlock code (PUK) to unblock the PIN.  
The **Submit** button displays after you enter the PIN.
7. Click the **Submit** button.  
The modem can now access the mobile broadband network. However, it might take several minutes before the modem detects the mobile broadband network.

## Personalize the SIM PIN

If SIM security is enabled, you can change the SIM PIN to a personalized code. This code is not limited to four digits. If SIM security is disabled, you cannot change the SIM PIN.

### ► To personalize SIM card security:

1. Launch a web browser from a device that is connected to the modem.  
The device can be a computer that is directly connected to the modem or a client from a router that is connected to the modem.
2. In the address field of your browser, enter **http://192.168.5.1**.  
The limited Dashboard page displays.
3. If you did not select the **Remember me** check box when you logged in previously, enter the modem password in the **Sign In** field.  
See the modem label for the default password.
4. Click the **Sign In** button.  
The full Dashboard page displays.

5. Select **Settings > Mobile > SIM Security**.



6. Click the **Update SIM PIN** link.

Current SIM PIN	<input type="text"/>
New SIM PIN	<input type="text"/>
Verify SIM PIN	<input type="text"/>

7. In the **Current SIM PIN** field, enter the old PIN.
8. In the **New SIM PIN** field and **Verify SIM PIN** fields, enter the new PIN.
9. Click the **Submit** button.
10. Click the **OK** button.  
Your settings are saved. Make sure that you write down your new PIN and store it in a safe place.

## Disable SIM Card Security

If you no longer need SIM card security, you can disable it.



### WARNING:

Be careful entering the SIM PIN multiple times because you can enter only a limited number of incorrect PINs before the SIM card is blocked. The number of allowed attempts depends on the SIM card. If the SIM card is blocked, you must obtain a PIN unlock key (PUK) from your mobile broadband service provider to unblock the PIN (see *Unblock the SIM Card With a PUK* on page 57).

### ► To disable SIM card security:

1. Launch a web browser from a device that is connected to the modem.  
The device can be a computer that is directly connected to the modem or a client from a router that is connected to the modem.
2. In the address field of your browser, enter **http://192.168.5.1**.  
The limited Dashboard page displays.

## LTE Modem Model LB2120

3. If you did not select the **Remember me** check box when you logged in previously, enter the modem password in the **Sign In** field.

See the modem label for the default password.

4. Click the **Sign In** button.

The full Dashboard page displays.

5. Select **Settings > Mobile > SIM Security**.

SIM Security:      Active [Update SIM PIN](#)

Activating SIM Security will require you to enter a SIM PIN each time you power on the device.

6. Click the **Disable** button.

SIM Security:      Active [Update SIM PIN](#)

Enter your PIN to disable SIM security.

Activating SIM Security will require you to enter a SIM PIN each time you power on the device.

7. In the **SIM PIN** field, enter the PIN.

You are allowed only a limited number of attempts to enter the correct PIN. If you run out of available attempts, the SIM card is blocked. The number of allowed attempts depends on the SIM card. If the SIM card is blocked, contact your mobile broadband service provider to receive a PIN unlock key (PUK) to unblock the PIN.

8. Click the **Submit** button.

Your settings are saved. Now when you turn on the modem, you no longer need to enter the SIM PIN before the modem can access the mobile broadband network.



## Unlock the SIM Card With a PUK

Before you start the following procedure, contact your mobile service provider to receive a PIN unlock key (PUK) that lets you unblock the SIM card.



**WARNING:**

**Be careful entering the PUK multiple times because you can enter only a limited number of incorrect PUKs. The number of allowed attempts depends on the SIM card. If you run out of available attempts, you might need to contact your mobile broadband service provider again.**

► **To unblock the SIM card with a PUK:**

1. Launch a web browser from a device that is connected to the modem.  
The device can be a computer that is directly connected to the modem or a client from a router that is connected to the modem.
2. In the address field of your browser, enter **http://192.168.5.1**.  
The limited Dashboard page displays.
3. If you did not select the **Remember me** check box when you logged in previously, enter the modem password in the **Sign In** field.  
See the modem label for the default password.
4. Click the **Sign In** button.  
The full Dashboard page displays.  
The Alerts section of the Dashboard page displays a message about the SIM card being blocked and a link to a pop-up window.
5. Click the link.  
A pop-up window similar to the following one displays.

### SIM Blocked

Your SIM requires a PUK code to be entered.

Enter SIM PUK

Enter New SIM PIN

Verify SIM PIN:

Retries remaining 10

6. In the **Enter SIM PUK** field, enter the PUK that you obtained from your mobile service provider.

## LTE Modem Model LB2120

You are allowed a limited number of attempts to enter the correct PUK. The number of attempts depends on the SIM card. If you run out of available attempts, you might need to contact your mobile broadband service provider again.

The **Submit** button displays after you enter the PUK.

7. Take one of the following actions:

- If your mobile service provider provided you with a new SIM code, enter it in both the **Enter New SIM PIN** and **Verify SIM PIN** fields.
- If your mobile broadband service provider did not provide you with a SIM code, enter a custom SIM code (you can make up your own code) in both the **Enter New SIM PIN** field and **Verify SIM PIN** fields.

Make sure that you write down your new PIN and store it in a safe place.

8. Click the **Submit** button.

9. Click the **OK** button.

The SIM card is unblocked.

If you experience problems unblocking the SIM card, contact your mobile broadband service provider.

# Manage the Modem and Monitor Usage and the Network

---

# 6

This chapter describes how to manage the firmware and configuration file of the modem and monitor data usage and the network.

The chapter contains the following sections:

- *Upgrade the Firmware of the Modem* on page 60
- *Back Up and Restore the Modem Settings* on page 61
- *Return the Modem to Its Factory Default Settings* on page 62
- *View Monthly Data and Session Data Usage* on page 64
- *Set a Plan Limit for the Data Counter* on page 65
- *Change the Billing Cycle Counter or Reset the Data Counter* on page 66
- *View Service Provider, Type of Service, and Signal Strength* on page 66
- *View Account Details and Other Details About Your Modem* on page 68
- *View Information About the Mobile Broadband Connection* on page 69
- *Set Up SMS Alert Messages* on page 70
- *Set the Data Limit for SMS Alert Messages* on page 72
- *View Alerts* on page 73
- *Turn Off the LEDs* on page 74

## Upgrade the Firmware of the Modem

The modem's firmware (also referred to as software) is stored in flash memory.

The modem automatically checks for new firmware once a week. Firmware updates generally comprise enhancements and fixes to the functionality of the modem and modem's web pages. If the modem detects new firmware, the modem's web page displays an alert and options to download the update the firmware.

You can also manually check to see if new firmware is available and update the modem to the new firmware.

### ► To manually check for new firmware and update your modem:

1. Launch a web browser from a device that is connected to the modem.  
The device can be a computer that is directly connected to the modem or a client from a router that is connected to the modem.
2. In the address field of your browser, enter **http://192.168.5.1**.  
The limited Dashboard page displays.
3. If you did not select the **Remember me** check box when you logged in previously, enter the modem password in the **Sign In** field.  
See the modem label for the default password.
4. Click the **Sign In** button.  
The full Dashboard page displays.
5. Select **Settings > General > Software and Reset**.  
The Software and Reset page displays.  
To detect new firmware, the modem must be connected to the Internet.
6. In the Software Update section, click the **Check for update** button.  
The modem checks for new firmware. This process might take several seconds. If an update is available, the page adjusts to display the **Start download** button.
7. Click the **Start download** button.  
The firmware downloads. When the download is complete, the page adjusts to display the **Start update** button.
8. Click the **Start update** button.  
The modem installs the firmware.



#### **WARNING:**

**To avoid the risk of corrupting the firmware, do not interrupt the update. For example, do not turn off the modem.**

The page shows the progress of the firmware upload in percentage completed. The firmware update process takes several minutes. When the update is complete, the modem restarts. After several minutes, the modem becomes available again.

9. Verify that the modem runs the new firmware:

- a. Log back in to the modem.  
The Dashboard page displays.
- b. In the upper right corner, click the **About** link.  
The page displays details about the modem. The Firmware section displays the firmware version of the modem.

## Back Up and Restore the Modem Settings

You can back up (save) the configuration settings of the modem to a file on your computer and restore the configuration settings from a file. (You can maintain several backup files.)

### Back Up the Settings

You can save a copy of the configuration settings.

#### ► To back up the modem's configuration settings:

1. Launch a web browser from a device that is connected to the modem.  
The device can be a computer that is directly connected to the modem or a client from a router that is connected to the modem.
2. In the address field of your browser, enter **http://192.168.5.1**.  
The limited Dashboard page displays.
3. If you did not select the **Remember me** check box when you logged in previously, enter the modem password in the **Sign In** field.  
See the modem label for the default password.
4. Click the **Sign In** button.  
The full Dashboard page displays.
5. Select **Settings > General > Software and Reset**.

#### Download / Backup Settings

Download a copy of your device's settings onto your computer so you can restore it later.



6. In the Download / Backup Settings section, click the **Save** button.
7. Choose a location to store the file on your computer.  
The default name of the backup file is `export.cfg`.
8. Follow the directions of your browser to save the file.

## Restore the Settings

If you backed up the configuration settings, you can restore the settings from a file. (You can maintain several backup files.)

### ► To restore configuration settings that you backed up:

1. Launch a web browser from a device that is connected to the modem.  
The device can be a computer that is directly connected to the modem or a client from a router that is connected to the modem.
2. In the address field of your browser, enter **http://192.168.5.1**.  
The limited Dashboard page displays.
3. If you did not select the **Remember me** check box when you logged in previously, enter the modem password in the **Sign In** field.  
See the modem label for the default password.
4. Click the **Sign In** button.  
The full Dashboard page displays.
5. Select **Settings > General > Software and Reset**.

#### Restore Settings

If you saved your settings on a file previously, import it here to restore your device with those settings.

No file selected

6. In the Restore Settings section, click the **Browse** button.  
The default name of the backup file from which you can restore the configuration is `export.cfg`.
7. Follow the directions of your browser to locate and select the file.
8. Click the **Submit** button.  
The configuration is uploaded to the modem. When the restoration is complete, the modem restarts.

## Return the Modem to Its Factory Default Settings

Under some circumstances (for example, if you lost track of the changes that you made to the modem settings or you move the modem to a different location), you might want to erase the configuration and reset the modem to factory default settings.

To reset the modem to factory default settings, you can use either the **Reset** button on the bottom of the modem or the modem's web pages. However, if you cannot find the IP address or lost the password to access the modem, you must use the **Reset** button.

After you reset the modem to factory default settings, the password is the one that is shown on the modem label, the LAN IP address is 192.168.5.1, and Router mode is enabled. For a list of factory default settings, see *Factory Default Settings* on page 94.

### Use the Reset Button



**CAUTION:**

This process erases all settings that you configured in the modem.

► **To reset the modem to factory default settings with the Reset button:**

1. On the bottom of the modem, locate the recessed **Reset** button.
2. Insert a straightened paper clip into the hole and press for at least five seconds.

---

**Note** If you press the button for less than five seconds, the modem might just restart rather than resetting to factory default settings.

---

3. Release the button.  
The modem resets and restarts. This process takes about one minute.

### Use the Modem's Web Pages to Reset the Modem to Factory Defaults



**CAUTION:**

This process erases all settings that you configured in the modem.

► **To reset the modem to factory default settings with the modem's web pages:**

1. Launch a web browser from a device that is connected to the modem.  
The device can be a computer that is directly connected to the modem or a client from a router that is connected to the modem.
2. In the address field of your browser, enter **http://192.168.5.1**.  
The limited Dashboard page displays.
3. If you did not select the **Remember me** check box when you logged in previously, enter the modem password in the **Sign In** field.  
See the modem label for the default password.
4. Click the **Sign In** button.  
The full Dashboard page displays.

5. Select **Settings > General > Software and Reset**.

### Factory Reset

Reset your device to factory settings, just like when you took it out of the box the first time.



6. In the Factory Reset section, click the **Reset** button.

The configuration is reset to factory default settings. When the restoration is complete, the modem restarts.



### WARNING:

**To avoid the risk of corrupting the firmware, do not interrupt the restoration. For example, do not close the browser, click a link, or load a new page. Do not turn off the modem.**

## View Monthly Data and Session Data Usage

You can view an estimate of your data usage since the start of the billing cycle as well as the data usage and time that passed since the modem connected to the mobile broadband network in the current session.

The plan data counter resets automatically when the next billing cycle starts, and the session data counter resets automatically for each session. You can also change the billing start date for display only or reset the data counter (see [Change the Billing Cycle Counter or Reset the Data Counter](#) on page 66).

### ► To view detailed data usage:

1. Launch a web browser from a device that is connected to the modem.  
The device can be a computer that is directly connected to the modem or a client from a router that is connected to the modem.
2. In the address field of your browser, enter **http://192.168.5.1**.  
The limited Dashboard page displays.
3. If you did not select the **Remember me** check box when you logged in previously, enter the modem password in the **Sign In** field.  
See the modem label for the default password.
4. Click the **Sign In** button.  
The full Dashboard page displays.

The Monthly Usage section displays the data usage for the current billing cycle and the number of days left in the billing cycle. The Session section displays the data usage and time for the current session. The Session section displays only if the modem is connected to the mobile broadband network.

By default, the billing cycle starts on the first day of the month. You can change when the monthly data counter resets by changing the billing cycle start date and you can reset the data counter manually. For more information, see [Change the Billing Cycle Counter or Reset the Data Counter](#) on page 66.



## Set a Plan Limit for the Data Counter

You can set a plan limit for the modem's data counter. A plan limit enables the modem to generate SMS alert messages to warn you about your data usage (see [Set Up SMS Alert Messages](#) on page 70). The amount of data that you enter is for tracking only and does not affect the actual data that is billed by your mobile broadband provider.

### ► To set a plan limit for the data counter:

1. Launch a web browser from a device that is connected to the modem.  
The device can be a computer that is directly connected to the modem or a client from a router that is connected to the modem.
2. In the address field of your browser, enter **http://192.168.5.1**.  
The limited Dashboard page displays.
3. If you did not select the **Remember me** check box when you logged in previously, enter the modem password in the **Sign In** field.  
See the modem label for the default password.
4. Click the **Sign In** button.  
The full Dashboard page displays.

**Monthly Usage**

0.00 GB USED      0 DAYS REMAINING

Displayed data usage is intended to help manage usage. The amounts shown are approximate and may vary.

Billing start date  
Day 10 each month      Reset

Plan Limit  
[ ] GB

5. In the Monthly Usage section, in the **Plan Limit** field, enter the amount of data that you want to track.  
The **Submit** button displays after you enter an amount.
6. From the menu, select **MB** or **GB**.
7. Click the **Submit** button.  
Your settings are saved. The **Enable Data Alerts** check box and slider display. For information about how to set a data limit for SMS alert messages, see [Set the Data Limit for SMS Alert Messages](#) on page 72.

## Change the Billing Cycle Counter or Reset the Data Counter

You can change the start date of the billing cycle counter to a day other than the first day of the month and you can reset the data counter. The start date of the billing cycle counter is for display only and changing it does not change the actual billing cycle of your mobile broadband provider.

### ► To change the start date of the billing cycle counter or to reset the data counter:

1. Launch a web browser from a device that is connected to the modem.  
The device can be a computer that is directly connected to the modem or a client from a router that is connected to the modem.
2. In the address field of your browser, enter **http://192.168.5.1**.  
The limited Dashboard page displays.
3. If you did not select the **Remember me** check box when you logged in previously, enter the modem password in the **Sign In** field.  
See the modem label for the default password.
4. Click the **Sign In** button.  
The full Dashboard page displays.
5. In the Monthly Usage section, from the **Billing start date** menu, select a new start date.  
The **Submit** button displays after you make a selection.
6. To reset the data counter for data usage, click the **Reset** button.
7. Click the **Submit** button.  
Your settings are saved.

## View Service Provider, Type of Service, and Signal Strength

You can view the service provider, the type of network, and the signal strength of the mobile broadband network at your location. If the modem is not connected to the network, you can view some of this information for the most recent connection.

### ► To view the service provider, type of network, signal strength, and other information:

1. Launch a web browser from a device that is connected to the modem.  
The device can be a computer that is directly connected to the modem or a client from a router that is connected to the modem.
2. In the address field of your browser, enter **http://192.168.5.1**.  
The limited Dashboard page displays.

## LTE Modem Model LB2120

3. If you did not select the **Remember me** check box when you logged in previously, enter the modem password in the **Sign In** field.

See the modem label for the default password.

4. Click the **Sign In** button.

The full Dashboard page displays.

In the connection graph, the broadband icon and the information below it display the following:

- **Signal strength.** Five bars in the broadband icon indicate the strongest signal. One bar indicates the weakest signal.
- **Service provider.** The name of the mobile broadband service provider (or operator).
- **Type of service.** The type of service is indicated by icons that are described in the following table. Different service providers can use different icons. The following figure shows an example of 4G service. The following table shows the types of mobile broadband services.
- **Connection state.** The Internet connection state (Internet Connected or Internet Disconnected).
- **Roaming state.** If the modem is roaming, a roaming icon and notification might display.

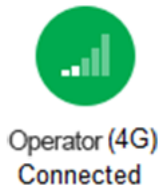

**Table 3. Types of mobile broadband service**

Icon	Type of Mobile Broadband Service	
4G	Long Term Evolution (LTE)	4G
H+	Dual Carrier HSPA Plus HSPA Plus	3G
H	HSPA HSUPA HSDPA	
3G	UMTS	
2G	EDGE GPRS	2G

---

**Note** Model LB2120-100NAS does not support 2G.

---

## View Account Details and Other Details About Your Modem

You can view details about your modem such as the mobile number, IMEI (International Mobile Station Equipment Identity), firmware version and related information, and so on.

► **To view details about your modem:**

1. Launch a web browser from a device that is connected to the modem.  
The device can be a computer that is directly connected to the modem or a client from a router that is connected to the modem.
2. In the address field of your browser, enter **http://192.168.5.1**.  
The limited Dashboard page displays.
3. If you did not select the **Remember me** check box when you logged in previously, enter the modem password in the **Sign In** field.  
See the modem label for the default password.
4. Click the **Sign In** button.  
The full Dashboard page displays.
5. In the upper right corner, click the **About** link.  
The page displays details about the modem and its configuration.

The screenshot displays the 'About' page of the modem, organized into several sections:

- Account Details:** My number: +1 (760) 760-7600; IMEI: 350070070000625; IMSI: 31000000094144; FSN: 4PL0000C0003A; ICCID: 8900000000008941448.
- Device:** Model: LB2120; LB2120 Manager: http://192.168.5.1; PRI Version: 23113143, 01.25.
- Firmware:** Firmware Version: M18Q2\_v12.09.163431; App Version: NTG9X07C\_12.09.05.16; Web App Version: LBHDATA\_03.03.103.145; Bootloader Version: Bootloader Ver: v1.0.0; Hardware Version: 02.
- Network Status:** View Details.
- Open Source:** View Credits & Licenses; GNU GPL.

A 'Save to File' button is located at the bottom left of the page.

The displayed details are self-explanatory, except for the following information in the Account Details section:

- Information that is associated with the SIM card:

## LTE Modem Model LB2120

- **IMSI**. International Mobile Subscriber Identity (IMSI), used to identify the subscriber account (that is, the SIM card) on the network.
  - **ICCID**. Integrated Circuit Card Identifier (ICCID). This is the serial number of the SIM card.
  - Information that is associated with the modem:
    - **IMEI**. International Mobile Station Equipment Identity (IMEI), used to identify the device (that is, the modem) on the network.
    - **FSN**. Factory serial number (FSN). This is the serial number of the modem.
6. To view details about the network, in the Network Status section, click the **View Details** link.  
For more information, see [View Information About the Mobile Broadband Connection](#) on page 69.
  7. To save the information to a file, do the following:
    - a. Scroll down to the bottom of the page and click the **Save to File** button.  
The default name of the backup file is `about.txt`.
    - b. Follow the directions of your browser to save the file.

## View Information About the Mobile Broadband Connection

You can view details about your modem such as the mobile number, IMEI (International Mobile Station Equipment Identity), firmware version and related information, and so on.

### ► To view details about your modem:

1. Launch a web browser from a device that is connected to the modem.  
The device can be a computer that is directly connected to the modem or a client from a router that is connected to the modem.
2. In the address field of your browser, enter **http://192.168.5.1**.  
The limited Dashboard page displays.
3. If you did not select the **Remember me** check box when you logged in previously, enter the modem password in the **Sign In** field.  
See the modem label for the default password.
4. Click the **Sign In** button.

The full Dashboard page displays.

5. Select **Settings > Mobile > Status Details**.

### 4G Details

Status	Connected
PS service type	LTE
Network	Operator
Roaming	Off
RSRP	-113
RSRQ	-8
RS-SINR	0
PLMN	310410
LAC	36107
RAC	0
PSC	-1
Cell ID	171773208
TX Power	0
IP Address	10.5.234.91
IPv6 Address	
Quality	32
Channel UL	20200
Channel Number	2200
IMSI	310000000061314
My number	17607607600
Current radio band	LTE B4
Reject Code	-1
ICCID	89000000000142613141

The information that is displayed on this page is not described in this manual. If you experience mobile broadband service problems, this information might be requested by NETGEAR support or by the support team of your mobile broadband service provider.

For more information about your modem and the broadband network connection, see the following sections:

- [View Service Provider, Type of Service, and Signal Strength](#) on page 66
- [View Account Details and Other Details About Your Modem](#) on page 68

## Set Up SMS Alert Messages

You can set up the modem to automatically send SMS alert messages (or in short, alerts) if particular conditions occur. The modem can send such messages to up to three devices. SMS charges might apply.

The format of an SMS alert message is as follows: [XXX] [YYYYYY] [ZZZZZZZZZZZZZZ] [Text]

- [XXX] is a message ID with a number from 0 to 999. For example, 003.
- [YYYYYY] is the model number, which consists of 6 characters. For example, LB1110.

## LTE Modem Model LB2120

- [ZZZZZZZZZZZZZZ] is the factory serial number (FSN), which consists of 13 characters. For example, 4PX123AB1234C.
- [Text] is the message text. For example, software update is available.

An example of an SMS alerts message is: 003 LB1110 4PX123AB1234C software update is available.

### ▶ To set up SMS alerts:

1. Launch a web browser from a device that is connected to the modem.  
The device can be a computer that is directly connected to the modem or a client from a router that is connected to the modem.
2. In the address field of your browser, enter **http://192.168.5.1**.  
The limited Dashboard page displays.
3. If you did not select the **Remember me** check box when you logged in previously, enter the modem password in the **Sign In** field.  
See the modem label for the default password.
4. Click the **Sign In** button.  
The full Dashboard page displays.
5. Select **Settings > General > Alerts**.

SMS Alerts  On  
 Off

Send text message alerts to one or more devices. Outgoing SMS charges may apply.  
Note: You may need to specify the international dialing prefix and country code in the device phone number.

Device Phone #s

Alerts

Switch to Wireline Broadband

Switch to 3G/4G LTE

Software Update Available

3G/4G LTE Data Limit Warning

3G/4G LTE Data Limit Exceeded

By default, the **On** radio button is selected and the capability to send SMS alerts is enabled.

6. In the **Device Phone #s** fields, enter the phone numbers to which the modem must send alerts.  
The **Submit** button displays after you enter a phone number.
7. Select one or more check boxes for the alerts that the modem must send:

- **Switch to Wireline Broadband.** The modem switched from the mobile broadband connection to the wireline broadband connection.
- **Switch to 3G/4G LTE.** The modem switched from the wireline broadband connection to the mobile broadband connection.
- **Software Update Available.** The modem detects that new firmware is available.
- **3G/4G LTE Data Limit Warning.** The configured mobile broadband data limit is about to be exceeded. (For more information, see [Change the Billing Cycle Counter or Reset the Data Counter](#) on page 66.)
- **3G/4G LTE Data Limit Exceeded.** The configured mobile broadband data limit was exceeded.

---

**Note** For information about setting data limits, see [Set a Plan Limit for the Data Counter](#) on page 65. For information about resetting the data counter, see [Change the Billing Cycle Counter or Reset the Data Counter](#) on page 66.

---

8. Click the **Submit** button.  
Your settings are saved.

## Set the Data Limit for SMS Alert Messages

After you specify a plan limit for the data counter (see [Set a Plan Limit for the Data Counter](#) on page 65), you can set the data limit for SMS alert messages as a percentage of the data that is still available on your plan limit. For example, if you set the plan limit for the data counter at 1 GB and the data limit for SMS alert messages at 10 percent, the modem can generate data limit warnings for SMS alert messages if the data counter falls below 100 MB. For information about setting up SMS alert messages, see [Set Up SMS Alert Messages](#) on page 70.

### ► To set the data limit for SMS alert messages:

1. Launch a web browser from a device that is connected to the modem.  
The device can be a computer that is directly connected to the modem or a client from a router that is connected to the modem.
2. In the address field of your browser, enter **http://192.168.5.1**.  
The limited Dashboard page displays.
3. If you did not select the **Remember me** check box when you logged in previously, enter the modem password in the **Sign In** field.  
See the modem label for the default password.
4. Click the **Sign In** button.



The full Dashboard page displays.

The screenshot shows a 'Monthly Usage' dashboard. At the top, it displays '0.00 GB USED' and '0 DAYS REMAINING'. Below this is a disclaimer: 'Displayed data usage is intended to help manage usage. The amounts shown are approximate and may vary.' The 'Billing start date' is set to 'Day 10 each month' with a 'Reset' button. The 'Plan Limit' is set to '1 GB'. There is a checked checkbox for 'Enable Data Alerts (10%)' and a slider below it, currently positioned at 10% between 0 and 100%.

The **Enable Data Alerts** check box and slider display only after you specify a plan limit for the data counter.

5. Make sure that the **Enable Data Alerts** check box is selected.  
By default, the **Enable Data Alerts** check box is selected.
6. Move the slider to set the percentage of the data that is still available on your plan limit.  
The percentage displays next to the **Enable Data Alerts** check box.  
Your settings are saved. (You do not need to click a **Submit** button.)  
If you set up SMS alerts messages, the modem generates data limit warnings for SMS alert messages if the data counter falls below the specified percentage.

## View Alerts

Your modem displays alerts to advise you of device status changes.

---

**Note** Alerts remain displayed as long as the issues that cause them are active. When the issues are resolved, the alerts are removed automatically.

---

### ► To view alerts:

1. Launch a web browser from a device that is connected to the modem.  
The device can be a computer that is directly connected to the modem or a client from a router that is connected to the modem.
2. In the address field of your browser, enter **http://192.168.5.1**.  
The limited Dashboard page displays.

3. If you did not select the **Remember me** check box when you logged in previously, enter the modem password in the **Sign In** field.  
See the modem label for the default password.
4. Click the **Sign In** button.  
The full Dashboard page displays.  
Alerts display in the Alerts section at the top of the page.
5. Follow the instructions in each alert to address the conditions that caused it to display.

## Turn Off the LEDs

By default, the LED bars on the top panel of the modem are enabled to indicate the status of the modem and the mobile broadband connection. There might be situations in which you want to turn off the LED bars. However, the LAN LED bar cannot be turned off.

### ► To turn off the LED bars except for the LAN LED bar:

1. Launch a web browser from a device that is connected to the modem.  
The device can be a computer that is directly connected to the modem or a client from a router that is connected to the modem.
2. In the address field of your browser, enter **http://192.168.5.1**.  
The limited Dashboard page displays.
3. If you did not select the **Remember me** check box when you logged in previously, enter the modem password in the **Sign In** field.  
See the modem label for the default password.
4. Click the **Sign In** button.  
The full Dashboard page displays.
5. Select **Settings**.  
The page displays the general settings.
6. In the Device LED section, select the **Off** radio button.  
By default, the **On** radio button is selected.  
The **Submit** button displays after you change the selection.
7. Click the **Submit** button.  
Your settings are saved and the LED bars except for the LAN LED bar turn off.

# Manage SMS Messages

---

# 7

This chapter describes how to manage SMS messages.

The chapter contains the following sections:

- *Manage Incoming SMS Messages* on page 76
- *Send an SMS Message* on page 77

## Manage Incoming SMS Messages

The modem notifies you of unread SMS messages by showing a number next to the **Messaging** link on the main menu. You can view these messages and delete messages that you no longer need.

► **To view and delete a message:**

1. Launch a web browser from a device that is connected to the modem.  
The device can be a computer that is directly connected to the modem or a client from a router that is connected to the modem.
2. In the address field of your browser, enter **http://192.168.5.1**.  
The limited Dashboard page displays.
3. If you did not select the **Remember me** check box when you logged in previously, enter the modem password in the **Sign In** field.  
See the modem label for the default password.
4. Click the **Sign In** button.  
The full Dashboard page displays.
5. Select **Messaging**.

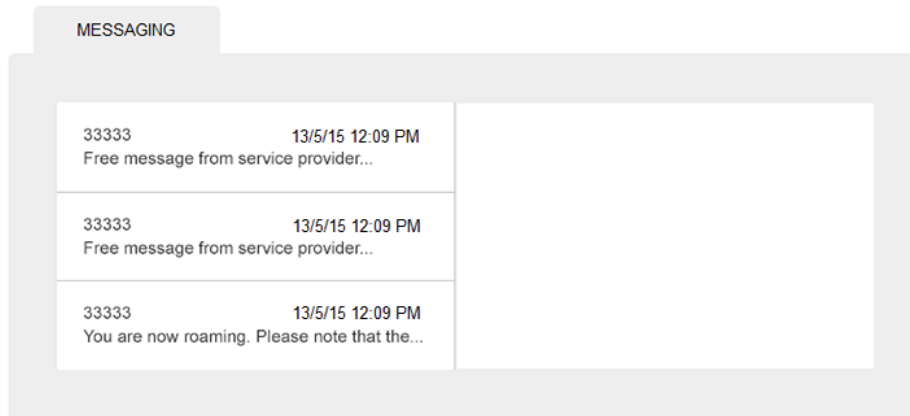

6. To view details about a message, click the message.  
The message details display on the right, along with the **Delete** button.
7. To delete the message, do the following:
  - a. Click the **Delete** button.
  - b. Confirm your decision by clicking the **Delete** button again.  
The message is deleted.

## Send an SMS Message

You can send a short SMS message of up to 70 characters directly from the modem.

► **To send an SMS message:**

1. Launch a web browser from a device that is connected to the modem.  
The device can be a computer that is directly connected to the modem or a client from a router that is connected to the modem.
2. In the address field of your browser, enter **http://192.168.5.1**.  
The limited Dashboard page displays.
3. If you did not select the **Remember me** check box when you logged in previously, enter the modem password in the **Sign In** field.  
See the modem label for the default password.
4. Click the **Sign In** button.  
The full Dashboard page displays.
5. Select **Messaging**.  
The Messaging page displays.
6. Click the **New** button.  
The **To** and **Message** fields display.
7. In the **To** field, enter the phone number to which you want to send the message.  
The **Discard** button and Envelope icon display.
8. In the **Message** field, enter the message text.  
The number of characters is limited to 70.
9. Click the Envelope icon.  
The message is queued for sending. After the message is sent, a confirmation pop-up window displays.

# Frequently Asked Questions

---

# 8

This chapter provides answers to questions that might come up about your modem.

The chapter contains the following sections:

- *What do I do when I can't connect a device to the modem?* on page 79
- *What do I do when I can't access the Internet?* on page 79
- *What do I do when the No Signal icon displays?* on page 79
- *Why does the Signal Strength LED show only a few bars?* on page 79
- *Why is the download or upload speed slow?* on page 79
- *Can I connect multiple LAN devices to the modem?* on page 80
- *Access the Modem's Web Pages for the First Time* on page 17
- *Return the Modem to Its Factory Default Settings* on page 62
- *How do I disconnect from the mobile broadband network?* on page 80
- *How do I find my computer's IP address?* on page 81
- *How do I find a device's MAC address?* on page 82
- *How do I find my mobile phone number?* on page 84
- *Where can I find more information?* on page 84

---

**Note** If the information in this chapter does not help you, see *Alerts and Troubleshooting* on page 85.

---

## What do I do when I can't connect a device to the modem?

If you are experiencing problems connecting to the modem, try the following suggestions:

- Disconnect your device from the modem.
- Turn off your modem, wait 10 seconds, and turn on your modem.
- Restart your device.
- Wait for the modem to connect to the network before you connect the Ethernet cable to your device.
- Turn off or temporarily disable any security programs or firewalls on your device.
- If possible, try using another device to connect to your modem. If you can, then the problem is with the device that cannot connect, not the modem.

## What do I do when I can't access the Internet?

If you are connected to the modem but cannot connect to the Internet, try the following suggestions:

- Make sure that network coverage is available in your area.
- Make sure that your micro SIM card is active and enabled with data services.
- Confirm that your account is activated and that no other Internet connections are active.
- Switch your modem off and on and restart your computer.
- Verify that an access profile name (APN) profile exists for the service provider. For more information, see [View APN Profiles or Add a Custom APN Profile](#) on page 35.

## What do I do when the No Signal icon displays?

If the No Signal icon  displays on the modem's web page, make sure that you are in your network provider's coverage area.

## Why does the Signal Strength LED show only a few bars?

Reception on your modem is poor. Try moving it to a location with a clear view of the sky (for example, near a window).

If the reception does not improve, consider purchasing an external antenna (see [Optional External Antenna](#) on page 14).

## Why is the download or upload speed slow?

Data transfer speed depends on signal strength and interfering radio sources such as electrical generators or WiFi devices.

Check your signal strength and network type (for example, LTE 4G is generally faster than 3G).

## Can I connect multiple LAN devices to the modem?

By connecting the modem to an Ethernet switch or hub, you can connect multiple Ethernet devices such as printers, credit card terminals, and computers to the modem.

In such a configuration, the modem must function in Router mode (which it does by default) so that Network Address Translation (NAT) is enabled and the built-in Dynamic Host Configuration Protocol (DHCP) server can assign a LAN IP address to each Ethernet device.

For more information, see *Manage Router Mode and Bridge Mode* on page 26.

## How do I access the modem's web pages?

For information about accessing the modem's web pages, see *Access the Modem's Web Pages for the First Time* on page 17.

## What do I do if I forget my admin login password?

The default admin login password is the one that is shown on the modem label, and the modem web page URL is `http://192.168.5.1`.

If you changed the admin login password and cannot remember the password that you created, you must set the modem back to factory default settings. For more information, see *Return the Modem to Its Factory Default Settings* on page 62.

## How do I disconnect from the mobile broadband network?

### ► To disconnect from the network:

1. Launch a web browser from a device that is connected to the modem.  
The device can be a computer that is directly connected to the modem or a client from a router that is connected to the modem.
2. In the address field of your browser, enter **http://192.168.5.1**.  
The limited Dashboard page displays.
3. If you did not select the **Remember me** check box when you logged in previously, enter the modem password in the **Sign In** field.  
See the modem label for the default password.
4. Click the **Sign In** button.  
The full Dashboard page displays.  
On the left, under the main menu, a link lets you connect to or disconnect from the mobile broadband network.
5. On the left, under the main menu, click the **Disconnect** button.



## How do I find my computer's IP address?

The steps for finding your computer's IP address depend on the operating system. If your device runs an operating system that is not listed here, see the appropriate operating system documentation.

**Table 4. Find your computer's IP address**

Operating System	Task Description
Windows 7	<p>To find the IP address on a Windows 7 device:</p> <ol style="list-style-type: none"> <li>1. Select <b>Start &gt; Run</b>. The Run window opens.</li> <li>2. Enter <code>cmd</code> or <code>command</code> and click the <b>OK</b> button. The Command Prompt window opens.</li> <li>3. At the command prompt, enter <code>ipconfig</code> and press Enter. For an Ethernet connection, the IP address might be listed in the Ethernet adapter Local Area Connection section.</li> <li>4. Write down the IP address for the entry that relates to the Ethernet network connection.</li> </ol>
Windows 8	<p>To find the IP address on a Windows 8 device:</p> <ol style="list-style-type: none"> <li>1. In the Charms bar, click the <b>Search</b> icon.</li> <li>2. Enter <b>Command Prompt</b>.</li> <li>3. In the search results, click <b>Command Prompt</b>. The Command Prompt window opens.</li> <li>4. At the command prompt, enter <code>ipconfig</code> and press Enter. For an Ethernet connection, the IP address might be listed in the Ethernet adapter Local Area Connection section.</li> <li>5. Write down the IP address for the entry that relates to the Ethernet network connection.</li> </ol>
Windows 10	<p>To find the IP address on a Windows 10 device:</p> <ol style="list-style-type: none"> <li>1. In the Task bar, click the <b>Search</b> field.</li> <li>2. Enter <b>Command Prompt</b>.</li> <li>3. In the search results, click <b>Command Prompt</b>. The Command Prompt window opens.</li> <li>4. At the command prompt, enter <code>ipconfig</code> and press Enter. For an Ethernet connection, the IP address might be listed in the Ethernet adapter Local Area Connection section.</li> <li>5. Write down the IP address for the entry that relates to the Ethernet network connection.</li> </ol>

**Table 4. Find your computer’s IP address (Continued)**

Operating System	Task Description
MAC	<p>To find the IP address on a Mac OS X device:</p> <ol style="list-style-type: none"> <li data-bbox="410 401 1122 457">1. From the Apple menu, select <b>System Preferences &gt; Network</b>. The network settings display.</li> <li data-bbox="410 474 932 531">2. Select the Ethernet adapter. The IP address is displayed in the right pane.</li> </ol>
Other	<p>To find the IP address on devices running other operating systems, refer to the user documentation for your operating system or computer.</p>

## How do I find a device’s MAC address?

You must know the MAC address for a device when you allow or deny the device access to your WiFi network (MAC filtering).

The steps for finding a device’s MAC address depend on the operating system. If your device runs an operating system that is not listed here, see the appropriate operating system documentation.

**Table 5. Find a device's MAC address**

Operating System	Task Description
Windows 7	<p>To find the MAC address on a Windows 7 device:</p> <ol style="list-style-type: none"> <li>1. Select <b>Start &gt; Run</b>. The Run window opens.</li> <li>2. Enter <code>cmd</code> or <code>command</code> and click the <b>OK</b> button. The Command Prompt window opens.</li> <li>3. At the command prompt, enter <code>ipconfig /all</code> and press Enter. For an Ethernet connection, the MAC address (physical address) might be listed in the Ethernet adapter Local Area Connection section.</li> <li>4. Write down the physical address for the entry that relates to the WiFi network connection. This address displays as a series of numbers and letters. This is the MAC address of your Ethernet adapter.</li> </ol>
Windows 8	<p>To find the MAC address on a Windows 8 device:</p> <ol style="list-style-type: none"> <li>1. In the Charms bar, click the <b>Search</b> icon.</li> <li>2. Enter <b>Command Prompt</b>.</li> <li>3. In the search results, click <b>Command Prompt</b>. The Command Prompt window opens.</li> <li>4. At the command prompt, enter <code>ipconfig /all</code> and press Enter. For an Ethernet connection, the MAC address (physical address) might be listed in the Ethernet adapter Local Area Connection section.</li> <li>5. Write down the physical address for the entry that relates to the WiFi network connection. This address displays as a series of numbers and letters. This is the MAC address of your Ethernet adapter.</li> </ol>

**Table 5. Find a device’s MAC address (Continued)**

Operating System	Task Description
Windows 10	<p>To find the MAC address on a Windows 10 device:</p> <ol style="list-style-type: none"> <li>1. In the Task bar, click the <b>Search</b> field.</li> <li>2. Enter <b>Command Prompt</b>.</li> <li>3. In the search results, click <b>Command Prompt</b>. The Command Prompt window opens.</li> <li>4. At the command prompt, enter <code>ipconfig /all</code> and press Enter. For an Ethernet connection, the MAC address (physical address) might be listed in the Ethernet adapter Local Area Connection section.</li> <li>5. Write down the physical address for the entry that relates to the WiFi network connection. This address displays as a series of numbers and letters. This is the MAC address of your Ethernet adapter.</li> </ol>
MAC	<p>To find the MAC address on a Mac OS X device:</p> <ol style="list-style-type: none"> <li>1. From the Apple menu, select <b>System Preferences &gt; Network</b>. The network settings display.</li> <li>2. Select the Ethernet adapter that is connected to the routing hardware.</li> <li>3. Select <b>Advanced</b>.</li> <li>4. Select <b>Ethernet</b>. The Ethernet ID is displayed. This is the same thing as the MAC address.</li> </ol>

## How do I find my mobile phone number?

For information about finding your mobile phone number, see [View Account Details and Other Details About Your Modem](#) on page 68.

## Where can I find more information?

Review the following:

- Read the installation guide that came with your modem.
- Learn tips and tricks at [netgear.com/learningcenter/mobile](http://netgear.com/learningcenter/mobile) to get the most from your modem.

This chapter provides suggestions for troubleshooting problems that might arise when you are using your modem. If you do not find the solution here, check the NETGEAR support site at [netgear.com/support](http://netgear.com/support) for more product information and contact information.

The chapter contains the following sections:

- *Alert Messages* on page 86
- *Quick Tips for Troubleshooting* on page 86
- *Verify Normal Behavior With the LED Bars* on page 87
- *Troubleshoot With the LED Bars* on page 87
- *You Cannot Log In to the Modem* on page 89
- *Troubleshoot the Mobile Broadband Internet Connection* on page 89
- *Changes Not Saved on the Modem's Web Pages* on page 90
- *TCP/IP Network Not Responding* on page 91

## Alert Messages

The modem can display alerts to advise you of device status changes. The following table describes alerts that might display. For information about how to view alerts, see [View Alerts](#) on page 73.

**Table 6. Alert messages**

Alert Message or Code	Description or Solution
<b>SIM card alerts</b>	
SIM Not Installed	Ensure that the micro SIM card is installed correctly. See <a href="#">Install the Micro SIM Card</a> on page 8.
SIM Error — Check SIM	Ensure that your network service provider's micro SIM card is inserted in the modem. If a problem still exists, contact your service provider's customer service. The micro SIM card might be damaged and need replacing.
SIM Locked	The micro SIM card is locked. For information about unlocking the SIM card, see <a href="#">Unblock the SIM Card With a PUK</a> on page 57.
<b>Temperature Alerts</b>	
<p>The modem is designed to work over a wide temperature range. (For more information, see <a href="#">Technical and Environmental Specifications</a> on page 95.) The modem shuts down automatically if it goes out of the supported temperature range.</p> <p>If this situation occurs, move the modem to an area where the temperature is more suitable. If the modem is too warm, make sure that the area is well ventilated and air can circulate around the modem.</p>	

## Quick Tips for Troubleshooting



The following table includes tips for troubleshooting some common problems.

**Table 7. Quick tips for troubleshooting**

Problem	Possible Solution
<p>You cannot connect to the Internet over the mobile broadband connection.</p> <p>See also <a href="#">Troubleshoot the Mobile Broadband Internet Connection</a> on page 89.</p>	Check with your mobile broadband service provider to ensure that good coverage exists in the area.
	Make sure that your mobile broadband account is active.
	Make sure that the SIM card is inserted correctly into the modem (see <a href="#">Install the Micro SIM Card</a> on page 8).
	If SIM security is enabled, make sure that you entered the PIN correctly to unlock the SIM card (see <a href="#">Unblock the SIM Card With a PUK</a> on page 57). A locked SIM card prevents the modem from connecting to the mobile broadband network.
<p>You cannot connect over an Ethernet cable to the modem.</p>	Make sure that the Ethernet cable is securely plugged in.
	Make sure that your computer or device does not use a static IP address but is configured to receive an IP address automatically with DHCP.

## Verify Normal Behavior With the LED Bars



When you turn on the power on the modem, the Power LED bar, Signal Strength LED bars, and LAN LED bar light as described here:

1. When power is first applied, the Power LED  bar lights solid amber.
2. After approximately 12 seconds, the LAN LED  bar lights solid green and then goes off again.
3. After approximately 15 seconds, the following occurs:
  - If the Gigabit Ethernet port is connected to a device over an Ethernet cable, the LAN LED bar lights solid green.
  - If the modem detects mobile broadband coverage, the Signal Strength LED bars  indicate the quality of the coverage when the modem is connected to a LTE, 4G, 3G, or 2G mobile broadband service. Five green bars indicate the strongest signal. One green bar (that is, the shortest bar) indicates the weakest signal.
  - The Power LED bar lights solid green.

## Troubleshoot With the LED Bars

The following table describes error conditions that are indicated by the LED bars.

**Table 8. LED descriptions (error conditions)**

Designation	Icon or LED Bars	Description
Power		<b>Power LED bar blinks amber fast and individual Signal Strength LED bars light solid green.</b> For information, see <i>Power LED Bar Blinks Amber Fast and an Individual Signal and Strength LED Bar Lights Solid Green</i> on page 88.
Signal Strength		<b>Off.</b> The modem is not connected to and is not searching for a mobile broadband service. <b>Individual Signal Strength LED bar lights solid green, other Signal Strength LED bars are off.</b> For information, see <i>Power LED Bar Blinks Amber Fast and an Individual Signal and Strength LED Bar Lights Solid Green</i> on page 88.

### Power LED Bar Is Off

If the Power LED  bar is off and other LED bars are also off when you turn on the modem, do the following:

- Check that the power **On/Off** button on the back is in the On position, that is, it is pressed in.
- Check that the power cord is correctly connected to your modem and that the power supply adapter is correctly connected to a functioning power outlet.
- Check that you are using the 12 VDC 1.0A power adapter that NETGEAR supplied for this product.

If the error persists, most likely a hardware problem occurred. For recovery instructions or help with a hardware problem, contact technical support at [netgear.com/support](http://netgear.com/support).

## Power LED Bar Blinks Amber Fast and an Individual Signal and Strength LED Bar Lights Solid Green

If the Power LED  bar blinks amber fast and an individual signal strength bar lights solid green while others are off, one of the conditions that is described in the following table occurred. Bar 1 is the shortest and leftmost bar. Bar 5 is the tallest and rightmost bar.

**Table 9. Error conditions indicated by the Signal Strength LED bars**

Condition	Bar 1	Bar 2	Bar 3	Bar 4	Bar 5	Possible Solution
System too hot	Off	Off	Off	Off	Green	Turn off the modem for a while and move the modem to a location with a moderate temperature.
System over voltage	Off	Off	Off	Green	Off	Make sure that you use the power adapter that came in the product package.
						Turn off the modem for a while, and then turn it back on.
						If the condition does not improve, contact technical support at <a href="http://netgear.com/support">netgear.com/support</a> .
Micro SIM card out or not correctly installed	Off	Off	Green	Off	Off	Install or reinstall the micro SIM card.
Unknown error	Off	Off	Off	Off	Off	Turn the power off, wait 10 seconds, and turn on the modem to see if it recovers. If the Power LED bar is still blinking red fast but no individual Signal Strength bar lights solid green one minute after power-up, do the following: <ul style="list-style-type: none"> <li>• Turn the power off one more time, wait 10 seconds, and turn on the modem to see if it finally recovers.</li> <li>• Clear the modem's configuration to factory defaults (see <i>Return the Modem to Its Factory Default Settings</i> on page 62).</li> </ul>
						If the error persists, most likely a hardware problem occurred. For recovery instructions or help with a hardware problem, contact technical support at <a href="http://netgear.com/support">netgear.com/support</a> .

## LAN LED Is Off

If the LAN LED  bar is off when you connect a device to the Gigabit Ethernet port of the modem, check the following:

- The Ethernet cable connections are secured at the modem and at the device at the other end of the cable.
- The power of the device at the other end of the cable is turned on.
- You are using the correct cable.



## You Cannot Log In to the Modem

If you are unable to log in to the modem's web pages from a device that is connected to the modem, check the following:

- If you are using an Ethernet-connected computer, check the Ethernet connection between the computer and the modem (see [LAN LED Is Off](#) on page 88).
- Make sure that Java, JavaScript, or ActiveX is enabled in your browser. If you are using Internet Explorer, click the **Refresh** button to be sure that the Java applet is loaded.
- Try quitting the browser and launching it again.
- Make sure that you are using the correct login information. See the modem label for the default password. Make sure that Caps Lock is off when you enter this information.
- Make sure that your computer does not use a static IP address but is configured to receive an IP address automatically with DHCP.
- Turn off and on both the modem and the device that is connected to the modem.
- If your modem's IP address was changed and you do not know the current IP address, clear the modem's configuration to factory defaults. This sets the modem's IP address to 192.168.5.1. For more information, see [Return the Modem to Its Factory Default Settings](#) on page 62.

## Troubleshoot the Mobile Broadband Internet Connection

If your modem cannot access the Internet, check the mobile broadband connection:

- Make sure that a micro SIM card is installed in the modem. Micro SIM cards from other devices do not function in the modem and this SIM card does not function in other devices. For information about inserting the SIM cards, see [Install the Micro SIM Card](#) on page 8.
- If SIM security is enabled, make sure that you entered the PIN correctly to unlock the SIM card (see [Enter the SIM PIN to Enable the Modem to Connect to the Internet](#) on page 53. A locked SIM card prevents the modem from connecting to the mobile broadband network.
- Make sure that your mobile broadband account is active.
- Check with your Internet service provider to ensure that coverage exists in the area. If no mobile broadband coverage exists, all Signal Strength bars are off.
- If only one or two Signal Quality LED bars light, move the modem closer to a window for better access to the mobile broadband signal.
- Check to see if your mobile service provider is experiencing network problems. It might not be that the modem cannot connect to the Internet, but rather that your service provider cannot provide an Internet connection.
- You might need to add a custom APN profile (see [Manage APN Profiles for Mobile Broadband Connections](#) on page 34). Contact your mobile broadband service provider.

For more information about Internet connection problems, see [TCP/IP Network Not Responding](#) on page 91.

## Obtain an Internet IP Address From Your Service Provider

If your modem cannot access the Internet but one or more Signal Strength LED bars light green, see if the modem can obtain an Internet IP address from the mobile broadband service provider.

Unless the modem was assigned a static IP address, the modem requests an IP address from the mobile broadband service provider. You can determine whether the request was successful (see [View Account Details and Other Details About Your Modem](#) on page 68).

If the IP address is shown as 0.0.0.0, the modem did not obtain an IP address from the mobile broadband service provider. If this situation occurs, do the following:

- Make sure that an APN profile exists for your mobile broadband service provider (see [Manage APN Profiles for Mobile Broadband Connections](#) on page 34).
- Turn off the modem and then turn it back on.

If you still cannot obtain an Internet IP address, contact your mobile broadband service provider.

## Troubleshoot Internet Browsing

If the modem can obtain an IP address but your computer is unable to load any web pages from the Internet, it might be for one of the following reasons:

- The monthly data limit for your mobile broadband account might be reached.  
For information about checking your usage, see [View Monthly Data and Session Data Usage](#) on page 64.
- Your computer might not recognize any DNS server addresses.  
A DNS server is a host on the Internet that translates Internet names (such as www addresses) to numeric IP addresses. Typically your mobile broadband service provider assigns the addresses of one or two DNS servers for your use. If you entered a DNS address when you set up the modem, reboot your computer and verify the DNS address. Alternatively, you can configure your computer manually with DNS addresses, as explained in your operating system documentation.
- Your computer might not use the modem as its TCP/IP bridge.  
If your computer obtains its information from the modem by DHCP, reboot the computer and verify the modem address.  
For information about TCP/IP problems, see [TCP/IP Network Not Responding](#) on page 91.

## Changes Not Saved on the Modem's Web Pages

If the modem does not save the changes you make in the modem's web pages, do the following:

- When entering configuration settings, always click the **Submit** button before moving to another page or tab, or your changes are lost.
- Click the **Refresh** or **Reload** button in the web browser. It is possible that the changes occurred, but the old settings might be in the web browser's cache.

## TCP/IP Network Not Responding

Most TCP/IP terminal devices and routers include a ping utility for sending an echo request packet to the designated device. The device responds with an echo reply to tell whether a TCP/IP network is responding to requests.

### Test the LAN Path to Your Modem

You can ping the modem from your computer to verify that the LAN path to your modem is set up correctly.

#### ► To ping the modem from a Windows computer:

1. From the Windows taskbar, click the **Start** button and select **Run**.
2. In the field provided, enter **ping** followed by the IP address of the modem, as in this example:  
**ping 192.168.5.1**
3. Click the **OK** button.

A message such as the following one displays:

```
Pinging <IP address> with 32 bytes of data
```

If the path is working, you see this message:

```
Reply from < IP address >: bytes=32 time=NN ms TTL=xxx
```

If the path is not working, you see this message:

```
Request timed out
```

If the path is not functioning correctly, you might be using an incorrect network configuration. Do the following:

- Verify that the Ethernet card driver software and TCP/IP software are both installed and configured on your computer or workstation.
- Verify that the IP address for your modem and your computer are correct and that the addresses are on the same subnet.

### Test the Path From Your Computer to a Remote Device

After you verify that the LAN path works correctly, test the path from your computer to a remote device.

#### ► To test the path from your computer to a remote device:

1. From the Windows toolbar, click the **Start** button and select **Run**.
2. In the field provided, enter **ping -n 10 IP address**.  
*IP address* is the IP address of a remote device such as your mobile broadband service provider's DNS server.

If the path is functioning correctly, replies as described in *Test the LAN Path to Your Modem* on page 91 display. If you do not receive replies, do the following:

## LTE Modem Model LB2120

- Check to see that your computer lists the IP address of your modem as the default router. If the IP configuration of your computer is assigned by DHCP, this information is not visible in your computer's Network Control Panel.
- Check to see that the network address of your computer (the portion of the IP address specified by the netmask) is different from the network address of the remote device.  
Many mobile broadband service providers restrict access by allowing traffic only from the MAC address of your modem, but some additionally restrict access to the MAC address of a single computer connected to the modem. In this case, inform your service provider that you bought a new network device, and ask them to use the modem's MAC address.

# Default Settings and Specifications

---

# A

The appendix contains the following sections:

- *Factory Default Settings* on page 94
- *Technical and Environmental Specifications* on page 95

## Factory Default Settings

You can reset the modem to the factory default settings, which are shown in the following table.

For more information about resetting the modem to its factory default settings, see [Return the Modem to Its Factory Default Settings](#) on page 62.

**Table 10. LB2120 modem factory default settings**

Feature	Default Settings
<b>Login</b>	
User login URL	http://192.168.5.1
Admin user name	The modem does not require an admin user name.
Login password (case-sensitive)	See the modem label
<b>Local area network (LAN)</b>	
LAN IP address	192.168.5.1
Subnet mask	255.255.255.0
Operation mode	Router mode enabled; Bridge mode disabled
IP pass-through (IPPT)	Disabled in Router mode; enabled in Bridge mode
DHCP server	Enabled with the following address range: 192.168.5.20 to 192.168.5.99
DNS mode	Auto
DMZ	Disabled. If enabled, the default DMZ IP address is 192.168.5.4
<b>Mobile broadband and security</b>	
Network mode	All bands
Auto Connect mode	Always except when roaming (The modem automatically attempts to connect to the mobile broadband network when powered on, except when roaming.)
Network Selection mode	Automatic (The modem connects automatically to the type of mobile broadband network that is made available by your mobile broadband service provider.)
Automatic failover mode	Auto (The modem uses the wireline broadband connection by default and fails over to the mobile broadband connection if the wireline broadband connection fails.)
MTU size	1430 (nonconfigurable)
IP pass-through (IPPT)	Disabled in Router mode; enabled in Bridge mode
NAT	Enabled

**Table 10. LB2120 modem factory default settings (Continued)**

Feature	Default Settings
VPN pass-through	Enabled
<b>Messaging</b>	
Incoming SMS messaging	Enabled

## Technical and Environmental Specifications

**Table 11. LB2120 modem specifications**

Feature	Description
Data and routing protocols	TCP/IP, DNS relay, NAT (many-to-one), TFTP client, VPN pass-through, DNS
Power adapter	Model LB2120-100AUS: Input 200–240V, 50/60 Hz Output: 12 VDC @ 1.0A
	Model LB2120-100EUS: Input 200–240V, 50/60 Hz Output: 12 VDC @ 1.0A
	Model LB2120-100NAS: Input 100–120V, 50/60 Hz Output: 12 VDC @ 1.0A
Dimensions (width by depth by height) and weight	Model LB2120-100AUS: 120 by 99 by 31 mm (4.7 by 3.9 by 1.2 in.) 150 g (0.33 lb)
	Model LB2120-100EUS: 120 by 99 by 31 mm (4.7 by 3.9 by 1.2 in.) 150 g (0.33 lb)
	Model LB2120-100NAS: 120 by 99 by 31 mm (4.7 by 3.9 by 1.2 in.) 150 g (0.33 lb)
Gigabit Ethernet port	One 10/100/1000BASE-T, RJ-45 autosensing port
Operating temperature	0° to 40°C (32° to 104°F)

**Table 11. LB2120 modem specifications (Continued)**

Feature	Description
Storage temperature	-25° to 55°C (-13° to 131°F)
Operating humidity	90% maximum relative humidity, noncondensing
Storage humidity	5–95% maximum relative humidity, noncondensing



# Wall-Mount the Modem

---

# B

This appendix describes how to wall-mount the modem.

The appendix contains the following sections:

- *Position Your Modem* on page 98
- *Mount Your Modem* on page 99

## Position Your Modem

Use the Signal Strength LED bars  on the top panel to position the modem for best signal strength in relation to the mobile broadband network. Also for best results, place your modem according to the following guidelines:

- Place your modem close to a window but avoiding direct sunlight. A window location gives the best conditions for receiving a strong 4G LTE signal.
- Make sure that the modem is within reach of an AC power outlet and near Ethernet cables for wired computers.
- Place the modem away from electrical devices such as the following:
  - Ceiling fans
  - Home security systems
  - Microwaves
  - Computers
  - Base of a cordless phone
  - 2.4 GHz cordless phone
  - 5 GHz cordless phone
- Place the modem away from large metal surfaces, large glass surfaces, insulated walls, and items such as the following:
  - Solid metal doors
  - Aluminum studs
  - Fish tanks
  - Mirrors
  - Brick walls or surfaces
  - Concrete walls or surfaces

## Mount Your Modem

### ► To wall-mount the modem:

1. Drill holes in the wall where you want to wall-mount the modem.

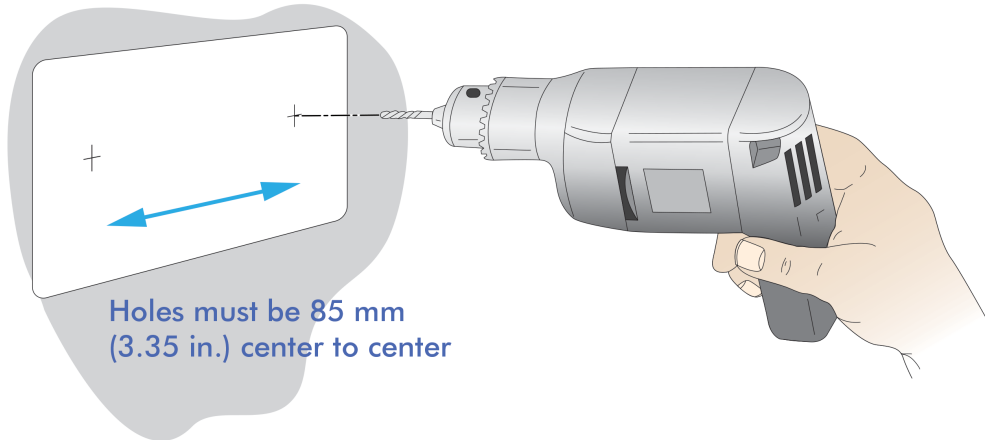

2. Install wall anchors in the holes.

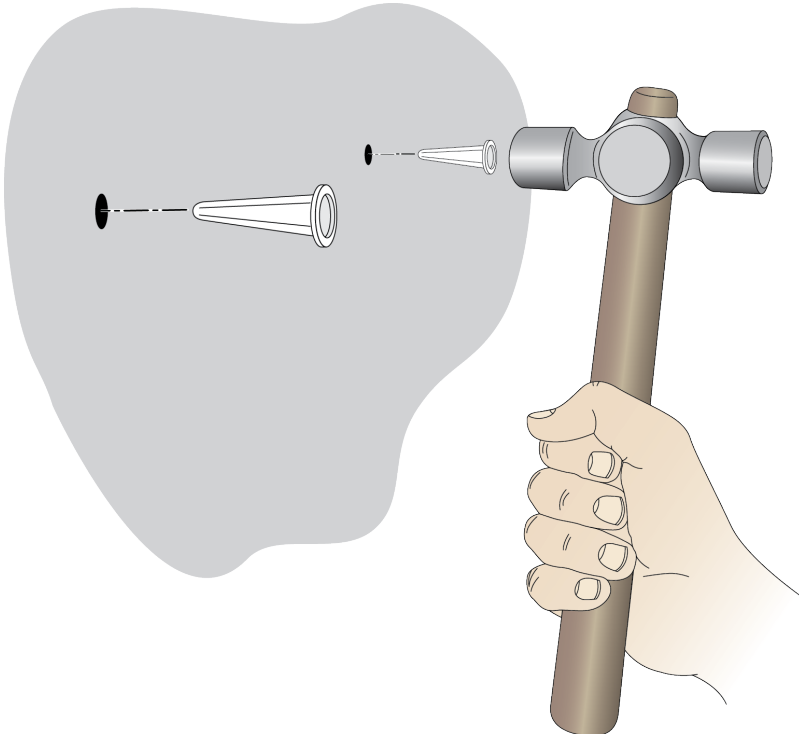

3. Use pan head Phillips wood screws, 3.5 x 20 mm (diameter x length, European) or No. 6 type screws, 1 inch long (U.S.).

## LTE Modem Model LB2120

4. Insert screws into the wall anchors, leaving 1/8 inch (3 mm) of each screw exposed.

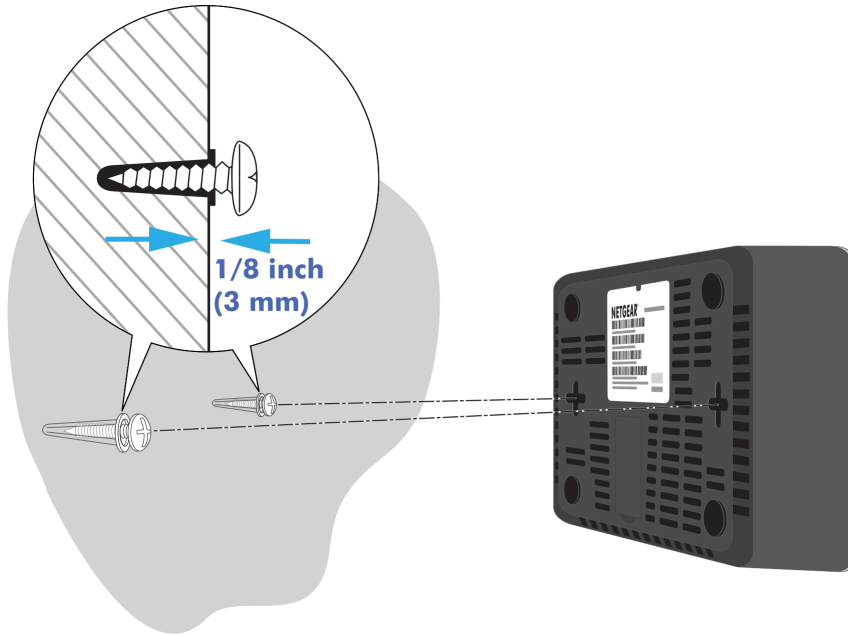

5. Attach the modem to the screws and secure it into place.