

A Computational Investigation
Of the Evolution of Vision

Luc Beaudoin

University of Ottawa

Note added 2011-01-31 by Luc P. Beaudoin Bibliographical reference of this document:
Beaudoin, L. P. (1990). *A Computational Investigation of the Evolution of Vision*. Honour's thesis. School of Psychology, University of Ottawa, Ottawa.

The reader will appreciate that this piece of scholarly juvenilia reflects the unbridled exuberance of youth, which would be tempered today by broader knowledge. I believe it nevertheless raises some pertinent questions about the evolution of vision and the possibility of principled variation in evolution. I wish to express my deep gratitude to (a) Prof. Claude Lamontagne for having kept and then found the last remaining paper copy of this document (which I subsequently lost!); (b) to Todd Muddle (Associate University Librarian at SFU) for coordinating SFU's original digitization of this document; (c) to Todd Muddle and Joanie Wolfe (Assistant for Theses at SFU) for recovering this digitized document; and (d) to Carol Woodworth for help with document recovery. Without their help, this document would have been lost forever. It was runner-up for the best thesis award, which was awarded to an *empirical* thesis. Who in Psychology can compete with data? Except for this note, this document is an authentic, unredacted digitization of my original honour's thesis. End of note.

Running head: Evolution of vision

Acknowledgements

I wish to express my appreciation to C. Lamontagne for many very stimulating discussions about the various levels of this scientific enquiry, and also to J.-F. Houle for pointing out the problem of random variation at the biochemical level.

Table of Contents

Abstract	5
The approach	8
The problem of the evolution of vision	8
The computational syntax and related metaphysical considerations	12
Epistemic entities	12
A vehicle for the semantics of perception: Characterization	16
Grouping criteria and grouping domains	18
Formal vs real anatomy	21
A note on the logical status of the syntax	22
General axioms	23
Vision is the activation of local-global ties	23
The phylogenesis of vision is the addition of local-global ties	24
All the cells on which an EE rests belong to the same EE	26
Cells within an EE have the same EC	27
There cannot be two EEs which rest on the same EE	27
Groupings obey the principle of adjacency	28
Virtues and limits of the principle of adjacency	30
Local axioms	32
A hexagonal geometry	32
Threshold and weight determination	33
Criteria for grouping cells within unidimensional variety	33
Criteria for grouping cells within bidimensional continua	35
Some Ramifications of the assumptions	40
Offspring and issues in a two amplitude 0:EE domain	41
The Δa domain and line segment detection	41
Grouping cells representing different directions: A	

formal or a semantic challenge?	45
Offspring and problems in a multi-amplitude 0:EE domain	49
Towards a solution to the problem of explaining the evolution of early vision	52
Concluding statements	55
References	57
Appendix A	60
Appendix B	65
Figure captions	91
Figures	95
Disk 1	
Disk 2	

Abstract

The computational syntax and terminology proposed by Lamontagne (1987) were used to investigate the problem of the phylogenesis of visual perception. In particular, an attempt was made to specify Lamontagne's principle of adjacency. This principle states that a relevant natural mutation will cause an offshoot to have one or more levels of informational grouping than its parents, where each specific group contains units of information which are adjacent, along one or many continua, to the pivotal unit of that group. A number of assumptions were proposed to constrain the investigation space. Among them was the pairwise-grouping hypothesis, a hypothesis belonging to the set of possible instances of the adjacency principle. This hypothesis states that any formal epistemic entity of level n --that is, n :EE--receives input only from pairs of $(n-1)$:EEs. Given a two amplitude retinal domain, the assumptions were found to predict offspring capable of detecting line segments and some of their orientations. With a multi-amplitude retinal domain, however, the pairwise-grouping hypothesis and the general principle of adjacency were found to have difficulty in accounting for smooth contrast detection. Formal neural network solutions were proposed to overcome that and related difficulties.

A Computational Investigation
Of the Evolution of Vision

Qu'il y a des carrés d'infini, des cubes d'infini, et des infinis d'infinis, dont le pénultième n'est rien par rapport au dernier? Tout cela, qui paraît d'abord l'excès de la déraison, est en effet, l'effort de la finesse et de l'étendue de l'esprit humain, et la méthode de trouver des vérités qui étaient jusqu'alors inconnues. (Voltaire, 1734/1964, p.113.)

Certainly, one of the greatest challenges facing the field of cognitive science is accounting for the phylogenic origins of cognition across *all* forms of life. It is because of a phylogenic process that cognition exists at all, and that it exists in the way it does. Evolution has caused the appearance and permitted the transformation of cognitive processes, known and unknown. It may be the difficulty inherent in an enterprise as vast as that of explaining the evolution of cognition that has made many scientists shun this challenge.

Cognitive psychologists have, not without audacity, directed most of their efforts towards solving the riddle of ontogenetic development; the odd reference to evolution merely speaks in terms of the survival of adaptive traits, thereby emphasizing the role of natural selection rather than natural mutation. Yet modern biological evolutionary theorists now realize that environmental selection is a small part of the evolutionary process. In this so called "neo-neo-darwinian" view (Piattelli-Palmarini, 1989), the question is not so much "how were the fittest organisms selected?", but "what made the organisms (fit or not fit) have the form they

have?" The simple answer to that question, namely *random variation*, is no longer considered in itself sufficient to account for even the building blocks of organisms, amino acids (Creighton, 1984). Hence, there lies a whole world of phenomena, namely cognitive processes, begging to be accounted for in scientific evolutionary terms. And while the theoretical soil is not completely virgin, there is little of man's conjectural toil to rely on.

In this paper, a machete of a computational kind is used to hack a path into the jungle of phylogenic research issues. It may be conjectured that cognition is an evolutionary outgrowth of perception and primal motor systems. Given this hypothesis, and the fact that vision is one of the better understood cognitive systems, the study of the phylogenesis of vision is a rational place to start one's journey towards an understanding of the phylogenic origins of cognition. To avoid the pitfalls of ambiguity that can so easily deter research into cognitive systems, a computational syntax will be used to embody the proposed theoretical statements.

The research reported here consists of a set of theoretical statements about the evolution of vision and a set of their implications. One theoretical statement of particular interest is the principle of adjacency, proposed by Lamontagne (1987),¹ which states that phylogenesis causes the appearance of offspring that group bits of sensory information which are adjacent along informational dimensions. Some statements are proposed to render the principle of adjacency more specific. The set of statements is not suggested as a theory but as a guide to initial investigation. The physiology of some of the predicted offspring is examined in the

¹ For brevity, throughout the paper Lamontagne will mean Lamontagne (1987).

light of empirical and explicitly theoretical knowledge about early vision.

Before explaining the terminology used in the body of the paper, it is of interest to briefly discuss the philosophy of the present approach and speak about evolution in general.

The Approach

This research follows the epistemological framework of falsificationism proposed by Popper (1959, 1983). The aim of science is deemed to be to explain empirical phenomena which are problematic, that is, to propose theories. Although a theory can not be shown to be true, it can be shown to be false (by empirical refutation). The prime virtue of a theory is, therefore, its falsifiability; and this requires that it should be clear. Clarity of theory in most nontrivial worlds requires formalization beyond every day language (Beaudoin, in press). Formalization implies the correct use of syntactical rules and terminology, such as logic, mathematics, calculus, formal neuron theory, etc.

In the light of this epistemology, the starting point of a scientific investigation is the statement of the problem, followed by a reference to the formalisms of interest.

The Problem of the Evolution of Vision

The problem of the evolution of vision is that organisms see, and that there are no falsifiable theories that explain the existence of this fact. One is referred to the comments of Lamontagne & Beausoleil (1982) in relation to the problem of the accounts of

human vision; they apply almost just as well to the problem of the evolution of vision. Marr (1982) discussed the fact that in the early 1970's researchers believed that they understood vision. It was when artificial intelligence researchers started trying to simulate vision that people began to realize that they, in fact, understood very little about vision. Again the case is similar in evolution research. That is, the field is lacking an explicit theory that can be brought to the level of simulation.

Much research is performed on the evolution of simple organisms and plants. Evolution theory for the more complex processes of higher organisms has taken the form of post hoc explanations in terms of natural selection. (But see Pollard, 1987, for some recent and more sophisticated theories regarding evolution.) Yet there are two major problems with the concept of natural selection. The first is that it is not scientific, for it does not yield any specific predictions.² Whatever organisms survive in a particular environment, it will always be possible to claim that they did so because they were the fittest.

The second problem is that, even if one admits the rather obvious fact that the environment will have an effect on which organisms survive, natural selection does not explain the real question of evolution, which was asked by Saunders & Ho (1987), namely: Why do organisms appear with the characteristics that they have and don't have? Neo-neo-Darwinists (most notably, Gould & Vrba, 1982;

² Popper (1974, p. 135-139), was the first one to propose this criticism, and it created a wave of epistemological questioning in biology (see, e.g., Saunders & Ho, 1982). He somewhat tempered his argument in subsequent publications (Popper, 1987), but his reasons for doing so are not without strong criticism (see, for example, Curtis, 1989.)

Vrba & Gould, 1986) have realized that the role of natural selection is not to guide evolution in a positive sense but to eliminate the nonviable organisms. In this view, a trait does not appear because it is adaptive, and it need not be adaptive to appear and remain. The color of one's eyes is a typical example. It is deemed absurd to seek to justify this trait in terms of adaptive value. (But, again, one could invoke the argument that any trait exists because it is adaptive.) In Gould & Vrba's view, the only condition for the survival of a trait is that it is not fatal to the organism. Saunders & Ho (1987) minimize the relevance of natural selection:

[...N]atural selection cannot act on a variant which does not exist. Whether or not a particular feature appears in evolution largely depends not on its relative fitness once it appears, but on the probability that it ever occurs at all. (121)

Theoretical statements, therefore, need to be proposed to account for the probability factors.

Wächtershäuser (1987) published a theory of the evolution of vision. He argued that the evolution of vision involves an evolution of biochemical features, which perform new functions when they are combined. He also claimed that vision evolves interactively with the evolution of motricity. More precisely, he claimed that vision originated from simple organisms with light sensitive pigments and a developing approach-avoidance response to light. He noted that photoreceptors are found in most metazoan animal groups, from the most simple (e.g. the hydrozoa) to the most complex, and that they are all functionally dependent upon one visual pigment (rhodopsin).

He also argued for a link between algal and animal vision. These arguments provide a theoretical foundation for the claim that vision is an outgrowth of the retinal plane.

Wächtershäuser (1987)'s paper is one of the first falsifiable theories of the evolution of vision; its refutable aspects, however, lie only in the realm of photoreception, and not in the realm of organization of information at levels posterior to the receptive plane. As it happens, vision in many metazoan animal groups is vastly more than photoreception. Unfortunately, to this author's knowledge, there is no falsifiable theory of the evolution of postretinal visual processing (But see Goodson, 1973, for Darwinian formulations.)

In this paper, the evolution of vision is seen as an information processing challenge. Given this approach, it is of interest to consider the work of Fogel, Owens, and Walsh (1966) who studied the evolution of intelligence from an artificial intelligence perspective. They presented algorithms for deriving hypothetical organisms (programs) which could perform predictions based on a set of input data. The simulation generated a number of offspring, which could be mutated to yield more offspring. The offspring were scored in terms of their predictive accuracy on relevant tasks. Fogel et al. decided to retain and cause a mutation of the organism which had the best predictive power.

Fogel et al.'s approach had a number of virtues. The main one which distinguishes it from other evolutionary theories of high order processes is the theoretical clarity inherent in a mathematical representation of an offspring. One important technological problem, however, constrained the research they could produce: Given the limited amounts of random access and read only

memory to which they had access, their computers could not work with very complicated or numerous organisms. When one simulates evolution one needs such tools, for exponential functions characterize both the increase in number of organisms and the increase in their complexity. And given the neo-neo-Darwinist notions, it is not reasonable to only retain those organisms which perform optimally (hence one must be able to store a large number of offspring). Since sufficiently powerful computing technology is now available, the time seems ripe to develop strong and clear theories which can be brought to the level of computer simulation.

But first one must have a sufficient vocabulary and syntax. In the next section the syntax proposed by Lamontagne is described and expanded upon. Since this research so heavily rests on the seminal paper's syntax, just as mechanical engineering rests on differential calculus, and that Lamontagne's paper cannot be reproduced here, a perusal over that paper is recommended.

The Computational Syntax and Related Metaphysical Considerations

In this section some of the syntax of the present research, which was proposed in Lamontagne's seminal work, is briefly explained. Furthermore, clarifications on foundational issues which weren't explicitly dealt with in the seminal paper, but which arise when one tries to apply the syntax, and some new terminology are also put forth.

Epistemic Entities

Lamontagne remarked that perception involves relations between

very local events (e.g., light intensities on a retinal plane) and more global events (e.g., a visual representation taking the form of an edge or a scene). The computational syntax provides a way of speaking about such relations. Sensory events, actual as well as *potential*, are referred to as neurophysiological units, or informational units. Lamontagne used the term *epistemic entity* (EE) to refer to a neurophysiological unit; in this paper, however, the term EE will be used to denote a multidimensional array the cells of which are informational units.

Insert Figure 1 about here

Each informational unit occupies a nonambiguous position along a determined number of continua, within an EE. The most basic case of an EE is that of the informational units and their continua at the level of interface between the environmental energetic medium to which the knowledge system reacts and the knowledge system itself. At the level of interface of the *visual* system, where the environmental energetic medium is assumed to be photonic, it is assumed that units occupy a location along three continua. These continua are: Positions, Moments, and Amounts. Positions is a two dimensional continuum representing space, whereas Amounts and Moments are unidimensional continua representing, respectively, the amplitude and the time of the stimulation. To simplify the research domain a monochromatic world is assumed and reactance to the frequency of the light wave is not taken into consideration. It should be noted that the term continuum is used although the system does not, of course, encode events along a scale with an infinity of units. (As a matter of fact, some two valued continua will be postulated.)

One can represent informational units and the EE to which they belong in various fashions. In this paper formal neural networks will be used. A formal neuron in an array of such neurons will represent an informational unit. Figure 1 shows how the values of cells within the interface EE are obtained. A mapping function translates the amplitudes of each cell of a retina at moment zero into the EE below. The retinal cell values and their representation in the EE are equivalent, it is merely the form (and not the matter) of the representation that differs. The units of an EE are either active or nonactive. In other words, an event either occurs or does not occur. (The state of activation of a unit can therefore be indicated by a boolean.) According to the mapping function, a cell, x , within an EE will carry the value true if and only if the corresponding retinal cell, at the moment which x occupies, has the same amplitude which x occupies. For instance, the top left cell of the array (within the epistemic entity) corresponding to amount two and moment zero carries the value true because the receptor cell at the same position actually has the amount two. The other EE cells representing the same position (i.e. top left) and same moment have a value false.

The representation of every EE will take the general form of the EE of Figure 1; that is, units will carry boolean values and occupy nonambiguous positions along discretely represented continua.

It was said above that perception involved relations between local and global events. The syntax provides a way of denoting these relations. This is accomplished by speaking of the *level* which a unit occupies. Suppose a unit is said to occupy a level n . For example, the units in the EE of Figure 1 occupied $n:EE$, where n equaled zero; that is, they occupied $0:EE$. A unit, x , which is immediately more global in relation to another unit, y , of level n ,

$n:y$, is said to occupy the level *above* n , i.e., $(n+1):x$. Therefore, local-global relations can partially be described by referring to the level which the respective units occupy. The syntax does not require (but it does permit) that an integer can denote the level of a unit in an absolute fashion. That is, the syntax does not constrain one to designate a unit's level; but it does require that one can speak of the relation between some units, such that one unit may be said to be at an inferior or superior level to some other units.

A neural network example may help to understand the terminology. Suppose that two cells, x and y , belonging to $n:EE$, project their terminal fields, which carry a weight of plus one (+1), into cell z , which has a threshold of two. The cell z may be said to be immediately more global in relation to cells x and y , such that z is at level n plus one, i.e., $(n+1):z$. Note that the cell z represents a grouping of the information of cells x and y . Note also that it is not necessary to specify the value of n in order to see that there is a local-global relation between x and y , and z .

As an additional syntactical consideration, it should be noted that, for this paper, in order for two cells, x and y , to be considered as occupying the same EE , x and y , of $n:EE$, must have their conditions of activation specified in terms of cells at $(n-1):EE$.

Speaking of informational relations in terms of local-global ties is computationally useful but is not sufficient in itself to denote the semantics of these ties. Lamontagne provides a powerful way of speaking about the semantics of these ties.

A Vehicle for the Semantics of Perception: Characterization

Lamontagne's syntax includes a way of formulating statements about the grouping of information from one EE to another. Within a phylogenic perspective, one is interested in the decisions which lead to the formation of a grouping from one level to another. A *grouping criterion* refers to the rule for mapping some (local) cells into more global cells. A grouping criterion determines the essential characterization (EC) of the more global cells. So, for example, if the grouping criterion dictates that cells which are adjacent along the positions continuum but occupy the same amount and same moment should be grouped into a global cell, then the EC of that grouping is *adjacent positions, same moments, same amplitude*.

Lamontagne found that, special cases aside, every grouping contains, or leads to, two kinds of informational variety, which he referred to as differential characterization (DC) of the grouping. The first kind of DC is novel informational variety, and is referred to as a primary differential characterization (PDC). PDC thus denotes the appearance of a continuum which wasn't present in the previous level of information, but which has emerged from the grouping, as a consequence of the EC. The second kind of DC is informational variety which merely is passed (nontransformed) from the prior EE to the new EE; it is referred to as secondary differential characterization (SDC).

An example from the visual modality may help to make this terminology more meaningful. In Figure 2 0:EE has two amounts, 37 positions (distributed along two dimensions), and two moments (see

Figure 2). This system is arranged such that all cells of 0:EE with the same moment and same amplitude and which occupy different positions on the same horizontal plane (x positional axis) are grouped into a cell which has a threshold equal to the number of input cells. Note that, in this paper, and in contrast to connexionist models, the weights of the neurons are always fixed at plus one (+1).

Insert Figure 2 about here

The semantics of the nervous system depicted in Figure 2 can be described precisely in Lamontagne's terminology. The 0:EE represents the interface with the energetic mediums, and it holds Positions, Moments, and Amounts. Note that the system has only two amounts and two moments. The EC of an 0:EE cell of position x,y, and moment z, in the portions of the array with amount equal to one is that light of a certain amplitude has been received at certain position x,y and moment z on the receptor plane. The EC of any 0:EE cell in the portion of the array of the other amount is the logical negation of its counterpart in the portion of the array with amount equal to one, that is, that light superior to a certain amplitude has not been received at position x,y and moment z. A 1:EE cell has a value true if and only if the input cells, which occupy a different position (in a horizontal axis) and the same amplitude and same moment, are activated; this criterion is the EC of 1:EE. In essence, then, for the value of a 1:EE cell of amount k, and moment z, to be true there must be a horizontal line segment of activated cells at 0:EE at moment m at the corresponding position.

Whereas one cannot speak of length at the 0:EE of the above hypothetical organism, for at the 0:EE the system merely has access

to information in the form of discrete occurrences or nonoccurrences of light at unique positions, one *could* speak of length given the conjunction of different positions, same amounts, same moments if one permitted the detection of lines of different length. In the terminology used here, it would be said that length is a *PDC* of the EC linearity. Now, if one chooses not to group on different moments, as in Figure 2, the moment is merely passed on from 0:EE to 1:EE; therefore, given our definition above, moment is a *SDC* of the grouping specified by the EC, just as amount is.

Grouping Criteria and Grouping Domains

It is important to note that the choice of a grouping criterion is arbitrary. In fact, the syntax does not indicate which groupings should be performed, it merely indicates how one could *express* the semantics of these groupings. *What* the semantics are is a matter of scientific theorizing. Now, if a grouping contains units which belong to the same EE, and these units may belong to *different* or *identical* continua, there will be two to the n (i.e., 2^n) possible groupings per EE, where n equals the number of units in the EE.³ It is considered that each grouping reflects a unique grouping criterion.

When one performs a grouping, one must specify the domain from which the grouping was taken. That is, one must specify on which continua (if any) diversity was reduced, and on which continua (if any) diversity was merely passed, in the passage from $(n-1)$:EE to n :EE. This decision will be referred to as a *grouping domain*. A

³ The cardinality of the set of possible groupings is 2^n since the set of possible groupings is the power set of the set containing the units at EE. (See Armstrong, Pelletier, Reckhow, & Rudnicki (1986) for this fact, the syntax of set theory.)

grouping domain can be expressed formally for all cases, as

$$D(n:EE) = \{ \partial_1 c_1, \partial_2 c_2, \dots, \partial_n c_n \} \quad (1)$$

where D is a grouping domain, where c_1, c_2, \dots, c_n are the continua belonging to the set of continua of the given EE , and where $\partial_1, \partial_2, \dots, \partial_n$ are operators which belong to the set of operators, O , where

$$O = \{ \Delta, \Omega \}. \quad (2)$$

The operators from the set O indicate whether a grouping reduces variety on a certain continuum (this will be the case for the Δ operator), or passes the variety from this continuum (this will be the referent of Ω). One will recall that the continuum on which the diversity is passed is the SDC of the given grouping. As an example, the grouping domain from Figure 2 may be expressed as $\Delta p \Omega m \Omega a$; that is, different positions, identical moments, and identical amounts. Now, since the operators are binary, one could without loss of formal clarity express a grouping domain merely in terms of one operator, and infer from the absence of a continuum in an expression that the other operator was applied to that continuum.⁴ The elimination of Ω can be obtained by the following transformation:

$$D' = D \setminus \{ (\partial_n c_n) \mid \partial_n = \Omega \} \quad (3)$$

⁴ This derivation is performed in order to introduce the notion of the power set of grouping domains. Elsewhere in this paper both operators (Δ , and Ω) will usually be used to describe grouping domains.

D' is equal to the grouping domain minus the elements which use the operator Ω . When this syntactic transformation is applied to the example of $\Delta p \Omega m \Omega a$, one obtains, of course, Δp . Both of these expressions are semantically equivalent.

It is of interest to consider the set of all domains of grouping for a given EE. This set is actually the power set of the set of continua of $n:EE$, such that the Δ operator is applied to every element. Since the cardinality of a power set of a set is equal to 2 to the n (i.e., 2^n), where n equals the cardinality of the latter set, the cardinality of the power set of the set of continua is 2 to the n' (i.e., $2^{n'}$), where n' equals the cardinality of the set of continua. One may therefore write the set of all possible grouping domains at $n:EE$ as U , where

$$U(n:EE) = \{D_1, D_2, \dots, D_k\} \quad (4)$$

where $k = 2^{n'}$.

Since there are three continua at $0:EE$, the cardinality of the set of grouping domains at $1:EE$ is eight. We can set them out as

$$U(0:EE) = \{\{\Delta p\}, \{\Delta m\}, \{\Delta a\}, \{\Delta p \Delta a\}, \{\Delta p \Delta m\}, \{\Delta a \Delta m\}, \{\Delta p \Delta a \Delta m\}, \{\},\}. \quad (5)$$

Every power set contains an empty set. The empty set here corresponds to the case where the operator Δ is applied to no continuum. By reintroducing the Ω operator, the grouping domain corresponding to the empty set can be expressed as $\Omega p \Omega m \Omega a$.

Given multivalued continua, a domain will contain many possible grouping criteria.⁵ It will be forcefully argued below that one of the main tasks of the scientist interested in the phylogenesis of vision is to propose constraints within the grouping domains. For it is too general, for example, to merely indicate that a grouping of the form $\Delta p \Omega m \Omega a$ has occurred. There are many ways in which this grouping can be instantiated. A grouping criterion specifies precisely which of the members of a domain of grouping criteria is chosen. It will be shown below that since there are many values in p , in m , and in a , it is not at all evident that purely random determination of grouping criteria can account for the emergence of high level vision.

Formal vs Real Anatomy

The issue of correspondence between the formal neural representations and living biological systems needs to be addressed. The nervous system of a living or dead organism will be called a biological system. An explicitly theoretical representation of biological nervous system will be called a formal nervous system. Now both kinds of nervous systems have an anatomy *and* a physiology. In this paper, the anatomy of the formal nervous system is not meant to be equivalent to the anatomy of the biological nervous system. Rather, the anatomy and the physiology of the

⁵ The exception to this rule is the bijective function which maps $n:EE$ into $n+1:EE$, such that no diversity is introduced or reduced (i.e., Ω is the only operator used.) Even in a multivalued EE, there is only one possible criterion within this grouping domain.

formal nervous system are both meant to represent the *physiology* of the biological nervous systems. A full blown theory of perceptual evolution will need to include rules of derivation of statements about the anatomy of biological nervous systems.

While a solution to the problem of translation between formal anatomy and biological anatomy will not be proposed here, an important notion can be discussed. When one decides to discreetly represent the information at every EE, one increases the formal clarity of one's theory, while decreasing its anatomical plausibility. Such a decision will increase the difficulty of working backwards from the formal anatomy to the biological anatomy. In this paper, exactly that decision was taken. So, while it takes just one receptor of a biological system to respond to stimulation of various amounts at one position and many moments, it takes as many cells as there are moments times amounts in this paper to represent the same information. Anatomical plausibility was traded-off for formal clarity.

A Note on the Logical Status of the Syntax.

The computational syntax merely requires that one speak in terms of epistemic entities, and that one may explain the different kinds of characterizations which proceed from the grouping (or degrouping) of information. The syntax says nothing about what the content of the representations should be. That is, although the syntax requires that one may speak of EC, PDC, etc., it does not say what these characterizations should be. The syntax is a statement about the *form* theories must take; it is not a statement about the theories' semantics. In this sense, the syntax does not belong to the

set of refutable sets of propositions. Therefore, given the criterion of demarcation between science and metaphysics (see Popper, 1959), the syntax and terminology belong to metaphysics, just as logic and mathematics do. The theories which use the syntax, however, may be falsifiable, at least in as much as actual organisms, with characteristics that violate the predictions of the theory, can be observed.

Having described a way of speaking about perception and its phylogenesis, it is now appropriate to begin a discussion of the evolution of visual systems. This discussion will begin with a description of some assumptions.

General Axioms

The purpose of this section is to make as explicit as possible the global assumptions that guided this theoretical enterprise. The first and last general assumption presented here were presented in Lamontagne's paper with reference to perception in general. In this section their hypothetical nature and relevance to vision are emphasized. It is within the context of these global assumptions that the viability of some more precise theoretical statements will be critically examined below. Following are the global assumptions and some comments about them.

(A1). *Vision is the activation of local-global ties.*

The general proposition (noted above) that *perception* involves grouping of information is applied specifically to the visual modality. That is, the information processing challenge of vision is

considered to be the formation of fruitful local-global ties. Of course, the local-global ties can be characterized essentially, and lead to PDC and SDC. This process is assumed to occur recursively: the tie of $n:EE$ serves as a local instance in a tie with a more global instance at $(n+1):EE$. This hypothesis does not omit the possibility that an EE builds on a number of EEs below; the next hypothesis, though, does.

(A2). *The phylogenesis of vision is the addition of local-global ties.*

It is assumed that, in the *phylogenesis* of vision, the formation of ties started from the most local instances and built to higher (and, given the first axiom, more global) instances.

Although certainly of conjectural nature, the first and second hypotheses are not very bold. They basically amount to the postulation that vision involves grouping disparate information from the retinal plane, and that visual phylogenesis causes the appearance of organisms which may have more of these groups of information. The very anatomy of the nervous systems suggests this grouping of information, by the fact that neural cells are massively interconnected. The meaning of these groupings, however, are restricted by the following hypotheses.

Given that perception is the activation of local-global ties, the challenge of proposing a theory of phylogenesis of vision is quite clear: What are the principles which govern, in an evolutionary process, the formation of local-global ties? Now, the null hypothesis on this point amounts to the postulation that no principle is needed, i.e., that local-global ties are produced at random. Although a nondeterministic hypothesis cannot be empirically

refuted, (see Popper, 1959, pp. 246-250), it can at least be shown to be very unlikely. An approximation of the odds which the biological systems would have to face in order to come up with the kinds of perceptual nervous systems observed⁶ can be specified in terms of the computational syntax. If one admits an 0:EE with 8 x 8 positions, 2 amounts, and 3 moments (which are quite minimal constraints on all counts), then one can obtain the pool of possible grouping criteria as

$$P = 2^8 \times 8 \times 2 \times 3 = 2384 \quad (6)$$

Now, obtaining modular combinations out of such a pool could occur at random; but it implies a certain burden both on time and on space. That is, it would take a certain amount of time/space to try out the possibilities and come up with a modular arrangement. Nonetheless, such odds can be beat. But then the problem becomes one of accounting for *repeated* modular arrangements (i.e at EEs superior to 1:EE). It is difficult to account for the fact that modular arrangement is seen not only from receptors to ganglion cells but at many epistemic levels.

Biologists have long since come to terms with the idea that random variation is not a sufficiently powerful construct to account for the organization observed in living beings. For example, Creighton (1984, p. 161) discussed a similar problem in relation to the appearance of polypeptides. Polypeptides are formed of amino acids. There is a small class of functional polypeptides. Take the

⁶ The primary characteristics of concern to account for here is the fact that visual nervous systems are modular. That is, local operations seem to be performed in the earlier stages of vision.

case of a small polypeptide consisting of 100 amino acids. One can ask oneself: What is the probability that the particular observed arrangement of amino acids in this polypeptide would occur if a random process governed its appearance? The answer is $1/10^{100}$. Creighton notes that 10^{100} is 10^{31} times greater than one of the estimates of the number of atoms in the universe (10^{79}).

Determinisms are therefore postulated to explain the formation of polypeptides. Similar odds must be beat for the formation of peptides which have properties such that they bind with a receptor that has newly appeared given a mutation (Schwyzer, 1987). The following are some determinisms of physiological variation.

(A3). All the cells on which an EE rests belong to the same EE.

It is assumed that the condition of activation of an n :EE cell is specified solely in terms of units from one $(n-1)$:EE. That is, it could not be the case that one EE, x :EE rests on two EEs, y :EE and z :EE, where y is not equal to z .

Two of the things which the second and third assumptions do not imply should be made clear. First, these assumptions do not rule out the possibility that the very first organisms equipped with the primitives for vision may have had more than one EE. Second, they do not imply that phylogenetic development is a slow and gradual process. Indeed, mutations very often produce quite abrupt changes, and do not merely impact on a small number of cells (Mourant, 1971 in Piattelli-Palmarini, 1989, p. 6). In the present scheme, it could be the case that one mutation causes an offshoot to have many more EEs than its parents. The only restriction is that every EE rest solely on one EE. An additional assumption would need to be added in

order to specify the function determining the rate of epistemic growth.

(A4). *Cells within an EE have the same EC.*

It was said above that in order for two cells, x and y , to be considered as occupying the same EE, x and y of n :EE must have their conditions of activation specified in terms of cells at $(n-1)$:EE. To this assumption it is added that cells within an EE have the same EC. That is, x and y must have the same relation to cells of $(n-1)$:EE. For example, if the conditions of activation of x is specified in terms of $(n-1)$:EE cells which occupy adjacent positions, then the conditions of activation of y must be specified in terms of $(n-1)$:EE cells which occupy adjacent positions; but the exact cells in relation to which the conditions of activation of x and y are specified need not be the same.

(A5). *There cannot be two EEs which rest on the same EE.*

The fifth assumption states that there cannot be two EEs which rest on the same EE. That is, any EE may only serve as a local instance to one EE. The fifth assumption implies that no two EEs can exist in parallel. Therefore, there should be just one linear sequence of EEs. In this view, an integer may denote the standing of any EE in relation to 0:EE. That is, an integer may denote in an *absolute* sense the level of an EE. One will recall that the syntax did not require this assumption, but that it permitted it.

The third, fourth and fifth axioms may seem unduly constraining.

They were introduced to bound the investigation. A more lengthy investigation may omit some of these constraints on the formation of local-global ties. These axioms, however, would significantly contribute to the falsifiability of a theory resting upon them.

(A6). *Groupings follow the principle of adjacency.*

The most important determinism investigated here is Lamontagne's principle of adjacency. This principle states that a relevant natural mutation will cause an offshoot to have one or more levels of informational grouping than its parents, where each specific group contains units of information which are adjacent, along one or many continua (depending on the domain of grouping), to the pivotal⁷ unit of that group. That is, if one groups on a variety of a certain continuum, the units of this continuum must not be separated from the pivotal unit by one or more units: the units must be adjacent to the pivotal unit.

The principle of adjacency is a class of criteria of grouping. It specifies the kinds of groupings which are permissible, given a certain domain of grouping. It does not specify which elements of the set of *domains* of grouping will be chosen. In fact, there is no meaningful way to speak of a grouping domain, say Δ_p , as being adjacent to another domain of grouping, say Δ_m . At least at low EEs, the cardinality of the *set of grouping domains* is not impressive. For example this cardinality was eight at 1:EE. In comparison, the cardinality of a domain of grouping, such as $\Delta_p\Delta_m\Delta_a$, was

⁷ A pivotal cell is the n:EE cell according to which a relation (e.g., an adjacency relation) is determined. The pivotal cell participates with other cells of n:EE as determinants of the state (true vs false) of an n:EE cell.

astronomical. Hence, it is assumed that the selection of domains of grouping may be randomly determined. If the principle of adjacency were a specific criterion of grouping, rather than a class of grouping criteria, it would state precisely the groupings that would be seen, given a type of domain of grouping; and the randomness of variation would be usurped by the random selection of a member of the set of domains of grouping.

 Insert Figure 3 about here

The principle of adjacency greatly reduces the pool of offspring one could observe. For example, it rules out the example given in Figure 2. In that figure, the conditions of activation of a 1:EE cell were not specified in relation to a pivotal cell which was adjacent to every other input cell. One may get the (false) impression that the adjacency principle implies that there will never be an n:EE cell receiving inputs from more than two (n-1):EE cells. Figure 3 contains a three level offspring (with two amounts and eight by eight positions) which violates the pairwise grouping interpretation of the principle of adjacency, and yet doesn't violate the general meaning of the principle of adjacency (see Figure 3). In this figure, for any 1:EE cell to be on, the six neighbors (of the same amount) of the pivotal cell (i.e., the 0:EE cell at the same position and same amount as the 1:EE cell of interest⁸) must be on, *and* the pivotal cell must also be on. This 1:EE therefore exemplifies a $\Delta p\Omega a$ grouping criterion. In this case, every pivotal cell is bound to its six neighbors. Figure 3 will also serve as an illustration of a computer

⁸ It is also marked by a peculiar grey pattern.

simulation to be considered below.

Virtues and Limits of the Principle of Adjacency.

Though one cannot justify any scientific hypothesis (Popper 1959), there are some implications which make the principle of adjacency appealing. Lamontagne discussed some of them in his seminal paper. To them one could add the fact that the principle avoids the possibility of having organisms with a "grandmother-cell" at a premature EE. That is, the probability of unduly restricting potential variability (and thus discrimination power) is restricted by the fact that one cannot unite cells which do not have a neighbor in common. It could not occur, therefore, that at 2:EE half of the 1:EE positions are usurped into one grouping (unless, of course, there is a trivial number of positions at 1:EE). This virtue seems necessary for any theory of visual phylogenesis.

There are two problems, however, with the principle of adjacency as it is presently formulated. The first and foremost is that it is not sufficiently formally elaborate so as to be brought to the level of computer simulation. More work needs to be done at the level that Marr (1982) referred to as "computational theory," that is, the expression of the goal of the computation and the strategy by which it can be performed. The second problem is that within any continuum with a nontrivial number of values there are many different ways in which grouping could occur, such that the groupings do not violate the principle of adjacency.⁹ For example,

⁹ This is a problem unless one invokes the clause of a random selection of a grouping criterion from the set of grouping criteria permitted by the principle of adjacency.

given the Δp domain, a grouping criterion may state that every grouping on p involves the grouping of a pivotal unit and its two neighbors along one directional axis (hence in both orientations, for a direction has two orientations). The latter criterion is different from the grouping criterion which states that every grouping on p must contain the pivotal unit's neighbors in every direction (such as in Figure 3). Yet, both of these criteria are compatible with the principle of adjacency. Hence, the principle of adjacency is a *class* of potential phylogenetic hypotheses.

One may therefore wish to select some criterion within the class of criteria permitted by the principle of adjacency. In the next section some of the alternative instances of the principle of adjacency are investigated. Admittedly, one may argue that there is no need to specify a deterministic sub-criterion of the principle of adjacency. Such a person would argue that it is good enough to let the groupings take place randomly, so long as they fall in the set of criteria which are compatible with the adjacency principle. This option seems valid. It is more difficult, however, to develop an algorithm along these lines, because of the fact that the less narrow are one's computational constraints, the more alternative cases one will have to consider. Also, it may be argued that a more specific conjecture is more scientific because it will be more readily falsifiable.

Let us now try to find more explanations so that, eventually, either these axioms may serve as pillars to a proper theory, or they will be shown to crumble before data which they cannot explain.

Local Axioms

In the last section it was shown that the principle of adjacency could be considered as a class of phylogenetic grouping hypotheses; in the present section some more specific formulations of the principle will be considered. The essential challenge of specifying the principle of adjacency is stating exactly how the groupings will be performed. In the trek towards theoretical unity, one encounters the difficulty that the kinds of grouping procedures which one could postulate varies as a function of the grouping domain. As a step towards unifying this diversity, it was decided to treat grouping domains in terms of the number of dimensions included in the continua to which Δ was applied. Grouping on unidimensional continua, will be considered first, and bidimensional continua will be considered second. At the end of this section, decisions will have been made as to which criteria, within the class of the principle of adjacency, will be selected for further investigation. But first, an explicit reference to the geometry needs to be made.

(L A1). *A hexagonal geometry*

The question of the shape of the formal neurons is important because of the principle of adjacency, whereby spatial relations are critical. Using an orthogonal geometry will give a different picture of adjacent relations than a hexagonal geometry (Beausoleil, 1986). As Lamontagne argued, using hexagonal cells is most realistic, given the observed receptor geometry in mammals. It should be noted, however, that, at the 0:EE, the hexagonal geometry does not

influence the representation of m or a , since these are unidimensional continua. That is, cells, at 0:EE, are hexagonal only with respect to the Positions continuum. Continuing to use a hexagonal geometry beyond 0:EE will preserve the relations of 0:EE. These decisions will be manifest in the diagrams below.

(L A2). *Threshold and weight determination*

As was suggested above, the threshold of any given cell representing a grouping is equal to the number of cells participating in the grouping. For an n :EE cell to be on the sum of its inputs must be equal to its threshold. Furthermore, the cells will have a positive weight of one (i.e., +1).

(L A3). *Criteria for grouping cells within unidimensional variety.*

Given the principle of adjacency, there are only two ways one could group within unidimensional variety. One will remember that at 0:EE, m and a are unidimensional continua. On a unidimensional continuum, any unit has only two neighbors, one on either side. The first way to group, called *tripletwise grouping*, is to take each n :EE cell (the pivotal cell) with its two n :EE neighbors and join them into an $(n+1)$:EE cell. An example of such a criterion is seen in Figure 4 (see Figure 4). This figure shows tripletwise grouping of the form $\Delta_j \Omega_k$, where j and k are unidimensional continua.

 Insert Figure 4 about here

The second way, called *pairwise* grouping, consists of uniting a pivotal cell with one of its neighbors at a time. Figure 5 displays such a grouping criterion (see Figure 5).

Insert Figure 5 about here

Also worth noting in both Figure 4 and Figure 5 is a simple shrinkage effect: Since j is a finite continuum, there are less units in the $n:EE$ continuum than in the $(n+1):EE$ continuum. Such an effect will often be offset by a PDC which increases the number of units at $(n+1):EE$, by adding new continua.

The two grouping criteria, pairwise vs tripletwise, can be distinguished in terms of the proportion of cells around the pivotal cell which participate in an $(n+1):EE$ grouping. Pairwise grouping is a *partial* grouping criterion, because some but not all of the pivotal cell's neighbors participate in the grouping. Tripletwise grouping is an *exhaustive* grouping criterion, since all of the pivotal cell's neighbors which could be called to play in the grouping actually participate in the grouping. In bidimensional continua the same distinctions will be applicable to candidate criteria; in addition, some intermediary criteria will be possible.

The pairwise grouping criterion will be favored for experimental purposes in this research, because the case of an $0:EE$ domain with just two amounts will be investigated, and in this case tripletwise grouping will be impossible. Note that along a two valued

unidimensional continuum, pairwise grouping is exhaustive.

(L A4). *Criteria for grouping cells within bidimensional continua*

Position is the first bidimensional continuum to which the system has access. This kind of continuum permits a great number of different criteria; it will therefore be more difficult to come up with a suitable hypothesis. Let us first consider an *exhaustive* criterion, such as the one in the 1:EE of Figure 3 mentioned above. This criterion, in the $\Delta p \Omega a \Omega m$ domain, is that every cell is joined in with every one of its neighbors. Such a criterion has an advantage over a partial criterion to be described below; the advantage is that the position of the (n+1):EE cell is determined with great ease: it merely needs to occupy the same position (at a higher EE, of course) as its n:EE pivotal cell. Furthermore, with such a criterion there is no shrinkage effect (an effect which will be shown to cause some difficulties.)

The exhaustive grouping criterion for a domain with a two dimensional continuum has the disadvantage of being too stringent. The problem is that as soon as a $\Delta p \Delta a$ grouping will be performed most of the information of the preceding EE will be lost. For, quite simply, it will rarely be the case that a cell will have the value true while the pivotal cell's positional neighbors of a different amount also carry the value true. Since the typical pattern of light is made of edges (Marr & Hildreth, 1980), and not of dots, the cells will quite rarely have their thresholds met.

The principle which the exhaustive grouping criterion violates in this case is that a criterion should not be so stringent as to

eliminate all of the potential variety early on. To state the problem differently, if all the cells of a given EE have the value false, then the flow of information is halted. It is quite reasonable to have few cells "on" when one is dealing with a high EE, because (1) there is a great number of cells at such an EE (the number of cells per EE tends to rise exponentially as a function of the EE), and (2) every cell carries a lot of information about the earlier EEs. But at a low EE it would be useful for some cells to carry information about features of the input, and they can only do so if they are on, given the axioms about activation and thresholds.

A computer simulation was carried out in order to better gauge the kinds of patterns of activation which the cells of offspring resulting from an exhaustive criterion would have when two bidimensional continuum domains were considered. The program supporting the simulation is included on Disk 1, the details of its description are included in Appendix A and its code is included in Appendix B. The simulation performs groupings using either $\Delta p \Delta a$ or $\Delta p \Omega a$ (which it chooses at random) for up to four EEs.¹⁰ Before selecting the grouping domain and performing the groupings, the program asks the user to specify which cells of the formal retina he wants on. To designate the values of the retinal cells, an eight by eight positions by two amounts by one moment coordinate system is provided in the very top portion of Figure 6 (see Figure 6). (A complete description of this figure is provided in the Appendix A.)

¹⁰ As it is explained in Appendix A, after grouping on a dimension it is transformed, e.g. following $\Delta p \Omega a$, p becomes p' . For simplicity, however, in the simulation the continua are referred to as Positions and Amounts at every EE.

Insert Figure 6 about here

Since there are only two amounts at 0:EE, receptor cells are either on or off. The 0:EE contains an On cell array and an Off cell array. Having acknowledged which cells are on in the formal receptors, the program proceeds to assign values to the 0:EE: A cell which is on at position x, y on the receptor array will be on at position x, y of the 0:EE On pile and off at the same position of the Off pile. The receptor plane is thus logically equivalent to the 0:EE plane. (The boolean value true corresponds to on.) Following the assignment of values to 0:EE, grouping domains are chosen randomly. The value of each cell at each EE, given the initial conditions and the grouping domain, can be displayed by the program in response to a prompt. The program also displays the order in which the grouping domain were selected.

Running the simulation confirmed that most of the variety was usurped as soon as a Δa grouping was performed. When a Δa grouping was obtained, informational flow continued only for those positions which built upon a receptor cell that had one value while all of its neighbors had a different value. In terms of center surround on-off ganglion cells of biological systems, this corresponds to the extreme condition where the totality of the receptor cells responding to the surround field are off and the those responding to the center field are off, or vice versa. (Note that gradients of amplitude are not here considered.)

It may be considered an advantage of the exhaustive bidimensional continuum criterion that center-surround like cells

are easy to obtain; these cells, however, are of the grossest sort, responding only when the greatest number of cells in the periphery have the same (for $\Delta p \Omega a$) or a different ($\Delta p \Delta a$) amplitude. A more realistic alternative would map the proportion of cells with the same (or a different) amplitude from the pivotal cell. But one must be careful not to introduce principles merely in order to account for ganglion cell level visual processing. Epistemologically, it would be more valuable for a theory to predict on-off cells if it were not carved out especially for this purpose; such an attitude will be necessary if one wishes to account for the whole of perception with the fewest principles. In any case, there are *partial* principles which are less demanding (in terms of the conditions of activation that result from it) than the exhaustive one proposed above and which produce similar results of on-off cells.

The *partial* grouping criterion to be examined relies on pairwise grouping. This involves treating the continuum as a set of axes, along which pairwise grouping will be performed. Given that positions are embodied in hexagonal units, at 0:EE there are three directions to be considered. Since cells have neighbors in both orientations¹¹, in the Δp domain at 0:EE each cell will be a pivotal input cell for six groupings. This creates a problem, which didn't exist with the exhaustive criterion, namely the assignment of a position to the (n+1):EE cell. Choosing to represent all cells into the same number of two dimensional arrays as the n:EE number of arrays is one possible solution. But then cells could no longer be considered collinear, that is, it will not be possible to fit the pieces of the jigsaw puzzle in such a way as to not have blanks between the

¹¹ Note that with this vocabulary, as in physics, *direction* refers to a line (e.g., North-South is a line) and *orientation* is subsidiary to the line, (e.g. North as an orientation on the North-South line).

cells (unless one can produce an algorithm which selects an appropriate cell geometry). Adjacency relations can still be determined, even if not all the pieces of the formal puzzle fit together. For example, one could consider two cells to be adjacent if they were within half of the diameter of the biggest circle which could be inscribed within the (hexagon of the) pivotal cell. But this does create an impressive additional computational burden. Furthermore, it is not immediately evident which geometrical formula will include cells which should be considered as adjacent to each other.

A simpler solution (again for the case of $\Delta p\Omega a$) consists in representing the $(n+1):EE$ cells in discrete two dimensional arrays, where each array represents a direction. That is, inevitably with a pairwise grouping criterion in a bidimensional continuum a new continuum appears by DC. It would be consistent with the policy of representing DCs unambiguously to put cells which are grouped in the same direction in the same array; for a PDC of the pairwise grouping criterion taken from the $\Delta p\Omega a\Omega m$ domain is, in fact, direction. Such a discretization process would be meaningful in the sense of *characterization*. Such a solution is illustrated in Figure 7 (see Figure 7). Note that adjacency relations *within* these two dimensional arrays are completely unambiguous: For all cells have spatial neighbors in the three directions. This process could therefore be applied recursively. The one problem that does occur from such a decision is the determination of adjacency relations if one wants to group across directions (Δd); for the shapes of the arrays change from one direction to another. Note in Figure 7 that, although the number of cells in each $1:EE$ array is identical, each

array of direction has its particular shape. Solutions to this problem will be examined below.

Insert Figure 7 about here

For the purpose of this research the pairwise grouping criterion will be used for all kinds of domains. The advantage of using this criterion is that it can be applied to every domain. In the next section some of the kinds of offspring and problems which follow from pairwise grouping and from the various other assumptions will be examined. Note that a claim to the effect that the pairwise grouping hypothesis is necessary or sufficient to account for the evolution of vision is not made. The hypothesis is merely considered one of the many directions which are worthy of investigation.

Some Ramifications of the Assumptions

Having proposed some specific principles of grouping, some of the offspring that would follow from them will now be studied. This enterprise has two chief aims. One is to understand the physiology of the offspring which the principles predict. The other aim is to find the kinds of problems which occur when modelling evolution within the proposed framework. As in cases of programming in general, it is useful to explore the problem space by hand before sitting down and writing the actual algorithm. In this section, therefore, the offspring will be derived manually, and grouping domains will not be selected randomly.

To simplify the investigation and exposition, offspring following from a two amplitude 0:EE domain will first be considered;

thereafter, a more realistic multi-amplitude domain will be assumed.

Offspring and Issues in a Two Amplitude 0:EE Domain.

The Ω_a domain was explored above; some of the offspring here will group different amounts.

The Δ_a Domain and Line Segment Detection

Grouping different amounts is important for line detection. Lines are best obtained by comparing differences in amounts. If one merely groups different positions without grouping different amounts, one does find cells which respond to lines (e.g. the 1:EE cells of Figure 7); but these cells also respond when not a line but a patch of light (or nonlight) is presented. So, if light is spread uniformly on the receptor plane of the formal organism in Figure 7, *all* cells in the On (i.e., amplitude equal to one) 1:EE stack following would be on. (And, conversely, if no suprathreshold photonic stimulation were presented to the receptor plane, all 1:EE cells of the Off stack would be on.)

To consider this problem from a physical point of view, that is, from the point of view of the reflectance of light from a surface, one finds that on a surface, A, which reflects light of uniform amplitude, $n!$ lines could be drawn connecting n points of the surface in a pairwise fashion. But this light 'patch' will have a small number of edges; namely the segments which delineate it from the surface reflecting a different amplitude of light. One could more economically represent the surface, A, in terms of the contrasts of its edges than in terms of the $n!$ lines which it activates. Marr and

Hildreth (1980) have similarly emphasized the importance of contrasts. Goodson (1973, pp. 74-75) has argued that detecting "edgedness" is the most fundamental capacity which accrues to perceptual knowledge systems in evolution.

Despite the importance of edge detection, not all mutations will cause different amounts to be grouped. But, likely, the successful mutants will contain a Δa grouping at some EE (though not necessarily at 1:EE or 2:EE).

Let us consider the mutant with $\Delta p\Delta a$ at 1:EE (see Figure 8). Figure 8 shows the conditions of activation for three cells per 1:EE array following from a pairwise grouping within the $\Delta p\Delta a$ domain. Note that to facilitate comprehension, the offshoot was represented three times. Each of the three blocks represents the same offshoot. In each block a different direction is illustrated.

 Insert Figure 8 about here

In Figure 8, the EC of a 1:EE cell is that it is on if and only if its pivotal cell is on and its pivotal cell's neighbor in positional and amount space is also on. Now, whereas the $\Delta p\Omega a$ grouping resulted in three 1:EE (two dimensional) arrays, each representing a direction of grouping, the present grouping results in six two dimensional arrays, still representing three directions. There are six (as opposed to three) two dimensional arrays at 1:EE because one can group in two different orientations per direction,¹² *and* the grouping of a pivotal cell with its neighbor does not overlap with the grouping of the pivotal cell's positional neighbor in the same amount

¹² This is true for every nonboundary cell.

array (whereas it does in the case of $\Delta p\Omega a$); hence each grouping must be represented in its own array. There are two PDCs to the EC. The first is directionality, that is, the axis along which the difference in position was considered. And the second is orientation of the contrast, that is, whether the pivotal cell's neighbor has a greater or a lesser amplitude.

A second illustration of the physiology of the $\Delta p\Delta a$ offshoot is provided on Disk 2, which contains a Hypercard simulation that is made to run on a computer from the Macintosh family (see Disk 2)¹³. The simulation provides a graphical illustration of 0:EE and 1:EE (as in Figure 8); moreover, it lets the user specify a pattern of activation at 0:EE by assigning values to a formal receptor plane. (As in the Pascal simulation, 0:EE is merely the translation of the receptor values into an On and an Off array.) The input and output are more easily intelligible than in the Pascal simulation (on Disk 1), since they are completely graphical. Note that, unlike the Pascal simulation, this simulation has built-in conditions of activation. It is therefore not a simulation of evolutionary grouping, but a simulation of the physiology of one specific formal organism. Further details about the simulation are contained in the program itself.

This formal organism has a number of characteristics worth noting. First, arrays representing contrasts in different directions have different shapes. This will make it difficult to group cells

¹³ The user will merely have to double-click on the icon named *hypsim2*. Note that it is essential that the simulation be run using the Hypercard application provided on Disk 2. Using another version of this application will cause the buttons to appear as question marks rather than as hexagons.

representing contrasts in different directions (i.e., Δd). Arrays at the same EE have different shapes. The relation between arrays representing the same direction when there are but three dimensions is particular in as much as every direction is adjacent to every other, much in the same way that in a triangle every side shares an angle with every other side. This will not always be the case. Finally, it should be noted that the amplitude continuum has been usurped by the EC. The derivative of the p continuum (from 0:EE) will be referred to as p' .

Let us consider a possible offspring of the formal organism considered above, which is the result of $\Delta p \Delta a / \Delta p'$. (The operators and continua before the slash represent the grouping domains at 1:EE, and the ones after slash represent the domains at 2:EE. This expression represents a list of groupings.) This offspring has cells that can respond to edges spanning two cells at the receptor level. (One may speculate that, in offspring from this mutant, the arrays of such edge detectors may be incarnated (in a biological system) into the arrangement of cells Hubel & Wiesel (1974, 1979) referred to as "orientation columns.") Beaudoin & Lamontagne (1990) reported a similar offshoot, $(\Delta p \Omega a / \Delta p' \Delta a / \Delta p'' \Delta o$, where o represents orientation), with 3:EE cells which respond to thin lines. That is these cells respond to (1) the activation of spatially adjacent cells of the same amplitude at 0:EE, and (2) the activation of cells spatially adjacent to the cells referred to in (1), but which lie in the array of a different amplitude.

Investigating these mutants suggested that if no grouping from the Δd domain was performed, then the progeny would, at best, be able to detect lines merely from three directions. That is, in order to obtain the pool of directions which many biological systems have

access to, it would be necessary (but not necessarily sufficient) to select a grouping from the Δ_d domain, rather than just passing the direction continuum by SDC. Grouping different directions is therefore an important topic.

Grouping cells representing different directions: A formal or a semantic challenge?

Grouping different directions presents a problem for the theoretician. Given the grouping procedures agreed upon above, within any two dimensional array adjacency relations are nonambiguous. The case is different, however, for Δ_p grouping because the arrays of the grouping domain are of different shapes. A specific example is given in Figure 9 (see Figure 9). This Figure contains two arrays of cells which are taken from the 3:EE of the mutant $\Delta_p\Omega a/\Delta_p'\Delta a/\Delta_p''\Delta o$. (Note that since there was no grouping from the Δ_d domain, by SDC, direction was merely passed on from 1:EE to 3:EE.) The two arrays are from branches of different 1:EE directions. Which cell should be considered adjacent, in the other array, to the bottom cell marked by a pattern? Clearly, the answer to this question rests on an objective coordinate system at the n:EE in question. The problem is in specifying this "objective coordinate system."

Insert Figure 9 about here

There is a pool of candidate coordinate systems to choose from. For example, one can decide to treat the top left cell of every two dimensional array as (0, 0). But then some cells will be left without

neighbors. (Consider the bottom cells of the right array.) Now, one solution is to simply reject these cells. As an alternative solution, one can decide that the middle cell of any array is (0,0). Or one can randomly choose a reference point as (0, 0) coordinate. Any solution would seem to have an arbitrary component; and any solution, it would seem, will impact on the physiology of the offspring (by modifying the exact units that would be considered adjacent to each other.)

There is, however, a path by which one could approach this problem that weakens the claim for an arbitrary selection of a coordinate system. Here, one argues that the differential array shape changes are artifacts of the extremities. Thus the present situation is similar to many contexts in vision modelling, where the boundaries of the receptor plane create problems that don't appear anywhere else. Mathematicians apparently have similar problems with certain cases, such as the number zero. Anyhow, the way to resolve the problem would be to examine the case where the array goes on to infinity, and see if the proposed coordinate systems geometrically reduce to each other. If they do, then one merely has to suppose a receptor plane with a great amount of cells and arbitrarily select one of the coordinate systems provided above. The argument is made more appealing when one considers the great number of receptors in biological visual systems.

The mathematical proof suggesting the plausibility of this path was not undertaken in this research. There is, however, a special branch of mathematics, namely topology, which deals with similar issues and which can be pointed to as a direction in which to seek expertise in order to help solve this problem.

In order to examine the physiology of an offspring from a Δd

criterion (namely, $\Delta p/\Delta d$), a coordinate system was selected. It consisted in using the top left cell of each array as (0, 0). This involved rejecting cells which did not have neighbors in direction space. As expected above, seeming primitives for curved line detection were obtained. Some cells taken from the $\Delta p/\Delta d$ offspring are depicted in Figure 10 (see Figure 10). Figure 10 contains three arrays of 2:EE cells along with the conditions of activation (in terms of 0:EE values) of one cell per 2:EE array. The cells marked in gray in the 0:EE array must be on for the cell marked in gray at 2:EE (immediately below) to be on. The spatially neighboring cells of the marked cells within a 2:EE array have identical conditions of activation (in terms of 0:EE values) except that the position of the 0:EE pattern is offset as a function of the spatial relation between the given cell and the gray cell.

Insert Figure 10 about here

By combining cells A and B of Figure 10, a 3:EE cell which would only be on if 6 cells (at 0:EE) arranged in a circle were on would be obtained. Of course, grouping within the $\Delta p/\Delta d$ domain would yield an *array* of such 3:EE cells, with p'' as a PDC. Given the circular 0:EE field which can be obtained by the combination of these 2:EE cells, it is of interest to investigate whether they could be seen as primitives for center-surround on-off cells.

As will be argued below, the existence of center-surround cells is an important datum for the evolutionary modelling of vision, for the biological cells occur at a relatively early stage of many a biological visual system (e.g., they have been found by Kuffler (1953)

in ganglion cells in the cat). An evolutionary theory which could not account for these cells at an early EE could be considered as refuted. Given the 2:EE units of the formal organism under consideration, it could be shown that center surround like cells would be obtained at 3:EE by the combination of the logical conjunction of the 2:EE cells A and B (displayed in Figure 10) with the negation of cell C (see Figure 10). Formally, the conditions of activation of one of the 2:EE cells, labelled D, could be written in terms of propositional calculus¹⁴ as

$$D \leftrightarrow (A \cdot B \cdot \neg C), \quad (7)$$

that is, cell D (a 3:EE cell), has value true if and only if A and B and not C. But this grouping violates two of the assumptions proposed above. First, the grouping is nonpairwise. Second, in order to use the negation operator one would have to take cell C from the opposite amounts plane. But if cell A and cell B are on the same amounts plane and cell C on another, then one would be using a nonunique grouping domain, i.e., Ωa for $A \cdot B$, and Δa for $(A \cdot B) \cdot \neg C$. But the axioms do not permit the use of two grouping criteria for the passage from an n:EE to (n+1):EE.

This finding could be interpreted as a shortcoming of the group of assumptions, since it is not evident how circular surround like on-off cells would be obtained from them.

To summarize, given a two amplitude domain, formal organisms with cells responding to edges of certain directions were obtained. It was noted that the Δd domain would have to be selected in order to obtain a greater pool of directions and cells responding to curved

¹⁴ For the syntax of propositional logic see Armstrong et al. (1986).

lines. Grouping on different directions uncovered the problem of grouping across values imbedded in arrays of different shapes; a problem to which some solutions were proposed. Cells with circular fields were found in some offspring. A way of obtaining more realistic on-off cells at a low EEs was suggested; this suggestion, however, violated some of the assumptions used thus far. Nonetheless, the possibility of using logical connectives other than *and* seems worthy of investigation. More challenges arise when one considers more realistic and more powerful 0:EE domains.

Offspring and Problems in a Multi-Amplitude 0:EE Domain.

Given a two amplitude 0:EE domain, smooth gradients of light intensity cannot be detected. Many biological systems can detect fine amplitudinal variations, while also being able to detect sharp contrasts. Clearly, a good theory of evolution should be able to account for such capacities. A good theory should also be able to account for the fact that such cells exist at very low levels of vision. In order to investigate this problem space, which is also discussed in Beaudoin & Lamontagne (abstract submitted for publication), a multi-amplitude 0:EE domain was supposed.

An offspring from a four amplitude 0:EE domain was produced. The grouping domains $\Delta p \Delta a / \Delta p'$ were invoked. This offspring was capable of detecting smooth contrasts, that is, contrasts of one amplitude. But it was not able to respond to contrasts greater than one. By implication, contrasts greater than one will never be obtained from mutants of this offshoot, because when such contrasts will be presented to the retina, no corresponding 1:EE neuron will fire. That implies that the information flow in terms of

the contrast, stops at 0:EE.

The problem of detecting great contrast is a consequence not merely of the pairwise grouping hypothesis, but of the principle of adjacency and the global assumptions. The principle of adjacency says that one can group only on differences of one. How then can cells responding to contrasts greater than one be produced? It will be shown that grouping intermediary contrasts (i.e., creating intermediary groupings) cannot be used as a solution, since these groupings will not see their conditions of activation met, since if a cell of one amplitude carries the value true and so does its neighbor then there is no contrast. And the only way an intermediary junction can carry the value true is if a cell and its neighbors have the value true.

 Insert Figure 11 about here

An illustration of this problem is provided in Figure 11. Figure 11 shows a formal organism with four amounts and three moments¹⁵ at 0:EE, and the $\Delta m \Delta a$ grouping at 1:EE. In order to avoid the problem of having axonal traffic, while providing a complete description of the conditions of activation of the cells, the coordinates (amount, moment) of both input 0:EE cells are provided in the 1:EE cells. It must be kept in mind that if a cell at moment m (0:EE) is on at amplitude n , then every other 0:EE cell occupying the same formal moment but a different amplitude must be off (since a retinal cell can't have two different amplitudes at the same moment). It will be seen that if contrasts greater than one are

¹⁵ Moments is used in stead of positions for the sake of simplicity. For it is a unidimensional continuum.

imputed to 0:EE, (e.g. by giving the following input values at the 0:EE level $m = -2, a = 1; m = -1, a = 3; m = 0, a = 5$) then there is no 1:EE cell the condition of activation of which is satisfied. Clearly on these assumptions one cannot build an informational hierarchy to detect nonsmooth contrasts.

Before proposing some solutions to the problem of contrast detection, a formal skeleton of contrast detection in a multi-amplitude domain should be examined. Figure 12 illustrates the kinds of computations which must be performed to detect all possible contrasts between adjacent moments. The grouping criterion was taken from the $\Delta m \Delta a$ domain unrestricted by the principle of adjacency. Each 1:EE cell has a threshold of two and receives input from two 0:EE units. The input units for a given 1:EE unit are adjacent along Moments, but need not be adjacent along Amounts. The essential characterization of 1:EE is thus different amplitudes at adjacent moments. There are two PDCs, which are illustrated by the arrangements of the array of 1:EE neurons: One is the orientation of contrast (i.e., whether the pivotal cell has a greater or smaller amplitude than its neighbor), the other is the degree of difference in amplitude.

Insert Figure 12 about here

This formal representation in Figure 12 may provide a good algorithm for detecting and measuring contrasts; the goal, however, is not to perform such computations as much as to propose an algorithm for deriving organisms which will perform such computations. The algorithm presented in Figure 12 will serve as a formal norm that at least some offspring of a phylogenetic theory

must be capable of matching (or surpassing). In the next section, some general solutions which may meet this important norm are proposed for future research.

Towards a Solution to the Problem of Explaining the Evolution of Early Vision

The problem of accounting for local smooth contrast detection at an early EE provides a pristine challenge for the principle of adjacency. There is a number of possible directions in which the research on the phylogensis of vision could be taken in order to derive offspring capable of contrast detection. Some of these preserve the general philosophy of the principle of adjacency, whereas others propose to modify it. It should be kept in mind, however, that the research reported here rested not only on the principle of adjacency as an axiom, but also on more specific assumptions. The most important of these additional assumptions were: (1) the pairwise grouping hypothesis, (2) that only positive weights should be permitted, and (3) the threshold should be equal to the number of input cells. Affecting the latter hypotheses may be sufficient to solve the problem at hand. Three tangents will be proposed.

The first suggestion preserves the essence of the general principle of adjacency, but adds the assumption that logical connectives other than *and* can be used. It was shown in the two amplitude world that more realistic center-surround cells could be obtained early on if the logical connective "not" were introduced. Contrast detection in a multi-amplitude 0:EE domain, which satisfies the computational requirements depicted in Figure 12 (minus the

orientation of contrast), can be obtained if one allows some thresholds to be *exclusive or (xor)*, while the usual *and* conditions work in parallel, conjuncting the results of neighboring *xor* cells.¹⁶

Insert Figure 13 about here

A neural implementation of such grouping, taken from the $\Delta m \Delta a$ domain, is presented in Figure 13, where a 2 moment, 4 amplitude 0:EE is mapped into 1:EE (see Figure 13). Degree of contrast emerges here as a PDC. It is represented by the plane on which the conjunction cell is active. Given the constraints of the grouping criteria, only one of the conjuncting groups can be active for a given set of inputs. It is these conjunction nodes that represent the degree of contrast. Now, although orientation of contrast is not available to this formal organism, it is not yet known whether some offspring of this general solution would be capable of detecting the orientation of the difference.¹⁷

Within the framework of this solution, it is proposed that the

¹⁶ Strictly speaking, implementing the use of not and xor in neural networks requires using inhibition. But one can merely specify that a connection is of type xor, without using inhibition explicitly in formal neural representations. It would be understood that the xor box, as in Fig B7, represents a neural subnetwork.

¹⁷ Spatial on-off cells in biological organisms respond differentially to the orientation of the difference in amplitudes. For example, some cells respond with an increase in firing rate to the occurrence of more light in their center than their surround region; and the same cells respond with a decreasing firing rate to the occurrence of more light in their surround region, while the baseline firing rate is when a uniform distribution of light is projected onto their whole receptive field.

selection of a grouping criterion imply a nonexclusive choice from a pool of possible types of gates (*and*, *xor*, *or*, *etc.*). This solution is proleptic; it needs formal and foundational clarification. One particularity to be investigated is the fact that it implies levels of groupings within an EE. The impact of this fact on the notion of essential characterization should be examined. Another consideration is the use of different kinds of gates (*and* and *xor*) within an EE. Another issue is that the logical connective does not typically fall within the bounds of formal neuron theory, it usually is implemented by a network of neurons. (The next solution examines this possibility.) In any case, implementing the present solution for one hypothetical organism is a relatively easy matter, but specifying it formally for the *recursive* derivitation of *n* formal organisms is quite another.

The second solution path is to investigate the possibility of explicitly incorporating rules both for inhibition and the determination of thresholds. Using *xor* and not implies the use of inhibition, but representations need not use inhibition explicitly. A more fundamental solution is to let the system (randomly?) choose between excitatory or inhibitory connections, and also to select sets of thresholds for each EE.

Another possible solution for obtaining contrast detection is to give amplitudes a special status. The rationale behind this suggestion is very tightly linked to distinctions that Kant proposed (Kant, 1787/1987, pp. 81-105); they concerned the *matter* and *form* of perception. According to Kant, time and space were innate ideas which formed the structure of perception. That is, they were the form of perception, they were implied before anything (matter,

in the philosophical sense) was even perceived. In this light, amplitude can be seen as the external part of perception, i.e., the matter of perception. Granting a special status to amplitude in an evolutionary framework opens the folding gates to a tide of formal and empirical issues. A clarification of this "special status" must be undertaken in conjunction with reflections on the possibilities of computationally expressing this special status. These reflections may lead to a special principle for amounts, and a principle of adjacency for the other continua.

Further research is needed, possibly along the lines suggested here, to uncover a plausible solution to the problem of accounting for contrast detection in organisms' with multi-amplitude domains. This problem, however, is but one of the hurdles to jump. The major challenge, of course, is to present a theory from which n automata may be automatically derived, regardless of the number of continua and the number of their dimensions.

Concluding Statements

In this paper, one of the infinite number of possible avenues to research the evolution of vision was taken. Many of the underlying assumptions were made explicit. The difficulty in accounting for low level vision suggested that some of these assumptions needed to be revised.

One of the more important contributions of this research was to pinpoint the areas in which assumptions needed to be made. Here it was decided, for example, to render more precise the grouping domain. It was suggested to even further specify the principle of adjacency; this led to the postulation of a pairwise grouping

hypothesis. Future researchers may wish to keep the principle of adjacency but permit random variation of grouping criteria which are consistent with the principle. Also, they may wish to remove some of the assumptions about the relations between the EEs. (E.g. that all cells in one EE builds only on cells from one EE.) This removal would have the effect of increasing the number and complexity of the theory's possible offspring. This would make for a considerable research enterprise.

Another determinant of the number of possible offspring was found to be the number of dimensions in the continua involved in a grouping domain. Although only unidimensional and bidimensional continua were studied here, a proper evolutionary theory will need to provide rules for grouping along continua with an arbitrary number of dimensions. At least it is now known that the number of dimensions is a factor to be considered.

At this juncture, merely an approximation of the research issues in the phylogenesis of vision has been suggested. Much more theoretical research is needed before one can claim to have proposed a provisionally satisfactory system of statements about the computational problem of the evolution of vision.

References

- Armstrong, W. W., Pelletier, F. J., Reckhow, R. A., & Rudnicki, P. (1986). *Formal systems in computing science*. (Available from W. W. Armstrong, Department of Computer Science, University of Alberta, Edmonton, Alberta, T6G 2E2.)
- Beaudoin, L. P. (in press). L'intelligence artificielle pure dans la démarche scientifique. [Pure artificial intelligence and scientific research] *Pugwash Papers*.
- Beaudoin, L. P. & Lamontagne (1990, May). Towards a formalization of the principle of adjacency in the phylogenesis of the visual modality. (Poster to be presented at the Canadian Psychological Association Convention.)
- Beaudoin, L. P. & Lamontagne (Abstract submitted to the Association canadienne française pour l'avancement de la science, for its 1990 convention). Le principe d'adjacence immédiate et la phylogénèse de la vision. [The principle of adjacency and the phylogenesis of vision].
- Beausoleil, J.-R. (1986). *On deriving percepts and producing movement: Theoretical studies of periphery bound knowledge processes*. Unpublished doctoral dissertation, University of Ottawa, Ottawa.
- Creighton, T. E. (1984). *Protein structures and molecular principles*. New-York: W. H. Freeman & Company.
- Curtis, R. (1982). Evolutionary epistemology [Review of Evolutionary epistemology, rationality, and the sociology of knowledge]. *Philosophy of the social sciences*, 19, 95-102.
- Fogel, L. J., Owens, A. J., & Walsh, M. J. (1966). *Artificial intelligence through simulated evolution*. New York: John Wiley & Sons.
- Goodson, F.E. (1973). *The evolutionary foundations of psychology*. Toronto: Holt, Rinehart, & Winston.

- Gould, S. J., & Vrba, E.S. (1982). Exaptation--A missing term in the science of form. *Paleobiology*, 8, 4-15.
- Hubel, D. H. & Wiesel, T. N. (1974). Anatomical demonstration of orientation columns in macaque monkey. *Journal of Comparative Neurology*, 177, 361-380.
- Hubel, D. H. & Wiesel, T. N. (1979). Brain mechanisms of vision. *Scientific American*, 24, 150-162.
- Kant, E. (1787/1987). *Critique de la raison pure*, [Critique of pure reason] Ed. by P. Archambault, Translated by J. Barni. Paris: Flammarion.
- Kuffler, W. S. (1953). Discharge patterns and functional organization of mammalian retina. *Journal of neurophysiology*, 16, 37-68.
- Lamontagne, C. (1987). Sensorymotor emergence: Proposing a computational "syntax." In W. Callebaut & R. Pinxten (Ed.), *Evolutionary Epistemology: A multiparidigm program*. Boston, MA: Reidel Publishing.
- Lamontagne, C. & Beausoleil, J.-R. (1982). Achieving visual spatiality: towards a psychologically relevant, physiological plausible, and computationally efficient conjecture. *Cognition and Brain Theory*, 5, 341-363.
- Marr, D. (1982). *Vision*. W. H. Freeman & Company: New York.
- Marr, D. & Hildreth, E. (1980). Theory of edge detection. *Proceedings of the Royal Society of London*, 207, 181-217.
- Mourant, A. E. (1971). Transduction and skeletal evolution. *Nature*, 231, 466-467.
- Piattelli-Palmarini, M. Evolution, selection and cognition: From "learning" to parameter setting in biology and the study of language. *Cognition*, 31, 1-44.
- Pollard, J. W. (1987). *Evolutionary theory: Paths into the future*. London: John Wiley & Sons.
- Popper, K. R. (1959). *The logic of scientific discovery*. New York: Basic Books.

- Popper, K. R. (1974). 'Intellectual autobiography' and 'Replies to critics.' In P. Schillp (Ed.) *The philosophy of Karl Popper*. LaSalle, Ill: Open Court.
- Popper, K. R. (1983). *Realism and the aim of science*. Totowa: Rowman and Littlefield.
- Popper, K. R. (1987). Natural selection and the emergence of mind. In G. Radnitsky & W. W. Bartley, III (Ed.) *Evolutionary epistemology, rationality, and the sociology of knowledge*. Lasalle, Ill: Open Court.
- Saunders, P. T. & Ho, M. W. (1982). Is neo-Darwinism falsifiable? and does it Matter? *Nature and System*, 4, 179-196.
- Saunders, P. T. & Ho, M. W. (1987). The complexity of organisms. In J. W. Pollard (Ed.), *Evolutionary theory: Paths into the future*. London: John Wiley & Sons.
- Schwyzler, R. (1986). Prediction of potency and receptor selectivity of regulatory peptides: The membrane compartment concept. In D. Theodoropoulos (Ed.), *Peptides* (pp. 7-23). West-Berlin: Walter de Gruyter & Company.
- Think's Lightspeed Pascal: User's guide and reference manual*. (1986). Bedford: Think technologies, Inc.
- Voltaire, F. M.-A., (1734/1964). Sur l'infini et la chronologie. [On the infinite and on chronology] *Lettres philosophiques* [Philosophical letters] Ed. by R. Pomeau. Paris: Garnier-Flammarion.
- Vrba, E.S., & Gould, S.J. (1986). The hierarchical expansion of sorting and selection: Sorting and selection cannot be equated. *Paleobiology*, 12, 217-228.
- Wächtershäuser, G. (1987). Light and Life: On the nutritional origins of sensory perception. In G. Radnitsky & W. W. Bartley, III (Ed.) *Evolutionary epistemology, rationality, and the sociology of knowledge*. Lasalle, Ill: Open Court.

Appendix A

Description of the computer simulation on Disk 1.

This section contains a description of the computer simulation of evolutionary grouping (on Disk 1), which leads to the generation of one offshoot (with n EEs) per run.

The Program was designed to run on a Macintosh Plus. The user will be able to run the simulation by double clicking on the project "Random grouping project" icon. He will then have to select "Open File" from the "File" menu, and choose "Random grouping file." Then the user will merely have to select "Go" from the run menu. The program is explained below, and its code is in Appendix B.

The grouping criterion is exhaustive, as defined in the text, and the grouping domain for each EE is randomly selected from a set of two grouping domains. The program generates two three dimensional arrays. Each array has dimensions corresponding to Positions (2 dimensions), and EE (1 dimension). Note that constraints of Pascal are such that arrays are orthogonal rather than hexagonal (this constraint will be overcome by a simulation technique, below.) The two arrays conjuncted together correspond to an offspring of four dimensions. Simply for the sake of syntax, one array, namely the array which at 1:EE has cells each of which is on if and only if the corresponding cell (i.e. same x same y coordinate) in the retina is on (true) , will be referred to as the ON array; the other array, namely the array which at 1:EE has cells each of which is on if and only if the corresponding retinal cells is off, will be referred to as the OFF array. These arrays will be referred to, merely for the

sake of syntax, as arrays of different amplitudes, or different amplitudinal arrays. A graphical representation of such an offshoot (including an additional 2 dimensional array, the retina) is presented in Figure 6 (but see text below).

The constants defined in the main body of the program define the amount of positions (in terms of x and y) and the amount of EEs of the arrays. The program initializes every cell of both arrays, by assigning the value false to each of them. Then the user is asked to assign values to a receptor plane, referred to as a retina (i.e. a two dimensional array of cells carrying boolean values, where the dimensions are spatial dimensions (x and y)). The user is provided with a coordinate system at the top of Figure 6 (see Figure 6). Given the particularity of the global (as opposed to the local, i.e. unit) geometry, the user is well advised to consult the coordinate system. The values given to the retina will serve as a basis to mechanically assign values to the 1:EE cells of each array.¹⁸ One 1:EE array has cells each of which is on if and only if the corresponding cell (i.e. same x same y coordinate) in the retina is on (true), the other 1:EE array has cells each of which is on if and only if the corresponding retinal cells is off.

Arrays at EEs greater than one contain cells the values of which are determined by the values of relevant cells at $(n-1)$:EE *and* by the grouping domain. The grouping domain is randomly selected at every EE from an arbitrarily restricted set of two grouping domains. In this simulation, at 2:EE the set of grouping domains contains $\Delta p \Delta a$,

¹⁸ Note that given the constraints of the programming language (namely that arrays can't be indexed by a value of 0) a small break with terminology must be made rather than referring to the first EE as 0:EE, as was the case in the body of the paper, the first EE will be referred to as 1:EE, and 1:EE as 2:EE, and so on)

and $\Delta p\Omega a$. Note that Δp is involved in both grouping domains. The only difference between the two grouping domains, therefore, is whether or not adjacent positions are considered in terms of the same ON array or the adjacent ON array. Whatever the domain, the grouping criterion is 'exhaustive' in the sense defined in the text. That is, identity (Ω) requires that all the adjacent cells have the same value, and difference requires that at least one adjacent cell has a different value. More precisely, a $n:EE$ cell, k , resulting from a $\Delta p\Omega a$ grouping will carry the value true if and only if all cells which are adjacent to the pivotal input cell, (i.e. the cell from the same amplitudinal array as the k cell and the same position (x,y)), but from $(n-1):EE$ is on and at least one of k 's positional neighbors from the same amplitudinal array does not have a value true. Conversely, a $n:EE$ cell, j , resulting from a $\Delta p\Delta a$ grouping will carry a value of true if and only if all cells which are adjacent to the pivotal input cell, (i.e., the cell from the same amplitudinal array as the j cell and the same position (x,y)), but from $(n-1):EE$ are true and at least one of j 's positional neighbors from the other amplitudinal array does not have a value true.

A word should be said about the geometry in this simulation and its impact on the determination of adjacency relations. First let us distinguish between local and global geometry. Local geometry refers to the shape of the cells in an array. The global geometry refers to the overall shape of a two dimensional array of cells. E.g. a square, a rectangle, a parallelogram, etc. The concern here is the difference between an orthogonal vs a geometrical local geometry; the former inherently permits a cell to have four neighbors, the second permits a cell to have six neighbors. Now, although the arrays are orthogonal, the code was written in such a way that the

adjacency relationships could be determined as if the units were hexagonal. For in the case of a square like array as well as in the case of a hexagon, cells can be identified by two dimensional coordinates.

Unlike most of the figures presented in the text, the global shape of two dimensional arrays within an EE of the simulation is like that of a parallelogram (with hexagonal units). This solution is an algorithmic shortcut because it minimizes the numbers of cells occupying special positions. The special cells are those occupying a corner and those located on an edge. A proper cell (given a pseudo hexagonal local geometry) has six neighbors which can be identified by one coding expression. Each category of special cells requires its own bit of code for determining which cells are adjacent to it and actually exist. If a global hexagonal shape were chosen, there would be 6 different corner cell cases, and 6 different border cases to consider. A parallelogram was chosen because it admits of only four corners and four border cases. A great part of the code is dedicated to resolving these special cases.

It was said above that the grouping domain was randomly selected, at every EE, from a set of two grouping domains. This is an accurate statement; however, the labels of the grouping domains beyond 1:EE do not semantically map onto the EC of that EE. For once a $\Delta p \Delta a$ grouping has been made, one cannot correctly speak of another $\Delta p \Delta a$. For grouping on a two valued continuum (in this case a) usurps the variety of that continuum. Similarly, the position continuum once grouped upon is no longer p but is p' . It is only for computational simplicity that the two arrays are throughout referred to as "ON" and "OFF". So, once a Δa grouping has been performed, a is transformed into another continuum. Obtaining

more meaningful labels to denote this continuum gets to the heart of the problem of modelling evolution from the programmer's point of view. At this stage of the research, it is sufficient to keep a global label for the grouping domains and remember that the underlying semantics of the grouping depends on which grouping preceded it, at inferior EEs.

Having assigned values to the cells of every EE, the program then displays which grouping domains were selected, and offers the user the possibility of viewing a tabular representation of the cell values from the retina, the "ON" array, and the "OFF" array. It is this final table which is most useful to the user. To facilitate the user's understanding of adjacency relations, the global geometry of the table is as that of a parallelogram.

Appendix B

Code for the simulation on Disk 1

"The simulation was written in *Lightspeed Pascal*. An explanation of the programming syntax is contained in *Think's Lightspeed Pascal* (1986). "

```

program synthesis;
  const
    a = 1;{(b-a) determines the length of the x and y dimensions of the
retina}
    b = 8;
    c = 1;{(d-c) determines the number of legitimate levels (EE) of the
knowledge system}
    d = 5;
  var
    x : a..b;
    y : a..b;
    EE : c..d;      {x and y are positional dimensions, EE is epistemic
level}
    ret : array[a..b, a..b] of boolean; {ret = retina}
    on : array[a..b, a..b, c..d] of boolean;
    off : array[a..b, a..b, c..d] of boolean;

{-----}
procedure opentext; {This procedure opens a text window}
  var

```

```

    r : rect;
begin
    hideall;
    Setrect(r, 0, 20, 515, 350);
    Settextract(r);
    Showtext;
end; {of opentext}
{-----}

```

procedure compute_ret_and_one; {this procedure assigns values to the retina and 1:EE}

```

procedure ret_values; {initializes the retina}
  procedure assign_false_as_default; {to the RET cells}
  var
    x : a..b;
    y : a..b;
    n : c..d;
  begin
    for y := a to b do
      for x := a to b do
        ret[x, y] := false;
      end; {of assign false as default}
    procedure manual_value_to_ret; {the 'user' names the cells that
are ON}
    var
      stop : integer;
    begin

```

```
x := 1;
y := 1;
  writeln('assign the on values to the cells you wish to be on at
level n=1.');
```

```
  writeln('By default, the other cells will be off.');
```

```
  writeln('The first coordinate will be the horizontal one (x)');
  writeln('and the second will be the vertical one (y).');
```

```
  writeln('note that the dimensions correspond to the diagonals one
displayed in the figure');
```

```
  Writeln('When you will have assigned "on" to the last cell you
want on');
```

```
  writeln('type the number 0 in the "stop prompt" ');
  repeat
  begin
    Write('x: ');
    Readln(x);
    Write('y: ');
    Readln(y);
    write('stop?');
    readln(stop);
    ret[x, y] := true;
  end;
  until (stop = 0);
end; {manual value to ret}
```

```
begin    {ret_values procedure}
  assign_false_as_default;
  manual_value_to_ret;
end;    {ret_values procedure}
```

```
{-----}
```

```
procedure compute_one;
```

```
    procedure compute_on_one; {this procedure assigns value to n:EE  
"ON" cells}
```

```
    var
```

```
        x, y, n : integer;
```

```
begin
```

```
    x := 1;
```

```
    y := 1;
```

```
    n := 1;
```

```
    for n := 1 to 1 do
```

```
        for x := a to b do
```

```
            for y := a to b do
```

```
                begin
```

```
                    if ret[x, y] = true then
```

```
                        on[x, y, n] := true
```

```
                    else
```

```
                        on[x, y, n] := false;
```

```
                end;
```

```
            end;{compute_on_one}
```

```
    procedure compute_off_one; {this procedure assigns values to  
the n:EE "OFF" cells}
```

```
{cells can both be either on or off}
```

```
    var
```

```
        x, y, EE : integer;
```

```

begin
  x := 1;
  y := 1;
  EE := 1;
  for EE := 1 to 1 do
    for x := a to b do
      for y := a to b do
        begin
          if ret[x, y] = true then
            off[x, y, EE] := false
          else
            off[x, y, EE] := true;
          end;
        end; {compute_off_one}

begin      { procedure: compute_one}
  compute_on_one;
  compute_off_one;
end;      { procedure: compute_one}

begin {compute_ret_and_one}
  ret_values;
  compute_one;
end;   {compute_ret_and_one}

{-----
--}

procedure compute_random; {this procedures assigns values to n:EE

```

cells (where $n > 1$ and $\leq d$)}

var

t : integer; {random number}

q : integer; {case of random number}

n : integer; {will be assigned to EE}

procedure compute_dpda;

 procedure compute_on_dpda;

 var

 x, y, EE : integer;

 begin

 x := 1;

 y := 1;

 EE := n;

 for x := a to b do

 for y := a to b do

 begin { the conditionals are there in order to account for the 8
special cases, i.e. the 4 corners and the 4 borders.}

 if ((x = a) and (y <> a) and (y <> b)) then {do not include cells in
position 1 and 2 (cf Table "Basic retina")}

 begin

 if ((off[x, (y - 1), (EE - 1)] or off[(x + 1), y, (EE - 1)] or off[(x + 1),
(y + 1), (EE - 1)] or off[x, (y + 1), (EE - 1)]) and on[x, y, (EE - 1)]) then

 on[x, y, EE] := true

 else

 on[x, y, EE] := false;

 end

 else if ((x = b) and (y <> b) and (y <> a)) then

 begin

```

    if ((off[(x - 1), y, (EE - 1)] or off[(x - 1), (y - 1), (EE - 1)] or off[x,
(y - 1), (EE - 1)] or off[x, (y + 1), (EE - 1)]) and on[x, y, (EE - 1)]) then
      on[x, y, EE] := true
    else
      on[x, y, EE] := false;
    end
    else if ((x <> a) and (x <> b) and (y = a)) then

```

```

begin

```

```

    if ((off[(x - 1), y, (EE - 1)] or off[(x + 1), y, (EE - 1)] or off[(x + 1),
(y + 1), (EE - 1)] or off[x, (y + 1), (EE - 1)]) and on[x, y, (EE - 1)]) then
      on[x, y, EE] := true
    else
      on[x, y, EE] := false;
    end
    else if ((x <> a) and (x <> b) and (y = b)) then

```

```

begin

```

```

    if ((off[(x - 1), y, (EE - 1)] or off[(x - 1), (y - 1), (EE - 1)] or off[x,
(y - 1), (EE - 1)] or off[(x + 1), y, (EE - 1)]) and on[x, y, (EE - 1)]) then
      on[x, y, EE] := true
    else
      on[x, y, EE] := false;
    end

```

```

    else if ((x = a) and (y = a)) then

```

{the following four expressions are for the cells on the corners}

```

begin

```

```

    if ((off[(x + 1), y, (EE - 1)] or off[(x + 1), (y + 1), (EE - 1)] or off[x,

```

```
(y + 1), (EE - 1)) and on[x, y, (EE - 1)]) then
  on[x, y, EE] := true
else
  on[x, y, EE] := false;
end
else if ((x = a) and (y = b)) then

begin
  if ((off[x, (y - 1), (EE - 1)] or off[(x + 1), y, (EE - 1)]) and on[x, y,
(EE - 1)]) then
    on[x, y, EE] := true
  else
    on[x, y, EE] := false;
  end
  else if ((x = b) and (y = a)) then

begin
  if ((off[(x - 1), y, (EE - 1)] or off[x, (y + 1), (EE - 1)]) and on[x, y,
(EE - 1)]) then
    on[x, y, EE] := true
  else
    on[x, y, EE] := false;
  end
  else if ((x = b) and (y = b)) then

begin
  if ((off[(x - 1), y, (EE - 1)] or off[(x - 1), (y - 1), (EE - 1)] or off[x,
(y - 1), (EE - 1)]) and on[x, y, (EE - 1)]) then
    on[x, y, EE] := true
```



```

else
  on[x, y, EE] := false;
end
else
{if the cell has 6 neighbours, i.e. if the cell isn't on either of the four
boundaries, nor is one of the four corner cells}
  begin
    if ((off[(x - 1), y, (EE - 1)] or off[(x - 1), (y - 1), (EE - 1)] or off[x,
(y - 1), (EE - 1)] or off[(x + 1), y, (EE - 1)] or off[(x + 1), (y + 1), (EE -
1)] or off[x, (y + 1), (EE - 1)]) and on[x, y, (EE - 1)]) then
      on[x, y, EE] := true
    else
      on[x, y, EE] := false;
    end;
  end;
end; {compute_on}

procedure compute_off_dpda;
var
  x, y, EE : integer;
begin
  x := 1;
  y := 1;
  EE := n;
  for x := a to b do
    for y := a to b do
      begin

        if ((x = a) and (y <> a) and (y <> b)) then {i.e. if the cell is on the

```

borderline far left, and off either of the two corners}

{do not include cells in position 1 and 2 (cf Table "Basic retina")}

begin

if ((on[x, (y - 1), (EE - 1)] or on[(x + 1), y, (EE - 1)] or on[(x + 1), (y + 1), (EE - 1)] or on[x, (y + 1), (EE - 1)]) and off[x, y, (EE - 1)]) then

off[x, y, EE] := true

else

off[x, y, EE] := false;

end

else if ((x = b) and (y <> b) and (y <> a)) then

begin

if ((on[(x - 1), y, (EE - 1)] or on[(x - 1), (y - 1), (EE - 1)] or on[x, (y - 1), (EE - 1)] or on[x, (y + 1), (EE - 1)]) and off[x, y, (EE - 1)]) then

off[x, y, EE] := true

else

off[x, y, EE] := false;

end

else if ((x <> a) and (x <> b) and (y = a)) then

begin

if ((on[(x - 1), y, (EE - 1)] or on[(x + 1), y, (EE - 1)] or on[(x + 1), (y + 1), (EE - 1)] or on[x, (y + 1), (EE - 1)]) and off[x, y, (EE - 1)]) then

off[x, y, EE] := true

else

off[x, y, EE] := false;

end

else if ((x <> a) and (x <> b) and (y = b)) then

```

begin
  if ((on[(x - 1), y, (EE - 1)] or on[(x - 1), (y - 1), (EE - 1)] or on[x, (y
- 1), (EE - 1)] or on[(x + 1), y, (EE - 1)]) and off[x, y, (EE - 1)]) then
    off[x, y, EE] := true
  else
    off[x, y, EE] := false;
  end
  else if ((x = a) and (y = a)) then
{the following four statements are for the cells on the corners}

```

```

begin
  if ((on[(x + 1), y, (EE - 1)] or on[(x + 1), (y + 1), (EE - 1)] or on[x, (y
+ 1), (EE - 1)]) and off[x, y, (EE - 1)]) then
    off[x, y, EE] := true
  else
    off[x, y, EE] := false;
  end
  else if ((x = a) and (y = b)) then

```

```

begin
  if ((on[x, (y - 1), (EE - 1)] or on[(x + 1), y, (EE - 1)]) and off[x, y,
(EE - 1)]) then
    off[x, y, EE] := true
  else
    off[x, y, EE] := false;
  end
  else if ((x = b) and (y = a)) then

```

```

begin
  if ((on[(x - 1), y, (EE - 1)] or on[x, (y + 1), (EE - 1)]) and off[x, y,
(EE - 1)]) then
    off[x, y, EE] := true
  else
    off[x, y, EE] := false;
  end
  else if ((x = b) and (y = b)) then

begin
  if ((on[(x - 1), y, (EE - 1)] or on[(x - 1), (y - 1), (EE - 1)] or on[x, (y
- 1), (EE - 1)]) and off[x, y, (EE - 1)]) then
    off[x, y, EE] := true
  else
    off[x, y, EE] := false;
  end
  else
{if the cell has 6 neighbours, i.e. if the cell isn't on either of the four
boundaries, nor is one of the four corner cells}
begin
  if ((on[(x - 1), y, (EE - 1)] or on[(x - 1), (y - 1), (EE - 1)] or on[x, (y
- 1), (EE - 1)] or on[(x + 1), y, (EE - 1)] or on[(x + 1), (y + 1), (EE - 1)]
or on[x, (y + 1), (EE - 1)]) and off[x, y, (EE - 1)]) then
    off[x, y, EE] := true
  else
    off[x, y, EE] := false;
  end;
end;
end; {compute_off_dpda}

```

```
begin {compute_dpda;}
  compute_on_dpda;
  compute_off_dpda;
end;{compute_dpda}
```

```
procedure compute_dpda;
  procedure compute_on_dpda;
    var
      x, y, EE : integer;
    begin
      x := 1;
      y := 1;
      EE := n;
      for x := a to b do
        for y := a to b do
          begin
            if ((x = a) and (y <> a) and (y <> b)) then
              begin
                if ((on[x, (y - 1), (EE - 1)] and on[(x + 1), y, (EE - 1)] and on[(x + 1),
(y + 1), (EE - 1)] and on[x, (y + 1), (EE - 1)]) and on[x, y, (EE - 1)]) then
                  on[x, y, EE] := true
                else
                  on[x, y, EE] := false;
                end
              end
            else if ((x = b) and (y <> b) and (y <> a)) then
```

```

begin
  if ((on[(x - 1), y, (EE - 1)] and on[(x - 1), (y - 1), (EE - 1)] and on[x,
(y - 1), (EE - 1)] and on[x, (y + 1), (EE - 1)]) and on[x, y, (EE - 1)]) then
    on[x, y, EE] := true
  else
    on[x, y, EE] := false;
  end
  else if ((x <> a) and (x <> b) and (y = a)) then

```

```

begin
  if ((on[(x - 1), y, (EE - 1)] and on[(x + 1), y, (EE - 1)] and on[(x + 1),
(y + 1), (EE - 1)] and on[x, (y + 1), (EE - 1)]) and on[x, y, (EE - 1)]) then
    on[x, y, EE] := true
  else
    on[x, y, EE] := false;
  end
  else if ((x <> a) and (x <> b) and (y = b)) then

```

```

begin
  if ((on[(x - 1), y, (EE - 1)] and on[(x - 1), (y - 1), (EE - 1)] and on[x,
(y - 1), (EE - 1)] and on[(x + 1), y, (EE - 1)]) and on[x, y, (EE - 1)]) then
    on[x, y, EE] := true
  else
    on[x, y, EE] := false;
  end
  else if ((x = a) and (y = a)) then

```

{the following four statements are for the cells on the corners}

```

begin

```

```
    if ((on[(x + 1), y, (EE - 1)] and on[(x + 1), (y + 1), (EE - 1)] and on[x,
(y + 1), (EE - 1)]) and on[x, y, (EE - 1)]) then
```

```
    on[x, y, EE] := true
```

```
    else
```

```
    on[x, y, EE] := false;
```

```
end
```

```
    else if ((x = a) and (y = b)) then
```

```
begin
```

```
    if ((on[x, (y - 1), (EE - 1)] and on[(x + 1), y, (EE - 1)] and on[x, y,
(EE - 1)]) then
```

```
    on[x, y, EE] := true
```

```
    else
```

```
    on[x, y, EE] := false;
```

```
end
```

```
    else if ((x = b) and (y = a)) then
```

```
begin
```

```
    if ((on[(x - 1), y, (EE - 1)] and on[x, (y + 1), (EE - 1)] and on[x, y,
(EE - 1)]) then
```

```
    on[x, y, EE] := true
```

```
    else
```

```
    on[x, y, EE] := false;
```

```
end
```

```
    else if ((x = b) and (y = b)) then
```

```
begin
```

```
    if ((on[(x - 1), y, (EE - 1)] and on[(x - 1), (y - 1), (EE - 1)] and on[x,
(y - 1), (EE - 1)]) and on[x, y, (EE - 1)]) then
```

```
    on[x, y, EE] := true
  else
    on[x, y, EE] := false;
  end
  else
    {if the cell has 6 neighbours, i.e. if the cell isn't on either of the four
    boundaries, nor is one of the four corner cells}
    begin
      if ((on[(x - 1), y, (EE - 1)] and on[(x - 1), (y - 1), (EE - 1)] and on[x,
      (y - 1), (EE - 1)] and on[(x + 1), y, (EE - 1)] and on[(x + 1), (y + 1), (EE
      - 1)] and on[x, (y + 1), (EE - 1)]) and on[x, y, (EE - 1)]) then
        on[x, y, EE] := true
      else
        on[x, y, EE] := false;
      end;
    end;
  end; {compute_on_dpsa}

  procedure compute_off_dpsa;
  var
    x, y, EE : integer;
  begin
    x := 1;
    y := 1;
    EE := n;
    for x := a to b do
      for y := a to b do
        begin
```



```
if ((x = a) and (y <> a) and (y <> b)) then
begin
  if ((off[x, (y - 1), (EE - 1)] and off[(x + 1), y, (EE - 1)] and off[(x +
1), (y + 1), (EE - 1)] and off[x, (y + 1), (EE - 1)]) and off[x, y, (EE - 1)])
then
  off[x, y, EE] := true
else
  off[x, y, EE] := false;
end
else if ((x = b) and (y <> b) and (y <> a)) then

begin
  if ((off[(x - 1), y, (EE - 1)] and off[(x - 1), (y - 1), (EE - 1)] and
off[x, (y - 1), (EE - 1)] and off[x, (y + 1), (EE - 1)]) and off[x, y, (EE -
1)]) then
  off[x, y, EE] := true
else
  off[x, y, EE] := false;
end
else if ((x <> a) and (x <> b) and (y = a)) then

begin
  if ((off[(x - 1), y, (EE - 1)] and off[(x + 1), y, (EE - 1)] and off[(x +
1), (y + 1), (EE - 1)] and off[x, (y + 1), (EE - 1)]) and off[x, y, (EE - 1)])
then
  off[x, y, EE] := true
else
```

```
    off[x, y, EE] := false;
end
else if ((x <> a) and (x <> b) and (y = b)) then

begin
    if ((off[(x - 1), y, (EE - 1)] and off[(x - 1), (y - 1), (EE - 1)] and
off[x, (y - 1), (EE - 1)] and off[(x + 1), y, (EE - 1)] and off[x, y, (EE -
1)]) then
        off[x, y, EE] := true
    else
        off[x, y, EE] := false;
    end
    else if ((x = a) and (y = a)) then
{the following four statements are for the cells on the corners}

begin
    if ((off[(x + 1), y, (EE - 1)] and off[(x + 1), (y + 1), (EE - 1)] and
off[x, (y + 1), (EE - 1)] and off[x, y, (EE - 1)]) then
        off[x, y, EE] := true
    else
        off[x, y, EE] := false;
    end
    else if ((x = a) and (y = b)) then

begin
    if ((off[x, (y - 1), (EE - 1)] and off[(x + 1), y, (EE - 1)] and off[x, y,
(EE - 1)]) then
        off[x, y, EE] := true
    else
```

```

    off[x, y, EE] := false;
end
    else if ((x = b) and (y = a)) then

begin
    if ((off[(x - 1), y, (EE - 1)] and off[x, (y + 1), (EE - 1)]) and off[x, y,
(EE - 1)]) then
        off[x, y, EE] := true
    else
        off[x, y, EE] := false;
    end
    else if ((x = b) and (y = b)) then

begin
    if ((off[(x - 1), y, (EE - 1)] and off[(x - 1), (y - 1), (EE - 1)] and
off[x, (y - 1), (EE - 1)]) and off[x, y, (EE - 1)]) then
        off[x, y, EE] := true
    else
        off[x, y, EE] := false;
    end
    else
{if the cell has 6 neighbours, i.e. if the cell isn't on either of the four
boundaries, nor is one of the four corner cells}
begin
    if ((off[(x - 1), y, (EE - 1)] and off[(x - 1), (y - 1), (EE - 1)] and
off[x, (y - 1), (EE - 1)] and off[(x + 1), y, (EE - 1)] and off[(x + 1), (y +
1), (EE - 1)] and off[x, (y + 1), (EE - 1)]) and off[x, y, (EE - 1)]) then
        off[x, y, EE] := true

```

```
else
  off[x, y, EE] := false;
end;
end;
end; {compute_off_dpda}

begin {compute_dpda}
  compute_on_dpda;
  compute_off_dpda;
end; {compute_dpda}

begin {compute_random}
  for n := 2 to d do
    {can't start n off at c (i.e. 1) for EE=n and the next operation on EE
    should start at EE=2}
    {{for the EE=1 is an initialization of on & off piles and EE =2 is
    grouping proper}
    begin
      t := Random;
      if t > 0 then
        begin
          compute_dpda;
          writeln('EE=', n, ' grouping was performed according to dpda ');
        end
      else
        begin
          compute_dpda;
          writeln('EE=', n, ' grouping was performed according to dpda ');
        end
      end;
    end;
```

```
end;  
end; {compute_random}
```

```
{-----}
```

```
procedure checkcell;  
var  
    stop : integer;  
begin  
    stop := 0;  
    writeln('would you like to check the value of a particular cell?');  
    writeln('if not type 0');  
    readln(stop);  
    if stop <> 0 then  
        begin  
            write('you can now check the value of any cell at the EE level of  
your choice, provided that');  
            writeln(c, '>=EE>=', d);  
            repeat  
                begin  
                    writeln('Here are the choices: none(0), retinal cell(1); on cell(2);  
off cell(3).');  
                    readln(stop);  
                    if stop <> 0 then  
                        begin  
                            Write('x: ');  
                            Readln(x);  
                            Write('y: ');  
                            Readln(y);
```

```

write('EE: ');
readln(EE);
case stop of
0 :
  write("");
1 :
  write('the value of the retinal cell', x, y, ' is ', ret[x, y], '.');
2 :
  write('the value of the on cell', x, y, EE, ' is ', on[x, y, EE], '.');
3 :
  write('the value of the off cell', x, y, EE, ' is ', off[x, y, EE], '.');
end;
end;
  writeln;
end
until stop = 0;
end;
end; {checkcell }

```

```
{-----}
```

```
procedure table; {this procedure writes a table listing the values of
all the cells}
```

```

const
e = 1;
f = 2;
g = 3;
h = 4;
i = 5;
j = 6;

```

```
k = 7;
l = 8;
m = 7; {this const indicates the space between cells (on x) in
table; 7 is its OPTIMAL value}
pos = 27;
pos2 = 29;
var
p : integer;
procedure table_ret;
var
x, y : integer;
stop : integer;
begin
  writeln('Would you like to see the retinal TABLE of cell values? (If
yes type 1; if no type 0)');
  Readln(stop);
  if stop <> 0 then
  begin
    Writeln('RETINAL CELLS VALUES:');
    writeln(e : pos2, f : m, g : m, h : m, i : m, j : m, k : m, l : m);
    for y := a to b do
    begin
      p := pos - (y * 3);
      write(y : p);
      for x := a to b do
      begin
        write(ret[x, y] : m);
      end;
    end;
```

```
writeln;
end;
end;
end; {table_ret}

procedure table_on;
var
  x, y, EE : integer;
  stop : integer;
begin
  writeln('Would you like to see the values of cells from (or
following from)');
  writeln('the ON plane? (If yes type 1; if no type 0) ');
  Readln(stop);
  if stop <> 0 then
  begin
    Writeln('Values of cells from (or following from) the ON plane:');
    for EE := c to d do
    begin
      writeln('EE= ', EE : 1);
      writeln(e : pos2, f : m, g : m, h : m, i : m, j : m, k : m, l : m);
      begin
        for y := a to b do
        begin
          p := pos - (y * 3);
          write(y : p);
          for x := a to b do
          begin
            write(on[x, y, EE] : m);
```



```
end;  
  writeln;  
end;  
end;  
end;  
end;  
end; {table_on}
```

```
procedure table_off;  
var  
  x, y, EE : integer;  
  stop : integer;  
begin  
  writeln('Would you like to see the table of cell values from (or  
following from)');  
  writeln('the off plane ?( If yes type 1; if no type 0) ');  
  Readln(stop);  
  if stop <> 0 then  
    begin  
      Writeln('Values of cells from (or following from) the OFF plane:');  
      for EE := c to d do  
        begin  
          writeln('EE= ', EE : 1);  
          writeln(e : pos2, f : m, g : m, h : m, i : m, j : m, k : m, l : m);  
          begin  
            for y := a to b do  
              begin  
                p := (pos - (y * 3));  
                write(y : p);
```

```
    for x := a to b do
    begin
        write(off[x, y, EE] : m);
    end;
        writeln;
    end;
end;
end;
end;
end;
end;{table_off}

begin {table procedure}
    table_ret;
    table_on;
    table_off;
end; {table procedure}
{-----}

begin {main}
    opentext;
    compute_ret_and_one;
    compute_random;
    checkcell;
    table;
end.
```

Figure Captions

Figure 1. This figure represents a receptor plane at moment zero ($m = 0$) with cells carrying amplitudes ranging from zero to two (in integer steps), along with the corresponding 0:EE. The amplitudes of the receptors determine which cells will be on at moment zero of 0:EE. An 0:EE cell of position x, y and amount a is on if and only if the corresponding receptor cell of position x, y has amplitude a .

Figure 2. At 0:EE there are positions, two moments, and two amounts. The grouping from 0:EE to 1:EE takes four different positions on the one axis, same amounts, same moments and joins them into a 1:EE cell, via a cell with a threshold of four. Although the conditions of activation are only illustrated for two cells per two dimensional 1:EE array, as will be the case hereafter each n :EE cell represents the same kind of grouping as the one explicitly depicted in terms of neural networks.

Figure 3. This figure represents groupings taken from the $\Delta p \Delta a$ grouping domain (1:EE) and from the $\Delta p \Omega a$ grouping domain (2:EE). Each cell is grouped with each of its spatial neighbors. As is explained in Appendix A, where the computer simulation using these grouping criteria is described, nonboundary cells have six neighbors. It is for the purpose of simplifying the simulation that the continua, after they have been grouped upon, are still referred to as p , or as a , rather than p' or a' . (See the text and Appendix A.)

Figure 4. An example of tripletwise grouping from the $\Delta j \Omega k$

grouping domain, where j and k are unidimensional continua taking four and two values, respectively. Each nonbondary 0:EE cell is a pivotal cell with each of its two neighbors along dimension j .

Figure 5. An example of pairwise grouping from the $\Delta j\Omega k$ grouping domain. Each 0:EE cell serves as a pivotal cell to exactly one grouping into a 1:EE cell.

Figure 6. An illustration of the structure of the grouping from the simulation described in Appendix A. The figure contains the coordinate system for the simulation on Disk 1. The receptor plane has eight times eight positions (along x and y), and two amplitudes and one moment. Each EE is subdivided into two two dimensional arrays, where each dimension is a spatial dimension. One of the 1:EE arrays has cells which carry true if the corresponding receptor is on, the other carries false under the same conditions. The figure textually indicates that the grouping takes place according to an exhaustive grouping criterion. (See Appendix A for further details.)

Figure 7. Pairwise grouping from the $\Delta p\Omega a$ grouping domain from 0:EE (amounts by positions) to 1:EE (positions' by directions). Each two dimensional array of 1:EE represents the direction along which the grouping was performed. A hexagonal geometry permits three such directions.

Figure 8. Pairwise grouping from the $\Delta p\Delta a$ grouping domain, from 0:EE (amounts by positions) to 1:EE (positions' by directions by orientations). The 0:EE arrays are presented three times merely to increase the clarity of the diagram; in fact, there are only two 0:EE

amplitudes (hence two 0:EE two dimensional arrays). Direction and orientation of grouping is represented in discrete arrays. Each nonboundary 0:EE cell forms a grouping in two orientations per direction. The orientations are represented in discrete arrays because, contrary to the $\Delta p \Omega a$ grouping, the grouping of one cell never equals the grouping of the cell's spatial neighbor of the same 0:EE amplitude (compare with Figure 5).

Figure 9. The arrays of different amplitudes at 0:EE are identical in terms of positions. As groupings are performed, the shape of arrays change: They shrink along the dimension grouped upon. Depicted here are two 0:EE arrays representing each of two amplitudes, and two 3:EE arrays. Note that the global geometry of the 3:EE arrays is different. Also note that the 3:EE cell marked by a grey pattern has no spatial neighbor (at least not along one of the directions) in the other 3:EE array.

Figure 10. Three arrays of 2:EE cells along with the 0:EE. (Note that the 0:EE array can be considered as the same across the three representations, it was replicated for didactic purposes.). A $\Delta p \Delta d$ grouping was performed. Each 2:EE array has one of its cells marked in grey; the condition of activation of each of these cells (*in terms of 0:EE values*) is that at least the 0:EE cells marked in grey in the array above carry the value true. The patterns of conditions of activation may be primitives of curved lines. Connecting cells A and B would yield a circular receptive field. Connecting cells A and B with the negation of cell C would yield a center-surround like cell (see text).

Figure 11. Pairwise grouping from the $\Delta a \Delta m$ domain. Four amplitudes and three moments are stored. The 0:EE cells in relation to which the conditions of activation of the 1:EE cells are determined are inscribed within the 1:EE cells, according to the legend. Note that if there is a difference of more than one amplitude between adjacent moments, no 1:EE cell will have its conditions of activation met.

Figure 12. The computations which would need to be performed in order for a system to detect contrasts greater than one through the time continuum; the $\Delta m \Delta a$ grouping domain is restricted by the principle of adjacency for Δm but not for Δa . Note that nonadjacent 0:EE amounts are grouped into 1:EE cells.

Figure 13. A way of obtaining amplitudinal contrast detection through time while preserving the essence of the principle of adjacency. 0:EE contains five amplitudes and two moments. The 1:EE consists of a hierarchy of *xor* junctions, where a cell is on if and only if one of its input cells are on, and of *and* junctions, where a cell is on if and only if all of its input cells are on. Note that the *xor* cells have adjacent cells as their input, and that adjacent *xor* cells also participate in *and* junctions. The degree of amplitudinal contrast across moments is indicated by the level (one through four) on which an *and* cell is on. For any nonempty set of inputs at moments (-1) and (0) there will only be one *and* cell with the value true.

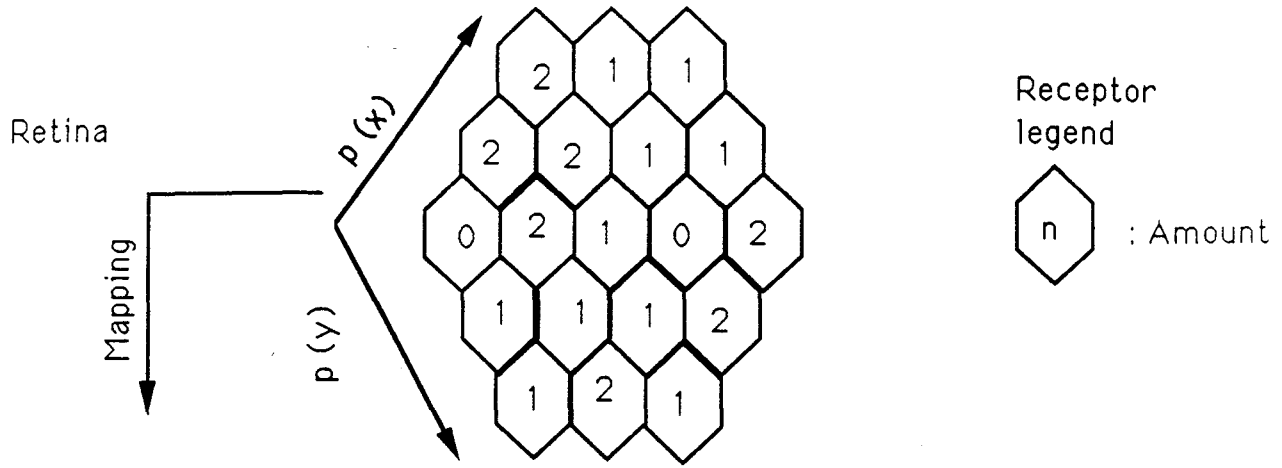

Epistemic Entity

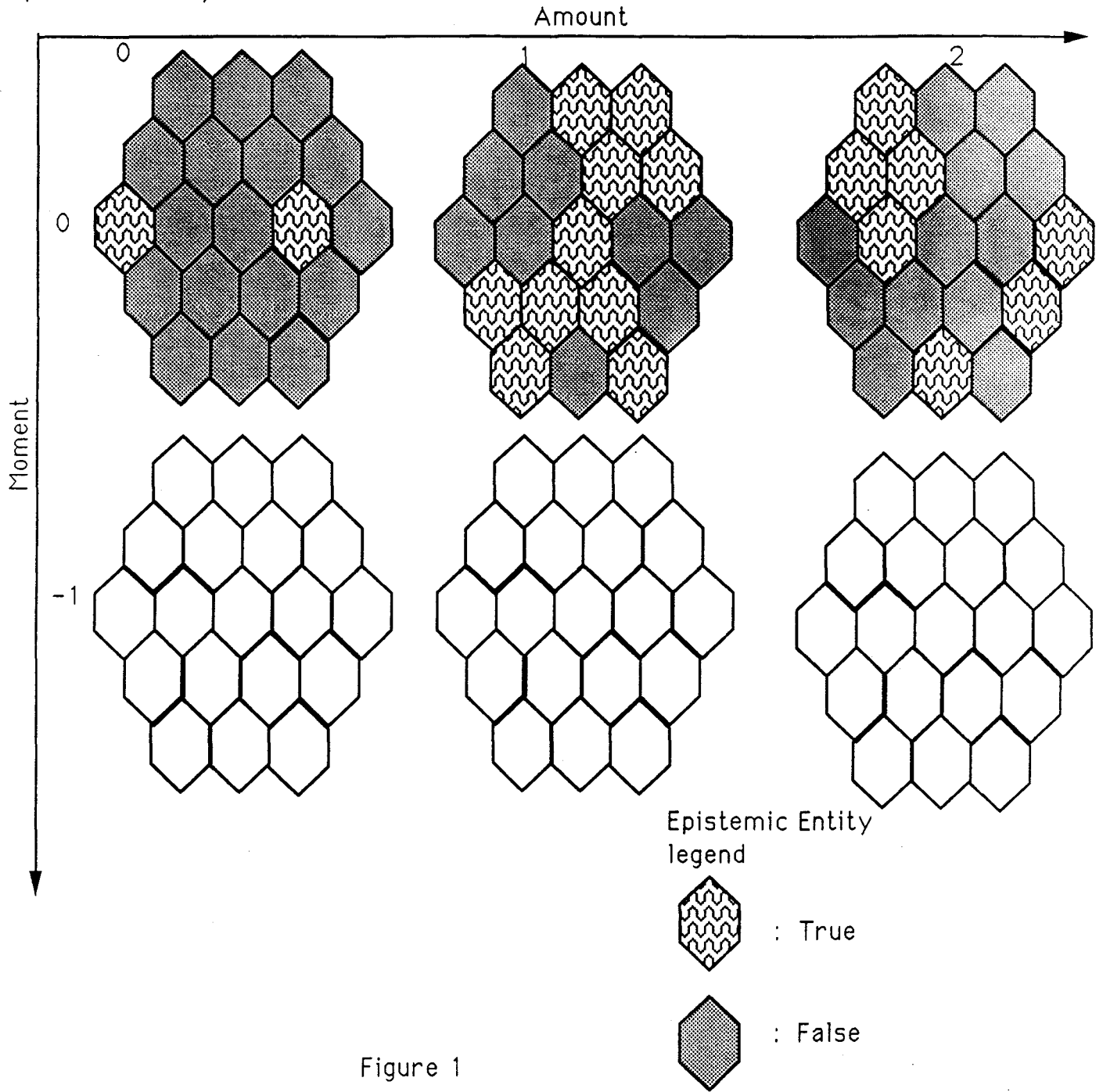

Figure 1

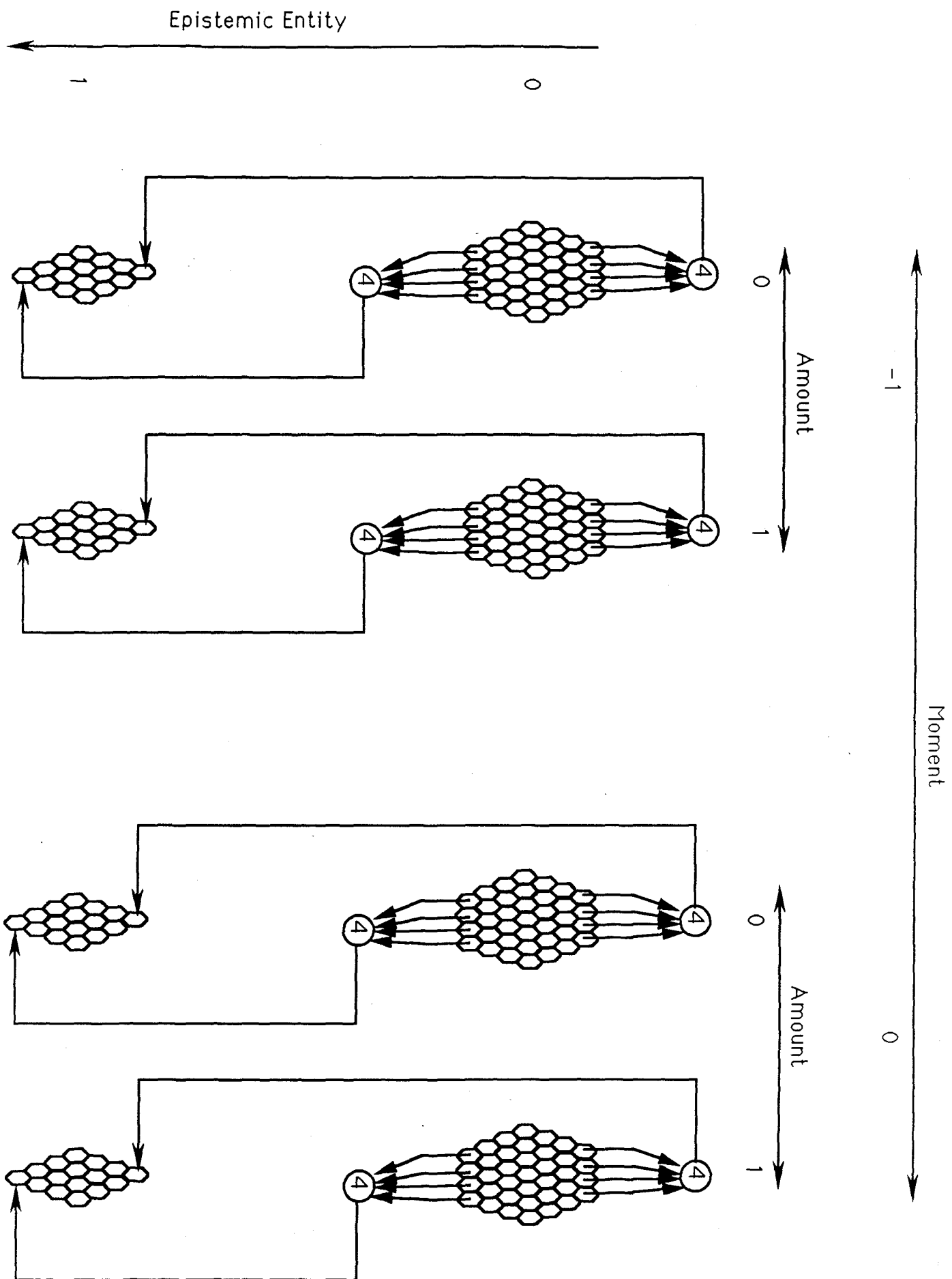

Figure 2

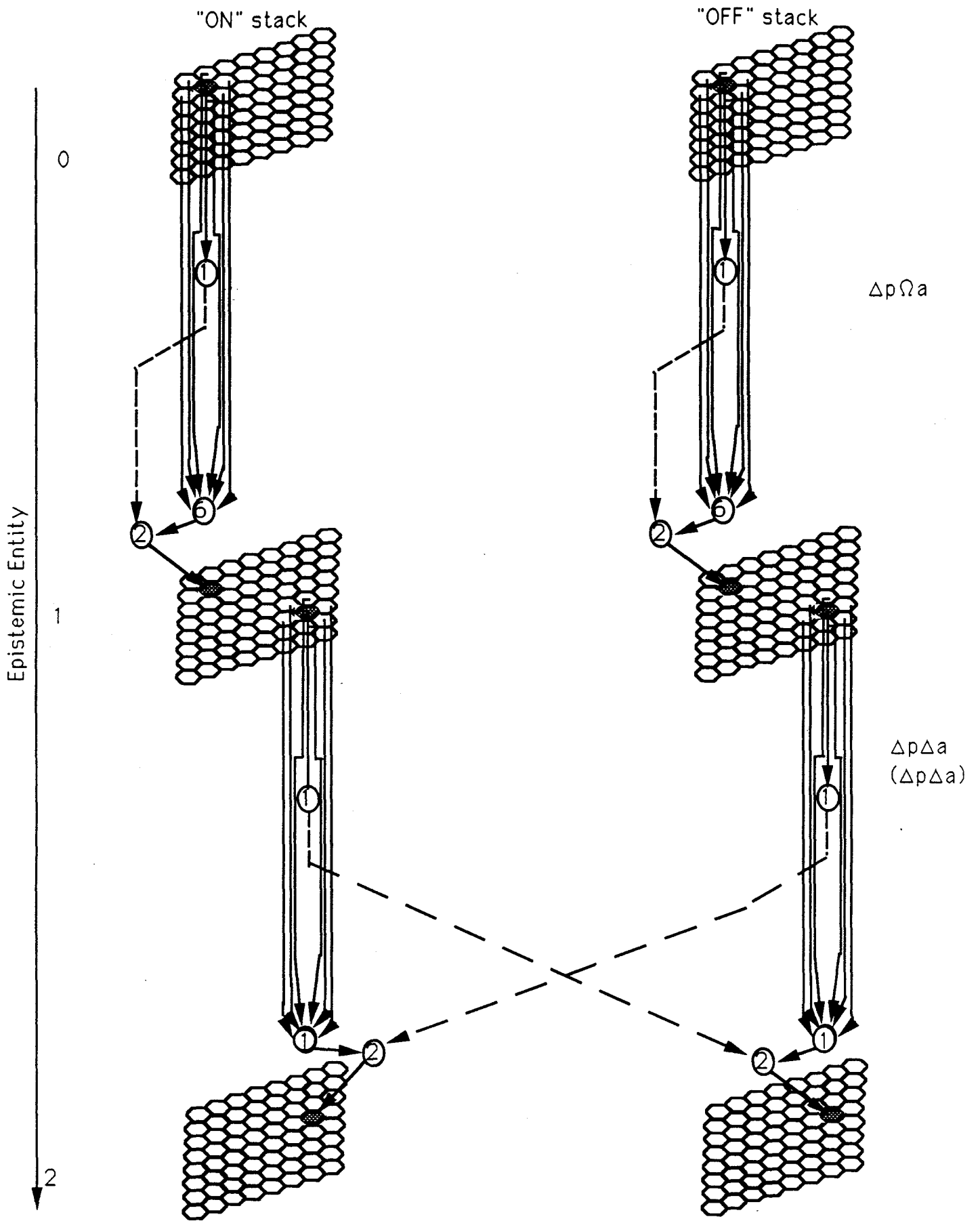

Figure 3

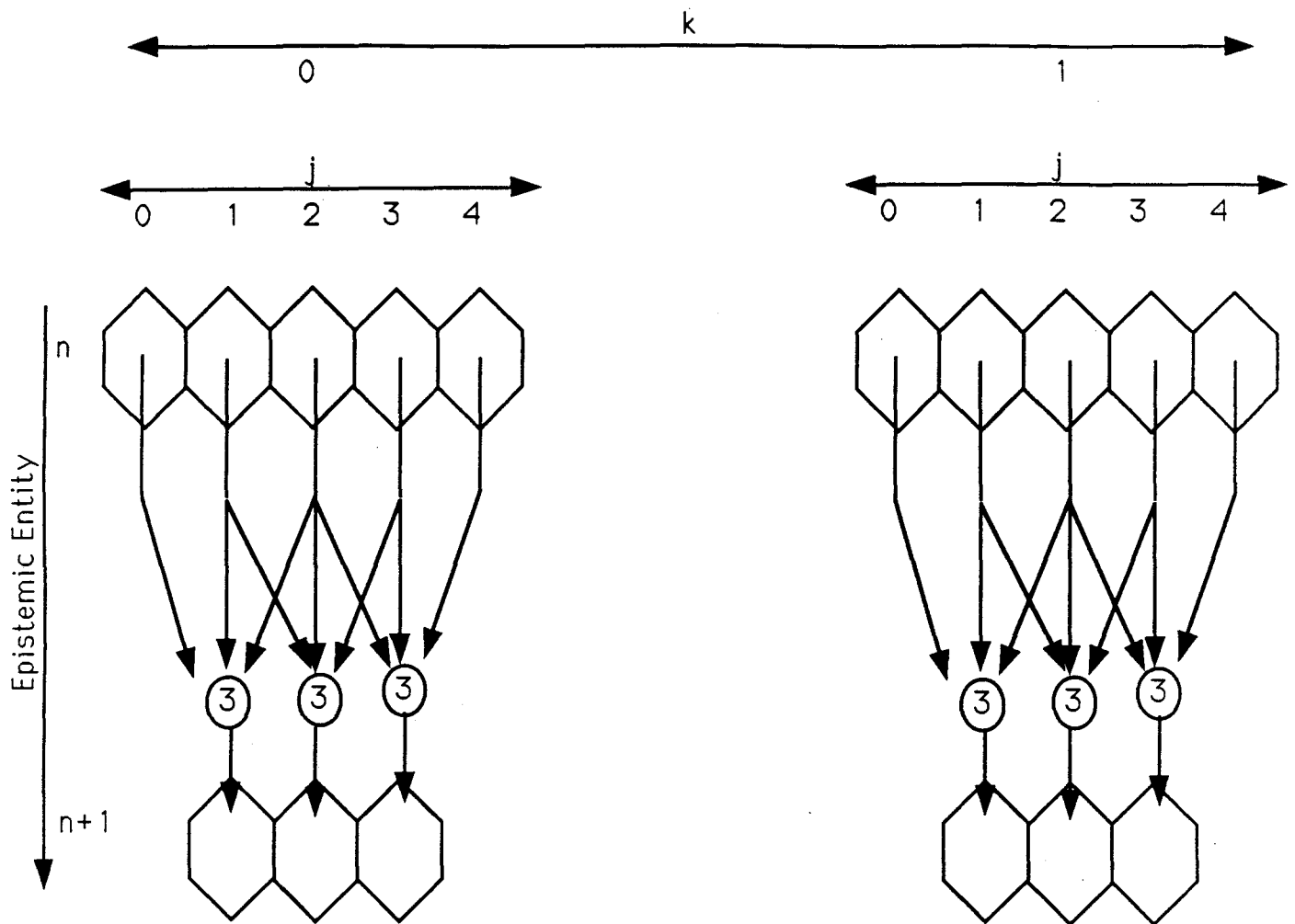

Figure 4

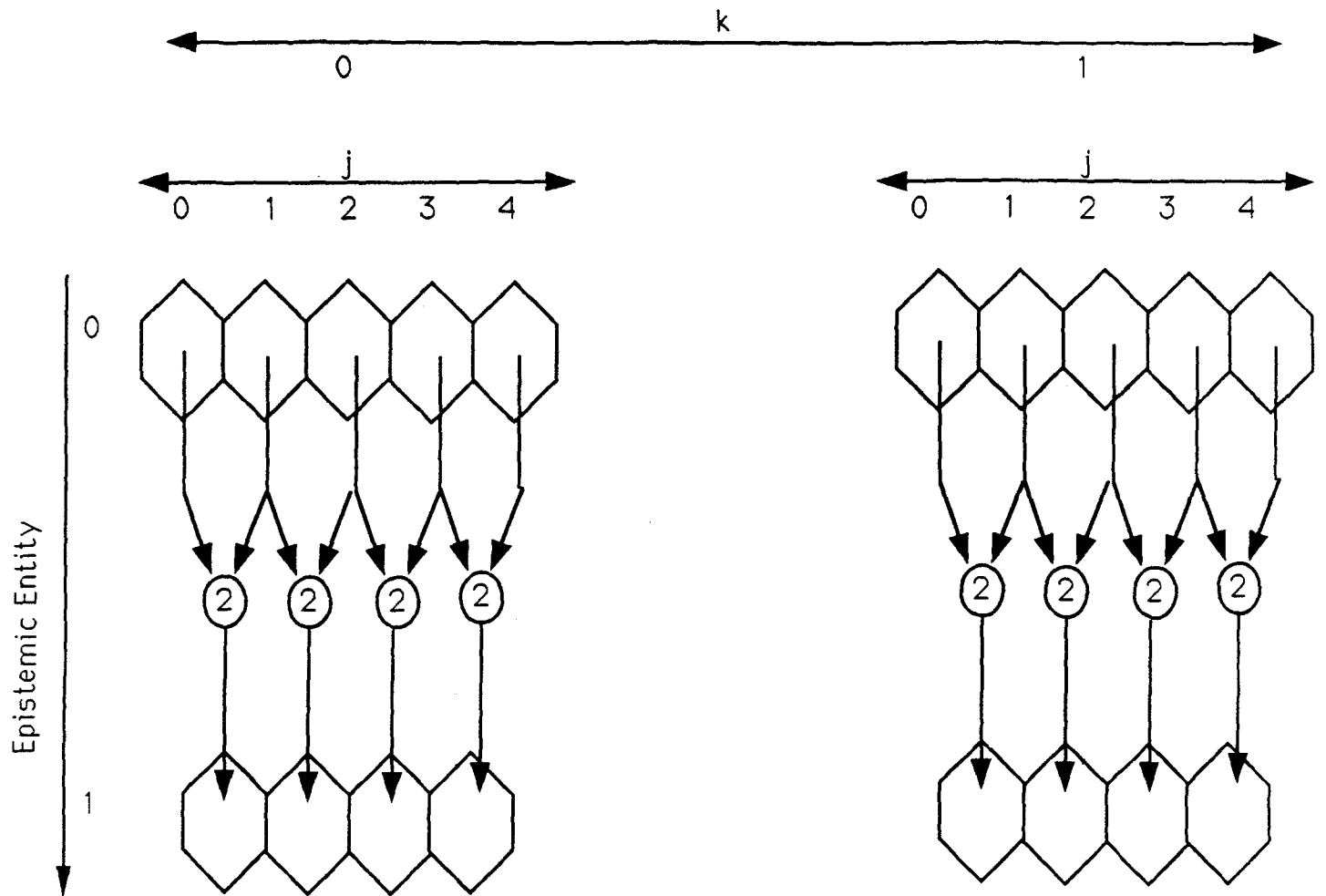

Figure 5

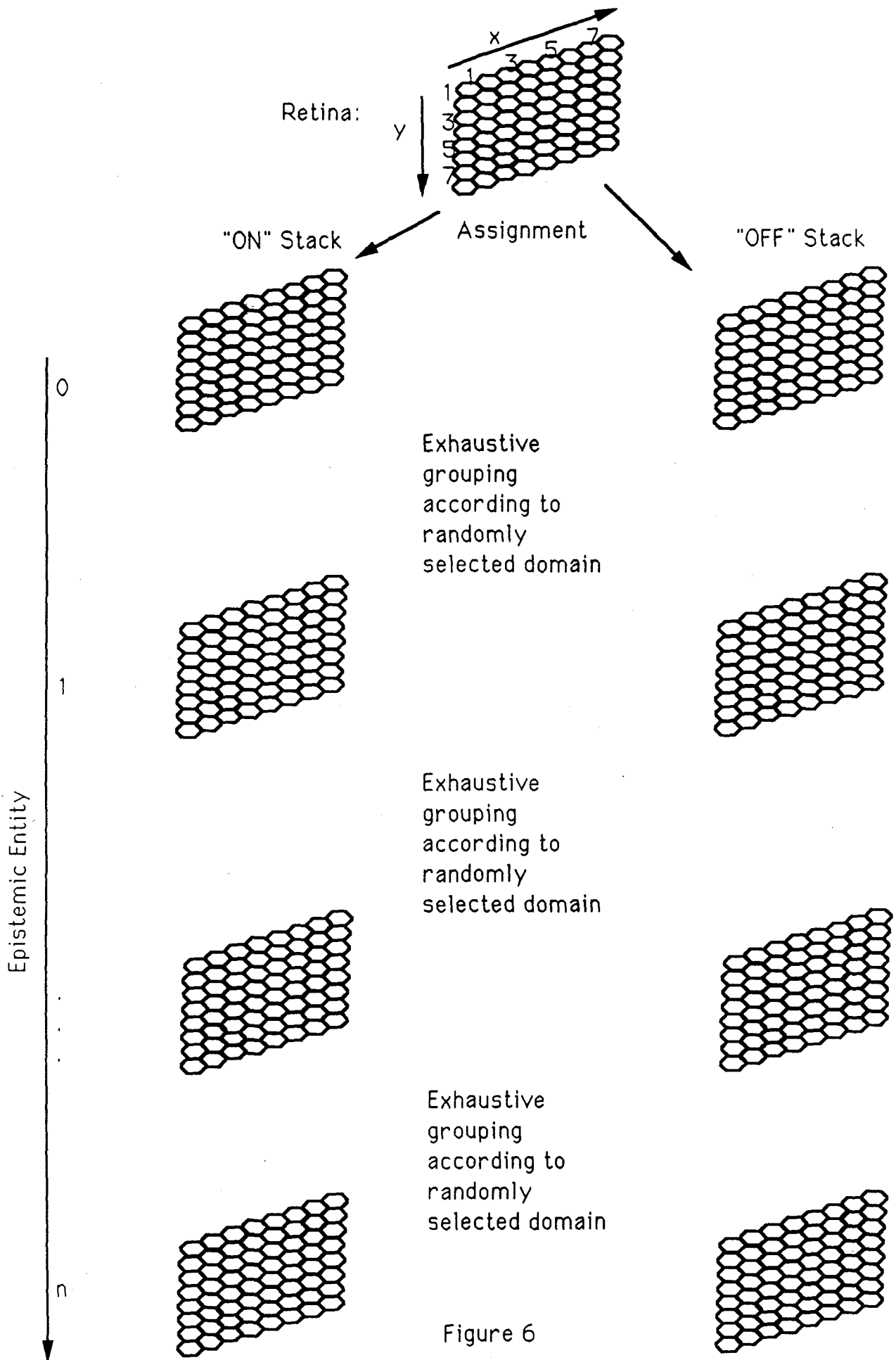

Figure 6

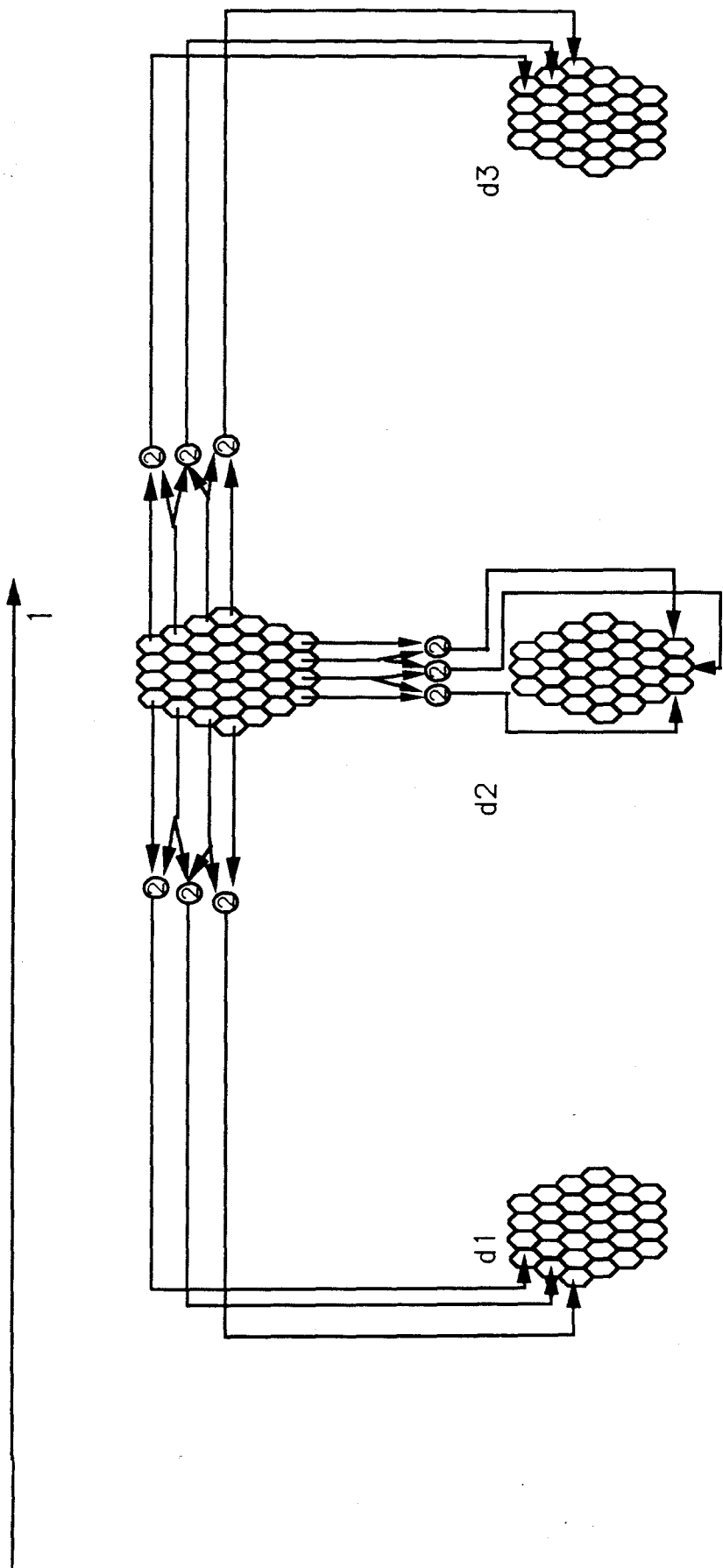

Figure 7

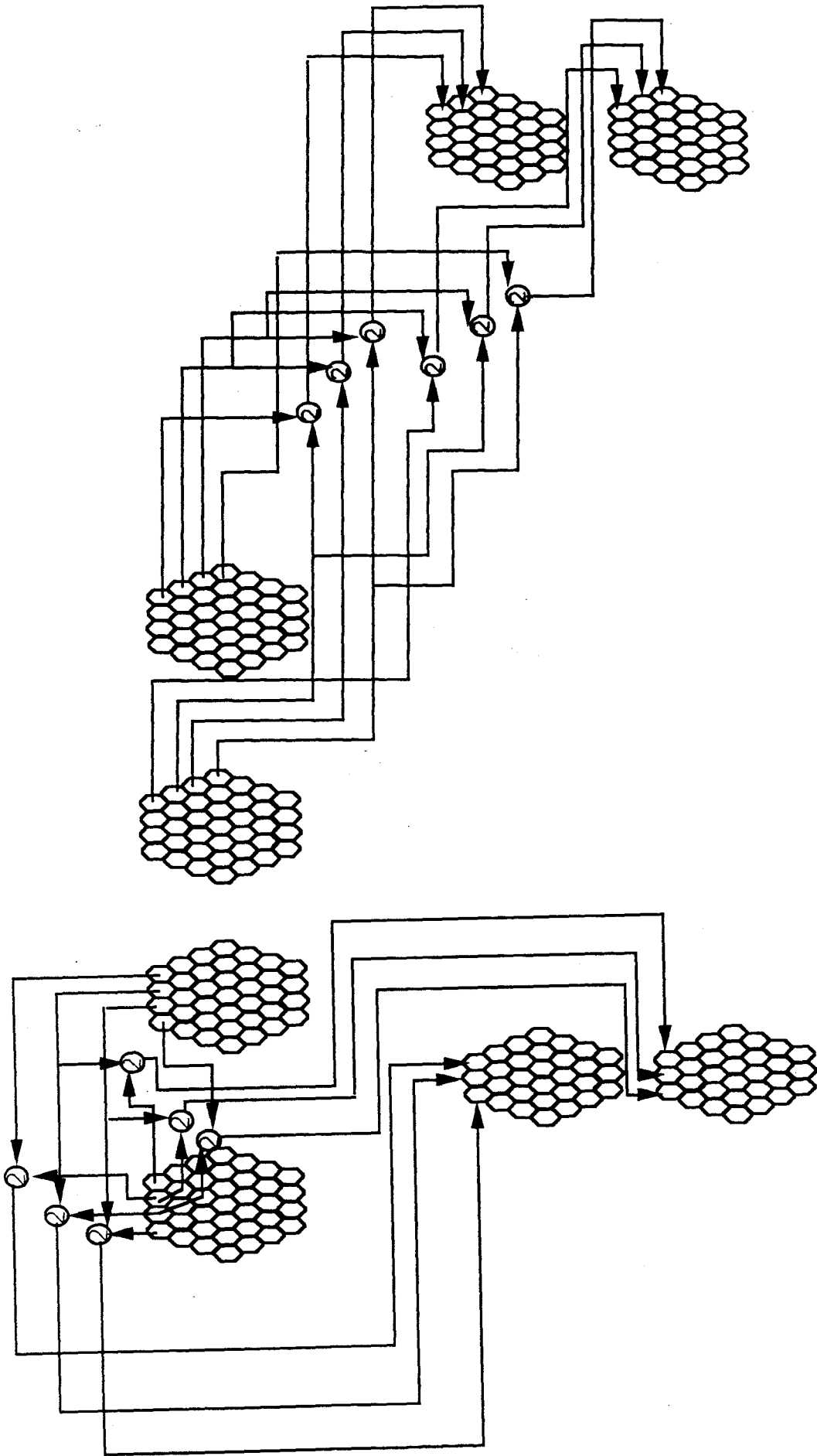

Figure 8

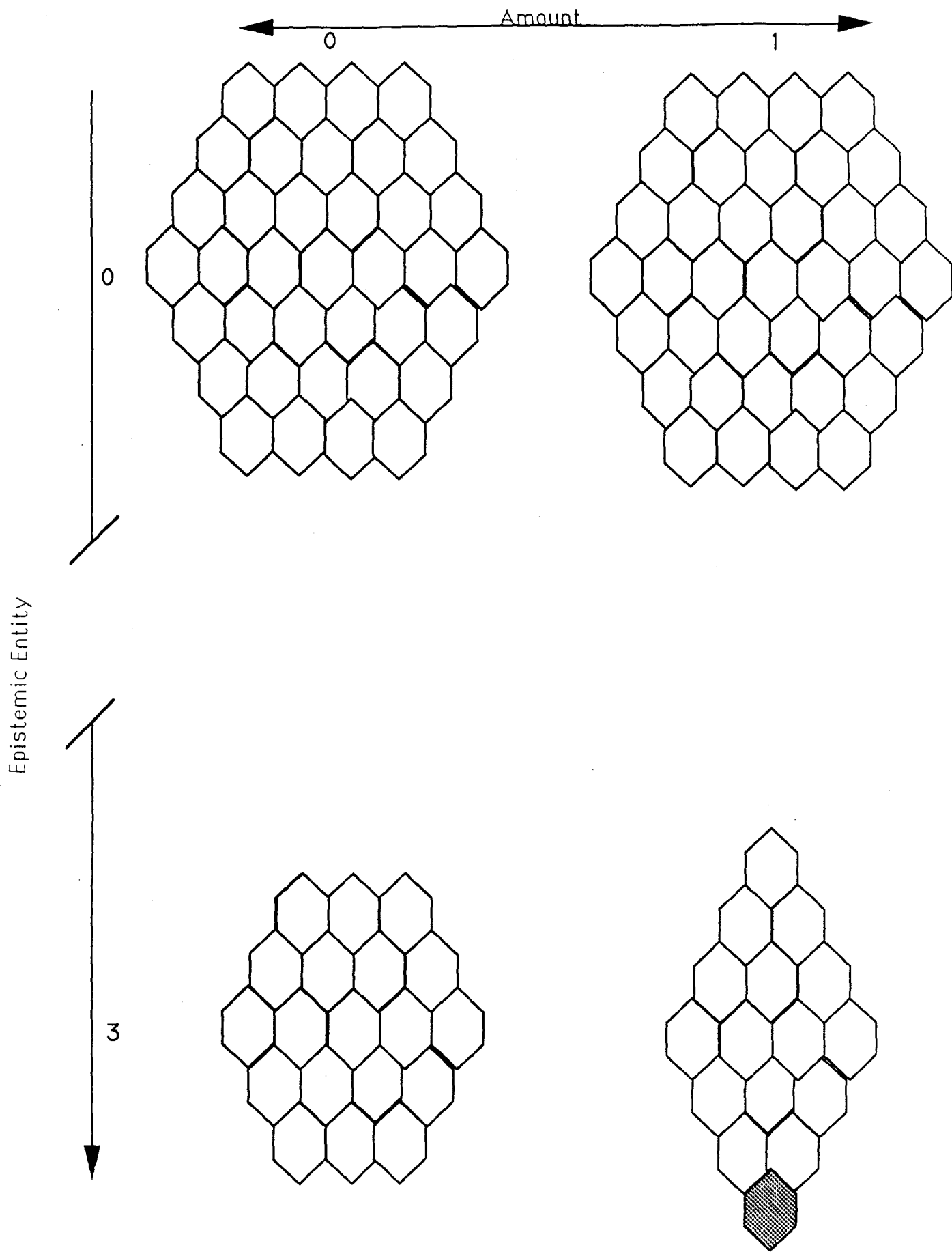

Figure 9

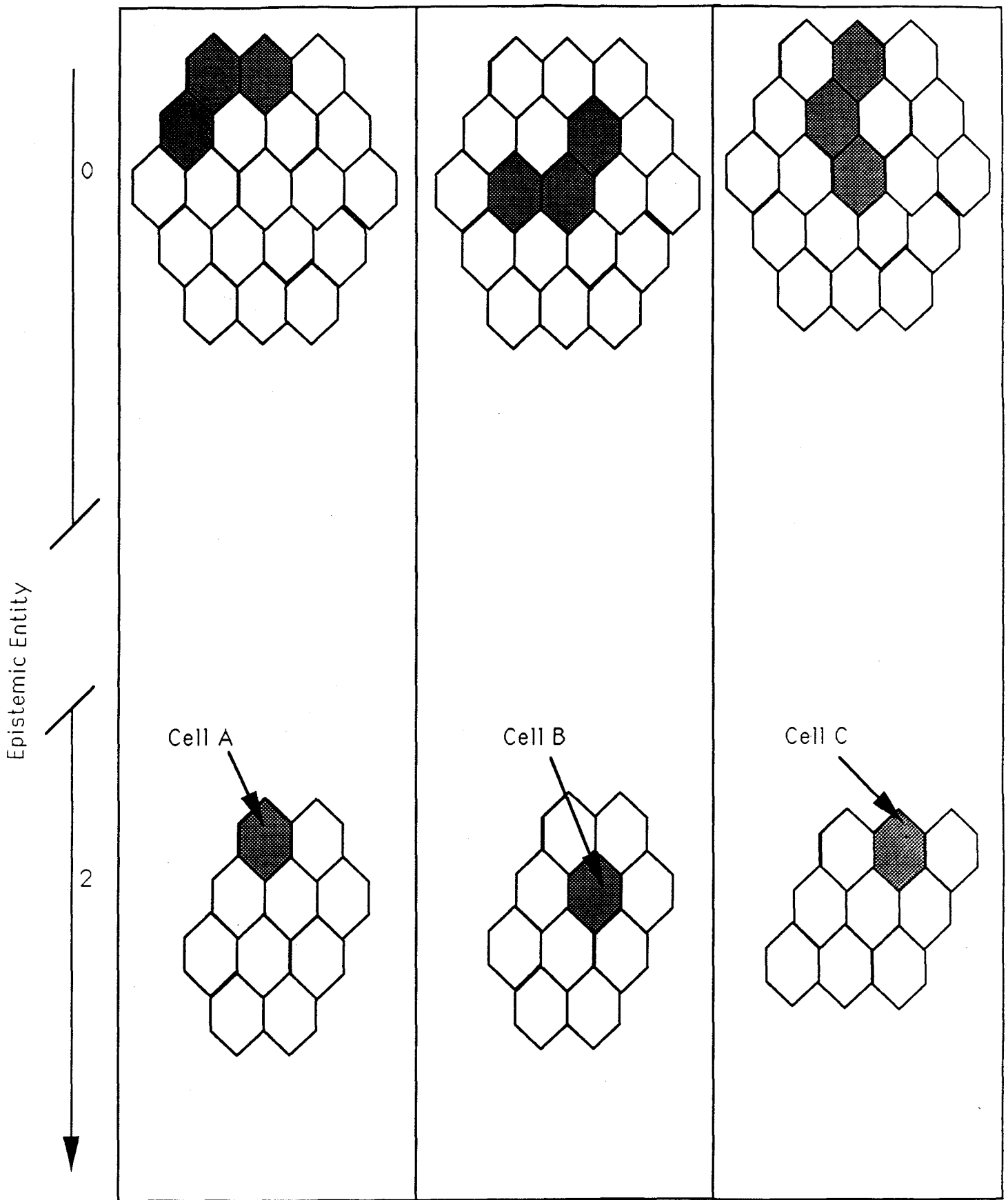
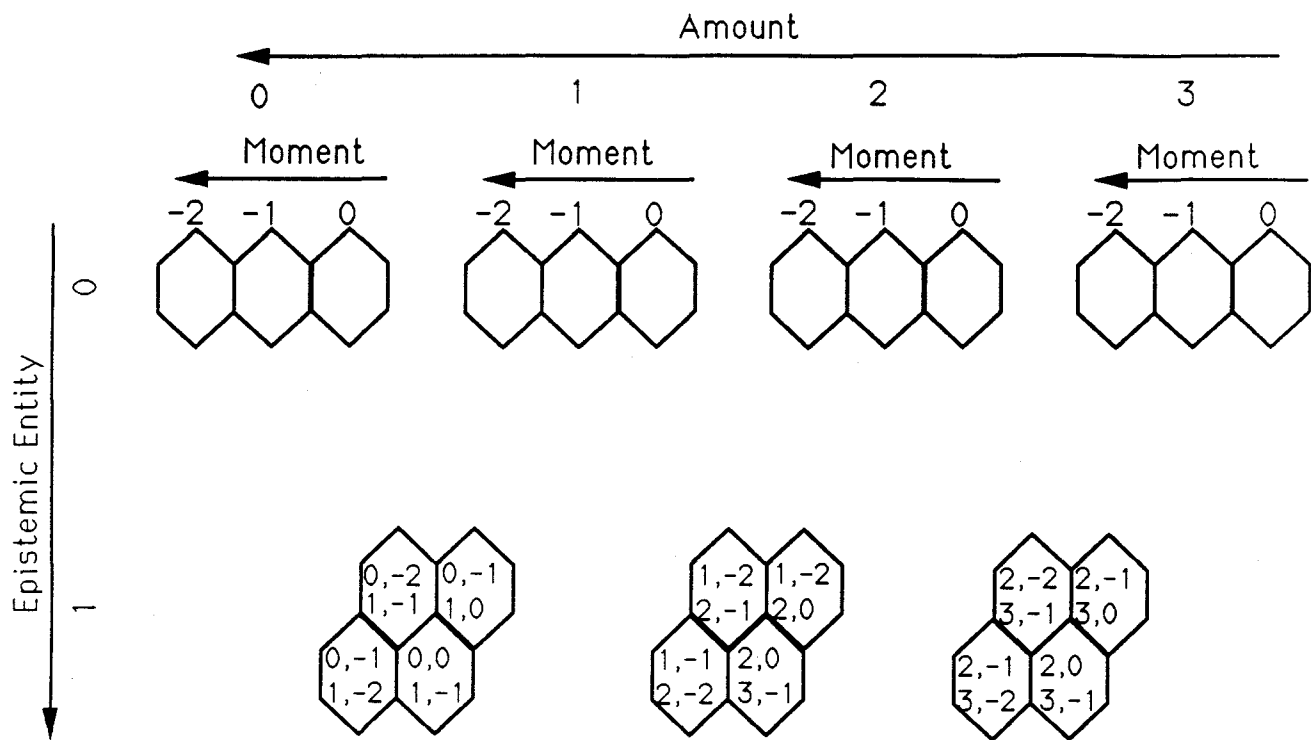

Figure 10



Legend of coordinates
of 0:EE cells inscribed
in the 1:EE somas.

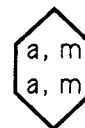
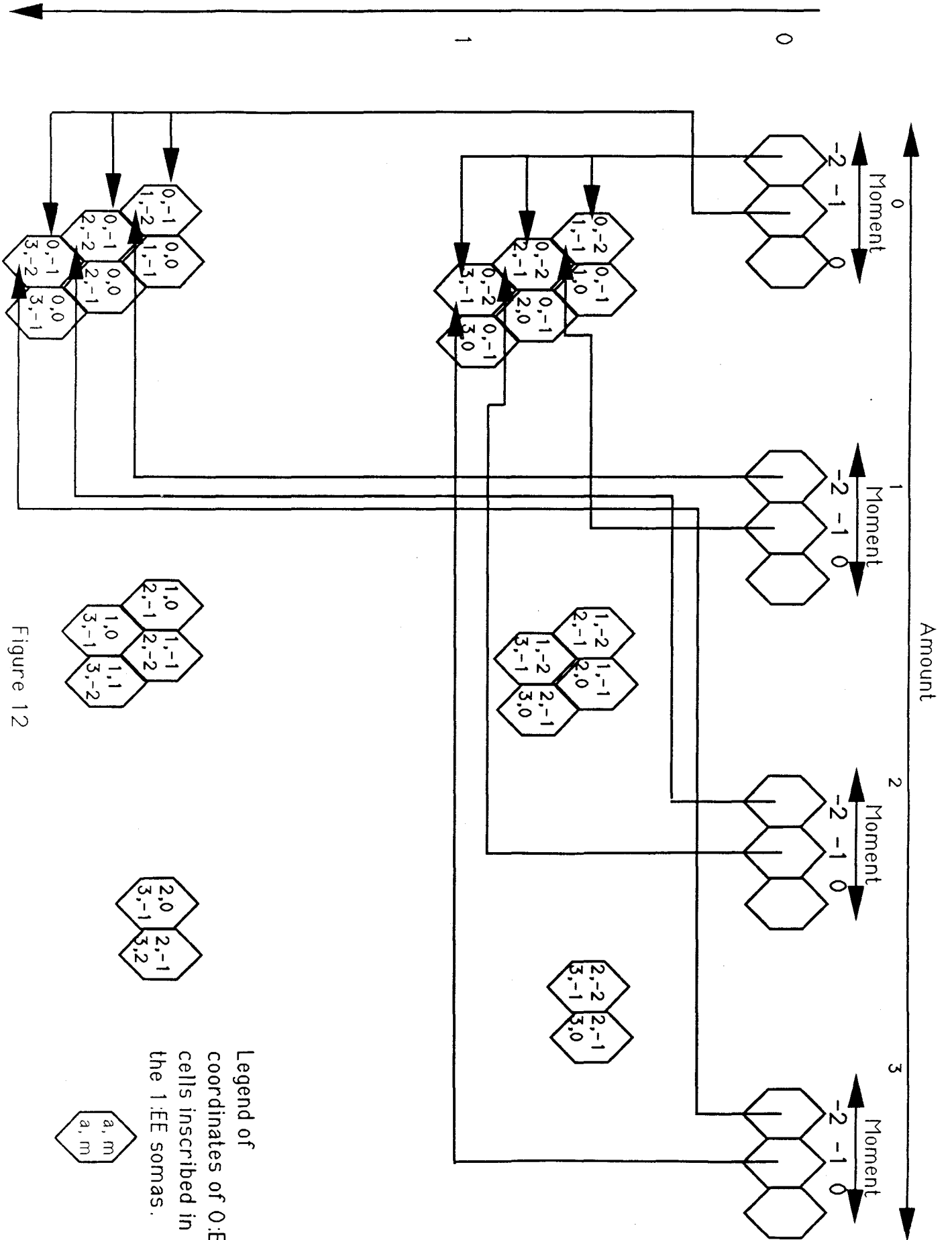

Figure 11

Epistemic Entity



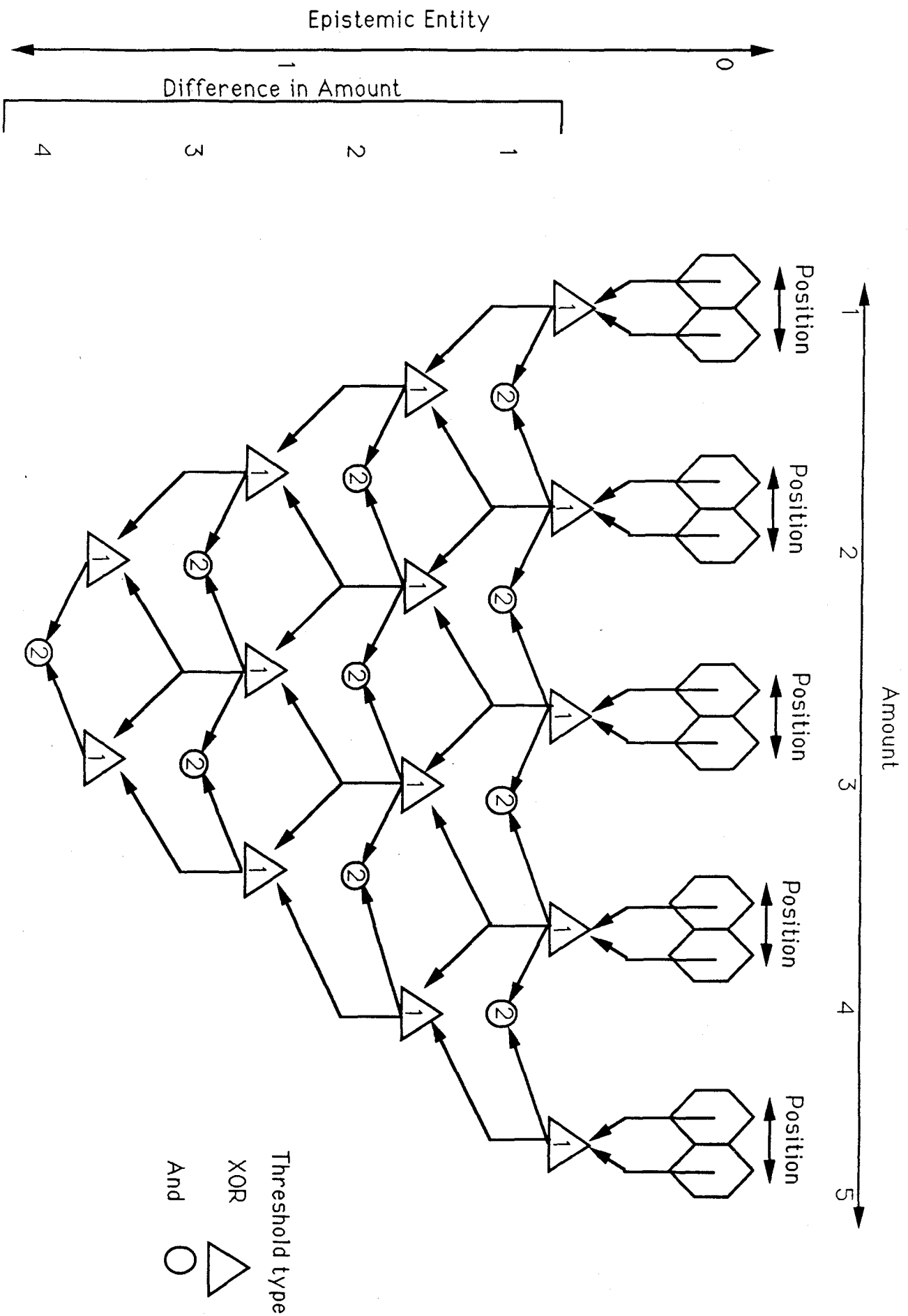

Figure 13