

# **M9500 Patient Monitor**

## **User's Manual**

### **Guangdong Biolight Meditech Co., Ltd.**

Address: Innovation First Road, Technology Innovation Coast, Jinding, Zhuhai, P.R.CHINA

Tel: +86-756-3399900

Fax: +86-756-3399989

<http://www.blt.com.cn>

**J/M9500-A004-2008A1**

## **Preface**

Thank you for using M9500 patient monitor.

In order to enable you to skillfully operate Monitor as soon as possible, we provide this user's manual with delivery. When you install and use this instrument for the first time, it is imperative that you read carefully all the information that accompanies this instrument.

Based on the need to improve the performance and reliability of the parts and the whole instrument, we sometimes will make some amendments to the instrument (including the hardware and software). As a result, there might be cases of discrepancies between the manual and the actual situation of products. When such discrepancies occur, we will try our best to amend or add materials. Your comments and suggestions are welcome.

## **Contact Information**

Address: Innovation First Road, Technology Innovation Coast, Jinding, Zhuhai, P.R.CHINA

Tel: +86-756-3399900

Fax: +86-756-3399989

Post code: 519085

Toll-free consultation hot line: +86-800-830-1016

## **Statement**

This manual contains exclusive information protected by copyright laws and we reserve its copyright. Without written approval of manufacturer no parts of this manual shall be photocopied, Xeroxed or translated into other languages.

The contents and version contained in this manual are subject to amendments without notification.

The version number of this manual: A1

## **Manufacturer's Responsibility**

Only under the following circumstances will manufacturer be responsible for the safety, reliability and performance of the instrument.

⇒ All the installation, expansion, readjustment, renovation or repairs are conducted by the personnel certified by manufacturer.

⇒ The electrical safety status at the installation site of the instrument conforms to the national standards.

⇒ The instrument is used in accordance with the operation procedures.

## **CE mark**



### **EC Representative Name:**

Shanghai International Holding Corp GmbH (Europe)

### **EC Representative Address:**

Eiffestrasse 80 D-20537 Hamburg Germany

**Copyright reserved © 2008 Guangdong Biolight Meditech Co., Ltd.**

# Contents

<b>Chapter 1 General Introduction .....</b>	<b>1-1</b>
<b>1.1 Intended Use .....</b>	<b>1-1</b>
<b>1.2 About this Manual.....</b>	<b>1-1</b>
<b>1.3 Brief Introduction to the Monitor .....</b>	<b>1-3</b>
<b>1.4 Appearance and Structure of the Monitor.....</b>	<b>1-4</b>
<b>Chapter 2 Important Safety Notes .....</b>	<b>2-1</b>
<b>2.1 General Safety .....</b>	<b>2-1</b>
<b>2.2 Some Important Notes for Safety .....</b>	<b>2-3</b>
<b>2.3 Classifications.....</b>	<b>2-5</b>
<b>2.4 Safe Operating and Handling Conditions.....</b>	<b>2-6</b>
<b>Chapter 3 Preparations Before the Use of the Monitor .....</b>	<b>3-1</b>
<b>3.1 Unpacking and Checking .....</b>	<b>3-1</b>
<b>3.2 Connecting to Power.....</b>	<b>3-1</b>
<b>3.3 Connecting to the Central Monitor System.....</b>	<b>3-3</b>
<b>3.4 Starting the Monitor .....</b>	<b>3-4</b>
<b>3.5 Connecting to Various Kinds of Sensors.....</b>	<b>3-4</b>
<b>3.6 Preparation of Recorder.....</b>	<b>3-4</b>
<b>3.7 Shutting off the Monitor.....</b>	<b>3-5</b>
<b>Chapter 4 Operation Instructions for the Monitor .....</b>	<b>4-1</b>
<b>4.1 Screen Mode .....</b>	<b>4-1</b>
<b>4.2 Main Menu .....</b>	<b>4-5</b>
<b>4.3 Screen Display .....</b>	<b>4-31</b>
<b>Chapter 5 Parameters Measurement.....</b>	<b>5-1</b>
<b>5.1 Measurement of ECG/HR.....</b>	<b>5-1</b>
<b>5.2 Measurement of RESP.....</b>	<b>5-13</b>
<b>5.3 Measurement of SpO<sub>2</sub>/Pulse.....</b>	<b>5-15</b>
<b>5.4 Measurement of TEMP .....</b>	<b>5-19</b>
<b>5.5 Measurement of NIBP .....</b>	<b>5-22</b>
<b>5.6 Measurement of IBP .....</b>	<b>5-29</b>
<b>5.7 Measurement of CO<sub>2</sub> (Sidestream, CPT).....</b>	<b>5-35</b>
<b>5.8 Measurement of CO<sub>2</sub> (Mainstream, IRMA).....</b>	<b>5-42</b>
<b>5.9 Measurement of CO<sub>2</sub> (Microstream, LoFlo).....</b>	<b>5-46</b>

5.10 Measurement of CO2(Mainstream, CAPNOSTAT5).....	5-54
5.11 Measurement of AG(IRMA) .....	5-58
<b>Chapter 6 Alarm .....</b>	<b>6-1</b>
6.1 Alarm Category and level.....	6-1
6.2 Alarm Modes .....	6-1
6.3 Alarm Setup.....	6-3
6.4 Alarm Cause .....	6-5
6.5 Silence/Suspension .....	6-5
6.6 Parameter Alarm.....	6-6
6.7 When an Alarm Occurs .....	6-7
6.8 Alarm Description and Prompt .....	6-7
<b>Chapter 7 Recording .....</b>	<b>7-1</b>
<b>Chapter 8 Other Functions.....</b>	<b>8-1</b>
8.1 Nurse Call .....	8-1
8.2 Analog Signal Output .....	8-2
8.3 SD Card Storage.....	8-2
<b>Chapter 9 Maintenance and Cleaning.....</b>	<b>9-1</b>
9.1 System Check .....	9-1
9.2 Battery Maintenance .....	9-2
9.3 General Cleaning .....	9-3
9.4 Cleaning Agents.....	9-4
9.5 Disinfection .....	9-4
<b>Chapter 10 Accessories.....</b>	<b>10-1</b>
<b>Appendix A Product Specifications.....</b>	<b>1</b>
A.1 Environmental Specifications .....	1
A.2 Hardware Specifications.....	1
A.3 Measurement Specifications.....	3
<b>Appendix B Default System Setup .....</b>	<b>13</b>
B.1 System.....	13
B.2 Alarm Limit .....	16
<b>Appendix C EMC .....</b>	<b>19</b>

# Chapter 1 General Introduction

## 1.1 Intended Use

The Monitor is used to monitor patient's physiological parameters such as ECG, RESP, SpO<sub>2</sub>, NIBP, IBP, TEMP, EtCO<sub>2</sub> and AG continuously. It is intended to be used in various hospital rooms such as Coronary Care Unit, Intensive Care Unit, Neonatal Intensive Care Unit and Operating Room to provide additional information to medical and nursing staff about the physiological condition of the patient.

It is not intended to be used in outdoor transport applications and used on neonate when using IRMA mainstream EtCO<sub>2</sub> and AG monitoring.

## 1.2 About this Manual

This manual contains the instructions necessary to operate the product safely and in accordance with its function and intended use. Observance of this manual is a prerequisite for proper product performance and correct operation and ensures patient and operator safety.

This manual is based on the maximum configuration and therefore some contents may not apply to your product. If you have any question, please contact us.

This manual is an integral part of the product. It should always be kept close to the equipment so that it can be obtained conveniently when needed.

The manual is geared for clinical professionals who are expected to have a working knowledge of medical procedures, practiced and terminology as required for monitoring patients.

All illustrations in this manual serve as examples only. They may not necessarily reflect the setup or data displayed on your product.

Signs in this manual:



**Warning:** Means it must be strictly followed so as to prevent the operator or the patient from being harmed.



**Caution:** Means it must be followed so as not to damage the instrument.



**Note:** Important information or indications regarding the operation or use.



**Warning:**

- Before putting the system into operation, verify that the equipment, connecting cables and accessories are in correct working order and operating condition.
  - To avoid explosion hazard, do not use the equipment in the presence of flammable anesthetics, vapors or liquids.
  - Do not open the equipment housings; electric shock hazard may exist. All servicing and future upgrades must be carried out by the personnel trained and authorized by manufacturer only.
  - When using the equipment with electrosurgical units (ESU), make sure the patient is safe.
  - Do not come into contact with the patient during defibrillation. Otherwise serious injury or death could result.
  - Do not rely exclusively on the audible alarm system for patient monitoring. Adjustment of alarm volume to a low level or off may result in a hazard to the patient. Remember that alarm settings should be customized according to different patient situations and always keeping the patient under close surveillance is the most reliable way for safe patient monitoring.
  - The physiological data and alarm messages displayed on the equipment are for reference only and cannot be directly used for diagnostic interpretation.
  - To avoid inadvertent disconnection, route all cables in a way to prevent a stumbling hazard. Wrap and secure excess cabling to avoid risk of entanglement or strangulation by patient or personnel.
- 



**Caution:**

- To ensure patient safety, use only parts and accessories specified in this manual.
- At the end of its service life, the equipment, as well as its accessories, must be disposed of in compliance with the guidelines regulating the disposal of such products. If you have any questions concerning disposal of the equipment, please contact us.
- Magnetic and electrical fields are capable of interfering with the proper performance of the equipment. For this reason make sure that all external devices operated in the vicinity of the equipment comply with the relevant EMC requirements. Mobile phone, X-ray equipment or MRI devices are a possible source of interference as they may emit higher levels of electromagnetic radiation.
- Before connecting the equipment to the power line, check that the voltage and frequency ratings of the power line are the same as those indicated on the

**equipment's label or in this manual.**

- **Always install or carry the equipment properly to avoid damage caused by drop, impact, strong vibration or other mechanical force.**
- 

### **1.3 Brief Introduction to the Monitor**

The monitor has features as follows:

- ≡ Multiple measuring functions include 3-lead, 7-lead, 12-lead ECG/HR, RESP, dual TEMP, SpO<sub>2</sub>/Pulse, NIBP, dual IBP, EtCO<sub>2</sub> and AG are optional.
- ≡ Complete built-in module design ensures stable and reliable performance
- ≡ Unique all-lead ECG on-one-screen display, which can facilitate the diagnosis and analysis of cardiac disease
- ≡ Can store the trend data for 168 hours and has the function of displaying trend data and trend graphs
- ≡ Function of alarm event reviewing, can store 1800 pieces of alarm events
- ≡ Function of NIBP measurement reviewing, can store 1000 pieces of NIBP measurement data
- ≡ Function of reviewing 30 minutes one important lead's EGC waveform
- ≡ Built-in recorder is optional and it supports real-time recording, trigger printout by alarm
- ≡ Parameter display with big character
- ≡ Optional function of Calculator of drug concentration
- ≡ Optional function of Display of oxyCRG
- ≡ Function of Display of short trend
- ≡ 15" authentic color high brightness TFT LCD monitor
- ≡ Portable design, stylish and convenient
- ≡ Rechargeable maintenance-free battery, can continue working when AC power is off
- ≡ Nurse call function guarantee patient alarm draws enough attention
- ≡ Can be connected with the central unit to realize centralized monitoring
- ≡ Is resistant to high-frequency electrotome and is protected against defibrillation effects



## 1.4 Appearance and Structure of the Monitor

### 1.4.1 Front View

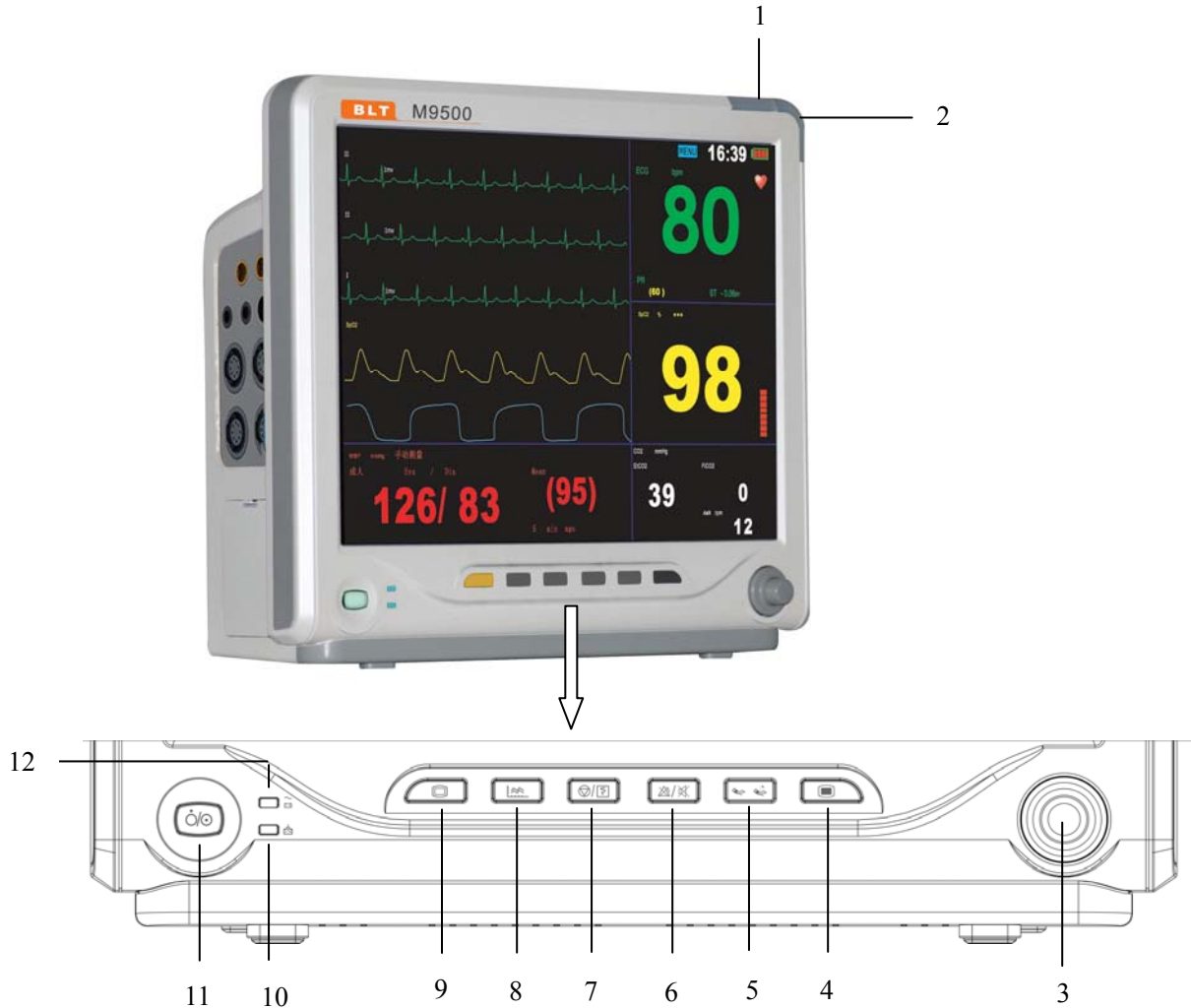







1. Physiological alarm indicating lamp
2. Technical alarm indicating lamp
3. Trim Knob

The Trim Knob is used for:

Turn left or turn right to move the cursor.

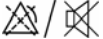
Press down to perform an operation, such as open the menu dialog or select one option.

4.  Press this button once to open the main menu dialog.
5.  Press this button in 2 seconds to start or stop the NIBP measurement. Press and hold this button for 2 seconds to make NIBP module working at STAT measurement mode and perform continuous NIBP measurement within 5 minutes.

6.  Press this button in 2 seconds to make the monitor alarm paused or cancel the pause. Press and hold this button for 2 seconds can silence the monitor's audio system or cancel the silence. When the nurse call function is enabled, pressing this button can cancel the current nurse call alarm.
7.  Press this button in 2 seconds to freeze waveform, press again to defreeze waveform. Press and hold this button for 2 seconds can start real-time recording. In case the real-time recording is underway, pressing this button will terminate real-time recording.
8.  Press this button once to see the Trend Graph and the Trend Table.
9.  Press this button once to exit the present menu and return to main screen.
10. Battery charging indicating lamp  
It is illuminated when the battery is being charged.  
It is go out when the battery is fully charged or no battery in monitor
11.  Power button
12. Power indicating lamp  
It is illuminated green when the AC power is connected.  
It is illuminated orange when the AC power is not connected and monitor is powered by battery.  
It is turned out when the AC power is not connected.

### 1.4.2 Left View

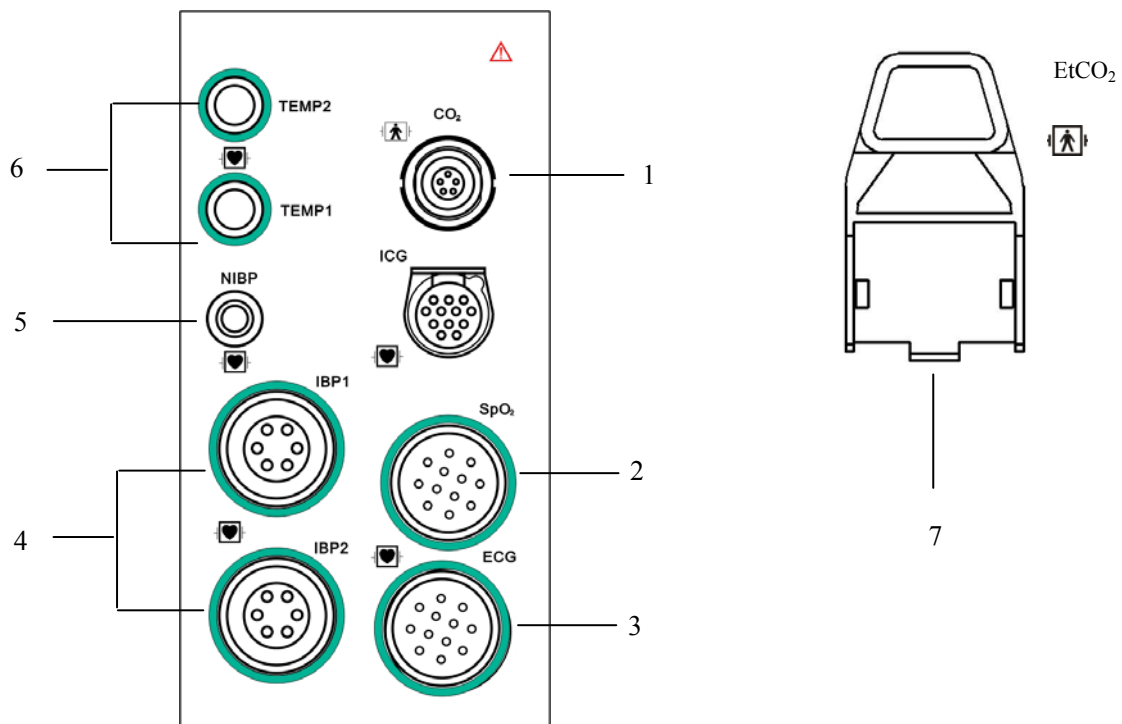

1. CO<sub>2</sub>/AG socket
2. SpO<sub>2</sub> socket
3. ECG socket
4. IBP socket (IBP1 and IBP2)
5. NIBP cuff connector
6. TEMP socket (TEMP1 and TEMP2)
7. Receptacle for Dehydration flask

### 1.4.3 Rear View

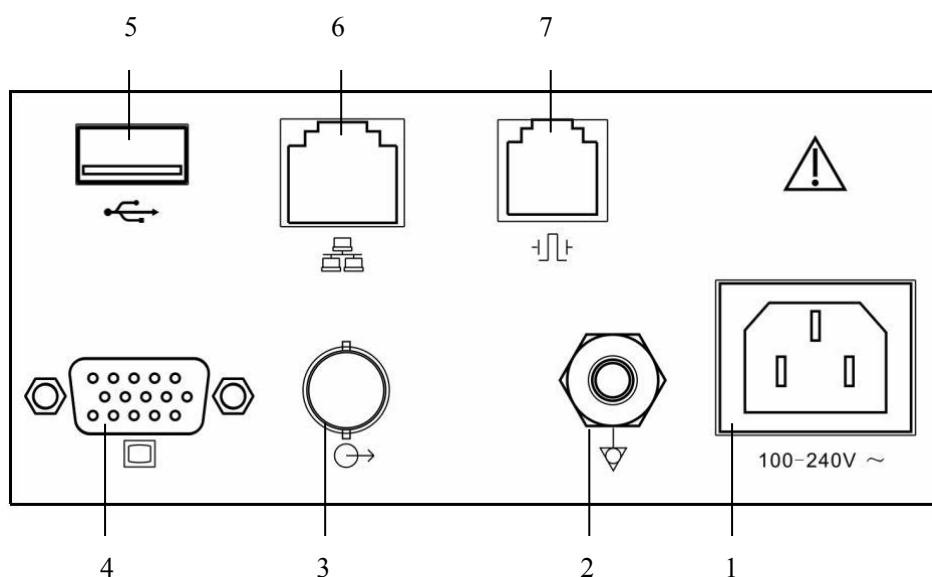

1. AC input socket
2. Potential equalization conductor terminal
 

Base on the requirements of safety and anti-interference, the monitor must be connected with potential equalization system individual. Connect the Potential equalization conductor terminal to the potential equalization system with the green and yellow potential equalization cable. If the protection earth system is damaged, the potential equalization system can take on the safety function of protection earth conductor.
3. Auxiliary output connector
 

Connect to the device, such as oscillograph to output analog signals. It also can be connected to nurse call system in hospital. When an alarm occurs, outputting the nurse call signal to remind nurse.
4. Secondary display socket
 

Connect to standard VGA display for secondary displaying.
5. USB socket
 

Connect to USB device.

6. Network connector

Standard RJ45 socket. It is used for connection with the central monitoring system provided by manufacturer.

---

**!** **Caution:** The AC input socket at the back panel of the monitor can be connected with 100-240V AC power by electrical wires supplied with this instrument.

---



---

**👉** **Note:** The Network Connector is a standard RJ45 socket and being used for connection with the central monitoring system provided by manufacturer.

---















---

**💣** **Warning:** The sensor cable sockets on Monitor can only be connected with the sensor cables supplied with this instrument and no other cables shall be used.

---

1.4.4 Notes on the signs on the monitor

Signs	Notes on the signs
	Type CF applied part, defibrillation protected The unit displaying this symbol contains an F-Type isolated (floating) applied part providing a high degree of protection against shock, and is defibrillator-proof.
	Type BF applied part, defibrillation protected The unit displaying this symbol contains an F-Type isolated (floating) applied part providing a high degree of protection against shock, and is defibrillator-proof.
	Attention: Consult accompanying documents (this manual).
	Non-ionizing radiation
	Dangerous voltage
	Equipotentiality
	Alternating current (AC)

Signs	Notes on the signs
	USB socket
	Network connector
	Secondary display socket
	Auxiliary output connector
	CE mark
	<p>Symbol for the marking of electrical and electronics devices according to Directive 2002/96/EC.</p> <p>The device, accessories and the packaging have to be disposed of waste correctly at the end of the usage. Please follow local ordinances or regulations for disposal.</p>
<b>ECG</b>	Short for “Electrocardiogram”
<b>RESP</b>	Short for “Respiration”
<b>SpO<sub>2</sub></b>	Short for “Pulse Oxygen Saturation”
<b>TEMP</b>	Short for “Temperature”
<b>IBP</b>	Short for “Invasive Blood Pressure”
<b>NIBP</b>	Short for “Non-invasive Blood Pressure”
<b>EtCO<sub>2</sub></b>	Short for “End tidal carbon dioxide”
<b>AG</b>	Short for “Anesthetic gas”

## Chapter 2 Important Safety Notes

---

 **Warning:** For pacemaker patients, Rate meters may continue to count the pacemaker rate during occurrences of cardiac arrest or some arrhythmias. Do not rely entirely upon rate meter alarms. Keep pacemaker patients under close surveillance. See this manual for disclosure of the pacemaker pulse rejection capability of this instrument.

---

 **Warning:** Only trained doctors and nurses can use the device.

---

 **Warning:** The monitor is neither a therapeutic instrument nor a device that can be used at home.

---

### 2.1 General Safety

#### 1. Safety precautions for safe installation

- ⇒ The input socket of monitor can be connected to the electrical wires and common electrical wire can be used.
- ⇒ Only the power supply type of AC 100-240V 50/60Hz specified by monitor can be used.
- ⇒ Connect the electrical wire to a properly grounded socket. Avoid putting the socket used for it in the same loop of such devices as the air conditioners, which regularly switch between ON and OFF.
- ⇒ Avoid putting the monitor in the locations where it easily shakes or wobbles.
- ⇒ Enough space shall be left around the monitor so as to guarantee normal ventilation.
- ⇒ Make sure the ambient temperature and humidity are stable and avoid the occurrence of condensation in the work process of the monitor.

---

 **Warning:** Never install the monitor in an environment where flammable anesthetic gas is present.

---

2. Monitor conforms to the safety requirements of IEC 60601-1:1995. This monitor is protected against defibrillation effects.

### 3. Notes on signs related to safety



Type CF applied part, defibrillation protected

The unit displaying this symbol contains an F-Type isolated (floating) applied part providing a high degree of protection against shock, and is defibrillator-proof.

The type CF applied parts provide a higher degree of protection against electric shock than that provided by type BF applied parts.



Attention! Please refer to the documents accompanying this monitor (this manual)!



Type BF applied part, defibrillation protected

The unit displaying this symbol contains an F-Type isolated (floating) applied part providing a high degree of protection against shock, and is defibrillator-proof.

4. When a defibrillator is applied on a patient, the monitor may have transient disorders in the display of waveforms. If the electrodes are used and placed properly, the display of the monitor will be restored within 10 seconds. During defibrillation, please note to remove the electrode of chest lead and move the electrode of limb lead to the side of the limb. The electrode of the defibrillator should not come into direct contact with the monitoring electrodes. Please ensure the monitor is reliably grounded and the electrodes used repeatedly should be kept clean.



**Warning: When conducting defibrillation, do not come into contact with the patient, the bed and the monitor. Otherwise serious injury or death could be resulted in.**

---

5. To guarantee the safe operation of the monitor, Monitor is provided with various replaceable parts, accessories and consuming materials (such as sensors and their cables, electrode pads). Please use the products provided or designated by the manufacturer.

6. Monitor only guarantees its safety and accuracy under the condition that it is connected to the devices provided or designated by manufacturer. If the monitor is connected to other undesignated electrical equipment or devices, safety hazards may occur for causes such as the cumulating of the leakage current.

7. To guarantee the normal and safe operation of the monitor, a preventive check and maintenance should be conducted for the monitor and its parts every 6-12 months

(including performance check and safety check) to verify the instrument can work in a safe and proper condition and it is safe to the medical personnel and the patient and has met the accuracy required by clinical use.

---

**!** **Caution: The monitor does not contain any parts for self-repair by users. The repair of the instrument must be conducted by the technical personnel been authorized by manufacturer.**

---

## **2.2 Some Important Notes for Safety**

### **PATIENT NUMBER**

The monitor can only be applied to one patient at one time.

### **INTERFERENCE**

Do not use cellular phone in the vicinity of this equipment. High level of electromagnetic radiation emitted from such devices may result in strong interference with the monitor performance.

### **ACCIDENTAL SPILLS**

To avoid electric shock or device malfunction, liquids must not be allowed to enter the device. If liquids have entered the device, take it out of service and have it checked by a service technician before it is used again.

### **ACCURACY**

If the accuracy of any value displayed on the monitor or printed on a printout paper is questionable, determine the patient's vital signs by alternative means. Verify that all equipment is working correctly.

### **ALARMS**

Do not rely exclusively on the audible alarm system for patient monitoring. Adjustment of alarm volume to a low level or off during patient monitoring may result in a hazard to the patient. Remember that the most reliable method of patient monitoring combines close personal surveillance and correct operation of monitoring equipment.

The functions of the alarm system for monitoring the patient must be verified at regular intervals.

### **BEFORE USE**



Before putting the system into operation, please visually inspect all connecting cables for signs of damage. Damaged cables and connectors must be replaced immediately.

Before using the system, the operator must verify that it is in correct working order and operating condition.

Periodically, and whenever the integrity of the product is in doubt, test all functions.

## **CABLES**

Route all cables away from patient's throat to avoid possible strangulation.

## **TO CLEAR PATIENT DATA**

When monitoring a new patient, you must clear all previous patient data from the system. To accomplish this, shut down the device, and then turn on it. Selecting 〈New patient〉 in 〈main setup〉 menu can also clear the previous patient data.

## **DISPOSAL OF PACKAGE**

Dispose of the packaging material, please observe the applicable waste control regulations and keeping it out of children's reach.

## **EXPLOSION HAZARD**

Do not use this equipment in the presence of flammable anesthetics, vapors or liquids.

## **LEAKAGE CURRENT TEST**

When interfacing with other equipment, a test for leakage current must be performed by qualified biomedical engineering personnel before using with patients.

## **BATTERY POWER**

The device is equipped with a battery pack. The battery discharges even when the device is not in use. Store the device with a fully charged battery and take out the battery, so that the service life of the battery will not be shortened.

## **DISPOSAL OF ACCESSORIES AND DEVICE**

Disposable devices are intended for single use only. They should not be reused as performance could degrade or contamination could occur.

The service life of this monitor is five years. At the end of its service life, the product described in this manual, as well as its accessories, must be disposed of in compliance with the guidelines regulating the disposal of such products. If you have questions concerning disposal of products, please contact manufacturer or its representatives.

**EMC**

Magnetic and electrical fields are capable of interfering with the proper performance of the device. For this reason, make sure that all external devices operated in the vicinity of the monitor comply with the relevant EMC requirements. X-ray equipment or MRI devices are a possible source of interference as they may emit higher levels of electromagnetic radiation. Also, keep cellular phones or other telecommunication equipment away from the monitor.

**INSTRUCTION FOR USE**

For continuous safe use of this equipment, it is necessary that listed instructions were followed. However, instructions listed in this manual in no way can supersede established medical practices concerning patient care.

**LOSS OF DATA**

Should the monitor at any time temporarily lose patient data, close patient observation or alternative monitoring devices should be used until monitor function is restored.

If the monitor does not automatically resume operation within 60 seconds, restart the monitor using the power on/off switch. Once monitoring is restored, you should verify correct monitoring state and alarm function.

**2.3 Classifications**

The Monitor is classified, according to IEC 60601-1:1995 as:

Type of protection against electric shock:	I
Degree of protection against electric shock:	BF: EtCO <sub>2</sub> , AG CF: ECG, RESP, TEMP, IBP, NIBP, SpO <sub>2</sub>
Degree of protection against harmful ingress of water:	Ordinary Equipment (enclosed equipment without protection against ingress of water)
Degree of safety of application in the presence of a flammable anesthetic-mixture with air or with oxygen or nitrous oxide:	Not suitable
Mode of operation:	Continuous operation

**I:** Class I equipment

**BF:** Type BF applied part

**CF:** Type CF applied part

**Not suitable:** Equipment is not suitable for use in the presence of flammable anesthetic mixture with air or with oxygen or nitrous oxide.

## 2.4 Safe Operating and Handling Conditions

Method(s) of sterilization or disinfection recommended by the manufacturer:	Sterilization: not applicable Disinfection: See "Maintenance and Cleaning ->General Cleaning"
Electromagnetic interference	No cellular telephone nearby
Electro surgical interference damage	No damage
Diathermy instruments influence	Displayed values and prints may be disturbed or erroneous during diathermy
Defibrillation shocks	The monitor specifications fulfill the requirements of IEC 60601-1, IEC 60601-2-27, IEC 60601-2-49, IEC 60601-2-34
Auxiliary outputs	The system must fulfill the requirements of standard IEC 60601-1-1

## Chapter 3 Preparations Before the Use of the Monitor

### 3.1 Unpacking and Checking

- ⇒ Unpack the package

Open the package, accessories include: electrical wire, various patient sensors and user's manual (this manual), warranty card, certificate and particular paper and the lower foam case contains the monitor.

- ⇒ Remove the monitor and accessories

---

**!** **Caution: Please place the monitor on level and stable supporting plane, not on the places that can easily shock or wake. Enough room should be left around the monitor so as to guarantee normal ventilation.**

---

- ⇒ Keep all the packaging materials for future use in transportation or storage.
- ⇒ Check the monitor and accessories

Check the monitor and its accessories one by one in accordance with the particular paper. Check to see if the parts have any mechanical damages. In case of problems, please contact us or our agent.

### 3.2 Connecting to Power

#### 3.2.1 AC Power

- ⇒ Confirm the rated AC current is: AC 100-240V 50/60Hz
- ⇒ Use the electrical wires provided along with the instrument, put its output end plug (round headed) into the AC current socket on the back of the monitor, and the plug of input end into a grounded socket of the mains (It must be a special socket of the hospital), connect the monitor through the earth one of electrical wires.
- ⇒ When the indicating light above the power switch on the panel of the monitor is green, it means the AC power is on. And when the monitor is not connected to AC power and the DC battery is used as the power source, the indicating light is orange.

---

**!** **Warning: The monitor must be connected to a properly installed power outlet with protective earth contacts only. If the installation does not provide for a protective earth conductor, disconnect the monitor from the power line and operate it on battery power.**



---

---

 **Note:** The equipment has no mains switch. The equipment is switched completely only by disconnecting the power supply from the wall socket. The wall socket has to be easily accessible.

---

---

 **Note:** For measurements in or near the heart we recommend connecting the monitor to the potential equalization system. Use the green/yellow potential equalization cable and connect it to the pin labeled with the  symbol.

---

### 3.2.2 Battery Power

The monitor has a battery pack to provide power to the monitor whenever AC power is interrupted. The battery is generally referred to as the “battery”.

You must charge the battery before using it. There is no external charger. The battery is charged when the monitor is connected to AC power. To assure a fully charged battery that is ready for use, we recommend that the monitor be plugged into AC power whenever it is not in use.

Run time of the batteries is according to the usage and configuration of monitor. NIBP and SpO<sub>2</sub> monitoring and the usage of the recorder will drain battery power faster than other parameters.

---

 **Note:** When the monitor is connected to AC power, the battery is in a state of being recharged. When it is unable to be connected to the AC power, the battery can be used to supply power, and at this time it is unnecessary to use the electrical wires, and the instrument can be switched on directly.

---

---

 **Note:** A “Battery Low” message displaying at the technical alarm information area of screen and an audible system alarm indicate approximate 5 minutes of battery life remaining. You should connect the monitor to an AC power source when the message is displayed.

---

---

 **Note:** This monitor contains a rechargeable battery. The average life span of this type of battery is approximately three years. When replacement becomes necessary, contact a qualified service representative to perform the replacement.

---

 **Disposal Note:** Should this product become damaged beyond repair, or for some reason its service life is considered to be at an end, please observe all local, state, and federal regulations that relate to the disposal of products that contain lead, batteries, plastics, etc.

---

#### ■ Install Battery

The battery storage is located at the bottom of the monitor, following the steps to install a battery.

- 1、 Open the battery gate according to the direction marked on the monitor.
- 2、 Turn the baffle up clockwise.
- 3、 Push the battery into the gate with the electrode point to the bottom of the monitor.
- 4、 After pushing the battery inside the storage withdraw, the baffle turn back to the middle position.
- 5、 Close the gate.

#### ■ Uninstall battery

- 1、 Open the battery gate according to the direction marked on the monitor.
- 2、 Turn the baffle up clockwise.
- 3、 Take out the battery. Then close the gate.

### 3.3 Connecting to the Central Monitor System

---

 **Warning:** Accessory equipment connected to the analog and digital interface must be certified according to the respective IEC standards (e.g. IEC 60950 for data processing equipment and IEC 60601-1:1995 for medical equipment). Furthermore all configurations shall comply with the valid version of the system standard IEC 60601-1-1. Everybody who connects additional equipment to the signal input part or signal output part configures a medical system, and is therefore responsible that the system complies with the requirements of the valid version of the system standard IEC 60601-1-1. If in doubt, consult the technical service department or your local representative.

---

If the user intends to connect the monitor to the central monitoring system, plug its connecting electrical cable into the Network Connector at the back of the monitor.



**Note:** This monitor can only be connected to the central monitoring system provided by manufacturer, do not attempt to connect this monitor to other central monitoring system.

---

### 3.4 Starting the Monitor

- ⇒ Press the power button. The alarm indicating lamps flash, and then go out. The system gives a beep and displays the startup screen.
- ⇒ The startup screen disappears and the monitor enters the main screen.



**Warning:** In case the monitor is found to be working abnormally or indication of errors appears, please do not use this monitor for monitoring and should contact the after-sale service center as soon as possible.

---

### 3.5 Connecting to Various Kinds of Sensors

Connect sensor cables to the relevant sockets on the monitor and put sensors on the monitored locations on the body of the patient. Refer to the relevant content of **Chapter 5** for details.



**Warning:** For safety reasons, all connectors for patient cables and sensor leads (with the exception of temperature) are designed to prevent inadvertent disconnection, should someone pull on the leads. Do not route cables in a way that they may present a stumbling hazard. Do not install the monitor in a location where it may drop to the patient. All consoles and brackets used must have a raised edge at the front.

---

### 3.6 Preparation of Recorder

If the monitor you use has been provided with a recorder, before starting of monitoring please check if the recorder has had recording thermal paper installed. The thermal side (that is the smoother side) should face upwards and a small section should be pulled out onto the outlet of the paper (on the right panel of the monitor).

If record paper has been used up, following the steps to install recording paper.

1. Push down the switch to open recorder.
2. Install the paper with the thermal side upwards.
3. Close the recorder with a section of paper outside of the storage.

For detailed operation information, refer to Fig. 3-6-1



Fig. 3-6-1 Install Recording Paper

### 3.7 Shutting off the Monitor

Please follow these steps to shut off the monitor:

- Confirm that the patient monitoring is finished.
- Disconnect the cables and sensors from patient.
- Confirm that the monitoring data is stored or cleared.
- Press the power switch, then a dialog will pop up to ask you make sure the shut-off operation. Select “OK” to shut off the monitor. If the monitor can't be switched off normally, forced close the monitor by pressing and holding the power switch more than 5s. This may cause some damages to the device.



## Chapter 4 Operation Instructions for the Monitor

 **Note:** In each menu, press **<Previous>** to return to the previous menu and press the **<Main>** button to return to main screen. In all the dialogue windows, there is help info to indicate the current operation.

 **Note:** The monitor configuration is consist of standard and non-standard parameter configuration, and their operation methods are basically the same, the standard configuration includes 5-lead ECG, RESP, SpO<sub>2</sub>, Single TEMP and NIBP modules, and the non-standard parameter configuration includes Dual TEMP, IBP, CO<sub>2</sub> and AG modules.

### 4.1 Screen Mode

In the **<Select Screen>** of the **<Main Setup>** menu, 8 kinds of different screen display modes can be selected, namely: Standard, NIBP Review, Big Numerics, Short Trend, 7 leads, 12 leads, oxyCRG, Other Bed. They are respectively showed as follow:

#### 1) Standard

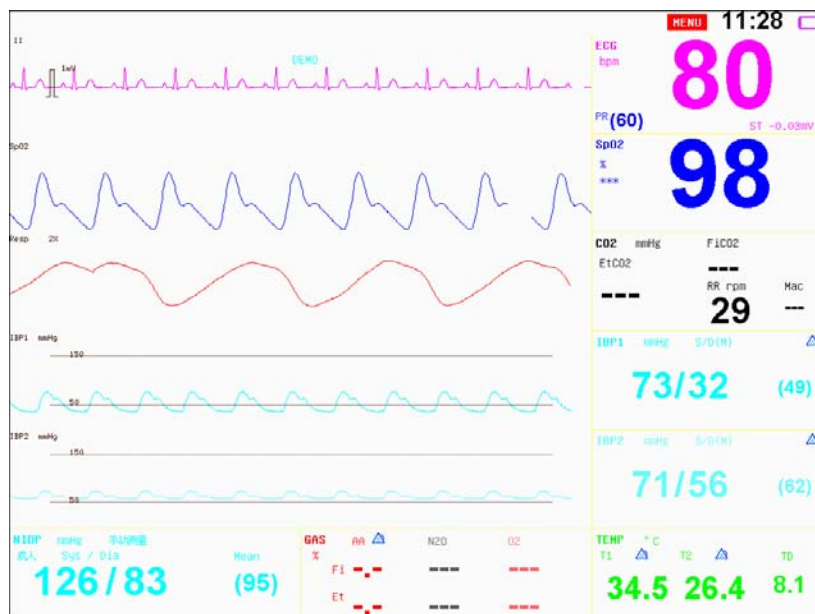

The ECG waveform of one lead is displayed on the uppermost region above the waveforms (this lead is called key monitoring lead and is set by the **<ECG1>** option in **<ECG>**), and the waveforms below are displayed differently according to different configurations.

## 2) NIBP Review

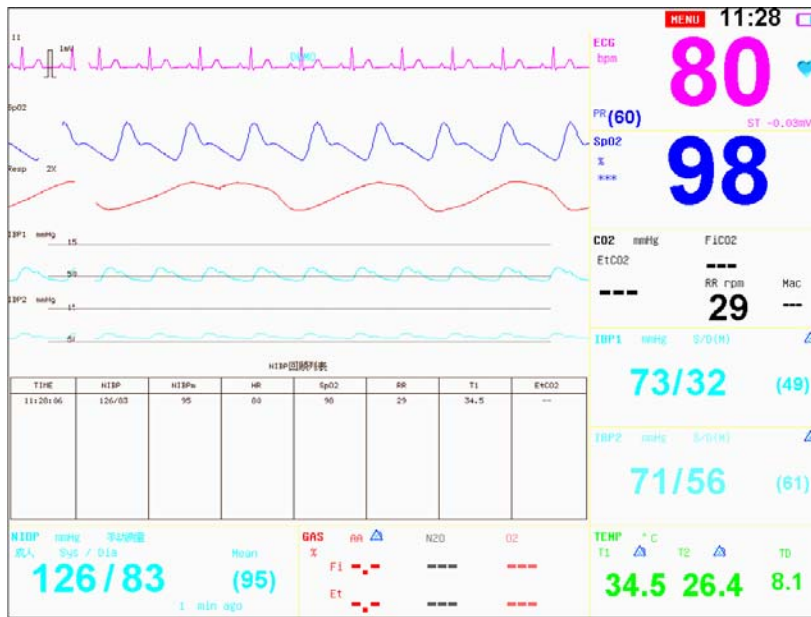

The recent groups of NIBP measurement results are displayed below the waveforms and the measurement records can be browsed by turning the trim knob.

## 3) Big Numerics

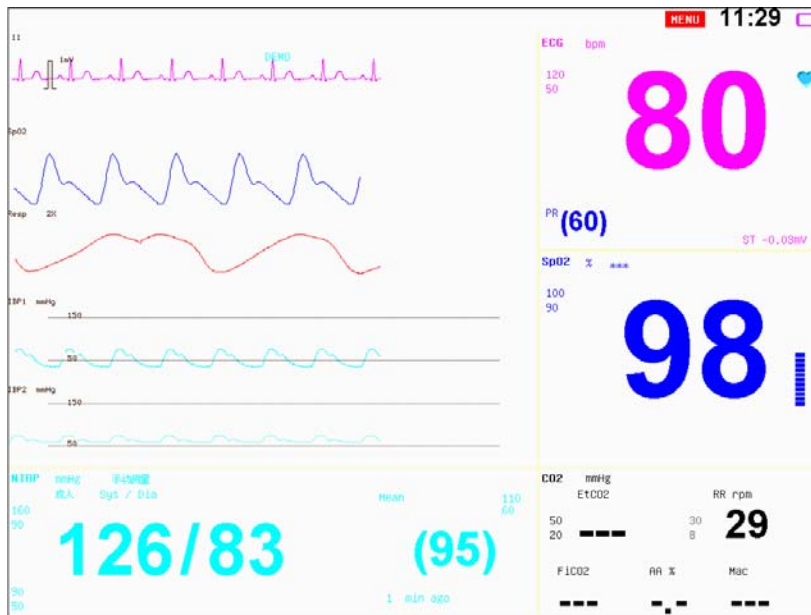

The main parameters are displayed in big font, e.g. HR, SpO<sub>2</sub>, NIBP, RESP and EtCO<sub>2</sub>.

#### 4) Short Trend

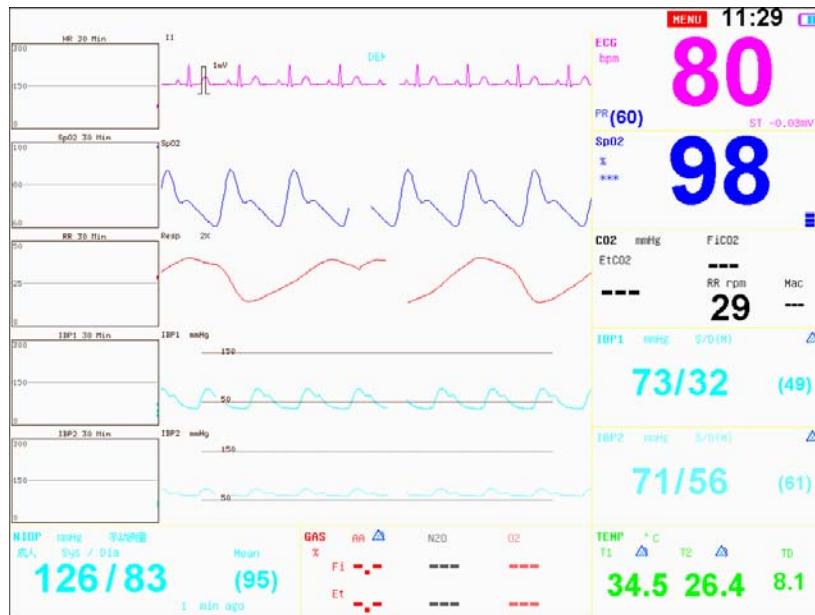

The short trend diagram relevant to the parameters is displayed on the upper-left corner of the waveform.

#### 5) 7-Leads

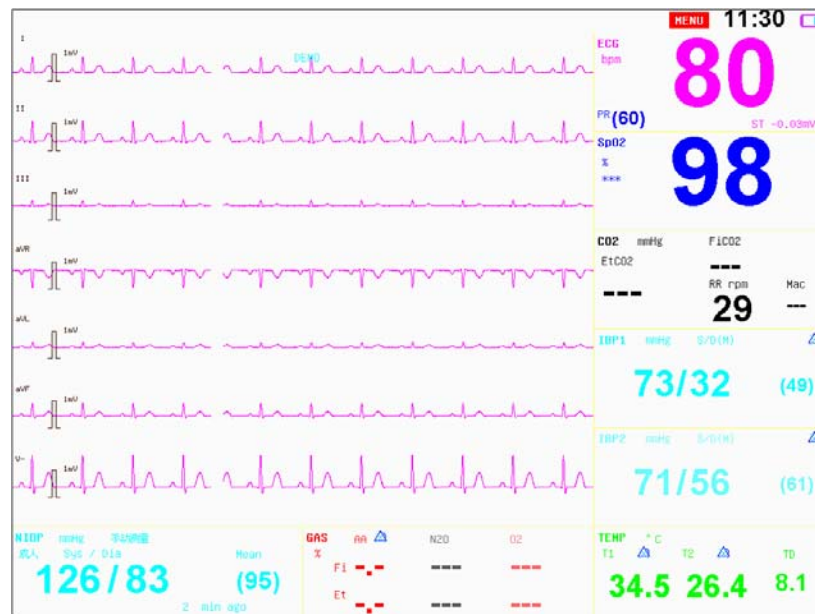

The ECG waveforms of 7-lead are displayed in the waveform display zone, they are I, II, III, aVR, aVL, aVF, and V- respectively.

6) 12-leads

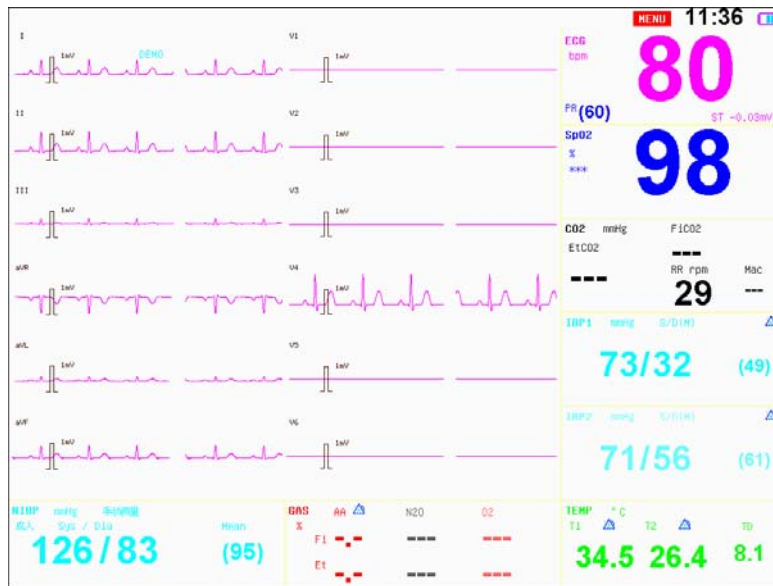

The 12-lead ECG waveforms are displayed in the waveform display zone, they are I, II, III, aVR, aVL, aVF, V1, V2, V3, V4, V5, V6.

In order to facilitate the diagnosis and analysis of heart disease, monitor is especially designed with displaying 12-lead (all-lead) ECG synchronously on screen. Select **<12 leads>** in the **<Select Screen>** of the **<Main Setup>** menu. The waveform is composed of left and right regions, and displayed in the left region are ECG waveforms of limb leads and on the right are the ECG waveforms of chest leads.

7) OxyCRG

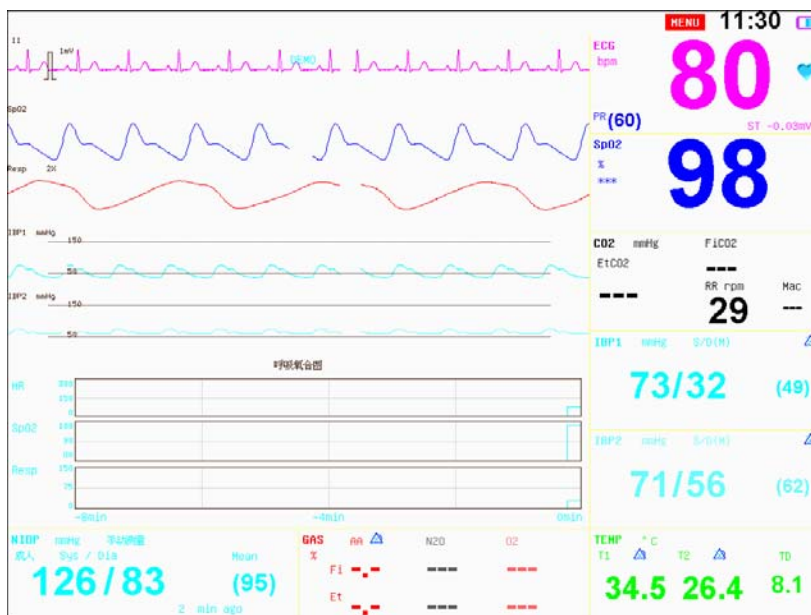

The trend diagrams of HR, SpO<sub>2</sub> and RESP within 8 minutes are displayed under the waveforms.

## 8) Other Bed

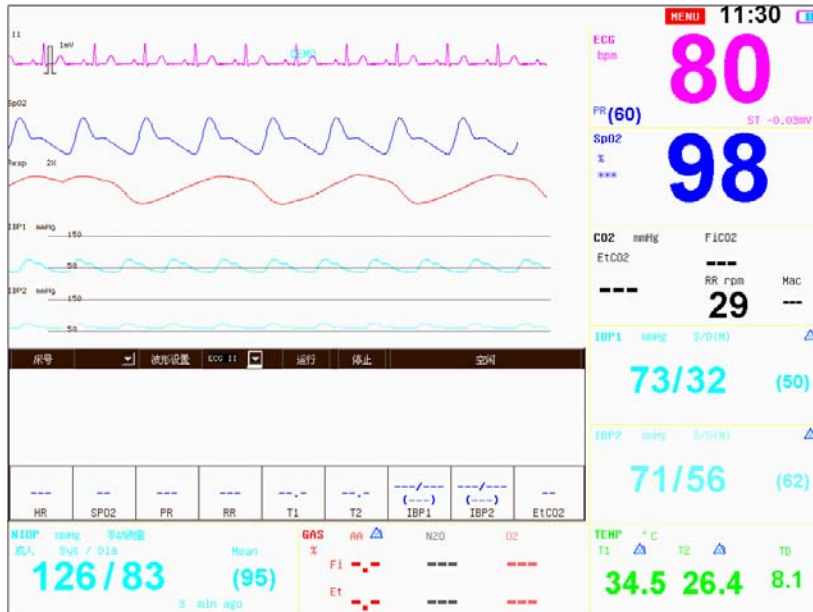

The info for other beds is showed below the waveforms, including one waveform and parts of parameters. Among them, through <Bed NO>, the number of online machine can be selected and through <Bed wave> the waveform display of other beds can be selected. Press <Run> to initiate monitoring of other beds, and press <Stop> to terminate the present monitoring of other beds. Switching from monitoring of other beds screen to other screens will automatically terminate the present monitoring of other beds.

## 4.2 Main Menu

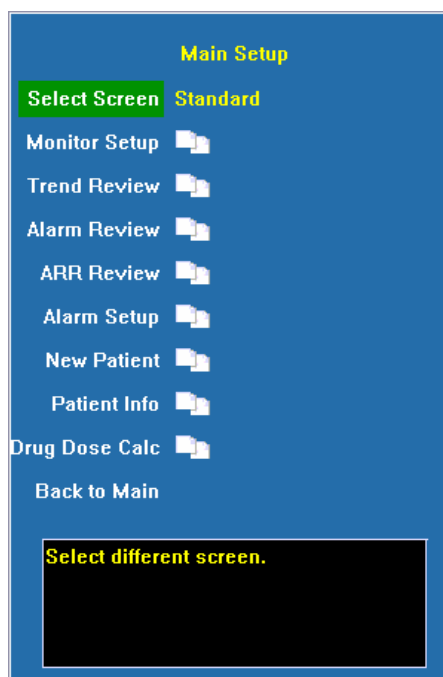

**Select Screen** Such eight display modes as **Standard, NIBP Review, Big Numerics, Short Trend, 7 leads, 12 leads, oxyCRG** and **Other Bed** can be selected. And the display mode varies according to different manufacturer configurations.

**Monitor Setup** Click and open the dialog of monitor configuration. Conduct some configurations of the monitor.

**Trend Review** Click and open the dialog of trend browse. Browse trend tables or trend diagrams.

**Alarm Review** Click and open the dialog of alarm event review. Browse alarm events.

**ARR Review** Click and open the dialog of arrhythmia review. Browse the waveforms and events of arrhythmia.

**Alarm Setup** Click and open the dialog of alarm configuration. Conduct configuration of alarm parameters.

**New Patient** Terminate the monitoring of the current patient and initiate the monitoring of a new patient. Pressing the option will delete the monitoring data of the current patient and patient Info and initiate the monitoring of a new patient.

**Patient info** Click and open the dialog of patient info. It provides the input and browse of patient info.

**Drug Dose Calc** Click and open the dialog of drug concentration. Open the calculation tool of drug concentration and it provides the calculation and printing of drug calculation and titration tables.



**Caution: After initiating the monitoring of a new patient, the data of historical patients will be completely eliminated.**

---

## 4.2.1 Monitor Setup

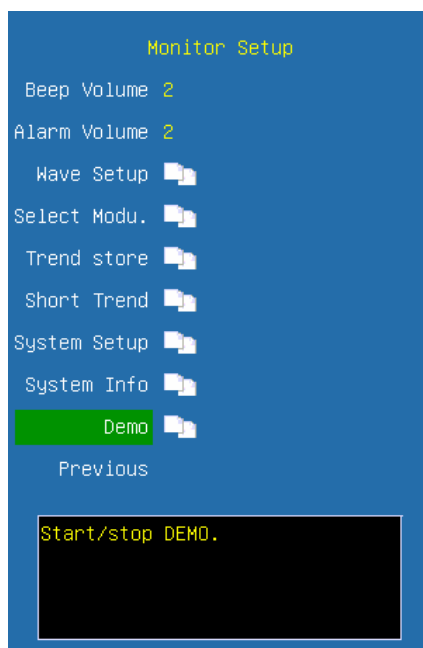

**Beep volume** Set the volume of BEEP and options are **Off, 1, 2, 3, 4, 5, 6**. After one selection is made, a testing beep will be produced.

**Alarm volume** Set the alarm volume and options are **Off, 1, 2, 3, 4, 5, 6**. After one selection is made, a testing beep will be produced.

**Wave Setup** Click and open the dialog of waveform configuration. Conduct the customization of screen waveforms and relevant waveform displays can be selected according to needs.

**Select Module** Click and open the dialog of module configuration. Some of the modules not in current use can be switched off, and after switching-off, the relevant parameters and waveforms will not be displayed and no alarm will be made.

**Trend storage** Click and open the dialog of configuration of trend storage. It provides the configuration function on the mode of trend storage and several modes of trend storage can be defined.

**Short Trend** Click and open the dialog of short trend diagram. Some scales and time of short trend diagram can be defined.

**System Setup** Click and open the dialog of system configuration. Conduct the configuration and maintenance of systems.

**System info** Click and open the dialog of system info. Some info of the system will be displayed, such as version info.

**Demo** Switch on or switch off demonstration function.

## ■ Waveform Setup

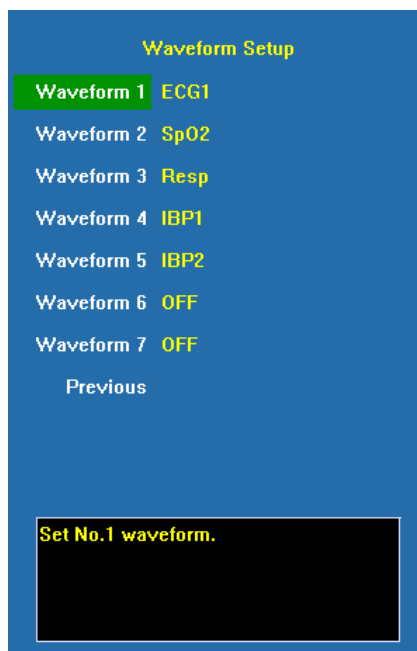

**Waveform 1** Select the waveform displayed in the first line, and according to the lead types, different ECG waveforms can be selected (**Note: The lead must be the ECG waveform, and cannot be switched off**). At 3-Leads mode, it is the key monitoring lead and it is defaulted as Lead II.

**Waveform 2** Select the waveform displayed in the second line, and options are **Off**, **Cascade** and **random waveform**. When selecting **<Cascade>**, waveform 2 is the cascade of waveform 1.

**Waveform 3** Select the waveform displayed in the third line. Select **Off** close the wave display or select certain waveform to display.

**Waveform 4** Select the waveform displayed in the fourth line. Select **Off** close the wave display or select certain waveform to display.

**Waveform 5** Select the waveform displayed in the fifth line. Select **Off** close the wave display or select certain waveform to display.

**Waveform 6** Select the waveform displayed in the sixth line. Select **Off** close the wave display or select certain waveform to display.

**Waveform 7** Select the waveform displayed in the seventh line. Select **Off** close the wave display or select certain waveform to display.



## ■ Select Module

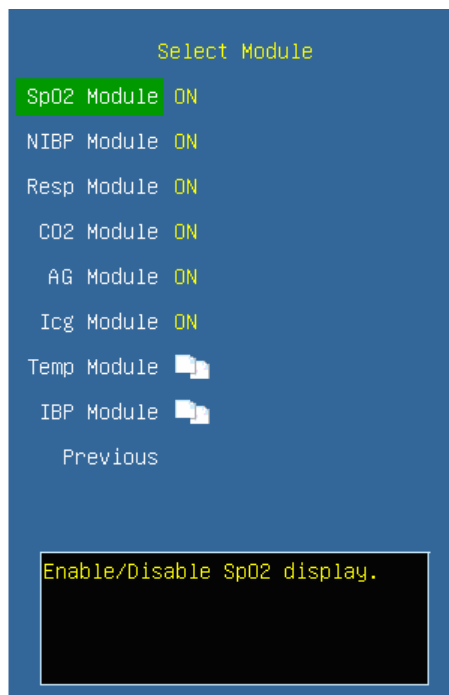

**SpO<sub>2</sub> module** Enable/Disable the display of SpO<sub>2</sub> module. After switching-off, the SpO<sub>2</sub> parameters and relevant alarm will not be displayed and the current SpO<sub>2</sub> waveform will be automatically switched off. After it is open, the SpO<sub>2</sub> waveform will also be opened.

**NIBP module** Please refer to **SpO<sub>2</sub> module** instruction

**RESP module** Enable/Disable the display of RESP module. After switching-off, the RESP parameters and relevant alarm will no be displayed and the current RESP waveform will be automatically switched off. After it is open, if there is no CO<sub>2</sub> module, the RESP waveform will be opened automatically.

**CO<sub>2</sub> module** Enable/Disable the display of CO<sub>2</sub> module. After switching-off, the CO<sub>2</sub> parameters and relevant alarm will no be displayed and the current CO<sub>2</sub> waveform will be automatically switched off. After it is open, the CO<sub>2</sub> waveform will be automatically open, if there is an RESP waveforms, the RESP waveform will be switched off.

**AG module** Please refer to **SpO<sub>2</sub> module** instruction

**TEMP module** Click and open the dialog of TEMP module setup.

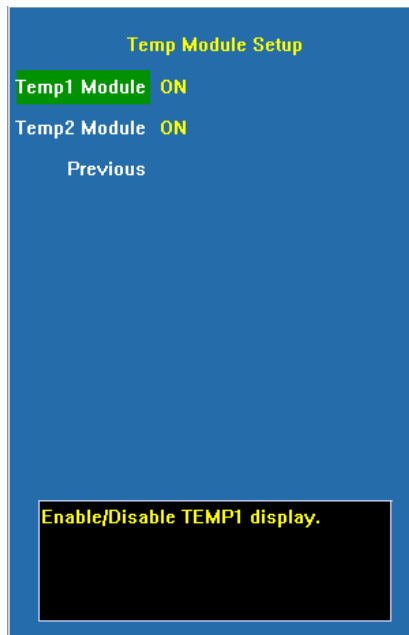

**TEMP 1 module** Enable/Disable the display of TEMP 1 module

**TEMP 2 module** Enable/Disable the display of TEMP 2 module

**IBP module** Click and open the dialog of IBP module setup

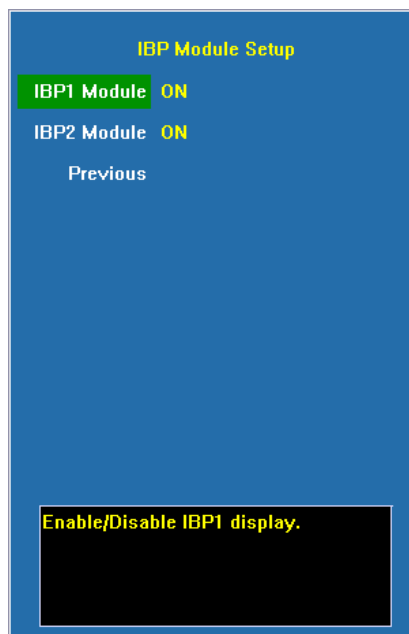

**IBP1 module** Enable/Disable the display of IBP1 module. After switching-off, no IBP1 parameters and relevant alarm will be displayed and the current IBP1 waveform will be automatically switched off. After it is open, the IBP1 waveform will also be opened.

**IBP2 module** Please refer to **IBP1 module** instruction

## ■ Trend Storage Setup

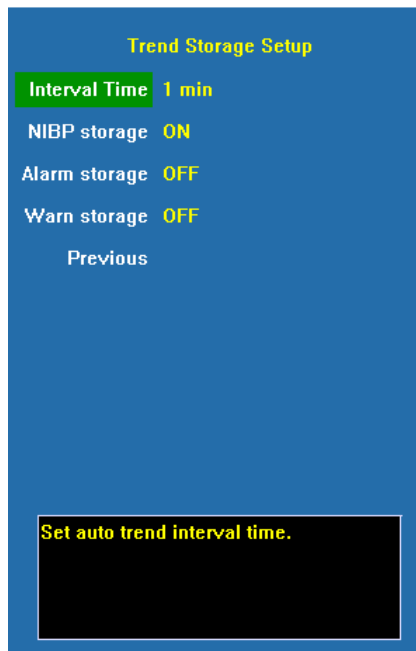

**Interval time** Select the cycle intervals of trend storage and options are **Off, 1min, 2min, 3min, 4min, 5min, 10min, 15min, 20min, 25min** and **30min**.

**NIBP storage** Enable/Disable the switch of NIBP storage. When it is enabled, it indicates after NIBP measurement completed, a record will be stored.

**Alarm storage** Enable/Disable the switch of alarm storage. When it is enabled, it indicates if there is a high alarm of physiological parameters a record will be stored.

**Warn storage** Enable/Disable the switch of warning storage. When it is enabled, it indicates if there is a medium alarm of physiological parameters a record will be stored.

## ■ Short trend Setup

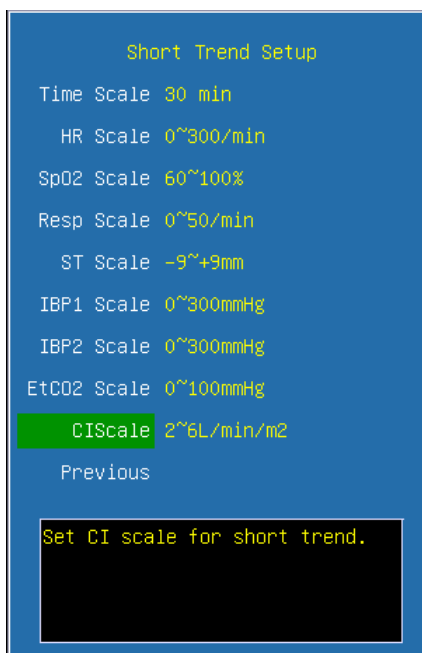

**Time scale** Select the time interval of short trend diagram. Options are **5min, 10min, 15min, 20min, 30min, 1h** and **2h**.

**HR scale** Select the scale of heart rate for short trend diagram. Options are **0~160/min** and **0~300/min**.

**SpO<sub>2</sub> scale** Select the scale of SpO<sub>2</sub> for short trend diagram. Options are **40~100%**, **60~100%** and **80~100%**.

**RESP scale** Select the scale of respiration rate for short trend diagram. Options are **0~8/min, 0~24/min, 0~50/min** and **0~100/min**.

**ST scale** Select the scale of ST-segment for short trend diagram. Options are **-2~+2mm, -5~+5mm** and **-9~+9mm**.

**IBP1 scale** Select the scale of IBP1 for short trend diagram. Options are **0~300mmHg, 0~150mmHg, 0~200mmHg, 0~100mmHg, -20~50mmHg** and **-50~300mmHg**.

**IBP2 scale** Select the scale of IBP2 for short trend diagram. Options are **0~300mmHg, 0~150mmHg, 0~200mmHg, 0~100mmHg, -20~50mmHg** and **-50~300mmHg**.

**EtCO<sub>2</sub> scale** Select the scale of EtCO<sub>2</sub> for short trend diagram. Options are **0~30mmHg, 0~60mmHg** and **0~100mmHg**.

## ■ System Setup

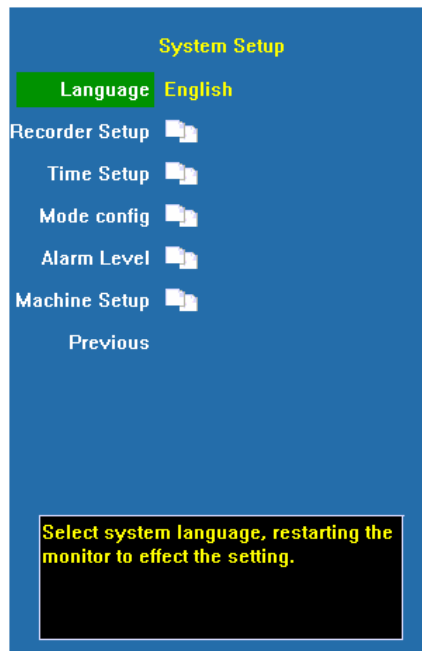

**Language** The categories of languages can be selected. To change the language, it is necessary to restart the monitor.

**Recorder Setup** Click and open the dialog of recorder configuration.

**Time Setup** Click and open the dialog of time configuration. After the time of the system has been configured, please restart the monitor.

**Mode Config** Click and open the dialog of mode configuration.

**Alarm level** Click and open the dialog of alarm level configuration.

**Machine Setup** Click and open the dialog of machine maintenance. Enter the interface of machine maintenance and it is necessary to enter the password (password is **125689**)

## ■ Recorder Setup



**Record Wave1** Select the waveform recording in the first line. Select certain waveform to record. **It cannot be switched off.**

**Record Wave2** Select the waveform recording in the second line. Select **Off** close the wave display or select certain waveform to record.

**Record Wave3** Select the waveform recording in the third line. Select **Off** close the wave display or select certain waveform to display.

**Record Time** Select the time duration of the waveform for each recording. Options are **8s, 12s** and **16s**.

**Record interval** Select the time interval for cycle recording. Options are **Off, 1min, 2min, 3min, 4min, 5min, 10min, 15min, 20min, 25min** and **30min**.

**Record Grid** Enable/Disable recording of the grids when the recorder is producing waveforms.

**Alarm Record** Enable/Disable the alarm recording at the high level of physiological alarm.

**Warn Record** Enable/Disable the warn recording at the medium level of physiological alarm.

**Delay Time** Delayed recordings start documenting on the recorder strip from a preset time before the recording is started. This interval is called the “Delay Time” and can be set to **Real time, 4s** or **8s**.

## ■ Time Setup

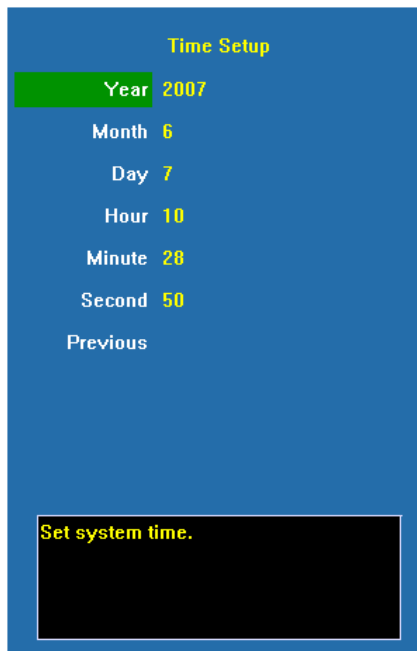

The user can configure system time. The user is advised to set system time before implementing monitoring. If the configuration is to be conducted during the process of monitoring, the user is advised to switch off the monitor after exiting the current window and then restart it. The time for the revision takes effect after the current window is exited.

## ■ Mode Setup

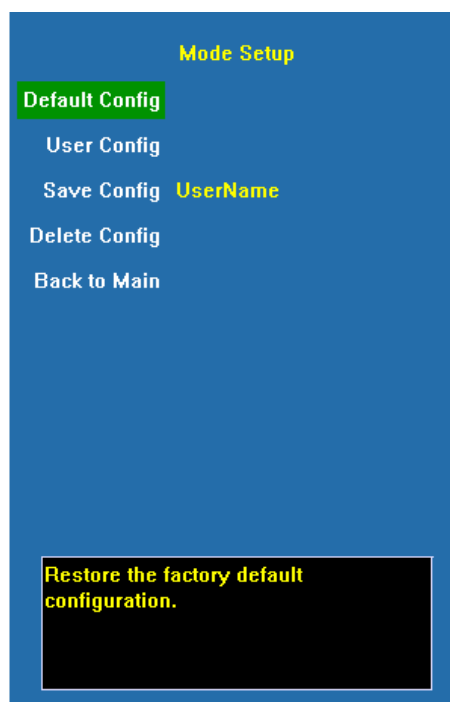

**Default Config** Select the default configuration defined by the manufacturer and options are **Cancel**, **Adult**, **Children** and **Neonatal**, select **<Cancel>** to abort it.

**User Config** Select the mode of user saving. Select the previous custom configuration, select **<Cancel>** to abort it.

**Save Config** Save the current configuration info as custom configuration, enter the name of the user custom configuration, select **<OK>** to save the current mode and select **<Cancel>** to cancel saving.

**Delete Config** Delete the previous data of custom configuration, select the custom configuration that needs to be deleted; press the selected mode to delete the mode, and press **<Cancel>** to cancel deleting.

---

**!** **Caution: The mode name cannot be black when saving current configuration, otherwise, the custom configuration will not be save.**

---

## ■ Alarm level Setup



Alarm levels of all the parameters can be configured. Press **<Set Alarm level >** option, the cursor will move to the region of configuring alarm levels. If the alarm level of a certain parameter is to be configured, first move the cursor to the alarm level of that parameter, press the option and then select the alarm level, Options are **low**, **med** and **high**.



## ■ Machine Setup



**Maintenance** Click and open the dialog of system maintenance

**Factory** Manufacturer maintenance is not an operation option for users and it must be operated by the technical and maintenance personnel authorized by manufacturer.

**CO<sub>2</sub> Gain Cal** Conduct gain calibration on the sidestream CO<sub>2</sub> module. This function is only valid on sidestream CO<sub>2</sub> and when the sampling pump has been started.

**CO<sub>2</sub> Cal Mode** Open or close the CO<sub>2</sub> calibration mode. When conducting calibration on sidestream CO<sub>2</sub>, set the CO<sub>2</sub> cal mode to ON.

**HUM** Select the frequency of the AC power supply and options are **50Hz** and **60Hz**.

It is mainly configured according to the frequency of local power supply.

**Gas zero** Conduct zero calibration on mainstream CO<sub>2</sub> module or anesthesia gas module. Press this button, the following dialog will pop up. Select **OK** to conduct zero-calibration operation. If **Cancel** is selected, the zero-calibration will not be implemented.

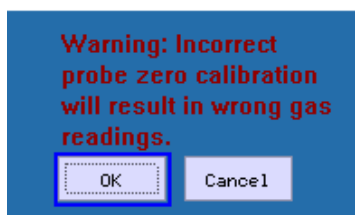

---

 **Note:** The zero-calibration of Gas is only valid on the mainstream CO<sub>2</sub> module and AG module of IRMA Company.

---

**Nurse call setup** Please refer to chapter 8 for details.

### ■ System Maintenance

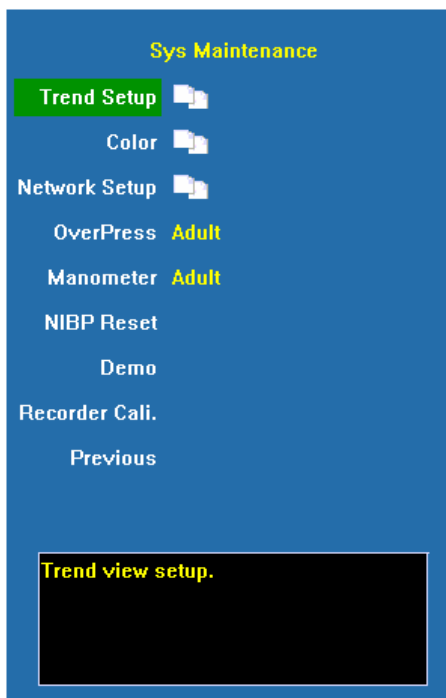

**Trend Setup** Click and open the dialog of trend display configuration. Conduct configurations of trend diagrams and trend tables.

**Color** Click and open the dialog of color configuration and configure colors of parameters and waveforms.

**Network Setup** Click and open the dialog of network configuration. Conduct network configurations.

**Over-press** Initiate NIBP over-pressure test

**Manometer** Initiate NIBP manometer test.

**NIBP reset** Reset NIBP module.

**Demo** Switch on or switch off demonstration function

**Recorder cali.** Conduct speed calibration of the recorder. This operation must be conducted when the recorder is changed.

### ■ Trend Setup

The user can define various trend display info according to needs or use the display configuration for default trend.



**Trend Graph1** Configuration of trend diagram.

There are a total of three pages of trend diagrams and on each page trend diagram can be configured for six regions, and options are **Off, HR, SpO<sub>2</sub>, NIBP, PR, Resp, CO<sub>2</sub>, T1, T2, AA, N<sub>2</sub>O, O<sub>2</sub>, P1, P2, ST, HR+SpO<sub>2</sub>, SpO<sub>2</sub>+PR, Resp+CO<sub>2</sub>, PR+CO<sub>2</sub>, T1+T2, IBP1+IBP2, AA+CO<sub>2</sub>, N<sub>2</sub>O+O<sub>2</sub>**. It is possible to have self-configurations on the contents of the trend diagrams and at least one page of trend diagrams shall be configured.



**Trend Table** Configuration of trend tables

There are a total of three pages of trend tables and on each page trend table can be configured for six regions, and options are **HR, SpO<sub>2</sub>, NIBP (S/D), NIBP (M), IBP1 (S/D), IBP1 (M), IBP2 (S/D), IBP2 (M), Resp, PR, T1, T2, CO<sub>2</sub>, AA, N<sub>2</sub>O, O<sub>2</sub>, ST**. It is possible to have self-configurations on the contents of the trend tables and at least one page of trend tables shall be configured.



■ **Color Setup**



Enter the interface of color configuration, the colors of various parameters and waveforms can be configured.

### ■ Network Setup

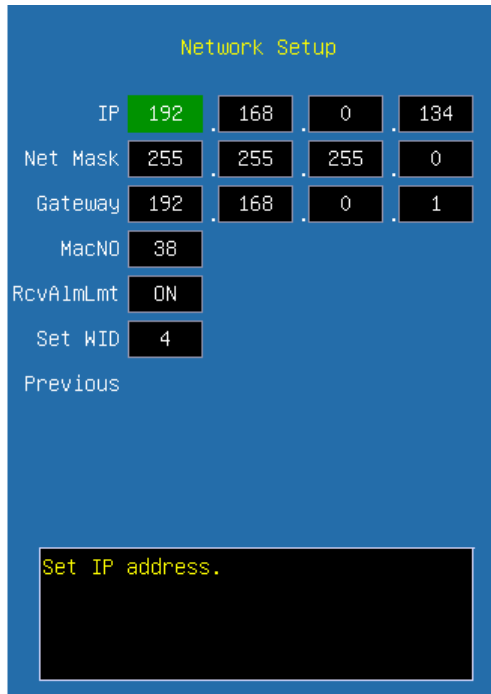

In the interface of network configuration, such items as **IP address**, **Net mask**, **Gateway**, **Machine number** can be configured. The configuration is mainly necessary when the monitor connecting to the Central Unit.

### ■ System info

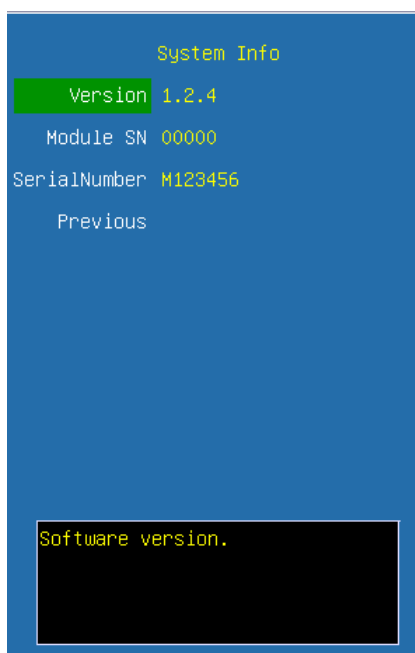

- Version**            It displays the version number of software.
- Module SN**        It displays the product serial number of module.
- Serial Number**    It displays the serial number of the machine.

### 4.2.2 Trend Review

#### Trend Graph

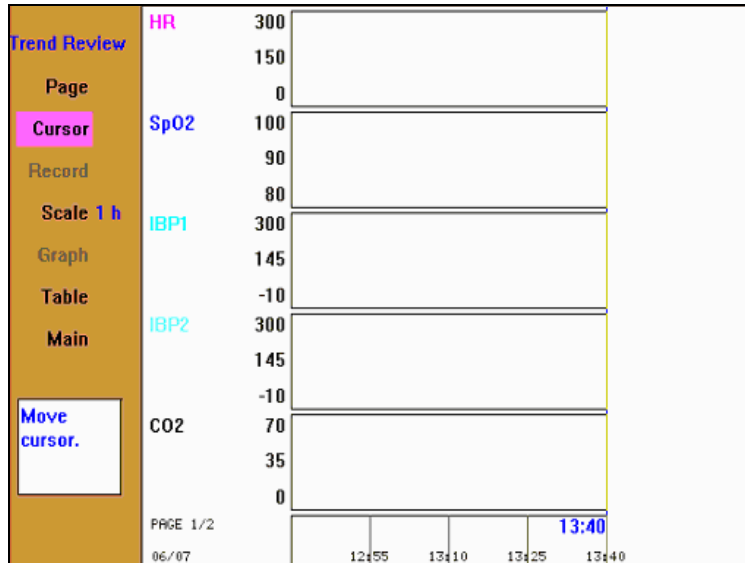

#### Trend Table

Trend Review	PAGE 1/2					
Page	TIME	HR	SpO2	IBP1	IBP2m	PR
Cursor						
Record						
Scale 1 h						
Graph						
Table						
Main						
Return to main screen.						

**Page**    Press this option and turn the trim knob to conduct the paging operation. Press it again to restore the initial status. If more than one page of trend diagrams or trend tables are configured, then the paging is switched between the trend diagrams or trend tables between different pages.

**Cursor** Press this option, turn the trim knob and move the cursor in the trend diagrams or trend tables. Press it again to restore the initial status. It is possible to move the cursor in the trend diagrams and trend tables. In the trend tables, it is possible to browse the trend records by moving the cursor, and if it moves to the left side or the right side of trend diagram, continue moving can roll the trend diagram by 1/4 screen to the left or right.

**Record** Press this option to record the trend tables of the current page, but the trend diagram does not support recording.

**Scale** Press this option and the time intervals for one page of trend diagrams can be selected. Options are **1h, 2h, 4h, 6h, 8h, 10h, 12h, 24h, 48h** and **72h**.

**Graph** Press this option to switch to the display of trend diagram.

**Table** Press this option to switch to the display of trend tables.

### 4.2.3 Alarm Review

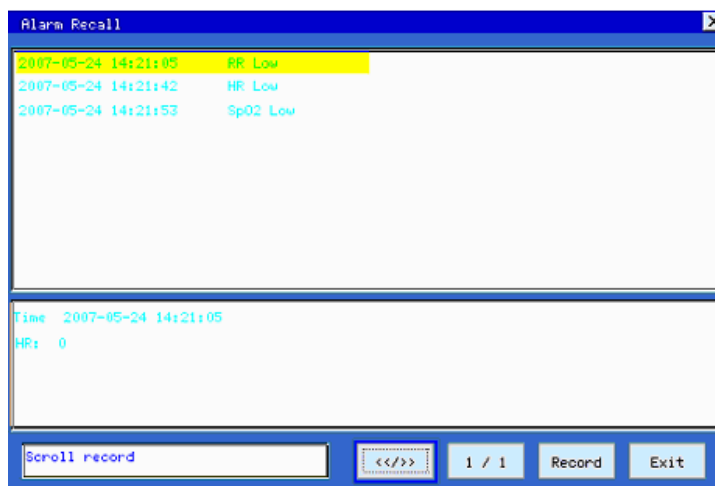

<</>> Select this button, turn the trim knob to roll the records back and forth.

1/1 Select this button, turn the trim knob to turn the pages back and forth.

**Record** Print the currently selected alarm events through the recorder; and if no recorder is configured, this option is invalid.

**Exit** Exit the dialog of alarm review

### 4.2.4 ARR Review

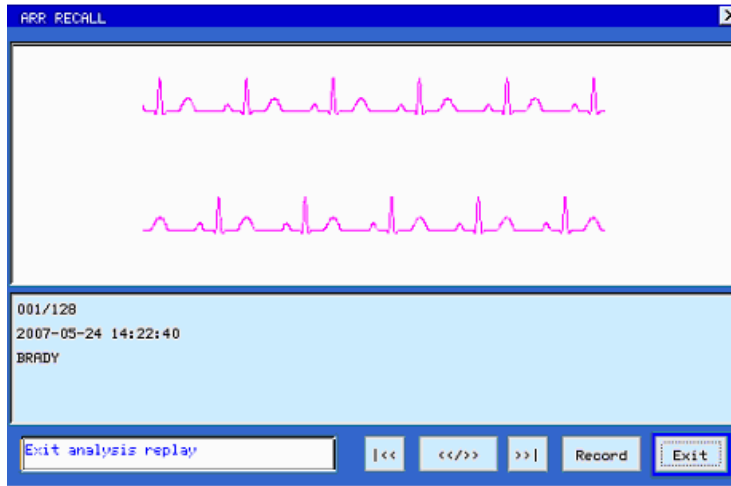

Click and open the dialog of arrhythmia review and the arrhythmia data for 8 seconds are displayed on each screen, i.e. the ECG waveforms 4 seconds before and after the occurrence of the event, and a maximum of 128 groups of abnormal data can be stored for search.

|<< Turn to the first abnormal waveform record.

>>| Turn to the last abnormal waveform record.

<</>> Select this button and turn the trim knob to turn the records back and forth.

**Record** Print the ECG waveform of the current screen through the recorder. If no recorder is configured, this option is invalid.

**Exit** Exit the dialog of Arrhythmia Review.

#### 4.2.5 Alarm Setup

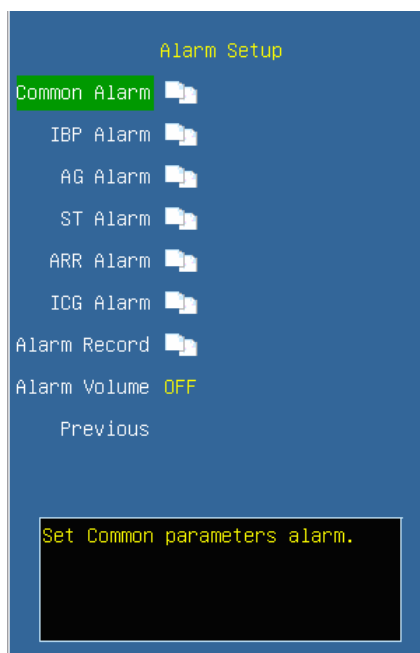



**Common Alarm** Click and open the dialog of common parameters alarm. It can setup the alarm limits of common parameters.

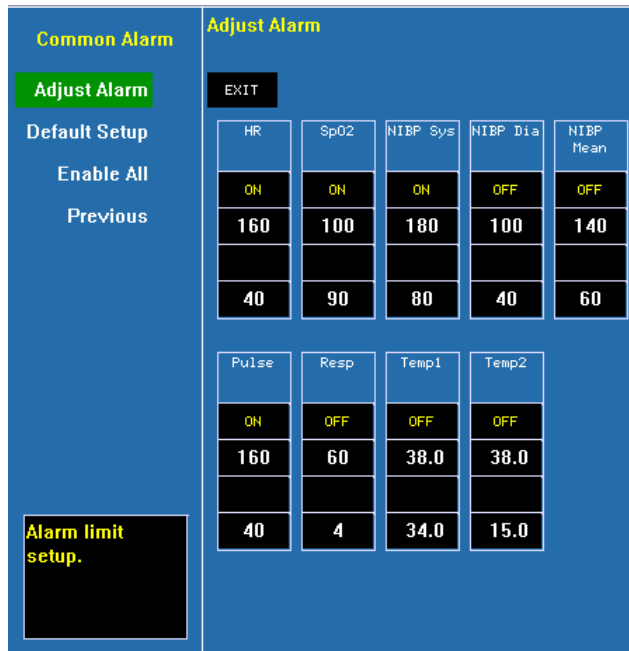

**IBP Alarm** Click and open the dialog of IBP alarm. It can setup the alarm limits of IBP.

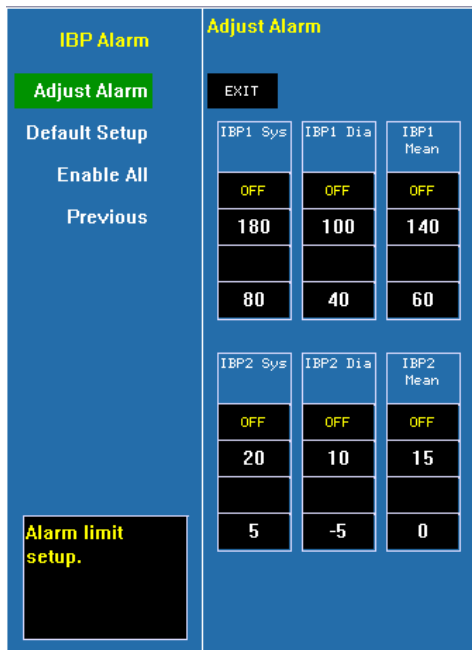

**AG Alarm** Click and open the dialog of AG alarm. It can setup the alarm limits of the AG module.

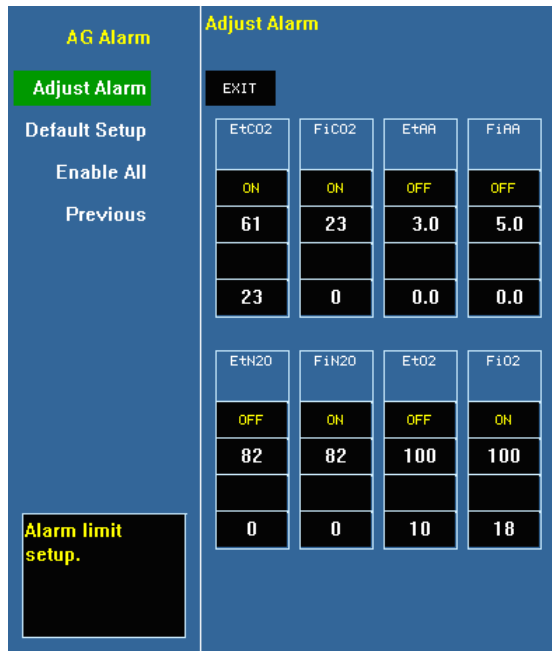

**ST Alarm** Click and open the dialog of ST alarm. If the ST analysis is not configured, this option is invalid.

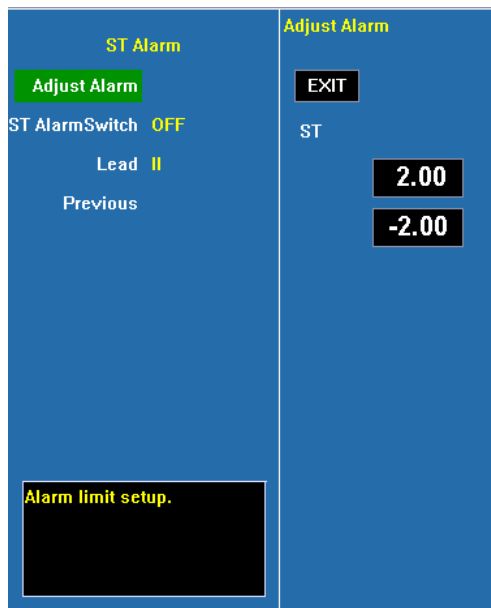

**ARR Alarm** Click and open the dialog of ECG analysis alarm. It can setup the alarm limits of various Arrhythmias.

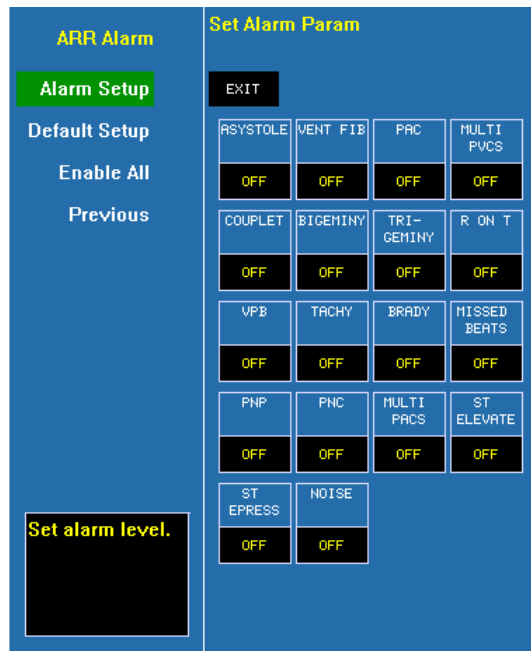

**Alarm Record** Click and open the dialog of alarm recording. Configure whether the alarm records of various modules are recorded. Only when the switch for alarm recording of the module and the switch for alarm record in the record setup have been switched on, the physiological alarm in the relevant modules will trigger the alarm recording.

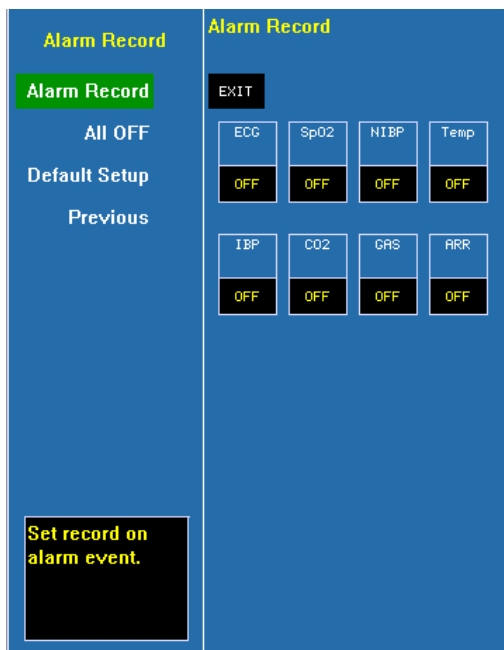

**Alarm volume** Configure the volume of alarm and options are **off, 1, 2, 3, 4, 5, 6**. Once a level is selected, a testing beep will be produced.

 **Note:** In each dialog of alarm configuration, press the button **⟨Adjust Alarm⟩** and the cursor moves to the adjustment region of alarm limits. Press the button **⟨Enable All⟩** and all the alarms will be opened. If the user desires to adjust the alarm parameter of a certain parameter, first move the cursor onto the label of that parameter, and then press the trim knob to move the cursor up and down to select the parameter to be adjusted for revision.

#### 4.2.6 Patient info



Patient Setup

Case No. 000000001

Name ABCDEFGHH

Height 172

Weight 50

Sex Male

Age 65

Room No. 9

Bed No. 20

Previous

Set patient ID.

**Case No.** The case number of patients (It can be configured according to the actual status of the hospital and a maximum of 10 letters can be entered), press **⟨Del⟩** to delete and **⟨Clear⟩** to clear; enter **⟨OK⟩** to confirm.

**Name** Patient name (It can be selected among A-Z and 0-9 and a maximum of 10 letters can be entered) enter **⟨OK⟩** to confirm.

**Height** Body height of patient (Turn the trim knob with an increment or decrement of 1 cm)

**Weight** Body weight of patient (Turn the trim knob with an increment or decrement of 1 kg)

**Sex** Gender of patient (male or female)

**Age** Age of patient (Turn the trim knob with an increment or decrement of 1 year)

**Room No.** Number of patient's room. Patient's room number can be displayed in the central unit.

**Bed No.** Number of patient's bed. Patient's bed number can be displayed in the central unit.

## 4.2.7 Drug Dose Calc

Drug Name	DRUG_A	Dose/kg/min	35.71	mcg
WEIGHT	70.0	kg	Dose/kg/hr	2142.86
DRUG AMOUNT	400.00	mg	INF RATE	93.75
LIQUID VOL	250.00	ml	DRIP RATE	31.25
CONCENTRATION	1600.00	mg/ml	DROP SIZE	20.00
Dose/min	2500.00	mcg	DURATION	2.67
Dose/hr	150.00	mcg		

Enter the patient's weight.

Exit

This calculation of drug concentration is mainly aimed at facilitating the work of physicians. It conducts concentration calculation on some commonly used drugs. A content of titration table can be output through recorder.

In the system, the following categories of drugs can be calculated:

**AMINOPHYLLINE, DOBUTAMINE, DOPAMINE, EPINEPHRINE, HEPARIN, ISUPREL, LIDOCAINE, NIPRIDE, NITROGLYCERIN, and PITOCIN.** In addition, it provides **DRUG\_A, DRUG\_B, DRUG\_C, DRUG\_D** and **DRUG\_E** to displace any other drugs flexibly.

The following formulas are used for the calculation of drug dosage:

Drug concentration equal to total amount of drug divided by liquid volume

Liquid velocity equal to drug dosage divided by drug concentration

Duration time equal to total amount of drug divided by drug dosage

Drug dosage equal to velocity of IV drip multiply drug concentration

In the window of drug calculation, the operator should first select the name of the drug to be calculated, confirm the patient weight and then enter other known values.

### ■ Drug name

Move the cursor to **<Drug name>**, press the trim knob, then turn the trim knob to select drug, and only one kind of drug can be selected for calculation at one time.

DRUG\_A, DRUG\_B, DRUG\_C, DRUG\_D and DRUG\_E are only codes for drugs rather than their real names. The units for these five kinds of drugs are fixed and the operator can select the appropriate units according to the habits of the drugs. The rules of the units are as follow:

DRUG\_A, DRUG\_B, DRUG\_C are fixed at the serial units of **gram (g)**, **milligram (mg)** and **microgram (mcg)**.

DRUG\_D is fixed at the serial units of **unit**, **k unit** and **m unit**.

DRUG\_E is fixed at the unit of **mEq**.

#### ■ **Weight**

The operator should enter the patient weight first, and as independent info the weight is only used in the function of the calculation of drug concentration.

Turn the trim knob to move the cursor to the positions of the various calculation items in the calculation formula respectively, turn the trim knob, and select calculation value, then press the trim knob and confirm the selected calculation value. When the calculation value is selected, the value of the calculated item will be displayed at relevant locations. There are range limits for the value adoption of each calculation Item, if the calculation results exceed the range, “---” will be displayed.

Regarding this function of drug calculation, the values for other individual items can only be entered after the weight and drug name have been entered. In the system, the values that are given initially are only a group of random initial values and the operator shall not take this value as the calculation standard and a group of values appropriate to the patient must be reentered according to the physicians' comments.

Each kind of drugs has a fixed unit or unit series and the operator must select the appropriate units according to the physicians' comments. In the unit series of the same unit, the addition of the units will be automatically adjusted in accordance with the current entered value. When the expressed range that can be expressed by this unit is exceeded, the system will display “---”.

When the operator has entered the value of a certain item, the system will give a prompt in the menu so as to remind the operator to verify the correctness of the entered value. Only by ensuring the correctness of the entered values, the calculated values can be reliable and safe.

In case of neonatal, drip velocity and volume per drip are invalid.

The values in the table may not be related to the patient monitored on this bed. Therefore the weight of this menu and the weight in the patient info are two different values. The values in this menu item are not affected by the values in the patient info.

#### ■ **Titration table**

Select **⟨Titration⟩** in the menu of drug calculation to enter the interface of titration table.

Titration Table					
DRUG AMOUNT	400.00 mg	LIQUID VOL	250.00 ml		
Dose/hr	150.00 mg	INF RATE	93.75 ml/hr		
WEIGHT	70.0 kg	DRIP RATE	31.25 GTT/min		
DOSE	INF RATE	DOSE	INF RATE	DOSE	INF RATE
0.00	0.00	10.00	6.25	20.00	12.50
1.00	0.63	11.00	6.88	21.00	13.13
2.00	1.25	12.00	7.50	22.00	13.75
3.00	1.88	13.00	8.13	23.00	14.38
4.00	2.50	14.00	8.75	24.00	15.00
5.00	3.13	15.00	9.38	25.00	15.63
6.00	3.75	16.00	10.00	26.00	16.25
7.00	4.38	17.00	10.63	27.00	16.88
8.00	5.00	18.00	11.25	28.00	17.50
9.00	5.63	19.00	11.88	29.00	18.13
BASE <input type="text" value="DOSE"/> STEP <input type="text" value="1"/> DOSE TYPE <input type="text" value="Dose/hr"/>					
PAGE UP/DOWN			RECORD		
Select one as the input and calculate the other one.					
Exit					

In the titration table, turn the trim knob to **<Base>**, then press the trim knob to select the desired item. Options are **Dose**, **Trans speed** and **Drop speed**. After selecting, press the trim knob to confirm the selection.

Move the cursor to **<Step>** and press the trim knob to select the step size; the selectable range is 1-10.

Move the cursor to **<Dose Type>** and press the trim knob to select the dosage unit.

Move the cursor to **<Page Up /Down>**, press the trim knob, and then turn the trim knob to browse the previous page and next page.

Move the cursor to **<Record>**, press the trim knob to give the output of the data of the titration table on the currently displayed interface.

Move the cursor to **<Exit>**, press the trim knob to return to the window of drug calculation.

### 4.3 Screen Display

This Monitor adopts color LCD screen with high brightness, which can display parameters, waveforms, system status and other prompt info. The main screen is mainly divided into three regions, they are respectively:



- Display zone of system info and alarm prompt info (the uppermost part)
- Waveform display zone (left, and It shall vary according to different screen types)
- Parameter display zone (right and lowest part)

### 4.3.1 System status

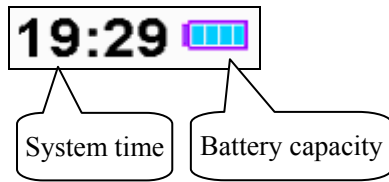
The system time and status of battery capacity are displayed on the upper right corner.



Notes on battery capacities:

-  Battery capacity is full
-  Battery capacity is half-full
-  Battery capacity is exhausted

Only when the monitor is powered by battery and is recharging the battery, the icon for battery capacity is displayed. If AC power is currently in use and the battery capacity is full, the icon will not be displayed.

---

 **Note:** When the battery capacity is exhausted, the system produces an alarm sound, prompting the user to plug in the AC power for recharging; if it is not recharged in time, the monitor will be automatically switched off due to insufficient capacity more than 5 minutes.

---



---

 **Caution:** When the energy level of the battery is exhausted, plug in the AC power to recharge, and then the battery indication may quickly return to “Full battery level”; the AC plug should be plugged in so as to ensure the full capacity of the battery.

---

### 4.3.2 Info display region

The upper region of the screen is the info display region, which is used to display the status of alarm sound, alarm suspension countdown and alarm info.

#### Status of alarm sound

 The alarm sound is in “Off” status, and if a new alarm is generated, the “Off” status of alarm sound will be automatically cancelled.

 Pause the alarm, and if a new alarm is generated, the “Pause” status of alarm sound will be automatically cancelled.



☰ **Alarm indicating zone**

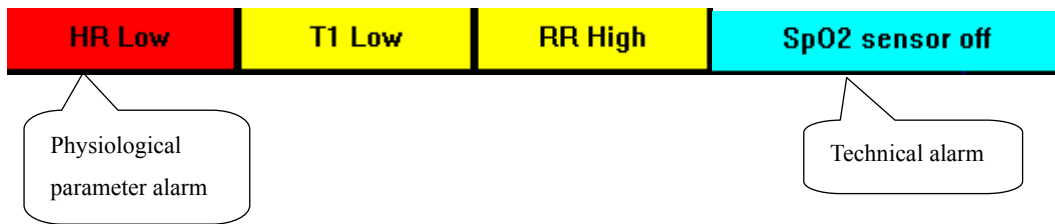

☰ **Alarm levels**

Red base color is high alarm

Yellow base color is medium and low alarm

The order displayed by the physiological parameter alarm is displayed from left to right in turn according to the alarm levels.

☰ **Parameter alarm**

The value of that parameter displayed on the upper part of the screen will flash to indicate the alarm of that parameter.

## Chapter 5 Parameters Measurement

### 5.1 Measurement of ECG/HR

#### 5.1.1 Principles of Measuring

Before the mechanical contraction, the heart will firstly produce electrization and biological current, which will be conducted to body surface through tissue and humors; the current will present difference in potential in different locations of the body, forming potential difference ECG, also known as body surface ECG or regular ECG, is obtained by recording this changing potential difference to form a dynamic curve. Monitor measures the changes in the body surface potentials caused by the heart of the patient, observe the cardioelectric activities, record the cardioelectric waveforms and calculate the HR through the multiple electrodes connected to ECG cable.

#### 5.1.2 Precautions during ECG Monitoring

---

 **Warning:** Before connecting the ECG cables to the monitor, please check if the lead wires and cables have been worn out or cracked. If so, they should be replaced.

---

 **Warning:** It is imperative to only use the ECG cables provided with the instrument by manufacturer.

---

 **Warning:** The equipment is capable of displaying the ECG signal in the presence of pacemaker pulses without rejecting pacemaker pulses.

---

 **Warning:** To avoid burning, when the electrotome operation is performed, the electrodes should be placed near the middle between ESU grounding pad and electrotome and the electrotome should be applied as far as possible from all other electrodes, a distance of at least 15 cm/6 in is recommended.

---

 **Warning:** When the electrotome operation is performed, the ECG leadwires should be intertwined as much as possible. The main unit of the instrument should be placed at a distance from the operation table. Power wires and the ECG lead cables should be partitioned and should not be in parallel.

---

 **Warning:** The monitor is protected against defibrillation effect. When applying defibrillator to the patient, the monitor will experience transient disorderly waveforms. If the electrodes are used and placed correctly, the display of the monitor will be restored within 5 seconds. During defibrillation, the chest leads such as V<sub>1</sub>~V<sub>6</sub> should be removed and such limb electrodes as RA, LA, RL, LL should be moved to the side of the limbs.

---

 **Warning:** All the electrodes and conducting part shall not be into contact with any other conductors including the ground. For the sake of patient safety, all the leads on the ECG cables must be attached to the patient.

---

 **Warning:** When conducting defibrillation, it is imperative to only use the electrodes recommended by manufacturer.

---

 **Warning:** Do not come into contact with the patient, bed and the monitor during defibrillation.

---

 **Warning:** The monitor cannot be directly applied to heart and cannot be used for the measurement of endocardio ECG.

---

 **Note:** When several parts of equipment are interconnected, the total leakage current is limited to the safety range according to standards IEC 60601-2-27.

---

### 5.1.3 Preparatory Steps before the Measurement of ECG/HR

- 1) Plug the ECG cable into the ECG socket of the monitor.
- 2) Place the electrodes onto the body of the patient and connect them to the relevant lead wires of the ECG cables, and at this moment ECG waveforms will appear on the screen.
- 3) Set the parameters relevant to ECG monitoring.

### 5.1.4 Connecting the ECG Cables to the Monitor

Monitor is provided with three different ECG cables relevant to 3-Lead ECG module, 5-Lead ECG module and 12-Lead ECG module:

1) 3-lead ECG cable

- ⇒ Including three limb leads: RA, LL, and LA.
- ⇒ Realize 3-lead ECG monitoring.

2) 5-lead ECG cable

- ⇒ Including four limb leads: RA, RL, LL, LA and one chest-lead C (C<sub>4</sub>).
- ⇒ Realize 7-lead ECG monitoring.

3) 12-lead ECG cable

- ⇒ Including four limb leads: RA, RL, LL, LA and six chest leads: C<sub>1</sub>, C<sub>2</sub>, C<sub>3</sub>, C<sub>4</sub>, C<sub>5</sub>, C<sub>6</sub>.
- ⇒ Realize all-lead (12-lead) ECG monitoring.

### 5.1.5 Connecting the ECG Electrodes to the Patient

#### 1) Connection steps

- ⇒ Clean the patient's skin and wipe the oil stains, sweat stains on the skin with alcohol. If necessary, shave body hair at the locations where the electrodes are to be placed or grind off the stratum corneum and clean it with alcohol.
- ⇒ Check if the buttons on the electrodes are clean and free of damage.
- ⇒ Place the electrodes on the body of patient. Before attaching, smear some conducting cream on the electrodes if the electrodes are not electrolyte self-supplied.
- ⇒ Connect the cable leads to the electrodes through the buttons of the electrodes.

---

 **Note: For patients who tremble a lot or patients with especially weak ECG signals, it might be difficult to extract the ECG signals, and it is even more difficult to conduct HR calculation. For severely burnt patients, it may be impossible to stick the electrodes on and it may be necessary to use the special pin-shape electrodes. In case of bad signals, care should be taken to place the electrodes on the soft portions of the muscle.**

---

 **Note: Check the irritation caused by each electrode to the skin, and in case of any inflammations or allergies, the electrodes should be replaced and the user should relocate the electrodes every 24 hours or at a shorter interval.**

---

 **Note: When the amplifier is saturated or overloaded, the input signal is medical meaningless, then the equipment gives an indication on the screen.**

---

## 2) Location for electrode placement

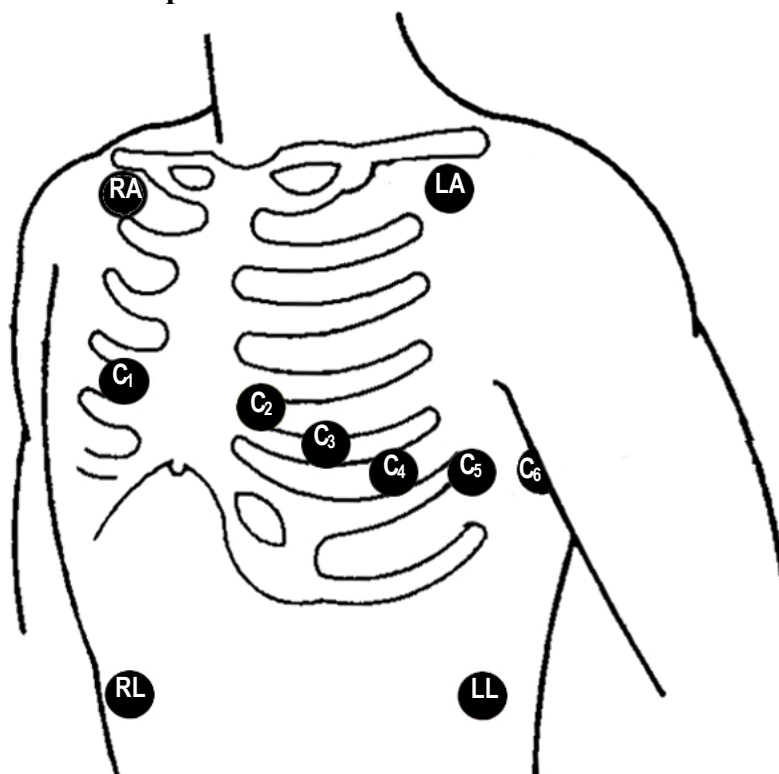

Fig. 5-1-5 Indicative map of the placement of ECG electrodes

The following table shows the lead name to identify each lead wire and its associated color of AHA and IEC standards.

AHA Label	AHA Color	IEC Label	IEC Color	Location
RA	White	R	Red	Under the clavicle of the right shoulder.
LA	Black	L	Yellow	Under the clavicle of the left shoulder.
RL	Green	N	Black	Right lower abdomen.
LL	Red	F	Green	Left lower abdomen.
V1	Red	C1	Red	4th intercostal space on the right sternum side.
V2	Yellow	C2	Yellow	4th intercostal space on the left sternum side.
V3	Green	C3	Green	Center of the line connecting V <sub>2</sub> and V <sub>4</sub> .
V4	Blue	C4	Brown	Node of the left 5th intercostal space and the mid-clavicular line.
V5	Orange	C5	Black	Node with the left anterior axillary line at the same height with V <sub>4</sub> .
V6	Purple	C6	Purple	Node with the left mid-axillary line at the same height with V <sub>4</sub> .

When conducting 3-leads ECG monitoring, use 3-lead ECG cable. The three limb-leads of RA, LA and LL as shown in Fig. 5-1-5, will be placed on the relevant locations. This connection can establish the lead of I, II, III.

When conducting 7-leads ECG monitoring, use 5-lead ECG cable. The four limb-leads of RA, LA, RL and LL as shown in Fig. 5-1-5, will be placed on the relevant locations. This connection can establish the lead of I, II, III, aVR, aVL, aVF; according to actual needs, chest lead C can be placed on any of the locations between C<sub>1</sub>~C<sub>6</sub>, respectively making one lead of V<sub>1</sub>~V<sub>6</sub> established.

When conducting 12-leads ECG monitoring, use 12-lead ECG cable, and all the leads are placed on the relevant locations respectively as indicated by Fig. 5-1-5. This kind of connection realizes the establishment of such 12 leads as I, II, III, aVR, aVL, aVF, V<sub>1</sub>~V<sub>6</sub>.

### 5.1.6 Setup of ECG/HR parameters

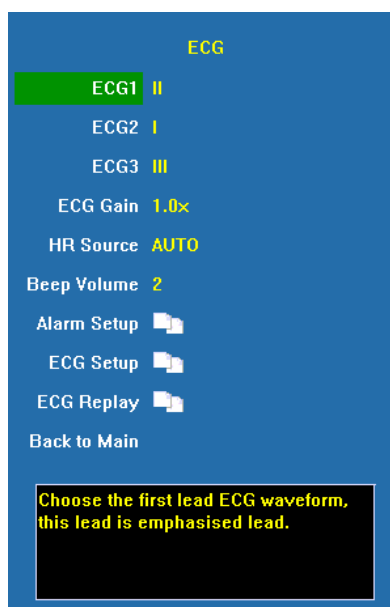

**ECG1** Select the first lead ECG waveform, and this lead is the key monitoring lead.

**ECG2** Select the second lead ECG waveform.

**ECG3** Select the third lead ECG waveform.

**ECG gain** Select the gain item of ECG waveform, and options are **AUTO**, **0.25x**, **0.5x**, **1.0x**, **2.0x** and **4.0x**.

**HR source** Select HR source item, and common options are **AUTO**, **ECG**, **PLETH**.

When select ART for IBP measurement, the option **ART** is appeared in HR source.

**Beep Volume** Select the volume of BEEP, and options are **Off**, **1**, **2**, **3**, **4**, **5**, **6**. Once an option is selected, a testing beep will be produced.

**Alarm setup** Click and open the dialog of alarm setup.

**ECG setup** Click and open the dialog of ECG setup.

**ECG replay** Click and open the dialog of ECG replay.

- **Alarm setup**

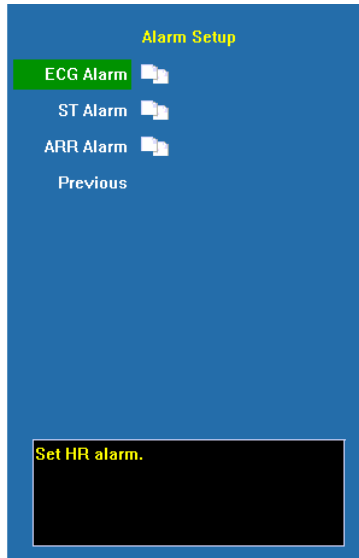

**ECG alarm** Click and open the dialog of HR alarm

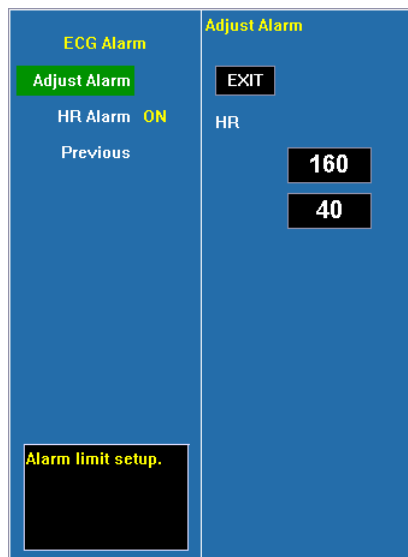

**Adjust alarm** Select this option to enter the configuration of alarm limits and configure the limits by turning the trim knob to select the high limits and low limits, and exit by selecting **<EXIT>** . The upper part is the high limit and the lower part is the low limit.

**HR alarm** Select **<ON>** to enable HR over limit alarm; select **<OFF>** to disable HR over limit alarm.

**ST alarm** Click and open the dialog of ST alarm

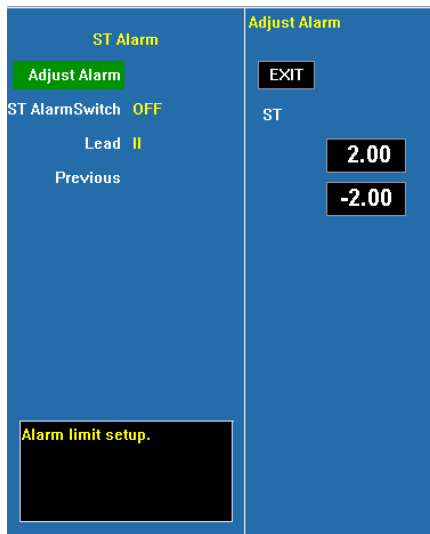

**Adjust alarm** Select this option to enter the configuration of alarm limits; by turning the trim knob, select the high limits and low limits for configuration and exit by selecting **<EXIT>** . The upper part is the high limit and the lower part is the low limit;

**ST Alarm** Select **<ON>** to enable ST over limit alarm; select **<OFF>** to disable ST over limit alarm.

**Lead** Select the ECG lead for calculating ST

**ARR alarm** Click and open the dialog of Arrhythmia analysis alarm.

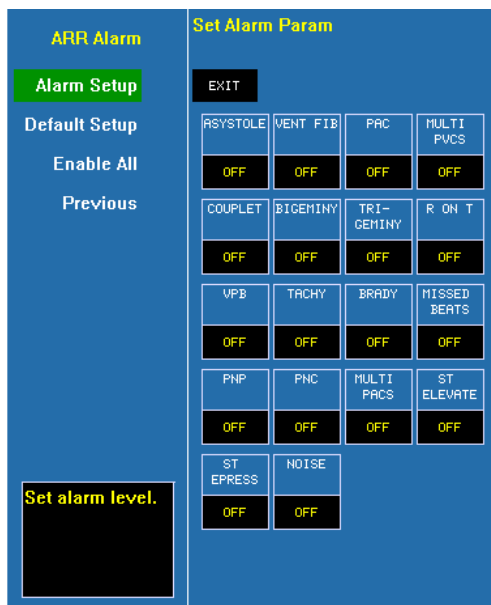

In the interface, it is possible to configure the alarm levels of various Arrhythmia or switch off the Arrhythmia alarm.



**Alarm Setup** Select this option to enter the configuration of ECG alarm levels; select the alarm levels of different Arrhythmia by turning the trim knob and exit by selecting <EXIT>.

**Default Setup** Select this option and configure the Arrhythmia alarm as the manufacturer's default configuration.

**Enable All** Select this option and configure all the Arrhythmia alarms as low level alarms.

- **ECG Setup**

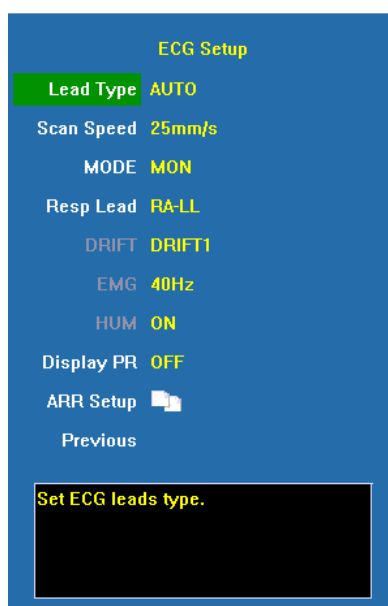

**Lead Type** Select the lead type of ECG input, and options are **5 leads**, **3 leads**, **Auto** and **12 leads**.

**Scan speed** Select the scanning speed of ECG waveforms and options are **12.5mm/s**, **25mm/s** and **50mm/s**. The output speed of the recorder remains the same as the scanning speed of the ECG lead.

**MODE** Select monitoring mode, and options are **User**, **Diagnosis**, **Monitor** and **Operation**.

**Resp Lead** Select the calculation methods of RESP lead, and options are **RA-LL**, **RA-LA**, **RL-LA** and **RL-LL**.

**DRIFT** Select the modes of drift filtrations, and options are **Off**, **Drift 1** and **Drift 2**.

**EMG** Select myoelectric filtration, and options are **Off**, **25Hz** and **40Hz**.

**HUM** Select hum frequency filtration, and options are **Off** and **on**. Specific frequencies (50Hz, 60Hz) are configured in <**Machine Setup**> and they must be configured according to the frequency of local power supply.

**Display PR** Select to simultaneity display pulse rate. If simultaneity display of PR is selected, PR will be simultaneity displayed at the lower left corner of the ECG parameter display region.

**ARR Setup** Click and open the dialog of Arrhythmia analysis configuration, Configure some of the parameters of Arrhythmia analysis.

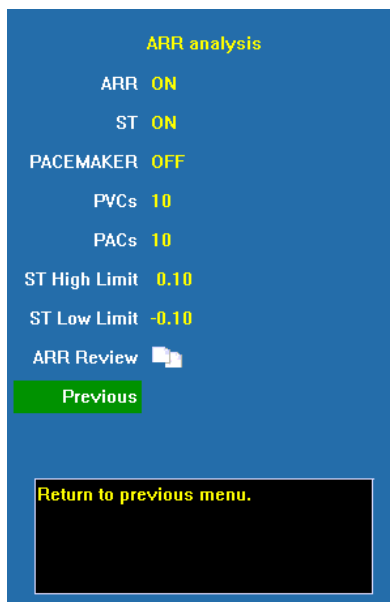

**ARR** Only when **ON** is selected, the monitor will conduct Arrhythmia analysis

**ST** Only when **ON** is selected, the monitor will conduct ST-segment analysis.

**Pacemaker** Only when **ON** is selected, the monitor will conduct pace-making analysis on patient with pacemaker.

**PVCs** Only when the times of continuous occurrences is selected from 1 to 10, the monitor will set off the alarm for the frequent occurrences of ventricular premature contractions.

**PACs** Only when the times of continuous occurrences is selected between 1 and 10, the monitor will set off the alarm for the times of premature beat.

**ST High Limit** ST alarm high limit of arrhythmia analysis, and the unit is **mV**.

**ST Low Limit** ST alarm low limit of arrhythmia analysis, and the unit is **mV**. In arrhythmia analysis, only when the ST-segment exceeds the configured high and low limits will be regarded as the elevation or depression of the ST-segment. They are different from the high and low limit in the configuration of ST alarm limits.

**ARR Review** Click and open the dialog of arrhythmia review. The user can review the arrhythmia that have occurred and can browse the waveforms 4 seconds before and after the occurrence of arrhythmia alarm.

- ECG replay

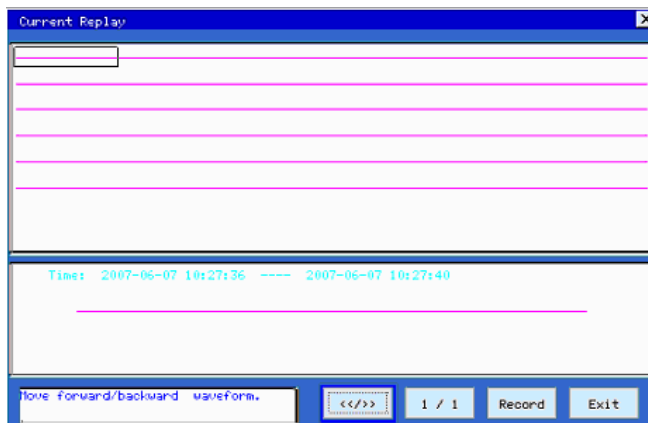

<</>> Select this button and it is possible to roll the waveform block by turning the trim knob back and forth, with 5 seconds each block.

1/1 Select this button, and it is possible to turn the pages back and forth, and the number before “/” shows the current page and the number following “/” shows total page numbers.

**Record** Print the enlarged waveform in current selection through the recorder.

**Exit** Exit the dialog of ECG replay.

**The states of the filter under various modes of ECG**

ECG mode \ Filter	Drift filter	HUM filter	EMG filter
DIAG	OFF	OFF	OFF
OPS	Drift 2	50Hz/60Hz	25Hz
MON	Drift 1	50Hz/60Hz	40Hz
USER	Optional	Optional	Optional

**Note:** Under the mode of DIAG, OPS and MON, the state of the filter cannot be regulated. Only under the state of USER can the state be regulated.

**Caution:** When “3 Lead” is selected as <Lead Type>, ECG is in 3-lead input mode, and only Lead I, II or III can be measured.

**Caution:** When “5 Lead” is selected as <Lead Type>, ECG is in 5-lead input mode, and Lead I, II, III, aVR, aVL and aVF and one chest lead can be measured at the same time; if chest lead ECG cable is connected, V1~V6 can be measured at the same time.

### 5.1.7 Functions of Arrhythmia Analysis

 **Note:** Arrhythmia Analysis software module may be an optional function in your monitor.

The function is consisting of ST segment analysis and arrhythmia analysis. Arrhythmia analysis can identify more than 18 kinds of abnormal ECG, as listed in the following table:

Prompt	Applicable Patient Type	Occurring Condition	Indication	Alarm level
ASYSTOLE	All patients	No QRS is detected for 4 consecutive seconds.	Asystole (ASY)	User-selectable
VENT FIB	Without pacemaker	Fibrillatory wave consecutive 4 seconds (350 to 600 times per min)	Ventricular fibrillation (VFIB)	User-selectable
PAC	Without pacemaker	Single Premature Atrial Contractions	PAC	User-selectable
VENT TACHY	Without pacemaker	The number of continuous Vent beats is larger than the upper limit of cluster Vent beats( $\geq 5$ ). The R-R interval is less than 600ms.	Ventricular tachycardia (VTA)	User-selectable
UVPB	Without pacemaker	Single UVPB	UVPB	User-selectable
COUPLET	Without pacemaker	2 consecutive PVCs	CPT	User-selectable
BIGEMINY	Without pacemaker	Vent Bigeminy	Vent Bigeminy (BGM)	User-selectable
TRIGEMINY	Without pacemaker	Vent Trigeminy	Vent Trigeminy (TGM)	User-selectable
R ON T	Without pacemaker	A type of single PVC under the condition that HR < 100, R-R interval is less than 1/3 the average interval, followed by a compensating pause of $1.25 \times$ the average R-R interval(The next R wave advances onto the previous T wave).	R ON T	User-selectable
PVC	Without pacemaker	Single PVCs not belonging to the type of above mentioned PVCs.	Single Premature Ventricular Contractions	User-selectable

Prompt	Applicable Patient Type	Occurring Condition	Indication	Alarm level
TACHY	All patients	5 consecutive QRS complex; R-R interval is less than 500 ms.	Tachycardia (TAC)	User-selectable
BRADY	All patients	5 consecutive QRS complex; R-R interval is longer than 1.5s	Bradycardia (BRD)	User-selectable
MISSED BEATS	Without pacemaker	When HR is less than 100 beats/min, no heartbeat is detected during the period of 1.75 times of the average RR interval; or when HR is longer than 100 beats/min, no heartbeat is detected within 1 second.	Missed beats (MIS)	User-selectable
PNP	With pacemaker	No QRS complex and pacing pulse are available during the period 1.75 times of the average RR interval. (Only considering patients with pacemaker).	Pacemaker not pulsating (PNP)	User-selectable
PNC	With pacemaker	When pacing pulse is available, no QRS exists during the period 1.75 times of the average RR interval. (Only considering patients with pacemaker).	Pacemaker not capturing (PNC)	User-selectable
ST DEPRESS	Without pacemaker	Depression of ST segment is more than 0.2mV (DEFAULT).	Depression of ST segment	User-selectable
ST ELEVATE	Without pacemaker	Elevation of ST segment is more than 0.2mV (DEFAULT).	Elevation of ST segment	User-selectable
NOISE	All patients	Abnormal ECG wave	Noise (NOS)	User-selectable

### 5.1.8 Maintenance and Cleaning

If there is any sign that the ECG cable may be damaged or deteriorated, replace it with a new one instead of continuing its application on the patient.

To avoid extended damage to the equipment, disinfection is only recommended when stipulated as necessary in the hospital maintenance schedule, disinfection facilities should be cleaned first.

#### ■ Cleaning:

Use a piece of clean cloth moistened in water or mild soap solution to clean the ECG cable.

#### ■ Disinfection:

Use a piece of clean cloth to wipe the surface of the cable with a 10% bleach solution or 2% Cidex®, clean with clear water and wipe it dry.

## 5.2 Measurement of RESP

### 5.2.1 Principles of Measuring

Monitor measures RESP with the method of impedance. When a patient exhales and inhales, changes will take place in the size and shape of the thoracic cavity, causing consequent changes in the impedance between the two electrodes installed at the patient's chest. Based on the cycle of impedance changes, the respiration rate can be calculated.

### 5.2.2 Preparatory Steps of the Measurement of RESP

- 1) Plug the 5-lead ECG cable into the ECG socket of the monitor.
- 2) Place the various pads of the electrodes onto the body of patient and connect them to the relevant lead cables. At this moment, the screen will show RESP waves and the RESP rate will be calculated.
- 3) Set the parameters relevant to RESP monitoring.

### 5.2.3 Connect the ECG Cable with Patient and the Monitor

To measure RESP parameters, it is unnecessary to use other cables and it is only necessary to use the two RA and LL leads in the 5-lead ECG cable. So please plug the 5-lead ECG cable into the ECG socket and refer to Fig. 5-1-5 to place the RA and LL leads onto the body of patient.

---

 **Warning:** For the sake of safety, all the leads on the 5-lead ECG cable must be connected to the body of patient.

---

---

 **Caution:** In order to get the best RESP waveforms, when selecting lead II for measuring RESP, it is advised to place RA and LL electrodes cornerways.

---

---

 **Caution:** For reducing the influence of rhythmic blood flow on Resp electrode pickup impedance changes, avoid the liver area and ventricles of heart in the line between RA and LL electrodes. This is particularly important for neonates.

---

---

 **Caution:** The measurement of RESP is not applicable for patient with excessive motion, otherwise it may cause the mistake of RESP alarm.

---

### 5.2.4 Setup of RESP parameters

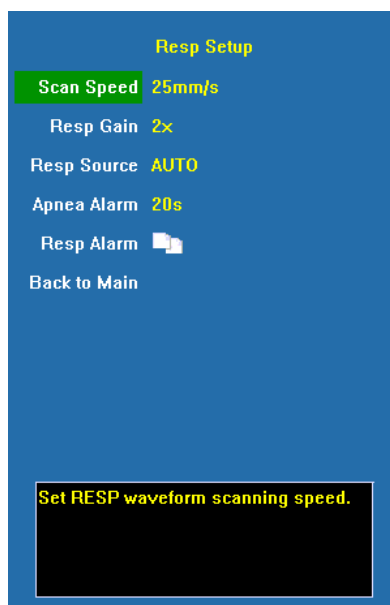

**Scan speed** Select the scanning speed of RESP waveform, and options are **6.25mm/s**, **12.5mm/s** and **25mm/s**.

**Resp gain** Select the waveform gain, and options are **1x**, **2x** and **4x**.

**RESP source** When the system is configured with CO<sub>2</sub> module, RESP source can be selected as **AUTO**, **ECG** and **EtCO<sub>2</sub>**. Only when the monitor that user has bought has CO<sub>2</sub> module, **EtCO<sub>2</sub>** of RESP source is valid, otherwise the RESP source is defaulted as **ECG**.

**Apnea alarm** Suffocation alarm occurs when the time of zero RESP rate has reached this time scale, the alarm will be set off. Options are **Off**, **10s**, **20s**, **40s** and **60s**.

**RESP alarm** Click and open the dialog of RESP alarm configuration.

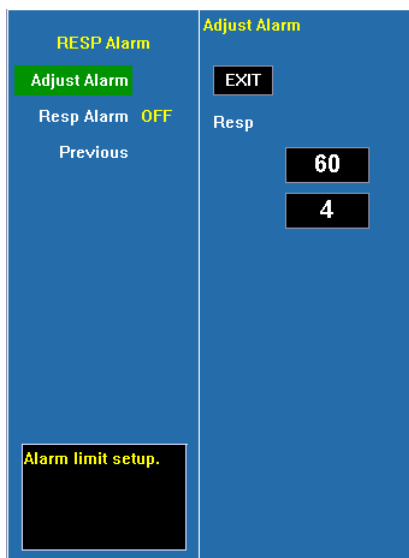

**Adjust alarm** Select this option to enter the configuration of alarm limits; conduct the

configurations by turning the trim knob to select high or low limits and exit by selecting **<EXIT>** .The upper part is the high limit and the lower one is the low limit.

**RESP alarm** Select **<ON>** to enable RESP over limit alarm; select **<OFF>** to disable RESP over limit alarm.

### 5.2.5 Maintenance and Cleaning

No special operation demanded. Please refer to **chapter 5.1.8**.

## 5.3 Measurement of SpO<sub>2</sub>/Pulse

### 5.3.1 Principles of Measuring

The measurement of degree of blood oxygen saturation (also known as pulse oxygen saturation, usually shortened as SpO<sub>2</sub>) adopts the principles of light spectra and volume tracing. The LED emits lights with two specific bandwidths, which are selectively absorbed by hemoferrum and desoxyhemoglobin. The optical receptor measures the changes in the light intensity after the light passes the capillary network and estimates the ratio of hemoferrum and the total hemoglobin.

$$\text{Degree of pulse oxygen saturation \%} = \frac{\text{hemoferrum}}{\text{hemoferrum} + \text{desoxyhemoglobin}} \times 100\%$$

Abnormal hemoglobin, carboxyhemoglobin, oxidative hemoglobin are not directly measured, for they are not the affecting factors in the measurement of SpO<sub>2</sub>

The sensor measurement wavelengths are nominally 660nm for the Red LED and 940nm for infrared LED.

Monitor adopts FFT filter and signal correlation techniques to deal with SpO<sub>2</sub> module's pulse waveform signals. Before the measurement of SpO<sub>2</sub>, the noise produced in the false trace is smoothed so as to the eliminate disturbance in the measurement of saturation. In case of weak blood pulse, the noise produced by some confinements of electrical properties is greatly reduced.

The monitor is designed for measurement and recording of functional saturation.

### 5.3.2 Preparatory Steps before the Measurement of SpO<sub>2</sub>/Pulse

- 1) Plug the SpO<sub>2</sub> sensor cable into the SpO<sub>2</sub> socket of the monitor.
- 2) Put the SpO<sub>2</sub> sensor onto the finger of the patient, and the screen should display SpO<sub>2</sub> waveforms, and the SpO<sub>2</sub> value and pulse rate should be calculated.
- 3) Set up the parameters relevant to SpO<sub>2</sub> and pulse monitoring.



### 5.3.3 Connecting to Patient and Monitor

Plug the SpO<sub>2</sub> sensor cable into the socket marked with SpO<sub>2</sub>, then put the sensor onto the finger of the patient, as shown in Fig. 5-3-3.

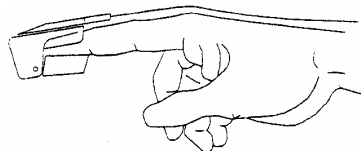

Fig. 5-3-3 Connection of SpO<sub>2</sub> sensor with the patient

After the SpO<sub>2</sub> sensor is connected to the patient, the screen shall display SpO<sub>2</sub> waveforms and then it shall calculate the SpO<sub>2</sub> value and pulse rate value.

---

**!** **Caution:** In case it is necessary to add a clip to fix the fingertip sensor, the cable instead of the sensor itself should be clipped. Please note that the cable of sensor should not be pulled with force.

---

---

**👉** **Note:** Frequent movements of the sensor may result in errors in the readings of the monitor.

---

---

**💧** **Warning:** In case NIBP and SpO<sub>2</sub> are measured at the same time, please do not place the SpO<sub>2</sub> sensor and the NIBP cuff on the same end of the limb, for the measurement of NIBP will block blood flow, affecting the measurement of SpO<sub>2</sub>.

---

---

**💧** **Warning:** Do not conduct SpO<sub>2</sub> measurement on the finger smeared with fingernail oil, otherwise unreliable measurement results might be produced.

---

---

**👉** **Note:** When using SpO<sub>2</sub> sensor, care should be taken to shield external light sources, such as light of thermo therapy or ultraviolet heating light, otherwise the measurements may be disturbed. Under such conditions as shock, hypothermia, anemia or the use of blood vessel-activating drugs, and with the existence of such substances as carboxyhemoglobin, methemoglobin, methylene blue the result of the SpO<sub>2</sub> measurement will be possibly not accurate.

---

---

**👉** **Note:**

- Make sure the nail faces to the light window.
  - The wire should be on the backside of the hand.
  - SpO<sub>2</sub> waveform is not proportional to the pulse volume.
-

---

 **Warning:** Do not use the sterile supplied SpO<sub>2</sub> sensors if the packing or the sensor is damaged and return them to the vendor.

---

 **Warning:** Prolonged and continuous monitoring may increase jeopardy of unexpected change of dermal condition such as abnormal sensitivity, rubescence, vesicle, repressive putrescence, and so on. It is especially important to check the sensor placement of neonate and patient of poor perfusion or immature dermogram by light collimation and proper attaching strictly according to changes of the skin. Check per 2~3 hours the sensor placement and move it when the skin deteriorates. More frequent examinations may be required for different patients.

---

### 5.3.4 Setup of SpO<sub>2</sub>/Pulse parameters

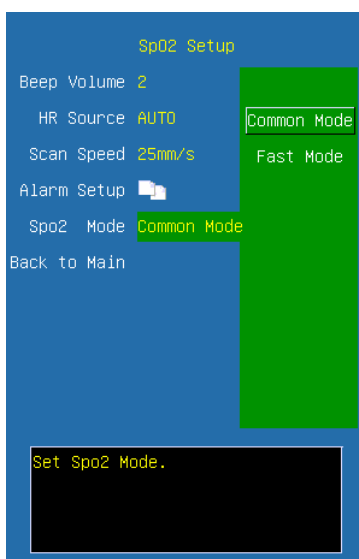

**Beep Volume** Select the BEEP volume and options are **Off, 1, 2, 3, 4, 5, 6**. Once an option is selected, a testing beep will be produced.

**HR source** Select the option of HR source, and options are **AUTO, ECG** and **PLETH**. When selecting **AUTO**, the HR source is ECG with the priority; and if there is no current ECG, the system automatically derives HR from SpO<sub>2</sub>.

**Scan speed** Select the scanning speed of the SpO<sub>2</sub> waveform, and options are **12.5mm/s, 25mm/s** and **50mm/s**.

**Alarm Setup** Click and open the dialog of SpO<sub>2</sub> alarm configuration.

**SpO<sub>2</sub> mode** Select the response time mode for SpO<sub>2</sub>, and options are **Common mode** and **Fast mode**. It is valid only use the Nellcor SpO<sub>2</sub> module.

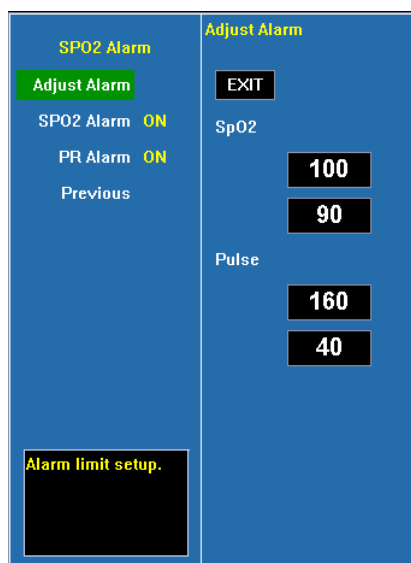

**Adjust alarm** Select this option to enter the configuration of alarm limits; conduct the configurations by turning the trim knob to select high and low limits and exit by selecting **<EXIT>** . The upper part is the high limit and the lower one is the low limit.

**SpO<sub>2</sub> alarm** Select **<ON>** to enable SpO<sub>2</sub> over limit alarm; select **<OFF>** to disable SpO<sub>2</sub> over limit alarm.

**PR alarm** Select **<ON>** to enable PR over limit alarm; select **<OFF>** to disable PR over limit alarm.

### 5.3.5 Maintenance and Cleaning



#### Warning:

- Do not subject the sensor to autoclaving.
- Do not immerse the sensor into any liquid.
- Do not use any sensor or cable that may be damaged or deteriorated.



**Note:** When disposing the disposable SpO<sub>2</sub> probe or useless SpO<sub>2</sub> probe, please observe all local, state, and federal regulations that relate to the disposal of this products or similar products.

For reusable SpO<sub>2</sub> sensor

Please unplug the sensor from the monitor before cleaning or disinfection.

Clean or disinfect the sensor before attaching to a new patient.

#### ■ Cleaning:

Use a piece of clean cloth moistened in water or mild soap solution to clean the sensor and patient contact surfaces.

#### ■ Disinfection:

Use a piece of clean cloth to wipe the sensor and patient contact surfaces with a 10% bleach solution or 70% isopropyl alcohol, clean with clear water and wipe it dry.

### 5.3.6 Signal strength prompt

The signal strength prompt is used to indicate if the SpO<sub>2</sub> signal strength measured is adequacy.

Prompt	Description
Weak Signal	The invalidation weak signal
*	The low intensity signal
**	The medium intensity signal
***	The high intensity signal

## 5.4 Measurement of TEMP

### 5.4.1 Brief Introduction to Measurement of TEMP

Monitor measures TEMP with TEMP sensors. The TEMP module of Monitor uses TEMP cable compatible with YSI-400. The minimum time to get accurate temperature measuring value is 3 minutes.

The monitor has two ports for body TEMP measurement, and can measure the temperature of two channels at the same time.

### 5.4.2 Preparatory Steps of the Measurement of TEMP

- 1) Plug the TEMP cables into the TEMP sockets of the monitor.
- 2) Place the TEMP sensors on body of patient and the screen will show the value of TEMP measurement.
- 3) Set the parameters relevant to TEMP.

### 5.4.3 Connecting Patient and Monitor

Plug the TEMP cable into the sockets marked with TEMP (either of TEMP1 and TEMP2), and then stick the TEMP sensor securely onto the body of patient.



**Caution: The TEMP sensor and cables should be handled with care. When not in use, the sensor and the cable should be rounded into loose ring shape.**

### 5.4.4 Setup of TEMP Parameters

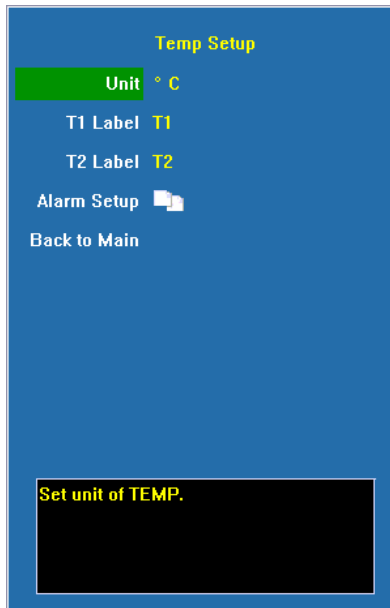

**Unit** Select the unit of TEMP, and options are °C and °F.

**T1 label** Select the labeling name for TEMP 1, and options are **T1, Eso, Naso, Tymp, Rect, Blad** and **Skin**.

**T2 label** Select the labeling name for TEMP 2, and options are **T2, Eso, Naso, Tymp, Rect, Blad** and **Skin**.

Label	Meanings	Label	Meanings
Eso	Esophageal temperature	Rect	Rectal temperature
Naso	Nasopharyngeal temperature	Blad	Bladder temperature
Tymp	Tympanic temperature	Skin	Skin temperature

**Alarm Setup** Click and open the dialog of configuration for TEMP alarm.

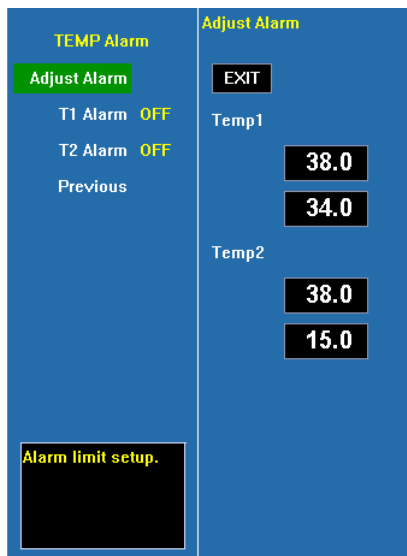

**Adjust alarm** Select this option to enter the configuration of alarm limits; conduct the configurations by turning the trim knob to select high or low limits and exit by selecting **<EXIT>** . The upper part is the high limit and the lower one is the low limit.

**T1 alarm** Select **<ON>** to enable T1 over limit alarm; select **<OFF>** to disable T1 over limit alarm.

**T2 alarm** Select **<ON>** to enable T2 over limit alarm; select **<OFF>** to disable T2 over limit alarm.

### 5.4.5 Maintenance and Cleaning

Reusable temp probes

1. The temp probe should not be heated above 100°C. It should only be subjected briefly to temperatures between 80°C and 100°C.
2. Only detergents containing no alcohol can be used for disinfection.
3. The rectal probes should be used, if possible, in conjunction with a protective rubber cover.

#### ■ **Cleaning:**

Use a piece of clean cloth moistened in water or mild soap solution to clean the probe.

#### ■ **Disinfection:**

Use a piece of clean cloth to wipe the surface of the cable with 70% isopropyl alcohol, a 10% bleach solution or 2% Cidex®, clean with clear water and wipe it dry.

---

 **Warning: Disposable TEMP probes must not be re-sterilized or reused.**

---

 **Note: For protecting environment, the disposable TEMP probe must be recycled or disposed of properly.**

---

 **Disposal Note: Should the TEMP probe become damaged beyond repair, or for some reason its useful life is considered to be at an end, please observe all local, state, and federal regulations that relate to the disposal of this products or similar products.**

---

 **Warning: The calibration of temperature measurement is necessary for every two years (or as frequently as dictated by your Hospital Procedures Policy). When you need calibrate the temperature, contact the manufacture please.**

---

---

 **Note: The self-test of the temperature measurement is performed automatically once every 10 minutes during the monitoring. The test procedure lasts about one second and does not affect the normal measurement of the temperature monitoring.**

---

---

 **Note: If Temperature to be measured beyond probe's measuring range, over measuring range alarm will display on the screen. Check out if probe is on the corresponding patient body site, or change it to other site on the patient.**

---

---

 **Note: If “TEMP self-check error” display on the screen, it is possibly that something is wrong with the temperature capture circuit, the operator should stop using the monitor and contact with the company.**

---

## **5.5 Measurement of NIBP**

### **5.5.1 Brief Introduction to Measurement of NIBP**

Monitor automatically conducts measurement of NIBP with the method of shockwave. The method of shockwave indirectly estimates the systolic and diastolic pressures within the blood vessels by measuring the change of the pressure within blood pressure cuff along with the volume of the arteries and calculates the average pressure.

The measurement time of BP on a calm patient is less than 40s, and when each measurement ends, the cuff automatically deflates to zero.

The monitor applies to any standards of the cuffs for neonate, child and adult (including the cuffs used for arms and legs).

The monitor measures the blood pressure during the time of deflation. Monitor automatically conducts the second and third inflation measurements in case during the first inflation it is unable to measure the value of BP, and gives out the information for measurement failures.

The longest cuff pressure maintaining duration is 120 seconds (90 seconds in neonate mode), and when the time is exceeded, the air will be deflated automatically. The monitor has been designed with hardware protection circuit regarding overpressure, errors of microprocessors, and the occurrence of power failure.

### **5.5.2 Preparatory Steps of Measurement of NIBP**

- 1) Plug the air hose of cuff into the NIBP socket of the monitor and tighten it clockwise to ensure secure contact of the plug and the socket (Please note that the plug should be loosened by turning counterclockwise first before unplugging).
- 2) Tie the cuff on the arm of patient.
- 3) Set the parameters and modes relevant to NIBP.



**Note: Make sure that the air conduit connecting the blood pressure cuff and the monitor is neither blocked nor tangled, and avoid compression or restriction of air conduit.**

---

### 5.5.3 Connecting to Patient and the Monitor

Plug the connector of air hose on cuff into the socket marked with NIBP and wrap the cuff onto the arm of patient. Make sure the mark of  $\Phi$  on the cuff is placed on the femoral artery of the arm and the air hose should be below the cuff so as to ensure the air

hose is not snarled after coming out of the cuff. The white line on the cuff should be within the range of “ $\longleftrightarrow$ ”, otherwise it will be necessary to replace it with a more suitable cuff (smaller or bigger one). The cuff should be placed on the same plane with the heart so as to prevent the errors in readings caused by the effects of hydrostatics of the blood column between the heart and the cuff. If the position of the cuff is higher than the plane of heart, the measured BP readings tend to be smaller; in case the position of the cuff is lower than the plane of the heart, the measured BP readings tend to be higher.



**Note: The accuracy of measurement of BP depends on the suitability of the cuff. Select the size of the cuff according to the size of the arm of patient. The width of the cuff should be 40% of the circumference of the upper arm or 2/3 of the length of the upper arm.**

---



#### **Warning:**

- You must not perform NIBP measurements on patients with sickle-cell disease or under any condition that the skin is damaged or expecting to be damaged.
- For a thrombasthenia patient, it is important to determine whether measurement of the blood pressure shall be done automatically. The determination should be based on the clinical evaluation.
- Prolonged non-invasive blood pressure measurements in Auto mode are



associated with purport, ischemia and neuropathy in the limb wearing the cuff. When monitoring a patient, examine the extremities of the limb frequently for normal color, warmth and sensitivity. If any abnormality is observed, stop the blood pressure measurements.

#### 5.5.4 Setup of NIBP Parameters

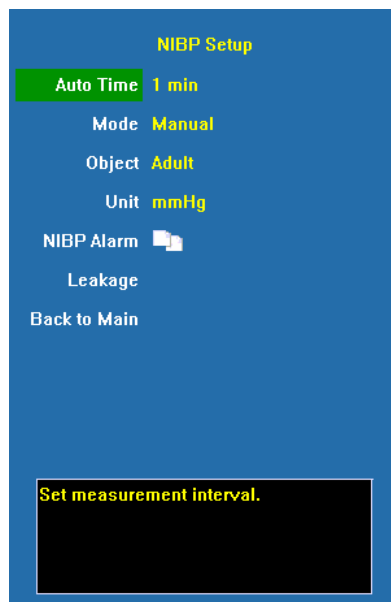

**Auto Time** Configure the cycle intervals of BP measurement and options are **1min**, **2min**, **3min**, **4min**, **5min**, **10min**, **15min**, **30min**, **60min**, **90min**, **2Hour**, **4Hour** and **8Hour**. During measurements, it cannot be altered.

**Mode** Configure the measurement mode of NIBP and options are **Manual**, **Auto** and **STAT**.

If STAT mode is configured, after measurement, the system will be automatically configured as the previous measurement mode. There is no STAT mode for neonatal. If STAT is selected, the rapid measurement will be initiated once it is confirmed.

**Object** Objects of measurements shall be configured, and options are **Adult**, **Children**, **Neonatal** and **Hyperpiesia**. The selection of objects of measurements during the measuring process will terminate the ongoing measurement.

**Unit** Select the unit for the NIBP measurement, and options are **kPa** and **mmHg**.

**Leakage** Air Leakage test

**NIBP Alarm** Click and open the dialog of alarm configuration of NIBP.

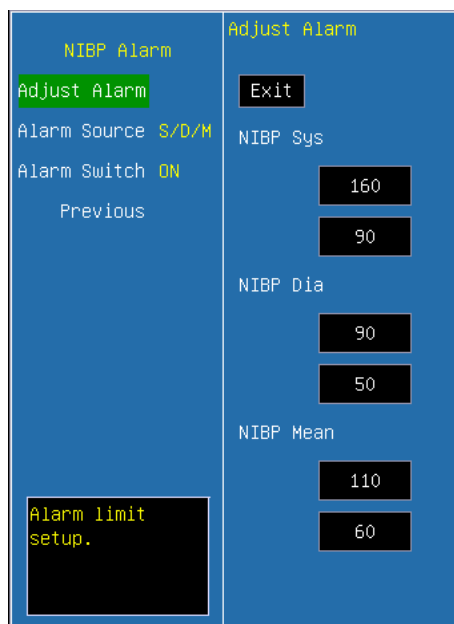

**Adjust alarm** Select this option to enter the configuration of alarm limits; conduct the configurations by turning the trim knob to select high or low limits and exit by selecting **<EXIT>** . The upper part is the high limit and the lower one is the low limit.

**Alarm Source** Select the alarm source for NIBP parameters. When the selected parameter or one of the parameter exceed alarm limit, the monitor will give out alarm signal. The options are as follow:

**<S>**: Only Systolic pressure exceeds the alarm limit will trigger the alarm system.

**<D>**: Only Diastolic pressure exceeds the alarm limit will trigger the alarm system.

**<M>**: Only Mean pressure exceeds the alarm limit will trigger the alarm system.

**<S/M>**: Systolic pressure or mean pressure exceeds the alarm limit will trigger the alarm system.

**<D/M>**: Mean pressure or diastolic pressure exceeds the alarm limit will trigger the alarm system.

**<S/D>**: Systolic pressure or diastolic pressure exceeds the alarm limit will trigger the alarm system.

**<S/D/M>**: Mean pressure, systolic pressure or diastolic pressure exceeds the alarm limit will trigger the alarm system.

**Alarm Switch** Select **<ON>** to enable parameter over limit alarm; select **<OFF>** to disable parameter over limit alarm.

### 5.5.5 Precautions during Measurement

⇒ If the BP of the patient is above 180mmHg, **<HYPER>** measurement mode is recommended.

⇒ When using the STAT measurement or AUTO measurement, if the time duration is relatively

long, care must be taken to check such abnormalities as purple spots, coldness and numbness at the limb end. If there are such phenomena, the cuff should be relocated or the measurement of NIBP should be halted. **To neonate mode, STAT measurement is unavailable.**

⇒ The presence of factors that change the properties of the cardiovascular dynamics of patient will adversely affect the measurement value of the monitor, and shock and hypothermia will also affect the accuracy of the measurement.

⇒ When the built-in main artery balloon pump is applied on the patient, the measurement value of NIBP will be affected.

⇒ For the limb that is on an intravenous drip or in a catheter insertion, or if the patient is connected to the heart-lung machine, or the patient is experiencing shiver or convulsions, the measurement of NIBP cannot be conducted.

⇒ When errors occur in the measurement of NIBP, the error codes will appear in the parameter display zone of the NIBP, and for the cause of the errors, please refer to **chapter 6.8.6.**

#### ⇒ Measurement Limitations

Measurements are impossible with heart rate extremes of less than 40 bpm or greater than 240 bpm, or if the patient is on a heart-lung machine.

The measurement may be inaccurate or impossible:

- 1) If a regular arterial pressure pulse is hard to detect
- 2) With cardiac arrhythmias
- 3) With excessive and continuous patient movement such as shivering or convulsions
- 4) With rapid blood pressure changes
- 5) With severe shock or hypothermia that reduces blood flow to the peripheries
- 6) With obesity, where a thick layer of fat surrounding a limb dampens the oscillations coming from the artery
- 7) On an edematous extremity.

### 5.5.6 Periodic Check

#### ⇒ Calibration





**Warning: The calibration of the NIBP measurement is necessary for every two years (of as frequently as dictated by your Hospital Procedures Policy). The performance should be checked according to the following details.**

---

#### Procedure of the Pressure Transducer Calibration:

- 1) Replace the cuff of the device with a rigid metal vessel with a capacity of 500 ml  $\pm 5\%$ .

- 2) Connect a calibrated reference manometer with an error less than 0.8 mmHg and a ball pump by means of a T-piece connector and hoses to the pneumatic system.
- 3) Access the NIBP menu.
- 4) Turn the trim knob to the **Manometer** option and press. Then the NIBP module has started performing calibration.
- 5) Inflate the pneumatic system to 0, 50 and 200 mmHg by ball pump separately. The difference between the indicated pressure of the reference manometer and the indicated pressure of the monitor will not exceed 3 mmHg. Otherwise, please contact our customer service.
- 6) Press the  /  button on front panel can stop the calibration.

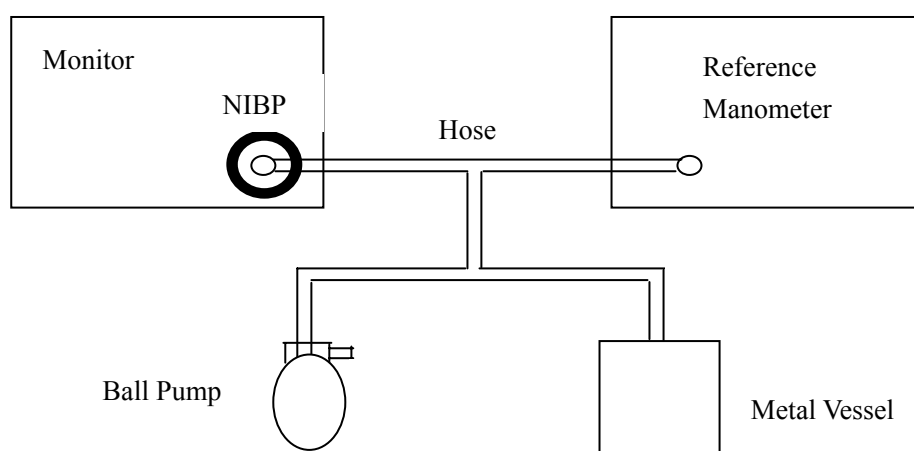



Fig. 5-5-6 Diagram of NIBP calibration

### Air Leakage check

#### Procedure of the air leakage test:

- 1) Connect the cuff securely with the socket for NIBP air hole.
- 2) Wrap the cuff around the cylinder of an appropriate size.
- 3) Access the NIBP setup window.
- 4) Select the **Air Leakage** option and press. Then the prompt “Air Leakage test” will appear on the NIBP parameter area indicating that the system has started performing Air Leakage test.
- 5) The system will automatically inflate the pneumatic system to about 180mmHg.
- 6) After 20 seconds or so, the system will automatically open the deflating valve, which marks the completion of an air leakage test.
- 7) If no error information displays on NIBP parameter area, it indicates that the airway is in good situation and no air leaks exist. However if the prompt “AIR SYSTEM LEAK” appears in the place, it indicates that the airway may have air

leaks. In this case, the user should check for loose connection. After confirming secure connections, the user should re-perform the air leakage test. If the failure prompt still appears, please contact the manufacturer for repair.

- 8) Press the  button on front panel can also stop the test.

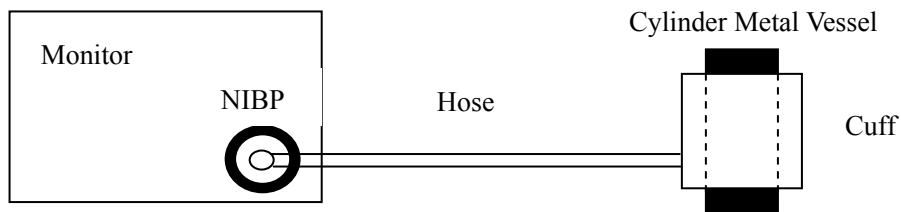





Fig. 5-5-7 Diagram of air leakage check

### 5.5.7 Maintenance and Cleaning

 **Warning:** Do not squeeze the rubber hose on the cuff. Do not allow liquid to enter the connector socked at the front of the monitor. Do not wipe the inner part of the connector socked when cleaning the monitor.

 **Warning:** If liquid is inadvertently splashed on the equipment or its accessories, or may enter the conduit or inside the monitor, contact local customer service center.

 **Warning:** Disposable blood pressure cuff must not be re-sterilized or reused.

 **Disposal Note:** Should the blood pressure cuff become damaged beyond repair, or for some reason its useful life is considered to be at an end, please observe all local, state, and federal regulations that relate to the disposal of this products or similar products.

For Reusable Blood Pressure Cuff:

#### ■ Cleaning:

1. Please clean the cuff termly.
2. Take down the cuff from the connector, take out the bladder from the cover of the cuff.
3. Use a piece of clean cloth moistened in water or mild soap solution to clean the bladder and the tube.
4. Clean the cover of the cuff with the mild soap solution.
5. Dry the cover and the bladder, then take the bladder into the cover to use again.

---

 **Warning:**

- **Clean the bladder frequently, will cause the bladder scathed, except the necessary, do not clean the bladder.**
  - **Do not dry the bladder and cover with high temperature.**
  - **If need the high level disinfecting, please selecting the disposable cuff.**
- 

## **5.6 Measurement of IBP**

### **5.6.1 Brief Introduction to Measurement of IBP**

The method of IBP measurement is direct measuring the BP of artery or veins on the pressure sensor mainly through liquid coupling so as to obtain the pressure curve of the continuous BP.

The IBP parameters of Monitor can select Arterial Pressure (ART), Pulmonary Artery pressure (PA), Left Atrium Pressure (LAP), Right Atrium Pressure (RAP), Central Venous Pressure (CVP), Intracranial Pressure (ICP).

Monitor has two measurement channels for IBP, and the IBP of two channels can be measured at the same time.

### **5.6.2 Preparatory Steps for Measurement of IBP**

- 1) Plug the cable of IBP into the IBP socket (either CH1 or CH2), and connecting cable to the pressure transducer. Fill the pressure transducer and extension tube with saline water mixed with heparin. Press the flexible valve to expel the saline water from the air outlet to expel air bubbles, and then reset it to zero.

---

 **Note: The method of touching test is to touch slightly the surface with finger. Waveforms should appear on the screen of the main unit. The blue ball cover should be put on the surface immediately when the energy converter is not used.**

---

---

 **Note: Anytime the user applies a new transducer, it should be verified or periodically verified according to the hospital operating rules.**

---

---

 **Warning: Disposable pressure transducer should not be reused. And it must be used before expired data. Do read the expired data on the IBP accessory package bag.**

---

**Warning:** When the monitor is used with HF surgical equipment, the transducer and the cables must be avoided conductive connection to the HF equipment to protect against burns to the patient.

The specified transducer is designed to protect against the effects of a discharge of a cardiac defibrillator. When the patient is in the defibrillation, the waveform of IBP maybe distorted temporarily. After the defibrillation, the monitoring will go on normally, the operation mode and the user configuration are not affected.

**Warning:** The operator should avoid contact with the conductive parts of the appurtenance when being connected or applied.

- 2) Plug the cable of IBP into the IBP socket on the right panel of the monitor. Connect the extension tube of the transducer and blood vessel with the artery needles and secure them, then make sure three-way valve 1 and three-way valve 2 (See Fig. 5-6-4) are in a state of ON. At this moment, BP waveforms should appear on the screen of the monitor.
- 3) Set up parameters and modes relevant to IBP.

### 5.6.3 Setup of IBP Parameters



**IBP Label** Select the names of IBP labels. Options are **IBP1**, **IBP2**, **ART**, **CVP**, **PA**, **RAP**, **ICP** and **LAP**.

**Unit** Select the units of IBP, and options are **mmHg**, **kPa** and **cmH<sub>2</sub>O**.

**Scan speed** Select the scanning speed of IBP waveforms, and options are **12.5mm/s**, **25mm/s** and **50mm/s**.

**Wave scales** Select the scale of IBP waveforms and options are **AUTO**, **0~200mmHg**, **0~300mmHg**, **-10~20mmHg** and **-50~300mmHg**.

**Display** Select the format of IBP display, and options are **S/D (M)**, **S/D, Mean** and **M (S/D)**.

**IBP Zero** Conduct zero-calibration on IBP.

**IBP Alarm** Click and open the dialog of IBP alarm limit configuration.

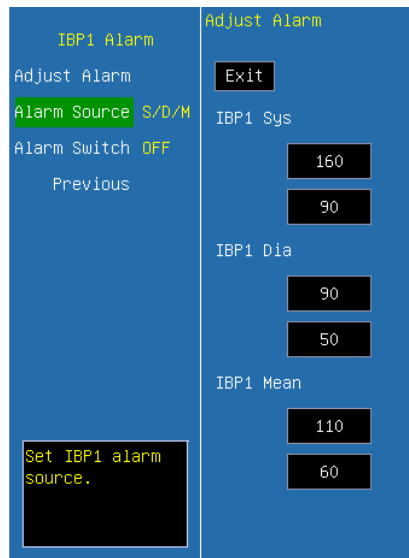

**Adjust alarm** Select this option to enter the configuration of alarm limits; conduct the configurations by turning the trim knob to select high and low limits and exit by selecting **<EXIT>**. The upper part is the high limit and the lower one is the low limit.

**Alarm Source** Select the alarm source for NIBP parameters. When the selected parameter or one of the parameter exceed alarm limit, the monitor will give out alarm signal. The options are as follow:

**<S>**: Only Systolic pressure exceeds the alarm limit will trigger the alarm system.

**<D>**: Only Diastolic pressure exceeds the alarm limit will trigger the alarm system.

**<M>**: Only Mean pressure exceeds the alarm limit will trigger the alarm system.

**<S/M>**: Systolic pressure or mean pressure exceeds the alarm limit will trigger the alarm system.

**<D/M>**: Mean pressure or diastolic pressure exceeds the alarm limit will trigger the alarm system.

**<S/D>**: Systolic pressure or diastolic pressure exceeds the alarm limit will trigger the alarm system.

**<S/D/M>**: Mean pressure, systolic pressure or diastolic pressure exceeds the alarm limit will trigger the alarm system.

**Alarm Switch** Select **<ON>** to enable parameter over limit alarm; select **<OFF>** to disable parameter over limit alarm.



#### 5.6.4 Calibration of Zero-point

Start the unit and preheat it for 3 minutes. If it is in a stable state, turn off three-way valve 2 and turn on three-way valve 1, and then select option in <IBP Zero> of <IBP Setup>, then it can be seen on the screen that the scanning baseline has returned to zero baseline.



**Note:** In the course of zeroing, should turn off the three-way valve near artery needle, don't connect artery needle with patient and make sure there is no air inside the whole tube.

---

#### 5.6.5 Connecting to Patient

As shown in Fig. 5-6-4



**Note:** The pressure measuring side of the transducer should be on the same plane as the heart of the patient in the process of zero-setting and measurement and the user should make sure there is no air inside the whole tube in order to assure the correctness of the measured results. If air is found in tube or in pressure transducer, they must be rinsed by physiological salt solution.

---



**Warning:** If liquid (not the liquid which used to douche the tubes and pressure transducers) spills on equipment or accessories, especially when the liquid is likely to enter the equipment or transducer, contacting with the maintenance department of the hospital immediately.

---

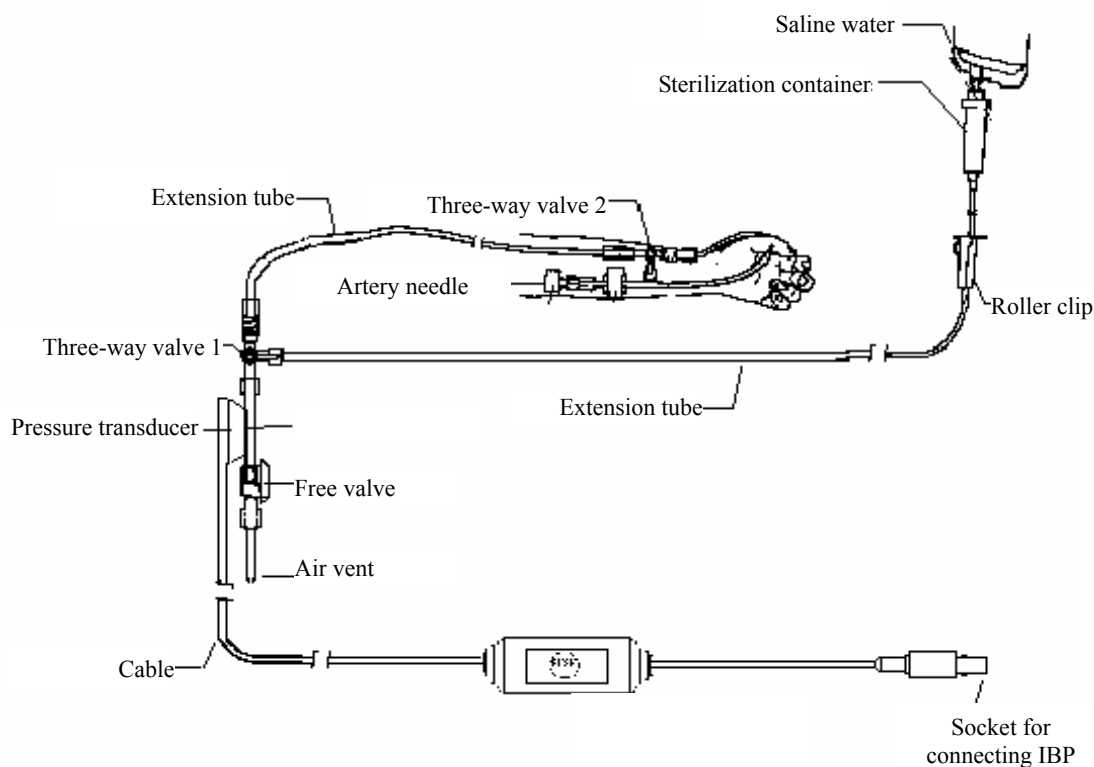



Fig. 5-6-4 Schematic diagram for installation of IBP sensor

### 5.6.6 Setup of Range

The setup of IBP module range can provide you with the best waveforms and the best measurement results. Based on different contents of measurement, there are two ranges for selection, and each group has five options:

- Arterial Pressure (ART):  
 AUTO, 0-50mmHg, 50-150mmHg, 100-240mmHg, 0-300mmHg
- Pulmonary Artery pressure (PA), Left Atrium Pressure (LAP), Right Atrium Pressure (RAP), Central Venous Pressure (CVP), Intracranial Pressure (ICP)  
 AUTO, 0-20mmHg, 0-30mmHg, 0-50mmHg, 0-80mmHg

---

 **Note:** AUTO will adjust the scale on which the pressure waveform is displayed on the screen automatically for the best observation status.

---

### 5.6.7 IBP Transducer Zero and Calibration

#### ■ IBP Transducer Zero

 **Warning: It is the responsibility of the user to ensure that a zero procedure has recently been done on the transducer, otherwise there will be no recent, valid zero value for the instrument to use, which may result in inaccurate measurement results.**

---

#### **Procedure of the IBP Transducer Zero:**

- 1) Turn off patient stopcock before you start the zero procedure.
- 2) The transducer must be vented to atmospheric pressure before the zero procedure.
- 3) The transducer should be placed at the same height level with the heart, approximately mid-axially line.
- 4) Access the Set IBP menu.
- 5) Turn the dial to pick the Zero1 item (Pick the Zero2 item when zeroing channel 2 IBP) and press will start zero the transducer.
- 6) Wait 3 seconds for the Zeroing procedure end and the pressure value that is displayed on screen will approximately return to zero.

 **Caution: Zero procedure should be performed before starting the monitoring and at least once a day and whenever after each disconnect-and-connect of the cable.**

---

#### **■ IBP Calibration**

##### **Caution:**

- Mercury calibration should be performed by the biomedical engineering department either whenever a new transducer is used, or as frequently as dictated by your Hospital Procedures Policy.
- The purpose of the calibration is to ensure that the system gives you accurate measurements.
- Before starting a mercury calibration, a zero procedure must be performed.
- If you need to perform this procedure yourself you will need the following pieces of equipment:
  - Standard sphygmomanometer
  - 3-way stopcock
  - Tubing approximately 25 cm long

#### **The Calibration Procedure:**

 **Warning: You must never perform this procedure while patient is being monitored.**

---

- 1) Close the stopcock that was open to atmospheric pressure for the zero calibration.
- 2) Attach the tubing to the sphygmomanometer.
- 3) Ensure that connection that would lead to patient is off.
- 4) Connect the 3-way connector to the 3-way stopcock that is not connected to the patient catheter.
- 5) Open the port of the 3-way stopcock to the sphygmomanometer.
- 6) Inflate to make the mercury bar rise to 0, 50 and 200 mmHg separately. The difference between the indicated pressure of the sphygmomanometer and the indicated pressure of the monitor will not exceed  $\pm 4\%$  or  $\pm 4$  mmHg, whichever is greater. Otherwise, please contact the manufacturer.
- 7) After calibration, disassemble the blood pressure tubing and the attached 3-way valve.

### 5.6.8 Maintenance and Cleaning

---

 **Warning: The disposable transducers or domes must not be re-sterilized or re-used.**

---

 **Note: For protecting environment, the disposable transducers or domes must be recycled or disposed of properly.**

---

 **Disposal Note: When disposing the disposable transducers or domes and tubing, please observe all local, state, and federal regulations that relate to the disposal of this products or similar products.**

---

## 5.7 Measurement of CO<sub>2</sub> (Sidestream, CPT)

Use the CO<sub>2</sub> measurement to monitor the patient's respiratory status and to control patient ventilation. The measurement principle is primarily based on the fact that CO<sub>2</sub> molecules can absorb special infrared light, where the intensity of infrared light passing the respiratory gas is measured with a photo detector. As some of the infrared light is absorbed by the CO<sub>2</sub> molecules, the amount of light passing the gas probe depends on the concentration of the measured CO<sub>2</sub>.

### 5.7.1 Brief Introduction to Measurement of Sidestream EtCO<sub>2</sub>

- According to the Fig. 5-7-1, snap slantways dehydration flask on the receptacle fixed on the monitor. It will click into place when properly seated.

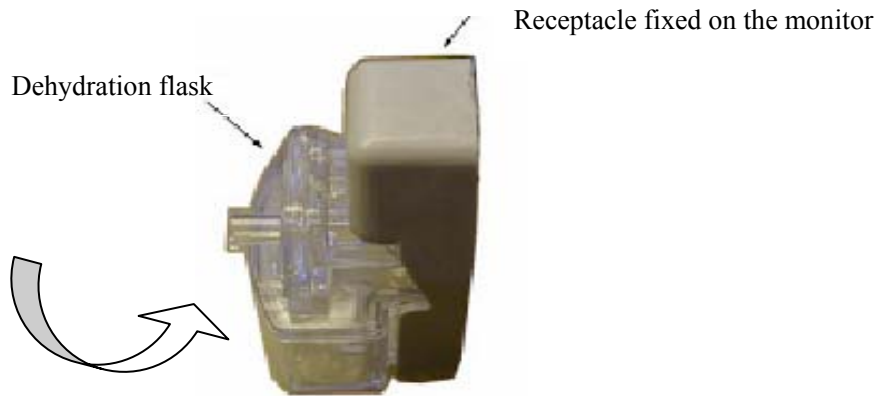

Fig.5-7-1 The installation sketch map of dehydration flask

- According to the Fig. 5-7-2, nip slantways the dehydration flask and disconnect from the receptacle fixed on the right panel of monitor. It will be remove the dehydration flask.

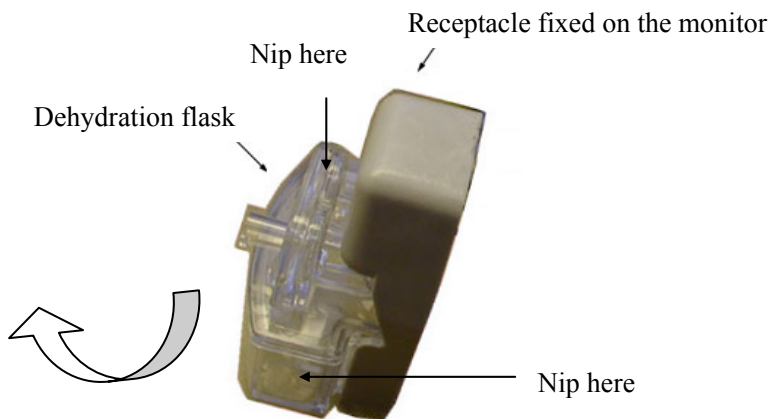

Fig.5-7-2 Remove sketch map of dehydration flask

- According to the Fig. 5-7-3, one end of the sampling tube has been connected with screw thread interface of the dehydration flask, and the other end of the sampling tube has been connected with the screw thread interface tube ( $\Phi 10\text{mm}$ ) of the patient Anaesthesia machine or Ventilator (If not the type screw thread interface tube, please connect the requirement type tube) the sampling tube's port can also been fixed on the naris of patient with adhesive plaster.

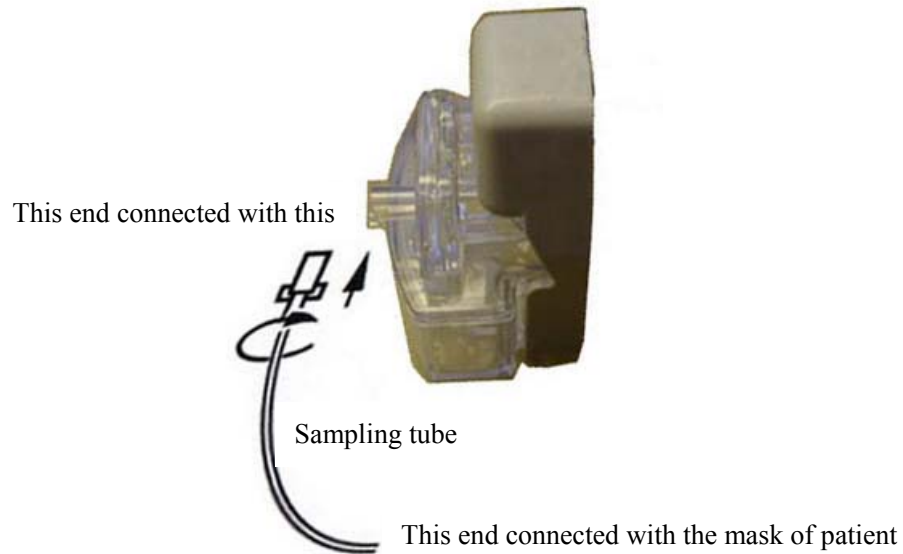



Fig. 5-7-3 Connected with dehydration flask

- Select < **CO<sub>2</sub> Setup**> button in Main Screen, then select the <**Start**> and press this button to start sampling pump, begin measuring EtCO<sub>2</sub>.
- Pay attention to the water level of dehydration flask. If the highest water level reaches, Please replace the dehydration flask in time to prevent the module from soaking by water.
- When air is getting across the sampling tube, a period of time will cost. So, a delay time will appear from starting measure to showing waveform in the screen and measuring result.
- Please keep the sampling tube clean, and prevent the tube from clogging by dust.

---

 **Note: Dehydration flasks and sampling tubes are disposable, please use products provided or designated by manufacturer.**

---

## 5.7.2 Setup of CO<sub>2</sub> parameters

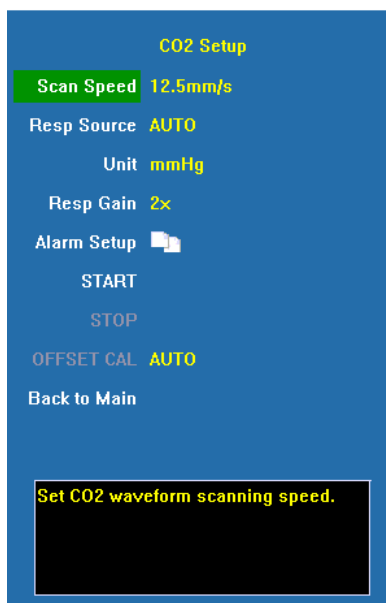

**Scan speed** Select the scanning speed of RESP waveforms, and options are **6.25mm/s**, **12.5mm/s** and **25mm/s**.

**RESP source** Select RESP source. And options are **AUTO**, **ECG** and **EtCO<sub>2</sub>**.

**Unit** Select the unit for CO<sub>2</sub>, and options are **mmHg**, **%** and **kPa**.

**Resp Gain** Select the gain of RESP waveform, and options are **1x**, **2x** and **4x**.

**Alarm setup** Click and open the dialog of CO<sub>2</sub> alarm.

**Start** Press this button to start the sampling pump to initiate the measurement of CO<sub>2</sub> (only valid on sidestream CO<sub>2</sub>).

**Stop** Press this button to switch off the sampling pump and terminate the measurement of CO<sub>2</sub> (only valid on sidestream CO<sub>2</sub>).

**Offset cal** Select the mode of drift calibration. Options are **Cancel**, **Automatic** and **Manual**. During the common measurements, please remain the default configuration as **Automatic**. Only when it is necessary to conduct gain calibration should this option be configured as **Manual (only valid on sidestream CO<sub>2</sub> which sampling pump has been started)**.

**Back to Main** Return to main screen.

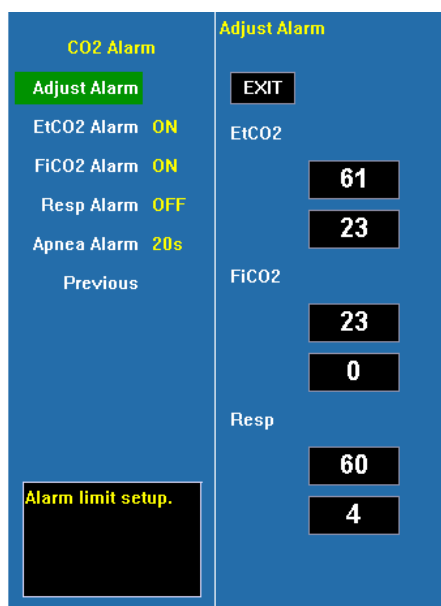

**Adjust alarm** Select this option to enter the configuration of alarm limits; conduct the configurations by turning the trim knob to select high or low limits and exit by selecting <EXIT> . The upper part is the high limit and the lower one is the low limit.

**EtCO<sub>2</sub> alarm high limit**, its configuration range is **0.0~13.1% (0~99.6mmHg)** continuously adjustable, no lower than the low limit; the configuration range of EtCO<sub>2</sub> alarm low limit is **0.0~13.1% (0~99.6mmHg)** continuously adjustable, no higher than the high limit.

**FiCO<sub>2</sub> alarm high limit**, its configuration range is **0.0~13.1% (0~99.6mmHg)** continuously adjustable, no lower than the low limit; the configuration range of FiCO<sub>2</sub> alarm low limit is **0.0~13.1% (0~99.6mmHg)** continuously adjustable, no higher than the high limit.

**RESP alarm high limit**, its configuration range is **0~150 rpm** continuously adjustable, no lower than the low limit; the configuration range of RESP alarm low limit is **0~150rpm** continuously adjustable, no higher than the high limit.

**EtCO<sub>2</sub> alarm** Select <ON> to enable EtCO<sub>2</sub> over limit alarm; select <OFF> to disable EtCO<sub>2</sub> over limit alarm.

**FiCO<sub>2</sub> alarm** Select <ON> to enable FiCO<sub>2</sub> over limit alarm; select <OFF> to disable FiCO<sub>2</sub> over limit alarm.

**RESP alarm** Select <ON> to enable RESP over limit alarm; select <OFF> to disable RESP over limit alarm.

**Apnea alarm** when the time of zero RESP rate has reached this time scale, the alarm will be set off. Options are **Off, 10s, 20s, 40s and 60s**.



---

 **Note: EtCO<sub>2</sub> alarm cannot be switched off.**

---

---

 **Caution: When the monitor is powered on, the pump in the CO<sub>2</sub> module is set off as default configuration. Since long-time running of sampling pump could shorten the life of CO<sub>2</sub> module, please start sampling pump manually, and stop the sampling pump after monitoring has been finished.**

---

### 5.7.3 Gain Calibration

Please carry out gain calibration and manual offset calibration, when the following conditions happened:

1. The module has been used for between half a year and one year.
2. The precision of EtCO<sub>2</sub> reading has been doubted by clinical physician.
3. After the latest calibration, atmospheric pressure or height above sea level varies evidently.

The apparatus has already been calibrated before leaving factory. User can directly apply it to measuring in normal conditions, to the exclusion of the previous conditions.

Gain calibration and manual offset calibration must be carried out if the previous conditions happened. The following procedures must be observed:

1. In parameter setup, please adjust **<VIEW TYPE>** of the CO<sub>2</sub> module to InsCO<sub>2</sub>;  
 When the monitor has been run for 30 minutes, one end of the sampling tube has been connected with the module, the other end has been exposed in the undefined atmosphere, please adjust **<OFFSET CAL>** to **MANU (Manual)** in the CO<sub>2</sub> setup dialog, and press the button of **<OFFSET CAL>** to start offset calibration.

Please connect the adjusting device according to Fig.5-7-4. While the standard gas of pressure CO<sub>2</sub> 5.0% (38.0mmHg) getting across the sampling tube, observe pressure measuring apparatus carefully to ensure that the pressure of standard gas is one standard atmosphere (the range of error is ±5%). Then press the **<GAIN CAL>** of CO<sub>2</sub> parameter setup dialog box, a password input box will emerge. Please input the password to start gain calibration. About five seconds later, the reading having calibrated will be shown in the screen.

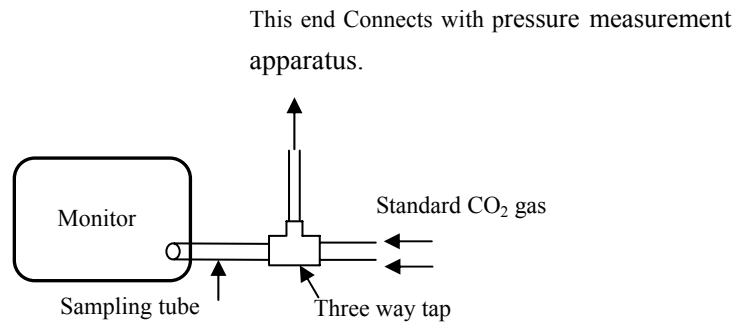



Fig.5-7-4 Gain calibration sketch map

---

 **Warning:** The standard gas of which the pressure of CO<sub>2</sub> is 5.0% (38.0mmHg) must be used during gain calibration. Otherwise, measurement values will not be accurate.

---

---

 **Note:** User may only calibrate the device under the instruction of the technical personnel authorized by company. Moreover, wrong calibrating procedure may result in false reading.

---

## 5.8 Measurement of CO<sub>2</sub> (Mainstream, IRMA)

---

 **Note:** You can only use PHASEIN IRMA mainstream EtCO<sub>2</sub> probe provided by the manufacturer to perform EtCO<sub>2</sub> monitoring on the monitor.

---

### 5.8.1 Preparatory Steps for Measurement of mainstream EtCO<sub>2</sub>

- 1) Plug the IRMA connector into the CO<sub>2</sub> socket on the left panel of the monitor.
- 2) Snap the IRMA sensor head on top of the IRMA airway adapter. It will click into place when properly seated.



- 3) A green LED indicates that the IRMA sensor is ready for use.



- 4) Connect IRMA/airway adapter 15 mm male connector to the breathing circuit Y-piece.



5 ) Connect the IRMA/airway adapter 15 mm female connector to the patient's endotracheal tube.



### 5.8.2 Pre-use check

Perform the tightness check of the patient circuit with the IRMA sensor head snapped on the IRMA airway adapter.

Check that the connections have been made correctly by verifying an actual CO<sub>2</sub> waveform on the monitor display.

### 5.8.3 Room Air calibration

Room air calibration of the oxygen sensor will be performed automatically at regular intervals whenever the IRMA sensor head is disconnected from the IRMA airway adapter.

If the IRMA sensor is kept in operation for a long time period without being disconnected from the airway adapter, or if the operating temperature for the oxygen sensor changes significantly, the IRMA sensor will indicate that a new room air calibration is required and a message will appear on the monitor.

### 5.8.4 Sensor Alarms Indicate

Description of the status LED situated on the IRMA sensor head:

Steady green light	System OK
Steady red light	Sensor error
Blinking red light	Check adapter

### 5.8.5 Setup of CO<sub>2</sub> parameters

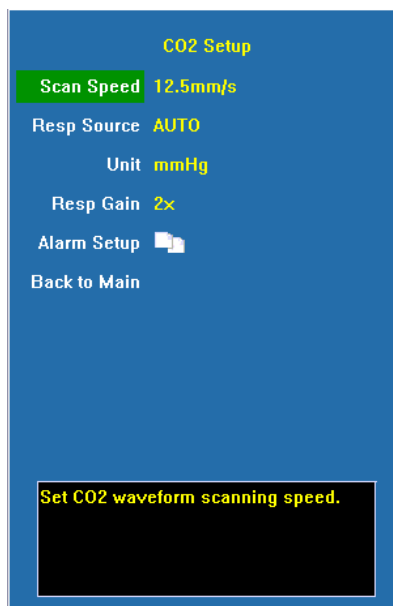

**Scan speed** Select the scanning speed of RESP waveforms, and options are **6.25mm/s**, **12.5mm/s** and **25mm/s**.

**RESP source** Select RESP source. Options are **AUTO**, **ECG** and **EtCO<sub>2</sub>**.

**Unit** Select the unit for CO<sub>2</sub>, Options are **mmHg**, **%** and **kPa**.

**Resp Gain** Select the gain of RESP waveform, and options are **1x**, **2x** and **4x**.

**Alarm Setup** Click and open the dialog of CO<sub>2</sub> alarm.

**Back to Main** Return to main screen.

### 5.8.6 Precautions during Measurement

1. Plug IRMA probe into the CO<sub>2</sub> socket on the left panel of monitor, then connect IRMA/airway adapter to the breathing circuit Y-piece. After the monitor is powered up, and it functions normally with the CO<sub>2</sub> module indicator light turns green. The IRMA CO<sub>2</sub> sensor is ready for use and there is no need to start the sample pump.
2. Do not place the IRMA airway adapter between the ET tube and an elbow, as this may allow patient secretions to block the adapter windows.



3. To keep secretions from pooling on the windows, position the IRMA airway adapter with its windows in a vertical position and not in a horizontal position.

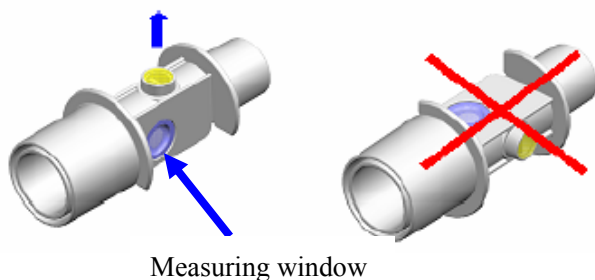

4. To prevent “rain-out” and moisture, from draining into the IRMA airway adapter, do not place the airway adapter in a gravity dependent position.
5. Do not use the IRMA airway adapter with nebulized medications as this may affect the light transmission of the airway adapter windows.
6. Never sterilize or immerse the IRMA sensor in liquid.
7. Do not apply tension to the sensor cable.
8. If error occurs in IRMA sensor, the indicate light will keep in red, and blink in red means the sensor is check the airway adapter.
9. Use a piece of clean cloth and alcohol for IRMA CO<sub>2</sub> cleaning.

## 5.8.7 Maintenance and Cleaning

### 5.8.7.1 Zero reference calibration

Gas readings should be verified with a reference instrument at regular intervals.

A zero reference calibration of the IR measurement should be performed whenever an offset in gas readings is discovered or if “GAS CONC. OUT OF RANGE” alarms appear when measuring room air.

Zero Reference calibration is performed by snapping a new IRMA airway adapter onto the IRMA sensor, without connecting the airway adapter to the patient circuit, and then using the <host instrument> to transmit a calibration command to the IRMA sensor.

Special care should be taken to avoid breathing into the adapter during the zero reference calibration procedure. The presence of ambient air (21% O<sub>2</sub> and 0% CO<sub>2</sub>) in the IRMA airway adapter is of crucial importance for a successful zero reference calibration. Always perform a pre-use check after performing zero reference calibration.

### 5.8.7.2 Cleaning and disinfecting

#### ■ Cleaning:

Use a piece of clean cloth moistened in water or mild soap solution to clean the sensor.

#### ■ Disinfection:

Use a piece of clean cloth to wipe the surface of the sensor with a 70% ethanol or 70% isopropyl alcohol.

## 5.9 Measurement of CO<sub>2</sub> (Microstream, LoFlo)

Use the CO<sub>2</sub> measurement to monitor the patient's respiratory status and to control patient ventilation.

### 5.9.1 Preparing to Measure CO<sub>2</sub>

#### 1. Attaching the LoFlo Module Cable

To attach the LoFlo module cable, plug the cable into the CO<sub>2</sub> socket on the left panel of monitor by matching the key on the cable to the key on the connector.

---

**!** **Caution:** To remove the module cable from the monitor, grasp the collar surrounding the cable and pull up.

---

#### 2. Attaching the Sample Cell

Follow these steps:

1) Insert the LoFlo sample cell into the LoFlo sample cell receptacle. A "click" will be heard when the sample cell is properly inserted. (Fig.5-9-1, Fig.5-9-2)

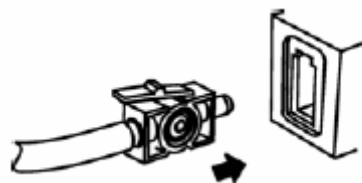

Fig.5-9-1

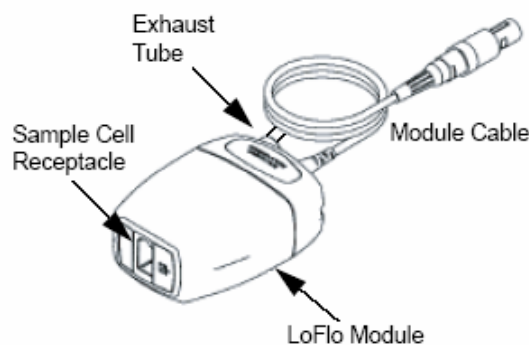

Fig.5-9-2



#### Note:

- Inserting the sample cell into the receptacle automatically starts the sampling pump. Removal of the sample cell turns the sample pump off.
  - To remove the sample cell from the sample cell receptacle, press down on the locking tab and pull the sample cell from the sample cell receptacle.
-

- 2) If the sampling pump fails to turn on, or runs intermittently, perform a “Zero” procedure. (Refer to the chapter 5.9.3)
- 3) Ensure that the LoFlo module exhaust tube vents gases away from the module environment.
- 4) Wait for the CO<sub>2</sub> module to warm up.

The monitor will display the **Sensor Warm Up** message for approximately one minute while the module warms up to operating temperature. The message disappears when the module is ready for use.



**Note: Warm up time varies with ambient temperature of the module.**

### 5.9.2 Setup of CO<sub>2</sub> parameters

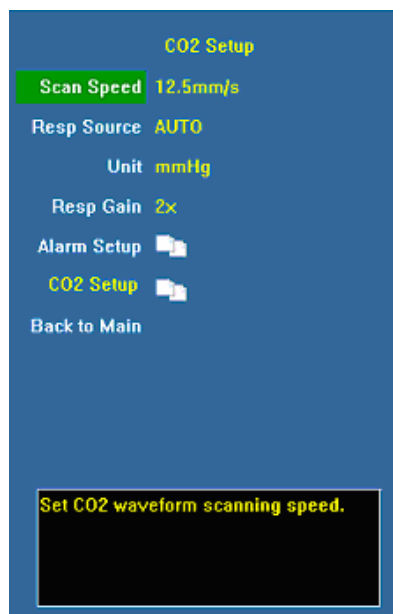

- Scan speed** Select the scanning speed of RESP waveforms, and options are **6.25mm/s**, **12.5mm/s** and **25mm/s**.
- RESP source** Select RESP source. And options are **AUTO**, **ECG** and **EtCO<sub>2</sub>**.
- Unit** Select the unit for CO<sub>2</sub>, and options are **mmHg**, **%** and **kPa**.
- Resp Gain** Select the gain of RESP waveform from ECG, and options are **1x**, **2x** and **4x**.
- Alarm setup** Click and open the dialog of CO<sub>2</sub> alarm.
- CO<sub>2</sub> setup** Click and open the dialog of CO<sub>2</sub> setup.
- Back to Main** Return to main screen.



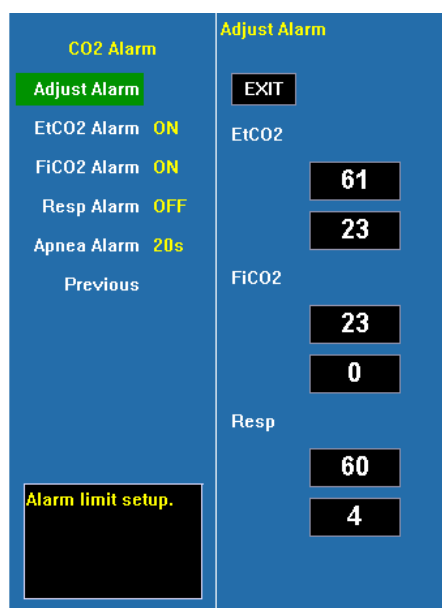

**Adjust alarm** Select this option to enter the configuration of alarm limits; conduct the configurations by turning the trim knob to select high or low limits and exit by selecting **<EXIT>**. The upper part is the high limit and the lower one is the low limit.

**EtCO<sub>2</sub> alarm high limit**, its configuration range is **0.0 ~ 13.1% (0 ~ 99.6mmHg)** continuously adjustable, no lower than the low limit; the configuration range of EtCO<sub>2</sub> alarm low limit is **0.0 ~ 13.1% (0 ~ 99.6mmHg)** continuously adjustable, no higher than the high limit.

**FiCO<sub>2</sub> alarm high limit**, its configuration range is **0.0 ~ 13.1% (0 ~ 99.6mmHg)** continuously adjustable, no lower than the low limit; the configuration range of FiCO<sub>2</sub> alarm low limit is **0.0 ~ 13.1% (0 ~ 99.6mmHg)** continuously adjustable, no higher than the high limit.

**RESP alarm high limit**, its configuration range is **0 ~ 150 rpm** continuously adjustable, no lower than the low limit; the configuration range of RESP alarm low limit is **0 ~ 150rpm** continuously adjustable, no higher than the high limit.

**EtCO<sub>2</sub> alarm** Select **<ON>** to enable EtCO<sub>2</sub> over limit alarm; select **<OFF>** to disable EtCO<sub>2</sub> over limit alarm.

**FiCO<sub>2</sub> alarm** Select **<ON>** to enable FiCO<sub>2</sub> over limit alarm; select **<OFF>** to disable FiCO<sub>2</sub> over limit alarm.

**RESP alarm** Select **<ON>** to enable RESP over limit alarm; select **<OFF>** to disable RESP over limit alarm.

**Apnea alarm** When the time of zero RESP rate has reached this time scale, the alarm will be set off. Options are **Off, 10s, 20s, 40s** and **60s**.

 **Note: EtCO<sub>2</sub> alarm cannot be switched off.**

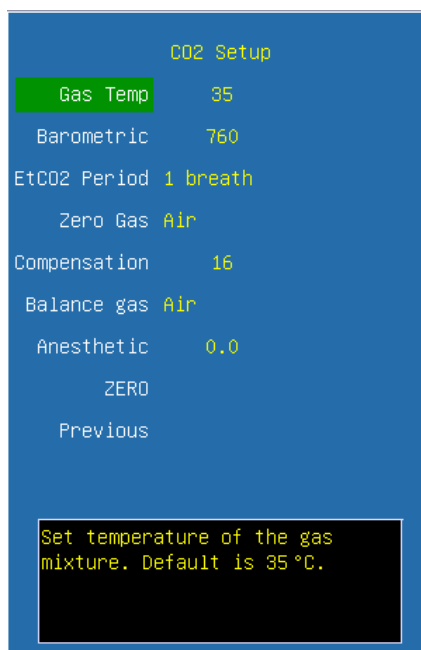

**Gas Temp** Select the temperature of gas. (Turn the trim knob with an increment or decrement of 1 °C)

**Barometric** Select the Atmospheric pressure. (Turn the trim knob with an increment or decrement of 1mmHg)

**EtCO<sub>2</sub> Period** Select the response time of EtCO<sub>2</sub>, the options are **1 breath, 10s** and **20s**.

**Zero Gas** Select the gas type of zeroing, the options are **Air** and **N<sub>2</sub>**.

**Compensation** Select the concentration of oxygen. (Turn the trim knob with an increment or decrement of 1%)

**Balance gas** Select the balance gas type, the options are **Air, N<sub>2</sub>O** and **Helium**.

**Anesthetic** Select the concentration of balance gas. (Turn the trim knob with an increment or decrement of 0.1%)

**Zero** Press the button to start zeroing. It is only valid when the system detects that the module can be zeroed.

### 5.9.3 Zero

Zeroing allows the LoFlo module or CAPNOSTAT 5 sensor to adjust to the optical characteristics, in order to obtain accurate readings. While zeroing is recommended the first time a LoFlo module or CAPNOSTAT 5 sensor is connected to the unit, it is only absolutely necessary when the message **Zero Required** is displayed.



**Warning:**

- Always ensure that the sample cell is properly connected to the LoFlo module before zeroing.
  - Always ensure that the CAPNOSTAT5 sensor is properly connected to the airway adapter before zeroing.
- 

Follow these steps:

1) Ensure that the nasal cannula or airway adapter is not connected to the patient or close to any source of CO<sub>2</sub> (including the patient's, your own, exhaled breath and ventilator exhaust valves).

1) Press the **<Zero>** option in **<CO<sub>2</sub> Setup>** menu. The unit zeroes the module and displays the **Zero In Progress** message for approximately 15-20 seconds. The message disappears upon completion of the zeroing.

---



**Note:**

- Do not attempt zeroing for 20 seconds after removing the adapter or cannula from the patient's airway. This time allows any CO<sub>2</sub> remaining in the adapter or cannula to dissipate before zeroing.
  - Do not attempt to zero the module while the adapter or cannula is in the patient's airway.
  - Do not attempt zeroing if the temperature is not stable.
  - Zeroing with CO<sub>2</sub> in the adapter or cannula can lead to inaccurate measurements or other error conditions. If you attempt zeroing while CO<sub>2</sub> remains in the adapter or cannula, the time required to zero the module may be increased.
- 

#### 5.9.4 Applying Microstream airway adapter or cannula

For intubated patients requiring an airway adapter: Install the airway adapter at the proximal end of the circuit between the elbow and the ventilator Y section. (Fig.5-9-3)

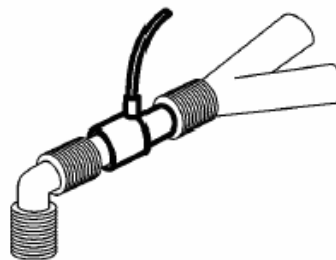

Fig.5-9-3

For intubated patients with an integrated airway adapter in the breathing circuit:  
Connect the male connector on the straight sample line to the female port on the airway adapter. (Fig.5-9-4)

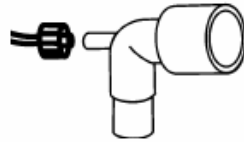

Fig.5-9-4

For non-intubated patients: Place the nasal cannula onto the patient. (Fig.5-9-5)

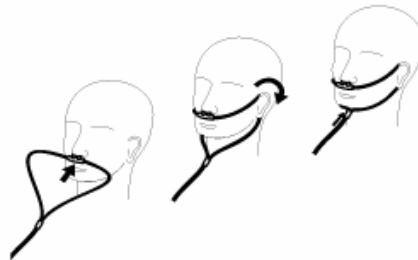

Fig.5-9-5

For patients prone to mouth breathing use an oral-nasal cannula. Trim the oral sampling tip if necessary to fit the patient. It should extend down past the teeth and be positioned in the mouth opening. Remove the cannula from the patient if the tip needs to be trimmed. (Fig.5-9-6)



Fig.5-9-6

For nasal or oral-nasal cannulas with oxygen delivery, place the cannula on the patient as shown then attach the oxygen supply tubing to the oxygen delivery system and set the prescribed oxygen flow.

---

**Warning:** Always connect the airway adapter to the sensor before inserting the airway adapter into the breathing circuit. In reverse, always remove the airway adapter from the breathing circuit before removing the sensor.

---

**Caution:** Always disconnect the cannula, airway adapter or sample line from the sensor when not in use.

---

### 5.9.5 Removing Exhaust Gases from the System

---



**Warning:** When using the microstream CO<sub>2</sub> measurement on patients who are receiving or have recently received anesthetics, connect the outlet to a scavenging system, or to the anesthesia machine/ventilator, to avoid exposing medical staff to anesthetics.

---

Use an exhaust tube to remove the sample gas to a scavenging system. Attach it to the microstream sensor at the outlet connector.

### 5.9.6 Safety considerations

---



**Warning:**

- Do not use in the presence of flammable anesthetics or other flammable gasses. Use of the LoFlo Module in such environment may present an explosion hazard.
  - **Electrical Shock Hazard:** Always disconnect the LoFlo Module before cleaning. Do not use if it appears to have been damaged. Refer servicing to qualified service personnel.
  - Do not position the sensor cables or tubing in any manner that may cause entanglement or strangulation.
  - Reuse, disassembly, cleaning, disinfecting or sterilizing the single patient use cannula kits and on-airway adapters may compromise functionality and system performance leading to a user or patient hazard. Performance is not guaranteed if an item labeled as single patient use is reused.
  - Inspect the microstream on- airway adapters, microstream sampling kits and CO<sub>2</sub> airway adapters for damage prior to use. Do not use the microstream on-airway adapters, microstream sampling kits and CO<sub>2</sub> airway adapters if they appear to be damaged or broken.
  - Replace the microstream on- airway adapters, microstream sampling kits and CO<sub>2</sub> airway adapters if excessive secretions are observed.
  - Monitor the CO<sub>2</sub> waveform (Capnogram). If you see changes or abnormal appearance check the airway adapters and the sampling line. Replace it if needed.
  - Do not operate the LoFlo Module when it is wet or has exterior condensation.
  - Do not apply excessive tension to any cable.
  - Do not use device on patients that can not tolerate the withdrawal of 50 ml/min±10 ml/min from the airway or patients that can not tolerate the added dead space to the airway.
  - Do not connect the exhaust tube to the ventilator circuit.
-



**Caution:**

- **Use only accessories provided by manufacturer.**
  - **Do not sterilize or immerse the LoFlo Module in liquids.**
  - **Do not clean the LoFlo Module and accessories except as directed in this manual.**
  - **Remove the LoFlo sampling kit sample cell from the receptacle when not in use.**
  - **Do not stick appendage into sample receptacle.**
  - **Always insert sample cell before inserting the on-airway adapter into the ventilated circuit**
  - **Always remove the on-airway adapter from the ventilated circuit before removing the sample cell.**
- 



**Note:**

- **This product and its accessories are latex free.**
  - **After the life cycle of the LoFlo Module and its accessories have been met, disposal should be accomplished following national and local requirements.**
  - **Nitrous oxide, elevated levels of oxygen and helium can influence the CO<sub>2</sub> measurement. Please setup gas compensation according to actual state.**
  - **Barometric pressure compensation is required to meet the stated accuracy of the LoFlo Module.**
-

## 5.10 Measurement of CO<sub>2</sub>(Mainstream, CAPNOSTAT5)

### 5.10.1 Preparing to Measure CO<sub>2</sub>

#### 1. Attaching the CAPNOSTAT 5 sensor cable

To attach the CAPNOSTAT 5 sensor cable, plug the cable into CO<sub>2</sub> socket on the left panel of monitor by matching the key on the cable to the key on the connector.

---

 **Caution: To remove the sensor cable from the monitor, grasp the collar surrounding the cable and pull up.**

---

#### 2. Selecting a mainstream airway adapter

Select an airway adapter based on the patient's size, ET tube diameter and monitoring situation. For more information refer to the following table or contact manufacturer.

Airway Adapter Type	ET Tube Diameter
SPU* Pediatric/Adult	> 4.0 mm
Adult Reusable	> 4.0 mm
SPU* Neonatal/Pediatric	≤ 4.0 mm
Neonatal Reusable	≤ 4.0 mm

\*SPU = Single Patient Use

#### 3. Attaching the airway adapter to the CAPNOSTAT 5 sensor

Before attaching the airway adapter to the CAPNOSTAT 5 sensor, verify that the airway adapter windows are clean and dry. Clean or replace the adapter if necessary. Follow these steps:

- 1) Align the arrow on the bottom of the airway adapter with the arrow on the bottom of the sensor.
- 2) Press the sensor and airway adapter together until they click.
- 3) Wait for the airway adapter and sensor to warm up.

The monitor will display the **Sensor Warm Up** message for approximately one minute while the sensor and adapter warm to operating temperature. The message disappears when the sensor is ready for use.

---

 **Note: Warm up time varies with ambient temperature of the module.**

---

#### 4. Zero

Please refer to chapter 5.9.3

#### 5. Attaching the airway adapter to the airway circuit

After zeroing, attach the airway adapter to the airway circuit as follow.(Fig.5-10-1)

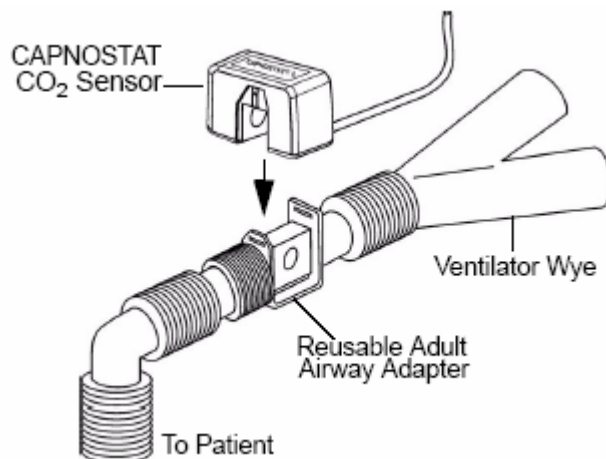

Fig.5-10-1

#### 6. Ensure the airway air-proof and ready to measure

##### 5.10.2 Setup of CO2 parameter

Please refer to chapter 5.9.2

##### 5.10.3 Zero

Please refer to chapter 5.9.3

##### 5.10.4 Safety considerations



#### Warning:

- **Do not use in the presence of flammable anesthetics or other flammable gasses. Use of the CAPNOSTAT5 sensor in such environment may present an explosion hazard.**
- **Electrical Shock Hazard: Always disconnect the CAPNOSTAT5 sensor before cleaning. Do not use if it appears to have been damaged. Refer servicing to qualified service personnel.**
- **Do not position the sensor cables or tubing in any manner that may cause entanglement or strangulation.**
- **Reuse, disassembly, cleaning, disinfecting or sterilizing the single patient use CO2 airway adapters may compromise functionality and system performance leading to a user or patient hazard. Performance is not guaranteed if an item labeled as**



single patient use is reused.

- Inspect the CO<sub>2</sub> airway adapters for damage prior to use. Do not use the CO<sub>2</sub> airway adapters if they appear to be damaged or broken.
  - Replace the CO<sub>2</sub> airway adapters if excessive secretions are observed.
  - If the CO<sub>2</sub> waveform (Capnogram) appears abnormal, inspect the CO<sub>2</sub> airway adapters and replace if needed.
  - Monitor the CO<sub>2</sub> waveform (Capnogram) for elevated baseline. Elevated baseline can be caused by sensor or patient problems.
  - Periodically check the CAPNOSTAT5 sensor and tubing for excessive moisture or secretion buildup.
  - Do not operate the CAPNOSTAT5 sensor when it is wet or has exterior condensation.
- 



**Caution:**

- Use only accessories provided by manufacturer.
  - Do not sterilize or immerse the CAPNOSTAT5 sensor in liquids.
  - Do not clean the CAPNOSTAT5 sensor and accessories except as directed in this manual.
  - It is recommended that the CO<sub>2</sub> sensor be removed from the circuit whenever an aerosolized medication is delivered. This is due to the increased viscosity of the medications which may contaminate the sensor windows, causing the sensor to fail prematurely.
  - Do not apply excessive tension to the CAPNOSTAT5 sensor cable.
- 



**Note:**

- This product and its accessories are latex free.
  - After the life cycle of the CAPNOSTAT5 sensor and its accessories have been met, disposal should be accomplished following national and local requirements.
  - Nitrous oxide, elevated levels of oxygen and helium can influence the CO<sub>2</sub> measurement. Please setup gas compensation according to actual state.
  - Barometric pressure compensation is required to meet the stated accuracy of the CAPNOSTAT5 sensor.
  - Do not place the combined CO<sub>2</sub> sensor between the ET tube and the elbow (pediatric or adult circuit), as this may allow patient secretions to block the adapter windows.
  - Position the combined CO<sub>2</sub> sensor with its windows in a vertical and not a horizontal position: this helps keep patient secretions from pooling on the windows.
-

### **5.10.5 Maintenance and cleaning**

#### **For CAPNOSTAT 5 Sensor and LoFlo Module**

The outside of the module or sensor may be cleaned and disinfected by wiping with 70% isopropyl alcohol, a 10% bleach solution, or mild soap. After cleaning, wipe with a clean, water-dampened cloth to rinse. Dry before use.

#### **For Reusable Airway Adapters**

Reusable airway adapters may be cleaned by rinsing in a warm soapy solution, followed by soaking in a liquid disinfectant such as 70% isopropyl alcohol, a 10% bleach solution, Cidex® or System 1® (refer to the disinfectant manufacturer's instructions for use).

Adapters should then be rinsed with sterile water and dried.

Reusable airway adapters may also be pasteurized or autoclaved. Autoclave at 121°C (250°F) for 20 minutes, unwrapped.

Before reusing the adapter, ensure the windows are dry and residue-free, and that the adapter has not been damaged during handling or by the cleaning process.

## 5.11 Measurement of AG(IRMA)

AG module is used to measure respiratory and anesthetic gases of a patient during anesthesia. It is applicable for adult and pediatric usage.

The measuring principle is that anesthetic gas can absorb infrared light. Gases that can be measured by AG module are able to absorb infrared light. Besides, each gas has its own absorption characteristic. First the gas is driven into a sample cell. Then the optic infrared filter selects the infrared light with special wavelength to penetrate this gas. For a given volume, the higher the gas concentration is, the more infrared light are absorbed. We may measure the quantity of the infrared light that have penetrated the gas and then calculate the gas concentration via specialized formula. If you desire to measure multiple gases, you should install various infrared filters in the AG module

MAC is defined as the minimum alveolar concentration at steady-state that prevents reaction to a standard surgical stimulus (skin incision) in 50% of patients at 1 atmosphere (i.e. sea level).



**Note: The AG measurement of monitor can only uses PHASEIN IRMA mainstream probe provided by the manufacturer.**

---

### 5.11.1 Preparatory Steps for Measurement of AG

- 1) See 5.8.1 for preparatory steps
- 2) A green LED indicates that the IRMA sensor is ready for use. A blue LED indicates that may measurement of AG.

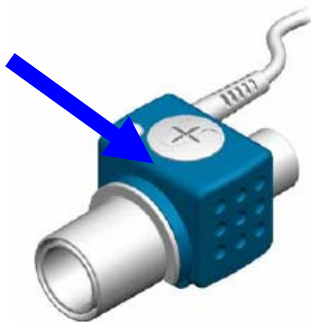

- 3) Always position the IRMA sensor with the O<sub>2</sub> cell pointing upwards. And the O<sub>2</sub> cell can be taken out by whirling it.

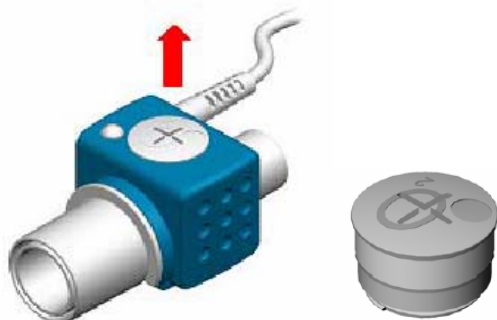

### 5.11.2 Pre-use check

- 1、 Before connecting the IRMA airway adapter to the breathing circuit, verify the O<sub>2</sub> calibration by checking that the O<sub>2</sub> reading on the monitor is correct (21%). See 5.8.3 for instructions on how to perform room air calibration.
- 2、 Verify that there has not been any accumulation of gas between the IRMA sensor head and the BLUEYE windows by checking that the CO<sub>2</sub> and Agent readings on the monitor are correct before connecting a patient to the breathing circuit.
- 3、 Perform the tightness check of the patient circuit with the IRMA sensor head snapped on the IRMA airway adapter.
- 4、 Check that the connections have been made correctly by verifying an actual gas waveform on the monitor display.

### 5.11.3 Room Air Calibration

Room air calibration of the oxygen sensor will be performed automatically at regular intervals whenever the IRMA sensor head is disconnected from the IRMA airway adapter.

If the IRMA sensor is kept in operation for a long time period without being disconnected from the airway adapter, or if the operating temperature for the oxygen sensor changes significantly, the IRMA sensor will indicate that a new room air calibration is required and a message will appear on the monitor.

Use the following procedure to perform a room air calibration of the oxygen sensor:

1. Disconnect the IRMA sensor from the airway adapter.
2. Wait until the LED starts blinking with red light.
3. Snap the IRMA sensor back on the airway adapter.
4. Check that the LED turns green.
5. Check that the O<sub>2</sub> reading on the monitor is 21%.

### 5.11.4 Sensor Alarms Indicate

Description of the status LED situated on the IRMA sensor head:

Steady green light	System OK
Steady blue light	Anesthetic agent present
Steady red light	Sensor error
Blinking red light	Check adapter

### 5.11.5 Setup of AG parameter

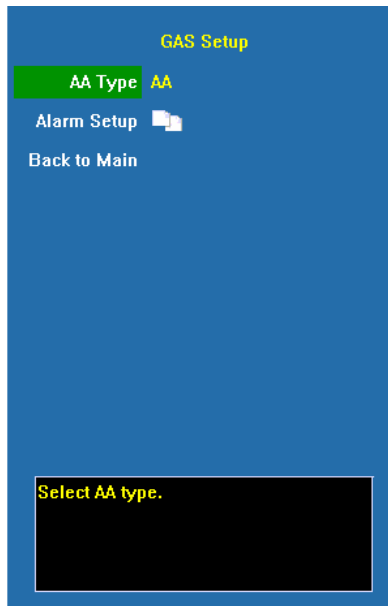

**AA type** Select the types of anesthetic gas, and options are **AA**, **HAL**, **ENF**, **ISO**, **SEV** and **DES**. After the monitor is turn on, if no AA types are configured, there will be a technical alarm prompting the configuration of AA and need to designate a kind of anesthetic gas. Considering safety, the configuration will not be saved after the monitor is switched off.

Label	Meanings	Label	Meanings
<b>AA</b>	Anesthetic agent	<b>ISO</b>	Isoflurane
<b>HAL</b>	Halothane	<b>SEV</b>	Sevoflurane
<b>ENF</b>	Enflurane	<b>DES</b>	Desflurane

**Alarm Setup** Click and open the dialog of anesthetic gas.

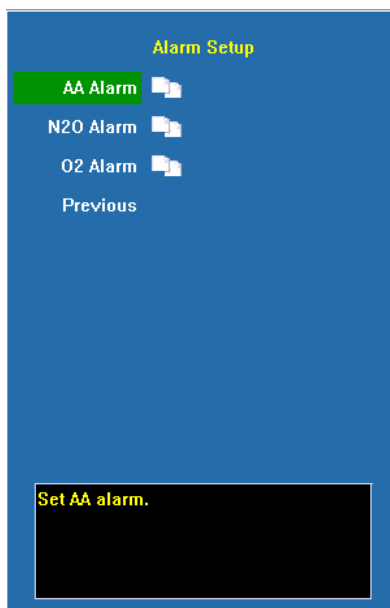

- **AA alarm** Click and open the dialog of AA alarm.

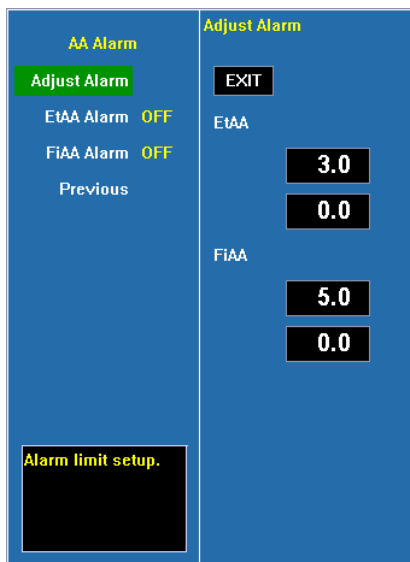

**Adjust alarm** Select this option to enter the configuration of alarm limits; conduct the configurations by turning the trim knob to select high and low limits and exit by selecting **<EXIT>** .The upper part is the high limit and the lower one is the low limit.

**EtAA alarm high limit**, its configuration range is **0.0~30.0%** continuously adjustable, no lower than the low limit; the configuration range of EtAA alarm low limit is **0.0~30.0%** continuously adjustable, no higher than the high limit.

**FiAA alarm high limit**, its configuration range is **0.0~30.0%** continuously adjustable, no lower than the low limit; the configuration range of FiAA alarm low limit is **0.0~30.0%** continuously adjustable, no higher than the high limit.

**EtAA alarm** Select **<ON>** to enable EtAA over limit alarm; select **<OFF>** to disable EtAA over limit alarm.

**FiAA alarm** Select <ON> to enable FiAA over limit alarm; select <OFF> to disable FiAA over limit alarm.

- **O<sub>2</sub> alarm** Click and open the dialog of O<sub>2</sub> alarm.

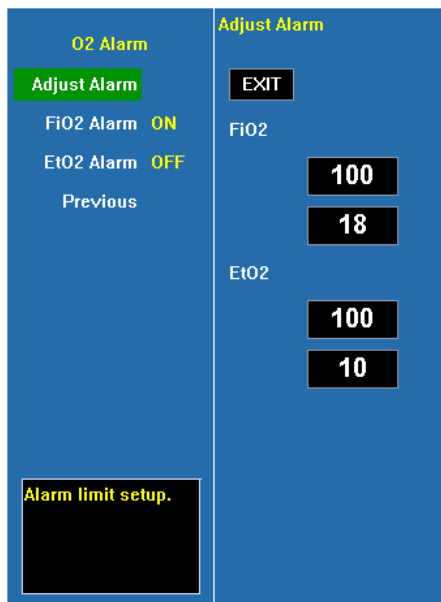

**Adjust alarm** Select this option to enter the configuration of alarm limits. conduct the configurations by turning the trim knob to select high and low limits and exit by selecting <EXIT> . The upper part is the high limit and the low one is the low limit.

**FiO<sub>2</sub> alarm high limit**, its configuration range is **18~100%** continuously adjustable, no lower than the low limit; the configuration range of FiO<sub>2</sub> alarm low limit is **18~100%** continuously adjustable, no higher than the high limit. **FiO<sub>2</sub> alarm cannot be switched off, and when lower than 18% it will trigger high alarm.**

**EtO<sub>2</sub> alarm high limit**, its configuration range is **18~100%** continuously adjustable, no lower than the low limit; the configuration range of EtO<sub>2</sub> alarm low limit is **18~100%** continuously adjustable, no higher than the high limit.

**FiO<sub>2</sub> alarm** Select <ON> to enable FiO<sub>2</sub> over limit alarm; select <OFF> to disable FiO<sub>2</sub> over limit alarm.

**EtO<sub>2</sub> alarm** Select <ON> to enable EtO<sub>2</sub> over limit alarm; select <OFF> to disable EtO<sub>2</sub> over limit alarm.

---

 **Note: FiO<sub>2</sub> alarm cannot be switched off.**

---

- **N<sub>2</sub>O alarm** Click and open the dialog of N<sub>2</sub>O alarm.

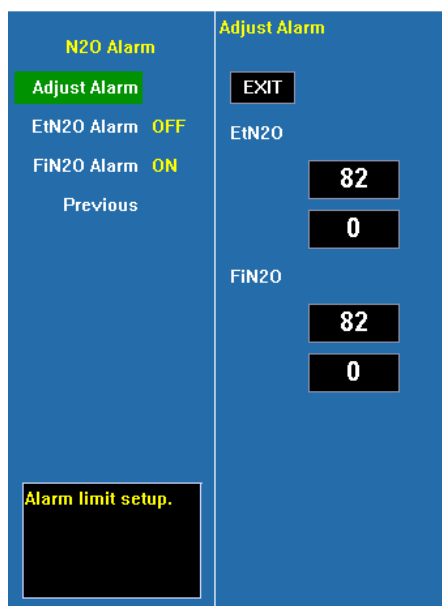

**Adjust alarm** Select this option to enter the configuration of alarm limits; conduct the configurations by turning the trim knob to select high and low limits and exit by selecting **<EXIT>**. The upper part is the high limit and the lower one is the low limit.

**FiN<sub>2</sub>O alarm high limit**, its configuration range is **0~100%** continuously adjustable, no lower than the low limit; the configuration range of FiN<sub>2</sub>O alarm low limit is **0~100%** continuously adjustable, no higher than the high limit.

**EtN<sub>2</sub>O alarm high limit**, its configuration range is **0~100%** continuously adjustable, no lower than the low limit; the configuration range of EtN<sub>2</sub>O alarm low limit is **0~100%** continuously adjustable, no higher than the high limit.

**FiN<sub>2</sub>O alarm** Select **<ON>** to enable FiN<sub>2</sub>O over limit alarm; select **<OFF>** to disable FiN<sub>2</sub>O over limit alarm.

**EtN<sub>2</sub>O alarm** Select **<ON>** to enable EtN<sub>2</sub>O over limit alarm; select **<OFF>** to disable EtN<sub>2</sub>O over limit alarm.

### 5.11.6 Precautions during Measurement

1. See 5.8.6
2. The lifetime of the IRMA oxygen sensor cell is up to six months since its leaving factory. If it cannot work normally or the parameter cannot be accurately measured due to exceeding time limit, please timely change the oxygen sensor cell.
3. If the IRMA airway adapter is detached from the sensor, or low voltage of oxygen sensor cell, or there is something wrong with the sensor, the prompting message may pop up on one of above conditions.



### **5.11.7 Maintenance and Cleaning**

#### **5.11.7.1 Oxygen sensor replacement**

Replace the oxygen sensor every four months, when indicated by the monitor or whenever the oxygen readings are questionable.

#### **5.11.7.2 Zero reference calibration**

Gas readings should be verified with a reference instrument at regular intervals.

A zero reference calibration of the IR measurement should be performed whenever an offset in gas readings is discovered or if “GAS CONC. OUT OF RANGE” alarms appear when measuring room air.

Zero Reference calibration is performed by snapping a new IRMA airway adapter onto the IRMA probe, without connecting the airway adapter to the patient circuit, and then using the <host instrument> to transmit a calibration command to the IRMA probe. Allow the IRMA probe to warm up for at least 15 minutes after power on, and 2 minutes after changing airway adapter, before transmitting the calibration command.

Zero Reference calibration is performed by snapping a new IRMA airway adapter onto the IRMA sensor, without connecting the airway adapter to the patient circuit, and then using the <host instrument> to transmit a calibration command to the IRMA sensor.

Special care should be taken to avoid breathing into the adapter during the zero reference calibration procedure. The presence of ambient air (21% O<sub>2</sub> and 0% CO<sub>2</sub>) in the IRMA airway adapter is of crucial importance for a successful zero reference calibration. Always perform a pre-use check after performing zero reference calibration.



**Warning: Incorrect probe zero calibration will result in false gas readings.**

---

#### **5.11.7.3 Cleaning and disinfecting**

##### **■ Cleaning:**

Use a piece of clean cloth moistened in water or mild soap solution to clean the sensor.

##### **■ Disinfection:**

Use a piece of clean cloth to wipe the surface of the sensor with a 70% ethanol or 70% isopropyl alcohol.

## Chapter 6 Alarm

This chapter gives general information about the alarm and corresponding remedies.



**Note: The equipment generates all the auditory and visual alarms through speaker, LED and screen.**

---

### 6.1 Alarm Category and level

There are two kinds of alarms, defined as physiological alarm and technical alarm. Physiological alarms refer to those alarms triggered by patient's physiological situation which could be considered dangerous to his or her life, such as SpO<sub>2</sub> exceeding alarm limit (parameter alarms). Technical alarms refer to system failure, which can make certain monitoring process technically impossible or make monitoring result unbelievable. General alarm belongs to those situations that cannot be categorized into these two cases but still need to pay some attention. Each alarm, either technical or physiological, has its own priority.

Alarms in the monitor are divided into three priorities, that is: high level, medium level and low level.

- High level alarm indicates the patient's life is in danger. It is the most serious alarm.
- Medium level alarm means serious warning.
- Low level alarm is a general warning.

Only alarm level of parameters exceeding limits alarm can be modified by the user, the other alarm level of physiological and technical alarms are preset by the system and they can not be changed by the user.

### 6.2 Alarm Modes

When alarm occurs, the monitor may raise the user's attention in two ways, which are auditory prompt, visual prompt and description. Visual prompt is given by alarm indicating lamp and screen of the monitor, auditory prompt is given by speaker in the device. Physiological alarm information is displayed in the Physiological Alarm area. Most of technical alarm information is displayed in the Technical Alarm area. Technical alarms related to NIBP measurement are displayed in the NIBP parameter area.

The Physiological Alarm area is on the upmost right part of the screen. The Technical Alarm area is to the left side of the Physiological Alarm area.

The alarm sound and visual display comply with clause 201.3.2 of the standard IEC 601-1-8.

---

 **Note: The concrete presentation of each alarm prompt is related to the alarm priority.**

---

#### ☰ Alarm Sound

The high/medium/low-level alarms are indicated by the system in following different audio ways:

Alarm level	Audio prompt
High	Mode is “DO-DO-DO-----DO-DO, DO-DO-DO-----DO-DO”, which is triggered once every 10 seconds.
Medium	Mode is “DO-DO-DO”, which is triggered once every 25 seconds.
Low	Mode is “DO-”, which is triggered once every 25 seconds.

#### ☰ Alarm Lamp light

When technical alarm occurs, the technical alarm lamp lights on in blue.

When physiological alarm occurs, the physiologic alarm lamp lights according to the alarm level.

The high/medium/low-level alarms are indicated by the system in following different visual ways:

Alarm level	Visual prompt
High	Alarm indicating lamp flashes in red with 2 Hz.
Medium	Alarm indicating lamp flashes in yellow with 0.5 Hz.
Low	Alarm indicating lamp lights on in yellow.

#### ☰ Screen Display

Physiological alarm: The parameter, which triggers the alarm, splashes in the frequency of 2Hz on the screen. The physiological alarm area on the screen displays alarm message, and red indicates high priority alarm, yellow indicates medium or low priority alarm.

When Technical alarm or General alarm occurs, the Technical alarm area displays alarm message, red indicates high priority alarm, yellow indicates medium or low priority alarm, cyan indicates general message.

---

 **Note: When alarms of different priorities occur at the same time, the monitor prompts the one of the highest priority.**

---

## 6.3 Alarm Setup

### ☰ Set Alarm volume

Step 1: Select <Alarm Volume> item in Menu: <MENU> → <Alarm Setup> → <Alarm Volume>.

Step 2: Set <Alarm Volume> item to <Off>, <1>, <2>, <3>, <4>, <5>, <6>.

### ☰ Set alarm limits of physiological parameters

The alarm limit of each physiological parameter can be set in its menu, and they are continuous in alarm range. For example:

ECG alarm setup:

Step 1: Select Menu <ECG>

Step 2: Configure the following parameters related to ECG alarm, <HR LO> and <HR HI>.

Please refer to above operation for Methods of Alarm setup of the other parameters

It is important to set physiological alarm limits properly. The monitor can't give medicinal alarm prompt in clinical application with improper setting of physiological alarm limit.

The physiological alarm occurs when the measurement exceeds the set parameter limits.

Please refer to above operation for Methods of alarm setup of the other parameters.

### ECG Alarm configuration

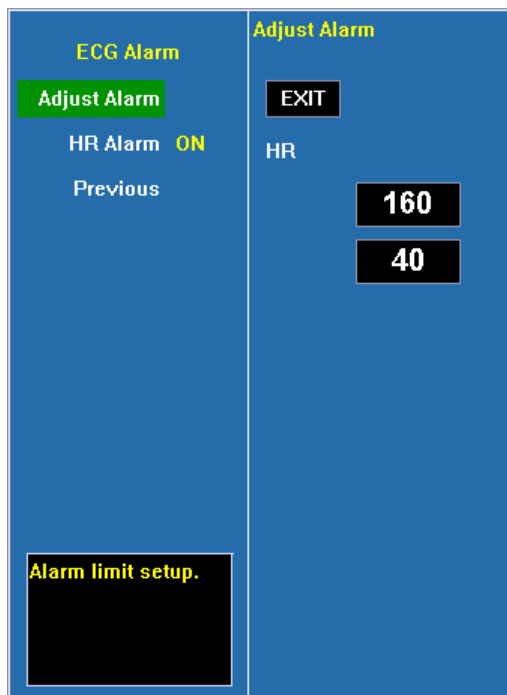

### Alarm levels configuration

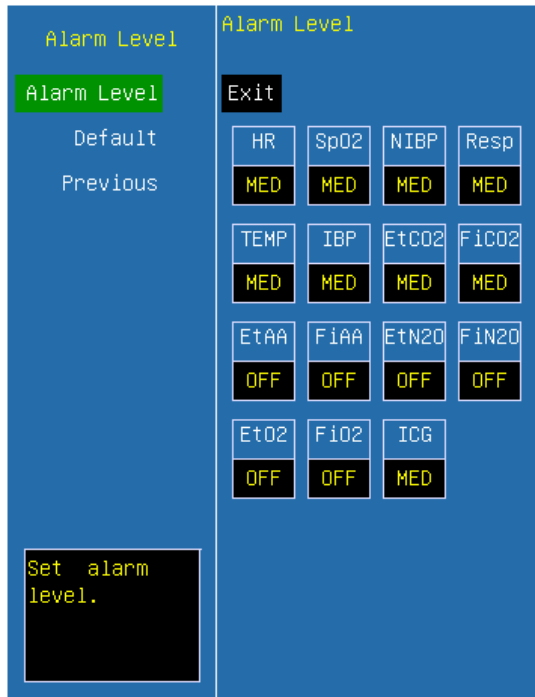

### Alarm recording configuration

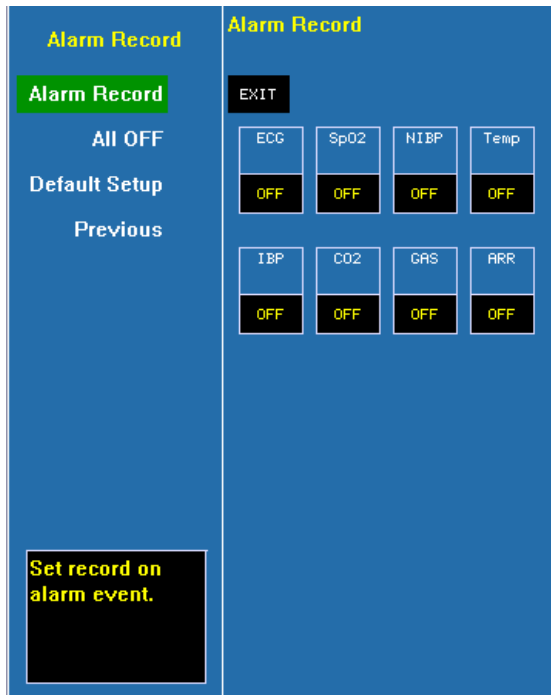

### Alarm indication of physiological parameters

Audio: when alarm occurs, the system generates alarm sound to raise the user's attention (audio alarm can be disabled).

Visual: The parameter flashes on the display area of the screen and alarm LED lights.

 **Warning:** The lower limit and the upper limit of parameter must be set based on clinical practices and general clinical experiences.

---

 **Note:** When parameter alarm level is off, alarm will be disabled, even if the measurement results exceed the limits. Alarm indicating lamp in the front of the monitor will alarm at the highest level, if different levels alarms coexist.

---

## 6.4 Alarm Cause

Alarm of the monitor includes:

1. Physiological Alarm
2. Technical Alarm
3. General Prompt

### ☰ Physiological Alarm

When the measuring value has exceeded the set parameter limit and its <ALM LEV> is not <OFF>, the monitor alarms. The monitor wouldn't alarm with absence of either of the two conditions.

### ☰ Technical Alarm



Once system fault occurs, the monitor will alarm immediately and trigger corresponding operations, such as stop displaying values and waveforms, erase the last screen to avoid misleading. The screen displays more than one fault message by alternative.

### ☰ General Prompt

Sometimes there are alarms similar to Technical Alarms but can be considered as normally. The condition, which triggers this kind of alarm wouldn't bring danger to the patient.



## 6.5 Silence/Suspension

### ☰ SILENCE



Press the  button and hold for 2 seconds can shut off all sounds until the  button is pressed again. When the system is in SILENCE status, any newly generated alarm will cancel the SILENCE status and make the system back to normal status.

When in the SILENCE status, the icon  will be displayed in the left upper of the screen.



### **SUSPENSION**

Press the /  button once can close all audio and visual prompt and description about all the physiological alarms and to make the system enter ALARM PAUSE status. The rest seconds for alarm pause is displayed in the Physiological Alarm area. And the symbol  is displayed in the System Prompt area.

The time for Alarm Suspension is 2 minutes.

When in the PAUSE status, press the /  button again to restore the normal alarm status. Besides, during PAUSE status, newly occurring technical alarm will cancel the PAUSE status and the system will come back to the normal alarm status. The symbol  disappears, too.

---

 **Note: Whether an alarm will be reset depends on the status of the alarm cause. But by pressing /  button can permanently shut off audio sound of Lead Off or Sensor Off alarms.**

---

## **6.6 Parameter Alarm**

The setup for parameter alarm is in their menus. In the menu for a specific parameter, you can check and set the alarm limit, alarm status. The setup is isolated from each other.

When a parameter alarm is off, a symbol “” displays near the parameter. If the alarms are turned off individually, they must be turned on individually.

For the parameters whose alarm switch is set to ON, the alarm will be triggered when at least one of them exceeds alarm limit. The following actions take place:

1. Alarm message displays on the screen as described in alarm mode;
2. The monitor beeps in its corresponding alarm class and volume;
3. If alarm recording is on, the recorder starts alarm recording at set interval.

## 6.7 When an Alarm Occurs



**Note:** When an alarm occurs, you should always check the patient's condition first.

Check the alarm message appeared on the screen. It is needed to identify the alarm and act appropriately, according to the cause of the alarm.

1. Check the patient's condition.
2. Identify which parameter is alarming or which kind of alarm it is.
3. Identify the cause of the alarm.
4. Silence the alarm, if necessary.
5. When cause of alarm has been over, check that the alarm is working properly.

## 6.8 Alarm Description and Prompt

### 6.8.1 ECG Alarm

Physiological Alarm:

Message	Cause	Alarm Level
HR too high	HR measuring value is above the upper alarm limit	User-selectable
HR too low	HR measuring value is below the lower alarm limit	User-selectable

Technical Alarm:

Message	Cause	Alarm Level
ECG RA LA LL V- LEAD OFF	ECG electrode fall off the skin or ECG cables fall off the monitor	Low
ECG electrode polarized	ECG electrode polarized	Low
ECG communication error	ECG measurement failure or communication failure	Low
HR alarm error	Alarm failure	Low

### 6.8.2 RESP Alarm

Physiological Alarm:



Message	Cause	Alarm Level
RR too high	RR measuring value is above the upper alarm limit	User-Selectable
RR too low	RR measuring value is below the lower alarm limit	User-Selectable
RESP Apnea	No signal for breath in specific interval	User-Selectable

Technical Alarm:

Message	Cause	Alarm Level
RR alarm error	Alarm failure	Low

### 6.8.3 SpO<sub>2</sub> Alarm

Physiological Alarm:

Message	Cause	Alarm Level
SpO <sub>2</sub> too high	SpO <sub>2</sub> measuring value is above the upper alarm limit	Medium ,High User-Selectable
SpO <sub>2</sub> too low	SpO <sub>2</sub> measuring value is below the lower alarm limit	Medium ,High User-Selectable
PR too high	PR measuring value is above the upper alarm limit	User-Selectable
PR too low	PR measuring value is below the lower alarm limit	User-Selectable

Technical Alarm:

Message	Cause	Alarm Level
SpO <sub>2</sub> sensor off	SpO <sub>2</sub> sensor may be disconnected from the patient or the monitor	Low
SpO <sub>2</sub> communication error	SpO <sub>2</sub> measurement failure or communication error	Low
SpO <sub>2</sub> alarm error	Alarm failure	Low
PR alarm error	Alarm failure	Low
SpO <sub>2</sub> sensor failure	SpO <sub>2</sub> sensor failure	Low
SpO <sub>2</sub> pulse timeout	Search pulse too long	High

Prompt:

Message	Cause	Alarm Level
Search pulse	SpO <sub>2</sub> module is searching for pulse	No alarm
Motion interference	Patient movement too much.	No alarm
Disconnected	SpO <sub>2</sub> sensor may be disconnected form the monitor.	No alarm

**6.8.4 TEMP Alarm**

Physiological Alarm:

Message	Cause	Alarm Level
TEMP1 too high	TEMP1 measuring value is above upper alarm limit	User-Selectable
TEMP1 too low	TEMP1 measuring value is below lower alarm limit	User-Selectable
TEMP2 too high	TEMP2 measuring value is above upper alarm limit	User-Selectable
TEMP2 too low	TEMP2 measuring value is below lower alarm limit	User-Selectable

Technical Alarm:

Message	Cause	Alarm Level
TEMP1 sensor off	TEMP1 sensor may be disconnected from user or monitor	Low
TEMP2 sensor off	TEMP2 sensor may be disconnected from user or monitor	Low
TMEP communication error	TEMP measurement error or communication error	Low
TMEP1 alarm error	Alarm failure	Low
TEMP2 alarm error	Alarm failure	Low
T1 over measuring range	TEMP1 over measuring range	Low
T1 below measuring range	TEMP1 below measuring range	Low
T2 over measuring range	TEMP2 over measuring range	Low
T2 below measuring range	TEMP2 below measuring range	Low
TEMP Self checking error	TEMP calibration failure	Low

**6.8.5 IBP Alarm**

Physiological Alarm:

Message	Cause	Alarm Level
IBP SYS1 too high	SYS measuring value of channel 1 is above upper alarm limit	User-Selectable
IBP SYS1 too low	SYS measuring value of channel 1 is below lower alarm limit	User-Selectable
IBP DIA1 too high	DIA measuring value of channel 1 is above upper alarm limit	User-Selectable
IBP DIA1 too low	DIA measuring value of channel 1 is below lower alarm limit	User-Selectable

IBP MAP1 too high	MAP measuring value of channel 1 is above upper alarm limit	User-Selectable
IBP MAP1 too low	MAP measuring value of channel 1 is below lower alarm limit	User-Selectable
IBP SYS2 too high	SYS measuring value of channel 2 is above upper alarm limit	User-Selectable
IBP SYS2 too low	SYS measuring value of channel 2 is below lower alarm limit	User-Selectable
IBP DIA2 too high	DIA measuring value of channel 2 is above upper alarm limit	User-Selectable
IBP DIA2 too low	DIA measuring value of channel 2 is below lower alarm limit	User-Selectable
IBP MAP2 too high	MAP measuring value of channel 2 is above upper alarm limit	User-Selectable
IBP MAP2 too low	MAP measuring value of channel 2 is below lower alarm limit	User-Selectable

Technical Alarm

Message	Cause	Alarm Level
IBP1 sensor off	IBP cable of channel 1 falls off from monitor	Low
IBP2 sensor off	IBP cable of channel 2 falls off from monitor	Low
IBP communication error	IBP communication error	Low
IBP1 alarm error	Alarm failure	Low
IBP2 alarm error	Alarm failure	Low

Prompt:

Message	Cause	Alarm Level
IBP1 Checking	IBP1 zero calibration is in progress.	No alarm
IBP1 Errlose	IBP1 zero calibration failed for IBP1 cable falls off.	
IBP1 Errtimeout	IBP1 zero calibration failed for time is out.	
IBP1 Check OK	IBP1 zero calibration succeed.	
IBP2 Checking	IBP2 zero calibration is in progress.	
IBP2 Errlose	IBP2 zero calibration failed for IBP2 cable falls off.	
IBP2 Errtimeout	IBP2 zero calibration failed for time is out.	
IBP2 Check OK	IBP2 zero calibration succeed.	

**6.8.6 NIBP Alarm**

Physiological Alarm:

Message	Cause	Alarm Level
NIBP SYS too high	NIBP SYS measuring value is above upper alarm limit	User-Selectable
NIBP SYS too low	NIBP SYS measuring value is below lower alarm limit	User-Selectable
NIBP DIA too high	NIBP DIA measuring value is above upper alarm limit	User-Selectable
NIBP DIA too low	NIBP DIA measuring value is below lower alarm limit	User-Selectable
NIBP MAP too high	NIBP MAP measuring value is above upper alarm limit	User-Selectable
NIBP MAP too low	NIBP MAP measuring value is below lower alarm limit	User-Selectable

Technical Alarm 1(display in description area):

Message	Cause	Alarm Level
NIBP communication error	NIBP measurement failure or communication failure	Low
NIBP SYS alarm error	Alarm failure	Low
NIBP DIA alarm error	Alarm failure	Low
NIBP MAP alarm error	Alarm failure	Low

Technical Alarm 2(display in description area below NIBP mean arterial pressure value):

Message	Cause	Alarm Level
SELF-TEST FAILED	Transducer or other hardware failure.	Low
LOOSE CUFF	a. Cuff is completely unwrapped. b. The cuff is not connected. c. Adult cuff used in neonate mode.	Low
AIR LEAK	Air leak in pneumatics, hose, or cuff.	Low
AIR PRESSURE ERROR	Unable to maintain stable cuff pressure, e.g. kinked hose.	Low
WEAK SIGNAL	a. Very weak patient signal due to a loosely wrapped cuff. b. The pulse of patient is too weak.	Low
RANGE EXCEEDED	Measurement range exceeds module specification.	Low
EXCESSIVE MOTION	a. Too many retries due to interference of motion artifact. b. Signal is too noisy during measurement, e.g. patient has severe tremor. c. Irregular pulse rate, e.g. arrhythmia.	Low

OVERPRESSURE SENSED	Cuff pressure exceeds the specified upper safety limit. Could be due to rapid squeezing or bumping of cuff.	Low
SIGNAL SATURATED	Large motion artifact that saturates the BP amplifier's amplitude handling capability.	Low
AIR SYSTEM LEAK	Module reports Air Leakage failure while in the Pneumatic Test mode.	Low
SYSTEM FAILURE	Module occurs abnormal processor event.	Low
TIME OUT	Measurement took more than 120 seconds in adult, 90 seconds in neonate mode.	Low
CUFF TYPE ERR	Neonate cuff used in adult mode.	Low

Prompt (display in description area below NIBP mean arterial pressure value):

Message	Cause	Alarm Level
NIBP Resetting	NIBP measurement module is resetting	No alarm
Over Press Testing	NIBP is testing Over-Pressure	
Manometer Testing	NIBP is testing Manometer	
Pneumatic Testing	NIBP is testing Pneumatic	

### 6.8.7 System Alarm and Prompt

Technical Alarm

Message	Cause	Alarm Level
Battery failure	Battery failure or no battery	Low
Battery low	Voltage of battery is too low	Medium
Key error	Keyboard error	Low
Recorder error	No paper in the recorder when recording or the recorder door is open or recorder is absent	Low

Prompt

Message	Cause	Alarm Level
Recording. . .	Recorder is in printing operation	No alarm

### 6.8.8 CO2 Alarm (CPT module, IRMA module)

Physiological Alarm:

Message	Cause	Alarm Level
EtCO <sub>2</sub> too high	EtCO <sub>2</sub> measuring value is above upper alarm limit	User-Selectable
EtCO <sub>2</sub> too low	EtCO <sub>2</sub> measuring value is below lower alarm limit	

Technical Alarm:

Message	Cause	Alarm Level
CO <sub>2</sub> sensor off	CO <sub>2</sub> sensor off patient or off the monitor	Low
CO <sub>2</sub> communication error	CO <sub>2</sub> module failure or communication failure	Low
CO <sub>2</sub> alarm error	Co <sub>2</sub> alarm function failure	Low
Check airway adapter	CO <sub>2</sub> airway adapter disconnected with CO <sub>2</sub> sensor	Low
CO <sub>2</sub> measurement Over range	CO <sub>2</sub> measurement Over range, need verify zero	Medium
CO <sub>2</sub> sensor error	CO <sub>2</sub> sensor error	Medium

### 6.8.9 CO<sub>2</sub>Alarm (LoFlo module, CAPNOSTAT5 module)

Physiological Alarm:

Message	Cause	Alarm Level
EtCO <sub>2</sub> Hi	EtCO <sub>2</sub> measuring value is above upper alarm	User-Selectable
EtCO <sub>2</sub> Lo	EtCO <sub>2</sub> measuring value is below lower alarm	User-Selectable
FiCO <sub>2</sub> Hi	FiCO <sub>2</sub> measuring value is above upper alarm	User-Selectable
FiCO <sub>2</sub> Lo	FiCO <sub>2</sub> measuring value is below lower alarm	User-Selectable
Apnea	No breath detected in the set period	User-Selectable

Technical Alarm:

Message	Cause	Alarm Level
Sensor Over Temp	Sensor over temperature.	High
Sensor Faulty	Sensor error	High
Check Sampling Line	Sampling line blockage or damage; Sampling line is kinked or pinched; Exhaust tube is blocked.	Low
Zero Required	Negative CO <sub>2</sub> detected; the module needs to be zeroed.	High
CO <sub>2</sub> Out of Range	The calculated CO <sub>2</sub> value is out of range.	Low
Check adapter	The adapter is removed from the module.	Low
Sensor no initialized	Sensor or module is not initialized	Low

Prompt:

Message	Cause	Alarm Level
Zero in Progress	Zeroing is in progress.	No Alarm
Sensor Warm Up	Module is warming up.	No Alarm

### 6.8.10 AG alarm and promotion

Physiological alarm:

Message	Cause	Alarm Level
EtAA too high	EtAA is above upper alarm limit	User-Selectable
EtAA too low	EtAA is below lower alarm limit	
FiAA too high	FiAA is above upper alarm limit	User-Selectable
FiAA too low	FiAA is below lower alarm limit	
EtN <sub>2</sub> O too high	EtN <sub>2</sub> O is above upper alarm limit	User-Selectable
EtN <sub>2</sub> O too low	EtN <sub>2</sub> O is below lower alarm limit	
FiN <sub>2</sub> O too high	FiN <sub>2</sub> O is above upper alarm limit	User-Selectable
FiN <sub>2</sub> O too low	FiN <sub>2</sub> O is below lower alarm limit	
EtO <sub>2</sub> too high	EtO <sub>2</sub> is above upper alarm limit	User-Selectable
EtO <sub>2</sub> too low	EtO <sub>2</sub> is below lower alarm limit	
FiO <sub>2</sub> too high	FiO <sub>2</sub> is above upper alarm limit	User-Selectable
FiO <sub>2</sub> too low	FiO <sub>2</sub> is below lower alarm limit	

Technical Alarm:

Message	Cause	Alarm Level
GAS communication error	GAS module failure or communication error	Medium
Check Airway Adapter	Airway adaptor of GAS module disconnected with sensor	Medium
Replace O <sub>2</sub> sensor	Oxygen sensor disconnected with module	Medium
O <sub>2</sub> sensor low	Weak oxygen sensor signal	Medium
GAS sensor error	GAS sensor error	Low
GAS CONC. Out of Range	Measurement of GAS module over range	Medium
Room Air Calibration Required	Measurement of oxygen density is not correct.	High

## Chapter 7 Recording

Monitor carries out the recording function by the built-in recorder.

### ☰ Alarm recording

Monitor provides the function of alarm trigger recording. To make alarm recording available, Please keep <Alarm Record >of <Recorder setup> of <System setup> in <Monitor setup> menu is **ON**, and adjust alarm level of alarm parameter to non-close. If any monitoring parameter exceeds the limit and <Alarm Record> is **ON**, recorder will print all monitoring parameter values in the alarm time. Moreover, if monitor alarms continuously, recorder will print every two minutes.

### ☰ Auto recording

Monitor has the function of Auto recording. To make Auto recording available, user can adjust <Record Interval> of <Recorder Setup> of <System Setup> in <Monitor Setup> to a necessary interval time. All monitoring parameter values and waveforms will be recorded automatically according to the determined period.

### ☰ Real-Time recording

Monitor has the function of real time recording. If  key in the front panel has been pressed over 2 seconds, the waveform and data of cardiac electro and SpO<sub>2</sub> can be recorded in real time. If this key pressed again, real time recording will end. The lead ECG waveform (determined by <Record Wave> in <Recorder Setup>) will be monitoring in emphasis, when ECG waveforms are being recorded.

---

 **Note: During real time recording, three waveforms can be recorded at the same time. Users can configure the waveforms according to need. Please refer to chapter 4.2.1. Measurement parameter values of individual module have been recorded on the top of waveforms.**

---



## Chapter 8 Other Functions

### 8.1 Nurse Call

Nurse Call is a function that the monitor will send signal to call nurse when the alarm conditions destined are occurred.

The monitor has a nurse call output socket, connect the socket to the nurse call system of the hospital by the nurse-call cable provided along with the monitor, the nurse call function can be realized.

The nurse call function is valid when the following conditions are concurrent:

1. The nurse call function is open.
2. An alarm condition destined is occurred.
3. The monitor is not in the state of alarm paused or system silence.

To set up nurse call function:

1. Select **【MENU】** → **【Monitor Setup】** → **【System Setup】** → **【Nurse Call】** , and configuration the following options:

**Nurse call** Select <ON> to enable nurse call function; select <OFF> to disable nurse call function.

**Phy trigger** Select the Physiological alarm level that can trigger the nurse call action. The options are **OFF, Low, MED** and **High**, and select <OFF> to disable the trigger action.

**Tech trigger** Select the Technical alarm level that can trigger the nurse call action. The options are **OFF, Low, MED** and **High**, and select <OFF> to disable the trigger action.

2. Select **【MENU】** → **【Monitor Setup】** → **【System Setup】** → **【Machine Setup】** , enter the password (password is **125689**) .

3. Enter the interface of Nurse call setup and configuration the following options:

**Call mode** Select the duration of nurse call signal and options are **One second** and **Continuous**.

**Relay type** Select the connecting type of nurse call relay. Select <N.C.> is normal Close, select <N.O.> is normal on.

---

 **Warning:** The nurse call function should not be used as the primary patient alarm inform source. It is necessary for combining the auditory and visual alarm signal and the patient clinical feature and symptom as the primary information to medical and nursing staff about the physiological condition of the patient.

---

## 8.2 Analog Signal Output

The monitor has an auxiliary output socket, connect to the device, such as oscillograph, and then perform some settings, the analog signal output function can be realized.

## 8.3 SD Card Storage

The monitor prepares the SD card to store data in case of power failure or power off. This can avoid the data lost in case of power off. Trend data and waveforms of patient are stored during monitoring. If the monitor is switched off suddenly, the monitoring data shall be consistent before and after power off.

## Chapter 9 Maintenance and Cleaning

### 9.1 System Check

An effective maintenance schedule should be established for your monitoring equipment and reusable supplies. This should include inspection as well as general clearing on a regular basis. The maintenance schedule must comply with the policies of your institution's infection control unit and/or biomedical department.

Check with your biomedical department to be sure preventive maintenance and calibration has been done. The User Maintenance Instruction contains detailed information.

Before using the monitor, check the equipment following these guidelines:

- ⇒ Check the equipment for obvious mechanical damage.
- ⇒ Check all the outer cables, inserted modules and accessories for fraying or other damage. Qualified service personnel should repair or replace damaged or deteriorated cables.
- ⇒ Check all the functions relevant to patient monitoring, make sure that the monitor is in good condition.

If you find any damage on the monitor, stop using the monitor on patient, and contact the biomedical engineer of the hospital or Manufacturer's Customer Service immediately.

---

 **Note: Refer to the User Maintenance Instruction for more comprehensive checkout procedures.**

---

The overall check of the monitor, including the safety check, should be performed only by qualified personnel once every 6 to 12 month, and whenever the monitor is fixed up.

- Inspect the safety relevant labels for legibility.
- Verify that the device functions properly as described in the instructions for use.
- Test the protection earth resistance according IEC 60601-1:1995, Limit 0.1ohm.
- Test the earth leakage current according IEC 60601-1:1995, Limit: NC 500uA, SFC 1000uA.
- Test the patient leakage current according IEC 60601-1:1995, Limit: 100uA(BF), 10uA(CF).
- Test the patient leakage current under single fault condition with mains voltage on

the applied part according IEC 60601-1:1995, Limit: 5mA(BF), 50uA(CF).

The leakage current should never exceed the limit. The data should be recorded in an equipment log. If the device is not functioning properly or fails any of the above tests, the device has to be repaired.

The synchronism of the defibrillator should be checked by in the frequency described in the hospital regulations. At least every 3 months, it should be checked by the biomedical engineer of the hospital or qualified service technician.

All the checks that need to open the monitor should be performed by qualified service technician. The safety and maintenance check can be conducted by persons from the manufacturer. You can obtain the material about the customer service contract from the local office.

The circuit diagrams, parts lists and calibration instructions of the patient monitor can be provided by the manufacturer.



**Warning: If the hospital or agency that is responding to using the monitor does not follow a satisfactory maintenance schedule, the monitor may become invalid, and the human health may be endangered.**

---



**Note: To ensure maximum battery life, please ensure that the battery is fully charged when you are keeping the device in storage for an extended period of time, and then take out the battery.**

---



**Warning: Refer the battery replacement only to manufacturer's service technician.**

---

## 9.2 Battery Maintenance

A rechargeable and maintenance-free battery is designed for Patient Monitor, which enables continuous working when AC power off. Special maintenance is not necessary in the normal situation. Please pay attention to the followings in using for more durable usage and a better capability.

- ⇒ Operate the patient monitor in the environment according to the instruction.
- ⇒ Use AC power for the patient monitor when available.
- ⇒ Recharge the battery sooner when it is off. The volume of battery will not be charged to what it should be, when the battery has not been charged for a long time.

⇒ If the monitor is not used for long time, the AC power should be plugged in until the battery is fully recharged, then take out the battery, so that the service life of the battery will not be shortened.

⇒ Avoid exposed and sun shine.

⇒ Avoid infrared and ultraviolet radiation.

⇒ Avoid moist, dust and erosion from acid gas.

#### **For Lithium ion battery:**

A lithium ion battery needs at least two conditioning cycles when it is put into use for the first time. A battery conditioning cycle is one complete, uninterrupted charge of the battery, followed by a complete, uninterrupted discharge of the battery. A lithium ion battery should be conditioned regularly to maintain its useful life. Condition a battery once when it is used or stored for two months, or when its run time becomes noticeably shorter.

To condition a lithium ion battery, follow this procedure:

1. Disconnect the monitor from the patient and stop all monitoring and measuring procedures.
2. Place the lithium ion battery in need of conditioning into battery compartment of the monitor.
3. Connect the monitor to the AC mains. Allow the battery to be charged uninterruptedly for above 6 hours.
4. Remove the AC mains and allow the monitor to run from the battery until it shuts off.
5. Reconnect the monitor to the AC mains. Allow the battery to be charged uninterruptedly for above 6 hours.

Now the battery is conditioned and the monitor can be returned to service.

### **9.3 General Cleaning**



**Warning: Before cleaning the monitor or the sensors, make sure that the equipment is switched off and disconnected from the power line.**

---

The Patient Monitor must be kept dust-free.

Regular cleaning of the monitor shell and the screen is strongly recommended. Use only non-caustic detergents such as soap and water to clean the monitor shell.

Please pay special attention to the following items:

1. Avoid using ammonia-based or acetone-based cleaners such as acetone.
2. Most cleaning agents must be diluted before use. Follow the manufacturer's

directions carefully to avoid damaging the monitor.

3. Don't use the grinding material, such as steel wool etc.
4. Don't let the cleaning agent enter into the chassis of the system.
5. Don't leave the cleaning agents at any part of the equipment.

## 9.4 Cleaning Agents

Examples of disinfectants that can be used on the instrument casing are listed below:

- Diluted soap solution
- Diluted Ammonia Water
- Diluted Sodium Hypochlorite (Bleaching agent).



**Note: The diluted sodium hypochlorite from 500ppm (1:100 diluted bleaching agent) to 5000ppm (1:10 bleaching agents) is very effective. The concentration of the diluted sodium hypochlorite depends on how many organisms (blood, mucus) on the surface of the chassis to be cleaned.**

---

- Hydrogen Peroxide 3%
- Alcohol 70%
- Isopropyl alcohol 70%

The surface of patient monitor can be cleaned with hospital-grade ethanol and dried in air or with crisp and clean cloth.

The manufacturer has no responsibility for the effectiveness of controlling infectious disease using these chemical agents. Please contact infectious disease experts in your hospital for details.

## 9.5 Disinfection

To avoid extended damage to the equipment, disinfection is only recommended when stipulated as necessary in the Hospital Maintenance Schedule. Disinfection facilities should be cleaned first.

Appropriate disinfection materials for ECG cable, SpO<sub>2</sub> sensor, blood pressure cuff, TEMP probe, CO<sub>2</sub> sensor and AG sensor are introduced in the corresponding chapters respectively.



**Warning: Do not use EtO gas or formaldehyde to disinfect the monitor.**

---

## Chapter 10 Accessories

This chapter lists the recommendation accessories used in this device.



**Warning:** The accessories listed below are specified to be used in this device. The device will be possibly damaged or lead some harm if any other accessories are used.

### Accessories List

Accessory	Type	Patient Type
ECG Electrode	2249	Adult
	2248	Pediatric
	2258-3	Neonate
ECG CABLE	No.0202001(3-leads) No.0202006(5-leads)	
	REK3003B(3-leads)	
NIBP CUFF (Disposable)	M1866A (3.1-5.7cm)	Neonate
	M1868A (4.3-8.0cm)	Neonate
	M1870A (5.8-10.9cm)	Neonate
	M1872A (7.1-13.1cm)	Neonate
NIBP CUFF (Reusable)	5082-201-3 (7.7-10.5cm)	Infant
	5082-202-3 (9.8-13.3cm)	Infant
	5082-203-3 (12.4-16.8cm)	Infant
	5082-204-3 (15.8-21.3cm)	Pediatric
	5082-205-3 (20.0-27.0cm)	Pediatric
	5082-206-3 (25.3-34.3cm)	Adult
	5082-207-3 (32.1-43.4cm)	Large Adult
	5082-208-3 (40.7-55.0cm)	Adult (Thigh)
	RNC001A (27-35cm)	Adult
	RNC002X -275 (20-28cm)	Pediatric
	RNC-004E (10-18cm)	Infant
RNC-005N (9-16cm)	Neonate	
SpO2 sensor (Disposable)	MAX-A	Adult (>30kg)
	MAX-P	Pediatric (10-50kg)

	MAX-I	Infant (3-20kg)
	MAX-N	Neonate (<3kg), Adult (>40kg)
SpO2 sensor (Reusable)	DS-100A	Adult
	OXI-A/N	Adult, Neonate
	OXI-P/I	Pediatric, Infant
	RSJ063CA	
	A0212-SA125P	Adult
	A0212-SA125PU	Adult
	A0212-SP125P	Pediatric
	A0212-SW125PU	Pediatric
Extension Cable of SpO2 sensor	TCO-SLFO	
Temperature Probe	90044	
	YSI 400 Series	
IBP Transducer	Deltran® II (DPT-248)	
EtCO2 (Sidestream, CPT)	Water trap	
	Sample line	
	3-way stopcock	
EtCO2 (Mainstream, IRMA)	IRMA CO2 sensor	Adult, Pediatric
	Extension cable	Adult, Pediatric
	Airway adapter	Adult, Pediatric
EtCO2 (MicroStream, LoFlo)	LoFlo Module	
	Sample line	
EtCO2 (MainStream, CAPNOSTAT5)	CAPNOSTAT5 CO2 Sensor	
	Airway Adapter	
AG(IRMA)	IRMA OR sensor	Adult, Pediatric
	IRMA OR+ sensor	Adult, Pediatric
	IRMA AX sensor	Adult, Pediatric
	Extension cable	Adult, Pediatric
	Airway adapter	Adult, Pediatric



## Appendix A Product Specifications

### A.1 Environmental Specifications

#### Environment

Ambient Temperature	Operating temperature: 0~+40℃ Operating temperature: +10~+35℃(If use IRMA OR sensor) Transportation and storage temperature: -20~+55℃ Transportation and storage temperature:+2~+8℃ (If use IRMA O <sub>2</sub> sensor)
Relative humidity	Working ≤85% Transportation and storage ≤93%
Atmospheric pressure	Working 860~1060 hPa Transportation and storage 500~1060 hPa

#### Power supply

Power Voltage	AC 100-240V 50/60Hz
Power Input	≤100VA
Fuse	T2AL/250V, Φ5×20 (mm)
Safety class	Category I

### A.2 Hardware Specifications

#### Size and weight

Size	335mm(H)×366mm(W)×172mm(D)
Weight	5.5kg

#### Display

LCD	
Size	15"
Type	Color TFT-LCD
Resolution	1024×768 pixels or higher
Indicators	
Physiological alarm LED	1 (Yellow/Red)

Technical alarm LED	1 (Blue)
AC Power LED	1 (Green/Orange)
Battery Charge LED	1 (Yellow)

**Battery**

Type	Rechargeable Lithium ion battery
	11.1V/4.0AH
Charge time	≤6 hours (2 batteries for 12 hours)
Operating time under the normal use and full charge	≥120 minutes (2 batteries for 240 minutes)
	New and fully charged battery at 25°C ambient temperature and NIBP work on AUTO mode for 20 minutes interval.
Operating time after the first alarm if low battery	≥10 minutes

**Battery**

Type	Rechargeable Lead acid cell, 12V/2.0AH
Charge time	≤10 hours (2 batteries for 20 hours)
Operating time under the normal use and full charge	≥30 minutes (2 batteries for 60 minutes)
	New and fully charged battery at 25°C ambient temperature and NIBP work on AUTO mode for 20 minutes interval.
Operating time after the first alarm if low battery	≥5 minutes

**Recorder (Option)**

Method	Thermal dot array
Paper width	50 mm
Record width	40 mm
Paper Speed	12.5 mm/s ,25 mm/s ,50 mm/s
Traces	Maximum 3 tracks

**Audio indicator**

Speaker	QRS Sound with Pitch Tone Alarm Sound, according to the requirement of IEC 60601-1-8
---------	---

**Interface**

Power supply	1 AC power socket
Network	1 standard RJ45 socket
USB	1 standard USB 1.1 socket
Auxiliary output	1 standard BNC socket, nurse call connector
Equipotentiality terminal	1

**System output**

<b>Nurse Call signal</b>	
Driver mode	Relay
Specs	$\leq 60\text{W}$ , $\leq 2\text{A}$ , $\leq 36\text{VDC}$ , $\leq 25\text{VAC}$
Isolated voltage	1500VAC
Type	N.C., N.O.
<b>ECG analog signal output</b>	
Signal range	-2.5V~+2.5V
Sensitivity	1V/mV
Accuracy	$\pm 5\%$
Signal delay	25ms
PACE restrain/intensify	Non
<b>IBP analog signal output</b>	
Signal range	-0.4V~+3V
Sensitivity	1V/100mmHg
Accuracy	$\pm 5\%$
Signal delay	55ms

**Alarm**

Level	Low, medium and high
Indication	Auditory and visual
Setup	Default and custom
Silence	All alarms can be silenced
Volume	45~85 dB measured at 1 meter

**A.3 Measurement Specifications**

**ECG**

Lead Mode	1. 5-leads ECG input 2. 3-leads ECG input 3. 12-leads ECG input (option)
Lead selection	1. I, II, III, aVR, aVL, aVF, V- 2. I, II, III 3. I, II, III, aVR, aVL, aVF, V1~V6 (option)
Gain	AUTO, 0.25x, 0.5x, 1.0x, 2.0x, 4.0x
Input impedance	$\geq 5.0 \text{ M}\Omega$
CMRR	MON $\geq 105\text{dB}$ OPS $\geq 105\text{dB}$
Frequency response	MON 0.5~40Hz OPS 1~25Hz
Electrode offset potential	$\pm 500\text{mV d.c.}$
Leakage Current	$< 10 \text{ }\mu\text{A}$
ECG signal range	$\pm 6.0 \text{ mV}$
Baseline recovery	$< 5\text{s}$ after Defibrillation. (MON or OPS mode)
Pacemaker pulses	No rejection of pulses with amplitudes of $\pm 2\text{mV} \sim \pm 700 \text{ mV}$ and durations of $0.5 \sim 2.0 \text{ ms.}$
Insulation	Breakdown Voltage 4000VAC 50/60Hz
Indication of electrode separation	Every electrode (exclusive of RL)
Sweep speed	12.5mm/s, 25mm/s, 50mm/s

**HR**

Measurement range	10~350 bpm
Refreshing time	Per 4 pulses
Resolution	1 bpm
Accuracy	$\pm 1\%$ or $\pm 1 \text{ bpm}$ , whichever is greater
Sensitivity	$\geq 0.2\text{mVpp}$
Alarm range	0~350 bpm, continuously adjustable between upper limit and lower limit
Alarm indication	Sound and light alarming
Time to Alarm for Tachycardia	Average 4s
Tall T-Wave Rejection Capability	0-1 mV T-Wave amplitude

Response Time of Heart Rate Meter to Change in Heart Rate	HR change from 80 to 120 bpm: Range: 6 to 10s HR change from 80 to 40 bpm: Range: 6 to 10s
---	---

**ST segment**

Measurement range	-2.0mV~2.0mV
Accuracy	-0.8mV~0.8mV: $\pm 0.02\text{mV}$ or $\pm 10\%$ whichever is greater Over $\pm 0.8\text{mV}$ : unspecified
Resolution	0.01mV
Refreshing time	10s
Alarm range	-2.00mV~2.00mV, continuously adjustable between upper limit and lower limit.

**NIBP**

Way of measurement	Automatic oscillometry		
Range of measurement	Adult	SYS	30~270 mmHg
		DIA	10~220 mmHg
		MEAN	20~235 mmHg
	Child	SYS	30~235 mmHg
		DIA	10~220 mmHg
		MEAN	20~225 mmHg
	Neonate	SYS	30~135 mmHg
		DIA	10~110 mmHg
		MEAN	20~125 mmHg
Range of HYPER measurement SYS DIA MEAN	(Only for adult) 40~300mmHg 10~250 mmHg 20~270 mmHg		
Cuff pressure range	0~280 mmHg (0~300mmHg at HYPER mode)		
Resolution	1 mmHg		
Pressure Accuracy Static Clinical	$\pm 2\%$ or $\pm 3$ mmHg, whichever is greater $\pm 5$ mmHg average error 8 mmHg standard deviation		
Unit	mmHg, kPa		

Pulse rate range	40 ~ 240 bpm	
Inflation time for cuff	Less than 40s. (standard adult cuff)	
Total cycle time	20 to 45s typical (dependent on heart rate and motion artifact)	
Intervals for AUTO measurement time	1,2,3,4,5,10,15,30,60,90 minutes 2,4,8 hours	
Overpressure Protection	Hardware and software double protections	
Adult	297±3 mmHg	
Child	252±3 mmHg	
Neonatal	147±3 mmHg	
Alarm range	SYS	0~300 mmHg, continuously adjustable between upper limit and lower limit
	DIA	0~300 mmHg, continuously adjustable between upper limit and lower limit
	MEAN	0~300 mmHg, continuously adjustable between upper limit and lower limit
Alarm indication	Sound and light alarming	
Measurement Mode	Adult	Manual, Auto and STAT
	Child	Manual, Auto and STAT
	Neonatal	Manual, Auto
	HYPER	Manual, Auto and STAT

**SpO<sub>2</sub>**

<b>BLT-SpO<sub>2</sub></b>	
Measurement Range	0~100%
Resolution	1%
Accuracy	At 70~100%, ±2% At 0~69%, unspecified
Data update period	<13s
Alarm range	0~100%, continuously adjustable between upper limit and lower limit.
<b>PR</b>	
Measurement Range	25~250 bpm
Resolution	1 bpm
Accuracy	±1% or ±1 bpm, whichever is greater
Data update period	<13s
Alarm range	0~300 bpm, continuously adjustable between upper limit and lower limit.

<b>Nellcor-SpO<sub>2</sub> ( option)</b>	
Measurement Range	0~100%
Resolution	1%
Accuracy	At 70~100%, $\pm 2$ digits (Adult) At 70~100%, $\pm 3$ digits (Neonate) At 70~100%, $\pm 2$ digits (Low Perfusion) At 0~69%, unspecified
Perfusion Range	0.03% ~ 20%
Data update period	Average 7s
Alarm range	0~100%, continuously adjustable between upper limit and lower limit.
<b>PR</b>	
Measurement Range	20~250 bpm
Resolution	1 bpm
Accuracy	$\pm 3$ digits
Data update period	Average 7s
Alarm range	0~300 bpm, continuously adjustable between upper limit and lower limit.

**TEMP**

Measurement Range	0.0~50.0°C
Accuracy	$\pm 0.1$ °C
Resolution	0.1°C
Unit	Celsius (°C), Fahrenheit (°F)
Refreshing time	1s
Self check	Every 10 minutes
Accuracy	At 45.1~50.0°C, $\pm 0.2$ °C (exclusive of probe) At 25.0~45.0°C, $\pm 0.1$ °C (exclusive of probe) At 0.0~24.9°C, $\pm 0.2$ °C (exclusive of probe)
Connecting cable	Compatible with YSI-400
Alarm range	0.0~50.0°C, continuously adjustable between upper limit and lower limit
Alarm indication	Sound and light alarming

**RESP**

Method	Impedance variation between RA-LL (R-F)
--------	---

Measuring impedance range	0.2 ~3 $\Omega$
Excitation frequency	64.8 kHz
Excitation current	$\leq 300 \mu$ A at 64.8 kHz
Base line impedance range	500~4000 $\Omega$ (50~120 kHz exciting frequency)
Measurement Range	0~150 rpm
Resolution	1 rpm
Accuracy	$\pm 2$ rpm
Gain	x1, x2, x4
Sweep speed	6.25mm/s, 12.5mm/s, 25mm/s
Delay of Apnea Alarm	Off, 10s, 20s, 40s, 60s
Alarm range	0~150 rpm, continuously adjustable between upper limit and lower limit.
Alarm indication	Sound and light indication

**IBP**

Measurement Range	-50 ~ +300 mmHg
Resolution	1 mmHg
Unit	mmHg, kPa
Accuracy Static	$\pm 2$ mmHg or 2% of the reading, whichever is greater (exclusive of transducer)
Dynamic	$\pm 4$ mmHg or 4% of the reading, whichever is greater (inclusion of transducer)
Sensitivity of transducer	5uV/V/mmHg, 2%
Impedance of transducer	300~3000 $\Omega$
Bandwidth	d.c. ~ 15Hz
Transducer sites	Arterial Pressure (ART) Pulmonary Artery Pressure (PA) Left Atrium Pressure (LAP) Right Atrium Pressure (RAP) Central Venous Pressure (CVP) Intracranial Pressure (ICP)



Selection of measurement range	ART	0~200mmHg
	PA	0~300 mmHg
	CVP	-10~20 mmHg
	LAP	-50~300 mmHg
	RAP	AUTO
	ICP	
(Among them, the AUTO switches automatically at an interval of 10 mmHg so as to ensure the waveform is at the state most suitable for observation)		
Alarm range	SYS	-50~300 mmHg, continuously adjustable between upper limit and lower limit
	DIA	-50~300 mmHg, continuously adjustable between upper limit and lower limit
	MEAN	-50~300 mmHg, continuously adjustable between upper limit and lower limit
Alarm indication	Sound and light indication	

**EtCO<sub>2</sub> (Sidestream, CPT)**

Measure method	Infrared spectrum
Measure mode	Sidestream
Measurement Range	0.0~13.1% (0~99.6 mmHg)
Resolution	1 mmHg
Unit	%, mmHg, kPa
Accuracy	At <5 % CO <sub>2</sub> , ±0.3% (±2.0 mmHg) At ≥5 % CO <sub>2</sub> , < ±10 % of reading
Range of respiration rate measurement	3~150 rpm
Calibration	Offset calibration: auto, manual Gain calibration
Alarm range	0.0~13.1 % (0~99.6mmHg), continuously adjustable between upper limit and lower limit
Alarm indication	Sound and light indication

**EtCO<sub>2</sub> (Mainstream, IRMA)**

Measure method	Infrared spectrum
Measure mode	Mainstream
Measurement Range	0.0~13.1% (0~99.6 mmHg)
Resolution	1 mmHg

Unit	%, mmHg, kPa
Accuracy	$\pm 0.5\%$ ( $\pm 4.0$ mmHg) or $< \pm 10\%$ of reading, which is greater
Rise time (at 10 L/min)	$\leq 90$ ms
Total system response time	$< 1$ s
Range of respiration rate measurement	0~150 rpm
RR Accuracy	$\pm 1$ rpm
Alarm range	0.0~13.1 % (0~99.6mmHg), continuously adjustable between upper limit and lower limit
Alarm indication	Sound and light indication

**EtCO<sub>2</sub> (Microstream, LoFlo)**

Measure method	Infrared spectrum
Measure mode	Microstream
Warm up time	Capnogram displayed in less than 20 s, At an ambient temperature of 25°C, full specifications within 2 minutes.
CO <sub>2</sub> Measurement Range	0 ~ 19.7%(0 ~ 150 mmHg)
CO <sub>2</sub> Resolution	1mmHg
CO <sub>2</sub> Stability	Short-Term Drift: Drift over four hours $\leq 0.8$ mmHg. Long-Term Drift: Accuracy specification will be maintained over a 120 hours period.
unit	%, mmHg, kPa
CO <sub>2</sub> Accuracy (at 760 mmHg, ambient temperature of 25°C)	0 ~ 40 mmHg, $\pm 2$ mmHg 41 ~ 70 mmHg, $\pm 5\%$ of reading 71 ~ 100 mmHg, $\pm 8\%$ of reading 101 ~ 150 mmHg, $\pm 10\%$ of reading Above 80 breath per minute $\pm 12\%$ of reading Gas temperature at 25°C.
CO <sub>2</sub> response time	$< 3$ s (includes transport time and rise time)
Respiration Rate Range	2~150 rpm
Respiration Rate Accuracy	$\pm 1$ rpm
Sample Flow Rate	50 ml/min $\pm 10$ ml/min
Alarm range	0.0~13.1 % (0~99.6mmHg), continuously adjustable between upper limit and lower limit
Alarm indication	Sound and light indication

**EtCO<sub>2</sub> (Mainstream, CAPNOSTAT5)**

Measure method	Infrared spectrum
Measure mode	Mainstream
Warm up time	Capnogram displayed in less than 15 s, At an ambient temperature of 25°C, full specifications within 2 minutes.
CO <sub>2</sub> Measurement Range	0 ~ 19.7%(0 ~ 150 mmHg)
CO <sub>2</sub> Resolution	1mmHg
CO <sub>2</sub> Accuracy	0 ~ 40 mmHg, ±2 mmHg 41 ~ 70 mmHg, ±5% of reading 71 ~100 mmHg, ±8% of reading 101 ~ 150 mmHg, ±10% of reading Temperature at 35°C.
CO <sub>2</sub> Stability	Short-Term Drift: Drift over four hours ≤0.8 mmHg. Long-Term Drift: Accuracy specification will be maintained over a 120 hours period.
Rise time	<60ms
unit	%, mmHg, kPa
Respiration Rate Range	0~150 rpm
Respiration Rate Accuracy	±1 rpm
Alarm range	0.0~13.1 % (0~99.6mmHg), continuously adjustable between upper limit and lower limit
Alarm indication	Sound and light indication

**AG (IRMA)**

Measure method	Infrared spectrum
Measure mode	Mainstream
Fi and Et values	CO <sub>2</sub> , N <sub>2</sub> O, O <sub>2</sub> , agent (HAL, ISO, ENF, SEV, DES)
Resolution	1mmHg
Unit	%, mmHg
Calibration	Room air calibration performed automatically when changing airway adapter (<5s)
Warm-up time	Concentrations reported in less than 10s, full accuracy within 1 min
Rise time (at 10 L/min)	CO <sub>2</sub> ≤ 90 ms O <sub>2</sub> ≤ 300 ms N <sub>2</sub> O ≤ 300 ms

	Hal, Iso, Enf, Sev, Des $\leq$ 300 ms	
Total system response time	< 1 s	
Measurement range of AG:		
Gas	Measurement range	Accuracy
CO <sub>2</sub>	0-10 %	$\pm 0.5\%$ or $\pm 10\%$ of reading, whichever is greater
N <sub>2</sub> O	0-100 %	$\pm 2\%$ or $\pm 10\%$ of reading, whichever is greater
O <sub>2</sub>	10-100 %	$\pm 3\%$
HAL, ISO, ENF	0-5%	$\pm 0.15\%$ or $\pm 10\%$ of reading, whichever is greater
SEV	0-8%	$\pm 0.15\%$ or $\pm 10\%$ of reading, whichever is greater
DES	0-18%	$\pm 0.15\%$ or $\pm 10\%$ of reading, whichever is greater
Respiration rate range	0~150 rpm	
Respiration rate accuracy	$\pm 1$ rpm	
Alarm indication	Sound and light indication	

## Appendix B Default System Setup

There are three options of default system setup: ADULT, CHILD, NEONATAL. The followings are the detail:

### B.1 System

#### 1. Standard Configuration

##### 1) Trend Graph Configuration

Region	Parameter
Region 1	HR
Region 2	SpO <sub>2</sub>
Region 3	PR
Region 4	NIBP
Region 5	Resp
Region 6	T1+T2

##### 2) Trend Table Configuration

###### Page 1

Region	Parameter
Region 1	HR
Region 2	SpO <sub>2</sub>
Region 3	PR
Region 4	NIBP(S/D)
Region 5	NIBP(M)
Region 6	Resp

###### Page 2

Region	Parameter
Region 1	HR
Region 2	T1
Region 3	T2

#### 2. Standard Configuration + dual IBP

##### 1) Trend Graph Configuration

###### Page 1

Region	Parameter
Region 1	HR
Region 2	SpO <sub>2</sub>
Region 3	P1
Region 4	P2
Region 5	Resp

**Page 2**

<b>Region</b>	<b>Parameter</b>
Region 1	PR
Region 2	NIBP
Region 3	T1+T2
Region 4	NIBP

**2) Trend Table Configuration**

**Page 1**

<b>Region</b>	<b>Parameter</b>
Region 1	HR
Region 2	SpO <sub>2</sub>
Region 3	P1
Region 4	P2
Region 5	Resp

**Page 2**

<b>Region</b>	<b>Parameter</b>
Region 1	PR
Region 2	NIBP(S/D)
Region 3	NIBP(M)
Region 4	T1
Region 5	T2

**3. Standard Configuration + dual IBP + EtCO<sub>2</sub>**

**1) Trend Graph Configuration**

**Page 1**

<b>Region</b>	<b>Parameter</b>
Region 1	HR
Region 2	SpO <sub>2</sub>
Region 3	P1
Region 4	P2
Region 5	CO <sub>2</sub>

**Page 2**

<b>Region</b>	<b>Parameter</b>
Region 1	PR
Region 2	NIBP
Region 3	Resp
Region 4	T1+T2

**2) Trend Table Configuration**

**Page 1**

<b>Region</b>	<b>Parameter</b>
Region 1	HR
Region 2	SpO <sub>2</sub>
Region 3	P1(S/D)
Region 4	P2(M)
Region 5	CO <sub>2</sub>

**Page 2**

<b>Region</b>	<b>Parameter</b>
Region 1	PR
Region 2	NIBP(S/D)
Region 3	NIBP(M)
Region 4	Resp
Region 5	T1
Region 6	T2

**4. Standard Configuration + dual IBP + EtCO<sub>2</sub>+GAS****1) Trend Graph Configuration****Page 1**

<b>Region</b>	<b>Parameter</b>
Region 1	HR
Region 2	SpO <sub>2</sub>
Region 3	P1
Region 4	P2
Region 5	CO <sub>2</sub>

**Page 2**

<b>Region</b>	<b>Parameter</b>
Region 1	PR
Region 2	NIBP
Region 3	Resp
Region 4	O <sub>2</sub> +N <sub>2</sub> O
Region 5	AA
Region 6	T1+T2

**2) Trend Table Configuration****Page 1**

<b>Region</b>	<b>Parameter</b>
Region 1	HR
Region 2	SpO <sub>2</sub>
Region 3	P1(S/D)
Region 4	P2(M)
Region 5	CO <sub>2</sub>

## Page 2

Region	Parameter
Region 1	PR
Region 2	NIBP(S/D)
Region 3	NIBP(M)
Region 4	Resp
Region 5	T1
Region 6	T2

## Page 3

Region	Parameter
Region 1	CO <sub>2</sub>
Region 2	N <sub>2</sub> O
Region 3	AA
Region 4	O <sub>2</sub>

## B.2 Alarm Limit

### 1. Setup of parameters alarm limit for adult

Parameter	Low limit	High limit
HR (bpm)	50	120
SpO <sub>2</sub> (%)	90	100
PR (bpm)	50	120
RR (rpm)	8	30
T1 (°C)	36.0	39.0
T2 (°C)	36.0	39.0
NIBP SYS(mmHg)	90	160
NIBP DIA (mmHg)	50	90
NIBP MEAN (mmHg)	60	110
IBP1 SYS (mmHg)	90	160
IBP1 DIA (mmHg)	50	90
IBP1 MEAN (mmHg)	60	110
IBP2 SYS (mmHg)	6	14
IBP2 DIA (mmHg)	-4	6
IBP2 MEAN (mmHg)	0	10
EtCO <sub>2</sub> (mmHg)	20	50
FiCO <sub>2</sub> (mmHg)	0	20
EtAA (%)	0.0	3.0
FiAA (%)	0.0	5.0



EtN <sub>2</sub> O (%)	0	82
FiN <sub>2</sub> O (%)	0	82
EtO <sub>2</sub> (%)	10	100
FiO <sub>2</sub> (%)	18	100

## 2. Setup of parameters alarm limit for child

Parameter	Low limit	High limit
HR (bpm)	75	160
SpO <sub>2</sub> (%)	90	100
PR (bpm)	75	160
RR (rpm)	8	30
T1 (°C)	36.0	39.0
T2 (°C)	36.0	39.0
NIBP SYS (mmHg)	70	120
NIBP DIA (mmHg)	40	70
NIBP MEAN (mmHg)	50	90
IBP1 SYS (mmHg)	70	120
IBP1 DIA (mmHg)	40	70
IBP1 MEAN (mmHg)	50	90
IBP2 SYS (mmHg)	2	10
IBP2 DIA (mmHg)	-4	2
IBP2 MEAN (mmHg)	0	4
EtCO <sub>2</sub> (mmHg)	20	50
FiCO <sub>2</sub> (mmHg)	0	20
EtAA (%)	0.0	3.0
FiAA (%)	0.0	5.0
EtN <sub>2</sub> O (%)	0	82
FiN <sub>2</sub> O (%)	0	82
EtO <sub>2</sub> (%)	10	100
FiO <sub>2</sub> (%)	18	100

## 3. Setup of parameters alarm limit for neonate

Parameter	Low limit	High limit
HR (bpm)	90	200
SpO <sub>2</sub> (%)	85	95
PR (bpm)	90	200

RR (rpm)	30	100
T1 (°C)	36.0	39.0
T2 (°C)	36.0	39.0
NIBP SYS(mmHg)	40	90
NIBP DIA (mmHg)	20	60
NIBP MEAN (mmHg)	25	70
IBP1 SYS (mmHg)	40	90
IBP1 DIA (mmHg)	20	60
IBP1 MEAN (mmHg)	25	70
IBP2 SYS (mmHg)	2	10
IBP2 DIA (mmHg)	-4	2
IBP2 MEAN (mmHg)	0	4
EtCO <sub>2</sub> (mmHg)	20	45
FiCO <sub>2</sub> (mmHg)	0	20
EtAA (%)	0.0	3.0
FiAA (%)	0.0	5.0
EtN <sub>2</sub> O (%)	0	82
FiN <sub>2</sub> O (%)	0	82
EtO <sub>2</sub> (%)	10	100
FiO <sub>2</sub> (%)	18	100

## Appendix C EMC

### Guidance and manufacture's declaration – electromagnetic emissions- for all EQUIPMENT and SYSTEMS

Guidance and manufacture's declaration – electromagnetic emission		
The Monitor is intended for use in the electromagnetic environment specified below. The customer of the user of the Multi-parameter Monitor should assure that it is used in such an environment.		
Emission test	Compliance	Electromagnetic environment – guidance
RF emissions CISPR 11	Group 1	The Monitor uses RF energy only for its internal function. Therefore, its RF emissions are very low and are not likely to cause any interference in nearby electronic equipment.
RF emission CISPR 11	Class A	The Monitor is suitable for use in all establishments other than domestic and those directly connected to the public low-voltage power supply network that supplies buildings used for domestic purposes.
Harmonic emissions IEC 61000-3-2	Class A	
Voltage fluctuations/ flicker emissions IEC 61000-3-3	Complies	

### Guidance and manufacture's declaration – electromagnetic immunity – for all EQUIPMENT and SYSTEMS

Guidance and manufacture's declaration – electromagnetic immunity			
The Monitor is intended for use in the electromagnetic environment specified below. The customer or the user of Low Frequency Therapeutic Device should assure that it is used in such an environment.			
Immunity test	IEC 60601 test level	Compliance level	Electromagnetic environment - guidance
Electrostatic discharge (ESD) IEC 61000-4-2	±6 kV contact ±8 kV air	±6 kV contact ±8 kV air	Floors should be wood, concrete or ceramic tile. If floor are covered with synthetic material, the relative humidity should be at least 30%.
Electrical fast transient/burst IEC 61000-4-4	±2 kV for power supply lines ±1 kV for input/output lines	±2 kV for power supply lines ±1 kV for input/output lines	Mains power quality should be that of a typical commercial or hospital environment.
Surge IEC 61000-4-5	±1 kV differential mode ±2 kV common mode	±1 kV differential mode ±2 kV common mode	Mains power quality should be that of a typical commercial or hospital environment.
Voltage dips, short interruptions and voltage variations on power supply input lines IEC 61000-4-11	<5% UT (>95% dip in UT) for 0.5 cycle 40% UT (60% dip in UT) for 5 cycles 70% UT (30% dip in UT) for 25 cycles <5% UT (>95% dip in UT) for 5 sec	<5% UT (>95% dip in UT) for 0.5 cycle 40% UT (60% dip in UT) for 5 cycles 70% UT (30% dip in UT) for 25 cycles <5% UT (>95% dip in UT) for 5 sec	Mains power quality should be that of a typical commercial or hospital environment.
Power frequency (50Hz) magnetic field IEC 61000-4-8	3A/m	3A/m	Power frequency magnetic fields should be at levels characteristic of a typical location in a typical commercial or hospital environment.
NOTE UT is the a.c. mains voltage prior to application of the test level.			

**Guidance and manufacture's declaration – electromagnetic immunity –  
for EQUIPMENT and SYSTEMS that are not LIFE-SUPPORTING**

Guidance and manufacture's declaration – electromagnetic immunity			
The Monitor is intended for use in the electromagnetic environment specified below. The customer or the user of Low Frequency Therapeutic Device should assure that it is used in such an environment.			
Immunity test	IEC 60601 test level	Compliance level	Electromagnetic environment - guidance
Conducted RF IEC 61000-4-6	3 Vrms 150 kHz to 80 MHz	1 Vrms	Portable and mobile RF communications equipment should be used no closer to any part of the patient monitor, including cables, than the recommended separation distance calculated from the equation applicable to the frequency of the transmitter. Recommended separation distance $d = \left[ \frac{3.5}{V_1} \right] \sqrt{P}$ $d = \left[ \frac{3.5}{E_1} \right] \sqrt{P}$ 80 MHz to 800 MHz $d = \left[ \frac{7}{E_1} \right] \sqrt{P}$ 800 MHz to 2.5 GHz Where P is the maximum output power rating of the transmitter in watts (W) according to the transmitter manufacturer and d is the recommended separation distance in metres (m). Field strengths from fixed RF transmitters, as determined by an electromagnetic site survey, a should be less than the compliance level in each frequency range. b Interference may occur in the vicinity of equipment marked with the following symbol: 
Radiated RF IEC 61000-4-3	3 V/m 80 MHz to 2.5 GHz	3 V/m	
NOTE 1 At 80 MHz and 800 MHz, the higher frequency range applies. NOTE 2 These guidelines may not apply in all situations. Electromagnetic propagation is affected by absorption and reflection from structures, objects and people.			
a Field strengths from fixed transmitters, such as base stations for radio (cellular/cordless) telephones and land mobile radios, amateur radio, AM and FM radio broadcast and TV broadcast cannot be predicted theoretically with accuracy. To assess the electromagnetic environment due to fixed RF transmitters, an electromagnetic site survey should be considered. If the measured field strength in the location in which the Low Frequency Therapeutic Device is used exceeds the applicable RF compliance level above, the Low Frequency Therapeutic Device should be observed to verify normal operation. If abnormal performance is observed, additional measures may be necessary, such as reorienting or relocating the Low Frequency Therapeutic Device.			
b Over the frequency range 150 kHz to 80 MHz, field strengths should be less than 3 V/m.			

**Recommended separation distances between portable and mobile  
RF communications equipment and the EQUIPMENT or SYSTEM –  
for EQUIPMENT or SYSTEM that are not LIFE-SUPPORTING**

<b>Recommended separation distances between portable and mobile RF communications equipment and the Low Frequency Therapeutic Device</b>			
The Monitor is intended for use in an electromagnetic environment in which radiated RF disturbances are controlled. The customer or the user of the Low Frequency Therapeutic Device can help prevent electromagnetic interference by maintaining a minimum distance between portable and mobile RF communications equipment (transmitters) and the Low Frequency Therapeutic Device as recommended below, according to the maximum output power of the communications equipment.			
<b>Rated maximum output power of transmitter (W)</b>	<b>Separation distance according to frequency of transmitter (m)</b>		
	150 kHz to 80 MHz $d = \left[ \frac{3.5}{V_1} \right] \sqrt{P}$	80 MHz to 800 MHz $d = \left[ \frac{3.5}{E_1} \right] \sqrt{P}$	800 MHz to 2.5 GHz $d = \left[ \frac{7}{E_1} \right] \sqrt{P}$
0.01	0.35	0.12	0.23
0.1	1.1	0.38	0.73
1	3.5	1.2	2.3
10	11	3.8	7.3
100	35	12	23
For transmitters rated at a maximum output power not listed above, the recommended separation distance d in metres (m) can be estimated using the equation applicable to the frequency of the transmitter, where P is the maximum output power rating of the transmitter in watts (W) according to the transmitter manufacturer.			
NOTE 1 At 80 MHz and 800 MHz, the separation distance for the higher frequency range applies.			
NOTE 2 These guidelines may not apply in all situations. Electromagnetic propagation is affected by absorption and reflection from structures, objects and people.			

Product name: Patient Monitor

Product type: M9500

Manufacturer: Guangdong Biolight Meditech Co., Ltd.

Address: Innovation First Road, Technology Innovation Coast, Jinding, Zhuhai, P.R.CHINA

Tel: +86-756-3399900

Fax: +86-756-3399989

Post code: 519085

Toll-free consultation hot line: +86-800-830-1016

**PN: 8.22.28-0001-02**