

Magnetic Level Gauge



Hadro Techniek B.V.
Westbaan 270
NL - 2841 MC Moordrecht

Tel +31 182 527190
info@hadro.nl
www.hadro.nl

POINTER® MAGNETIC LEVEL GAUGE

Operating principle

Magnetic level gauges work on the principle of communicating vessels, therefore the level in the measuring chamber will be the same as the level in the vessel. The measuring chamber is fitted with a float, which has a magnet inside. The float with magnet will float on the medium and the magnet in the float will turn the flaps of the indicating rail.

The float in the measuring tube is standard not pressurized and has no magnetic or mechanical guidance. This construction makes the float less dangerous than a float which is standard pressurized. When necessary Hadro can produce a pressurized float.

With the below mentioned process conditions it is possible to select a float which will float on the medium.

- Medium
- Density
- Working pressure
- Temperature

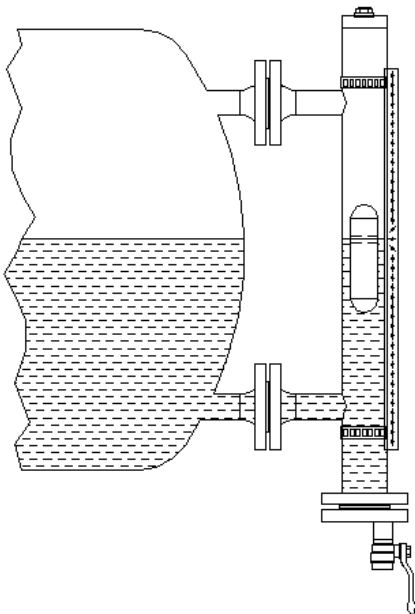

Each flap in the indicating rail is fitted with a permanent magnet which makes this level gauge unaffected by shocks, vibrations and high temperatures. Also moisture and / or an aggressive environment are no problem for this level gauge.

This magnetic level gauge is available with a full plastic indication rail or with stainless steel flaps in a aluminium or stainless steel 316 housing.

Because of the construction of the flaps, one side white and on the other red / orange it is possible to see the level over a greater distance or in darker places.

With the available “Pointers” it is possible to set the visual limits on the indicating rail on every level you require.

When the magnetic level gauge is fitted with magnetic switches it is possible to get a signal. With more switches you can make a pump control (pump on / off) and / or create a high / low alarm. Beside or instead of level switches a reedchain transmitter can be mounted, this reedchain has an standard output signal of 4-20 mA.

Magnetic level gauge are also suitable for interface reading. The float will sink into the medium with the lower density and will float on the medium with the higher density.

Models

In order to meet all the requirements there are several standard models available.

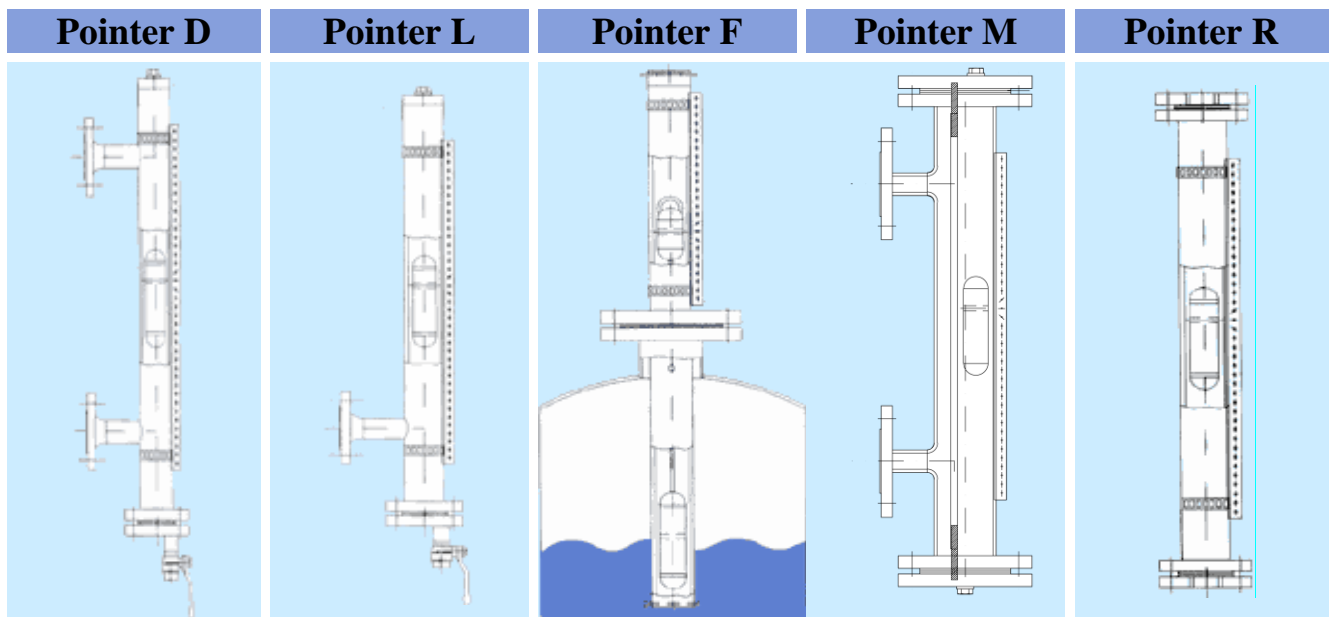

Pointer D

With two or more process connections for mounting on the side of a vessel. This design is suitable for many different applications, for example condensate tanks, LPG tanks etc.

Pointer L

With one process connection for mounting on the side of a vessel. This model is often used for day tanks for ships.

Pointer F

With one process connection on the bottom, this type is suitable for mounting above a tank. This design is mostly used for storage tank below the surface.

Pointer M

With two or more process connections for mounting on the side of a vessel. This design is specially made for evaporating applications.

Pointer R

With two process connections at the end of the level gauge, this type is suitable for mounting between two pipelines.

Special models

Beside the above mentioned types we can manufacture special models. We can make models with a coating (lining) from E-CTFE, PFA or ETFE, models made from plastic (PVC, PP, PVDF, HDPE), Hastelloy, Monel, Titanium or 254SMO/6Mo. We also produce magnetic level gauges with (steam)jacket for heating or cooling.

For further information please contact one of our technical sales engineers.

The advantages

- Standard unpressurised floatsystem
- Float without mechanical or magnetic guide rails
- Fully corrosion resistant system
- Competitive prices
- Short delivery times
- Measurement is unaffected by pressure, vacuum, temperature, foam and viscosity
- Minimum sensitivity to density variations
- Permanent indication without external power supply
- Low temperature version is fitted with ice free indication strip
- GL, LRS and BV approval for vessels
- Unique free view indication rail in plastic, Aluminium or full SS 316
- Fully adjustable switches
- Scale / ruler available in cm, mm, % or litres
- Back lighting is unnecessary
- Eccentric drain cannot be blocked by the float
- Safe, environmentally friendly and maintenance-free construction
- Broken float indication rail is possible
- Special designs according to client wishes are possible
- You are doing business directly with the manufacturer, reducing transfer mistakes
- For most types all our weldings are fully penetrated.

Contents

- 1 Pointer D / Pointer L
 - 1.1 Max. pressure 10 bar, 70 lbs
 - 1.2 Max. pressure 16 bar, 150 lbs
 - 1.3 Max. pressure 40 bar, 300 lbs
 - 1.4 High pressure up to 250 bar

- 2 Special applications
 - 2.1 For cold applications
 - 2.2 For evaporating applications
 - 2.2 With jacket for heating or cooling

- 3 Pointer F (mounting on top of a vessel)
 - 3.1 Without stillingwell
 - 3.2 With stillingwell pipe \varnothing 54 or 60.3
 - 3.3 With 3- rods \varnothing 76 or 104
 - 3.4 With stillingwell pipe \varnothing 76.1 or 88.9

- 4 Pointer R (mounting between two pipes)

- 5 Available floats

- 6 Switches
 - 6.1 General purpose level switches
 - 6.2 Intrinsic safe level switches (Ex i)
 - 6.3 Flameproof level switches (Ex d)

- 7 Reedchain for an analog output signal (4-20 mA)

- 8 Certificates

- 9 Application form

1 Pointer D / Pointer L

1.1 Max. pressure 10 bar, 70 lbs

Model	D-10 / D-70 L-10 / L-70	
Material	Stainless steel 316L (1.4404)	
Pipe	60.3 x 2 mm	
Pressure	Max. 10 bar / 70 lbs	
Temperature	Max. 160 °C	
C. to C.	Max. 5500 mm (for longer C. to C. see pointer D-16)	
Indication rail	Polycarbonate (max. temp. 105 °C, temporary 120 °C) Aluminium with SS316 flaps Stainless steel 316	
Process connection	DIN DN 15 – DN 32 / PN 16 ANSI ½” – 1¼” 150# RF Weld or thread (Male / Female) ½” – 1” DN 40 – DN 50 and ANSI 1.1/2” – 2” on 1” pipe	B = 75 mm B = 85 mm B = 70 mm B = 130 mm
Drain	¼”, ½” or ¾” plug BSP or NPT ¼”, ½” or ¾” ballvalve	
Drain gasket	None EPDM, NBR, FPM	
Vent	¼”, ½” or ¾” plug or valve, BSP or NPT G 2” stop None	
Float	From density min. 380 kg/m ³	
Drain length	Density min. 920 kg/m ³ Density min. 830 kg/m ³ Density min. 720 kg/m ³ Density min. 660 kg/m ³	A = 200 mm (*) A = 235 mm (*) A = 285 mm (*) A = 340 mm (*)
Extra support	C. to C. > 3 meter for offshore C. to C. > 4 meter for onshore	
Pointers	High & Low in stainless steel	
Marking	Tag plate acc. to standard layout PED marking till cat. III std.	
Certificates	Material EN 10204 3.1 + drawing Pressure test GL, LRS or BV certificate	
Special	Electrical tracing	

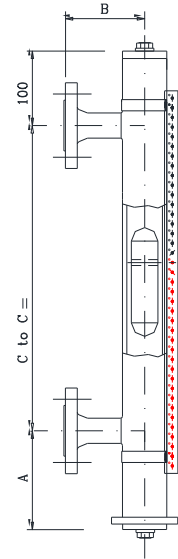

Pointer D-

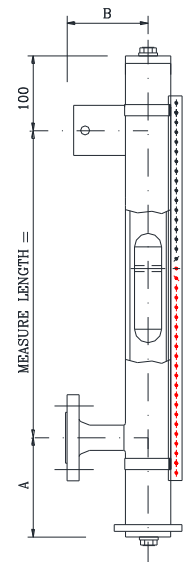

Pointer L-

(*) special (shorter) drain length available on request.

1.2 Max. pressure 16 bar, 150 lbs



Model	D-16 / D-150 L-16 / L-150	
Material	Stainless steel 316L (1.4404), Stainless steel 304, PP, PVC, PVDF, PE, Monel, Titanium, Hastelloy, 6Mo	
Pipe	60.3 x 2 mm or 60.3 x 2.77 mm (2" sch. 10)	
Pressure	Max. 16 bar / 150 lbs	
Temperature	Max. 400 °C	
C. to C.	Till 5500 mm in 1 piece, longer out more pieces	
Indication rail	Polycarbonate (max. temp. 105 °C, temporary 120 °C) Aluminium with SS316 flaps Stainless steel 316	
Process connection	DIN DN 15 – DN 32 / PN 16 ANSI ½" – 1¼" 150# RF Weld or thread (Male / Female) ½" – 1" DN 40 – DN 50 and ANSI 1.1/2" – 2" on 1" pipe	B = 75 mm B = 85 mm B = 70 mm B = 130 mm
Drain	¼", ½" or ¾" plug or valve, BSP / NPT Side entry as above Extra flange acc. DIN or ANSI None	
Drain gasket	PTFE, Aramide, Graphite, spiral wound	
Vent	¼", ½" or ¾" plug or valve, BSP / NPT or flanges Flange DN 50 / PN 16 or ANSI 2" 150# Flange DN 25 / PN 16 (as drain) None	
Float	From density min. 380 kg/m ³	
Drain length	Density min. 920 kg/m ³ Density min. 830 kg/m ³ Density min. 720 kg/m ³ Density min. 660 kg/m ³	A = 210 mm (*) A = 245 mm (*) A = 295 mm (*) A = 350 mm (*)
Extra support	C. to C. > 3 meter for offshore C. to C. > 4 meter for onshore	
Marking	Tag plate acc. to standard layout in stainless steel PED marking till cat. III std.	
Certificates	Material EN 10204 3.1 + drawing Pressure test GL, LRS or BV certificate NACE MR 01.75 / ISO 15156 WPS/PQR standard material II 1/2G Ex h IIC T6..T1 Ga/Gb II 1 D Ex h IIC T85°C ... T450°C Da KIWA 17ATEX0031 X / IECEx KIWA 18.0006	
Special	Insulation, steamjacket, spring, electrical tracing	

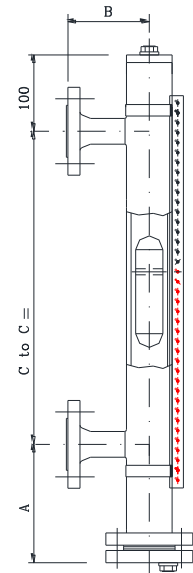

Pointer D-

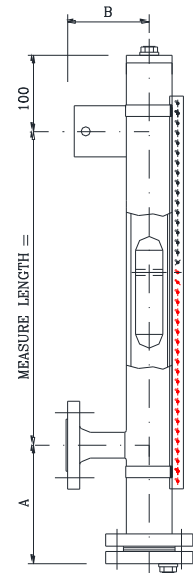

Pointer L-

(*) special (shorter) drain length available on request.

1.3 Max. pressure 40 bar, 300 lbs



Model	D-40 / D-300 L-40 / L-300	
Material	Stainless steel 316L (1.4404), Stainless steel 304, PP, PVC, PVDF, PE, Monel, Titanium, Hastelloy, 6Mo	
Pipe	60.3 x 2 mm or 60.3 x 2.77 mm (2" sch. 10)	
Pressure	40 bar / 300 lbs	
Temperature	Max. 400 °C	
C. to C.	Till 5500 mm in 1 piece, longer out more pieces	
Indication rail	Polycarbonate (max. temp. 105 °C, temporary 120 °C) Aluminium with SS316 flaps Stainless steel 316	
Process connection	DIN DN 15 – DN 32 / PN 40 ANSI ½" – 1¼" 300# RF (RTJ) Weld or thread (Male / Female) ½" – 1" DN 40 – DN 50 and ANSI 1.1/2" – 2" on 1" pipe	B = 75 mm B = 85 mm B = 70 mm B = 130 mm
Drain	¼", ½" or ¾" plug or valve, BSP or NPT Side entry as above Extra flange acc. DIN or ANSI None	
Drain gasket	PTFE, Aramide, Graphite, spiral wound	
Vent	¼", ½" or ¾" plug or valve, BSP / NPT or flanges Flange DN 50 / PN 40 or ANSI 2" 300# Flange DN 25 / PN 40 (as drain) None	
Float	From density min. 390 kg/m ³	
Drain length	Density min. 920 kg/m ³ Density min. 830 kg/m ³ Density min. 720 kg/m ³ Density min. 660 kg/m ³	A = 210 mm (*) A = 245 mm (*) A = 295 mm (*) A = 350 mm (*)
Extra support	C. to C. > 3 meter for offshore C. to C. > 4 meter for onshore	
Marking	Tag plate acc. to standard layout in stainless steel PED marking till cat. III std.	
Certificates	Material EN 10204 3.1 + drawing Pressure test GL, LRS or BV certificate NACE MR 01.75 / ISO 15156 WPS/PQR standard material II 1/2G Ex h IIC T6..T1 Ga/Gb II 1 D Ex h IIIC T85°C ... T450°C Da KIWA 17ATEX0031 X / IECEx KIWA 18.0006	
Special	Insulation, steamjacket, spring, electrical tracing	

(*)special (shorter) drain length available on request.

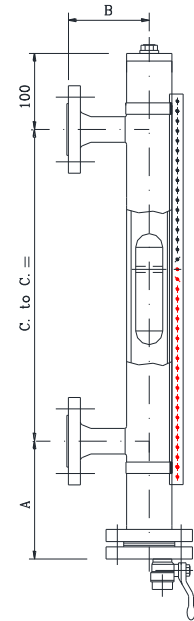

Pointer D-

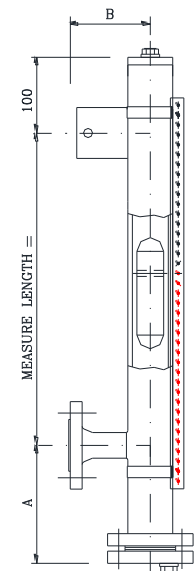

Pointer L-

1.4 High pressure up to 250 bar, 1500 lbs



Model	D-64 / D-100 / D-160 / D-600 / D-900 / D-1500 / D-2500	
Material	Stainless steel 316L (1.4404) / 316Ti (1.4571)	
Pipe	60.3 x 2.77 mm / 60.3 x 3.91 mm (2" sch.10 or 40)	
Pressure	Up to max. 250 bar	
Temperature	Max. 450 °C	
C. to C.	Till 5500 mm in 1 piece, longer out more pieces	
Indication rail	Polycarbonate (max. temp. 105 °C, temporary 120 °C) Aluminium with SS316 flaps Stainless steel 316	
Process connection	DIN DN 15 – DN 32 / PN 64 – PN 160 ANSI ½" – 1¼" 600# – 2500# RF – RTJ Weld or thread (Male / Female) ½" – 1" DN 40 – DN 50 and ANSI 1.1/2" – 2" on 1" pipe	B = 80 mm B = 85 mm B = 75 mm B = 130 mm
Drain	¼", ½" or ¾" plug BSP or NPT ¼", ½" or ¾" valve Extra flange acc. DIN or ANSI	
Drain gasket	None PTFE, Aramide, Graphite, spiral wound	
Vent	¼", ½" or ¾" plug or valve, BSP / NPT or flange Flange DN 50 or ANSI 2" Same as drain None	
Float	From density min. 610 kg/m ³	
Drain length	A = depending on pressure and temperature	
Extra support	C. to C. > 3 meter for offshore C. to C. > 4 meter for onshore	
Marking	Tag plate acc. to standard layout in stainless steel PED marking till cat. III std.	
Certificates	Material EN 10204 3.1 + drawing Pressure test GL, LRS or BV certificate NACE MR 01.75 / ISO 15156 WPS/PQR standard material II 1/2G Ex h IIC T6..T1 Ga/Gb II 1 D Ex h IIC T85°C ... T450°C Da KIWA 17ATEX0031 X / IECEx KIWA 18.0006	
Special	Insulation, spring, electrical tracing	

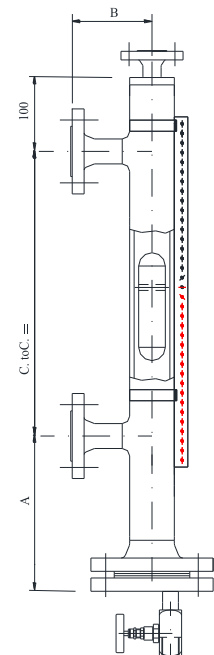

Pointer D-

2 Special applications



2.1 For cold applications

Model	D-16C / D-40C / D-150C / D-300C	
Material	Stainless steel 316L (1.4404)	
Pipe	63.5 x 1.5 mm	
Pressure	Up to max. 30 bar	
Temperature	Max. 100 °C	
C. to C.	Max. 5500 mm	
Indication rail	Aluminium with SS316 flaps Stainless steel 316	
Process connection	DIN DN 15 – DN 32 / PN 16 – PN 40 (M / V) ANSI ½” – 1¼” 150# – 300 # RF (RTJ) Weld or thread (Male / Female) ½” – 1” DN 40 – DN 50 and ANSI 1.1/2” – 2” on 1” pipe	B min= 75 mm B min= 85 mm B min= 70 mm B min= 130 mm
Drain	¼”, ½” or ¾” plug BSP or NPT ¼”, ½” or ¾” valve Extra flange acc. DIN or ANSI None	
Drain gasket	PTFE, Aramide, Graphite, spiral wound	
Vent	¼”, ½” or ¾” plug or valve, BSP or NPT Flange DN 50 / PN 40 or ANSI 2” 150 / 300# RF Flange DN 25 / PN 40 (as drain) None	
Float	From density min. 380 kg/m ³	
Drain length	Density min. 920 kg/m ³ Density min. 830 kg/m ³ Density min. 720 kg/m ³ Density min. 660 kg/m ³	A = 210 mm (*) A = 245 mm (*) A = 295 mm (*) A = 350 mm (*)
Extra support	C. to C. > 3 meter for offshore C. to C. > 4 meter for onshore	
Marking	Tag plate acc. to standard layout in stainless steel PED marking till cat. III std.	
Certificates	Material EN 10204 3.1 + drawing Pressure test GL, LRS or BV certificate NACE MR 01.75 / ISO 15156 WPS/PQR standard material II 1/2G Ex h IIC T6..T1 Ga/Gb II 1 D Ex h IIC T85°C ... T450°C Da KIWA 17ATEX0031 X / IECEx KIWA 18.0006	
Special	Armaflex insulation, PER insulation, restriction, spring, Coating (lining) with E-CTFE, PFA or ETFE	

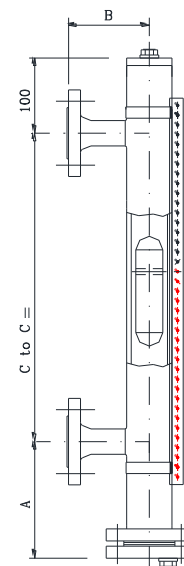

Pointer D-...C

(*)special (shorter) drain length available on request.

Hadro Techniek B.V.
Westbaan 270
NL - 2841 MC Moordrecht

Tel +31 182 527190
info@hadro.nl
www.hadro.nl

2.2 For evaporating applications



Model	M-16 / M-40 / M-64 / M-100 / M-150 / M-300 / M-600	
Material	Stainless steel 316L (1.4404)	
Pipe	88.9 x 2, 88.9 x 2.9, 88.9 x 3.05, 88.9 x 5.49 mm	
Pressure	Up to max. 100 bar	
Temperature	Max. 350 °C	
C. to C.	Max. 5500 mm	
Indication rail	Aluminium with SS316 flaps Stainless steel 316	
Process connection	DIN DN 15 – DN 50 / PN 16 – PN 100 ANSI ½” – 2” 150# – 600 # RF (RTJ) Weld or thread (Male / Female) ½” – 1”	B min= 120 mm B min= 120 mm B min= 100 mm
Drain	¼”, ½” or ¾” plug BSP or NPT ¼”, ½” or ¾” valve Extra flange acc. DIN or ANSI	
Drain gasket	None	
Drain gasket	PTFE, Aramide, Graphite, spiral wound	
Vent	¼”, ½” or ¾” plug BSP or NPT ¼”, ½” or ¾” valve Extra flange acc. DIN or ANSI	
Float	From density min. 435 kg/m ³ (depending on pressure)	
Drain length	Density min. 775 kg/m ³	A = 220 mm (*)
	Density min. 720 kg/m ³	A = 255 mm (*)
	Density min. 670 kg/m ³	A = 305 mm (*)
	Density min. 615 kg/m ³	A = 360 mm (*)
Extra support	C. to C. > 3 meter for offshore C. to C. > 4 meter for onshore	
Marking	Tag plate acc. to standard layout in stainless steel PED marking till cat. III std.	
Certificates	Material EN 10204 3.1 + drawing Pressure test GL, LRS or BV certificate NACE MR 01.75 / ISO 15156 WPS/PQR standard material II 1/2G Ex h IIC T6..T1 Ga/Gb II 1 D Ex h IIIC T85°C ... T450°C Da KIWA 17ATEX0031 X / IECEx KIWA 18.0006	

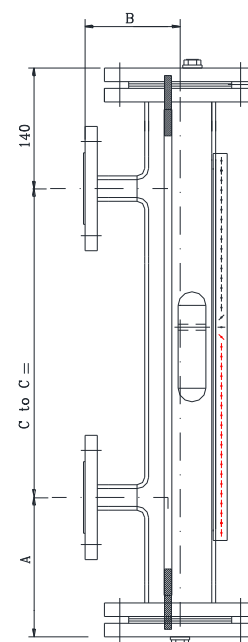

Pointer M-

(*)special (shorter) drain length available on request.

2.3 With jacket for heating or cooling



Model	D-16M / D-40M / D-150M / D-300M	
Material	Stainless steel 316L (1.4404)	
Pipe	60.3 x 2 mm and 70 x 2 mm	
Pressure	Inner pipe max. 50 bar / 300 lbs – Jacket max. 10 bar	
Temperature	Max. 200 °C	
C. to C.	Max. 5500 mm	
Indication rail	Aluminium with SS316 flaps Stainless steel 316	
Process connection	DIN DN 15 – DN 32 / PN 40 ANSI 1/2" – 1 1/4" 150# – 300# RF Weld or thread (Male / Female) 1/2" – 1" DN 40 – DN 50 and ANSI 1.1/2" – 2" on 1" pipe	B = 120 mm B = 120 mm B = 120 mm B = 150 mm
Jacket connection	See process connection	
Drain	1/4", 1/2" or 3/4" plug BSP or NPT 1/4", 1/2" or 3/4" valve Extra flange acc. DIN or ANSI None	
Drain gasket	PTFE, Aramide, Graphite, spiral wound	
Vent	1/4", 1/2" or 3/4" plug BSP or NPT Flange DN 50 / PN 40 or ANSI 2" 150/300# RF Flange DN 25 / PN 40 (as drain) None	
Float	From density min. 430 kg/m ³	
Drain length	Density min. 775 kg/m ³ Density min. 720 kg/m ³ Density min. 670 kg/m ³ Density min. 615 kg/m ³	A = 210 mm (*) A = 245 mm (*) A = 295 mm (*) A = 350 mm (*)
Extra support	C. to C. > 3 meter for offshore C. to C. > 4 meter for onshore	
Marking	Tag plate acc. to standard layout in stainless steel PED marking till cat. III std.	
Certificates	Material EN 10204 3.1 + drawing Pressure test GL, LRS or BV certificate NACE MR 01.75 / ISO 15156 WPS/PQR standard material II 1/2G Ex h IIC T6..T1 Ga/Gb II 1 D Ex h IIIC T85°C ... T450°C Da KIWA 17ATEX0031 X / IECEx KIWA 18.0006	
Special	Insulation, spring	

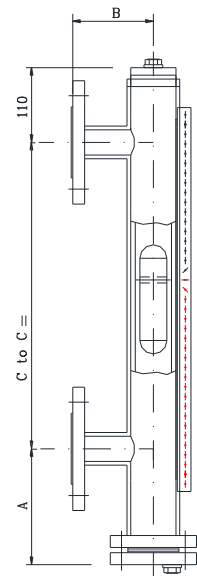

Pointer D-...M

(*)special (shorter) drain length available on request.

3. Pointer F (mounting on top of a vessel)

3.1 Without stilling well

Model	F-00A / F-00B
Material	Stainless steel 316L (1.4404), others on request
Pipe	60.3 x 2 mm (above tank)
Stilling well	Without
Pressure	Max. 60 bar (depending on type)
Temperature	Max. 350 °C
Measuring length	Max. 5500 mm
Indication rail	Polycarbonate (max. temp. 105 °C, temporary 120 °C) Aluminium with SS316 flaps Stainless steel 316
Process connection	DIN DN 50 – DN 150 / PN 40 ANSI 2" – 6" 150# RF ANSI 2" – 6" 300# RF ANSI 2" – 6" 600# RF
Vent	½", ¾" plug BSP or NPT, flange or valve
Float F-00A	Float OD 52 mm From density min. 480 kg/m ³ Density depending on measuring length, by measuring length 1000 mm for std. floats: Density min. 1210 kg/m ³ A = 115 mm Density min. 1030 kg/m ³ A = 185 mm Density min. 810 kg/m ³ A = 205 mm Density min. 670 kg/m ³ A = 255 mm
Float F-00B	Float OD 67 or 72 mm From density min. 380 kg/m ³ Density depending on measuring length, by measuring length 1000 mm for floats (OD 72 mm): Density min. 970 kg/m ³ A = 100 mm Density min. 690 kg/m ³ A = 150 mm Density min. 570 kg/m ³ A = 200 mm Density min. 500 kg/m ³ A = 250 mm
Pointers	High & Low in stainless steel
Marking	Tag plate acc. to standard layout in stainless steel
Certificates	Material EN 10204 3.1 + drawing Pressure test BV certificate NACE MR 01.75 / ISO 15156 WPS/PQR standard material ⊕ II 1/2G c IIC T1... T6 II 1 D Txx °C KEMA 10 ATEX0199 X

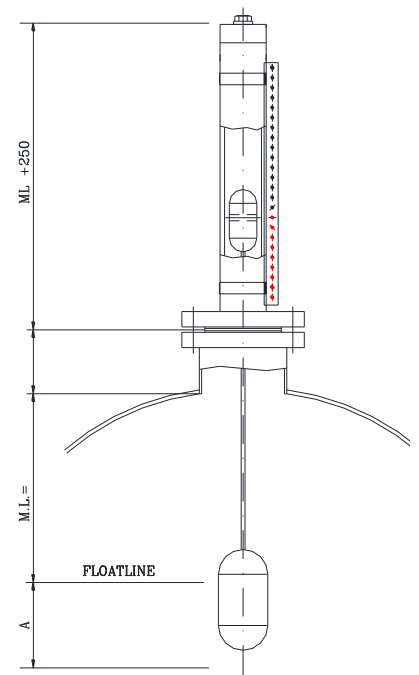

Pointer F-00

Hadro Techniek B.V.

Westbaan 270

NL - 2841 MC Moordrecht

Tel +31 182 527190

info@hadro.nl

www.hadro.nl

3.2 With stilling well pipe Ø 54 or 60.3

Model	F-01 / F-01A
Material	Stainless steel 316L (1.4404), others on request
Pipe	60.3 x 2 mm (above tank)
Stilling well	pipe 54 or 60.3
Pressure	Max. 60 bar (depending on type)
Temperature	Max. 350 °C
Measuring length	Max. 5500 mm
Indication rail	Polycarbonate (max. temp. 105 °C, temporary 120 °C) Aluminium with SS316 flaps Stainless steel 316
Process connection	DIN DN 50 – DN 150 / PN 40 ANSI 2" – 6" 150# RF ANSI 2" – 6" 300# RF ANSI 2" – 6" 600# RF
Vent	½", ¾" plug BSP or NPT, flange or valve
Float F-01	Stilling well pipe OD 60.3, float OD 52 From density min. 480 kg/m ³ Density depending on measuring length, by measuring length 1000 mm for std. floats: Density min. 1160 kg/m ³ A = 150 mm Density min. 1030 kg/m ³ A = 185 mm Density min. 810 kg/m ³ A = 205 mm Density min. 670 kg/m ³ A = 255 mm
Float F-01A	Stilling well pipe OD 54, float OD 47 From density min. 600 kg/m ³ Density depending on measuring length, by measuring length 1000 mm for std. floats: Density min. 1050 kg/m ³ A = 150 mm Density min. 910 kg/m ³ A = 200 mm Density min. 800 kg/m ³ A = 250 mm Density min. 730 kg/m ³ A = 300 mm
Pointers	High & Low in stainless steel
Marking	Tag plate acc. to standard layout in stainless steel
Certificates	Material EN 10204 3.1 + drawing Pressure test BV certificate NACE MR 01.75 / ISO 15156 WPS/PQR standard material ⊠ II 1/2G c IIC T1... T6 II 1 D Txx °C KEMA 10 ATEX0199 X

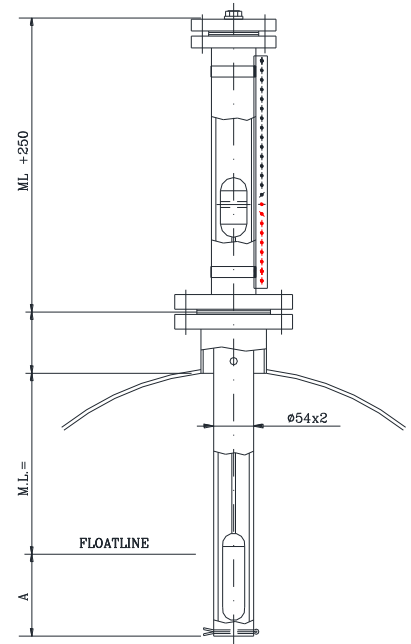

Pointer F-01A

3.3 With 3- rods $\varnothing 76$ or $\varnothing 104$

Model	F-02 / F-04
Material	Stainless steel 316L (1.4404), others on request
Pipe	60.3 x 2 mm (above tank)
Stilling well	3- rods $\varnothing 76$ or $\varnothing 104$
Pressure	Max. 60 bar (depending on type)
Temperature	Max. 350 °C
Measuring length	Max. 5500 mm
Indication rail	Polycarbonate (max. temp. 105 °C, temporary 120 °C) Aluminium with SS316 flaps Stainless steel 316
Process connection	DIN DN 80 – DN 150 / PN 40 ANSI 3" – 6" 150# RF ANSI 3" – 6" 300# RF ANSI 3" – 6" 600# RF
Vent	$\frac{1}{2}$ ", $\frac{3}{4}$ " plug BSP or NPT, flange or valve
Float F-02	3- rods $\varnothing 76$, float OD 52 mm From density min. 480 kg/m ³ Density depending on measuring length, by measuring length 1000 mm for std. floats: Density min. 1160 kg/m ³ A = 150 mm Density min. 1030 kg/m ³ A = 185 mm Density min. 810 kg/m ³ A = 205 mm Density min. 670 kg/m ³ A = 255 mm
Float F-04	3- rods $\varnothing 104$, float OD 72mm From density min. 380 kg/m ³ Density depending on measuring length, by measuring length 1000 mm for std. floats: Density min. 970 kg/m ³ A = 100 mm Density min. 690 kg/m ³ A = 150 mm Density min. 570 kg/m ³ A = 200 mm Density min. 500 kg/m ³ A = 250 mm
Pointers	High & Low in stainless steel
Marking	Tag plate acc. to standard layout in stainless steel
Certificates	Material EN 10204 3.1 + drawing Pressure test BV certificate NACE MR 01.75 / ISO 15156 WPS/PQR standard material ⊗ II 1/2G c IIC T1... T6 II 1 D Txx °C KEMA 10 ATEX0199 X

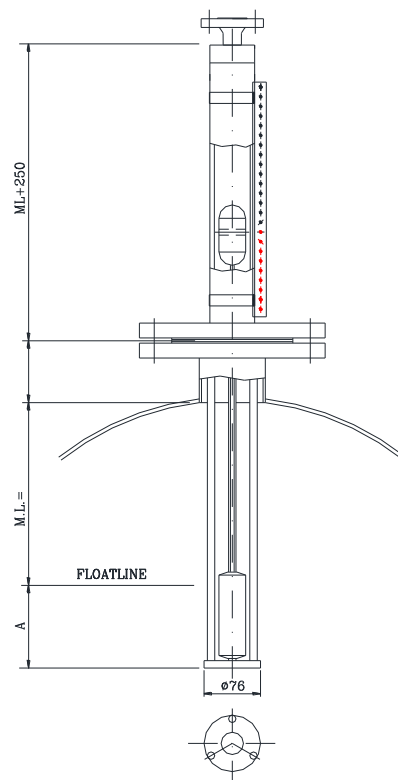

Pointer F-02

3.4 With stilling well pipe Ø 76.1 or 88.9

Model	F-03A / F-03B
Material	Stainless steel 316L (1.4404), others on request
Pipe	60.3 x 2 mm (above tank)
Stilling well	Pipe 76.1 or 88.9
Pressure	Max. 20 bar (depending on type)
Temperature	Max. 350 °C
Measuring length	Max. 5500 mm
Indication rail	Polycarbonate (max. temp. 105 °C, temporary 120 °C) Aluminium with SS316 flaps Stainless steel 316
Process connection	DIN DN 80 – DN 150 / PN 40 ANSI 3" – 6" 150# RF ANSI 3" – 6" 300# RF ANSI 3" – 6" 600# RF
Vent	½", ¾" plug BSP or NPT, flange or valve
Float F-03A	Pipe 76.1, float OD 67 mm From density min. 470 kg/m ³ Density depending on measuring length, by measuring length 1000 mm for std. floats: Density min. 1050 kg/m ³ A = 100 mm Density min. 760 kg/m ³ A = 150 mm Density min. 630 kg/m ³ A = 200 mm Density min. 560 kg/m ³ A = 250 mm
Float F-03B	Pipe 88.9, float OD 72 From density min. 380 kg/m ³ Density depending on measuring length, by measuring length 1000 mm for std. floats: Density min. 970 kg/m ³ A = 100 mm Density min. 690 kg/m ³ A = 150 mm Density min. 570 kg/m ³ A = 200 mm Density min. 500 kg/m ³ A = 250 mm
Pointers	High & Low in stainless steel
Marking	Tag plate acc. to standard layout in stainless steel
Certificates	Material EN 10204 3.1 + drawing Pressure test BV certificate NACE MR 01.75 / ISO 15156 WPS/PQR standard material ⊞ II 1/2G c IIC T1... T6 II 1 D Txx °C KEMA 10 ATEX0199 X

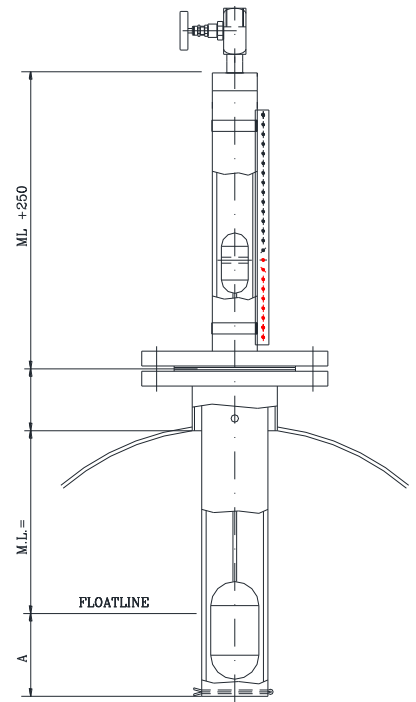

Pointer F-03

4. Pointer R (mounting between two pipes)

Model	R-40 / R-150 / R-300
Material	Stainless steel 316L (1.4404)
Pipe	60.3 x 2 mm or 60.3 x 2.77 mm
Pressure	Max. 40 bar / 150 or 300 lbs
Temperature	Max. 400 °C
C. to C.	Till 5500 mm in 1 piece, longer out more pieces
Indication rail	Polycarbonate (max. temp. 105 °C, temporary 120 °C) Aluminium with SS316 flaps Stainless steel 316
Process connection	DIN DN 15 – DN 50 / PN 40 ANSI ½” – 2” 150 - 300# RF Thread (Male / Female) ½” – 1” BSP or NPT
Float	From density min. 380 kg/m ³
Extra support	C. to C. > 3 meter for offshore C. to C. > 4 meter for onshore
Pointers	High & Low in stainless steel
Marking	Tag plate acc. to standard layout in stainless steel PED marking till cat. III std.
Certificates	Material EN 10204 3.1 + drawing Pressure test GL, LRS or BV certificate NACE MR 01.75 / ISO 15156 WPS/PQR standard material Ⓢ II 1/2G c IIC T1... T6 II 1 D Txx °C KEMA 10 ATEX0199 X
Special	Insulation, steamjacket, spring, electric tracing

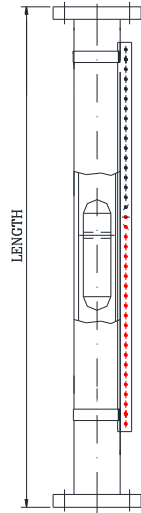

Pointer R

5. Available floats

All the magnetic level gauges are fitted with a float. This float is standard in stainless steel, but the float is also available in Titanium, Hastelloy, PVC-C, PVC-U, PP, PVDF, PE etc. The float must have enough buoyancy and the magnet must be fitted at the right position inside the float. So it is always important to select a float which is suitable for the process conditions.

In order to select the correct float the following process conditions are necessary.

- Medium
- Density
- Working pressure
- Operating temperature

The lowest density, for which we can supply a float is 380 kg/m^3 but this is depending on the before mentioned process conditions.

When a fluid is very aggressive we can also coat the float with a suitable lining.

When we have a choice between an open float or a pressurized float we prefer the pressurized float. Because the open float will eventually sink, condensate will build up inside the open float. For example our pressurized floats are suitable for 208 bar at 375°C with a density of 650 kg/m^3 .



The float inside a magnetic level gauge can be fitted with a torriodal (360°) magnet or a magnetic bar. All our floats are fitted standard with a torriodalmagnet, because a float with a magnetic bar can loose there guidance/ indication rail by rapid movement inside the level gauge. As a result the magnetic level gauge will not work properly for a while. Torriodalmagnets are not affected by rapid movements of the float and can move freely inside the level gauge. This is also why you can place a level switch at all the sides you want.

6. Switches

When you mount a magnetic switch on the level gauge it is possible to get a signal. With more switches you can make a pump control (pump on / off) and / or obtain a high / low alarm.

We can supply general purpose switches, switches for hazardous areas, or switches suitable for marine applications.

6.1 General purpose level switches

Type	HLS-15	LMS-Ha2	LMS-Ha1
Function	SPDT	SPDT	SPDT
System	Reed switch bi-stabile	Reed switch bi-stabile	Micro switch
Max. rating	2,5A / 60W / 60VA	0,8A / 60W / 40VA	2A / 40W / 100VA
Voltage	10 – 230 V	10 – 230 V	10 – 230 V
Temp. rating	-25 ... +95°C	-40... + 180°C	-50 ... +380°C
Lifetime	1 x 10 ⁹	1x 10 ⁸	1 x 10 ⁷
Enclosure	IP 66 / 67 and IP 68	IP 65	IP 67
Connection	5 meter cable PVC	M16 cable gland	M16 cable gland
Dimensions	65 x 25 x 15 mm	100 x 75 x 40 mm	95 x 65 x 54 mm
Material	Engineered Resin	Aluminium housing	AlSi housing
Options	Temperature till 130°C		M20 cable gland
			

Hadro Techniek B.V.

Westbaan 270





NL - 2841 MC Moordrecht

Tel +31 182 527190









info@hadro.nl

www.hadro.nl

6.2 Intrinsic safe level switches (Ex i)



Type	HLS-25i		LMS-Ha1E
Function	SPDT		SPDT
System	Reed switch bi-stabile		Micro switch
Max. rating	250mA / 1.3W / 1.3VA		0,5A / 20W / 30VA
Voltage	10 – 30 V		10 – 24 V
Temp. rating	-25 ... +100°C		-50 ... +380°C
Lifetime	1 x 10 ⁹		1 x 10 ⁷
Enclosure	IP 66 / 67 and IP 68		IP 67
Connection	5 meter cable PVC		M20 cable gland (blue)
Dimensions	80 x 25 x 20 mm		95 x 65 x 54 mm
Material	SS 316 housing		AlSi housing
Approval	II 1 GD Exia IIC T6 Ga II 1 GD Exia IIC T85°C IP66/67 Da		Ex i “simple apparatus“
Option			M16 cable gland (blue) Gold plated
			

6.2 Flameproof level switches (Ex d)

Type	HLS-25d		LMS-HaD	
Function	SPDT		SPDT	
System	Reed switch bi-stabile		Micro switch	
Max. rating	2.5A / 60W / 45VA		2A / 40W / 100VA	
Voltage	10 – 230 V		10 – 230 V	
Temp. rating	-25 ... +100°C		-40 ... + 380°C	
Lifetime	1 x 10 ⁹		1 x 10 ⁷	
Enclosure	IP 66 / 67 and IP 68		IP 66 / 67 and IP 68	
Connection	5 meter cable PVC		3/4" NPT or M20x1,5 max 1,5 mm ²	
Dimensions	90 x 25 x 20 mm		130 x 130 x 90 mm	
Material	SS 316 housing		Aluminium housing	
Approval	II 2 GD Exd IIC T6 Gb II 2 GD Ex tb IIIC T85°C Db		II 2G Ex d IIC T3..T4 Gb, II 2D Ex tb IIIC T135°C..T200°C Db	
Option			SS 316 Housing 2x SPDT	
				

7. Reedchain for an analog output signal

By using a reedchain it is possible to become a 4-20 mA signal. The reedchain is standard mounted on the complete length of the magnetic level gauge.

Design	Standard	Ex i 	Ex d 
Transmitter	“SMART” type	“SMART” type	“SMART” type
Approval		II 1G Ex ia II C T4..T6	II 2G Ex db IIC T5..T1 Gb II 2D Ex tb T100°C..T350°C
Supply	8 – 35 VDC	8 – 30 VDC	8 – 30 VDC
Temperature	-50 ... +350°C	-50 ... +350°C	-50 ... +350°C
Accuracy	± 5 mm	± 5 mm	± 5 mm
Material pipe	SS 316 L	SS 316 L	SS 316 L
Max. length	5,5 meter	5,5 meter	5,5 meter
Material housing	ABS or Aluminium	Aluminium or SS	Aluminium or SS316
Enclosure	IP 67	IP 67	IP 66 / 67 and IP 68
Connection	M16 x 1,5	M20 x 1,5	¾” NPT, M20x1.5
Output	4 – 20 mA / 2 wire	4 – 20 mA / 2 wire	4 – 20 mA / 2 wire
Action	Reversible std. D.A.	Reversible std. D.A.	Reversible std. D.A.
Options	High accuracy (± 2.5 or ± 1 mm) M16x1,5; M20x1,5; ½” NPT; ¾” NPT connections HART Enclosure IP 68 PROFIBUS FIELDBUS SS 316 housing Housing with LCD display (also optical) Output signal (Ohm or V)		



8. Certificates

We can supply the following certificates with our magnetic level gauges.

- Material EN 10204 3.1 + drawing
- Pressuretest
- GL, LRS and BV certificate
- ATEX, IECEx certificate
- NACE MR 01-75 / ISO 15156
- X-ray and Dye penetrant
- WPS, PQR welding protocol
- And others on request



Hadro Techniek B.V.
Westbaan 270
NL - 2841 MC Moordrecht

Tel +31 182 527190
info@hadro.nl
www.hadro.nl

9. Application form

For an offer, please fill out this form and fax to **+31 182 549008** or email to **info@hadro.nl**

Company	:
Contact person	:
Address	:
Postcode	: City :
Country	:
Telephone	: Fax :
E-mail	:

Space for your remarks:

Type : D L F M R
 Tag Nr. :

Quantity :

Measuring length : C. to C.mm

PROCESS CONDITIONS

Medium :

Density (kg/m³) : min max

Pressure : min max

Temperature : min max

Viscosity : < 80 cst orcst

DESIGN

Flanged Couplings

Thread Butt-weld

Material : SS 316L or

Connection size :

Pressure rating : Sealing surface

Drain (bottom/side) : G...../..... NPT / flange

Vent : Closed, G.../... NPT / flange

Gasket material : Std. / SS spiral wound / graphite /

CERTIFICATES

Ship approvals : GL / LRS / BV

Material cert. : EN 10204 3.1

Welding proc. : WPS / PQR

X-ray : NO / 10 / 100%

Explosion : ATEX / IECEX

Pressure test : HADRO /

OPTIONS

Float malfunction : Yes / No optical indication

Switches : STD / Exi / Exd

Scale / ruler : Cm / 0-100% / acc. tank content

Level transmitter : 4-20 mA / Exi / Exd / HART

Frost protection : Yes / No electric, steam, oil

Insulation : Cold / Heat resistant

Authorize Trading Partner / OEM



Hadro Techniek B.V.
 Westbaan 270
 NL - 2841 MC Moordrecht
 Tel +31 182 527190
info@hadro.nl
www.hadro.nl



PIC Engineering And Services (002110838-X)
 No. 72, Jalan Keluli AN7/AN,
 Pusat Perniagaan Bukit Raja, Seksyen 7 40000
 Shah Alam, Selangor D.E., Malaysia
 Tel: +6019 338 8819 Fax: +603 3343 8819
 Email: sales@picengineering.com.my
 Website: www.picengineering.com.my