



MAHARASHTRA STATE BOARD OF TECHNICAL EDUCATION
(Autonomous)
(ISO/IEC - 27001 - 2005 Certified)

SUMMER-15 EXAMINATION

Model Answer

Subject Code: 17630

Subject Name: Object Oriented Modeling & Design

Important Instructions to examiners:

- 1) The answers should be examined by key words and not as word-to-word as given in the model answer scheme.
- 2) The model answer and the answer written by candidate may vary but the examiner may try to assess the understanding level of the candidate.
- 3) The language errors such as grammatical, spelling errors should not be given more Importance (Not applicable for subject English and Communication Skills).
- 4) While assessing figures, examiner may give credit for principal components indicated in the figure. The figures drawn by candidate and model answer may vary. The examiner may give credit for any equivalent figure drawn.
- 5) Credits may be given step wise for numerical problems. In some cases, the assumed constant values may vary and there may be some difference in the candidate's answers and model answer.
- 6) In case of some questions credit may be given by judgment on part of examiner of relevant answer based on candidate's understanding.
- 7) For programming language papers, credit may be given to any other program based on equivalent concept.

1. Attempt any **FIVE** of the following:

Marks 20

a) What is attributes? Explain with suitable example.

(Explanation of Attribute -2 Marks; Example - 2 Marks)

Ans: Attributes:

- An attributes is nothing but data values of an object. An attributes is a named property of a class that describes a value held by each object of the class.
- An Attributes are listed in the second part of Class Box.
- Each attribute name may be followed by optional details.
- An attributes should describe values, not objects e.g. name, birthday, weight are attributes of person objects
- Each attribute name is Unique within a class.
- For Example :
Class Person has attributes Name, Birthdate and weight. Name is string, Birthdate is Date and Weight is integer.



MAHARASHTRA STATE BOARD OF TECHNICAL EDUCATION
(Autonomous)
(ISO/IEC - 27001 - 2005 Certified)

SUMMER-15 EXAMINATION

Model Answer

Subject Code: 17630

Subject Name: Object Oriented Modeling & Design

Person
Name: string Birthdate: date Weight: int

b) Describe conceptual model of UML?

(Correct explanation with diagram – 4 Marks)

Ans: To understand the UML, it is needed to form a conceptual model of the language, and this requires learning three major elements: the UML's basic building blocks, the rules that dictate how those building blocks may be put together, and some common mechanisms that apply throughout the UML.

UML 2.0 has 13 types of diagrams divided into three categories: Six diagram types represent static application structure, three represent general types of behaviors, and four represent different aspects of interactions. These diagrams can be categorized hierarchically as shown in the following block diagram:



MAHARASHTRA STATE BOARD OF TECHNICAL EDUCATION
(Autonomous)
(ISO/IEC - 27001 - 2005 Certified)

SUMMER-15 EXAMINATION

Model Answer

Subject Code: 17630

Subject Name: Object Oriented Modeling & Design

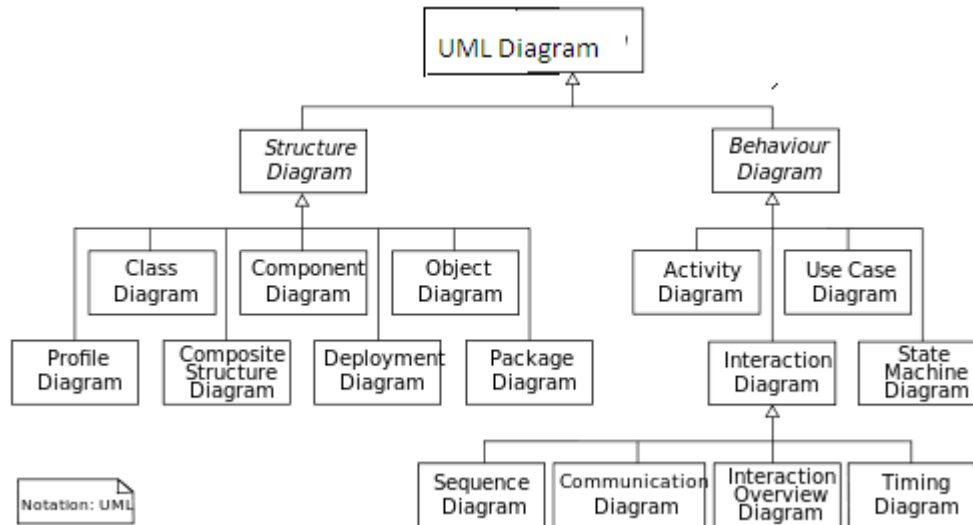

c) Mention and explain any four properties of objects?

(Any 4 relevant properties/themes/features; For each- 1 Mark)

Ans: Four Properties of Objects.

Object: An object is a real-world element in an object-oriented environment that may have a physical or a conceptual existence. Each object has:

- Identity that distinguishes it from other objects in the system.
- State that determines the characteristic properties of an object as well as the values of the properties that the object holds.
- Behavior that represents externally visible activities performed by an object in terms of changes in its state.
- Objects can be modeled according to the needs of the application.
- An object may have a physical existence, like a customer, a car, etc.; or an intangible conceptual existence, like a project, a process, etc.



MAHARASHTRA STATE BOARD OF TECHNICAL EDUCATION
(Autonomous)
(ISO/IEC - 27001 - 2005 Certified)

SUMMER-15 EXAMINATION

Model Answer

Subject Code: 17630

Subject Name: Object Oriented Modeling & Design

d) What are constraints? How they are applied in class diagrams?

(Constraint definition- 1 Mark, Explanation on how to apply it in a class diagram- 3 Marks)

Ans: A **constraint** represents some **condition, restriction** or **assertion** related to some element (that owns the constraint) or several elements. Constraint is usually specified by a Boolean expression which must evaluate to a true or false. Constraint must be satisfied (i.e. evaluated to **true**) by a correct design of the system. Constraints are commonly used for various elements on class diagrams.

Constraint:

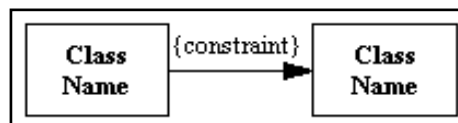

Symbol

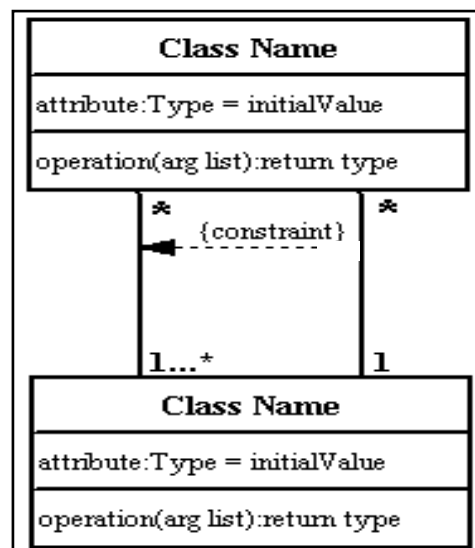

Example

For an element whose notation is a text string (such as a class attribute), the constraint string may follow the element text string in curly braces.



MAHARASHTRA STATE BOARD OF TECHNICAL EDUCATION
(Autonomous)
(ISO/IEC - 27001 - 2005 Certified)

SUMMER-15 EXAMINATION

Model Answer

Subject Code: 17630

Subject Name: Object Oriented Modeling & Design

Bank Account
+ owner : string { owner -> not empty () }
+ balance : number { balance >= 0 }

Bank account attributes constraints
- Non empty owner and positive balance.

- e) Define interface with suitable example and explain its importance.
(Define interface -1Mark, example-1Mark, Importance-2 Marks)

Ans:

- An interface is a collection of operations that specify a service of a class or component. An interface might represent the complete behavior of a class or component or only a part of that behavior. An interface defines a set of operation specifications (that is, their signatures) but never a set of operation implementations.



MAHARASHTRA STATE BOARD OF TECHNICAL EDUCATION
(Autonomous)
(ISO/IEC - 27001 - 2005 Certified)

SUMMER-15 EXAMINATION

Model Answer

Subject Code: 17630

Subject Name: Object Oriented Modeling & Design

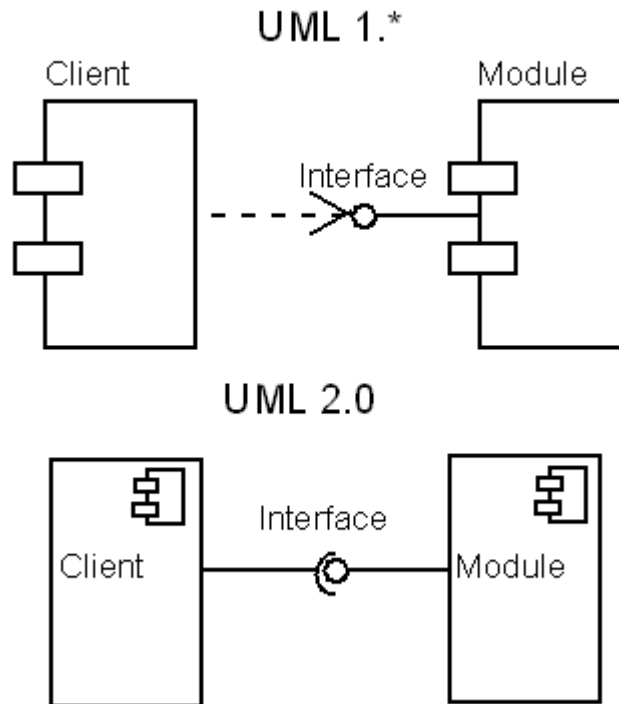

Importance:-

- An interface therefore describes the externally visible behavior of that element.
- An interface represent the complete behavior of a class or component or only a part of that Behavior.
- An interface defines a set of operation specifications.

f) Describe forking and joining in activity diagram.

(Explanation of Join min. 2 points – 2 Marks, Explanation of Fork min. 2 points - 2 Marks)

Ans: Join:

A join may represent the synchronization of two or more concurrent flows of control. A join can have two or more incoming transitions and one outgoing transition. Above the join, the activities associated with each of these paths continue in parallel. At the join, the concurrent flows synchronize, meaning that each waits until all incoming flow have reached the join, at



MAHARASHTRA STATE BOARD OF TECHNICAL EDUCATION
(Autonomous)
(ISO/IEC - 27001 - 2005 Certified)

SUMMER-15 EXAMINATION

Model Answer

Subject Code: 17630

Subject Name: Object Oriented Modeling & Design

which point one flow of control continues below the join. The notation for a join is a line segment with several activity edges entering it, and only one edge leaving it.

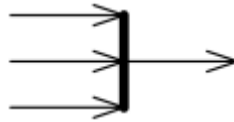

Fork:

A fork can represent the splitting of a single flow of control into two or more concurrent flows of control. A fork can have one incoming transition and two or more outgoing transitions, each of which represents an independent flow of control. Below the fork, the activities associated with each of these paths continue in parallel i.e. concurrently.

The notation for a fork is a line segment with a single activity edge entering it, and two or more edges leaving it.

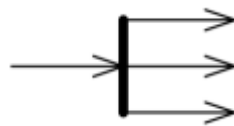

Joins and forks should always balance. It means that the number of flows that are going out from a fork should match the number of flows that are coming into its corresponding join.

E.g. Join and Fork

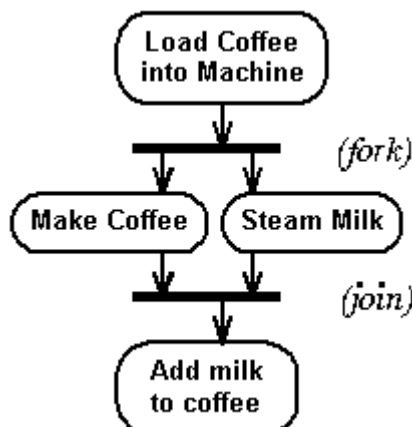



MAHARASHTRA STATE BOARD OF TECHNICAL EDUCATION
(Autonomous)
(ISO/IEC - 27001 - 2005 Certified)

SUMMER-15 EXAMINATION

Model Answer

Subject Code: 17630

Subject Name: Object Oriented Modeling & Design

g) What are different notations used for components diagram? Explain.

(listing of notations -1Mark, Explanation notations with diagram- 2Marks, diagram- 1 Mark)

Ans:

Component

A component is a logical unit block of the system, a slightly higher abstraction than classes. It is represented as a rectangle with tabs, usually including only its name. A component icon is a rectangle with two smaller rectangles jutting out from left-hand side. This symbol is visual stereotype.



Interface

A component can be connected with other components through interfaces. An interface (small circle or semi-circle on a stick) describes a group of operations used (required) or created (provided) by components. A full circle represents an interface created or provided by the component. A semi-circle represents a required interface, like a person's input.



MAHARASHTRA STATE BOARD OF TECHNICAL EDUCATION
(Autonomous)
(ISO/IEC - 27001 - 2005 Certified)

SUMMER-15 EXAMINATION

Model Answer

Subject Code: 17630

Subject Name: Object Oriented Modeling & Design

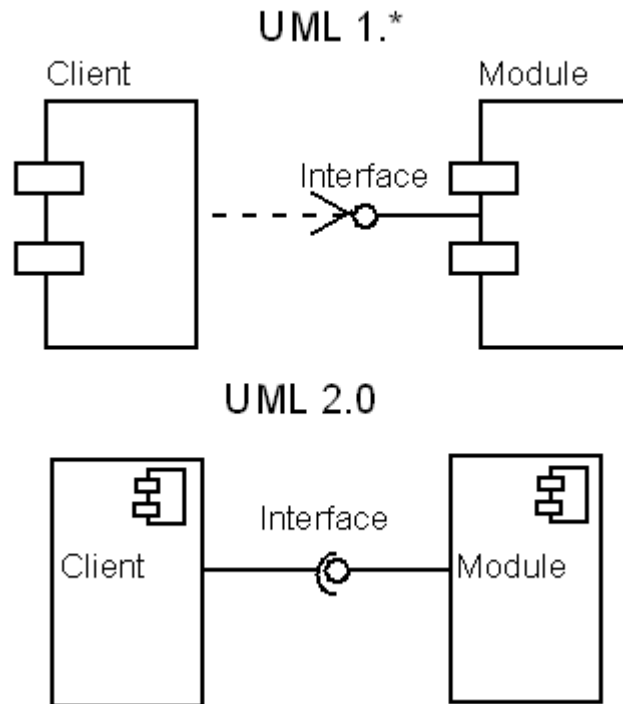

Dependencies

A dependency exists between two elements if changes to the definition of one element may cause changes to the other. It is represented as a dotted arrow as shown in figure..

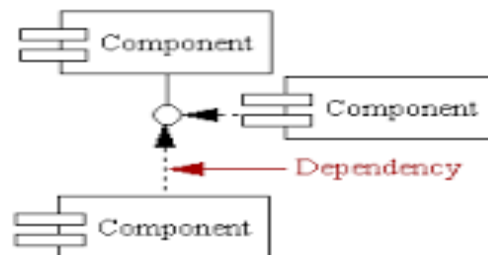



MAHARASHTRA STATE BOARD OF TECHNICAL EDUCATION
(Autonomous)
(ISO/IEC - 27001 - 2005 Certified)

SUMMER-15 EXAMINATION

Model Answer

Subject Code: 17630

Subject Name: Object Oriented Modeling & Design

2. Attempt any **FOUR** of the following: Marks 16

a) Explain class diagram with suitable example.

(Class diagram Explanation-2 Marks, Example - 2 Marks)

Ans: The class diagram is a static diagram. It represents the static view of an application. Class diagram is not only used for visualizing, describing and documenting different aspects of a system but also for constructing executable code of the software application.

The class diagram describes the attributes and operations of a class and also the constraints imposed on the system. The class diagrams are widely used in the modeling of object oriented systems because they are the only UML diagrams which can be mapped directly with object oriented languages.

The class diagram shows a collection of classes, interfaces, associations, collaborations and constraints. It is also known as a *structural diagram*.

Values and Attributes: A value is a piece of data. An attribute is a named property of a class that describes a value held by each object of the class.. Objects is to class as value is to attribute. Name, birth date and weight are attributes of Person class.

Operations and Methods: An operation is a function or procedure that may be applied to or by objects in a class. Hire() , fire() and payDividend() are operations on class company



MAHARASHTRA STATE BOARD OF TECHNICAL EDUCATION
(Autonomous)
(ISO/IEC - 27001 - 2005 Certified)

SUMMER-15 EXAMINATION

Model Answer

Subject Code: 17630

Subject Name: Object Oriented Modeling & Design

Example :

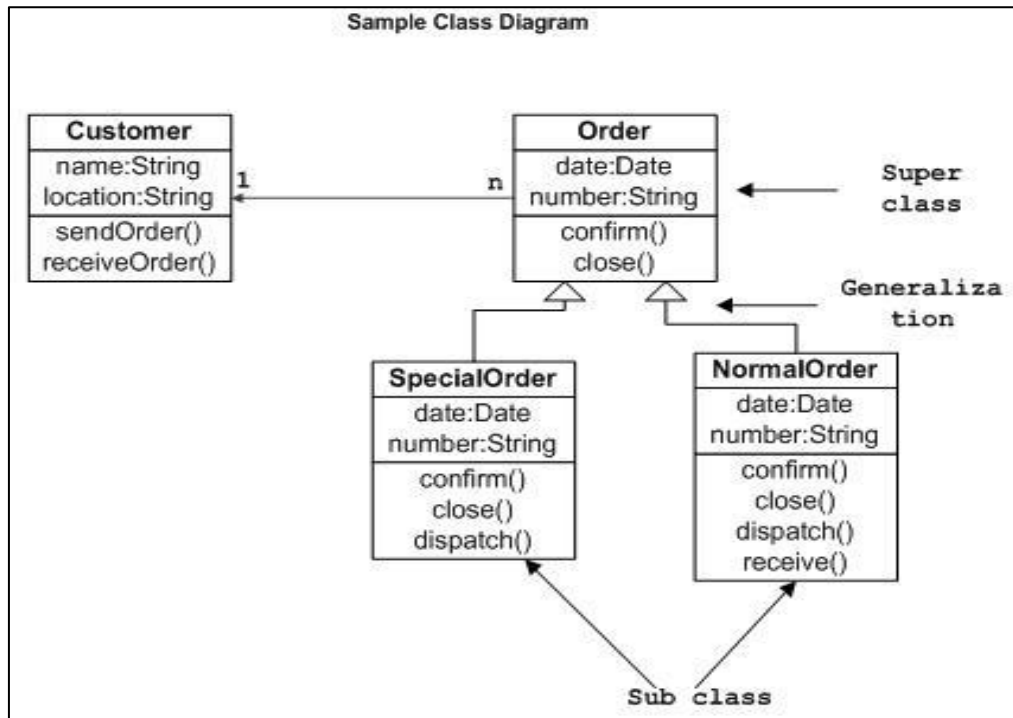

b) Explain different relationship in UML.

(At least two types of relations Explanation with example – 2Marks each.)

Ans: UML shows the following relationships:

1. Instance Level (object level)
2. Class Level

1.Instance level relationship:

Links

A *Link* is the basic relationship among objects. It is used in object diagrams. Helps in understanding the relationship between objects, with data values and multiplicity diagram.



**MAHARASHTRA STATE BOARD OF TECHNICAL EDUCATION
(Autonomous)
(ISO/IEC - 27001 - 2005 Certified)**

SUMMER-15 EXAMINATION

Model Answer

Subject Code: 17630

Subject Name: Object Oriented Modeling & Design

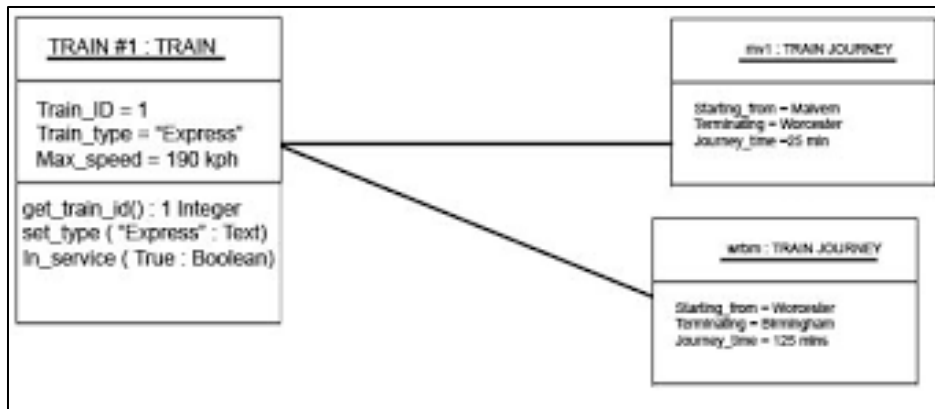

2. Class level relationships

Association

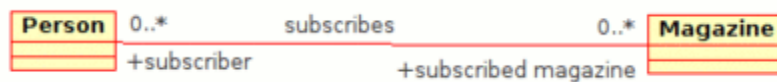

Class diagram example of association between two classes

An association represents a family of links. A binary association (with two ends) is normally represented as a line. An association can link any number of classes. An association with three links is called a ternary association. An association can be named, and the ends of an association can be adorned with role names, ownership indicators, multiplicity, visibility, and other properties. The classes may be associated with each other by aggregation or generalization.

Aggregation

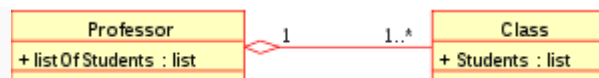

Class diagram showing Aggregation between two classes

Aggregation is a variant of the "has a" association relationship; aggregation is more specific than association. It is an association that represents a part-whole or part-of relationship.

Composition]

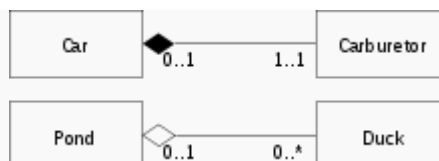



MAHARASHTRA STATE BOARD OF TECHNICAL EDUCATION
(Autonomous)
(ISO/IEC - 27001 - 2005 Certified)

SUMMER-15 EXAMINATION

Model Answer

Subject Code: 17630

Subject Name: Object Oriented Modeling & Design

Class diagram showing Composition between two classes at top and Aggregation between two classes at bottom

Generalization

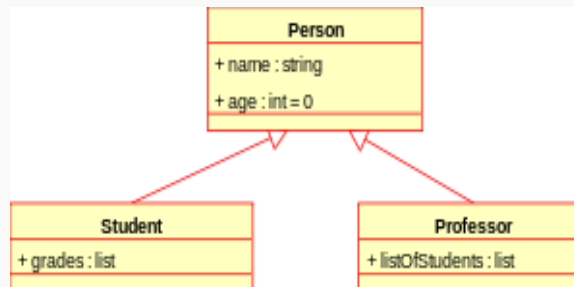

Class diagram showing generalization between one superclass and two subclasses

The Generalization relationship ("is a") indicates that one of the two related classes (the *subclass*) is considered to be a specialized form of the other (the *super type*) and the superclass is considered a '*Generalization*' of the subclass.

Realization

In UML modelling, a realization relationship is a relationship between two model elements, in which one model element (the client) realizes (implements or executes) the behavior that the other model element (the supplier) specifies.

c) Explain unified software development life cycle.

(Introduction- 1 Mark, Diagram with all phases names with brief explanation- 3 Marks)

Ans: The UML is largely process independent i.e it is not any particular software development life cycle. However, to get the most benefit from the UML, you should consider a process that is

- o use case driven
- o Architecture centric
- o Iterative and incremental



MAHARASHTRA STATE BOARD OF TECHNICAL EDUCATION
(Autonomous)
(ISO/IEC - 27001 - 2005 Certified)

SUMMER-15 EXAMINATION

Model Answer

Subject Code: 17630

Subject Name: Object Oriented Modeling & Design

- **Use case driven** means that use cases are used as a primary artifact for establishing the desired behavior of the system, for verifying and validating the system's architecture, for testing and for communicating among the stakeholders of the project.
- **Architecture centric** means that a system's architecture is used as a primary artifact for conceptualizing, constructing, managing and evolving the system under development.
- **An interactive process** is one that involves managing a stream of executable release. An interactive is one that involves the continuous integration of the system's architecture to produce these releases,
- The above 3 process i.e .use case driven, architecture-centric and iterative/incremental process can be broken into phases. Below fig shows. There are 4 phases in the SDLC: inception, elaboration, construction and transition.

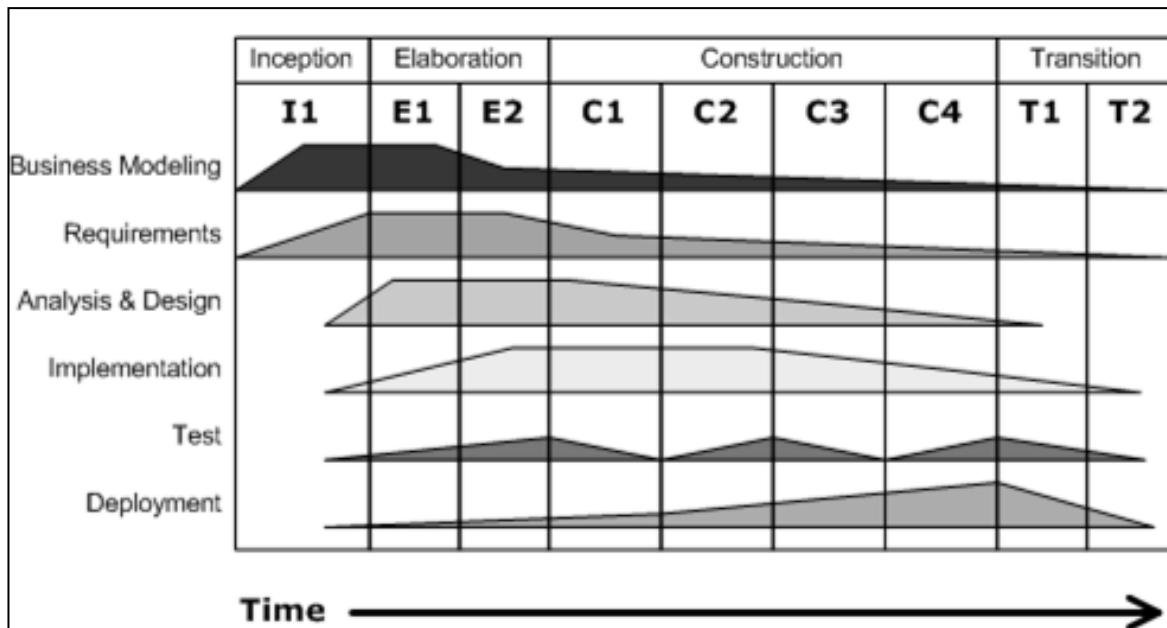

Development Life Cycle



MAHARASHTRA STATE BOARD OF TECHNICAL EDUCATION
(Autonomous)
(ISO/IEC - 27001 - 2005 Certified)

SUMMER-15 EXAMINATION

Model Answer

Subject Code: 17630

Subject Name: Object Oriented Modeling & Design

d) Differentiate between aggregation and association.

(Any 4 differences- 6 Marks, OR 1½ Marks each, Example - 1 Mark, for each 1 Mark)

Ans:

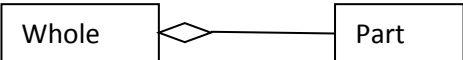
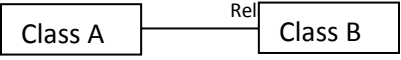
Aggregation	Association
Aggregation is the “Part-whole” or “a-part-of” relationship in which objects representing the components.	Association describe a group of links with common structure & common semantics.
Aggregation is drawn like association, except a small diamond indicates the assembly end of the relationship.	An association is drawn with line connecting two or more classes with association name on it.
Notation: 	Notation: 
An Aggregation is a specialized association.	An Association defines a relationship between two or more classes.
Aggregation is tightly looped from of	Association represents static relationship



MAHARASHTRA STATE BOARD OF TECHNICAL EDUCATION
(Autonomous)
(ISO/IEC - 27001 - 2005 Certified)

SUMMER-15 EXAMINATION

Model Answer

Subject Code: 17630

Subject Name: Object Oriented Modeling & Design

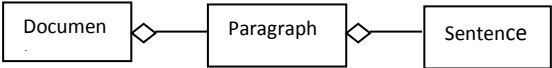
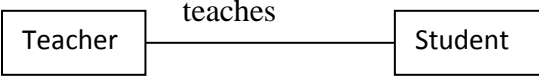
association with same extra semantics.	between classes.
Two types of Aggregation : aggregation & composition	Types of association unary, Binary & n-ary.
<p>Example:</p>  <p>Example shows that a document consists of many sentences.</p>	<p>Example:</p>  <p>Example shows the object model for Teacher & student associations.</p>

e) **What is metadata? Explain with appropriate example.**

(Define metadata-1Mark, Instantiation -1Mark, Example-2Marks)

Ans:

- Metadata describes other data. It provides information about a certain item's content. For example, an image may include metadata that describes how large the picture is, the color depth, the image resolution, when the image was created, and other data. A text document's metadata may contain information about how long the document is, who the author is, when the document was written, and a short summary of the document.
- Meta data: - Metadata is data that describes other data .for example, the definition of an class is metadata. Models are inherently metadata, since they describe the things being modeled. A relational database management system use metadata. A person can define database tables for storing information.



MAHARASHTRA STATE BOARD OF TECHNICAL EDUCATION
(Autonomous)
(ISO/IEC - 27001 - 2005 Certified)

SUMMER-15 EXAMINATION

Model Answer

Subject Code: 17630

Subject Name: Object Oriented Modeling & Design

Example:-

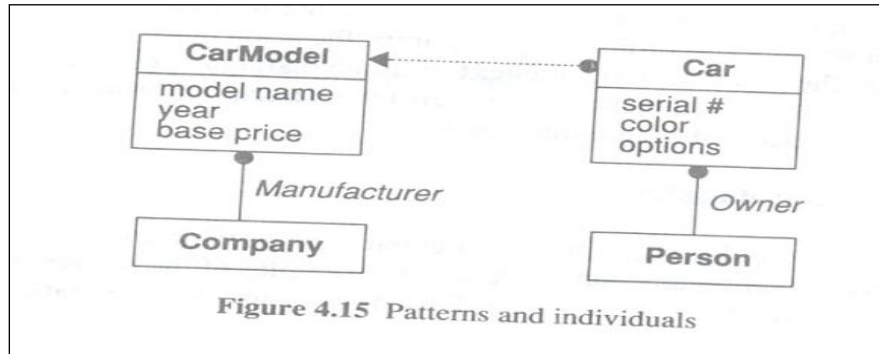

Explanation of example:-Each car model has its own attributes and associations. Each car model object also describes a set of physical cars owned by persons. Each car receives the common attributes from car model but also own list of particular attributes such as serial number, color and a list of options.

Car Model object as a pattern, a piece of metadata, that describes car objects.

f) Describe notations used for deployment diagram.

(Description- 2 Marks, Notations- 2 Marks)

Ans: A **deployment** is a dependency relationship which describes allocation (deployment) of an artifact to a deployment target. Deployment could be also defined at instance level - as allocation of specific artifact instance to the specific instance of deployment target.

Node is a deployment target which represents computational resource upon which artifacts may be deployed for execution.

Node is shown as a perspective, 3-dimensional view of a cube.





MAHARASHTRA STATE BOARD OF TECHNICAL EDUCATION
(Autonomous)
(ISO/IEC - 27001 - 2005 Certified)

SUMMER-15 EXAMINATION

Model Answer

Subject Code: 17630

Subject Name: Object Oriented Modeling & Design

Application Server Node

Nodes can be interconnected with communication paths. Communication paths can be defined between nodes such as **application server** and **database server** to define the possible communication paths between the nodes. Specific network topologies can then be defined through **links** between node instances.

Node is specialized by:

- device
- execution environment

Execution environment is usually part of a general node or «device» which represents the physical hardware environment on which this execution environment resides. Execution environments can be **nested** (e.g., a database execution environment may be nested in an operating system execution environment).

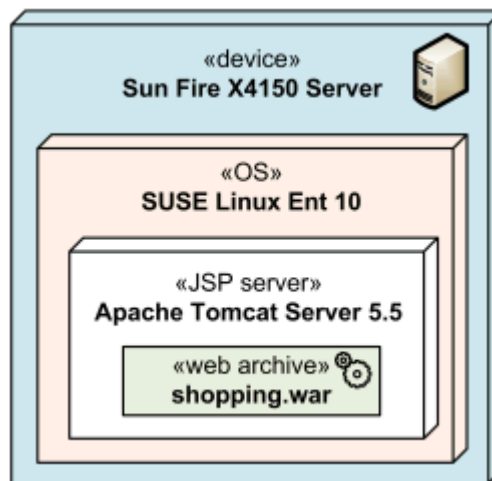

Several execution environments nested into server device

Device

A **device** is a node which represents a physical computational resource with processing capability upon which artifacts may be deployed for execution.



MAHARASHTRA STATE BOARD OF TECHNICAL EDUCATION
(Autonomous)
(ISO/IEC - 27001 - 2005 Certified)

SUMMER-15 EXAMINATION

Model Answer

Subject Code: 17630

Subject Name: Object Oriented Modeling & Design

A **device** is rendered as a node (perspective, 3-dimensional view of a cube) annotated with keyword «**device**».



Application Server device

A **communication path** is association between two deployment targets, through which they are able to exchange signals and messages.

Communication path is notated as **association**, and it has no additional notation compared to association.

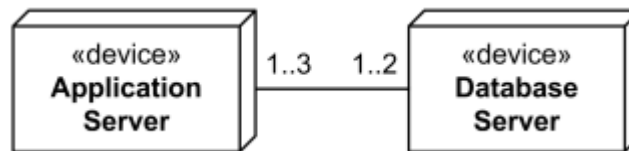

Communication path between several application servers and database servers.

3. Attempt any **FOUR** of the following:

Marks 16

a) What is state diagram? Explain.

(Correct explanation with minimum 4points – 4 Marks)

Ans: State diagram: The name of the diagram itself clarifies the purpose of the diagram and other details. It describes different states of a component in a system. The states are specific to a component/object of a system. **A State diagram describes a state machine.** Now to clarify it state machine can be defined as a machine which defines different states of an object and these states are controlled by external or internal events. State diagram is one of the five UML diagrams used to model dynamic nature of a system. **They define different states of an object during its lifetime.** And these states are changed by events. So, **State diagrams are useful to model reactive systems.** Reactive systems can be defined as a system that responds to external or internal events. **State diagram describes the flow of control from one state to another state.** **States are defined as a condition in which an object exists and it changes when some event is**



MAHARASHTRA STATE BOARD OF TECHNICAL EDUCATION
(Autonomous)
(ISO/IEC - 27001 - 2005 Certified)

SUMMER-15 EXAMINATION

Model Answer

Subject Code: 17630

Subject Name: Object Oriented Modeling & Design

triggered. So the most important purpose of State diagram is to model life time of an object from creation to termination. State diagrams are also used for forward and reverse engineering of a system. But the main purpose is to model reactive system.

Following are the main purposes of using State chart diagrams:

- To model dynamic aspect of a system.
- To model life time of a reactive system.
- To describe different states of an object during its life time.
- Define a state machine to model states of an object.

E.g. of State Diagram:

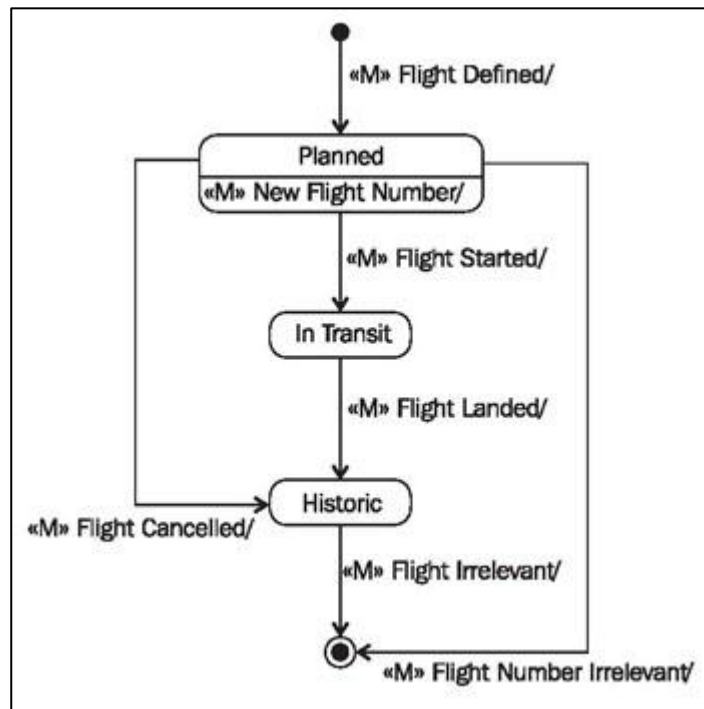



MAHARASHTRA STATE BOARD OF TECHNICAL EDUCATION
(Autonomous)
(ISO/IEC - 27001 - 2005 Certified)

SUMMER-15 EXAMINATION

Model Answer



Subject Code: 17630

Subject Name: Object Oriented Modeling & Design

b) Draw the symbols in deployment diagram and state use of it.

(Any Four important Symbols with its use- 4 Marks)

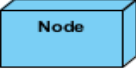
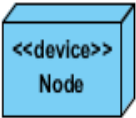
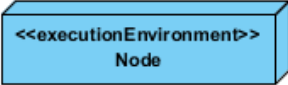
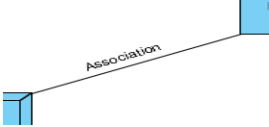
Ans:

Name	Symbol	Use
Node		A node is computational resource upon which artifacts may be deployed for execution. Eg. Server
Device Node		A Device Node is a physical computational resource with processing capability upon which artifacts may be deployed for execution. APC with specific configuration, mobile phone etc
Execution Environmental Node		An Execution Environment Node is a node that offers an execution environment for specific types of components that are deployed on it in the form of executable artifacts. Eg. OS, Database etc.
Association		An association specifies a semantic relationship that can occur between typed instances. Associations can be aggregation, dependency, generalization and realization.
Component		A component represents a modular part of a system that encapsulates its contents and whose manifestation is replaceable within its environment. A



MAHARASHTRA STATE BOARD OF TECHNICAL EDUCATION
(Autonomous)
(ISO/IEC - 27001 - 2005 Certified)

SUMMER-15 EXAMINATION

Model Answer

Subject Code: 17630

Subject Name: Object Oriented Modeling & Design

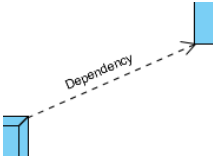
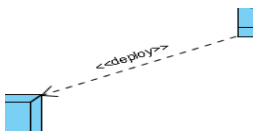
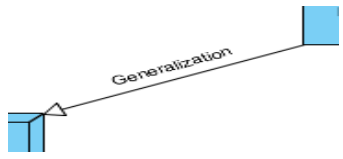
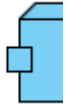
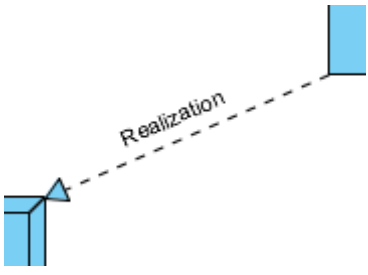
		component defines its behavior in terms of provided and required interfaces
Dependency		A dependency is a relationship that signifies that a single or a set of model elements requires other model elements for their specification or implementation.
Deployment		A deployment is the allocation of an artifact or artifact instance to a deployment target.
Generalization		A generalization is a taxonomic relationship between a more general classifier and a more specific classifier.
Port		A port is a property of a classifier that specifies a distinct interaction point between that classifier and its environment or between the (behavior of the) classifier and its internal parts.
Realization		Realization can be used to model stepwise refinement, optimizations, transformations, templates, model synthesis, framework composition, etc.





MAHARASHTRA STATE BOARD OF TECHNICAL EDUCATION
(Autonomous)
(ISO/IEC - 27001 - 2005 Certified)

SUMMER-15 EXAMINATION

Model Answer

Subject Code: 17630

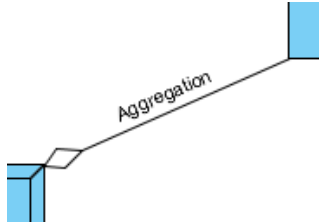
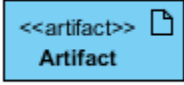
Subject Name: Object Oriented Modeling & Design

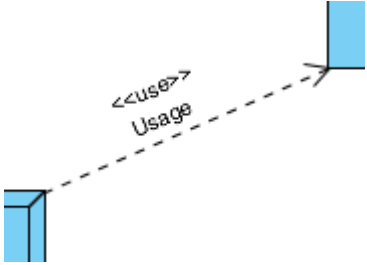
Aggregation		A kind of association that has one of its end marked shared as kind of aggregation, meaning that it has a shared aggregation.
Artifact		An artifact is the specification of a physical piece of information that is used or produced by a software development process, or by deployment and operation of a system.
Interface		An interface is a kind of classifier that represents a declaration of a set of coherent public features and obligations. An interface specifies a contract; any instance of a classifier that realizes the interface must fulfill that contract.
Note		A note (comment) gives the ability to attach various remarks to elements. A comment carries no semantic force, but may contain information that is useful to a modeler.
Usage		A usage is a relationship in which one element requires another element (or set of elements) for its full implementation or operation. In the meta model, a Usage is a Dependency in which the client requires the presence of the supplier.

c)



MAHARASHTRA STATE BOARD OF TECHNICAL EDUCATION
(Autonomous)
(ISO/IEC - 27001 - 2005 Certified)

SUMMER-15 EXAMINATION

Model Answer

Subject Code: 17630

Subject Name: Object Oriented Modeling & Design

Explain Object Modeling Technology (OMT) by Rumbaugh.

(Correct explanation of OMT technique- 4 Marks)

Ans: Rumbaugh's Object modeling technique: The Object Modeling Technique (OMT) presented by James Rumbaugh and his Co-worker describes a method for the analysis, design and implementation of a system using an object-oriented technique. OMT is fast, intuitive approach for identifying and modeling all the objects making up a system. OMT consists of four phases, which can be performed iteratively. The four phases are Analysis, System Design, Object Design and Implementation. The results of this phase are reusable, extendible and robust code.

OMT separates modeling into three different parts: OMT has proposed three main types of models:

1. Object model: The object model represents the static and most stable phenomena in the modeled domain. Main concepts are classes and associations with attributes and operations. Aggregation and generalization (with multiple inheritances) are predefined relationships.

2. Dynamic model: The dynamic model represents a state/transition view on the model. Main concepts are states, transitions between states, and events to trigger transitions. Actions can be modeled as occurring within states. Generalization and aggregation (concurrency) are predefined relationships.

3. Functional model: The functional model handles the process perspective of the model, corresponding roughly to data flow diagrams. Main concepts are process, data store, data flow, and actors.

OMT is a predecessor of the Unified Modeling Language (UML). Many OMT modeling elements are common to UML

d) What is modeling? What are four principles of modeling?

(Modeling- 2 Marks, Four Principles – 2 Marks)

Ans: A model is an abstract representation of a system, constructed to understand system prior to building or modifying it. Building a model for a software system prior to its construction is like preparing a blueprint for building a large building. Model includes fundamental modeling concepts and semantics, notations and guidelines. Models help us to visualize a system as it is or as we want it to be. It permits us to specify the structure or behavior of a system. Models give us a template that guides us in constructing a system. It documents the decisions we have made.

Four principles of modeling:



MAHARASHTRA STATE BOARD OF TECHNICAL EDUCATION
(Autonomous)
(ISO/IEC - 27001 - 2005 Certified)

SUMMER-15 EXAMINATION

Model Answer

Subject Code: 17630

Subject Name: Object Oriented Modeling & Design

- 1. The choice of what models to create has a profound influence on how a problem is attacked and how a solution is shaped:** It means choose your model well. The right models will brilliantly illuminate the most wicked development problems. The wrong models will mislead you, causing you to focus on irrelevant issues.
- 2. Every model may be expressed at different levels of precision:** All the users and developers both may visualize a system at different levels of details at different times.
- 3. The best models are connected to reality:** In object oriented systems, it is possible to connect all the nearly independent views of a system into one semantic whole.
- 4. No single model is sufficient. Every nontrivial system is best approached through a small set of nearly independent models:** To understand the architecture of a system, you need multiple interlocking views such as use case view, design view, process view, implementation view and deployment view. Each of these views may have structural as well as behavioral aspects. Together these views represent a system.

e) Describe the term dependencies with respect to class diagram.

(Explanation & Diagram – 4 Marks)

Ans: Dependency is a weaker form of bond which indicates that one class depends on another because it uses it at some point in time. One class depends on another if the independent class is a parameter variable or local variable of a method of the dependent class. This is different from an association, where an attribute of the dependent class is an instance of the independent class. Sometimes the relationship between two classes is very weak. They are not implemented with member variables at all. Rather they might be implemented as member function arguments.

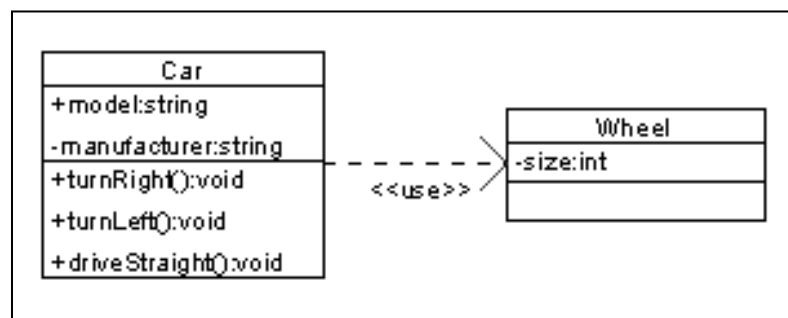



MAHARASHTRA STATE BOARD OF TECHNICAL EDUCATION
(Autonomous)
(ISO/IEC - 27001 - 2005 Certified)

SUMMER-15 EXAMINATION

Model Answer

Subject Code: 17630

Subject Name: Object Oriented Modeling & Design

f) Differentiate between functional modeling and dynamic modeling.

(Any Four Points – 4 Marks)

Ans:

Dynamic Model	Functional Model
It gives control aspect of a system	It gives Functional aspect of a system
It describes the aspects of a system and implements the control aspects of a system.	It describes computation within a system and those aspects of a system related with transformation of values, functions, mapping, restrictions and functional dependencies.
It contains state diagrams.	The functional model shows how output values are calculated from input. Functional model contains Data Flow Diagram.
A state diagram is a graph whose nodes are states and arcs are transition between states caused by events.	DFD is graph whose nodes are process and arcs are data flow directions.
States are nothing but values of objects. Events are those which represent external response.	Functional Model captures what a system does without regard to how or when it is done
We examine changes in the objects and their relationships over time.	DFD shows dependencies between values.



MAHARASHTRA STATE BOARD OF TECHNICAL EDUCATION
(Autonomous)
(ISO/IEC - 27001 - 2005 Certified)

SUMMER-15 EXAMINATION

Model Answer

Subject Code: 17630

Subject Name: Object Oriented Modeling & Design

4. Attempt any TWO of the following:

Marks 16

a) Draw use case diagram for hospital management.

(Any relevant use case diagram with proper notation - 8 Marks)

Ans:

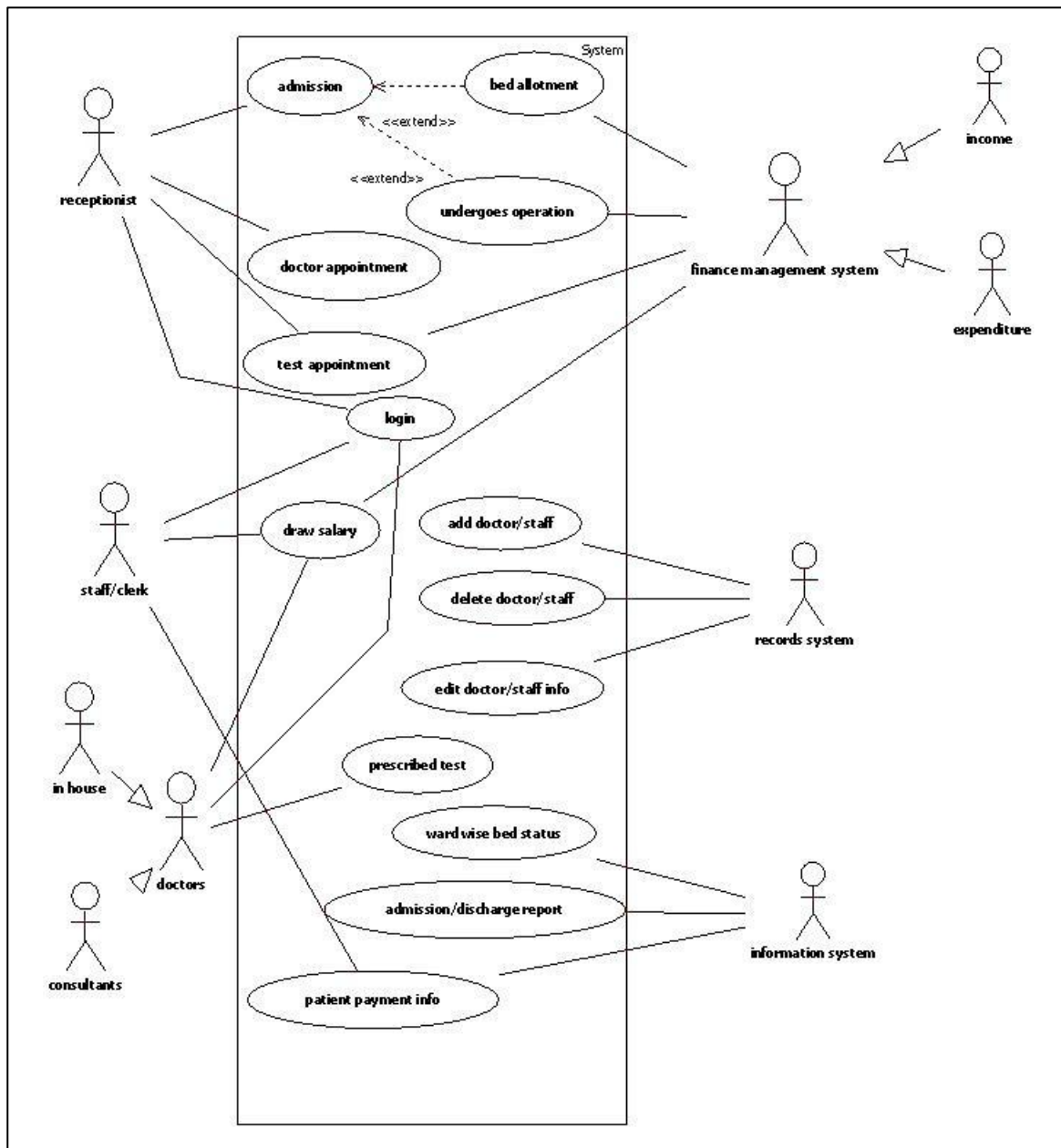



MAHARASHTRA STATE BOARD OF TECHNICAL EDUCATION
(Autonomous)
(ISO/IEC - 27001 - 2005 Certified)

SUMMER-15 EXAMINATION

Model Answer

Subject Code: 17630

Subject Name: Object Oriented Modeling & Design

b) Draw and explain state chart diagram for ATM.

(Any Relevant state chart diagram for ATM with proper notation - 5 Marks & Explanation -3 Marks)

Ans: Steps for Building a state chart diagram for ATM.

1. Prepare a state diagram for each object class with non-trivial dynamic behaviour showing the events the object receives and sends.
2. Every scenario or event trace corresponds to a path through the state diagram. State chart diagram for ATM
3. Each branch in Control flow is represented by a state with more than one exit transition.

In ATM, system might be in one of three basic states:

- I. Idle (Waiting for customer interaction)
- II. Active (Handling a customer's interaction)
- III. Maintenance (Perhaps having its cash store replenished)

While Active, the behavior of the ATM follows a simple path: Validate the customer, select transaction, process transaction & print a receipt. After printing, the ATM returns to idle state. We represent these stages of behavior as the states Validating, Selecting, processing & Printing. It would be desirable to let customer select & process multiple transaction after validating the account & before Printing Final receipt.

The state of ATM changes from Idle to Active when customer enters a credit card in machine. On entering Active state, entry action read card is performed. Starting with initial state of substructure, control passes to validating state, then selecting state & then to processing state.

After processing, control may return to selecting (if customer has selected another transaction) or it may move on to printing. After printing there's a complete transistion back to idle state.

Active state has an exit action, which ejects customer's card.



**MAHARASHTRA STATE BOARD OF TECHNICAL EDUCATION
(Autonomous)
(ISO/IEC - 27001 - 2005 Certified)**

SUMMER-15 EXAMINATION

Model Answer

Subject Code: 17630

Subject Name: Object Oriented Modeling & Design

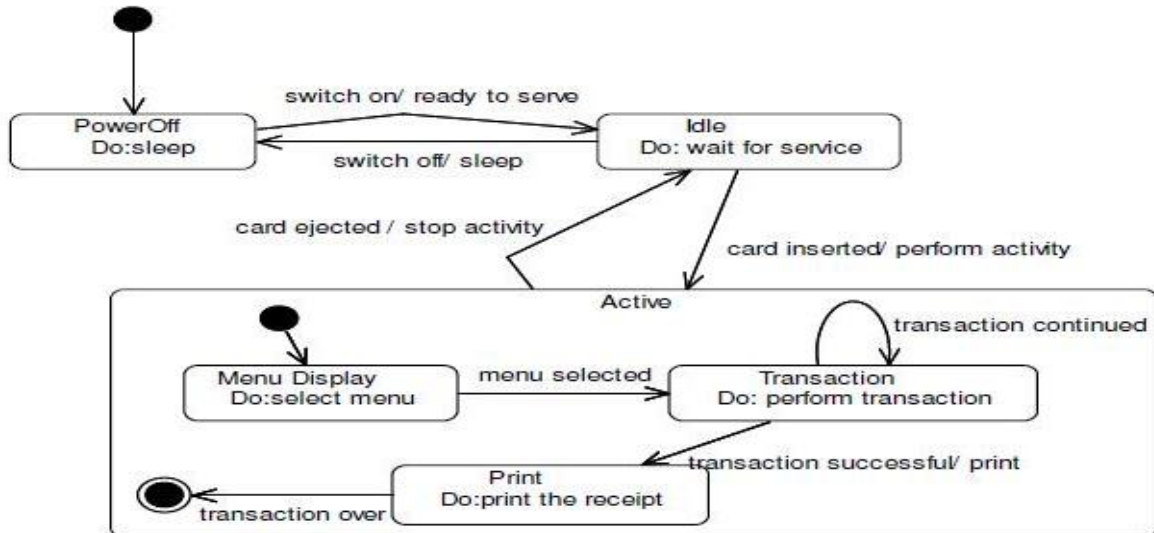

State Diagram for ATM system

OR

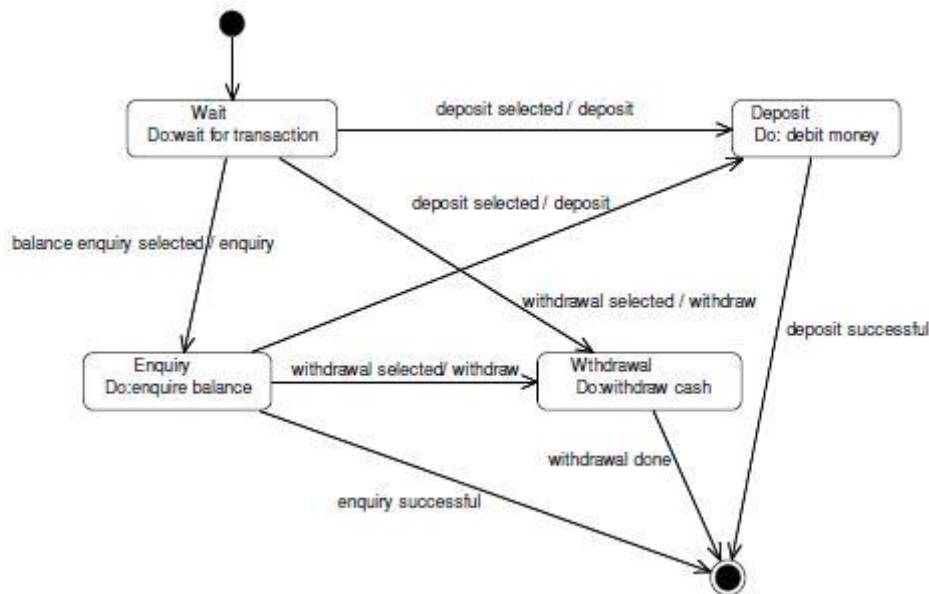

State Diagrams for ATM Transaction



MAHARASHTRA STATE BOARD OF TECHNICAL EDUCATION
(Autonomous)
(ISO/IEC - 27001 - 2005 Certified)

SUMMER-15 EXAMINATION

Model Answer

Subject Code: 17630

Subject Name: Object Oriented Modeling & Design

c) Draw a sequence diagram for printing a file.

(Any relevant sequence diagram with proper notation - 8 Marks)

Ans:

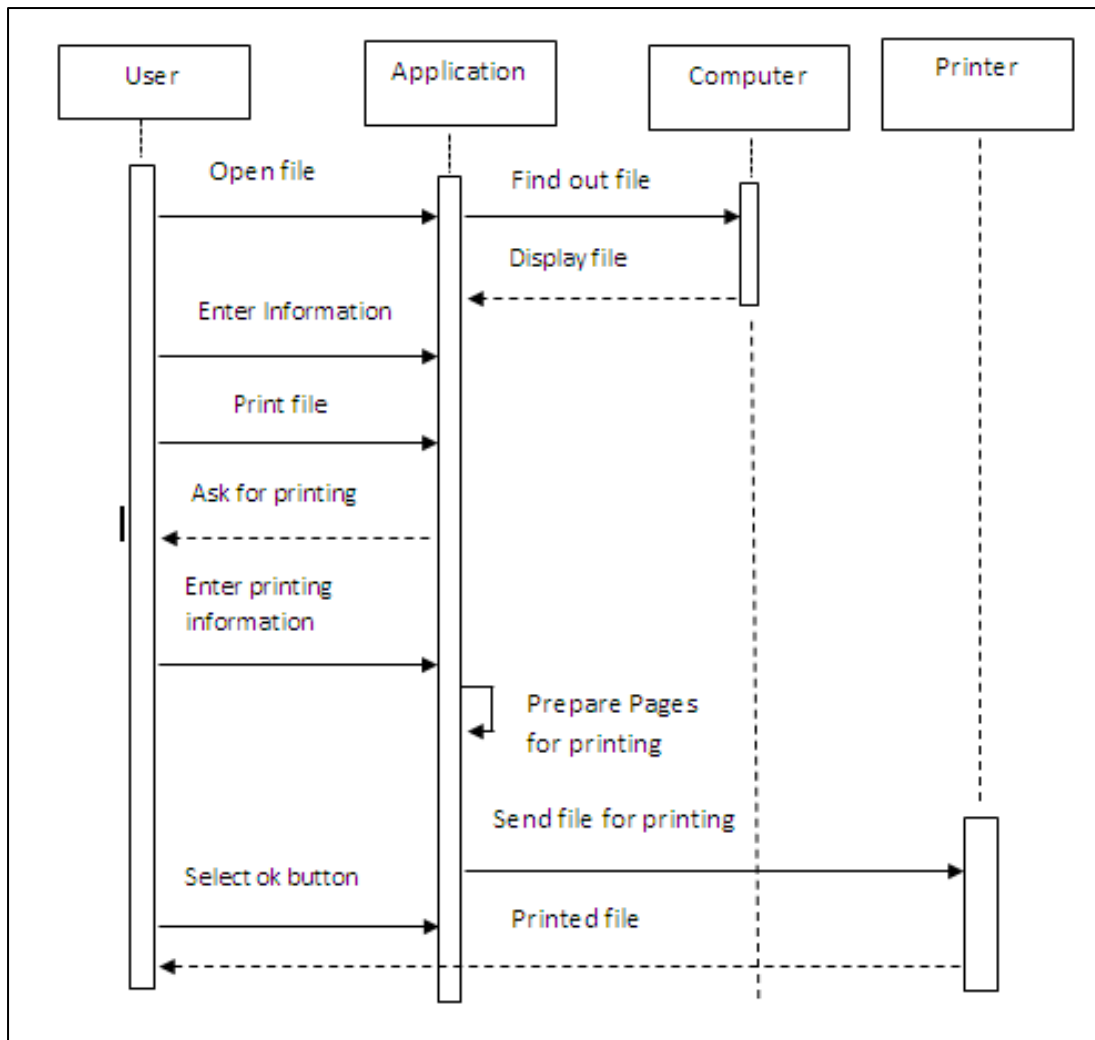



MAHARASHTRA STATE BOARD OF TECHNICAL EDUCATION
(Autonomous)
(ISO/IEC - 27001 - 2005 Certified)

SUMMER-15 EXAMINATION

Model Answer

Subject Code: 17630

Subject Name: Object Oriented Modeling & Design

5. Attempt any **FOUR** of the following:

Marks 16

a) Explain sequence diagram with suitable example.

(Explanation- 2 Marks, Example – 2 Marks)

Ans: Sequence diagram emphasizes on time sequence of messages and collaboration diagram emphasizes on the structural organization of the objects that send and receive messages. This diagram is a model describing how groups of objects collaborate in some behavior over time. The diagram captures the behavior of a single use case. It shows objects and the messages that are passed between these objects in the use case. A good design can have lots of small methods in different classes. Without this it can be difficult to figure out the overall sequence of behavior. This diagram is simple and visually logical, so it is easy to see the sequence of the flow of control. A sequence diagram also clearly shows concurrent processes and activations.

Purpose:

Purposes of sequence diagram can be describes as:

- To capture dynamic behavior of a system.
- To describe the message flow in the system.
- To describe structural organization of the objects.
- To describe interaction among objects.

Example of Sequence Diagram



MAHARASHTRA STATE BOARD OF TECHNICAL EDUCATION
(Autonomous)
(ISO/IEC - 27001 - 2005 Certified)

SUMMER-15 EXAMINATION

Model Answer

Subject Code: 17630

Subject Name: Object Oriented Modeling & Design

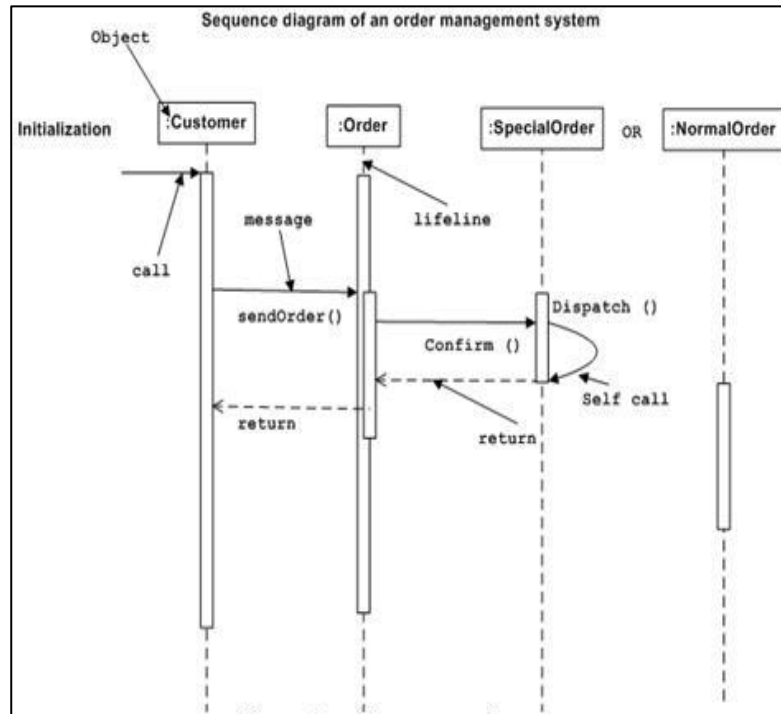

b) Explain decision (Branching) in activity diagram.

(Explanation of branching – 2 Marks, Suitable diagram – 2 Marks)

Ans: Branching:

Branches are notational convenience, equivalent to multiple transitions with guards. A branch may consist of one incoming transition and two or more outgoing transitions, you can place a Boolean expression, which is evaluated only once on entering the branch. Across all these outgoing transitions, guards should not overlap (otherwise, the flow of control would be ambiguous), but they should cover all possibilities (otherwise the flow of control would freeze.) You can use the keyword else to mark one outgoing transition, representing the path taken if no other guard expression evaluates to true. You can achieve the effect of iteration by using one action state that sets the value of an iteration, another action state that increment the iteration, and a branch that evaluates of the iteration is finished.



MAHARASHTRA STATE BOARD OF TECHNICAL EDUCATION
(Autonomous)
(ISO/IEC - 27001 - 2005 Certified)

SUMMER-15 EXAMINATION

Model Answer

Subject Code: 17630

Subject Name: Object Oriented Modeling & Design

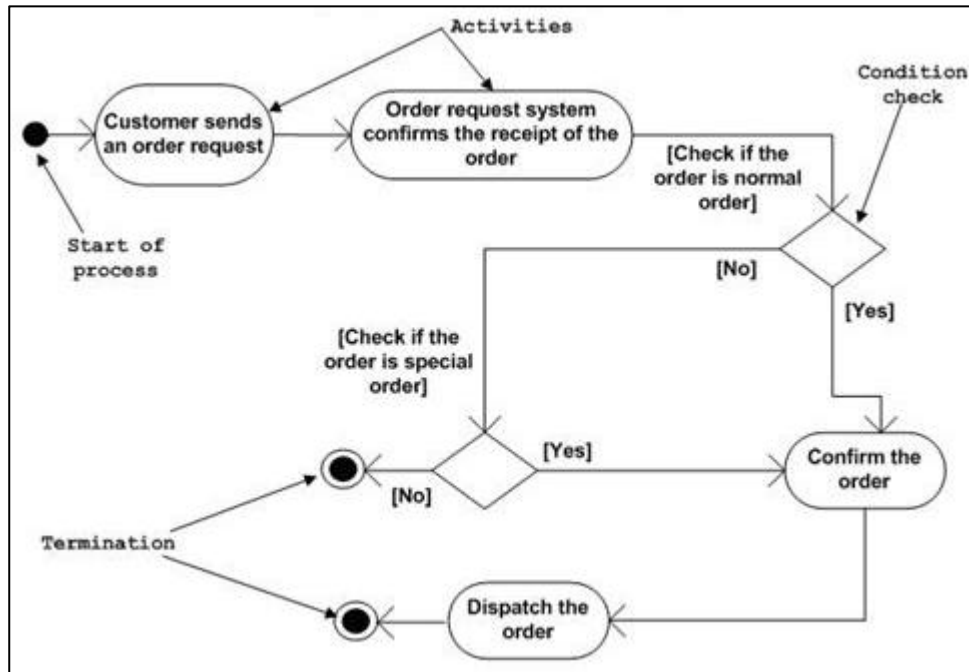

c) Explain propagation of operation with suitable example.

(Explanation of Propagation of operation – 2 Marks, Suitable diagram – 2 Marks)

Ans: Propagation of Operation:

Propagation (Also called Triggering) is the automatic application of an operation to a network of objects when the operation is applied to some starting object. Propagation of operations to parts is often a good indicator of propagation. Propagation is very well applicable to aggregated objects, operation carried on whole eventually changes the states of sub objects.

Example: A person owns multiple documents. Each document consists of paragraphs to characters. Copying a paragraph copies all the characters in it. The operation does not propagate in the reverse direction; a paragraph can be copied without copying the whole document. Similarly, copying a document copies the owner link but does not generate a copy of the person which is owner.

Example:

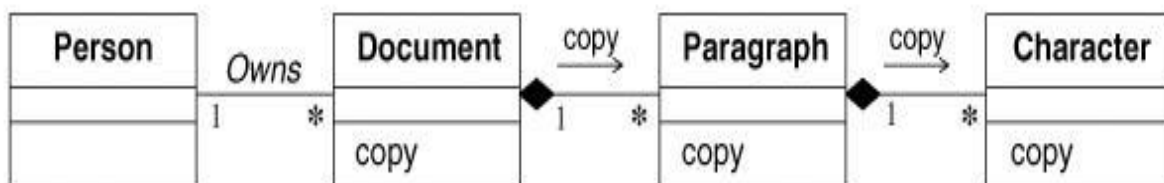



MAHARASHTRA STATE BOARD OF TECHNICAL EDUCATION
(Autonomous)
(ISO/IEC - 27001 - 2005 Certified)

SUMMER-15 EXAMINATION

Model Answer

Subject Code: 17630

Subject Name: Object Oriented Modeling & Design

d) Explain sequential substate with example.

(Explanation-2 Marks, Example – 2 Marks)

Ans: Substates

- A sub state is a state that's nested inside another one.
- A state that has sub states is called a composite state.
- A composite state may contain either *concurrent (orthogonal) or sequential (disjoint) substates*.
- Substates may be nested to any level

Sequential Substates

- Sequential Sub states are those sub states in which an event common to the composite states can easily be exercised by each states inside it at any time
- sequential sub states partition the state space of the composite state into disjoint states
- Below Figure shows Sequential Sub states
- A nested sequential state machine may have at most one initial state and one final state

Consider the problem of modeling the behavior of an ATM. This system might be in one of three basic states: Idle (waiting for customer interaction), Active (handling a customer's transaction), and Maintenance (perhaps having its cash store replenished). While Active, the behavior of the ATM follows a simple path: Validate the customer, select a transaction, process the transaction, and then print a receipt. After printing, the ATM returns to the Idle state. You might represent these stages of behavior as the states Validating, Selecting, Processing, and Printing. It would even be desirable to let the customer select and process multiple transactions after Validating the account and before Printing a final receipt.



MAHARASHTRA STATE BOARD OF TECHNICAL EDUCATION
(Autonomous)
(ISO/IEC - 27001 - 2005 Certified)

SUMMER-15 EXAMINATION

Model Answer

Subject Code: 17630

Subject Name: Object Oriented Modeling & Design

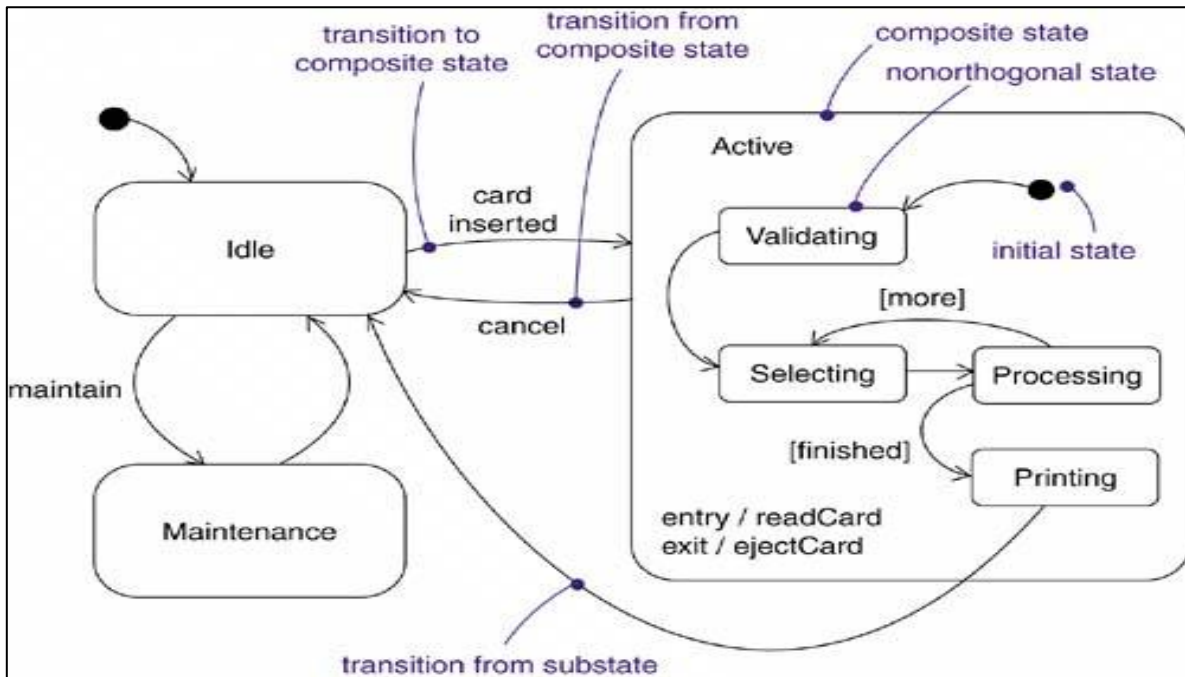

e) State the importance of generalization in class diagram with suitable example.

(Two Importance 2 Marks ; Example -2 Marks)

Ans:

- A generalization is a binary taxonomic (i.e. related to classification) directed relationship between a more general classifier (superclass) and a more specific classifier (subclass).
- Each instance of the specific classifier is also an indirect instance of the general classifier, so that we can say "Patient is a Person", "Savings account is an Account", etc. Because of this, generalization relationship is also informally called "Is A" relationship.
- Generalization is owned by the specific classifier.
- A generalization is shown as a line with a hollow triangle as an arrowhead between the symbols representing the involved classifiers. The arrowhead points to the symbol representing the general classifier. This notation is referred to as the "separate target style."
- Generalization relationships that reference the same general classifier can also be connected together in the "shared target style."



MAHARASHTRA STATE BOARD OF TECHNICAL EDUCATION
(Autonomous)
(ISO/IEC - 27001 - 2005 Certified)

SUMMER-15 EXAMINATION

Model Answer

Subject Code: 17630

Subject Name: Object Oriented Modeling & Design

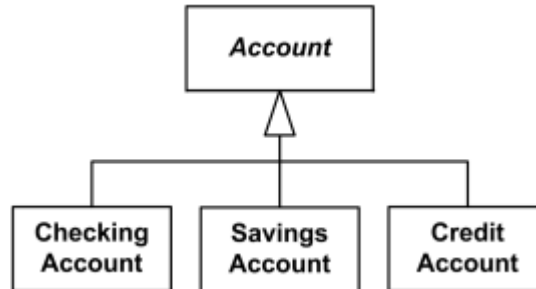

f) **What are the components of a state chart diagram?**

(Any four Components with its use 1 Mark each)

Ans: Initial State

The initial state represents the source of all objects: It is not a normal state, because objects in this state do not yet exist. It is denoted as follows;



State

The state of an object is always determined by its attributes and associations. States in statechart diagrams represent a set of those value combinations, in which an object behaves the same in response to events: It is denoted as follows;



Transition

A transition represents the change from one state to another: It is denoted as follows;



Internal Transition

An internal transition is a transition from one state to itself. This means that the object handles the event without changing its state: It is denoted as follows;

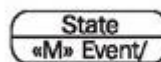

The events that initiate the internal transition are listed in the lower part of the state symbol. For instance, a frequent flyer card object in the state normal remains in the state normal when the event «M» add miles occurs.



MAHARASHTRA STATE BOARD OF TECHNICAL EDUCATION
(Autonomous)
(ISO/IEC - 27001 - 2005 Certified)

SUMMER-15 EXAMINATION

Model Answer

Subject Code: 17630

Subject Name: Object Oriented Modeling & Design

Final State

The final state represents the end of an object's existence: A final state is not a real state, because objects in this state do not exist anymore. It is denoted as follows;



Action

An action is the activity of an object that is initiated by an event: An action describes what the object does in response to the event. This description can be textual or formalized. It is denoted as follows;

«M» Event/Action

Guard Condition

A guard condition is a condition that has to be met in order to enable the transition to which it belongs: It is denoted as follows;

[Guard Condition]

Guard conditions can be used to document that a certain event, depending on the condition, can lead to different transitions.



MAHARASHTRA STATE BOARD OF TECHNICAL EDUCATION
(Autonomous)
(ISO/IEC - 27001 - 2005 Certified)

SUMMER-15 EXAMINATION

Model Answer

Subject Code: 17630

Subject Name: Object Oriented Modeling & Design

6. Attempt any TWO of the following:

Marks 16

a) Draw use case diagram for railway reservation.

(Any relevant diagram- 8 Marks)

Ans:

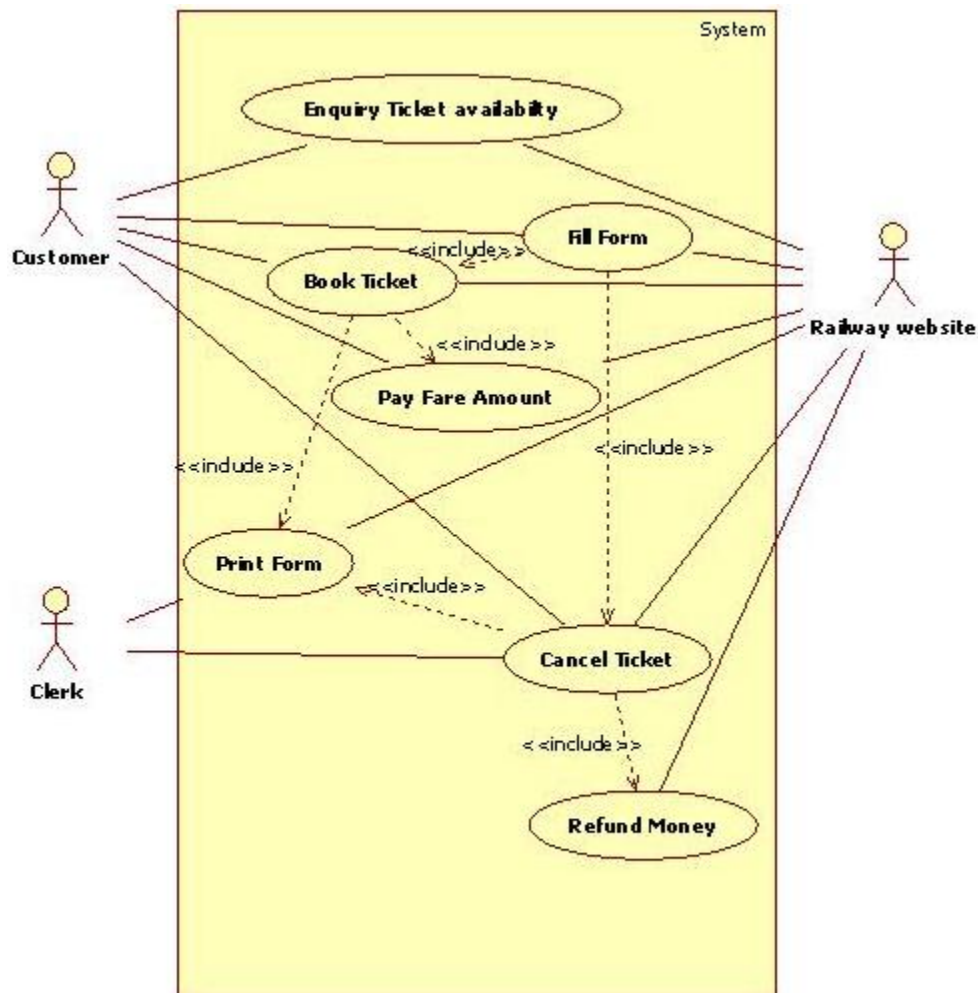

Railway Reservation System is a system used for booking tickets over internet. Any Customer Can book tickets for different trains. Customer can book a ticket only if the tickets are available. Customer searches for the availability of tickets then if the tickets are available he books the tickets by initially filling details in a form. Tickets can be booked in two ways by i-ticket or by e-ticket booking.



MAHARASHTRA STATE BOARD OF TECHNICAL EDUCATION
(Autonomous)
(ISO/IEC - 27001 - 2005 Certified)

SUMMER-15 EXAMINATION

Model Answer

Subject Code: 17630

Subject Name: Object Oriented Modeling & Design

b) Draw activity diagram for making photocopies of xerox machine.

(Any relevant diagram -8 Marks)

Ans:

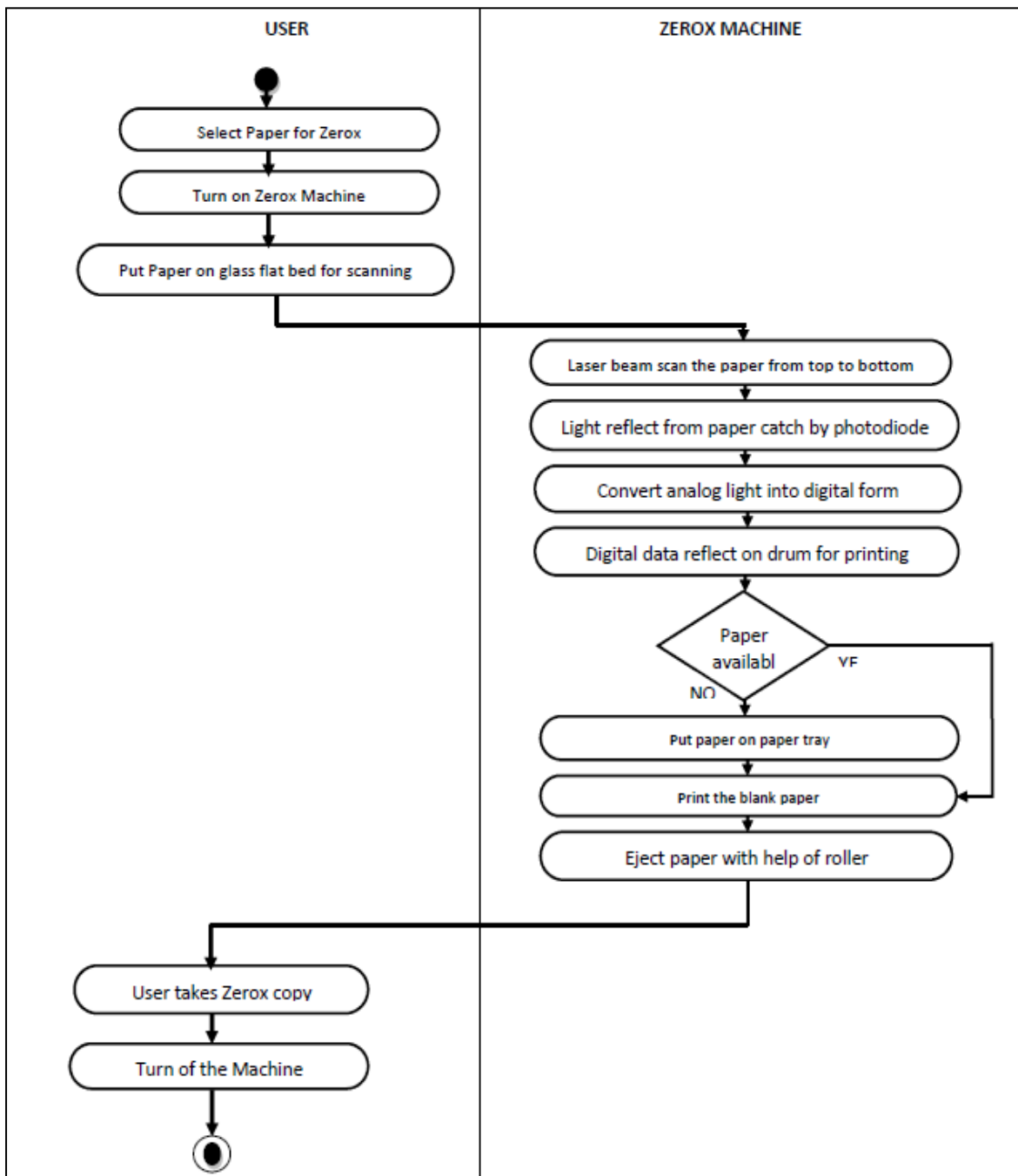



MAHARASHTRA STATE BOARD OF TECHNICAL EDUCATION
(Autonomous)
(ISO/IEC - 27001 - 2005 Certified)

SUMMER-15 EXAMINATION

Model Answer

Subject Code: 17630

Subject Name: Object Oriented Modeling & Design

c) Draw sequence diagram for placing purchase order.

(Any relevant diagram - 8 Marks)

Ans:

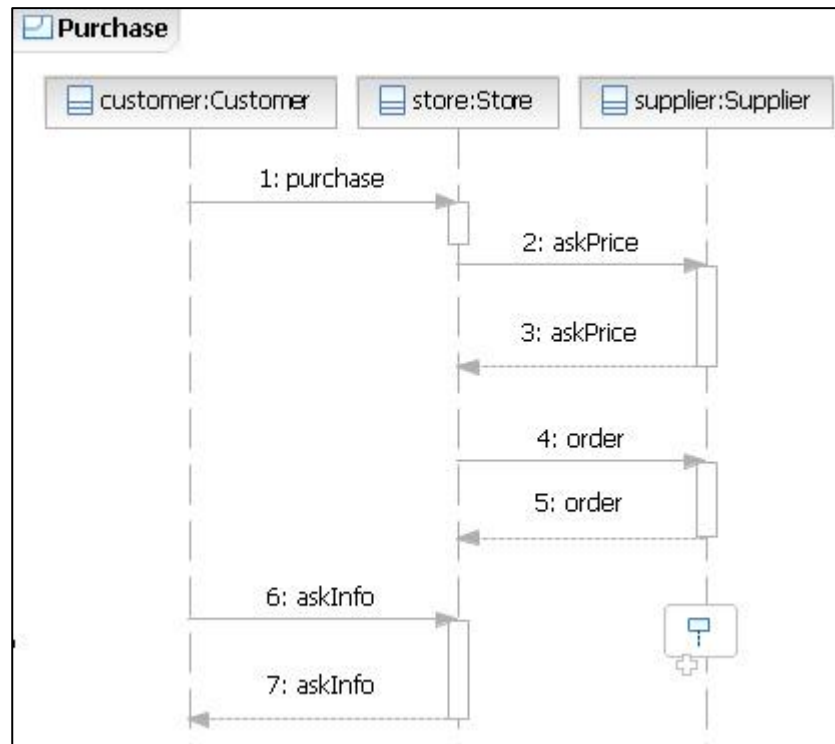

OR



MAHARASHTRA STATE BOARD OF TECHNICAL EDUCATION
(Autonomous)
(ISO/IEC - 27001 - 2005 Certified)

SUMMER-15 EXAMINATION

Model Answer

Subject Code: 17630

Subject Name: Object Oriented Modeling & Design

