



Main catalog

OPR lightning protection systems

External lightning protection

OPR lightning protection systems

External lightning protection



Lightning mechanism and location	2
Lightning protection technologies	3
Lightning protection risk analysis	8
Lightning protection technical study	9
Procedure for measuring the Early Streamer Emission of an ESE air terminal according to standard NF C 17-102 appendix C	10
Tests and research	12
Lightning capture devices	14
Down conductors	16
Equipotential bonding	19
Earth termination systems	21
Inspection ESEAT maintenance	23
Lightning air terminal range	
ESEAT typical installation	24
OPR, the high pulse voltage, initiation advance lightning air terminal	26
Early Streamer Emission Air Terminal - ESEAT	27
Single Rod Air Terminal - SRAT	29
Extension masts	30
Masts and extension masts	31
Pylons	32
Lateral fixations	33
Roof fixing accessories	35
Conductors and coupling accessories	36
Conductor fasteners	37
Earth coupling accessories	39
Earthing system	40
Equipotential bonding	43
Meshed conductors	
Typical installation	44
Accessories	45
Index	46

Lightning mechanism and location

Storms

The presence of unstable, moist and warm air masses gives rise to the formation of cumulonimbus storm clouds. This type of cloud is very extensive, both horizontally (about 10 km in diameter) and vertically (up to 15 km). Its highly characteristic shape is often compared with the profile of an anvil of which it displays the upper and lower horizontal planes. The existence of extreme temperature gradients in a cumulonimbus (the temperature can drop to $-65\text{ }^{\circ}\text{C}$ at the top) generates very rapid ascending air currents, and results in the electrical energisation of the water particles.

In a typical storm cloud, the upper part, consisting of ice crystals, is normally positively charged, whilst the lower part, consisting of water droplets, is negatively charged. Consequently, the lower part of the cloud causes the development of electrically opposite charges (i.e. positive over the part of the ground nearby).

Thus the cumulonimbus formation constitutes a sort of huge plate /ground capacitor whose median distance can often reach 1 to 2 km. The atmospheric electrical field on the ground, about 600 V/m in fine weather is reversed and can reach an absolute value of 15 to 20 kV/m when a ground discharge is imminent (the lightning stroke).

Before and during the appearance of the lightning stroke, discharges can be seen both within the cloud and between clouds.

Lightning

According to the direction in which the electrical discharge develops (downward or upward), and the polarity of the charges it develops (negative or positive), four classes of cloud-to-ground lightning stroke can be distinguished. In practice, lightning strokes of the descending and negative type are by far the most frequent: it is estimated that on plains and in our temperate zones, they account for 96 % of all cloud / ground discharges.

Mechanism of a lightning stroke

It is impossible to discern the individual phases of the lightning stroke by simple visual observation. This can only be done with high-speed cameras. Most lightning bolts exhibit the following phenomena: a leader leaves a point in the cloud and travels about 50 m at a very high speed of around 50 000 km/s. A second leader then leaves the same point, follows the previous path at comparable speed, goes beyond the final point of the first leader by an approximately identical distance, then disappears in turn.

The process is repeated until the tip of the last leader reaches a point a few dozen metres, or even just a few metres above ground level.

The ascending jets then converge, producing a return stroke from the ground towards the cloud (the upward streamer) during which the electric current circulates: The convergence of these two phenomena produces the main discharge, which may be followed by a series of secondary discharges, passing unbroken along the channel ionised by the main discharge. In an average negative lightning stroke, the maximum current is around 35 000 A.

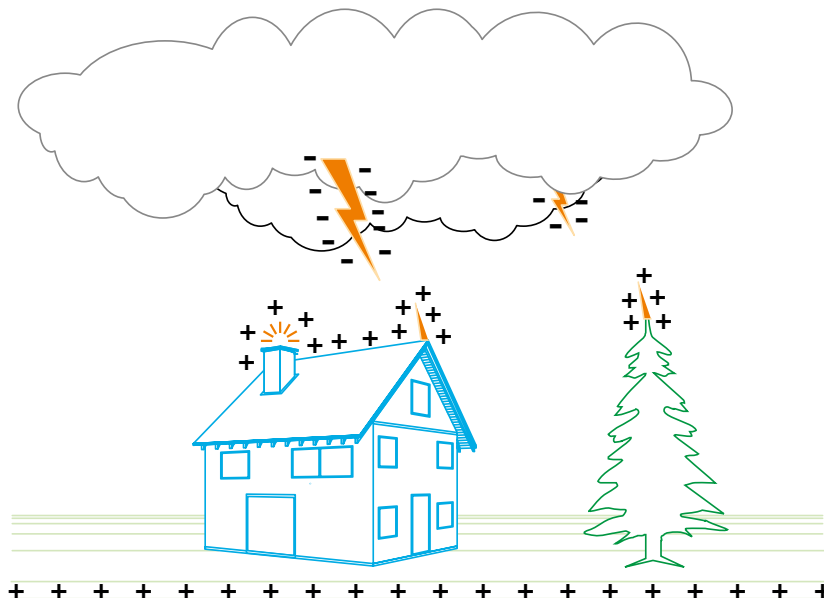

Lightning protection technologies

The effects of lightning

The effects of lightning are those of a high-strength impulse current that propagates initially in a gaseous environment (the atmosphere), and then in a solid, more or less conductive medium (the ground):

- visual effects (flash): caused by the Townsend avalanche mechanism
- acoustic effects: caused by the propagation of a shock wave (rise in pressure) originating in the discharge path; this effect is perceptible up to a range of around 10 km
- thermal effect: heat generated by the Joule effect in the ionised channel
- electrodynamic effects: these are the mechanical forces applied to the conductors placed in a magnetic field created by the high voltage circulation. They may result in deformations
- electrochemical effects: these relatively minor effects are conveyed in the form of electrolytic decomposition through the application of Faraday's law
- induction effects: in a variable electromagnetic field, every conductor harnesses induced current
- effects on a living being (human or animal): the passage of a transient current of a certain r.m.s value is sufficient to incur risks of electrocution by heart attack or respiratory failure, together with the risk of burns.

Lightning causes two major types of accidents:

- accidents caused by a direct stroke when the lightning strikes a building or a specific zone. This can cause considerable damage, usually by fire. Protection against this danger is provided by lightning air terminal systems
- accidents caused indirectly, as when the lightning strikes or causes power surges in power cables or transmission links. Hence the need to protect with SPD the equipment at risk against the surge voltage and indirect currents generated.

Protection against direct lightning stroke

To protect a structure against lightning strokes, a preferred impact point is selected to protect the surrounding structure and conduct the flow of the electric current towards the ground, with minimal impedance on the path followed by the lightning. Four types of protection systems meet these requirements.

Protection systems

Early streamer emission air terminal

Standards

- France: NF C 17-102 (September 2011 edition)
- Argentina: IRAM 2426
- Spain: UNE 21186
- Macedonia: MKS N.B4 810
- Portugal: NP 4426
- Romania: I-20
- Slovakia: STN 34 1391
- Serbia: JUS N.B4.810

Single rods air terminals

IEC 62 305-3

Meshed cages

IEC 62 305-3

Stretched wires

IEC 62 305-3

Lightning protection technologies

Lightning protection system with early streamer emission air terminal (ESEAT)

These state-of-the-art technologies have been designed on the basis of a series of patents registered jointly by HELITA and the French National Scientific Research Centre (CNRS). The OPR is equipped with an electronic device which is high pulse voltage of known and controlled frequency and amplitude enabling the early formation of the upward leader which is then continuously propagated towards the downward leader. This anticipation in the upward leader formation is essential

with regard to the last scientific knowledge on the lightning attachment that acknowledges the fact that this one results from an upward leader competition. Today the upward leader competition is internationally recognized thanks to high speed cameras pictures of this phenomenon of attachment and to its digital simulation.

The OPR draws its energy from the ambient electrical field during the storm. After capturing the lightning stroke, the OPR directs it towards the down conductors to the ground where it is dissipated.

Triggering time of an ESEAT

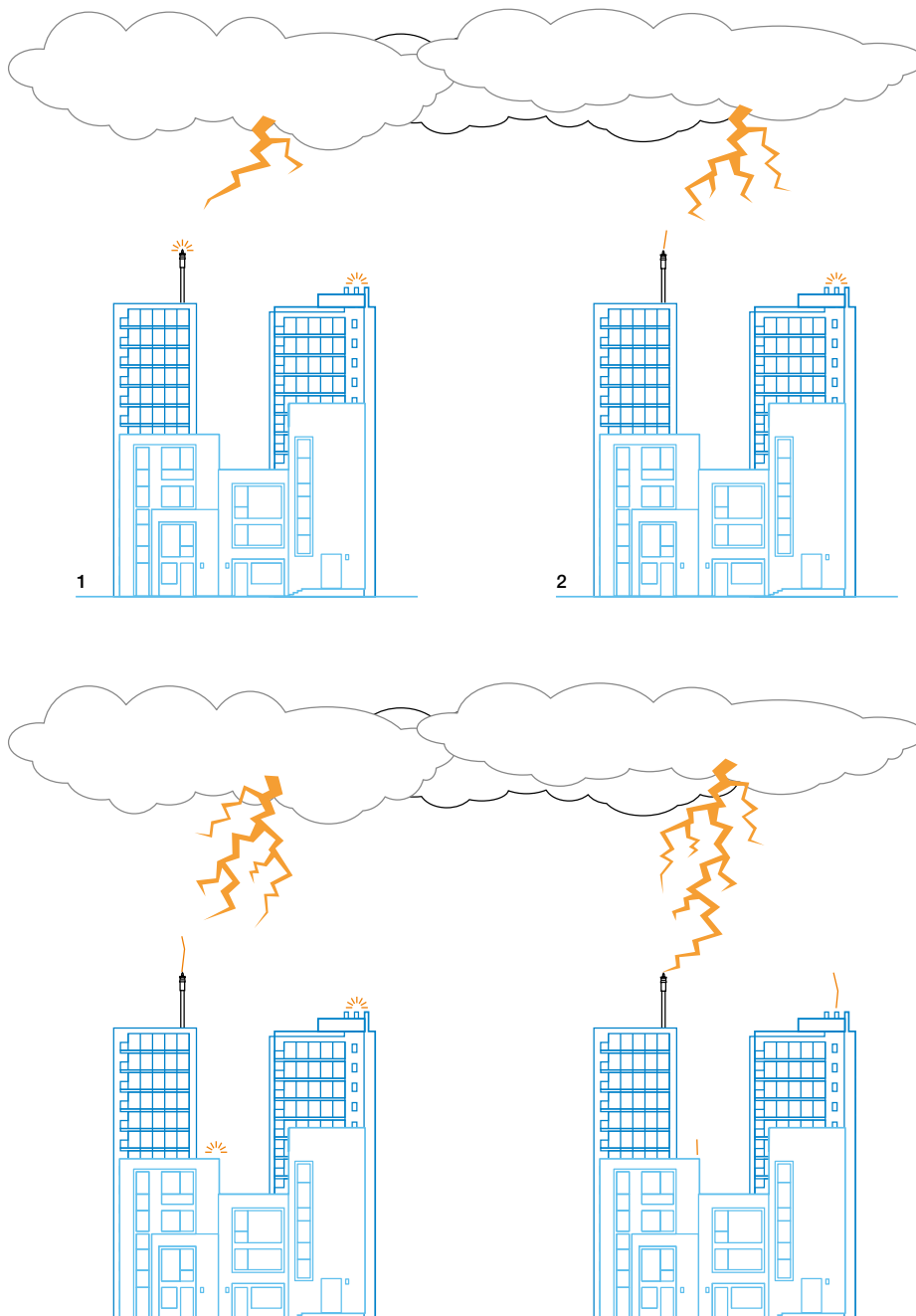

Lightning protection technologies

The early streamer emission (ESE) concept

During a storm, when the propagation field conditions are favourable, the OPR first generates an upward leader. This leader from the OPR tip propagates towards the downward leader from the cloud at an average speed of 1 m/μs.

The triggering time ΔT (μs) is defined as the mean gain at the sparkover instant (continuous propagation of the upward leader) obtained with an ESE air terminal compared with a single rod air terminal exposed to the same conditions. ΔT is measured in the high-voltage laboratory, all tests are defined in appendix C of the French standard NF C 17-102.

The triggering time instance gain ΔT is associated with a triggering time distance gain ΔL .

$\Delta L = v \cdot \Delta T$, where:

- ΔL (m): gain in lead distance or sparkover distance
- v (m/μs): average speed of the downward tracer (1 m/μs).
- ΔT (μs): gain in sparkover time of the upward leader measured in laboratory conditions.

OPR air terminals are especially effective for the protection of classified industrial sites, administrative or public buildings, historical monuments and open-air sites such as sports grounds.

Lightning protection technologies

Installation conditions

Lightning Protection System with an ESEAT is made of:

- an Early Streamer Emission Air Terminal and its extension mast
- two down conductors, or in case of several ESEAT one conductor per ESEAT
- a connecting link or test joint for each down conductor to enabling the earth resistance to be verified
- a protecting flat to protect the down conductor for the last two meters above ground level
- an earth designed to dissipate the lightning currents at the bottom of each down conductor
- an equipotential bonding between each earth and the general earthing circuit of the structure; this one must be disconnectable
- protection measures against injuries to leaving being due to touch and step voltages (e.g. warning notice).

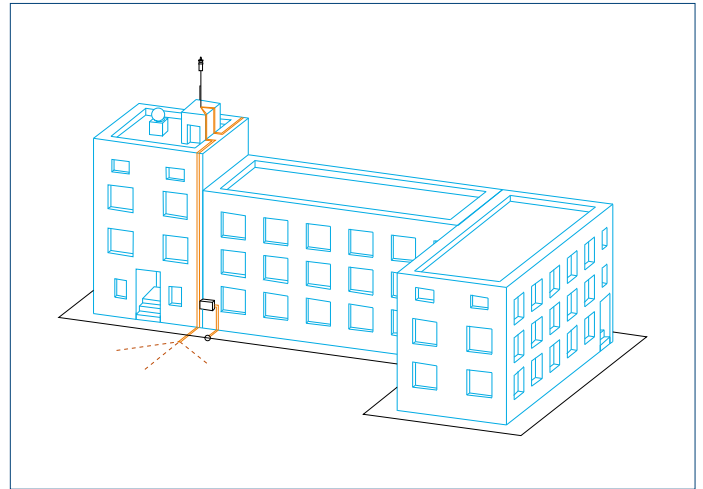

Lightning protection system with single rod air terminal

By protruding upwards from the building, they are likely to trigger the release of ascending streamers and thus be selected as impact points by lightning strokes occurring within the vicinity of the structure.

This type of protection is especially recommended for radio stations and antenna masts when the area requiring protection is relatively small.

A single rod air terminal protection is made up of:

- a rod lightning air terminal and its extension mast
- two down conductors
- a connection link or test joint on each down conductor to check the conductor earth resistance
- a protecting flat to protect the down conductor for the last two meters above ground level
- an equipotential bonding between each earth and the general earthing circuit of the structure; this one must be disconnectable
- protection measures against injuries to leaving being due to touch and step voltages (eg warning notice).

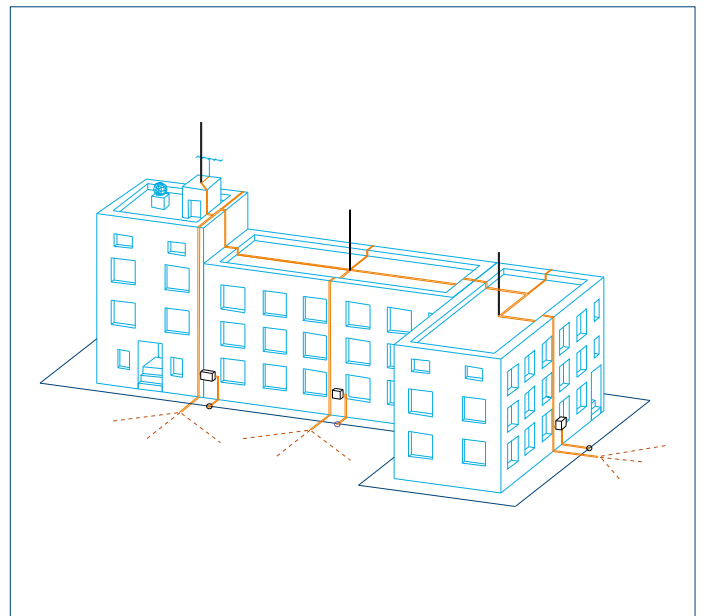

Lightning protection system with meshed cages

This principle consists of dividing up and more easily dissipating the lightning current by a network of conductors and earths.

A meshed cage installation has multiple down conductors and consequently provides very effective protection for buildings that house equipment sensitive to electromagnetic disturbance. This is because the lightning current is divided among the down conductors and the low current circulating in the mesh creates very little disturbance by induction.

A meshed cage installation is made up of:

- devices to capture the atmospheric discharges consisting of strike points
- roof conductors
- down conductors
- protection measures against injuries to leaving being due to touch and step voltages (e.g. warning notice)
- an equipotential bonding between each earth and the general earthing circuit of the structure; this one must be disconnectable.

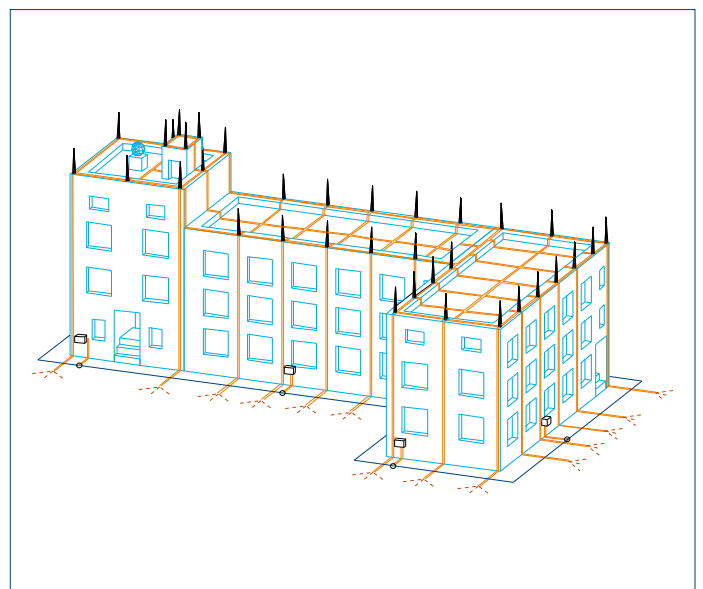

Lightning protection technologies

Stretched wires

This system is composed of one or several conductor wires stretched above the protected installation. The protection area is determined by applying the electro-geometrical model.

The conductors must be earthed at each end.

A stretched wire installation requires a thorough preliminary study to consider issues such as mechanical strength, the type of installation, and the insulation distances.

This technology is used to protect ammunition depots and as a general rule in circumstances where the site cannot be protected by using a building structure to support the conductors that convey the lightning currents to the earth.

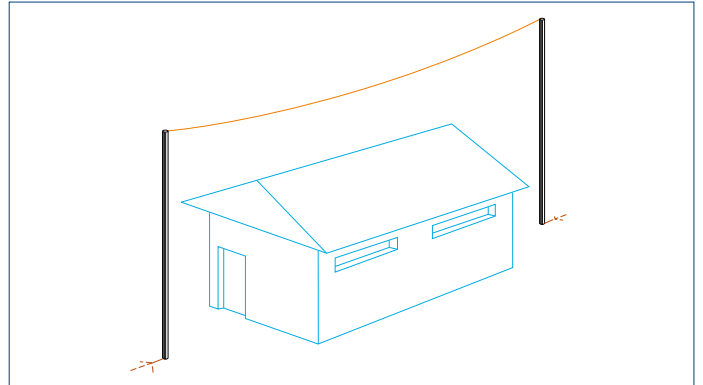

Protection against indirect lightning stroke effects

When lightning strikes cables and transmission lines (H.F. coaxial cables, telecommunication lines, power cables), a voltage surge is propagated and may reach equipment in the surrounding. This voltage surge can also be generated by induction due to the electromagnetic radiation of the lightning flash.

This can have many consequences: premature component ageing, destruction of printed circuit boards or component plating, equipment failure, data loss, programs hanging, line damage, etc. This is why you need to use Surge Protective Devices to protect equipment liable to be affected by lightning strikes.

The use of Surge Protective Devices is highly recommended when the building is fitted with an external lightning protection. A type 1 SPD is highly recommended or even mandatory in some countries. A good protection is made in step with one type 1 fitted in the MDB when the SDB are fitted with type 2 SPDs.

Equipotential bonding of metal parts

During a lightning stroke or even as a result of indirect effects, equipotential bonding defects can, by differences in potential, generate sparkover causing risk for human being or fire into the structure.

This is why it is an essential part of effective lightning protection to ensure that a site's equipotential bonding is effective and in good condition.

The necessity of an electrical insulation between the air termination or the down-conductor and the structural metal parts, the metal installations and the internal systems can be achieved by providing a separation distance "s" between the parts.

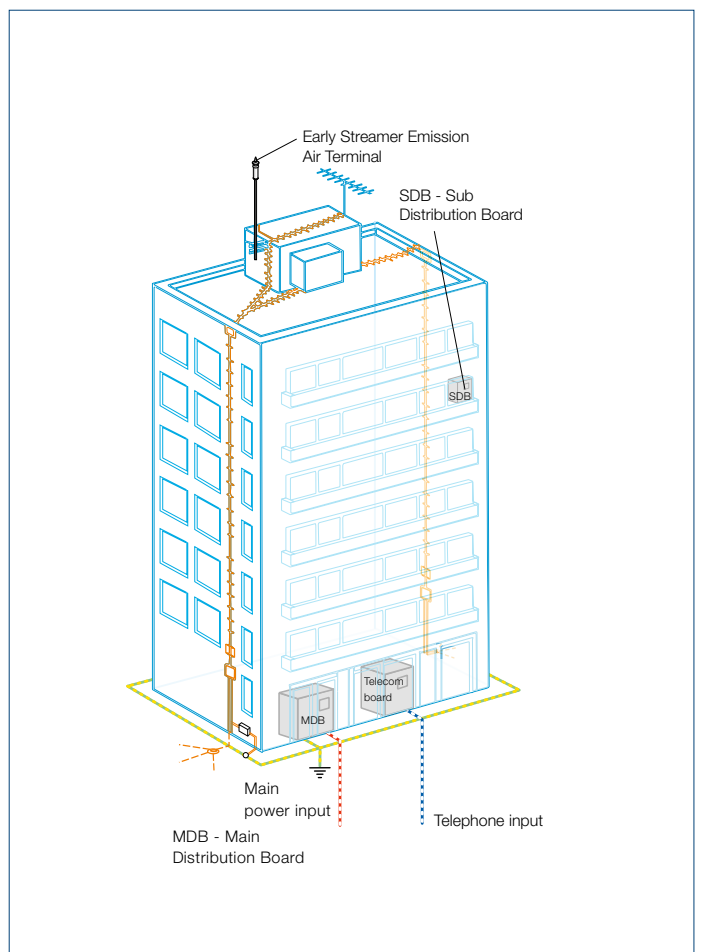

Lightning protection risk analysis

Risk analysis

All lightning protection standards recommend a preliminary lightning risk analysis in three parts:

- lightning risk evaluation
- protection level selection
- protection device definition.

We have developed a software based on the calculations of the IEC 62305-2 or NF C 17-102 (appendix A) in order to give you an easy and accurate solution regarding the risk analysis of any installation you wish to protect.

Protection device definition

It is advisable to take into account the technical and architectural constraints when configuring the different components of the protection device.

To facilitate your preliminary studies, we will provide a questionnaire in which the minimum required information can be entered, and a calculation software package.

Lightning flash density map (flashes per km² per year)

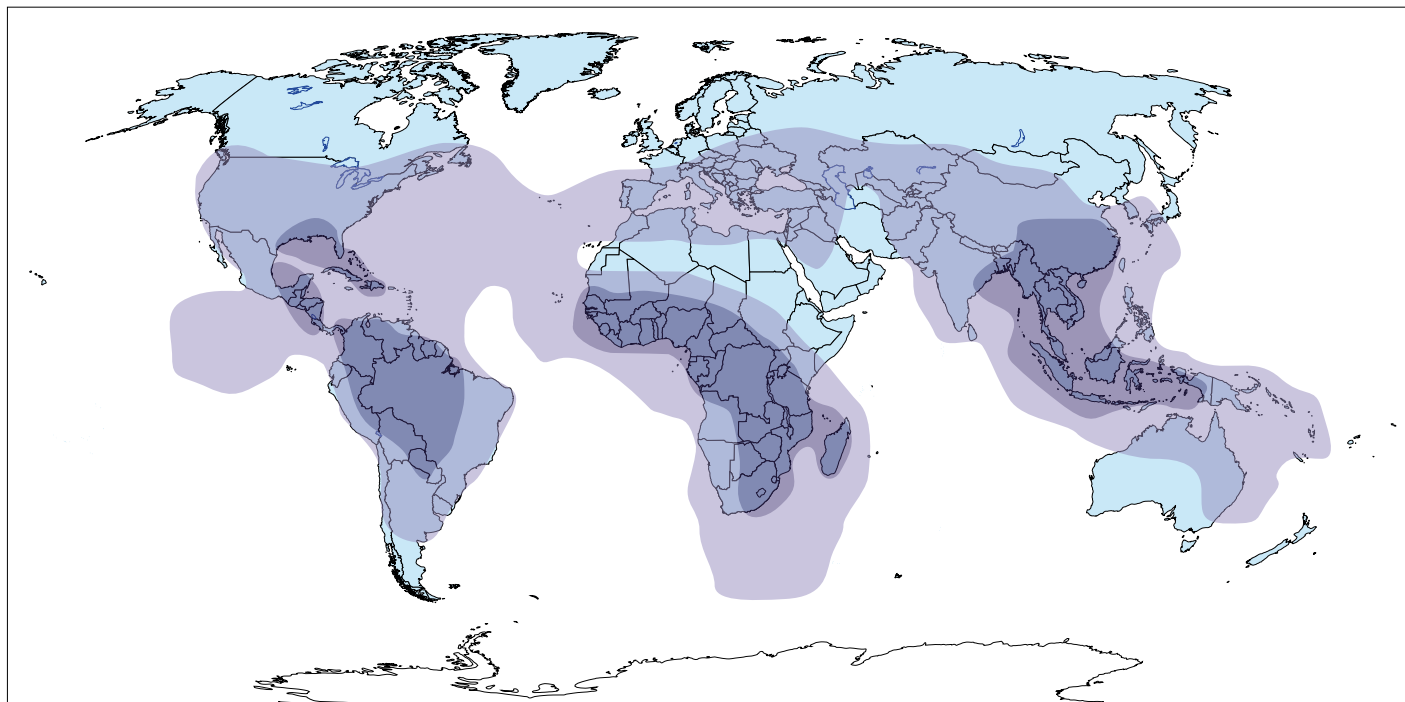

2 < Ng < 8

8 < Ng < 18

Lightning protection technical study OPR Designer software

ABB is happy to provide you with a complete new software in the field of lightning protection.

With a very simple approach you can create your technical study in one click!

You can either draw, import file (AutoCAD, pictures...) and from that point get a complete bill of material (air terminals, down conductors, fixing accessories and earthing system), the positioning of the lightning protection system on the structure.

The solution is given in a complete pdf file that includes :

- protected areas
- lightning air terminals positioning
- complete bill of material
- detailed bill of material per building
- catalogue pages for each component
- test certificates

This software is so far available in English, French, Spanish, Russian and Lithuanian version.

You may download OPR designer at the following address : <http://www.web-emedi.com/opr/>



ABB OPR Designer: The easy way for your surge and lightning protection

ABB is happy to provide you with the new design software for your surge and lightning protection. This software will help you in designing a complete lightning protection system solution for a building, in positioning the right external lightning air terminal including all the accessories and in selecting the right surge protection to protect all your installations.

CREATE YOUR TECHNICAL STUDY IN ONE CLICK !

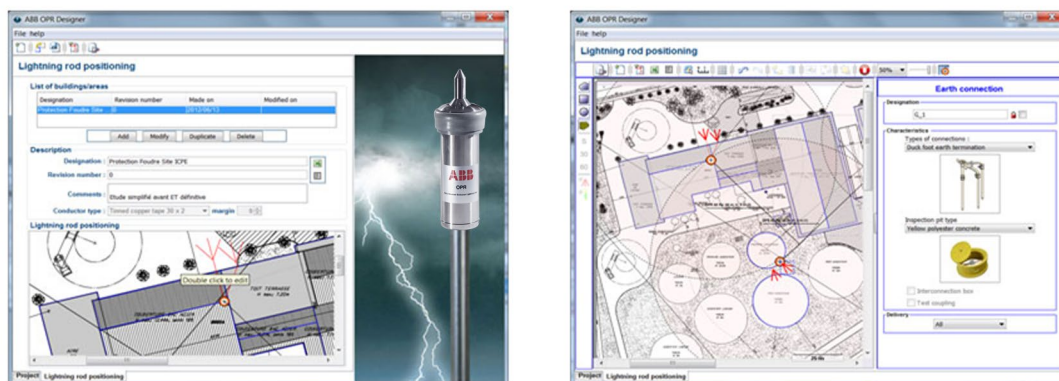

Click on the button to install the application (26Mb)

A shortcut will be added to your desktop to launch the application directly.



Minimal configuration requirements: Windows (XP, Vista, Seven) or Apple (OSX) and Java 1.6

Procedure for measuring the Early Streamer Emission of an ESE air terminal according to standard NF C 17-102 appendix C

This test procedure consists in evaluating the triggering time of an Early Streamer Emission (ESEAT) compared with the reference Single Rod Air Terminal (SRAT) in high voltage laboratory conditions. 50 shocks are applied to the single rod air terminal in the first configuration, then to the early streamer emission air terminal in a second configuration.

Simulation of natural conditions

Natural conditions can be simulated in a laboratory by superimposing a permanent field and an impulse field associated with a plate / ground platform area (H). The tested lightning air terminal is placed on the ground, beneath the centre of this platform. In the experiment, the height $H = 6$ m, and the lightning air terminal height $h = 1.5$ m.

Electrical conditions

The permanent field caused by the charge distribution in the cloud is represented by a negative DC voltage of -20 to -25 kV/m (simulating a negative field of around -20 to -25 kV/m) applied to the upper plate. The impulse field caused by the approach of the download leader is simulated with a negative polarity wave applied to the platform. The rise time of the wave T_m is 650 μ s. The wave gradient, at the significant points is around 10^9 V/m/s.

Geometrical conditions

The volume used for the experiment must be large enough to allow the ascending discharge to develop freely:

- distance d between upper platform and tip ≥ 1 m
- upper plate diameter \geq distance from upper plate to ground.

The lightning air terminal are tested in sequence in strictly identical geometrical conditions same height, same location, same distance between tip and upper platform.

ESE air terminals triggering time calculation

General conditions

- number of shocks: around 50 per configuration (sufficient for an accurate analysis of the leader /Leader transition)
- interval between shocks: the same for each configuration equal to 2 min.

Recording

- triggering time (TB): obtained directly by reading the data from the diagnostic equipment. This data is not characteristic, but it does enable a simple reading to establish whether or not a shock can yield a valid result
- light emitted by the leader at the lightning air terminal tip (photo-multipliers): this data provides a very accurate detection of the leader continuous propagation instant
- pre-discharge current (coaxial shunt): the resulting curves confirm the previous diagnostic data
- space-time development of the discharge (image converter): the image converter pictures provide a further means of analysing the results.

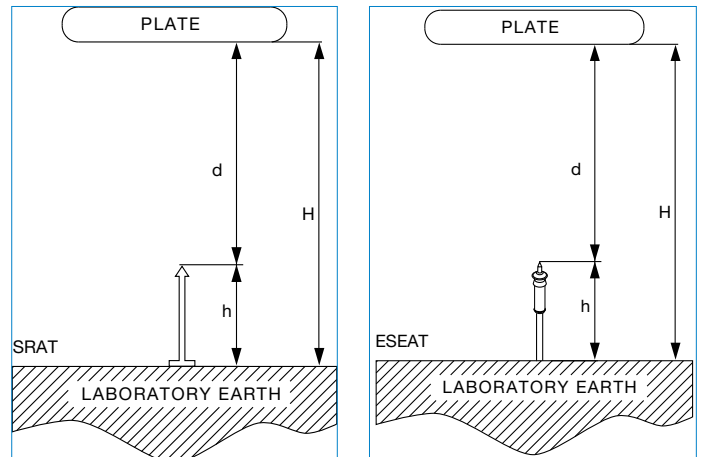

IREQ Laboratory (Canada - 2000)

Other recordings and measurements

- short-circuit current (coaxial shunt)
- time/voltage characteristics for several shocks
- rod to plate distance before and after each configuration
- climatic parameters must be maintain for the 2 configurations :
 - pressure ± 2 %
 - temperature ± 10 %
 - relative humidity ± 20 %.

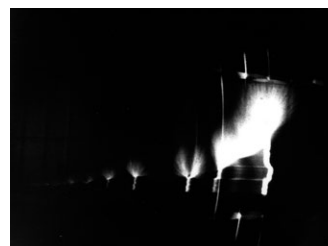

Triggering picture of a SRAT with a rotative high speed camera.



Triggering picture of an ESEAT with a rotative high speed camera.

Procedure for measuring the Early Streamer Emission of an ESE air terminal according to standard NF C 17-102 appendix C

Determination of the early streamer emission of the ESEAT

The triggering time instants, or continuous propagation instants of the upward leader are obtained by analysing the diagnostic data described above. The mean is then calculated for each lightning air terminal tested, and the difference between the mean values is the ESE lightning air terminal triggering time.

$$T = \overline{T_{SRAT}} - \overline{T_{ESEAT}}$$

ABB lightning protection group has unique know-how and experience in this field.

Since 1996, we have generated more than 40 000 sparks using this test procedure in the following high voltage laboratories:

- **SIAME Laboratory** - PAU UNIVERSITY (France)
- Bazet VHV Laboratory - **SEDIVER** (France)
- Volta HV Laboratory - **MERLIN GERIN** (France)
- L.G.E.Les Renardières - **ELECTRICITE DE FRANCE**
- Bagnères de Bigorre HV Laboratory - **LEHTM** (France)
- Varennes **IREQ** Laboratory (Canada)
- Korea Electrotechnology Research Institute - **KERI** (Korea)
- **WHVRI** - Wuhan High Voltage Research Institute (China)
- **Beijing testing center** surge protective devices (China).

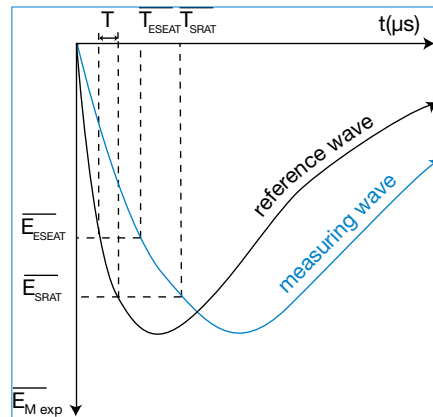

Tests and research

Objectives

ABB Lightning Protection Group has been investing for many years in research into lightning air terminal protection devices, and is constantly striving to enhance the performance of its products.

ABB's ongoing in situ research in France and abroad has three main objectives:

- to enhance the protection models
- to measure in situ the effectiveness of ESEAT, already evaluated in laboratory conditions
- to qualify the dimensioning of the equipment in real-life lightning strike conditions.

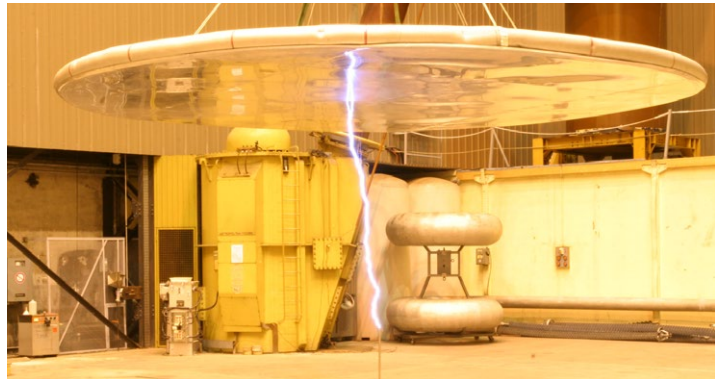

Tests under Laboratory conditions

Since 2003 our factory located in Bagnères de Bigorre (France) has a high tech laboratory allowing to test our Surge Protective Devices in 10/350 μ s and 8/20 μ s wave shapes as well as our direct lightning range with lightning currents up to 100 kA.

We also test our lightning rods in a dedicated high voltage laboratory close to our factory allowing normative tests thanks to an up to 3 MV generator.

Tests in situ

An experimental site devoted to the study of direct lightning impacts to a lightning protection system has been selected at the top of the "Pic du Midi" in the French Pyrenées mountains

for its high lightning impact density (30 days of storm per year).

The "Pic du Midi", famous astronomical observatory, offers an unique scientific environment for lightning observations in collaboration with astronomers.

Purpose of the experiments:

- to confirm the triggering time of ESEAT compared to single rod air terminals
- to direct the flow of the lightning currents captured by the lightning air terminal to low-voltage surge arresters via an appropriate earthing network
- to test the resistance of the equipment to lightning shocks and climatological constraints.

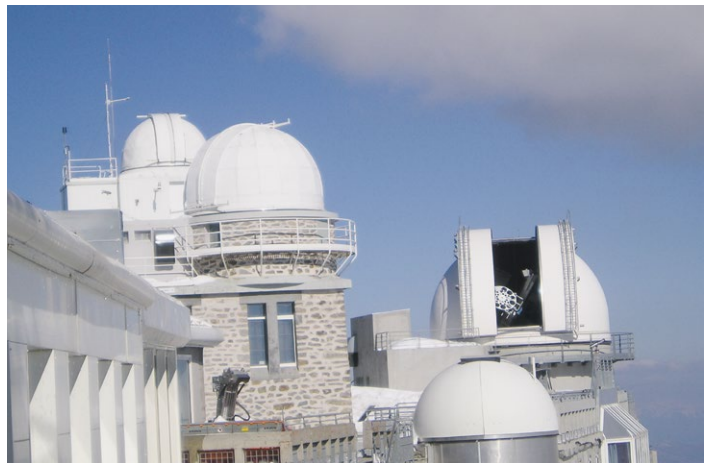

Tests and research

In situ tests at the Pic du Midi de Bigorre

This unique location enables us to test our products in highly severe conditions (high winds, extremely low temperatures) as these tests are running at an altitude of 2880 m.

Such tests give us the opportunity to complete our understanding on lightning phenomenon. For this purpose, we are using high speed cameras, lightning current recorders as well as field and light recorders.

Another in situ test runs at the Taoulet station 2300 m to verify that theoretical values announced are also validated in real conditions.

A constant partnership with scientists permits to follow these in situ sites and lead to fundamental research on lightning. As an application example, a software that determines the weak points of a structure has been developed.

Natural lightning experimental site

- Located in the Hautes Pyrénées department of France
- Keraunic level: 30 days of storms per annum.

Experimental artificial lightning triggering sites

Because lightning is a randomly occurring natural phenomenon, artificial triggering techniques have been developed to speed up the research process.

When lightning conditions are prevalent the triggering technique consists in sending a rocket with a trailing wire in the direction of the storm clouds to cause a lightning strike at the experimental site.

The wire may comprise an insulating section in order to generate the largest possible number of lightning strikes for experimental purposes.

- Site located at Privat d'Allier in Auvergne, France
Keraunic level: 30
Purpose of the experiments:
 - to qualify the lightning strike counters and
 - low-voltage arresters in situ
 - to qualify the resistance of the equipment to
 - triggered lightning strikes.
- Site located at Camp Blanding (Florida/USA)
Keraunic level: 80
Purpose of the experiments:
 - to confirm the triggering time gain of the ESE air terminals compared with single rod air terminals
 - to collect data with a view to improving the protection models.



Lightning capture devices

Lightning air terminals

Early Streamer Emission Air Terminals (ESEAT) or Single Rod Air Terminals (SRAT).

As a general rule, the lightning air terminal should culminate at least two metres above the highest points of the building(s) to be protected.

Its location should therefore be determined relative to building superstructures: chimneys, machine and equipment rooms, flagpoles, pylons or aerials. Ideally, these vulnerable points should be selected for lightning air terminal installation.

The lightning air terminal may be raised by an extension mast.

Our stainless steel interlocking extension masts can reach an overall height of 8.50 or 11 m including the lightning air terminal height. They have been specially designed to obviate the need for guying. However, if guying is essential (e.g. when the conductor is fixed with a flat support on the roof waterproofing, or is exposed to particularly strong winds), the guys should be made of \varnothing 5.6 fibre glass. When metal cables are used for guying, the lower anchoring points should be interconnected with the down conductor by a conductive material of the same type. We offer a range of fixtures adapted to most requirements.

Installation specifications are detailed in the individual product data sheets.

If several lightning air terminals (ESEAT or SRAT) are used in the outside installation on the same structure, they should be connected by a conductor, except when this has to pass an obstacle of more than 40 cm in height.

$D \leq 40$ cm: connect ESEATs

$D \geq 40$ cm: do not connect air terminals

When protecting open-air sites such as sports grounds, golf courses, swimming pools, and camping sites, ESEATs are installed on special supports such as lighting masts, pylons, or any other nearby structures from which the conductor can cover the area to be protected.

Our software OPR Designer is able to design a complete lightning protection system with all installations details, listing of material, protections areas layout, tests certificates within a complete technical document that is available for the client in pdf format.

Interconnection rule when several ESEAT on the same roof

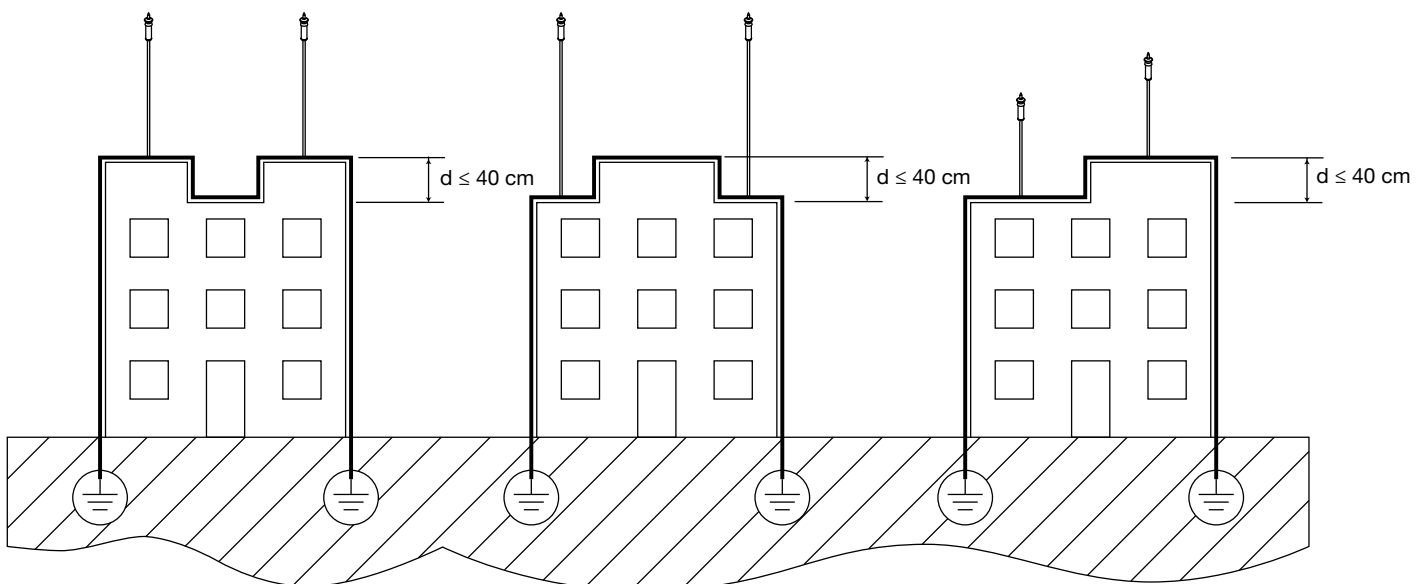

Lightning capture devices

Special cases

Antennas

By agreement with the user of the antenna, the device can be mounted on the antenna mast, provided that allowance is made for a number of factors notably:

- the lightning air terminal tip must culminate at least 2 m above the antenna
- the aerial coaxial cable is routed inside the antenna mast
- the common supporting mast will no need guying
- the connection to the down conductor will be made using a clamp fixed to the foot of the mast.

This process, widely used today, offers three advantages:

- technical (it earths the aerial itself)
- visual (there is only one mast)
- cost.

To be noted that an ESEAT electronic generator cannot be used in an atmosphere where the temperature is greater than 120°.

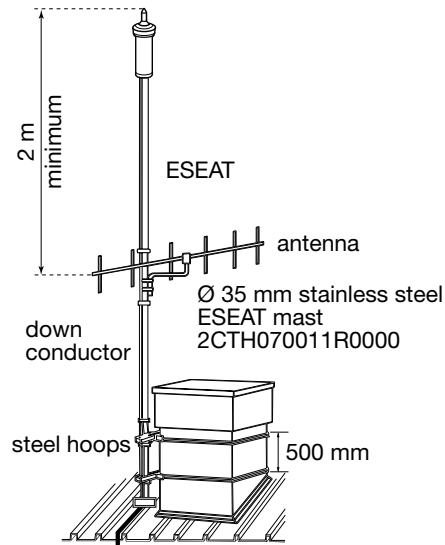

Industrial chimney

ESE air terminal:

- the lightning air terminal should be mounted on an offset mast (2CTH0HRI3501) as far as possible from smoke and corrosive vapours
- the mast should be fixed to 2 points as shown in the diagram.

To be noted that an ESEAT electronic generator cannot be used in an atmosphere where the temperature is greater than 120°.

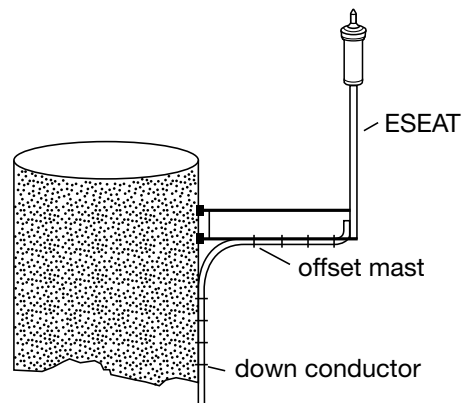

Single rod air terminal:

The lightning air terminals (1 or 2 m) should be mounted on stainless steel supports (2CTH0HPS2630) to enable mounting at a 30° angle. They will be interconnected by a belt conductor positioned 50 cm from the summit of the chimney.

When using 1 m air terminal at least two points should be used and placed at intervals of no more than 2 m around the perimeter.

When using strike points of at least 2 m in height, the number of points should be calculated to cover the protection radius.

Steeple

The lightning air terminal have been designed to carry roof ornaments (rooster, weathervane, cardinal points, etc.).

The down conductor is then fixed below the ornaments.

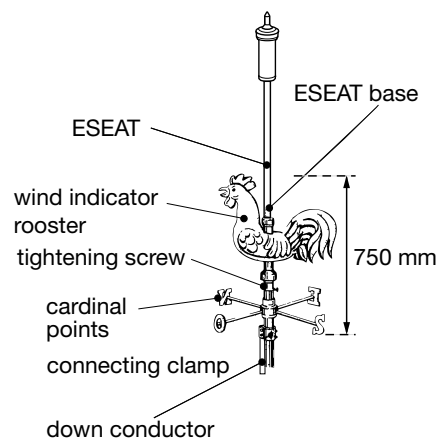

Down conductors

Overview

Down conductors should preferably be made with tin-plated red copper strips, 30 mm wide and 2 mm thick.

Lightning is a high frequency current that flows along the periphery of the conductors. For a like cross-section, a flat conductor has a greater periphery.

An exception to the above rule is buildings with aluminium cladding on which a copper down conductor might generate an electrolytic coupling phenomenon.

Here a 30 x 3 mm aluminium strip should be used or bimetal connection.

In some cases where it is impossible to fix the copper strip, a round \varnothing 8 mm tin-plated copper conductor. In the case where there is a need of mechanical movement of the down conductor use a 30 x 3 mm flexible tin-plated copper braid.

Path

The path should be planned to take account of the location of the earth termination. The path should be as straight and short as possible avoiding any sharp bends or upturns. Curvature radii should be no less than 20 cm. To divert the down conductor laterally, 30 x 2 mm tin-plated red copper preformed bends should be used.

The down conductor path should be chosen to avoid intersection and to be routed along electrical ducts. Shielding the electrical ducts 1 m on each side can be done when it is impossible to avoid crossing them. However when crossovers cannot be avoided, the conduit should be protected inside metal sheeting extending by 1 m on either side of the crossover. This metal sheeting should be connected to the down conductor.

However, in exceptional cases where an outside down conductor cannot be installed, the conductor may run down through a service duct, provided that this is used for no other purpose (and subject to agreement with the safety services and inspection organizations).

When a building is fitted with a metallic external cladding or stone facing or in glass, or in the case of a fixed covering part of the facade, the down conductor can be installed on the concrete facade or on the main structure, under the cladding. In this case, the conductive parts of the cladding must be connected to the down conductor at the top and at the bottom.

The down conductor, if not a copper one, shall be located at more than 10 cm behind inflammable material of the outside cladding if its cross section area is lower than 100 mm². For cross section area of 100 mm² or greater, there is no need to keep a distance between the down conductor and the flammable material.

A specific calculation of the temperature increase may be performed to validate a different rule.

The same requirements apply also to all inflammable material even on the roof (e.g. thatched roof).

Down-conductor bend shapes

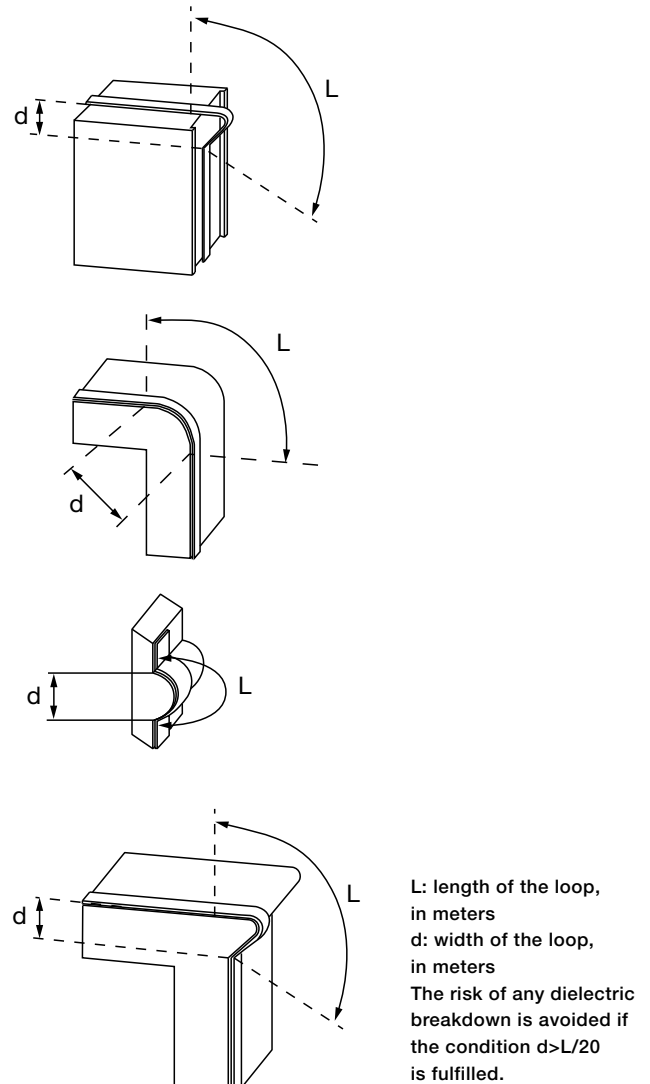

Indoor routing

When a down conductor cannot be installed outside the structure, it can be fitted inside on a part or on the full height of the structure. In this case, the down conductor must be placed inside a dedicated non flammable and insulating duct. The separation distance shall be calculated also for indoor down conductors in order to be able to determine the necessary insulation level of the dedicated duct.

The building operator has to be aware of the resulting difficulties to check and maintain the down conductors, and of the resulting risks of over voltages inside the building.

Access of people to the specific cable channel should be avoided in stormy periods or measures of protection as per outdoor down conductors should be fulfilled (see Annex D NF C 17-102 Vers September 2011) including equipotential bondings of floors with the down conductor.

Down conductors

Parapet walls

When the face of the parapet wall is less than or equal to 40 cm, an upward section in the down conductor is allowed with a maximum slope of no more than 45°. For parapet walls with an upward section of more than 40 cm, space should be allowed or a hole drilled to accommodate a 50 mm minimum diameter sheath and thereby avoid bypassing. If this is not possible, supports of the same height as the parapet wall should be installed to avoid an upturn.

Connection

The lightning air terminal is connected to the down conductor by a connecting clamp that must be tightly secured on to the mast. The strip will be secured along the extension masts by stainless steel clamps. The conductors can be connected together by coupling strips.

Fasteners

Whatever the supporting medium the down conductor must be secured by at least 3 fasteners per linear meter. Insulators are used to distance the conductors and prevent contact with easily flammable material (thatch or wood, for example). The fastener must be appropriate for the structure material and installed so as not to impair watertightness and allow the conductor thermal extension.

Test joint

Each down conductor must be fitted with a test joint or connection link to enable measurement of the resistance of the lightning earth system alone and the electrical continuity of the down conductor.

The test coupling is usually placed about 2 m above ground level to make it accessible for inspection purposes only. To be compliant with standards, the test joint should be identified by the words "lightning air terminal" and the "earth" symbol. On metal pylons, framework or cladding, the test joint should be placed on the ground in inspection earth pit about 1 m from the foot of the metal wall to avoid distorting the resistance measurement of the earth connection by inevitably measuring the electrical resistance on the other metallic networks in the building.

Protecting flat

Between the test joint and the ground, the strip is protected by a 2 m galvanized or stainless steel sheet metal flat fixed by 3 clamps supplied with the flat.

The protecting flat can be bent to follow the profile of the building.

Warning Notice: Protection measures against step and touch voltages

In certain conditions, the vicinity of the down-conductors of an ESE System, outside the structure, may be hazardous to life

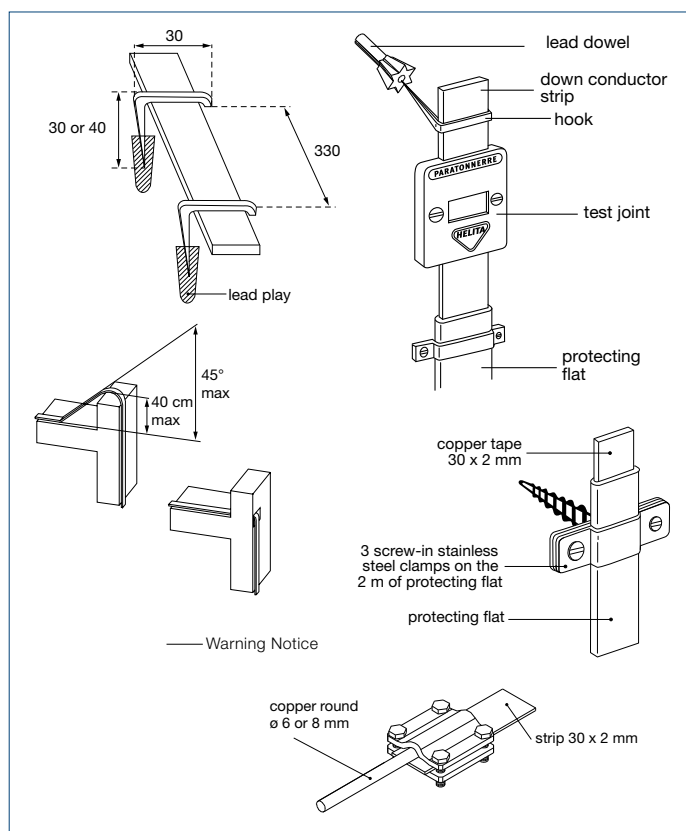

even if the ESE System has been designed and constructed according to the above-mentioned requirements.

The hazard is reduced to a tolerable level if one of the following conditions is fulfilled:

The probability of persons approaching, or the duration of their presence outside the structure and close to the down-conductors, is very low. The natural down-conductor system consists of typically more than ten columns of the extensive metal framework of the structure or of several pillars of interconnected steel of the structure, with the electrical continuity assured;

The contact resistance of the surface layer of the soil, within 3 m of the down-conductor, is not less than 100 kΩ.

NOTE: A layer of insulating material, e.g. asphalt, of 5 cm thickness (or a layer of gravel 15 cm thick) generally reduces the hazard to a tolerable level. If none of these conditions is fulfilled, protection measures shall be adopted against injury to living beings due to touch voltages as follows:

- insulation of the exposed down-conductor is provided giving a 100 kV, 1.2/50 μs impulse withstand voltage, e.g. at least 3 mm cross-linked polyethylene
- physical restrictions and/or warning notices to minimize the probability of down-conductors being touched. We propose in our catalogue Warning Notice (2CTH0PSH2009) to prevent touch voltage.

Down conductors

Lightning stroke counter

When the regulations require the installation of a lightning stroke counter, or to know when to make a complete verification of the installation after a lightning stroke. One per ESEAT or SRAT should be fitted. Regarding mesh cage installation one every 4 down conductor should be installed. The test joint around 2 m above the ground. The counter is connected in serial on the down conductor.

Lightning stroke counter and recorder is used to store date and time of the impact as well as lightning current values.



Meshed conductors

On roof

Is carried on the roof meshes with conductors of which the width depends on the level of protection and those ones must not be greater than 20 m as follows:

It is primarily a closed polygon whose perimeter is adjacent the periphery of the roof, this polygon is then complete by transverse conductors to satisfy the condition on the maximum width of the meshes. If there is a ridge, the conductor must follow it.

Air terminals are placed vertically at the highest and most vulnerable points on the buildings (roof ridges, salient points, edges, corners, etc.).

They are arranged at regular intervals around the periphery of the roof as follows:

- the distance between two 30 cm air terminals should not exceed 15 m
- the distance between two 50 cm air terminals should not exceed 20 m
- strike air terminals not located on the outer polygon are connected to the polygon as follows:
 - either by a conductor excluding any upturn if the air terminals is less than 5 m from the polygon
 - or by two conductors in opposite directions forming a transversal section if the air terminals is located more than 5 m from the polygon.

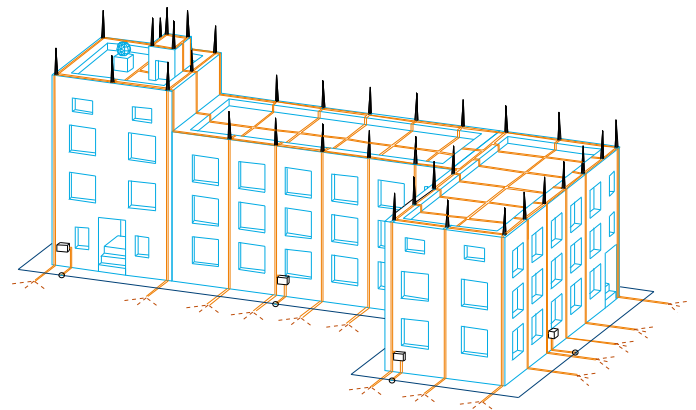

On wall

The down conductors are placed on the corners and salient features of the building in a layout that should be as symmetrical and regular as possible.

The average distance between two adjacent down conductors depends on the required protection level.

Protection level (IEC 62305-2)	Distance between 2 down conductors (IEC 62305-3)	Roof mesh size (IEC 62305-3)
I	10 m	5 x 5
II	10 m	10 x 10
III	15 m	15 x 15
IV	20 m	20 x 20

Equipotential bonding

Overview

When lightning current flows through a conductor, differences in potential appear between the conductor and nearby metallic networks (steel framework, pipes, etc.) inside or outside the building. Dangerous sparks may be produced between the two ends of the resulting open loop.

There are two ways to avoid this problem:

- Establish an interconnection providing an equipotential bond between the conductor and the metallic networks
- Allow a separation distance between the conductor and the metallic networks.

The separation distance is the distance beyond which no dangerous sparks can be produced between the down conductor carrying the lightning current and nearby metallic networks.

Because it is often difficult to guarantee that the lightning protection system is sufficiently isolated during installation or will remain so in the event of structural changes, on-site work, etc., equipotential bonding is often preferred.

There are, however, some cases in which equipotential bonding is not used (e.g. when there are flammable or explosive piping networks). In this case, the down conductors are routed beyond the separation distance "s".

Separation distance calculation

$$S \text{ (m)} = \frac{k_i \cdot k_c \cdot L}{k_m}$$

where:

"kc" is a coefficient determined by the number of down conductors per ESEAT:

kc = 1 for one down conductor, kc = 0.75 for two down conductors, kc = 0.6 for three conductors, kc = 0.41 for four or more conductors.

"ki" is determined by the required protection level:

ki = 0.08 for protection level 1 (high protection), for very exposed or strategic buildings

ki = 0.06 for protection level 2 (reinforced protection, exposed building)

ki = 0.04 for protection level 3 & 4 (standard protection)

"km" is related to the material situated between the two loop ends:

km : 1 for air

km = 0.5 for a solid material other than metal

"L" is the length between the point at which proximity is measured and the point at which the metallic network is earthed or the nearest equipotential bonding point.

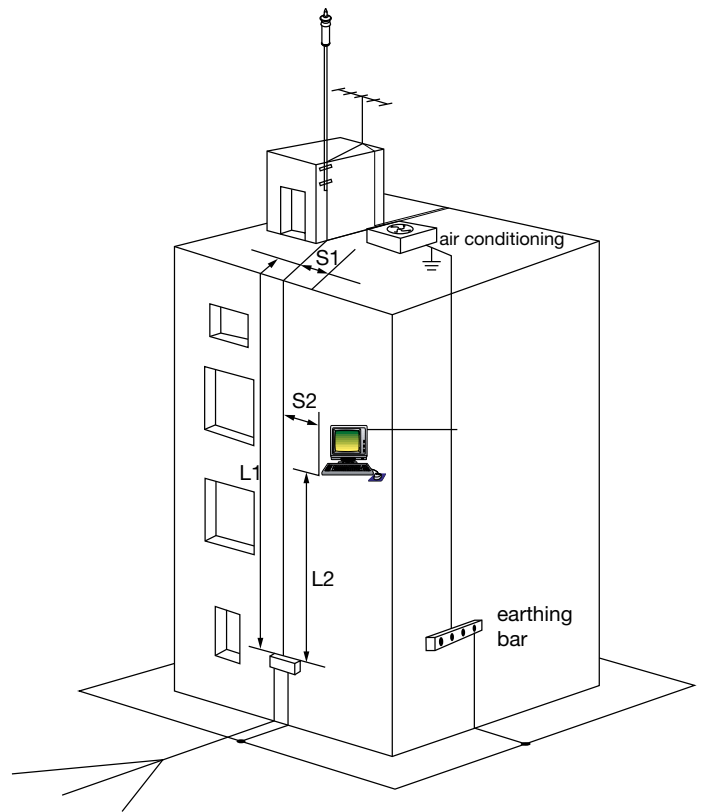

Example

An ESEAT with two down conductors protects a 20 m high building with protection level I.

- Question 1** : Should an air conditioning extractor located on the roof be interconnected if 3 m away from the down conductor? Length L1 = 25 m.

$$\text{Answer 1 : } S1 = 0.08 \times 0.75 \times 25 / 1 = 1.5 \text{ m}$$

Since the distance (3 m) between the conductor and the air-conditioning system is greater than the separation distance (1.5 meters), there is no need to interconnect this extractor.

- Question 2** : Should the computer located in the building 3 m away from the down conductor be interconnected with the conductor, where L2 = 10 m?

$$\text{Answer 2 : } S2 = 0.08 \times 0.75 \times 10 / 0.5 = 1.2 \text{ m}$$

Since the distance between the computer and the down conductor (3 m) is greater than the separation distance (1.2 m), there is no need to interconnect this computer. A tool is available that can be used to quickly calculate the separation distances.

Equipotential bonding

Equipotential bonding of external metallic networks

The equipotential bonding of external metallic networks is an integral part of the outdoor lightning protection installation just like the down conductors and their earths.

All conductive metallic networks located at a distance of less than s (separation distance) from a conductor should be connected to the conductor by a conductive material with a like cross-section.

The aerial masts and small posts supporting electrical power lines should be connected to the conductor via a mast arrester. Earthing systems embedded in walls should be connected to the conductor if terminal connections have been provided.

Equipotential bonding of internal metallic networks

The equipotential bonding of internal metallic networks is an integral part of the indoor lightning protection installation.

All conductive metallic networks in the structure (steel frameworks, ducts, sheathing, electrical raceways or telecommunication cable trays, etc.) should be connected to the conductor. This is done by using a conductive material with a cross-section of at least 6 mm^2 for copper or 16 mm^2 for steel to connect to equipotential bonding bars installed inside the structure and connected in turn to the closest point of the earthing circuit.

Unscreened telecommunication or electrical conductors should be bonded to the lightning protection system via surge arresters.

Equipotential bonding of earths

This is done by using a conductive material with a cross-section of at least 16 mm^2 for copper or 50 mm^2 for steel to connect bonding bar to earth termination system.

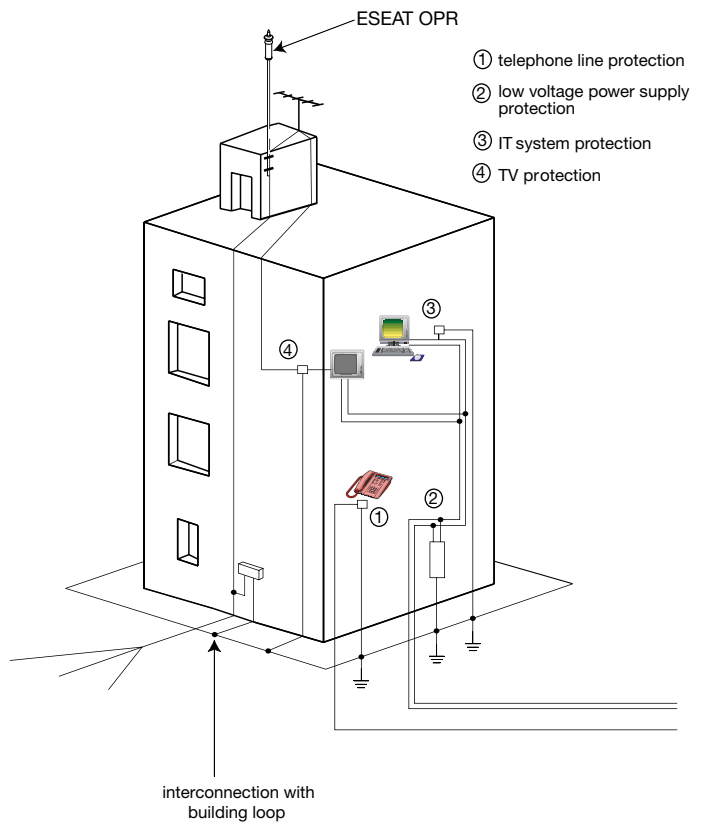

Earth termination systems

Overview

Each down conductor in a lightning protection system must be connected to an earth termination system which fulfils four conditions:

– The earth termination resistance value

International standards stipulate an earth termination resistance value of less than 10 ohms.

This value should be measured on the earth connection isolated from any other conductive component.

If the resistance value of 10 ohms cannot be achieved, the earth termination is nonetheless considered compliant if it is made up of at least 160 m (protection level 1) or 100 m (protection level 2, 3 & 4) of conductors or electrodes, each section measuring no more than 20 m.

– Current carrying capacity

This is an often overlooked but essential aspect of lightning conduction. To minimise the earthing system impedance value, a parallel configuration of three electrodes is strongly recommended instead of just one excessively long electrode.

– Equipotential bonding

Standards require the equipotential bonding of lightning earth termination systems with the existing earthing systems. This must be done using 16 mm² (copper) or 50 mm² (steel) minimum cross section conductor.

– Distance from buried utilities

Earth termination should be at least 2 m (if soil resistivity is over 500 ohms/m 5 m) distant from any buried metal pipe or electrical conduit, not connected to the main equipotential bonding of the structure.

Inspection earth pit

The connection parts of an earth termination system (duck's foot connector, earth rod, test joint) can be accessed in an inspection earth pit.

Lightning air terminals

Ducks foot connector

The minimum earth termination system is made up of 25 m of 30 x 2 mm tin-plated copper strip, split into 3 strands buried in 3 trenches at a depth of 60 to 80 cm dug in a fan shape like a duck's foot: one end of the longest strand is connected to the test joint, the two other strands being linked to a special connection known as a duck foot's connector.

Earth rods

When the site topography does not lend itself to the installation of a duck's foot as described above, an earth termination system can be developed using at least 3 copper earth rods each with a minimum length of 2 m, buried vertically in the ground; the rods should be spaced at intervals of about 2 m and at a mandatory distance of 1 m to 1.5 m from the foundations.

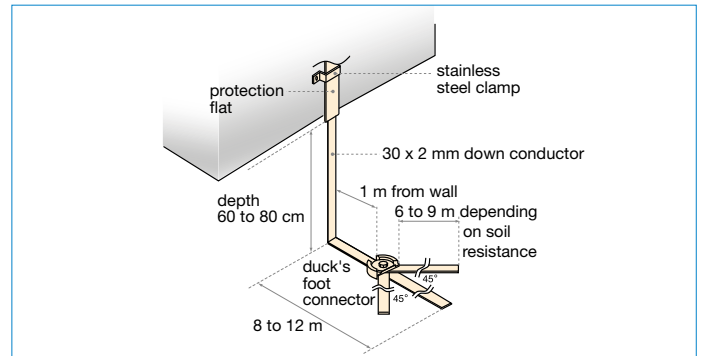

Duck's foot earth termination system

It is recommended to cover the earth termination system with a red or orange warning plastic mesh.

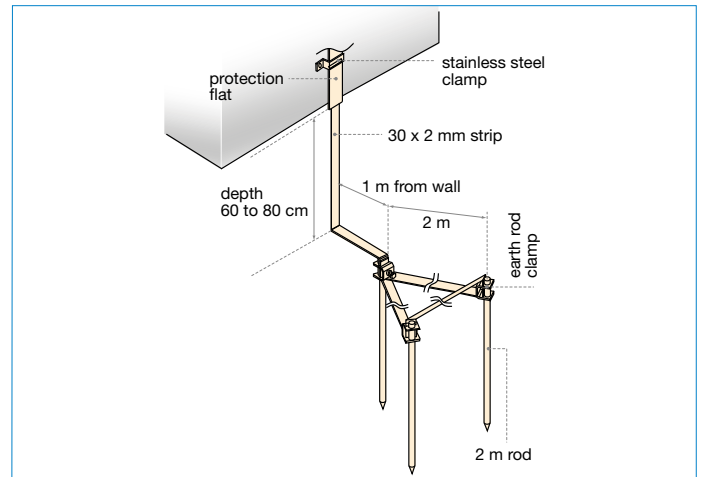

Rod triangle earth termination system

It is recommended to cover the earth termination system with a red or orange warning plastic mesh.

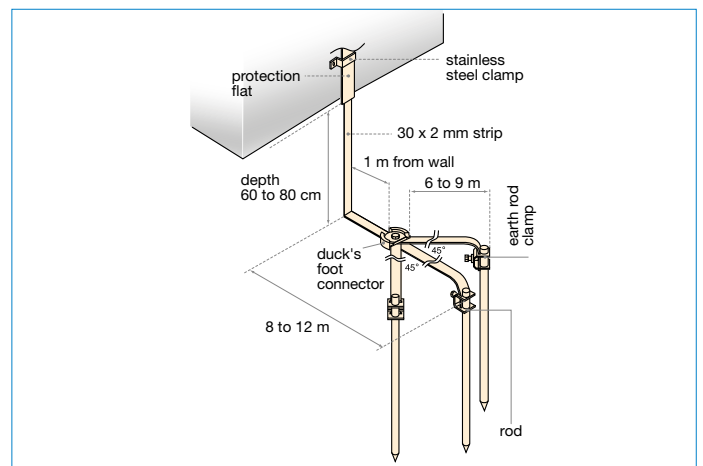

Duck's foot earth termination system with earth rods

It is recommended to cover the earth termination system with a red or orange warning plastic mesh.

Earth termination systems

Combined

If the soil type is not altogether suitable for a duck's foot connector, a combination of duck's foot and earth rods will significantly enhance protection (better earth resistance). In this case, the end of each duck foot connector strand is connected to an earth rod.

Meshed conductors

Duck's foot connector

The earth connection is made up of 3 conductors each 3 m minimum in length, buried horizontally at a depth of 60 to 80 cm. One of the strips is connected to one end of the test joint; the other two splay out at an angle of 45° on either side of this central strand and are coupled to it with a special connector known as a duck's foot connector. The resistance value must be less than 10 ohms. If the resistance value of 10 ohms cannot be achieved, the earth termination is nonetheless considered compliant if it is made up of at least 160 m of electrode in level 1, 100 m in level 2 and 10 m in level 3 & 4.

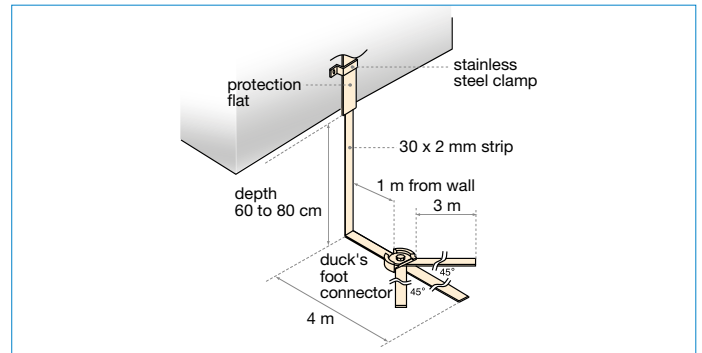

Duck's foot system for a meshed cage

It is recommended to cover the earth termination system with a red or orange warning plastic mesh.

Earth rods

The earth connection is made up of 2 spiked vertical rods at least 2 m in length, connected to each other and to the down conductor, and at least 2 m from each other. The rods should be 1 m to 1.5 m from the foundations. The earth termination systems in a building should be connected together with a conductor with the same cross-section and of the same type as the down conductors. Where there is an existing entrenched earth protection loop in the foundations for the building's 2 m flat electrical installations, there is no need to create a new loop: the earth terminations can simply 0.6 m be interconnected by a tin-plated 30 x 2 mm copper strip. The resistance value must be less than 10 ohms. If the resistance value of 10 ohms cannot be achieved, the earth termination is nonetheless considered compliant if it is made up of at least 160 m (80 m if vertical rods) of electrode in level 1, 100 m (50 m if vertical rods) in level 2 and 10 m (5 m if vertical rods) in level 3 & 4.

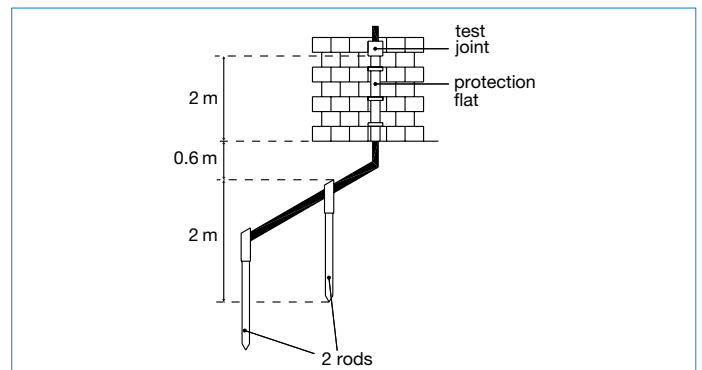

Earthing system equipotential bonding

When the protected building or area has an existing earth termination system for the electrical installations, the lightning earth termination systems should be connected to it.

This interconnection should be made to the earthing circuit at the closest point to the down conductor.

When this is impossible in an existing building, the interconnection should be made to the earth plate. In this case, the interconnecting conductor should be constructed such that no currents are induced in nearby equipment cables.

In all cases, the interconnection should include a device that can be disconnected to enable measurements of the resistance of the lightning earth termination system.

This device can be made up of either an interconnection box for equipotential bonding fixed to the main wall of the building, or an equipotential bonding bar located in an inspection earth pit.

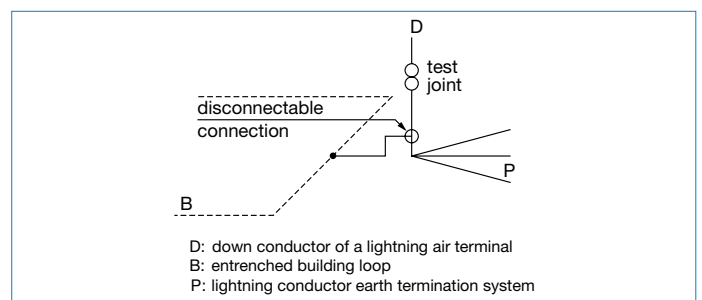

Inspection ESEAT maintenance

The current standards NF C 17-102 September 2011 edition recommends regular, periodical inspections of the lightning protection system.

The following schedules are recommended:

Protection level	Visual inspection (year)	Complete inspection (year)	Critical system complete inspection (year)
I and II	1	2	1
III and IV	2	4	1

Note: Critical systems shall be defined by laws or end users.

A lightning protection system should also be inspected whenever the protection structure is modified, repaired or when the structure has been struck by lightning.

Lightning strikes can be recorded by a lightning strike counter installed on one of the down conductors.

ESEAT maintenance kit, a unique solution

With its experience of ESEAT development and special testing processes, ABB offers a simple and complete solution: a telescopic 8 m pole supplied with a portable test case to enable simple in situ inspections.

The device can be used without dismantling the ESEAT.

The following aspects of an ESE System installation should be inspected (see NF C 17-102 September 2011 edition paragraph 8)

A visual inspection should be performed to make sure that:

- no damage related to lightning has been noted
- integrity of ESE System has not been modified
- no extension or modification of the protected structure needs the installation of additional lightning protection measures
- the electrical continuity of visible conductors is correct
- all component fasteners and mechanical protectors are in good condition
- no parts have been weakened by corrosion
- the separation distance is respected and there are enough equipotential bondings and their condition is correct
- SPD end of life indicator is correct
- maintenance operations results are checked and recorded

Complete verification includes visual verification and the following measurements to check:

- the electrical continuity of hidden conductors
- the earth termination system resistance values (any variation with regards to initial values > 50 % should be analysed)
- properly working of ESEAT according to manufacturer procedure.

NOTE: High frequency earth system measurement is feasible during installation or in maintenance operation in order to check the coherence between the needs and the installed earth system.

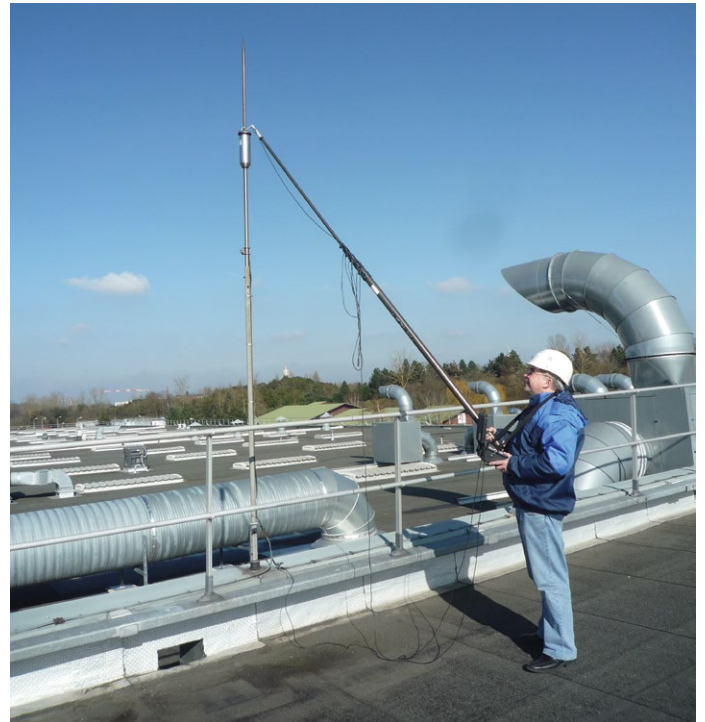

The findings of each scheduled inspection should be recorded in a detailed report stating the required corrective measures. Any faults identified in a scheduled inspection should be corrected as soon as possible in order to maintain optimal lightning protection.

Initial verification should be performed once the ESE system installation is completed in order to make sure that it complies with the NF C 17-102 standard requirements.

Lightning air terminal range

ESEAT typical installation on masonry building

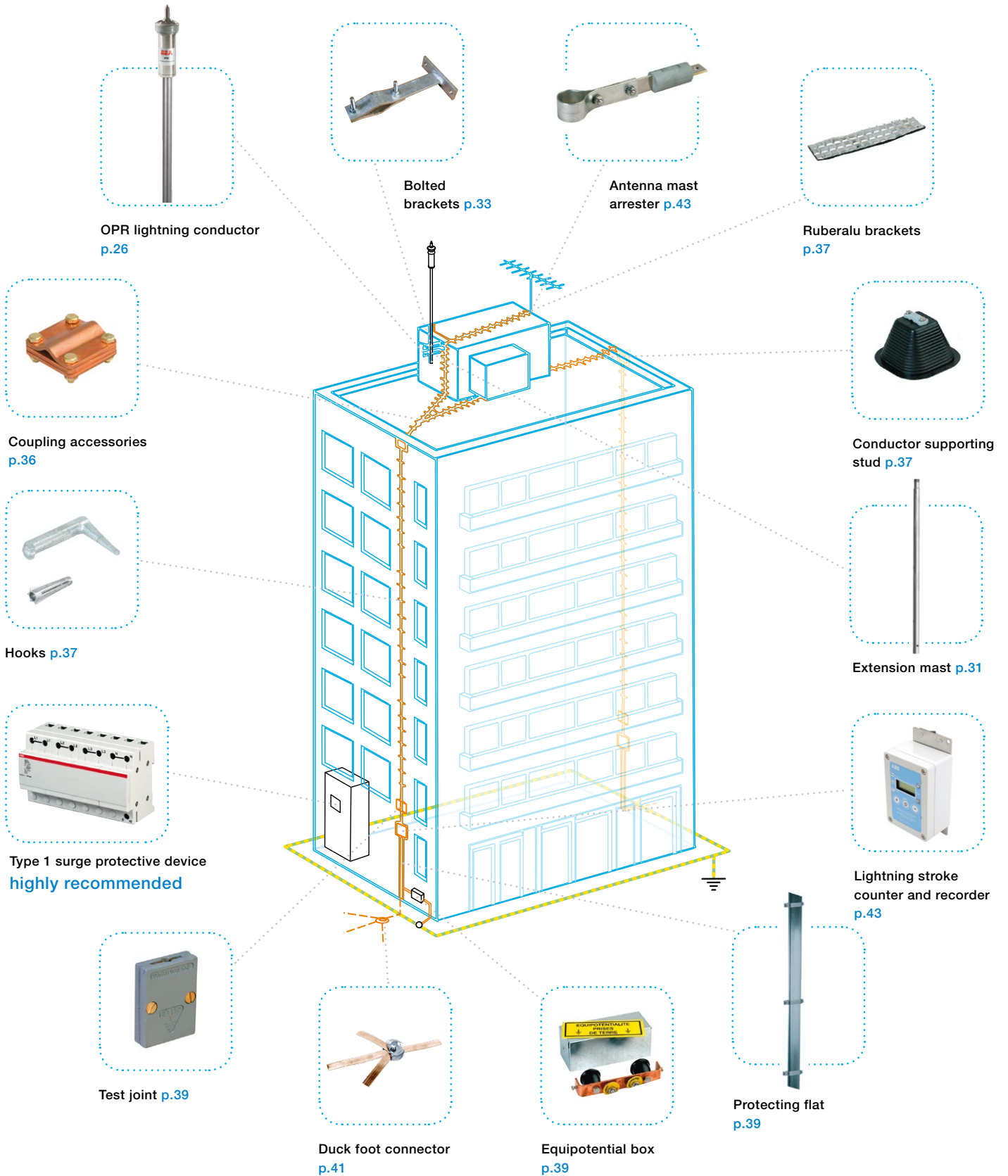

Lightning air terminal range ESEAT typical installation on metal cladding

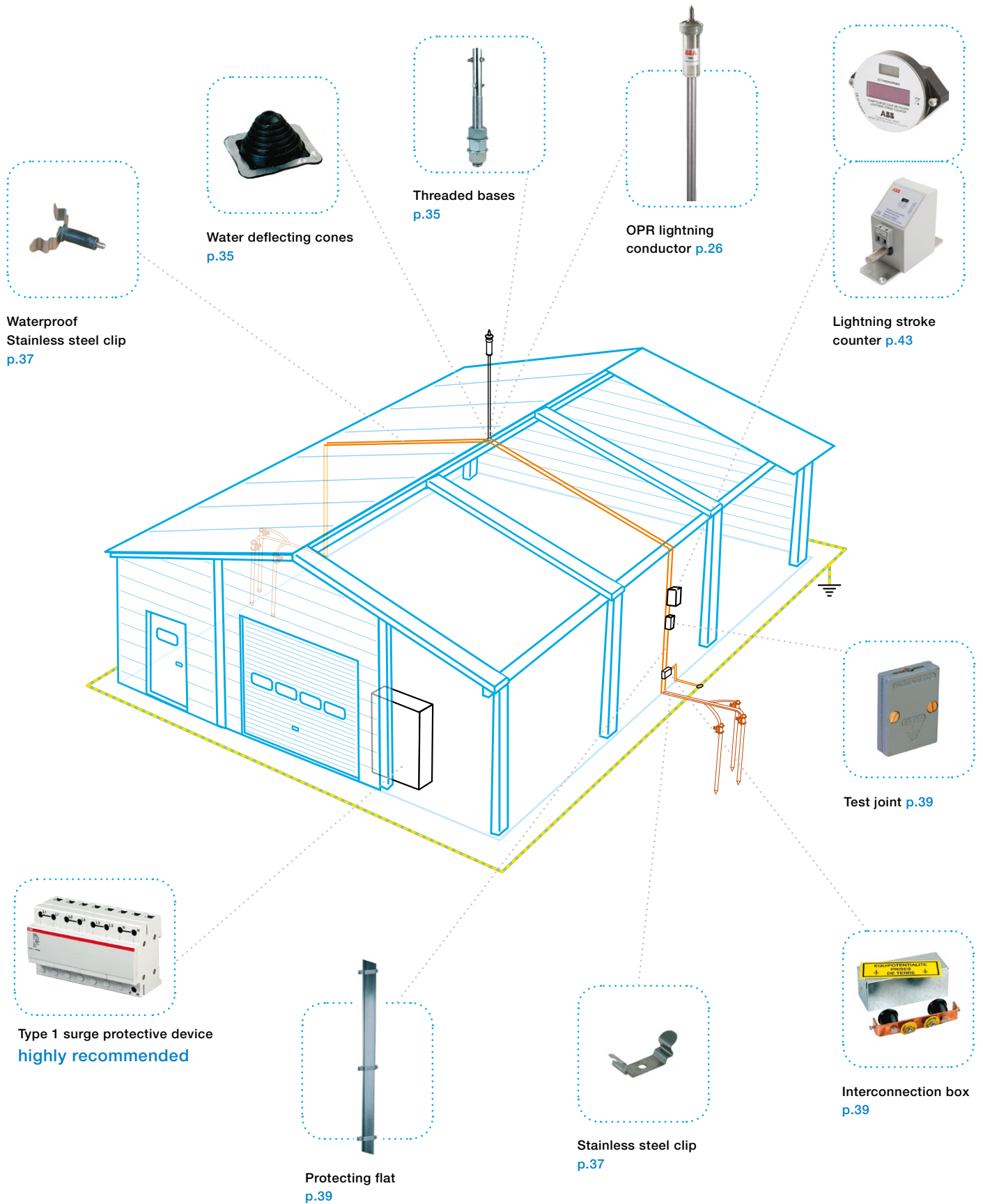

Lightning air terminal range - Early Streamer Emission OPR, the high pulse voltage, initiation advance lightning air terminal

ABB continues to innovate, and has developed a new generation of lightning devices. The new OPR range with increased initiation advance performances, represents further progress in terms of protection, operating autonomy and ease of maintenance. These advancements reinforce ABB's position as International leader in direct lightning protection with over 200 000 installations throughout the world.

ABB manufacturing quality

The enviable reputation of the OPR has been earned through maintaining a consistently high quality in manufacture. Before leaving the factory, each OPR has been tested for installation breakdown at high voltage, and subjected to a current test that ensures its performance when conducting lightning discharges. The high voltage output pulses at the OPR are also examined to verify correct amplitude and frequency. The OPR is built to withstand the arduous conditions encountered in service, and its ongoing performance can be monitored simply and quickly using the OPR test set.

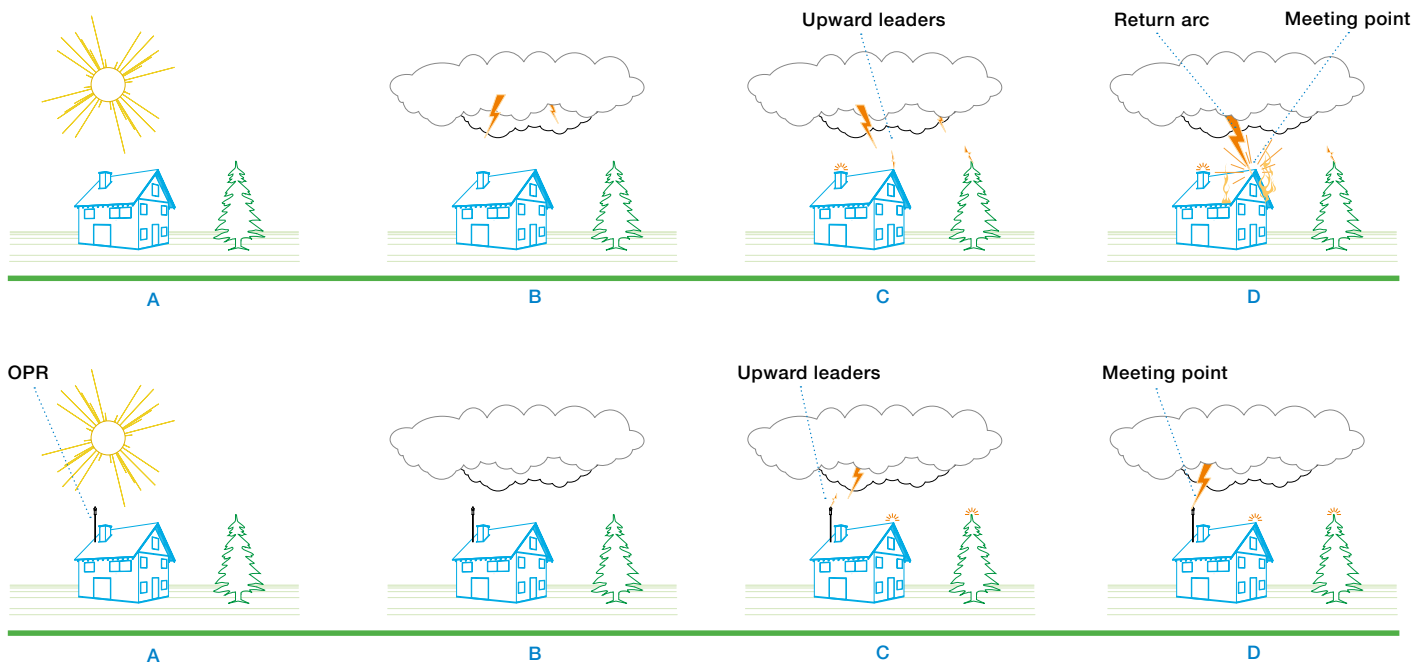

The advantage of initiation advance

The unique efficiency of the OPR lightning air terminal is based on a specific initiation advance, well before the natural formation of an upward leader, the OPR generates a leader that rapidly propagates to capture the lightning and direct it to earth. Validated in the laboratory, this gain in time relative to the simple rod provides additional essential protection.

Complete autonomy

During a storm the ambient electric field may rise to between 10 to 20 kV/m. As soon as the field exceeds a threshold representing the minimum risk of a lightning strike, the OPR lightning terminal is activated. It draws its energy from the ambient electric field the energy required to generate high voltage pulses, creating and propagating an upward leader. No other power sources are required, and no radioactive components are used.

Lightning air terminal range

Early Streamer Emission Air Terminal - ESEAT

RodCheck system: visual strike indicator

The aim of the RodCheck system is to give visual information on the intensity of the lightning current caught by the OPR even from a long distance.

We need to keep in mind that the lightning rod is a security device that permits to limit risk and therefore contributes to the safety of the people. Indeed a lightning impact may lead to explosion, to fire and consequently be a risk for the people within the structure.

As for any security device, it is important to figure out directly its degree of aging, which is linked to the lightning strike current to which it has been subjected.

On many sites lightning rods are usually equipped with counters that detect the flow of current without necessarily giving information about its intensity.

Only a digital counter could give such characteristics, but it would undoubtedly increase the price of the overall installation.

On the other hand, the new edition of the NF C 17-102 also states that from January 2009 it has been compulsory to have two down conductors per ESEAT. Therefore, as the counters are usually placed only on one of the two down conductors, they don't record the entire value of the current.

The RodCheck system has been developed so as to solve this specific security issue and it provides an estimate of the intensity of the lightning strike at first glance.

Thanks to the new RodCheck technology, the OPR considerably reinforces and improves the security of sites and people and provides the right answer to a perfectly justified question: "Has the lightning rod been deeply hit and is it necessary to check the installation?"

This visual indicator is made of a UV resistant EPDM shell, mounted directly on the OPR external spark gap.

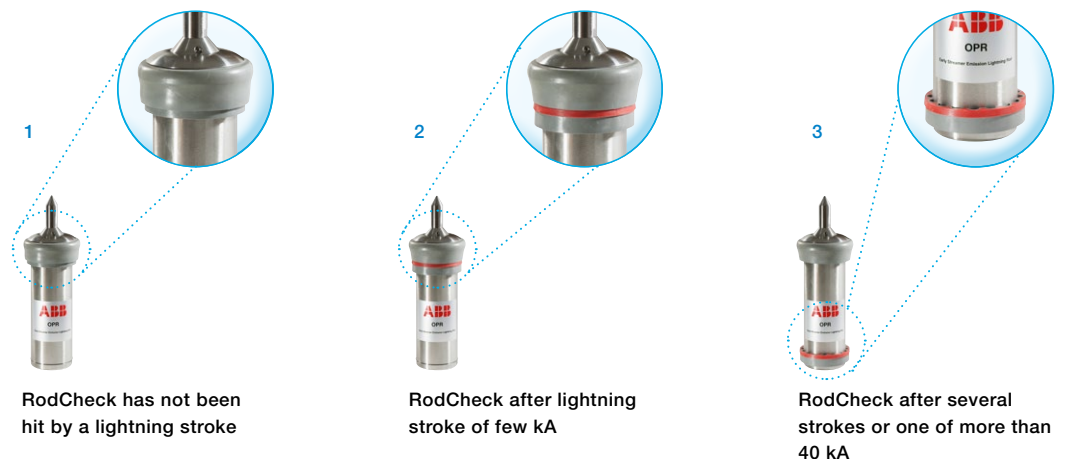

In the examples **2** and **3** we recommend performing a test of the OPR's electronics and afterwards the red ring may be put back in the initial position (example **1**).

As long as there is no indication of strike it is not necessary to test the generator. But on the other hand, we strongly recommend a complete check of the lightning rod OPR, including the check of its internal electronic system in case of a lightning impact. An 8 m high pole connected to a test case is needed to carry out the test of the generator.

Lightning air terminal range

Early Streamer Emission Air Terminal - ESEAT

Typical applications

Industrial sites, buildings, warehouses, where a large protection area is needed.

Ordering details

OPR

ΔT	Description	Type	Order code	Ean code	Pkg (pcs)	Weight (1 pce) kg
30	OPR 30	IMH3000	2CTB899800R7000	3660308514172	1	2.400
45	OPR 45	IMH4500	2CTB899800R7500	3660308514706	1	2.400
60	OPR 60	IMH6000	2CTB899800R7100	3660308514189	1	2.400

Mast to be ordered separately.
Maximum operating temperature: 120 °C.



Calculating protected areas

The radius of protection R_p of an OPR is given by French standard NF C 17-102 (September 2011 edition).

It depends on the ESEAT efficiency ΔT of the OPR measured in the high voltage laboratory, on the levels of protection I, II, III or IV calculated according to the lightning risk assessment guides or standards (NF C 17-102 annex A or IEC 62305-2, guides UTE C 17-100-2 or UTE C 17-108) and on the height h of the lightning air terminal over the area to be protected (minimum height = 2 m).

The protection radius is calculated according to Annex C in French standard NF C 17-102. For OPR 60, limiting the value of ΔT used in the protection radius calculations to 60 μs (limited 60 μs in accordance with the paragraph 5.2.2 of the NF C 17-102 standard).

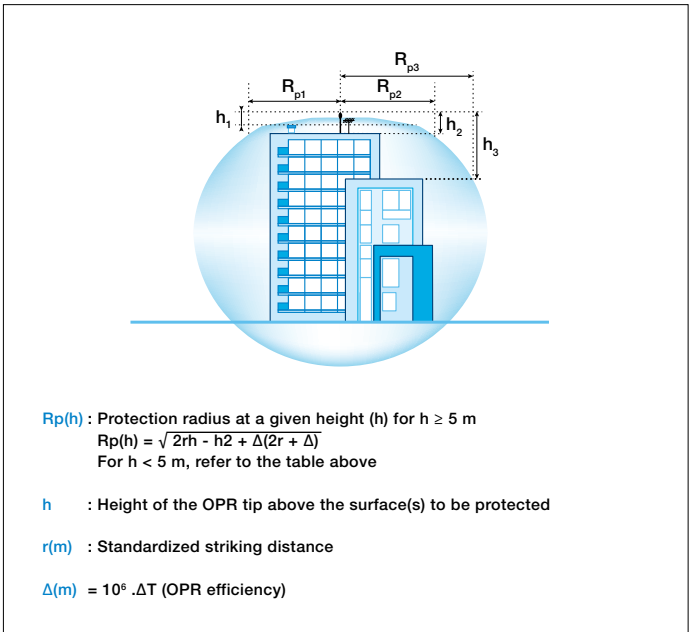

	LPL I	LPL II	LPL III	LPL IV
Rolling sphere radius $r(m)$	20	30	45	60

OPR radius of protection

Level of protection	I ($r = 20$ m)			II ($r = 30$ m)			III ($r = 45$ m)			IV ($r = 60$ m)		
	OPR 30	OPR 45	OPR 60	OPR 30	OPR 45	OPR 60	OPR 30	OPR 45	OPR 60	OPR 30	OPR 45	OPR 60
h (m)	Radius of protection R_p (m)											
2	19	25	31	22	28	35	25	32	39	28	36	43
3	29	38	47	33	42	52	38	48	58	43	57	64
4	38	51	63	44	57	69	51	65	78	57	72	85
5	48	63	79	55	71	86	63	81	97	71	89	107
6	48	63	79	55	71	87	64	81	97	72	90	107
8	49	64	79	56	72	87	65	82	98	73	91	108
10	49	64	79	57	72	88	66	83	99	75	92	109
15	50	65	80	58	73	89	69	85	101	78	95	111
20	50	65	80	59	74	89	71	86	102	81	97	113
45	43	65	76	58	75	89	75	90	105	89	104	119
50	40	65	74	57	75	88	75	90	105	89	104	120
55	36	65	72	55	75	86	74	90	105	90	105	120
60	30	65	69	52	75	85	73	90	104	90	105	120

Note: the optimized radius of protection is reached when placing the ESE lightning conductor at 5 m above the highest point of the structure to protect. A minimum of 2 m is a must.

Lightning air terminal range

Single Rod Air Terminal - SRAT

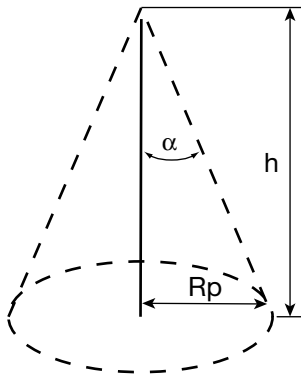

Typical applications

Small structure, pylons, chimney.

Description

The rods are made of a tapered solid stainless steel tip ($L = 0.20$ m), a stainless steel mast of 1 or 2 m length, to be ordered separately. In accordance with standard IEC 62305-3 (paragraph 5.2.2), the protection radii are as follows:

Radius of protection R_p (m)

H m	Level of protection H			
	I	II	III	IV
2	5	6	9	11
4	8	10	12	15
6	10	12	15	20
8	10	13	17	21
10	10	14	17	22
20	10	15	21	29

H: height of conductor tip above protected surface(s).

R_p : radius of protection in horizontal plane located at a vertical distance h from the conductor tip.

Ordering details

Length m	Description	Type	Order code	EAN code	Weight (1 pce) kg
0.20	Stainless steel tip (A) and connection clamp (D)	PTS3000	2CTH010004R0000	3660308521828	2.500
1.00	1 m stainless steel air termination mast (B)	HPI3001	2CTH010001R0000	3660308521316	2.000
2.00	2 m stainless steel air termination mast (C)	HPI3002	2CTH010002R0000	3660308521323	3.500

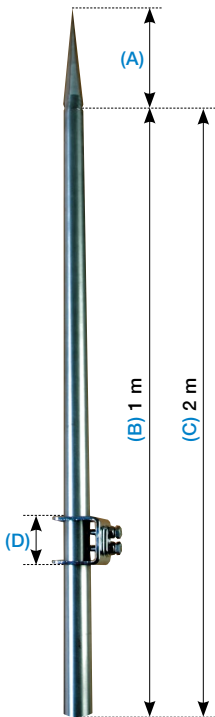

Protection of individual houses

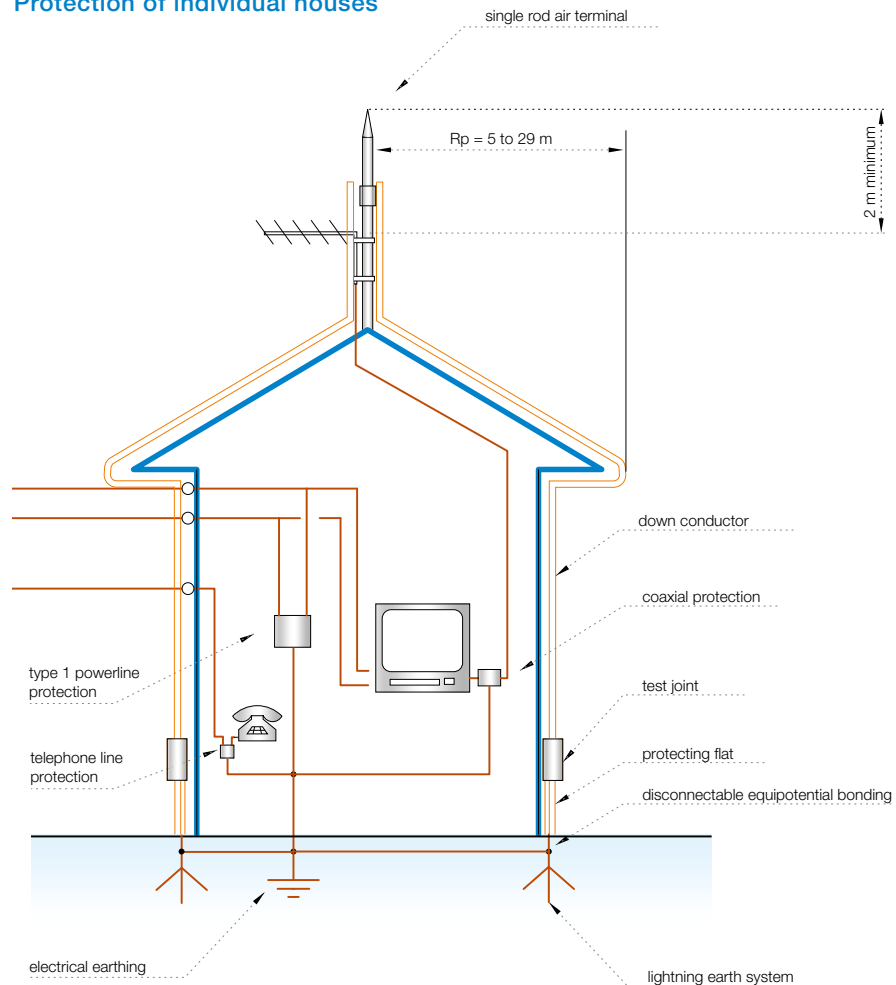

Lightning air terminal range Extension masts

Installation

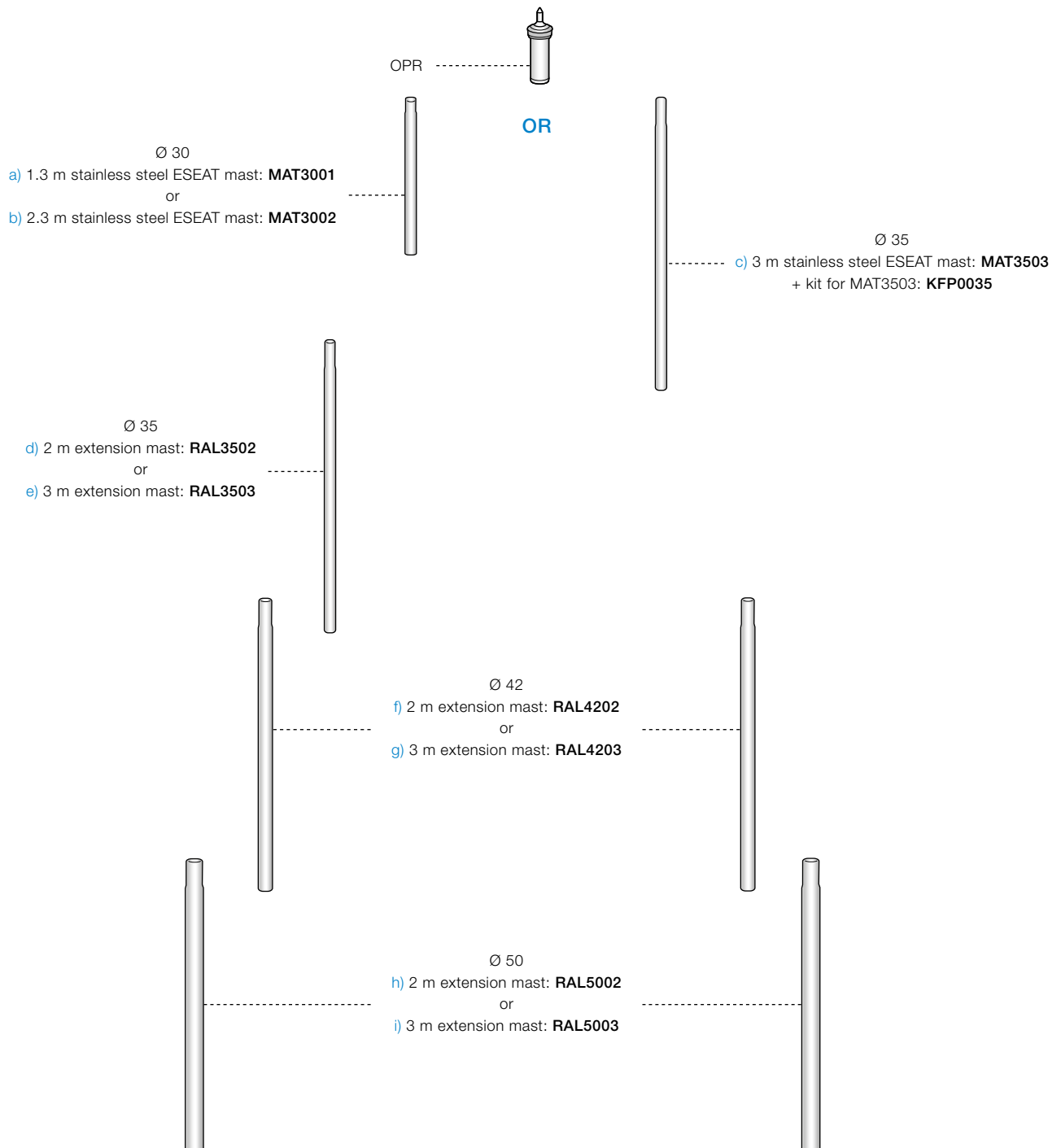

Important: All these extension masts need to be ordered with their screw and fixing kits (see next page)

Lightning air terminal range

Masts and extension masts

Masts

Masts

Height m	Description	Type	Order code	Ean code	Pkg (pcs)	Weight (1 pce) kg
1.3	Stainless steel ESEAT mast Ø 30	MAT3001	2CTH070001R0000	3660308521651	1	1.900
2.3	Stainless steel ESEAT mast Ø 30	MAT3002	2CTH070002R0000	3660308521668	1	3.000
3.0	Stainless steel ESEAT mast Ø 35	MAT3503	2CTH070011R0000	3660308521750	1	5.200

To be noted that the MAT3503 needs to be ordered with its screw and fixing kit KFP0035 made of a connecting clamp especially designed for Ø 35 mm mast.

Kit for MAT3503

Description	Type	Order code	Ean code	Pkg (pcs)	Weight (1 pce) kg
Screw and fixing	KFP0035	2CTH050027R0000	3660308521781	1	-

Extension masts

Description

All the extension masts have to be ordered with their screw kits.

Ordering details

Description	Type	Order code	EAN code	Pkg (pcs)	Weight (1 pce) kg
Extension masts					
2 m stainless steel mast Ø 35	RAL3502	2CTH070005R0000	3660308521699	1	5.200
3 m stainless steel mast Ø 35	RAL3503	2CTH070006R0000	3660308521705	1	6.400
2 m stainless steel mast Ø 42	RAL4202	2CTH070007R0000	3660308521712	1	6.400
3 m stainless steel mast Ø 42	RAL4203	2CTH070008R0000	3660308521729	1	9.600
2 m stainless steel mast Ø 50	RAL5002	2CTH070009R0000	3660308521736	1	7.500
3 m stainless steel mast Ø 50	RAL5003	2CTH070010R0000	3660308521743	1	11.000

Screw and fixing kit

Screw and fixing kit for stainless steel mast Ø 35 and 42 (1)	KFR3542	2CTH050026R0000	3660308521774	1	-
Screw and fixing kit for stainless steel mast Ø 50 (2)	KFR0050	2CTH050028R0000	3660308521798	1	-

(1) 5 collars, 4 nuts and bolts.

(2) 6 collars, 2 nuts and bolts.

Selection guide

Mast configuration without guying kit for a wind.

Nominal height m	ESEAT mast type	Extension mast type
Below 140 km/h and more than 6 km away from the sea		
4.5 (b + d)	b) MAT3002	d) RAL3502
5.2 (c + d)	c) MAT3503	d) RAL3502
6.2 (c + e)	c) MAT3503	e) RAL3503
7.2 (c + d + f)	c) MAT3503	d) RAL3502 + f) RAL4202
Up to 170 km/h or close to sea side		
4.5 (b + d)	b) MAT3502	d) RAL3502
5.2 (c + d)	c) MAT3503	d) RAL3502
6.5 (b + d + f)	b) MAT3002	d) RAL3502 + f) RAL4202
7.2 (c + d + f)	c) MAT3502	d) RAL3502 + f) RAL4202



Lightning air terminal range Pylons



Self carrying pylons

- material: hot galvanized steel
- these pylons are made of a welded steel lattice with a triangular cross-section. Each element is 3 m in length, except the ground anchoring section (about 1 m)
- delivered complete with stainless steel hardware and Ø 35 mm mast head (to receive OPR mast)
- the concrete anchorage blocks should be made with concrete in a proportion of 350 kg/m³ and calculated for a good ground.

Height (1) m	Self-supporting			
	Zone I 136 km/h	Zone II 149 km/h	Zone III 167 km/h	Zone IV 183 km/h
9	2CTHCHPA0109	2CTHCHPA0209	2CTHCHPA0309	2CTHCHPA0409
12	2CTHCHPA0112	2CTHCHPA0212	2CTHCHPA0312	2CTHCHPA0412
15	2CTHCHPA0115	2CTHCHPA0215	2CTHCHPA0315	2CTHCHPA0415
18	2CTHCHPA0118	2CTHCHPA0218	2CTHCHPA0318	2CTHCHPA0418

(1) Other sizes on request - Technical specifications available - For wind zone V (210 km/h) please consult us.



Guyed pylons

- material: hot galvanized steel
- these pylons are made of a welded steel lattice with a triangular cross-section (centerline distance 175 mm) supplied in lengths of 3 or 6 m
- use: lightning air terminal supports for flat roofs
- fibre glass guying (1 set per section)
- delivered complete with base and neoprene tile, Ø 35 mm mast head, fibre glass and accessories (anchoring clips and stay tighteners) for guying, with bolted anchoring.

Height (2) m	Guyed
	Zones I and II
9	2CTHCHPH0900
12	2CTHCHPH1200
15	2CTHCHPH1500
18	2CTHCHPH1800

(2) Other sizes on request - Technical specifications available - For wind zone V (210 km/h) please consult us.

Guying kit for lightning rod with mast

Complete kit with:

- 25 m of fibre glass cable **to be ordered separately**, 6 anchoring clips, 3 stay tighteners, 3 ring fasteners, 1 3-directional clamp and 1 base (2CTHCHPP4523).

Description	Type	Order code	EAN code	Weight (1 pce) kg
Guying kit	FHF0001	2CTH050022R0000	3660308521613	12.000
25 m fibre glass cable 5.6 mm	FDV5625	2CTH050023Z0000	3660308521620	-

OBSTA obstruction lights

The OBSTA HISTI is an obstruction light for hazard to low-flying aircraft for airport, building, broadcast transmitting towers, chimneys, bridges and transmission lines.

This lamp based on cold neon discharge principle offers high reliability, robustness in hostile environments (EMC, climatic...), proven long life (more than 25 000 hours) on all kinds of obstacle like transmission lines, TV towers and exposure in electromagnetic fields and high temperature.

One unique model will adjust itself to the main supply voltages, continuously from 100 V to 240 Vrms, 50/60 Hz.

Description	Type	Order code	EAN code	Weight (1 pce)
OBSTA HI STI 100 V A 240 V	HCO0071	2CTHCHCO0071	-	5
OBSTA photoelectric cell 230 V	HCO0752	2CTHCHCO0752	-	0.4

For another voltage, please contact us.

OBSTA low intensity LED

The NAVILITE is based on LED technology in compliance with ICAO low intensity type recently applied. These lights are devoted to the night marking of all kinds of obstacles with a DC power supply.

Description	Type	Order code	EAN code	Weight (1 pce)
OBSTA Navilite LED 48VDC	HCHCO0900	2CTHCHCO0900	-	0.4

For another voltage, please contact us.

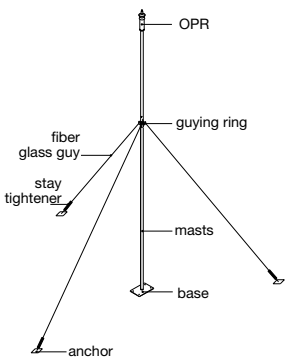

obsta
opsta

1



obsta
opsta

2

Lightning air terminal range

Lateral fixations



Wall fixing accessories

Bolted brackets

- use: bolted fixing for an offset mast on a vertical wall (M 10)
- bolt hole diameter: Ø 11 mm
- distance between bolt holes: 120 mm.

Offset mm	Description	Type	Order code	EAN code	Pkg (pcs)	Weight (1 pce) kg
290	Long bolted bracket	PBL0290	2CTH050016R0000	3660308521552	1	1.900
125	Short bolted bracket	PBC0125	2CTH050015R0000	3660308521545	1	1.400

Use 3 brackets for installation of 5 m (and 6 m) consisting of a 2 m (or 3 m) lightning rod with additional 3 m mast, with a wind less than 136 km/h if 2 is not sufficient.



Offset bracket

- use: fixing of a mast offset from a vertical section
- offset distance: max. 190 mm.

190	Offset bracket for vertical support	PDV0190	2CTH050018R0000	3660308521576	1	1.800
-----	-------------------------------------	---------	-----------------	---------------	---	-------



Pylons, ladders, guardrail or fences fixing accessories

Offset clamps

- use: fixing of a mast offset from a vertical wall or a horizontal section by means of Ø 10 mm bolts.

Use	Description	Type	Order code	EAN code	Pkg (pcs)	Weight (1 pce) kg
Horizontal support	1 - Clamp for horizontal support	CDH5001	2CTH050013R0000	3660308521521	1	1.700
Vertical support	2 - Clamp for vertical support	CDV5001	2CTH050014R0000	3660308521538	1	1.700

Version in 3 brackets for installation of 5 m (and 6 m) consisting of a 2 m (or 3 m) lightning rod with additional 3 m mast, with a wind less than 136 km/h.

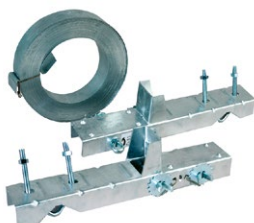

Steel hoops

Masonry chimney (rectangular/square section)

- use: fixing of a mast on a chimney, a concrete mast, etc. (rectangular/square section).

Clamping Ø	Description	Type	Order code	EAN code	Pkg (pcs)	Weight (1 pce) kg
mm						
from 30 to 60	Bracket square section	CCC6001	2CTH050020R0000	3660308521590	1	2.000
–	Coil of steel hoop (25 m)	HFC4002	2CTHCHFC4002	3660308523440	1	5.000



Metal cylindrical chimney

- use: fixing of a mast on a chimney, round section).

250	Bracket cylindrical section	CCT5001	2CTH050021R0000	3660308521606	1	1.140
–	Stainless steel tape 20 x 0.7 (50 m)	HFP2650	2CTHCHFP2650	3660308523471	1	4.000
–	Tightening clips 200 mm	HCP2651	2CTH0HCP2651	3660308524485	5	0.050

Wide offset bracket

- use: bolted fixing of a mast offset from a vertical wall (M 10)
- material: galvanized steel
- offset distance: 45 cm
- distance between bolt holes: 54 cm
- minimum distance between brackets: 50 cm to fix a set of masts for a building with a height of 5 m; 1 m for higher buildings
- delivered complete with hardware and back plate.



Clamping Ø	Description	Type	Order code	EAN code	Pkg (pcs)	Weight (1 pce) kg
mm						
from 30 to 60	Wide offset bracket	HPS0010	2CTH0HPS0010	3660308522658	1	10.500

Lightning air terminal range

Lateral fixations



Industrial chimney offset and bracket

Offset for industrial chimney stacks

Description

- material: stainless steel
- delivered complete with stainless steel connecting clamp for conductor
- to offset a solitary air terminal (without extension mast) by 1 m from a chimney stack
- assembly: lightning air terminal bolts into right hand tube + offset rod fitted to chimney stack by two brackets earth with two Ø 8 mm drill holes.

Ordering details

Offset	Description	Type	Order code	EAN code	Pkg (pcs)	Weight (1 pce) kg
m						
1	Offset for industrial chimney stacks	HRI3501	2CTH0HRI3501	3660308522672	1	5.200



Industrial chimney bracket

Description

- use: to offset a single rod air terminal (1 or 2 m) for a chimney stack
- material: stainless steel
- delivered complete with stainless kit screw kit.

Ordering details

Description	Type	Order code	EAN code	Pkg (pcs)	Weight (1 pce) kg
Stainless steel chimney bracket	HPS2630	2CTH0HPS2630	3660308522665	1	1.300

Lightning air terminal range

Roof fixing accessories



Ballasted tripods

- use: to fit a mast (height 5 m) on flat roof (max. gradient 5 %) without drilling or sticking on the roof
- material: galvanized steel.

Description	Type	Order code	EAN code	Weight (1 pce) kg
Ballasted tripod - Wind up to 149 km/h	TLB5002	2CTHCTLB5002	3660308524430	120.00
Ballasted tripod - Wind up to 170 km/h	TLB5004	2CTHCTLB5004	3660308524447	200.00
Ballasted tripod - Wind up to 186 km/h	TLB5005	2CTHCTLB5005	–	350.00

For wind speed above 186 km/h a guying kit must be used.



Supporting plates / tripods

- use: to fix lightning conductors or elevation masts to flat roofs
- material: galvanized steel
- bolt hole diameters: 12 mm.

Height mm	Dimensions of base	Centerline distance	Description	Type	Order code	EAN code	Weight (1 pce) kg
330	200 x 200	160 x 160	1 - Plate for OPR (30 mm) or extension mast (35 mm)	HPP4523	2CTH0HPP4523	3660308522610	5.500
800	420 face	390 face	2 - Tripod for 30 to 50 mm tube	TSH4525	2CTHCTSH4525	3660308524454	8.500

HOHPP4523: to be used with a guying kit

HCTSH4525: maximum height in wind zone 3 is 3 m.



Carriage bolt holdfasts

- use: to fix a single conductor rod (with no extension mast) in timber frameworks or bedding in masonry
- material: galvanized steel
- delivered complete with hardware.

Effective thread L. mm	Effective L. after fixing m	Hole Ø mm	Description	Type	Order code	EAN code	Weight (1 pce) kg
150	0.10	18	Short sup.	HST2044	2CTH0HST2044	3660308522689	1.250

Maximum height in wind zone 3 is 5 m (without guying kit)

Important: not to omit the use of water deflecting cone to secure watertightness of the installation.



Threaded bases

- use: to fix a conductor to a metal framework. The conductor may be raised by a Ø 35 mm extension mast
- material: galvanized steel
- delivered complete with hardware.

Maximum tightening L. mm	Thread Ø mm	Description	Type	Order code	EAN code	Weight (1 pce) kg
115	30	OPR mast base	HEF2107	2CTH050033R0000	3660308522511	2.200
150	36	Ø 35 mm extension mast base	HEF2313	2CTH050034R0000	3660308522528	4.500

Maximum height in wind zone 3 is 5 m (without guying kit)

Important: not to omit the use of water deflecting cone to secure watertightness of the installation.



Water deflecting cones

- use: to ensure the watertightness in between the roof and the mast when fixing is used under roofing. Cut according to mast diameter (CRE)
- material: rubber (CRE).

Taper opening mm	Height mm	Description	Type	Order code	EAN code	Weight (1 pce) kg
6 to 50	55	Water deflecting cone	CRE2700	2CTHCCRE2700	3660308523211	0.040

Lightning air terminal range

Conductors and coupling accessories



Conductors

Flat conductors (1) (sold per meter)

Material	Section	Type	Order code	EAN code	Pkg (pcs)	Weight (kg/m)
Tin-plated copper	30 x 2 mm (strip)	CPC2712	2CTH040003R0000	3660308523129	1	0.535
Tin-plated copper	30 x 2 mm (25 m spool)	CPC0025	2CTH040001R0000	3660308521866	25	0.535
Tin-plated copper	30 x 2 mm (50 m spool)	CPC0050	2CTH040002R0000	3660308521873	50	0.535
Stainless steel	30 x 2 mm (strip)	CPI2711	2CTHCCPI2711	3660308523150	1	0.474
Galvanized steel	30 x 3.5 mm	CPG3035	2CTHCCPG3035	3660308523143	1	0.870

(1) Other dimensions on request.



Round conductors (2)

Material	Section mm ²	Type	Order code	EAN code	Pkg (pcs)	Weight (kg/m)
Ø 8 tin-plated copper	50 (50 m spool)	CRC8000	2CTH040005R0000	3660308524676	50	0.450
Ø 8 red copper	50 (50 m spool)	CRC8001	2CTH040006R0000	3660308524683	50	0.450

(2) Other dimensions on request.

Shunts

- electrolytically tin-plated flat flexible copper braid with welded eyelet at each end
- other lengths and cross-sections available on request.



Length m	Section mm ²	Type	Order code	EAN code	Pkg (pcs)	Weight (1 pce) (kg)
0.30	50	STP5030	2CTH0STP5030	3660308522870	1	0.160
0.50	50	STP5050	2CTH0STP5050	3660308522887	1	0.270
0.75	50	STP5075	2CTH0STP5075	3660308522894	1	0.400
1.00	50	STP5100	2CTH0STP5100	3660308522900	1	0.600

Coupling accessories

Coupling strips

- use: for coupling or crossing two conductors without riveting
- the "standard" models accommodate 30 mm wide strips and rounds with Ø 6 and 8 mm
- the "multiple" model also enables crossings of round conductors
- the special strip model only accommodates flat strips.



Description	Type	Order code	EAN code	Pkg (pcs)	Weight (1 pce) (kg)
1 - Galvanized steel "standard" coupling	BRP2680	2CTHCBRP2680	3660308523082	1	0.300
2 - Copper "standard" coupling	BRC2780	2CTH0BRC2780	3660308522047	1	0.210
3 - Copper "multiple" coupling	BRX3780	2CTH0BRX3780	3660308522115	1	0.300
4 - Special copper coupling for strip	BRH2779	2CTH0BRH2779	3660308522092	1	0.200
5 - Special stainless steel coupling for strip	BRI2779	2CTH0BRI2779	3660308522108	1	0.204
6 - 3 x 2 and Ø 8 mm line coupling	BRC2781	2CTH0BRC2781	3660308522054	1	0.202



Connector for round conductors

Description	Type	Order code	EAN code	Pkg (pcs)	Weight (1 pce) (kg)
Lug with offset base for 8 mm conductors	PRC8000	2CTHCPRC8000	3660308524300	1	0.050

Lightning air terminal range

Conductor fasteners



Roof fixing accessories

Conductor supporting studs

- material: black synthetic exterior filled with cement (except 2CTHCHPV2771 to be filled up by your means)
- eliminates the need to drill through waterproofing to attach the conductor
- can be glued with neoprene glue
- height: 8 cm.

Use	Description	Type	Order code	EAN code	Pkg (pcs)	Weight (1 pce) kg
Ø 8 mm conductor 30 x 2 mm conductor Cable raceway	1 - Hollow stud	HPV2771	2CTHCHPV2771	3660308524072	1	0.160
Ø 8 mm conductor 30 x 2 mm conductor	2 - Solid stud (clip)	HPB2772	2CTHCHPB2772	3660308523945	1	1.290



Ruberulu brackets for flat roof with waterproofing

- material: bituminised aluminium
- these brackets are attached by hot-melt gluing.

Dimensions	Type	Order code	EAN code	Pkg (pcs)	Weight (1 pce) kg
mm 150 x 40	HBR2717	2CTH0HBR2717	3660308522375	1	0.020

Rolls also available.

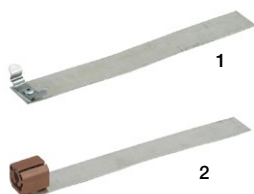

Clipped tile fasteners

- material: tin-plated copper strip saddle 25 x 1 mm
- Stainless steel clips: used for fixing 30 x 2 mm strips to all types of slated or unbedded roofing tiles (1)
- PVC clips: used for round conductors, exists in red copper colour or grey (2).

For flat conductors

1 - Tile fastener with stainless steel clip for flat conductor	HAA2673	2CTH0HAA2673	3660308522238	1	0.043
----------------------------------------------------------------	---------	--------------	---------------	---	-------

For round conductors

2 - Tile fastener with grey PVC clips for round conductor	HAR2745	2CTH0HAR2745	3660308522283	1	0.045
2 - Tile fastener with red copper colour PVC clips for round conductor	HAR2746	2CTH0HAR2746	3660308522290	1	0.045

Wall fixing accessories for flat conductors

Masonry wall hooks

- fixing: on masonry by hookds into lead dowels
- for flat strip.



Material	Description	Type	Order code	EAN code	Pkg (pcs)	Weight (1 pce) kg
Galvanized steel	Hook 30 mm	CMA3020	2CTH050032Z0000	3660308521859	20	0.014
Lead	Dowel	CPB3020	2CTH050030Z0000	3660308521835	20	0.003

Screw fastener

- for 30 mm wide strip: supplied with wood screw
- material: brass.



Description	Type	Order code	EAN code	Pkg (pcs)	Weight (1 pce) kg
Masonry screw fastener	HCL2642	2CTH0HCL2642	3660308522443	1	0.020

Metal cladding walls

Stainless steel clips

- material: stainless steel
- for fixing a flat strip conductor
- fixed with pop rivets or screws (Ø 4 mm) not supplied.

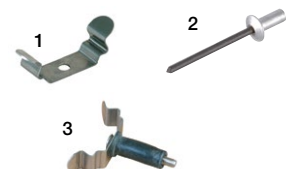

1 - Stainless steel clips for 30 x 2	CIP3020	2CTH050031Z0000	3660308521842	20	0.002
2 - Aluminium waterproof pop rivets Ø 4	HRP0100	2CTH050011Z0000	3660308521507	100	0.003
2 - Aluminium waterproof rivets Ø 4	HRP0500	2CTH050012Z0000	3660308521514	500	0.003
3 - Stainless steel clip for waterproof cladding for 30 x 2	HCB4240	2CTH0HCB4240	3660308522399	1	0.002

Lightning air terminal range

Conductor fasteners



Waterproof fixing on cladding

- fixing: on cladding and roofs of galvanized or thermo-lacquered steel plate (code: 2CTH0FDT0045)
- fixing: on tiles or fibro-cement (code: 2CTH0FDT0046)
- fixed entirely from outside and guaranteeing perfect watertightness. May be equipped with a bakelite insulator
- drill hole Ø 10 mm.

Use	Type	Order code	EAN code	Pkg (pcs)	Weight (1 pce) kg
Metal cladding dowel L. 15 mm	FDT0045	2CTH0FDT0045	3660308522191	1	0.030
Tiles or cement fibre dowel L. 25 mm	FDT0046	2CTH0FDT0046	3660308522207	1	0.040



Insulating supports

- fixing: strip on timber framework or thatch
- material: bakelite
- supplied complete with wood screws
- 2CTH0HIS6000 for flat conductors, 2CTH0HAR... for round conductors.



Insulator height H mm	Colour	Thread Ø mm	Type	Order code	EAN code	Pkg (pcs)	Weight (1 pce) kg
35	black	6	HIS6000	2CTH0HIS6000	3660308522542	1	0.050
–	grey	8	HAR2645	2CTH0HAR2645	–	1	0.050
–	copper	8	HAR2646	2CTH0HAR2646	3660308522276	1	0.050



Wall fixing accessories for round conductors

PVC fixtures

- fixing: on 30 mm wide strip with isolation from supporting material (screw hole spacing 15 mm)
- colour: grey or copper.



Use	Colour	Description	Type	Order code	EAN code	Pkg (pcs)	Weight (1 pce) kg
Masonry	Grey	Grey PVC fixture	HAR2445	2CTHCHAR2445	3660308523341	1	0.007
Masonry	Grey	Grey PVC fixture with screw kit	HAR2845	2CTH0HAR2845	3660308522313	1	0.016
Masonry	Copper	Copper PVC fixture with screw kit	HAR2846	2CTH0HAR2846	3660308522320	1	0.016



Masonry fixture

- for round conductor: supplied with wood screw
- material: copper.

Description	Type	Order code	EAN code	Pkg (pcs)	Weight (1 pce) kg
Copper fixing accessory for Ø 8 mm	SCP3000	2CTHCSCP3000	3660308524409	1	0.046



Pylon or ladder fixing accessories for round or flat conductor

Stainless steel collars

- use: to clamp conductors on tube supports
- material: stainless steel.

Tightening Ø mm	Type	Order code	EAN code	Pkg (pcs)	Weight (1 pce) kg
30 to 50	HCI2419	2CTH050001Z0000	–	20	0.015
40 to 70	HCI2420	2CTH050003Z0000	–	20	0.020
60 to 100	HCI2421	2CTHCHCI2421	–	1	0.025

Lightning air terminal range

Earth coupling accessories



Test joint

- enables the disconnection of the conductors for insulation and earthing measurements
- material: die-cast brass
- no need to drill the conductors
- accommodate Ø 6 and 8 mm round conductors and 30 x 2 or 30 x 3 mm flat conductors
- guarantee perfect conductivity, low impedance
- fixed by brackets with wood or metal screws, etc.
- in accordance with NF C 17-102 standard.

Description	Dimensions	Type	Order code	EAN code	Weight (1 pce)
	mm				kg
Test joint	70 x 50 x 20	JCH2708	2CTH0JCH2708	3660308522719	0.390

Note: Down conductors have to overlap on the whole height of the test joint.



Protecting flats and tubes

- 2 m galvanized steel flats or tubes to protect the down conductors against mechanical impact
- generally placed between the test joint and the ground
- delivered complete with 3 clamps (bracket, wood screw).

Description	Type	Order code	EAN code	Weight (1 pce)
				kg
Protecting flat for strip (delivered by 2)	TPH2705	2CTH0TPH2705	3660308522917	1.000
Protecting tube for round conductor (delivered by 2)	TPH2768	2CTH0TPH2768	3660308522924	1.000



Inspection earth pit

- used to house the test joint at ground level, the earth rod connections or earth interconnections
- the 2CTH0RVH3073 and 2CTH0RVH3074 models are equipped with a copper bar enabling the interconnection of 3 conductors or 2 conductors and a test joint.

Description	Dimensions	Type	Order code	EAN code	Weight (1 pce)
	mm				kg
1 - Cast iron	Ø ext. 190	RVH3071	2CTH0RVH3071	3660308522825	2.400
2 - Yellow polyester concrete	350 x 250	RVH3072	2CTH0RVH3072	3660308522832	10.000
3 - Yellow polyester concrete with earth bar	350 x 250	RVH3073	2CTH0RVH3073	3660308522849	10.000
4 - Grey PVC with earth bar	300 x 300	RVH3074	2CTH0RVH3074	3660308522856	3.300



Interconnection box for equipotential bonding

- these boxes are fixed to the bottom of the down conductor and enable easy, accessible interconnection and disconnection of the lightning earth termination system and the building's earth loop
- they are made of a galvanized steel cover over a copper bar mounted on two insulators enabling the connection of 2 conductors
- delivered complete with wood screw brackets and earth identification labels.

Description	Dimensions	Type	Order code	EAN code	Weight (1 pce)
	mm				kg
Interconnection box	150 x 65 x 65	BLH2707	2CTH0BLH2707	3660308522009	0.550

Warning notice

Description	Dimensions	Type	Order code	EAN code	Weight (1 pce)
	mm				kg
Warning notice	264 x 150	PSH2009	2CTH0PSH2009	3660308522757	0.010

Lightning air terminal range

Earthing system

Overview

Each down conductor in a lightning protection system must be connected to an earth termination system designed to carry away the lightning current. The earth termination system must fulfil three indispensable conditions:

- the earth termination resistance value
French and other international standards, as well as the technical requirements of a number of authorities stipulate an earth termination resistance value of less than 10 ohms. This value should be measured on the earth connection isolated from any other conductive component.
If the resistance value of 10 ohms cannot be achieved, the earth termination is nonetheless considered compliant if it is made up of at least 100 m of conductors or electrodes, each section measuring no more than 20 m (for level of protection 2, 3 and 4) and 160 m (8 x 20 m) for level 1.
- equipotential bonding
Standards require the equipotential bonding of lightning earth termination system with the existing earthing systems.
- inspection earth pit
The connection parts between lightning earth system and electrical system test joint can be accessed by an inspection pit.

General earth system

Duck's foot earth termination system

The minimum earth termination system is made up of 25 m of 30 x 2 mm tin-plated copper strip, split into 3 strands buried in 3 trenches at a depth of 60 to 80 cm dug in a fan shape like a duck's foot: one end of the longest strand is connected to the test joint, the two other strands being linked to a special connection known as a duck's foot connector.

Standard list of material

Description	Type	Order code	EAN code	Nb of pcs or m
Duck's foot connector	RPO2840	2CTH0RPO2840	3660308522818	1 pc
Flat conductor	CPC2712	2CTH040003R0000	3660308523129	25 m

Note: The earth termination is covered by a red or orange warning grid.

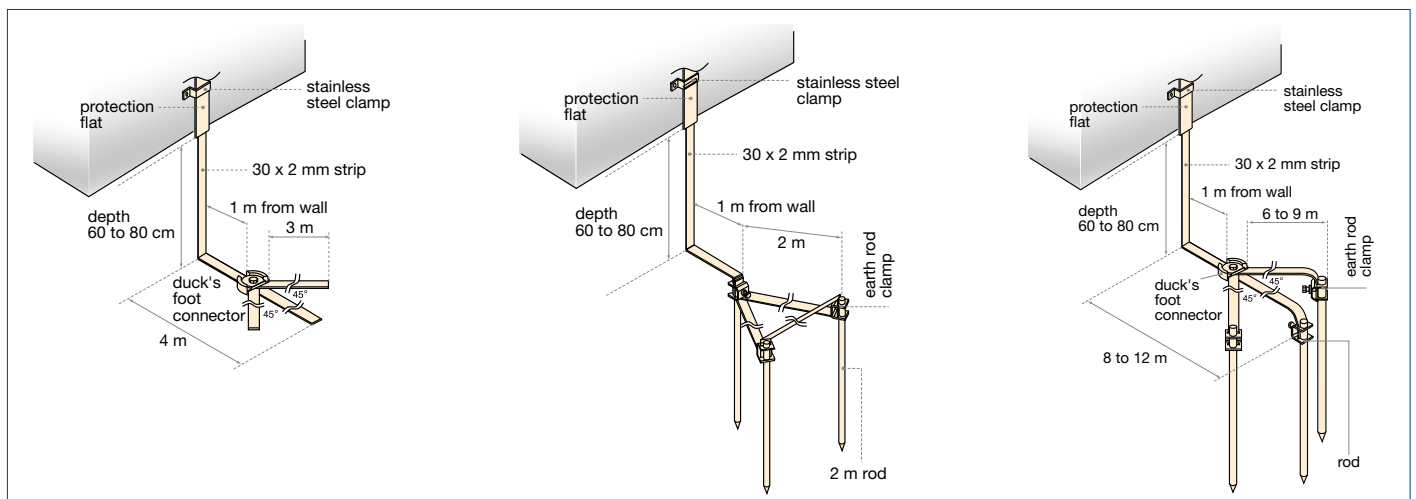

Rod triangle earth termination system

When the site topography does not lend itself to the installation of a duck's foot as described above, an earth termination system can be developed using at least 3 copper earth rods each with a minimum length of 2 m, buried vertically in the ground: the rods should be spaced at intervals of about 2 m and at a mandatory distance of 1 m to 1.5 m from the foundations.

Standard list of material

Rod system Description	Type	Order code	EAN code	Nb of pcs or m
Duck's foot connector	RPO2840	2CTH0RPO2840	3660308522818	1 pc
Flat conductor	CPC2712	2CTH040003R0000	3660308523129	10 m
Self-extensible earth rod	PVB2010	2CTHCPVB2010	3660308524379	6 pcs
Manual snap tool Ø 20	BMA0020	2CTH0BMA0020	3660308522030	1 pc
Earth rod clamp	CRH4020	2CTH0CRH4020	3660308522160	3 pcs

Note: The earth termination is covered by a red or orange warning grid.

Duck's foot earth termination system with earth rods

If the soil type is not altogether suitable for a duck's foot connector, a combination of duck's foot and earth rods will significantly enhance protection. In this case, the end of each duck's foot connector strand is connected to an earth rod.

Standard list of material

Rod system Description	Type	Order code	EAN code	Nb of pcs or m
Duck's foot connector	RPO2840	2CTH0RPO2840	3660308522818	1 pc
Flat conductor	CPC2712	2CTH040003R0000	3660308523129	25 m
Standard copper-bond rod, 2 m	PCS1920	2CTH0PCS1920	3660308524249	3 pcs
Manual snap tool Ø 20	BMA0020	2CTH0BMA0020	3660308522030	1 pc
Earth rod clamp	CRH4020	2CTH0CRH4020	3660308522160	3 pcs

Note: The earth termination is covered by a red or orange warning grid.

These here before configurations cannot guarantee an earth resistance of 10 Ω in case of bad soil resistivity. The values obtained by these configurations depends of the soil resistivity.

Lightning air terminal range

Earthing system

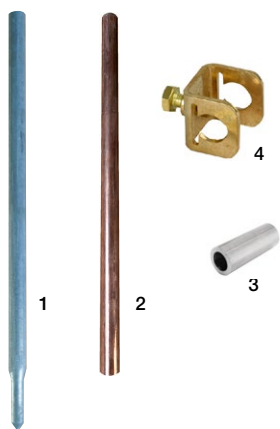

Earth rods

– the use of a reusable treated steel snap tool is compulsory to protect the rod head when driving in

Description	Type	Order code	EAN code	Weight (1 pce) kg
1 - Galvanized steel rod Ø 20 - L. 1 m	PVB2010	2CTHCPVB2010	3660308524379	2.400
2 - Standard copper-bond earth rod Ø 19 - L. 2.10 m	PCS1920	2CTHCPCS1920	3660308524249	3.940
3 - Manual snap tool Ø 20	BMA0020	2CTHOBMA0020	3660308522030	0.300
4 - Earth rod clamp for 30 x 2 strip	CRH4020	2CTH0CRH4020	3660308522160	0.150

(1) 2CTHCPVB2010: high resistance steel tube hot galvanized.
 (2) 2CTHCPCS1920: high corrosion resistance due to a 250 µ thickness of electrolytically plated copper.
 (3) 2CTHOBMA0020: manual snap tool - one for 3 rods to be hammered in.



Duck foot connectors

– zinc-plated, die-cast brass parts enabling the connection of three or four strands of tin-plated copper 30 x 2 mm conductor strip
 – variable strand angles
 – perfect electrical conductivity and strong tightening.

Description	Type	Order code	EAN code	Weight (1 pce) kg
Duck foot connector Ø 85 - thickness 30 mm	RPO2840	2CTH0RPO2840	3660308522818	0.800

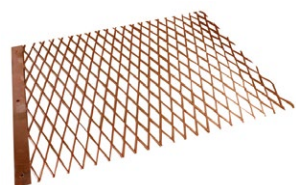

Earth grids

– earth grids are made of solid red copper with a mesh size of 115 x 40 mm.

Thickness mm	Description	Type	Order code	EAN code	Weight (1 pce) kg
3	Earth grid 0.66 x 0.92 m (4)	GMD6692	2CTHCGMD6692	3660308523303	3.800
3	Earth grid 1.00 x 2.00 m (5)	GMD1020	2CTHCGMD1020	3660308523297	8.400

(4) Equivalent to 18 m of Ø 8 mm round conductor.
 (5) Equivalent to 54 m of Ø 8 mm round conductor.



Digital earth test set

– battery-powered and watertight the 2CTHCACA6460 is a device that is easy to use and has been designed for operation in the field
 – on all installations requiring the qualification of electrical or lightning earth termination system, using traditional earth rod methods, the 2CTHCACA6460 measures the earth resistance and resistivity of the soil.

Description	Type	Order code	EAN code	Weight (1 pce) kg
1 - Digital earth and resistivity test set	ACA6460	2CTHCACA6460	3660308523044	1.300
Housing for test set with accessories (4 leads + 4 rods)	ACA2025	2CTHCACA2025	3660308523006	6.000



Lightning air terminal range

Equipotential bonding



Antenna mast arrester

- use: temporary grounding of an antenna mast in the event of lightning impact directly on the antenna
- in normal circumstances, the arrester insulates the antenna from the earth, but also from the Lightning Protection System in the event of a lightning strike on the LPS
- the arrester can also be used to earth metallic structures such as pylons, motor chassis, roof equipment, etc.
- characteristics:
 - dynamic excitation < 1800 V
 - static excitation voltage < 1100 V
 - nominal discharge current: 25 kA
 - dimensions: 280 x 45 x 30 mm
 - delivered complete with clamp for mast attachment.

Description	Type	Order code	EAN code	Weight (1 pce) kg
Antenna mast arrester	EAH4005	2CTH0EAH4005	3660308522177	0.400



1



2

Lightning stroke counter

- this counter, which is connected in series to a lightning down conductor, records lightning current
- this counter (1) uses the current induced in a secondary circuit to activate an electromechanical counter. It has been tested in High Voltage laboratories and in situ
- Counter (1 and 2) equipped with an external dry contact when lightning current flow through it.

Description	Type	Order code	EAN code	Weight (1 pce) kg
1 - Lightning stroke counter with a flat conductor connection	CCF2005	2CTH060001R0000	3660308521279	0.410
2 - Lightning stroke counter and recorder	CIF2006	2CTH0CIF2006	3660308522146	0.340
3 - Lightning stroke LCD counter fit directly on round or flat conductor	CCF2006	2CTH060002R0000	3660308524744	0.1



3

OPR test kit

OPR lightning air terminal testing kit

- the testing kit needs a contact with the OPR tip in one hand, and the bottom of the pole or the down conductor in the other hand
- it tests the OPR electronics by activating the high-voltage internal circuit of the OPR.

Description	Type	Order code	EAN code	Weight (1 pce) kg
4 - ESE pole test	PMH8000	2CTH080004R0000	3660308522740	6.000
5 - ESE test system	VDT0001	2CTH080001R0000	3660308521309	1.900



4



5

Meshed conductors

Typical installation

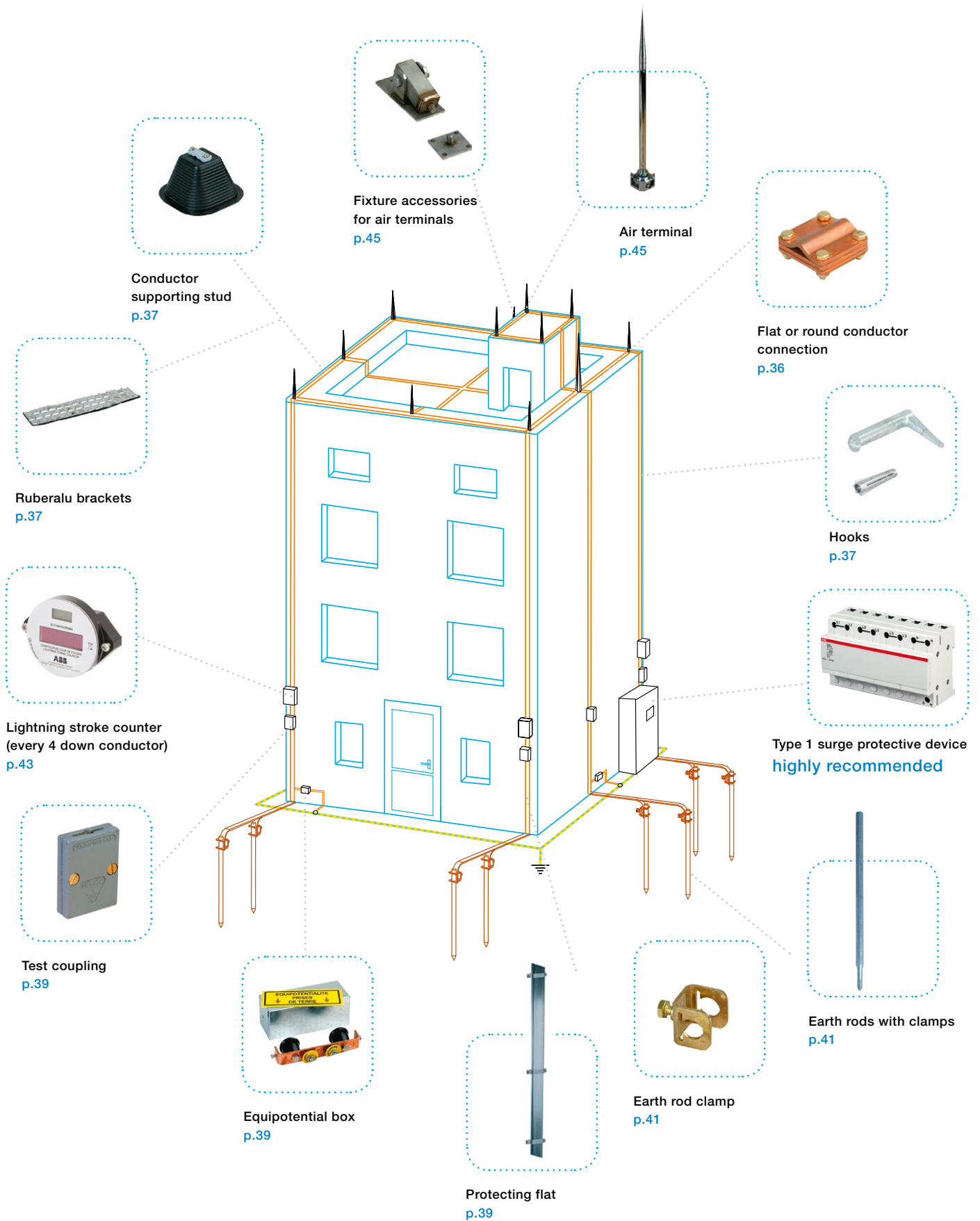

Meshed conductors

Accessories



Air terminal

Meshed cage air terminals are designed for easy, rapid installation on a wide range of structures.

They are made up of:

- a cylindrical (Ø 18 mm) bright nickel-plated copper cylinder tapered at the top and with a threaded lower section
- a bright tapped nickel-plated brass base M 10 for the connection and intersection of flat or round conductors. They are adaptable to all fixtures shown below.

Length	Material	Type	Order code	EAN code	Weight (1 pce)
m					kg
0.50	Nickel copper	HPC5000	2CTH0HPC5000	3660308522603	1.500

Fixture accessories for air terminals

Vertical mounting

- material: tin-plated or galvanized steel.



Length	Hole Ø	Description	Type	Order code	EAN code	Weight (1 pce)
cm	mm					kg
10	16	1 - To bed	SSH5001	2CTHCSSH5001	–	0.120
16	8	2 - To bold	STH5002	2CTHCSTH5002	3660308524423	0.070
13	10	3 - S/Steel threaded base	EFH5003	2CTH0EFH5003	3660308522184	0.100



Supporting plates

- material: stainless steel
- fixing: 2x Ø 10 mm bolt holes (centerline distance 93 mm).

Length x width	Description	Type	Order code	EAN code	Weight (1 pce)
mm					kg
50 x 50	1 - Flat plate PM	PSH5002	2CTH0PSH5002	3660308522795	0.100
120 x 50	Flat plate GM	PSH5004	2CTH0PSH5004	3660308522801	0.200
120 x 50	2 - Swivelling plate	SOH5006	2CTH0SOH5006	3660308522863	0.460
250 x 120	3 - Roof ridge plate	PFH5000	2CTH0PFH5000	3660308522733	0.500



Offset plate

- material: galvanized steel
- fixing: by M8 screw.



Description	Type	Order code	EAN code	Weight (1 pce)
15 cm offset plate	PDH5015	2CTHCPDH5015	3660308524263	0.200

Adaptor sleeve

- use: to fix air terminals to existing supports (max. Ø 50 mm)
- material: stainless steel.

Max. tightening length L	Type	Order code	EAN code	Weight (1 pce)
mm				kg
100	HMA5010	2CTH0HMA5010	3660308522566	0.400

Index

Order code classification

Order code	Type	Page	Order code	Type	Page	Order code	Type	Page
2CTB899800R7000	IMH3000	28	2CTH0EFH5003	EFH5003	45	2CTHCHPA0115		32
2CTB899800R7100	IMH6000	28	2CTH0FDT0045	FDT0045	38	2CTHCHPA0118		32
2CTB899800R7500	IMH4500	28	2CTH0FDT0046	FDT0046	38	2CTHCHPA0209		32
2CTH010001R0000	HPI3001	29	2CTH0HAA2673	HAA2673	37	2CTHCHPA0212		32
2CTH010002R0000	HPI3002	29	2CTH0HAR2645	HAR2645	38	2CTHCHPA0215		32
2CTH010004R0000	PTS3000	29	2CTH0HAR2646	HAR2646	38	2CTHCHPA0218		32
2CTH040001R0000	CPC0025	36	2CTH0HAR2745	HAR2745	37	2CTHCHPA0309		32
2CTH040002R0000	CPC0050	36	2CTH0HAR2746	HAR2746	37	2CTHCHPA0312		32
2CTH040003R0000	CPC2712	36	2CTH0HAR2845	HAR2845	38	2CTHCHPA0315		32
2CTH040005R0000	CRC8000	36	2CTH0HAR2846	HAR2846	38	2CTHCHPA0318		32
2CTH040006R0000	CRC8001	36	2CTH0HBR2717	HBR2717	37	2CTHCHPA0409		32
2CTH050001Z0000	HCI2419	38	2CTH0HCB4240	HCB4240	37	2CTHCHPA0412		32
2CTH050003Z0000	HCI2420	38	2CTH0HCL2642	HCL2642	37	2CTHCHPA0415		32
2CTH050011Z0000	HRP0100	37	2CTH0HCP2651	HCP2651	33	2CTHCHPA0418		32
2CTH050012Z0000	HRP0500	37	2CTH0HIS6000	HIS6000	38	2CTHCHPB2772	HPB2772	37
2CTH050013R0000	CDH5001	33	2CTH0HMA5010	HMA5010	45	2CTHCHPV2771	HPV2771	37
2CTH050014R0000	CDV5001	33	2CTH0HPC5000	HPC5000	45	2CTHPCPS1920	PCS1920	40
2CTH050015R0000	PBC0125	33	2CTH0HPP4523	HPP4523	35	2CTHCPDH5015	PDH5015	45
2CTH050016R0000	PBL0290	33	2CTH0HPS0010	HPS0010	33	2CTHCPRC8000	PRC8000	36
2CTH050018R0000	PDV0190	33	2CTH0HPS2630	HPS2630	34	2CTHCPVB2010	PVB2010	40
2CTH050020R0000	COC6001	33	2CTH0HRI3501	HRI3501	34	2CTHCSCP3000	SCP3000	38
2CTH050021R0000	CCT5001	33	2CTH0HST2044	HST2044	35	2CTHCSSH5001	SSH5001	45
2CTH050022R0000	FHF0001	32	2CTH0JCH2708	JCH2708	39	2CTHCSTH5002	STH5002	45
2CTH050023Z0000	FDV5625	32	2CTH0PFH5000	PFH5000	45	2CTHCTLB5002	TLB5002	35
2CTH050026R0000	KFR3542	31	2CTH0PSH2009	PSH2009	39	2CTHCTLB5004	TLB5004	35
2CTH050027R0000	KFP0035	31	2CTH0PSH5002	PSH5002	45	2CTHCTLB5005	TLB5005	35
2CTH050028R0000	KFR0050	31	2CTH0PSH5004	PSH5004	45	2CTHCTSH4525	TSH4525	35
2CTH050030Z0000	CPB3020	37	2CTH0RPO2840	RPO2840	40			
2CTH050031Z0000	CIP3020	37	2CTH0RVH3071	RVH3071	39			
2CTH050032Z0000	CMA3020	37	2CTH0RVH3072	RVH3072	39			
2CTH050033R0000	HEF2107	35	2CTH0RVH3073	RVH3073	39			
2CTH050034R0000	HEF2313	35	2CTH0RVH3074	RVH3074	39			
2CTH060001R0000	CCF2005	43	2CTH0SOH5006	SOH5006	45			
2CTH060002R0000	CCF2006	43	2CTH0STP5030	STP5030	36			
2CTH070001R0000	MAT3001	31	2CTH0STP5050	STP5050	36			
2CTH070002R0000	MAT3002	31	2CTH0STP5075	STP5075	36			
2CTH070005R0000	RAL3502	31	2CTH0STP5100	STP5100	36			
2CTH070006R0000	RAL3503	31	2CTH0TPH2705	TPH2705	39			
2CTH070007R0000	RAL4202	31	2CTH0TPH2768	TPH2768	39			
2CTH070008R0000	RAL4203	31	2CTHCACA2025	ACA2025	41			
2CTH070009R0000	RAL5002	31	2CTHCACA6460	ACA6460	41			
2CTH070010R0000	RAL5003	31	2CTHCBRP2680	BRP2680	36			
2CTH070011R0000	MAT3503	31	2CTHCCPG3035	CPG3035	36			
2CTH080001R0000	VDT0001	43	2CTHCCPI2711	CPI2711	36			
2CTH080004R0000	PMH8000	43	2CTHCCRE2700	CRE2700	35			
2CTH0BLH2707	BLH2707	39	2CTHCGMD1020	GMD1020	41			
2CTH0BMA0020	BMA0020	40	2CTHCGMD6692	GMD6692	41			
2CTH0BRC2780	BRC2780	36	2CTHCHAR2445	HAR2445	38			
2CTH0BRC2781	BRC2781	36	2CTHCHCI2421	HCI2421	38			
2CTH0BRH2779	BRH2779	36	2CTHCHCO0071	HCO0071	32			
2CTH0BRI2779	BRI2779	36	2CTHCHCO0752	HCO0752	32			
2CTH0BRX3780	BRX3780	36	2CTHCHFC4002	HFC4002	33			
2CTHOCIF2006	CIF2006	43	2CTHCHFP2650	HFP2650	33			
2CTHOCRH4020	CRH4020	40	2CTHCHPA0109		32			
2CTH0EAH4005	EAH4005	43	2CTHCHPA0112		32			

Index

Type classification

Type	Order code	Page	Type	Order code	Page	Type	Order code	Page
ACA2025	2CTHCACA2025	41	HEF2313	2CTH050034R0000	35	STP5030	2CTH0STP5030	36
ACA6460	2CTHCACA6460	41	HFC4002	2CTHCHFC4002	33	STP5050	2CTH0STP5050	36
BLH2707	2CTH0BLH2707	39	HFP2650	2CTHCHFP2650	33	STP5075	2CTH0STP5075	36
BMA0020	2CTH0BMA0020	40	HIS6000	2CTH0HIS6000	38	STP5100	2CTH0STP5100	36
BRC2780	2CTH0BRC2780	36	HMA5010	2CTH0HMA5010	45	TLB5002	2CTHCTLB5002	35
BRC2781	2CTH0BRC2781	36	HPB2772	2CTHCHPB2772	37	TLB5004	2CTHCTLB5004	35
BRH2779	2CTH0BRH2779	36	HPC5000	2CTH0HPC5000	45	TLB5005	2CTHCTLB5005	35
BRI2779	2CTH0BRI2779	36	HPI3001	2CTH010001R0000	29	TPH2705	2CTH0TPH2705	39
BRP2680	2CTHCBRP2680	36	HPI3002	2CTH010002R0000	29	TPH2768	2CTH0TPH2768	39
BRX3780	2CTH0BRX3780	36	HPP4523	2CTH0HPP4523	35	TSH4525	2CTHCTSH4525	35
CCG6001	2CTH050020R0000	33	HPS0010	2CTH0HPS0010	33	VDT0001	2CTH080001R0000	43
CCF2005	2CTH060001R0000	43	HPS2630	2CTH0HPS2630	34		2CTHCHPA0109	32
CCF2006	2CTH060002R0000	43	HPV2771	2CTHCHPV2771	37		2CTHCHPA0112	32
CCT5001	2CTH050021R0000	33	HRI3501	2CTH0HRI3501	34		2CTHCHPA0115	32
CDH5001	2CTH050013R0000	33	HRP0100	2CTH050011Z0000	37		2CTHCHPA0118	32
CDV5001	2CTH050014R0000	33	HRP0500	2CTH050012Z0000	37		2CTHCHPA0209	32
CIF2006	2CTH0CIF2006	43	HST2044	2CTH0HST2044	35		2CTHCHPA0212	32
CIP3020	2CTH050031Z0000	37	IMH3000	2CTB899800R7000	28		2CTHCHPA0215	32
CMA3020	2CTH050032Z0000	37	IMH4500	2CTB899800R7500	28		2CTHCHPA0218	32
CPB3020	2CTH050030Z0000	37	IMH6000	2CTB899800R7100	28		2CTHCHPA0309	32
CPC0025	2CTH040001R0000	36	JCH2708	2CTH0JCH2708	39		2CTHCHPA0312	32
CPC0050	2CTH040002R0000	36	KFP0035	2CTH050027R0000	31		2CTHCHPA0315	32
CPC2712	2CTH040003R0000	36	KFR0050	2CTH050028R0000	31		2CTHCHPA0318	32
CPG3035	2CTHCCPG3035	36	KFR3542	2CTH050026R0000	31		2CTHCHPA0409	32
CPI2711	2CTHCCPI2711	36	MAT3001	2CTH070001R0000	31		2CTHCHPA0412	32
CRC8000	2CTH040005R0000	36	MAT3002	2CTH070002R0000	31		2CTHCHPA0415	32
CRC8001	2CTH040006R0000	36	MAT3503	2CTH070011R0000	31		2CTHCHPA0418	32
CRE2700	2CTHCCRE2700	35	PBC0125	2CTH050015R0000	33			
CRH4020	2CTH0CRH4020	40	PBL0290	2CTH050016R0000	33			
EAH4005	2CTH0EAH4005	43	PCS1920	2CTHCPCS1920	40			
EFH5003	2CTH0EFH5003	45	PDH5015	2CTHCPDH5015	45			
FDT0045	2CTH0FDT0045	38	PDV0190	2CTH050018R0000	33			
FDT0046	2CTH0FDT0046	38	PFH5000	2CTH0PFH5000	45			
FDV5625	2CTH050023Z0000	32	PMH8000	2CTH080004R0000	43			
FHF0001	2CTH050022R0000	32	PRC8000	2CTHCPRC8000	36			
GMD1020	2CTHCGMD1020	41	PSH2009	2CTH0PSH2009	39			
GMD6692	2CTHCGMD6692	41	PSH5002	2CTH0PSH5002	45			
HAA2673	2CTH0HAA2673	37	PSH5004	2CTH0PSH5004	45			
HAR2445	2CTHCHAR2445	38	PTS3000	2CTH010004R0000	29			
HAR2645	2CTH0HAR2645	38	PVB2010	2CTHCPVB2010	40			
HAR2646	2CTH0HAR2646	38	RAL3502	2CTH070005R0000	31			
HAR2745	2CTH0HAR2745	37	RAL3503	2CTH070006R0000	31			
HAR2746	2CTH0HAR2746	37	RAL4202	2CTH070007R0000	31			
HAR2845	2CTH0HAR2845	38	RAL4203	2CTH070008R0000	31			
HAR2846	2CTH0HAR2846	38	RAL5002	2CTH070009R0000	31			
HBR2717	2CTH0HBR2717	37	RAL5003	2CTH070010R0000	31			
HCB4240	2CTH0HCB4240	37	RPO2840	2CTH0RPO2840	40			
HCI2419	2CTH050001Z0000	38	RVH3071	2CTH0RVH3071	39			
HCI2420	2CTH050003Z0000	38	RVH3072	2CTH0RVH3072	39			
HCI2421	2CTHCHCI2421	38	RVH3073	2CTH0RVH3073	39			
HCL2642	2CTH0HCL2642	37	RVH3074	2CTH0RVH3074	39			
HCO0071	2CTHCHCO0071	32	SCP3000	2CTHCSCP3000	38			
HCO0752	2CTHCHCO0752	32	SOH5006	2CTH0SOH5006	45			
HCP2651	2CTH0HCP2651	33	SSH5001	2CTHCSSH5001	45			
HEF2107	2CTH050033R0000	35	STH5002	2CTHCSTH5002	45			

Marketing tools

Catalogs and brochures

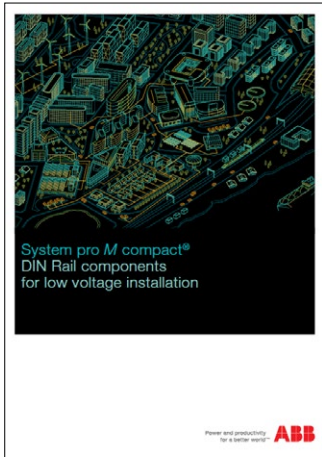

Technical catalog
System pro M compact®
DIN Rail components for low voltage installation
2CSC400002D0212



Main catalog
System pro M compact®
Surge and lightning protection solutions
1TXH000083C0203

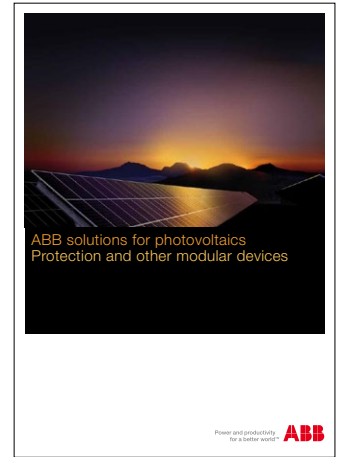

Brochure
ABB solutions for photovoltaics
Protection and other modular devices
2CDC002093B0201

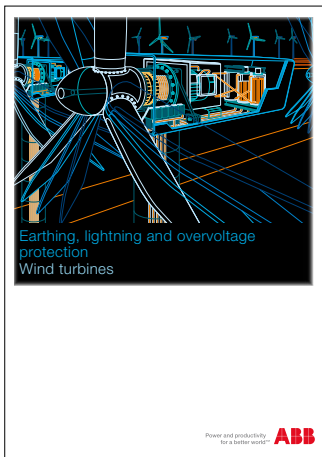

Brochure
Earthing, lightning and overvoltage protection
Wind turbines
1TXH000215B0201

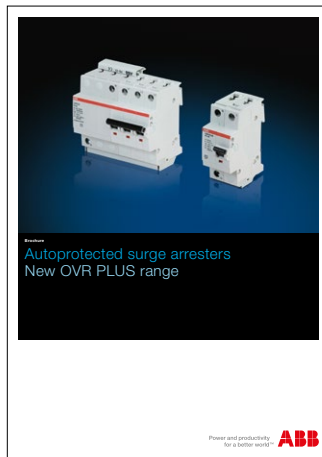

Brochure
Autoprotected surge arresters
New OVR PLUS range
1TXH000045B0203

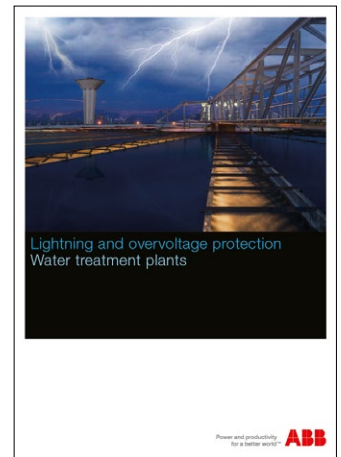

Brochure
Lightning and overvoltage protection
Water treatment plants
1TXH000444B0201

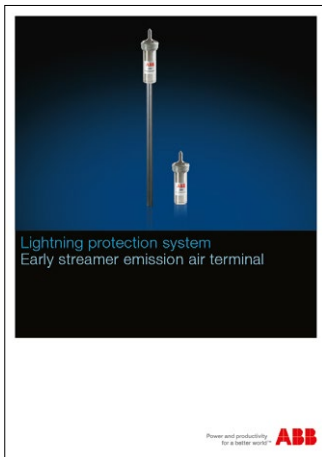

Brochure
Lightning protection system
Early streamer emission air terminal
1TXH000134B0205

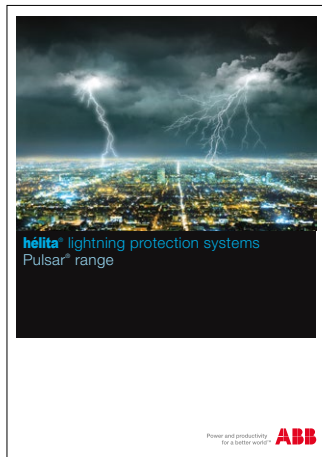

Brochure
Lightning protection system
Pulsar range
1TXH000084B0204

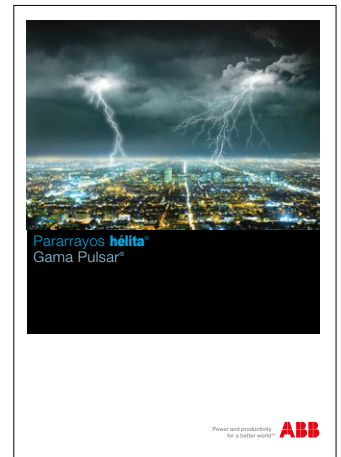

Brochure
Lightning protection system
Spanish version
1TXH000084B0703



Lightning protection specialists?

Absolutely.



Depending where we live, we are not all equal in front of the risk of lightning. For example there is more than 2 million lightning strokes per year on the French territory. They constitute a real risk for all humans and building structures. ABB as lightning protection specialist can offer you a range of lightning air terminals (simple rod or early streamer emission system OPR) in order to protect your facilities and personnel. All these products are developed by the ABB centre of excellence for lightning based in Bagnères de Bigorre - France; they are tested in laboratory as well as in situ to recreate natural conditions in the Pic du Midi (French Pyrenees).

ABB France
Lightning Protection Group

Power and productivity
for a better world™



Contact us

ABB France

Electrification Products Division

Pôle Foudre Soulé & Hérita

1, avenue des Victimes du 11 juin 1944

BP 303

F-65203 Bagnères-de-Bigorre / France

Tel. : +33 (0)5 62 91 45 60

Fax : +33 (0)5 62 91 45 62

You can find the address of your local sales organisation
on the ABB home page

<http://www.abb.com/contacts> -> Low Voltage products



<http://www.abb.com/lowvoltage>

Note

We reserve the right to make technical changes or modify the contents of this document without prior notice.

ABB does not accept any responsibility whatsoever for potential errors or possible lack of information in this document.

We reserve all rights in this document and in the subject matter and illustrations contained therein. Any reproduction, disclosure to third parties or utilization of its contents – in whole or in parts – is forbidden without prior written consent of ABB.

Copyright© 2016 ABB - All rights reserved