

UK-electronic ©2014

Kit Mosfet power amplifier 100/200W



Vollausbau 200W

Prime example! No inventory of delivery

WARNING

Attention:

this kit is not a beginners project! The voltages can +/- 60V DC and more, and are absolutely life-threatening if not handled !!!











We simply provide a complete compilation of the required components as well as a circuit and layout plan. UK-electronic offers no fundamental support for the construction! The kits and their components have been thoroughly checked.

For the function of the devices constructed by the customer, we accept no liability (the elements themselves, of course, already).

©2014 uk-electronic

Color table for resistors MF207 FTE52 1% and a example

Resistor color code

									
0	1	2	3	4	5	6	7	8	9

Example: Resistor MF207 10K 1%

Value: 10000 Ohm = 10KOhm

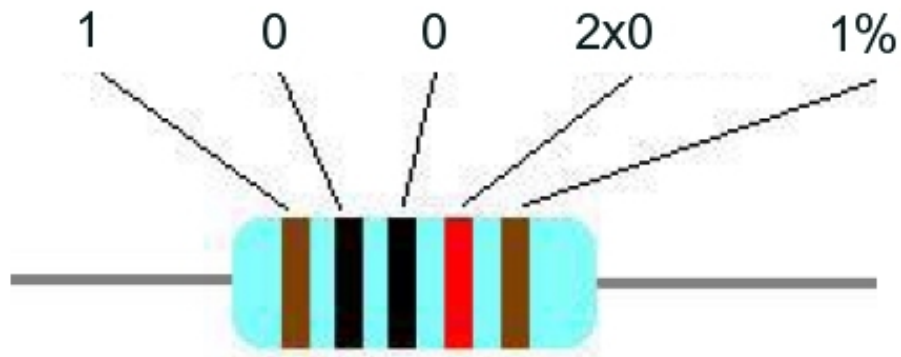

Mosfet Power Amplifier 100 bis 200W

Qty	Value
1	PCB „Mosfet Power Amp“
3	F1, F2, F3 Fuse holder
3	Fuse 4A slow
1	X1 Screw terminal 3 pole
2	Sodering tags 6,3mm
1	GR1 rectifer KBU8M or G
2	Insulating for transistors + M3 screws
1	1N4007 D1 0
3	2N5401 Q1, Q2, Q5 PNP Transistor
2	2N5551 Q3, Q4 NPN Transistor
1	IRFP240-H Q6, HEXFET Power MosFet
1	IRFP9240 Q7, HEXFET Power MosFet
1	4R7/2W R15 (yellow/violet/gold/gold)
1	47R R12 (yellow/violet/black/gold/brown)
3	100R R8, R10, R11 (brown/black/black/black/brown)
4	100R/2W R13, R14, R16, R17 (brown/black/brown/gold)
1	1k R6 (brown/black/black/red/brown)
1	1k TR1 CA6V
1	2k2 R1 (red/red/black/red/brown)
2	3k9 R4, R5 (orange/white/black/red/brown)
1	12k R9 (brown/red/black/red/brown)
1	43k R7 (yellow/orange/black/red/brown)
1	47k R3 (yellow/violet/black/red/brown)
1	250K TR2 CA6V
2	33p C5, C6 ceramic (33)
1	47p C21 ceramic (47)
1	68n C4 foil MKT
3	100n C7, C8, C10 foil MKT
1	1µF C1 foil MKT
1	47µ 63V C3
2	100µ 100V C9, C11
2	6800µF/80V C12, C13

Option : 200W Variante – Power supply min. 2x 55V (Trafo 225VA 2x40V)

Heatsink + screws M3

Q9 IRFP240-H

Q8 IRFP9240

Insulating for transistors + screws M3

The following kit includes all the components to build a mosfet amp for 100 or 200W. When building a 100W power amplifier, it is sufficient to work with two mosfets (Q6 and Q7). For safe operation, I recommend however as 100W variant the maximum configuration with 4 PowerMOSFETs, since the heat capacity is distributed optimally. In the experimental setup has been shown that the heat sink used here for continuous operation is too small and should be as large at least twice. However, one can tie or secure the heat sink to an existing metal chassis to the heatsink with a larger one. The transistors must be mounted insulated using mica -or- silicon wafers using thermal grease on the heat sink.

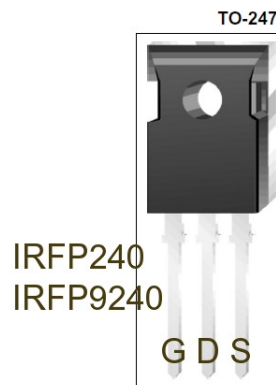

Soldering

First, all of the resistors, the capacitors (not charging electrolytic capacitors 2x6800/80) fitted, the transistors and the fuse holder and the soldering tags.

Then if the existing heat sink to the PCB screw and then the Power Mosfets (mount isolated) and solder. Then the two electrolytic caps 6800/80 can be fitted otherwise you could get very bad to fix it at the Mosfets zoom.

The comparison is limited to the set of quiescent current, which should be no modulation at about 30mA for 100W and 60mA for 200W. These easily removes the fuse in the positive power rail and turns on DVM in mA range between the two socket ends. With the trimmer TR1 can then be controlled quiescent current.

The trimmer TR2 is used to adapt to the level MOSFET output stage. For full scale of 100W 4 ohm approx 0.5V_{ss} / 1Khz were necessary.

The transformer should have at least 2x35V AC voltage at 2.5A load. This is a raw voltage of approx. 2x50V ready for the final stage, which then drops to about 45V at modulation. For more power then the transformer should be about 2x40V or 2x45 AC power at 2.5 to 3A. It corresponds to transformer cores of 200 and 225VA power rating.

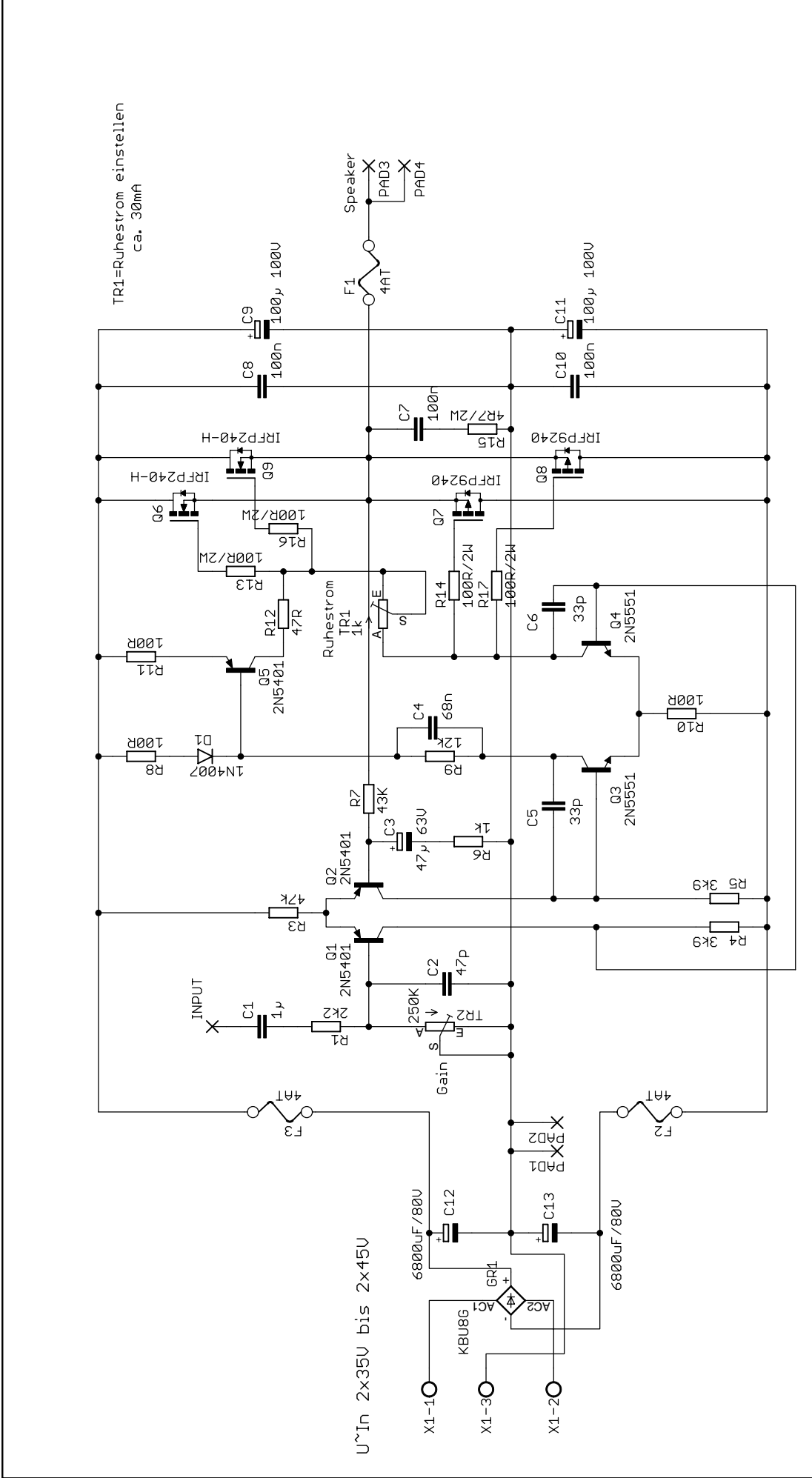

TITLE: 200w-mosfet-endstufe-mono	
Document Number:	REV:
Date: 18.03.2015 08:23:41	Sheet: 1/1