

Series 150 Controller

Installation Maintenance Repair Manual



Advantage Controls
4700 Harold-Abitz Dr.
Muskogee, OK 74403
Phone: 800-743-7431
Fax: 888-686-6212
www.advantagecontrols.com
email: support@advantagecontrols.com

11/2020

RO Series 150 Manual

Table of Contents

Contents	Page
I. Introduction	3
II. Installation.....	3
Mounting Instructions.....	3
Power Wiring.....	3
TDS / Conductivity Cell Wiring.....	4
Switch Inputs.....	5
I/O Expander Board	6
Terminal Strips, Jumpers and Wiring Diagram.....	6
III. Diagrams.....	8
A. Terminal Strips / Connectors.....	8
B. Sample Wiring Diagram.....	9
IV. Operation	10
A. Front Panel Display	10
V. Setpoints	14
A. Set Standard Setpoints.....	14
B. Display or Change Setpoints	16
VI. Adjustments	17
A. TDS / Conductivity Calibration.....	17
B. Display Adjustment	17
VII. Warranty and Factory Service Policies	18

I. Introduction

The Advantage Series 150 controller is a state of the art control system for commercial and industrial reverse osmosis systems. The S150 is a microprocessor-controlled system that can monitor pressure and level switches. A TDS/Conductivity monitor/controller with programmable Setpoints is an integral part of the S150. The S150 displays system status and sensor and switch input status on an easy to read backlit display. User programmable Setpoints are provided that allow fast and easy adjustment of system parameters.

II. Installation

Mounting Instructions

Mount the S150 in a convenient location on the RO equipment using the four mounting ears provided with the unit or the optional panel mounting bracket.

Note: All terminals on the board are labeled.

Terminal Strip, Jumper and Adjustment Locations

Refer to Figure 1 on page 8 for the location of all terminal strips and connectors. Figure 1 also shows all jumper and adjustment locations. Figure 2 (page 9) shows a sample wiring diagram.

Power Wiring

Refer to Figures 1-2 for terminal strip locations. AC power for the unit is connected to terminal strip P1. Connect the ground wire of the AC power to the terminal labeled GND. For AC power with a neutral and hot wire, the hot wire connects to L1 and the neutral wire connects to L2. For AC power with 2 hot wires, either wire can connect to L1 and L2. On AC power with 2 hot wires, the wire jumper between P6 and P7 should be removed and a fuse (GMA 1/4A) installed in F2.

Pump and Valve Relay Outputs

The S150 supplies relay outputs to control the RO pump and solenoid valves.

Note: The relays output the same voltage as the AC power to the board. If the pump and solenoids operate on different voltages, a contactor will need to be supplied to operate the pump.

Reverse Osmosis Pump Wiring

The RO pump connects to the L1 and L2 RO pump terminals of P1. This output can operate 120/240 VAC motors up to 1HP directly. For motors larger than 1HP or 3 phase motors, this output can be used to operate a contactor.

Inlet and Flush Valve Wiring

The inlet and flush valves must operate at the same voltage as supplied to the board. These outputs can supply 5A maximum and are not designed to operate pump motors directly. If these outputs are to be used to operate a boost or flush pump, the output should be used to operate a contactor. The inlet valve connects to the L1 and L2 inlet terminals of P1. The flush valve connects to the L1 and L2 flush terminals of P1.

TDS / Conductivity Cell Wiring

For accurate TDS/Conductivity readings, the cell should be installed in a tee fitting where a continuous flow of water passes over the cell and no air can be trapped around the cell. Refer to Figure 2 on page 9 for example installation. The cell is connected with 5 wires to terminal strip P10. Connect each colored wire to the terminal labeled with the same color.

TDS / Conductivity Sensor Installation

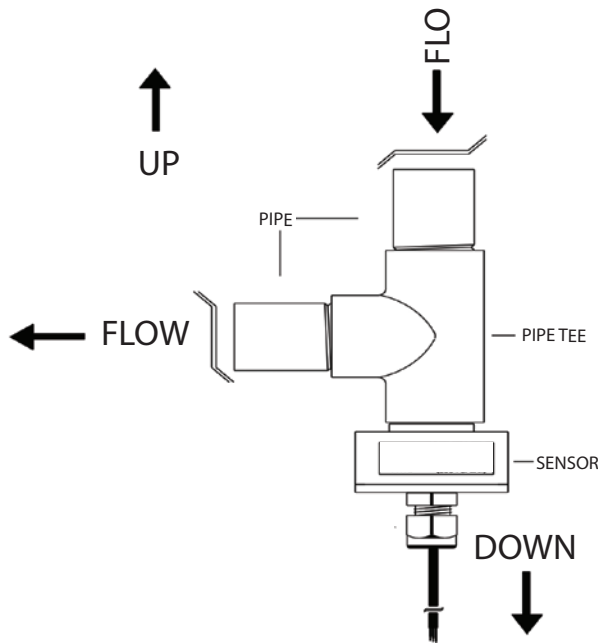

Notes:

- The sensor fitting is a 3/4" male NPT.
- Screw the sensors into the end of a pipe tee with the fluid flow in the direction indicated.
- Position the sensor in a place that will prevent air being trapped in the area of the sensor.

The TDS/Conductivity expander board allows a second TDS/conductivity to be monitored and displayed by the S150 controller. The expander board is mounted on the main board to the left of the connector for the 1st cell. The figure (above right) shows the wiring and adjustment information for the expander.

TDS / Conductivity Expander

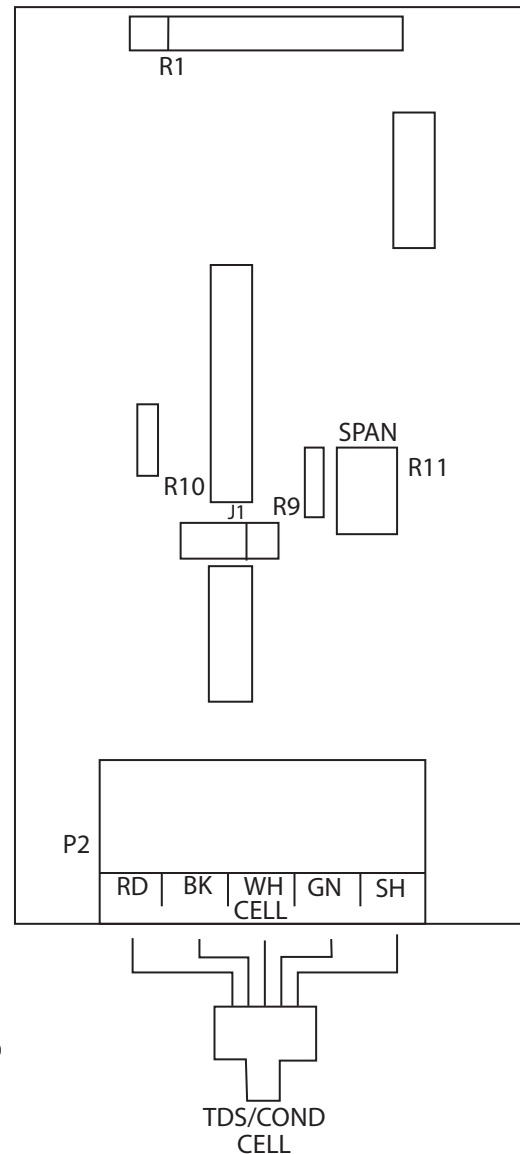

Switch Inputs

Switch inputs are connected to P9. The connections for these inputs are not polarity sensitive and can be connected to either terminal. The switch inputs should be dry contact closures only.

NOTE: Applying voltage to these terminals will damage the controller. The switches can be either normally open or normally closed in any combination. The switch connected to an input that is configured as normally open must be open for the unit to run. The switch connected to an input that is configured as normally closed must be closed for the unit to run. The Switch Select Setpoint allows each input to be configured as normally open or normally closed. The Switch Select Setpoint is defaulted to 31 which programs all inputs as normally closed. This means that all switch inputs must be closed for the unit to run. The table lists the values used to program the Setpoint to configure the inputs.

SWITCH	N.O.	N.C.	VALUE
PRESSURE FAULT	0	1	
PRETREAT	0	2	
TANK FULL HIGH	0	4	
TANK FULL LOW	0	8	
CHEM TANK LOW	0	16	
		TOTAL	

Select the type of switch used for each input and put that number in the value column. Add the values and program the total in the Switch Select Setpoint. For example, if the pressure fault and tank low inputs were normally closed and all others normally open, the value programmed in the Switch Select Setpoint would be 17(1 + 16).

Pressure Fault Switch

On systems where a low feed pressure shut down is required, a feed pressure switch can be connected to the pressure fault input of P9. If a high pump pressure shut down is required, a high pressure switch can be connected to this input. If both low feed pressure and high pump pressure shut down are required, both switches can be connected to this input. Both switches must be either normally open or normally closed to operate properly.

Pretreat Switch

In systems with pretreatment, a pretreat lockout switch can be connected to the pretreat input of P9. This switch should operate when the pretreatment device is out of service.

Note: The output from the pretreatment device must be a dry contact and must not supply voltage.

Tank Full Switch

In systems with a single tank level switch for controlling the RO pump, the level switch connects to the tank full high input of P9. If dual level switches are used for controlling the RO pump, the upper level switch connects to the tank full high input of P9 and the lower level switch connects to the tank full low input of P9.

I/O Expander Board

If the optional I/O expander board is installed, 2 additional relay outputs and 1 additional switch input are provided. AC power for the relays is connected to the L1 and L2 power terminals of P1. Relay 1 is connected to this power input and will supply the same voltage. This relay is rated for 120/240VAC at 1HP maximum. Relay 1 can be configured to supply a dry contact by connecting a jumper wire between the L1 and L2 power terminals of P1.

NOTE: If Relay 1 is configured as a dry contact, Relay 2 must be configured as a dry contact also. If Relay 1 is configured to supply voltage, Relay 2 can be selected to supply voltage, 120/240, 5A maximum, or as a dry contact output. Jumpers J1-J4 are used to select the relay 2 output type. To output voltage, a wire jumper is installed between J1 and J4 and a second wire jumper is installed between J2 and J3. For a contact closure output, a single wire jumper is installed between J3 and J4. The 2 relay outputs are programmed to operate as a divert output and an alarm output.

EXPANDER MODE	RELAY 1	RELAY 2
0	AUXILIARY PUMP	DIVERT
1	AUXILIARY PUMP	ALARM
2	DIVERT	ALARM
3	BOOST	DIVERT
4	BOOST	ALARM

Terminal Strips, Jumpers and Wiring Diagram.

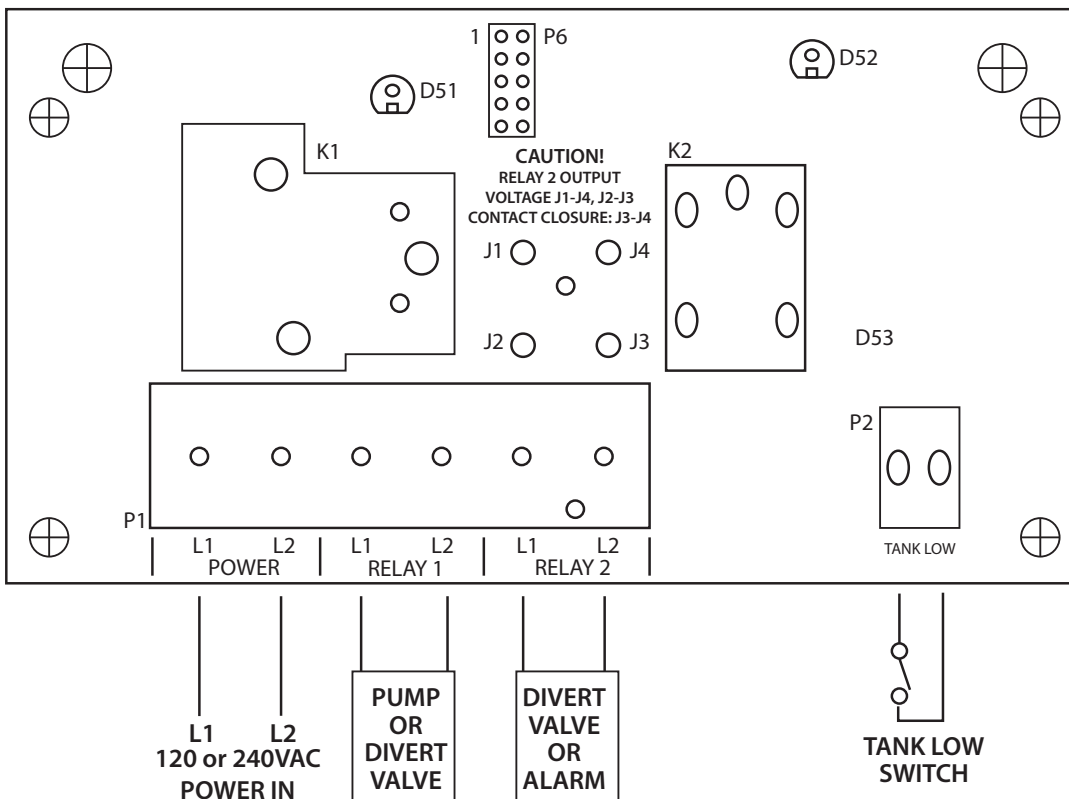

Auxiliary Pump

If the Expander Mode Setpoint is programmed to 0 or 1, relay 1 operates as an auxiliary pump output. This output is energized when the tank low input is not active. This output will supply power or a contact closure determined by the connections L1 and L2 of the terminal strip P1.

Boost Pump

If the Expander Mode Setpoint is programmed to 3 or 4, relay 1 operates as a boost pump output. This output is energized when the inlet solenoid output is active. This output will supply power or a contact closure determined by the connections L1 and L2 of the terminal strip P1.

Divert Output



If the Expander Mode Setpoint is programmed to 0 or 3, relay 2 operates as a divert relay and will operate whenever the unit is in the divert mode. This output will supply voltage or provide a contact closure based on the configuration of relay 1 and on the position of jumpers J1-J4. If the Expander Mode Setpoint is programmed to 2, relay 1 operates as a divert relay and will operate whenever the unit is not in the divert mode. This output will supply power or a contact closure determined by the connections L1 and L2 of the terminal strip P1.

Alarm Output

If the Expander Mode Setpoint is programmed to 1, 2 or 4, relay 2 operates as an alarm relay. When an alarm or warning is active, this relay will supply voltage or provide a contact closure based on the configuration of relay 1 and the position of jumpers J1-J4.

Chemical Tank Low Switch

A chemical tank low switch input can be connected to the tank low input of P2 on the expander board. This input will provide a chemical tank low alarm and will cause the unit to shut down.

 CAUTION 
1. There are live circuits inside the controller even when the power switch on the front panel is in the OFF position. Never open the front panel without first disconnecting power from the outlet. Prewired controllers are supplied with an 8 foot, 18 AWG power cord with USA style plug. A #1 Phillips driver is required to open the front panel.
2. Low voltage signal wires (probes, flow switch, water meter, etc.) should never be run in conduit with high voltage (like 115VAC) wires.
3. Never attempt to land connections to the controller without first disconnecting power from the outlet.
4. Do not block access to disconnect power during mounting and installation.
5. The controller should be connected to its own isolated circuit breaker, and for best results, the ground should be a true earth ground, not shared. Any attempt to bypass the grounding will compromise the safety of users and property.
6. The electrical installation of the controller must be performed by trained personnel only and conform to all applicable National, State and Local codes.
7. Operation of this product in a manner not specified by the manufacturer may result in damage to equipment or persons.
8. Avoid mounting in locations that expose the controller to direct sunlight, vapors, vibration, liquid spills or extreme temperatures; less than 0°F (-17.8°C) or greater than 120°F (50°C). EMI(electromagnetic interference) from radio transmissions and electric motors can also cause damage or interference and should be avoided.

III. Diagrams

Terminal Strips / Connectors

Figure 1

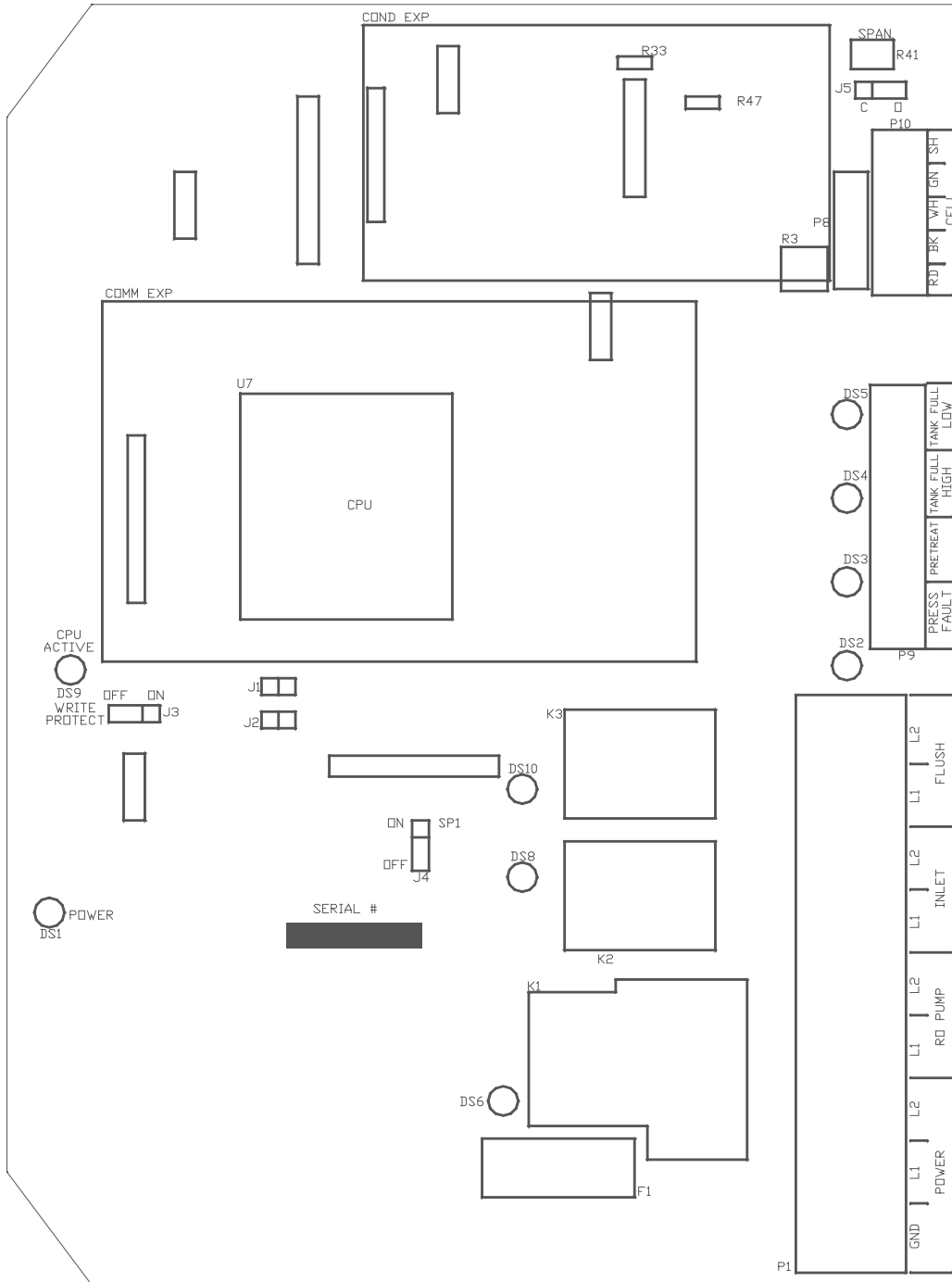

Sample Wiring Diagram

Figure 2

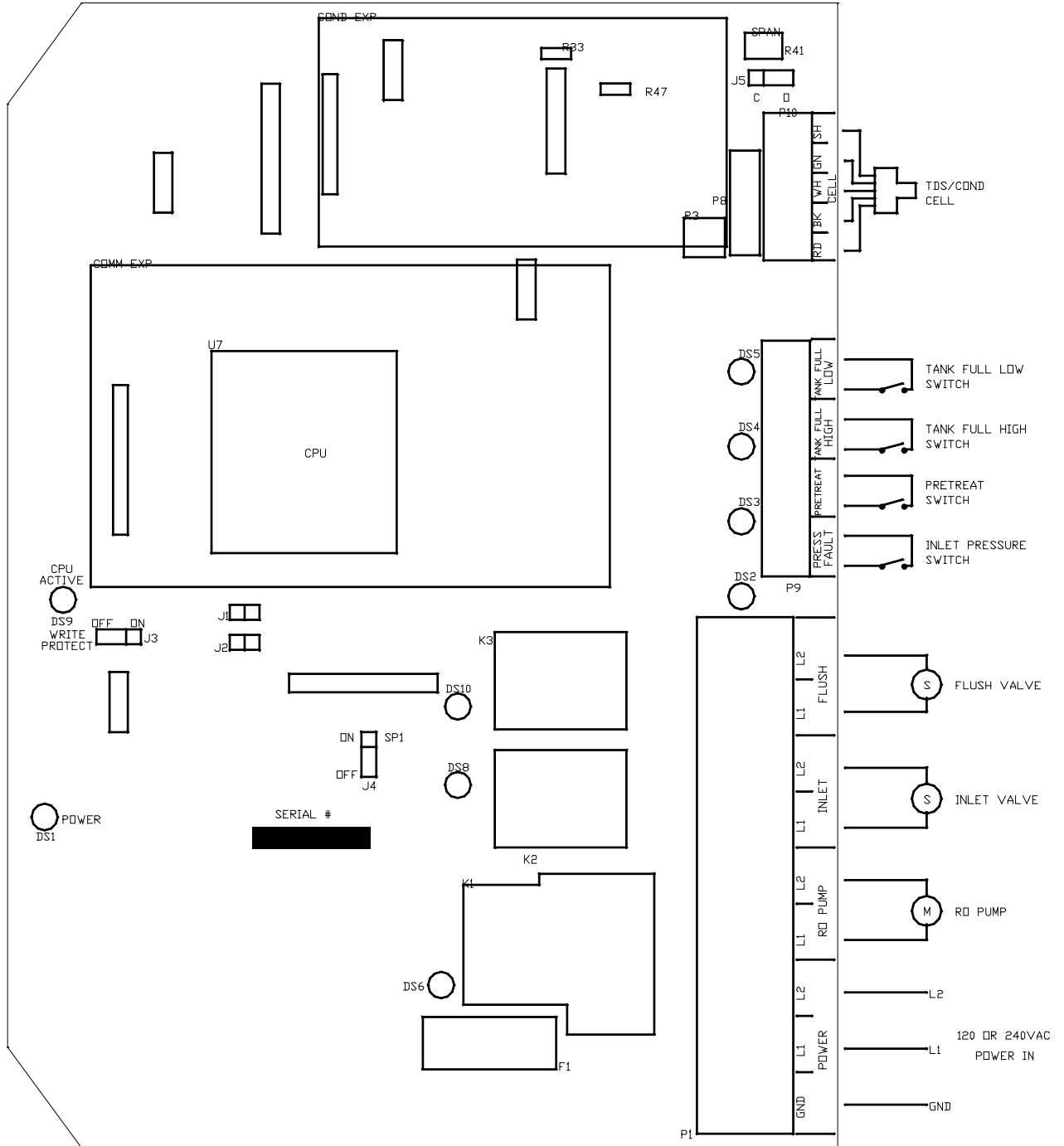

IV. Operation

The S150 has 2 modes of operation, an offline mode and an operating mode. In the offline mode, the unit is effectively off. All outputs are turned off and the display shows OFFLINE. In the operating mode, the unit operates automatically. All inputs are monitored and the outputs are controlled accordingly. Pressing the Power key will toggle the unit from offline to operate or from operate to offline. If power is removed from the unit, when power is reapplied, the unit will restart in the mode it was in when power was removed.

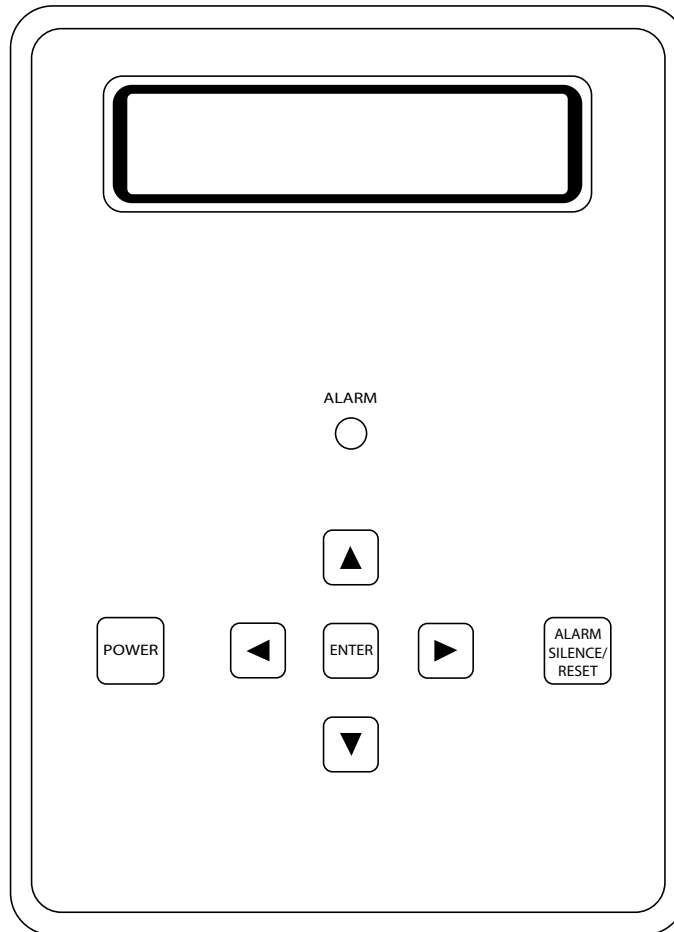

Front Panel Controls and Indicators

Display -	Shows status of system.
Alarm Lamp -	Flashes when fault causes a RO system shut down. On steady when a Setpoint is exceeded that does not cause an RO system shut down.
Power Key -	Places controller in operating or offline mode.
Left Arrow Key-	Scrolls through Setpoints starting with first Setpoint.
Right Arrow Key-	Scrolls through Setpoints starting with last Setpoint.
Up Arrow Key-	Increases value of Setpoint.
Down Arrow Key-	Decreases value of Setpoint
Enter Key -	Confirms entry of new Setpoint value
Alarm Silence / Reset Key -	Push once for alarm silence and twice to reset system after a shutdown has occurred.

Display

The display is a 2 line x 20 character backlit liquid crystal display. System operating status and sensor readings are shown on this display. Setpoint information is also shown on this display.

Operating Status Messages

The operating status of the unit is shown on the top line of the display. The following list describes the items shown for the operating status.

OFFLINE - The unit is offline.

DELAY 99 - The unit is in the RO start delay. The number is the seconds remaining before the RO pump starts.

OPERATING - The RO unit is operating.

TANK FULL - The unit is shut down due to a tank full condition.

PRETREAT - The unit is shut down due to a pretreat lockout condition.

PSI FAULT - The unit is shut down due to a pressure fault condition.

CHEM LOW - The unit is shut down due to a chemical tank low condition.

FLUSH 99 - Membrane flush is active. The number is the time remaining in the flush cycle.

TDS / Conductivity

The feed TDS/Conductivity is shown on the right half of the top line after the unit operating status. When the unit is offline because of a shut down condition, the reading is replaced with '----' If the reading is over range, the reading is shown as '^^^^'.

The permeate TDS/Conductivity is shown on the right half of the second line. When the unit is offline because of a shut down condition, the reading is replaced with '----' If the reading is over range, the reading is shown as '^^^^'.

Operating Hours, Temperature and % Rejection

The operating hours, the temperature and, if enabled, the % rejection are shown on the left half of the second line. The readings will alternate on the screen.

Warning Messages

Warning messages are also shown on the left half of the second line. If any warnings are active, the active warnings will alternate and be shown in place of the normal messages. The following lists the warning messages.

Hi Cond 1 - The feed TDS/Conductivity reading has exceeded the programmed limit.

Hi Cond 2 - The permeate TDS/Conductivity reading has exceeded the programmed limit.

HI HOURS - The current operating hours have exceeded the programmed limit.

Tank Full Operation

The unit can be operated with 1 or 2 level switches. With 1 level switch, the switch is connected to the tank full high input. When this switch has been active for 5 seconds, the unit will shut down on tank full. TANK FULL will show on the display. When the tank full condition clears, the unit will restart when the tank full restart delay times out.

For 2 level switch operation, the upper switch is connected to the tank full high input and the lower switch is connected to the tank full low input. When both switches are clear, the RO unit will run. The RO unit will continue to run when the water level rises and the lower switch becomes active. When the upper switch becomes active, after the 5 second delay, the RO unit will shut down. TANK FULL will show on the display. When the tank level drops and the upper level switch clears, the RO unit will remain off. When the lower level switch clears, the RO will restart when the tank full restart delay times out.

Tank Full Restart

The tank full restart is the delay before the RO unit starts when a tank full condition clears. This delay can be in minutes or in seconds. The TF Restart Setpoint selects seconds or minutes.

Tank Full Override

A timed tank full override can be initiated when the RO unit is shut down due to a tank full condition. Pressing the Alarm Silence/Reset key for 3 seconds during a tank full condition will enable the tank full override. The RO will start and OVERRIDE 9 will show on the display. The number is the minutes remaining in the override timer. When the override times out, the unit will return to the tank full shut down condition.

Pressure Fault

If the pressure fault input becomes active and stays active for the delay programmed in the PF Delay Setpoint, the unit will shut down for a pressure fault. The display will show PSI FAULT, the alarm lamp will flash and the audible alarm will sound. The pressure fault can be cleared by pressing the Alarm Silence/Reset key twice.

Auto Reset/Retries

If a pressure fault shut down occurs and the Auto Reset Setpoint is programmed to 0, the unit will remain shut down until manually reset. If the Auto Reset Setpoint is programmed to a value greater than 0, the unit will automatically clear the pressure fault and attempt to restart after this delay times out.

If the Retries Setpoint is programmed to a value other than 0, after the Auto Reset times out, the retry count will be incremented and the system will attempt to restart. If the pressure fault is still active, the system will again shut down. The system will attempt to restart for the number of times programmed in the Retries Setpoint and will then remain shut down until manually reset. If the system starts and is able to run continuously for 60 seconds, the retry count will be reset to 0.

Chemical Tank Low

When the chemical tank low input has been active for the time programmed in the Chem Low Delay setpoint, an alarm will be generated and the unit will shut down. The display will show CHEM LOW, the alarm lamp will flash and the audible alarm will sound. The fault can be cleared by pressing the Alarm Silence/Reset key twice.

High TDS / Conductivity Warning/Alarm

If the permeate TDS / Conductivity reading exceeds the limit programmed the C2 Limit Setpoint for the delay programmed in the C2 Delay Setpoint, the alarm lamp will light and the HI Cond 2 warning message will show on the display. This warning will clear when the TDS/Conductivity drops below the Setpoint. If the Shutdown Delay Setpoint is programmed to 0, the unit will continue to operate. Otherwise, once a high TDS/Cond warning occurs, after the time programmed in this setpoint, the RO unit will shut down and the alarm will sound. The alarm can be cleared by pressing the Alarm Silence/Reset key twice.

NOTE: the auto reset function is not active for this shut down.

High Temperature

If the feed water temperature exceeds the value programmed into the High Temp setpoint for 5 seconds, the unit will shut down for a high temperature alarm. The display will show HIGH TEMP, the alarm lamp will flash and the audible alarm will sound. The fault can be cleared by pressing the Alarm Silence/Reset key twice.

Alarm Silence

When a shut down occurs that causes the audible alarm to sound, the alarm can be silenced by pressing the Alarm Silence/Reset key once. The alarm will remain silenced if the Alarm Silence Setpoint is programmed to 0. If the Alarm Silence Setpoint is programmed to a value greater than 0, the alarm will resound after this delay times out. Pressing the Alarm Silence/Reset key will silence the alarm and reset this delay.

Pretreat

If the pretreat input becomes active and stays active for 2 seconds, the unit will shut down in a pretreat lockout condition. PRETREAT will show on the display and the unit will remain shut down as long as the pretreat input is active.

Direct Feed

If the Direct Feed setpoint is programmed to 0, the unit will operate normally with the tank full inputs controlling the operation of the unit. If the Direct Feed setpoint is programmed to 1, the unit will ignore the tank full inputs. The unit operation is controlled with the power key.

Flush

When the unit starts, the controller will begin a start up flush. During this flush, the inlet, flush and divert valves will be open and the RO pump will be off. The flush will last for the number of seconds programmed in the Flush Time 1 setpoint. When the flush times out, the controller will go through the start sequence. When the unit stops, the controller will begin a stop flush. During this flush, the inlet, flush and divert valves will be open and the RO pump will be off. The flush will last for the number of seconds programmed in the Flush Time 1 setpoint. When the flush times out, all outputs will turn off.

When the unit has been shut down continuously for the time programmed in the Flush Interval setpoint, the unit will begin an off hours flush. During this flush, the inlet and divert valves will be open and the RO pump will be on. The flush will last for the number of minutes programmed in the Flush Time 2 setpoint. When the flush times out, the unit will shut down.

Hi Operating Hours

If the current hours exceed the limit programmed in the Maximum Hours Setpoint, the alarm lamp will light and the HI HOURS warning message will be shown. This warning can be cleared by programming the current hours to 0 or by increasing the maximum hours limit.

Divert Output

When relay 1 or relay 2 has been programmed to operate as a divert relay, the relay will de-energize when the TDS/Conductivity exceeds the TDS/Cond Limit Setpoint. This will occur as soon as the reading exceeds the limit, there is no delay. When the reading drops below the limit and stays below the limit continuously for 5 seconds, the divert relay will turn on. If the RO is off, the divert output will be de-energized.

Alarm Output

When relay 2 has been programmed to operate as an alarm relay, the relay will energize whenever a warning or alarm condition occurs. The relay will remain energized as long as the warning/alarm condition is active.

Alarm Log

The alarm log screen will show the last 5 alarm conditions. Pressing both the Power and Alarm Silence/Reset key will display the alarm log screen. Press the Up arrow key to advance through the logged alarms. Pressing the Enter key will clear the alarm log.

V. Setpoints

A. Set Standard Setpoints

SETPOINT	DESCRIPTION	RANGE	DEFAULT
C2 Limit	When this value is met or exceeded, the alarm lamp will light and high TDS/Cond will show on the display. To disable, set to 0.	0-50.0 uS or PPM	10.0
C2 Delay	When the limit Setpoint is exceeded, no alarm will be given until this time has expired.	0-999 seconds	30
Shutdown Delay	Once a TDS/Cond alarm is active, if the time in this exceeded, a TDS/Cond shut down will occur. To disable, set to 0.	0-99 minutes	2
RO Start Delay	The amount of time between the inlet valve opening and the RO pump start.	0-99 seconds	5
Press Fault Delay	The time a pressure fault must be active before a pressure fault shut down occurs.	0-99 seconds	5
Auto Reset	When a pressure fault shut down is active, the system will attempt to restart after this delay. If set to 0, system must be manually reset.	0-99 minutes	60
Retries	Sets number of pressure fault retries the system will attempt. Set to 0 to disable.	0-9	5

SETPOINT	DESCRIPTION	RANGE	DEFAULT
Alarm Silence	If the audible alarm is silenced, after this delay, the alarm will resound. If set to 0, the alarm will remain silenced.	0-99 minutes	1
TF Restart Delay	When a tank full condition clears, the system will restart after this delay.	0-99 sec/min	5
TF Restart	Selects whether the tank full restart delay is in seconds or minutes. 0=seconds, 1=minutes.	0-1	0
TFO Time	The amount of time that a tank full override lasts.	0-9 minutes	5
Chem Low Delay	When a chem. tank low condition is active, delay before alarm occurs.	0-99 Seconds	5
Flush Time 1	The length of time the start/stop flush cycle Will last when flush is active.	0-99	30
Flush Time 2	The length of time the off hours flush cycle will last when flush is active.	0-99 minutes	5
Flush Interval	The interval between off hour flush cycles.	0-99 hours	2
Direct Feed	Selects normal tank full or direct feed operation. 0-normal, 1-direct feed	0-1	0
Maximum Hours	If the current operating hours exceed this limit, the operating hours warning will occur. To disable, set to 0.	0-65000 hours	4350
Current Hours	Current number of hours of RO system operation.	0-65000	0
Expander Mode	Selects how the relays on the I/O expander board operate.	0-4	2
High Temp	Sets the high temperature shut down limit	0-150°	32°
Temp Offset	Allows adjustment of temperature reading by +-5 degrees.	-5 - +5	0
Temp UOM	Selects display of temperature in °F or °C	0-1	1
Switch Select	Selects if switch inputs are normally open or normally closed.	0-31	31

SETPOINT	DESCRIPTION	RANGE	DEFAULT
TDS / Cond UOM	Selects display of water quality in uS or PPM NOTE: If this Setpoint is changed, the unit must be recalibrated.	0-1	0
C1 Limit	When this value is met or exceeded, the alarm lamp will light and high TDS/Cond will show on the display. To disable, set to 0.	0-999 uS or PPM	0
% Rej	Set to 1 to enable display of % rejection or 0 to disable display.	0-1	1

B. Display or Change Setpoints

1. Refer to page 10 for the location of the keys used to display or change the Setpoints, and Figure 1 (page 8) for the location of the write protect jumper, J3. For the unit to be able to accept a change in a Setpoint, the shorting jumper must be in the off position (center and left pins).
Note: Setpoints cannot be changed if the write protect jumper is in the ON position.
2. Use the Left and Right arrow keys to display the Setpoints. When either key is pressed, the top line of the display will show SETPOINT and the second line will show the setpoint and its value. Each press of an arrow key will advance the display to the next Setpoint. The Left arrow key starts with the beginning Setpoint and the Right arrow key starts with the last Setpoint.
3. The setpoint value cannot be changed until a key sequence has entered. To enable changing of the setpoint values, press Up, Down and then Up again. The top line of the display will now show ** SETPOINT **. This indicates that the setpoint can now be modified. The Up, Down and Up sequence can be entered before pressing the Left or Right arrow keys. If the sequence is entered first, the display will show ** SETPOINT ** when the Left or Right arrow key is first pressed. If the key sequence is entered incorrectly, press the Alarm Silence/Reset key and try again.
4. The Up and Down arrow keys are used to increment or decrement the Setpoint value. The value will change by 1 count each time a key is pressed. If the key is pressed and held for ~1 second, the Setpoint value will change at a fast rate. When the key is released, the fast rate will be reset. Pressing both the Up and Down arrow keys together will reset the Setpoint value to 0.
5. Pressing the Alarm Silence/Reset key at any time will cancel the operation and return the display to the main screen.
6. To accept the new Setpoint value, press the Enter key.
7. The unit will beep twice if the change is accepted. If the write protect jumper is on, the unit will show WRITE PROTECTED on the display and one long beep will sound.
8. When finished changing Setpoints, the write protect jumper should be placed in the on position (center and right pins).

To reset all setpoints to their value, press and hold both the Power and Right arrow keys for 3 seconds. The display will show PRESS ENTER TO RESET TO FACTORY DEFAULT. Pressing the Enter key will reset all setpoints to their default values. The display will show PROGRAMMING while the setpoints are being programmed. To cancel the operation, press the Cancel key instead of the Enter key.

NOTE: To reset the setpoint values, the write protect jumper must be in the off position.

VI. Adjustments

A. TDS / Conductivity Calibration

Feed

Refer to the Feed Cell Diagram on page 4 for adjustment location. To calibrate the feed TDS / Conductivity, place the cell in a known standard solution. Adjust the span adjustment for the correct reading. If the cell is installed, the unit can be calibrated by taking a sample of the water and testing it with a known, good meter. Adjust the span control until the reading matches the meter.

Permeate

Refer to Figure 1 (page 8) for adjustment location. To calibrate the permeate TDS / Conductivity, place the cell in a known standard solution. Adjust the span adjustment for the correct reading. If the cell is installed, the unit can be calibrated by taking a sample of the permeate water and testing it with a known, good meter. Adjust the span control until the reading matches the meter.

B. Display Adjustment

The display contrast can be adjusted for best viewing by adjusting control R3. This control is located toward the upper right corner of the board, just to the left of the cell connector.

VI. Manufacturer's Product Warranty

Advantage Controls warrants to the original purchaser that the products it manufactures will be free from defects in material and workmanship for a period of twelve months from the date of shipment on parts and ninety days on labor. Some non-Advantage manufactured resale items may have warranty periods less than twelve months. Advantage Controls' obligation under this warranty is limited exclusively to the repair or replacement of any product that Advantage finds to be defective. Items returned for warranty consideration must have a return authorization number and be properly packaged, shipped prepaid and insured. This warranty is valid only when the products are properly installed, maintained and used for the purpose for which they were designed. Misuse, neglect, damage, accident, improper repair, or modification not authorized in writing by Advantage Controls will void this warranty.

There are no warranties, expressed or implied, including the implied warranties for merchantability or fitness for a particular purpose that extend beyond the limited warranty expressly stated above. Advantage Controls' liability to any purchaser of its products, whether in contract or in tort, and whether arising out of warranties, representations, instructions, installations, or defects from any cause, will be limited exclusively to repairing or replacing the product or any part thereof under the conditions set out above.

30 Day Billing Memo Policy

Advantage Controls maintains a unique factory exchange program to ensure uninterrupted service with minimum downtime. If your controller malfunctions, call 1 (918-686-6211 (international customers dial +1 918 686-6211), and provide our technician with Model and Serial Number information. If they are unable to diagnose and solve your problem over the phone, a fully warranted replacement unit will be shipped, usually within 48 hours, on a 30 Day Billing Memo. This service requires a purchase order and the replacement unit is billed to your regular account for payment. The replacement unit will be billed at current list price for that model less any applicable resale discount. Upon return of your old unit, credit will be issued to your account if the unit is in warranty. If the unit is out of warranty or the damage not covered, a partial credit will be applied based upon a prorated replacement price schedule dependent on the age of the unit. Any exchange covers only the controller or pump. Electrodes and other external accessories are not included.

- Notes -

Get the Advantage in Water Treatment Equipment

Advantage Controls can give you the *Advantage* in products, knowledge and support on all of your water treatment equipment needs.

- Cooling Tower Controllers
- Boiler Blow Down Controllers
- Blow Down Valve Packages
- Solenoid Valves
- Water Meters
- Chemical Metering Pumps
- Corrosion Coupon Racks
- Chemical Solution Tanks
- Solid Feed Systems
- Feed Timers
- Filter Equipment
- Glycol Feed Systems
- Pre Fabricated Systems

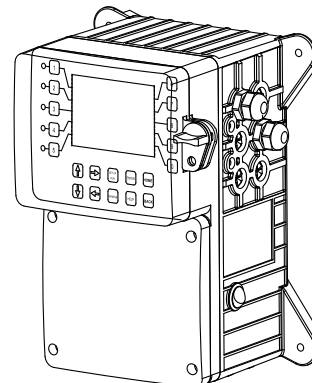
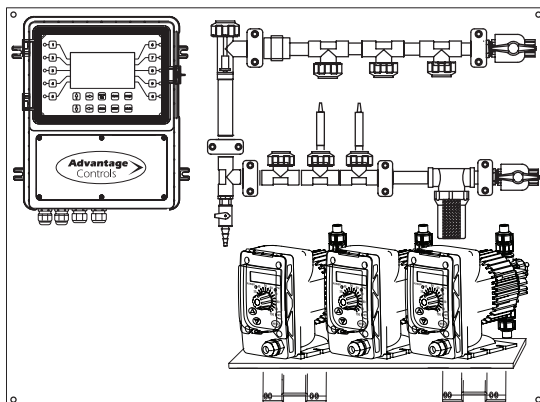
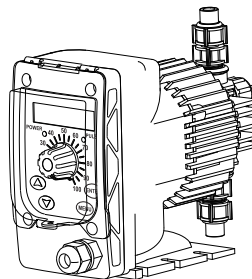
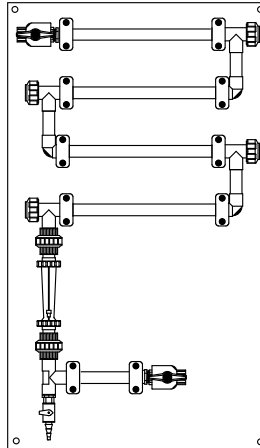
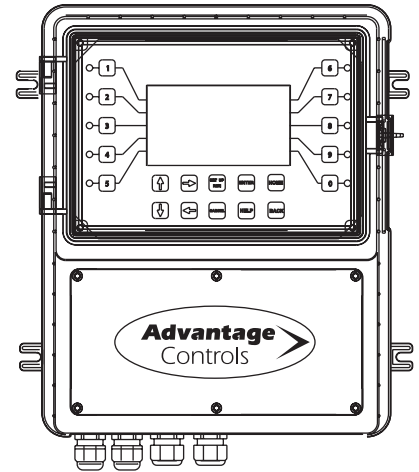
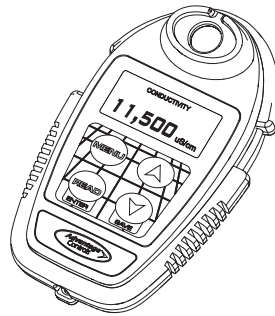

Get the Advantage

