

No More
Cutting &
Pasting!

Make Your
Own
Materials!

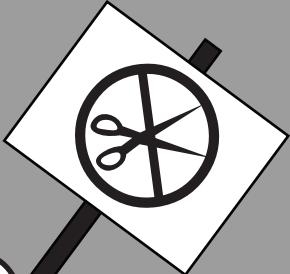

www.justusteachers.com

Table of Contents

Page	Content	Page	Content
3	Welcome and Licensing	26	123Fractions2
4	Installation Instructions	27	123Fractions3
5	123Angles1	28	123FractionSquares
6	123Angles2	29	123Geometry1
7	123Arrays	30	123Geometry2
8	123Beans1	31	123MathSymbols
9	123Beans2	32	123Mayan
10	123Cartesian1	33	123Money
11	123Cartesian2	34	123Money2
12	123Clocks1	35	123Nets1
13	123Clocks2	36	123NumberLines
14	123Clocks3	37	123PatternBlocks
15	123Clocks4	38	123PlaceValue2D
16	123CountingCubes	39	123PlaceValue3D
17	123CountingTiles1	40	123Rulers1
18	123CountingTiles2	41	123Rulers2
19	123Decimals	42	123TeddyBears
20	123Dice	43	123Testing
21	123Dominos1	44	123Transformations
22	123Dominos2	45	123Volume1
23	123FractionCircles	46	123Volume2
24	123FractionRectangles	47	123Volume3
25	123Fractions		

Welcome to 1,2,3 Math Fonts!

1, 2, 3 Math Fonts is an essential tool in the development of materials for the mathematics classroom. Use them to form your own creative worksheets, assessments, presentations and more!

Single User License

If you purchased a single user license, you have permission to install and use 1, 2, 3 Math Fonts on your school computer and your home computer. Please do not “share” with other computers or network this software.

School Site License

Purchase of a site license allows you to install 1, 2, 3 Math Fonts on every computer in your school as well as each teacher’s home computer. You may also install this software on a school network, but not on a district server.

District License

Purchase of a district license allows you to install 1, 2, 3 Math Fonts on all district computers and district employee’s home computers. The software may also be placed on a district network.

Publishing

Print items created with 1, 2, 3 Math Fonts may be freely distributed. Print items created for sale should have the acknowledgement “A portion of the materials contained in this publication were created with the use of 1, 2, 3 Math Fonts” on the copyright page. There are no publishing fees. The fonts may not be distributed in any way, nor can they be embedded on websites. Please contact mathfonts@justusteachers.com for more information.

*Please do not “share” 1,2,3 Math Fonts in any manner inconsistent with your license.

About the fonts...

1, 2, 3 Math Fonts has been specially created for math teachers. Every effort has been made to provide user-friendly fonts that will enhance your classroom teaching.

To make the fonts easy to find and use, all 1, 2, 3 Math Fonts start with “123” and have been grouped together near the top of your font menu.

The following pages detail the keystrokes involved in each font. A detailed listing of each keystroke/symbol association is provided, followed by a short description of how each font is laid out on the keyboard.

Some of the specialty fonts (that place one keystroke on top of another) may require you to strike the space bar several times after you’ve typed a symbol in order to avoid inadvertently placing one symbol on top of another.

Most of the fonts will be easier to see in larger sizes (48 and higher). Some fonts may appear incomplete on your computer screen when using smaller sizes, but will print clearly.

Keep in mind that all the features that work on your other installed fonts will also work on all of your 1, 2, 3 Math Fonts. Thus, the **Bold** feature will make your font bolder, Underline will underline your font, and *Italicize* will italicize your font!

Installation Instructions

*Once you have completed installation, it may be necessary to reboot your system before the fonts will appear properly.

Windows Option 1 - Automatic Installation

Insert CD into drive and wait for the **Welcome** screen to appear. If it does not appear automatically, double-click the CD drive to open it, then double-click **autorun**. Follow the prompts to complete installation.

Windows Option 2 - Manual Installation

Follow the instructions for your Operating System.

Windows 95 and older

1. Insert the CD-ROM into your disk drive.
2. Click **Start**, choose **Settings**, then choose **Control Panel**.
3. Double-click the **Fonts** icon to open it.
4. From the **File** menu, click **Install New Font**.
5. In the **Drives** menu, select the drive that contains the **123MathFonts** CD-ROM.
6. Select the **Fonts** folder in the **Directory** menu.
7. Select the fonts you wish to install.
8. Click **OK**. Then click "**Close**".

Windows XP

1. Insert the CD-ROM into your disk drive.
2. Click **Start**, then choose **Control Panel**.
3. Click **Appearance and Themes**.
4. Select **Fonts** from the Task Pane on the left side of the window.
5. From the **File** menu, click **Install New Font**.
6. In the **Drives** menu, select the drive that contains the **123MathFonts** CD-ROM.
7. Select the **Fonts** folder in the **Directory** menu.
8. Select the fonts you wish to install.

Windows Vista

1. Click **Start**, then choose **Control Panel**.
2. Click **Appearance and Personalization**.
3. Click **Fonts**.
4. From the **File** menu, click **Install New Font**. If you don't see the **File** menu, press **ALT**.
5. In the **Add Fonts** dialog box, under **Drives**, click the drive that contains the **123MathFonts** CD-ROM.
6. Select the **Fonts** folder in the **Folder** menu.
7. Select the fonts you wish to install, then click **Install**.

*Be sure to visit our **User Files** page, a collection of materials created by teachers using 1, 2, 3 Math Fonts.*

IT'S FREE!

www.justusteachers.com/mathfonts/userfiles.html

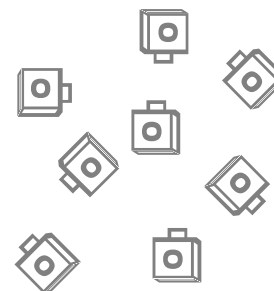

Macintosh OSX and later

1. Insert the CD-ROM into your disk drive.
2. Double-click the **123MathFonts** Icon.
3. Double-click the **Fonts** folder.
4. Drag the fonts that you wish to install to the **~/Library/Fonts** folder on your hard drive, (NOT the **System/Library/Fonts** folder.)

123Angles1

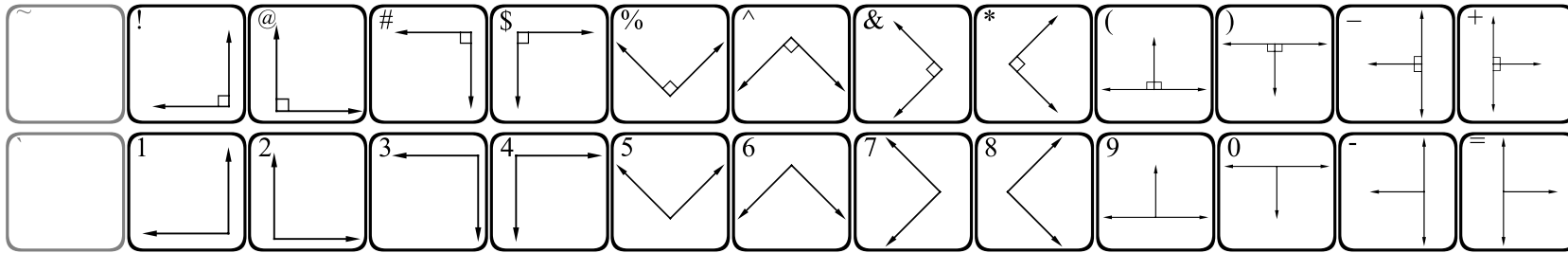

Right angles in various positions.

Acute angles in 15° increments.

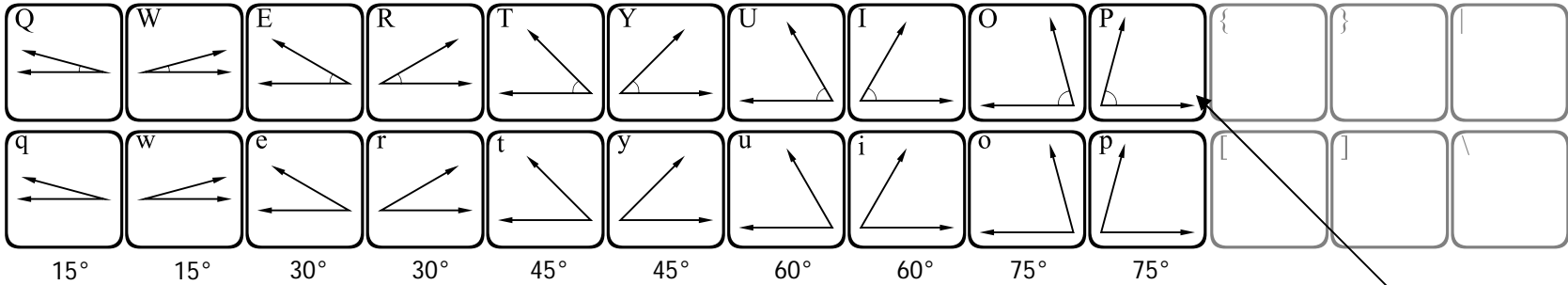

Pressing SHIFT will provide the same angle contained on the lowercase key, but with an angle marking.

Obtuse angles in 15° increments.

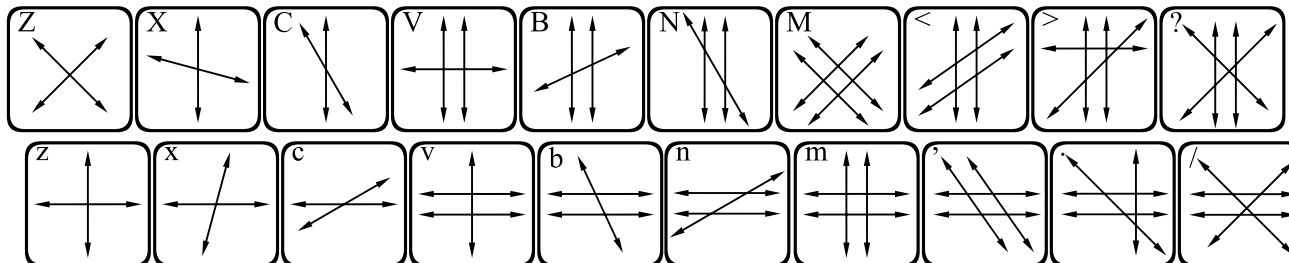
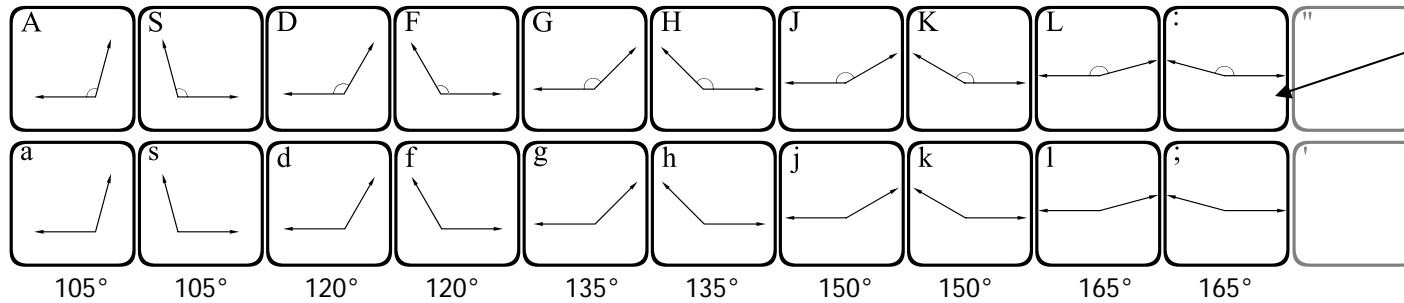

123Angles2

Requires 2 or more keystrokes. Type any 2 keys to create an angle.

- Press any 2 keys, and the 2 rays associated with those keys will meet at their endpoints to form an angle.
- Press the spacebar several times to move the cursor past the angle you have created.

~	!	@	#	\$	%	^	&	*	()	-	+
^	1	2	3	4	5	6	7	8	9	0	_	=
Q	W	E	R	T	Y	U	I	O	P	{	}	
q	w	e	r	t	y	u	i	o	p	[]	\
A	S	D	F	G	H	J	K	L	:	"		
a	s	d	f	g	h	j	k	l	;	'		
Z	X	C	V	B	N	M	<	>	?			
z	x	c	v	b	n	m	,	.	/			

Type 13 to make

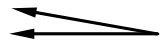

Type tWm to make

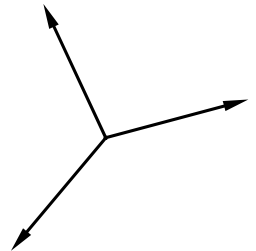

Moving from left to right, angles increase by 5 degree increments. Lowercase keys point "up", while uppercase point "down". Try pressing more than 2 keys to create multiple angles with a common vertex.

123Arrays

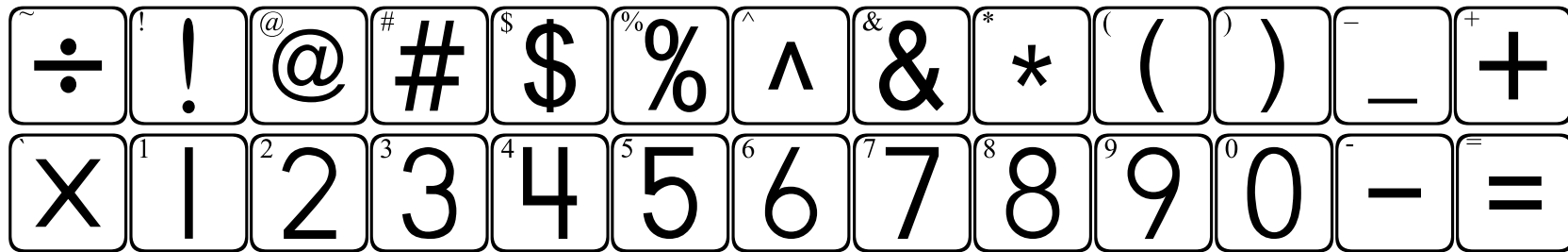

NOTE: The number of items on each letter key is equal to the number key above it.

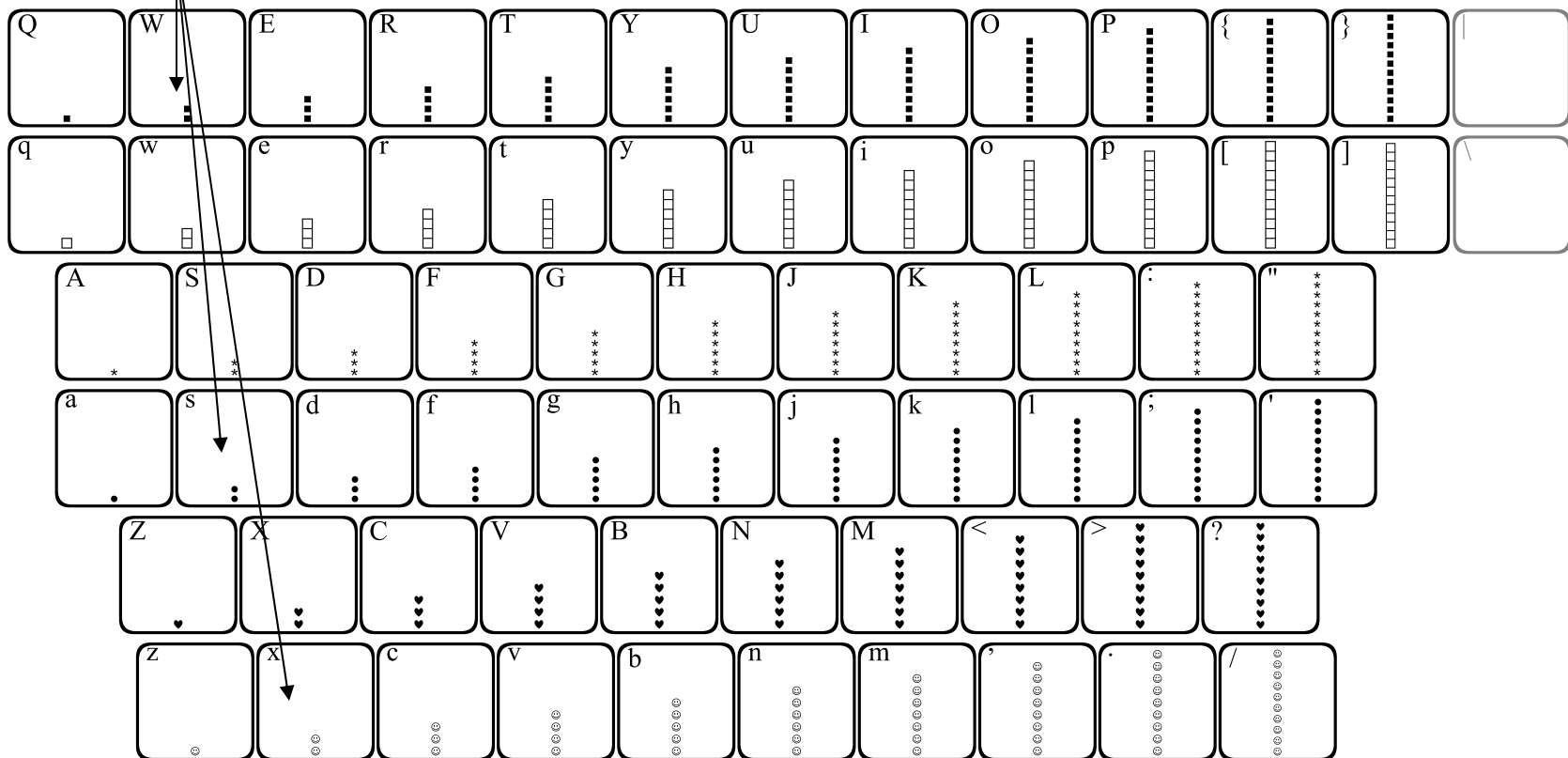

123Arrays can be used to build arrays and area models. Choose the height of the array you would like to build, and press the corresponding key. Each row starts with one figure and increases by one as you travel to the right. Press the key repeatedly until your array is the width you would like.

123Beans1

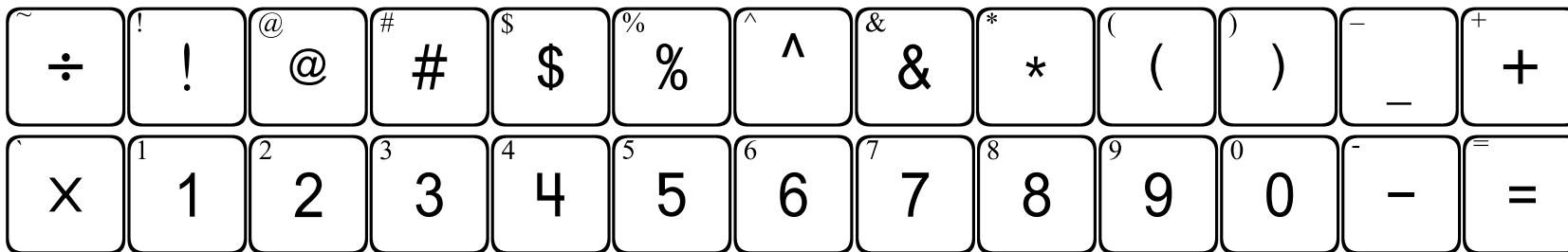

NOTE: The number of items on each letter key is equal to the number key above it.

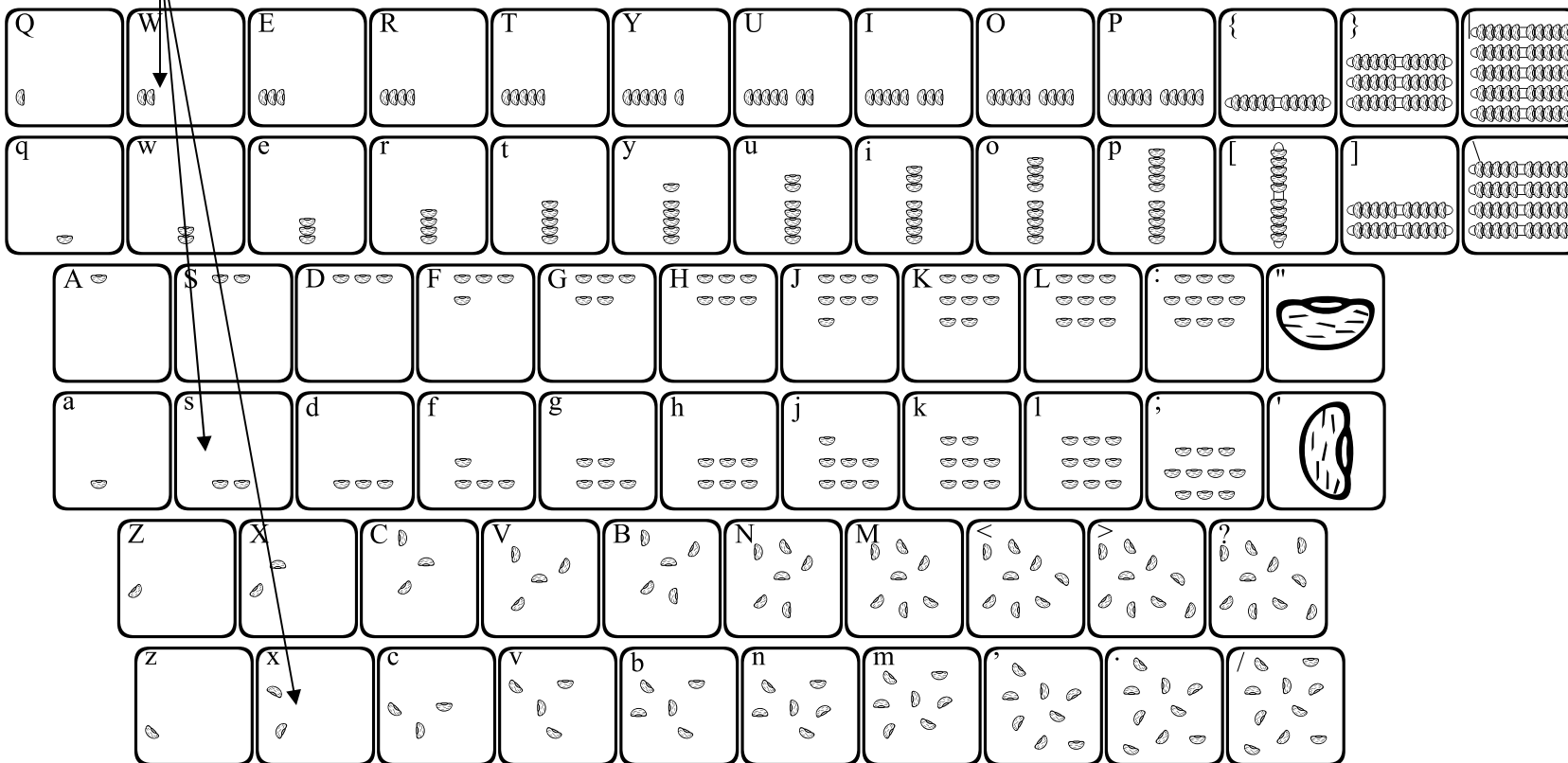

This font provides images of beans that can be used in teaching number concepts and place value.

Each letter row shows the beans in a certain formation in ascending order. By using the shift key with each letter row, you get the same number of beans, but in a different formation.

The braces, brackets and backslash show groups of ten beans (up to 5 groups stacked).

123Beans2

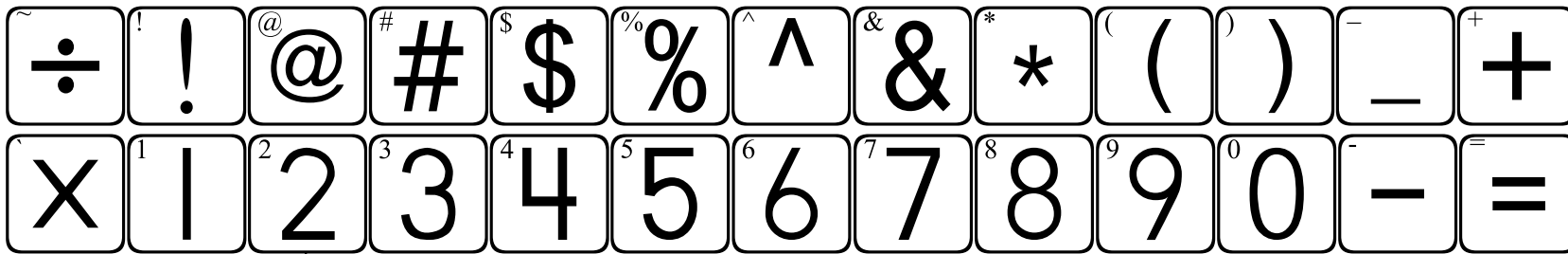

NOTE: The number of items on each letter key is equal to the number key above it.

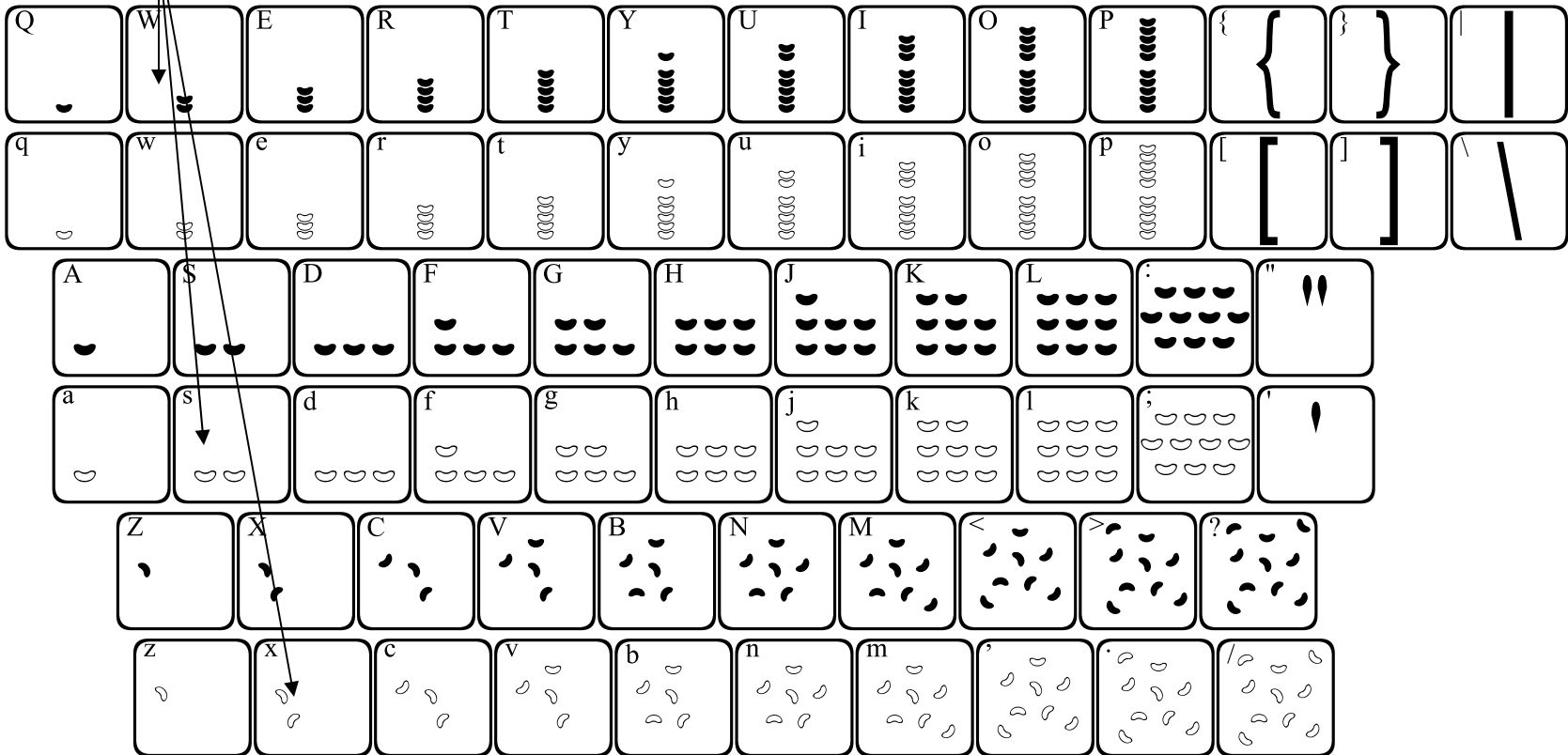

123Beans2 is very similar to 123Beans1. The primary difference is that the beans are shaped like lima beans.

Each letter row shows the beans in a certain formation in ascending order. By using the shift key with each letter row, you get the same number of beans, but in a different formation.

123Cartesian1

Requires 2 or more keystrokes. Grids are made by first placing the grid, then the point(s).

- Place grids using the bottom 2 rows of keys, then the points with the top 2 rows .
- Pressing the space bar will move the cursor one unit across the x-axis.

Points with arrows

Simple points

Points with letters

Relative y-axis positions

Grids are shown only for reference and do not appear when typing.

Typing any of these keys will place a point on a grid. The grid must be typed first.

As you move across the keyboard (left to right), the points are placed higher on the y-axis.

Type a grid first!

Indicates how the x and y axis are labeled.

Lowercase keys contain grids with the x and y labels. Grids on the uppercase keys are not labeled.

quadrant 2 numbered

quadrant 3 numbered

quadrant 4 numbered

quadrant 2

quadrant 3

quadrant 4

123Cartesian2

Requires 2 or more keystrokes. Grids are made by first placing the grid, then the point(s).

- Place grids using the "asdf" row of keys, then the points with the top 2 rows.
- Pressing the space bar will move the cursor one unit across the x-axis.

Points to use with 4 quadrant grids.

y = 0	y = -1	y = -2	y = -3	y = -4	y = -5	y = -6	y = -7	y = -8	y = -9	y = -10	
y = 0	y = 1	y = 2	y = 3	y = 4	y = 5	y = 6	y = 7	y = 8	y = 9	y = 10	

Grids are shown only for reference and do not appear. Typing any of these keys will place a point on a grid. The grid must be typed first.

Points to use with 1 quadrant grids.

y = 11	y = 12	y = 13	y = 14	y = 15	y = 16	y = 17	y = 18	y = 19	y = 20					
y = 1	y = 2	y = 3	y = 4	y = 5	y = 6	y = 7	y = 8	y = 9	y = 10	y = 0				

Type a grid first!

A	S	D	F	G	H	J	K	L	:	"				
a	s	d	f	g	h	j	k	l	:	"				
4 quadrants numbered	4 quadrants blank	quad 1 1x1	quad 1 5x5	quad 1 1x5	quad 1 5x1	quad 1 blank								
Z	X	C	V	B	N	M								
Z	X	C	V	b	n	m								
quad 2 numbered	quad 3 numbered	quad 4 numbered	quad 2 blank	quad 3 blank	quad 4 blank									

Lowercase keys contain grids with the x and y labels. Grids on the uppercase keys are not labeled.

Indicates how the x and y axes are labeled.

123Clocks1

Provides clocks that are preset at 15 minute increments.

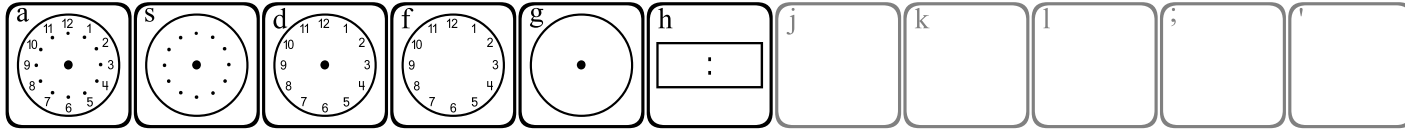
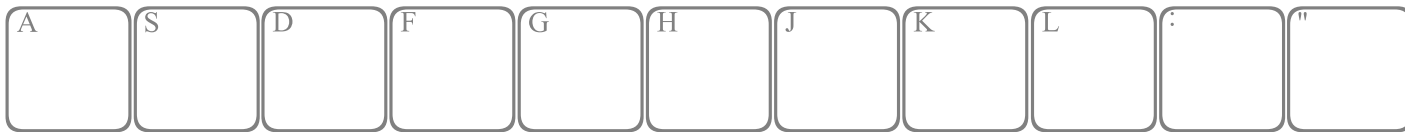
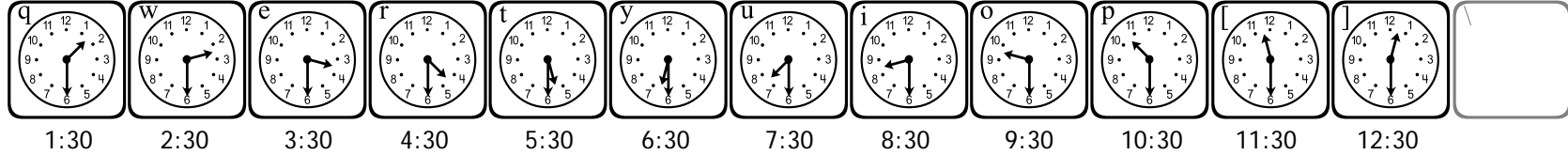
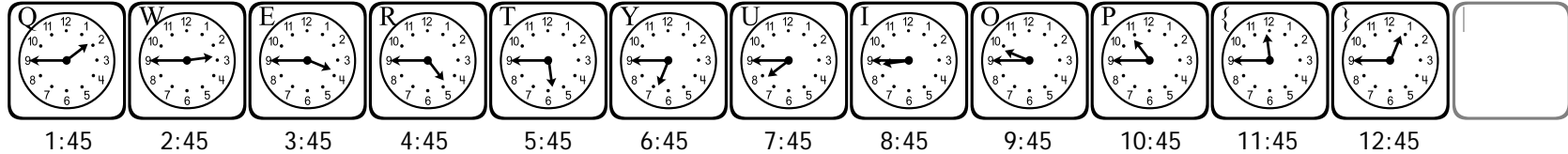
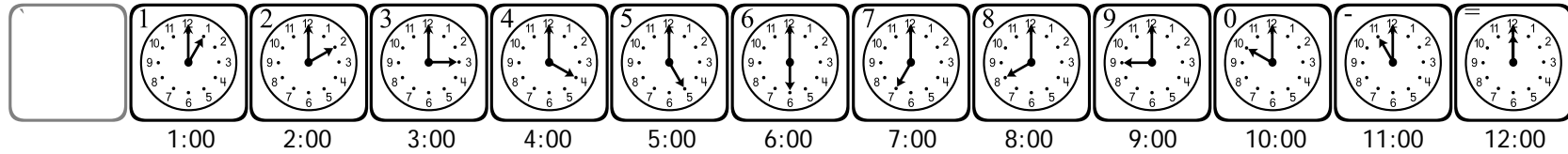
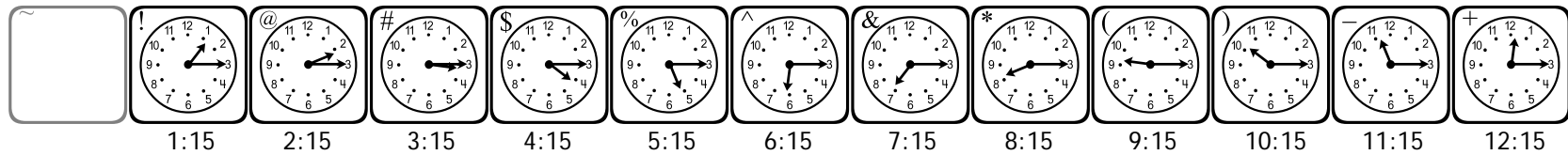

Z X Each hour corresponds to a number (1 = 1:00)
 The shift key with each number shows the quarter hour (! = 1:15)
 The row below each number shows the half hour (q = 1:30)
 The shift key with that row shows the hour and 3 quarters (Q = 1:45).

Z X Blank analog clocks can be found on the letters "a", "s", "d", "f" and "g".
 A blank digital clock can be found on the letter "h".

123Clocks2

Provides clocks that are preset at 15 minute increments. Identical to 123Clocks1, except for the shape of the hands.

~	!	@	#	\$	%	^	&	*	()	-	+
	1:15	2:15	3:15	4:15	5:15	6:15	7:15	8:15	9:15	10:15	11:15	12:15
	1	2	3	4	5	6	7	8	9	0	-	=
	1:00	2:00	3:00	4:00	5:00	6:00	7:00	8:00	9:00	10:00	11:00	12:00
Q	W	E	R	T	Y	U	I	O	P	{	}	
1:45	2:45	3:45	4:45	5:45	6:45	7:45	8:45	9:45	10:45	11:45	12:45	
q	w	e	r	t	y	u	i	o	p	l	l	\
1:30	2:30	3:30	4:30	5:30	6:30	7:30	8:30	9:30	10:30	11:30	12:30	
A	S	D	F	G	H	J	K	L	:	"		
a	s	d	f	g	h	j	k	l	;	'		

Z	X	Each hour corresponds to a number (1 = 1:00)	?
		The shift key with each number shows the quarter hour (! = 1:15)	
		The row below each number shows the half hour (q = 1:30)	
		The shift key with that row shows the hour and 3 quarters (Q = 1:45).	
Z	X	Blank analog clocks can be found on the letters "a", "s", "d", "f" and "g".	/
		A blank digital clock can be found on the letter "h".	

123Clocks3

Requires 2 or more keystrokes.

- Use the asdf row to place a clock face.
- Use the qwerty row to place hands on the clock.
- Use the number row to place numbers in the digital clock face.

~	!	@	#	\$	%	^	&	*	()	-	+	
	1	2	3	4	5	6	7	8	9	0	-	=	
Minute hands	Q ↗	W ↗	E →	R ↘	T ↘	Y ↓	U ↘	I ↙	O ←	P ↙	{ ↖	} ↑	
Hour hands	q ↗	w ↗	e →	r ↘	t ↘	y ↓	u ↘	i ↙	o ←	p ↙	[↖] ↑	\

Indicates the clock number the hand will be placed on.

→ 1 2 3 4 5 6 7 8 9 10 11 12

A	S	D	F	G	H	J	K	L	:	"	
a	s	d	f	g	h	j	k	l	:	"	

Z	X	C	V	B	N	M	<	>	?	
z	x	c	v	b	n	m	<	>	?	/

123Clocks4

Requires 2 or more keystrokes.

- Use the asdf row to place a clock face.
- Use the qwerty row to place hands on the clock.
- Use the number row to place numbers in the digital clock face.

~	!	@	#	\$	%	^	&	*	()	-	+	
	1	2	3	4	5	6	7	8	9	0	-	=	
Minute hands	Q ↗	W ↗	E →	R ↘	T ↘	Y ↓	U ↘	I ↙	O ←	P ↙	{ ↖	} ↑	
Hour hands	q ↗	w ↗	e →	r ↘	t ↘	y ↓	u ↘	i ↙	o ←	p ↙	[↖] ↑	\
	1	2	3	4	5	6	7	8	9	10	11	12	
	A	S	D	F	G	H	J	K	L	:	"		
	a	s	d	f	g	h	j	k	l	.	'	!	
	Z	X	C	V	B	N	M	<	>	?			
	z	x	c	v	b	n	m	,	.	/			

Indicates the clock number the hand will be placed on.

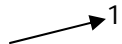

123CountingCubes

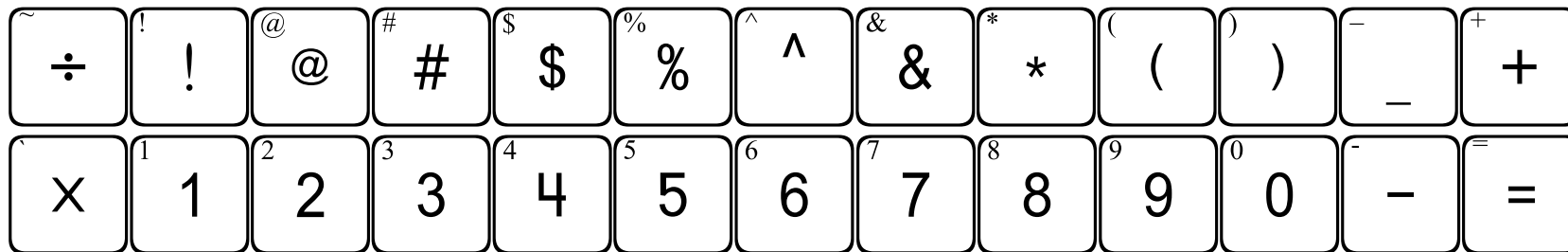

NOTE: The number of items on each letter key is equal to the number key above it.

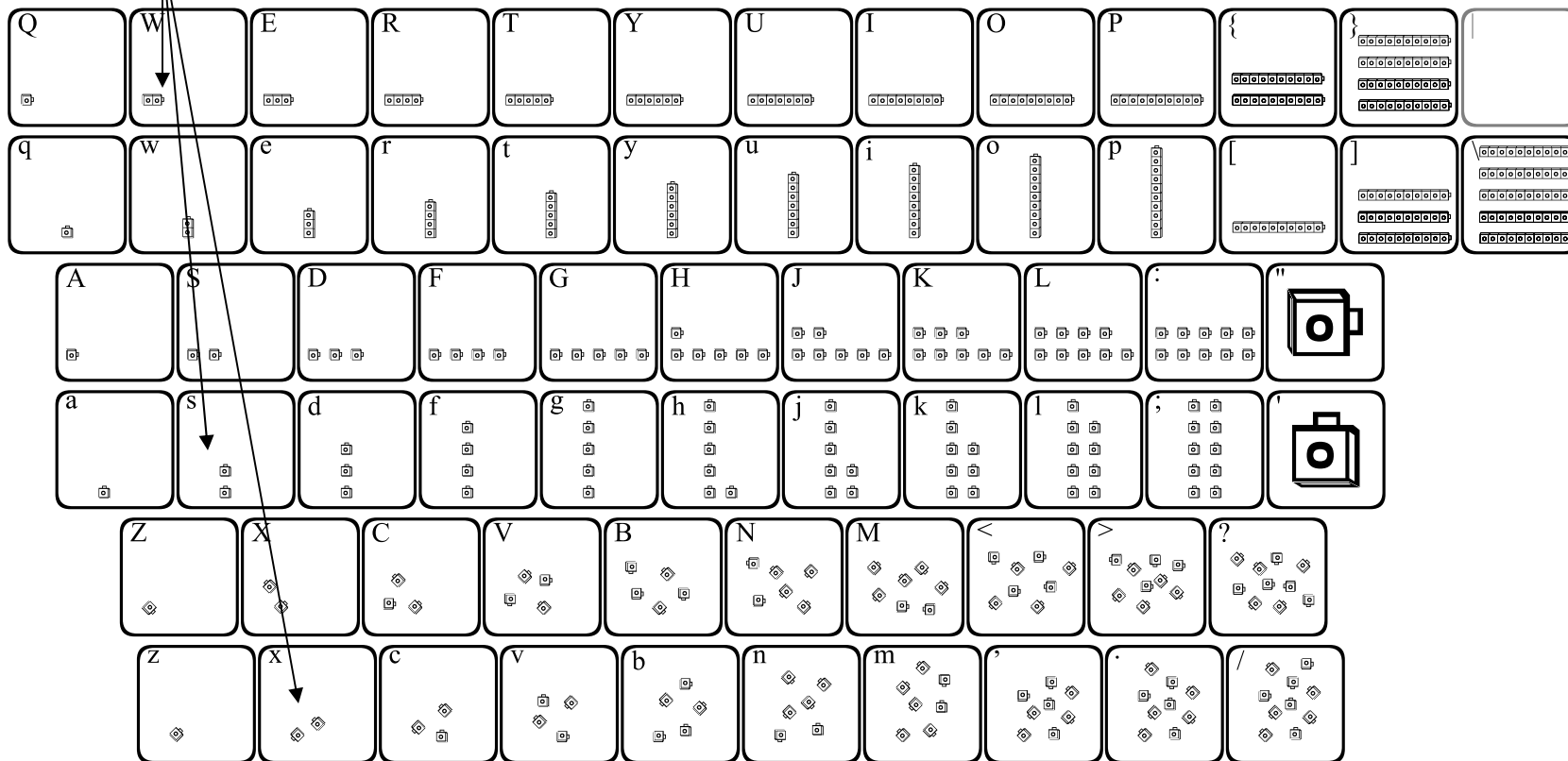

This font provides images of cubes that can be used in teaching number concepts and place value.

Each letter row shows the cubes in a certain formation in ascending order. By using the shift key with each letter row, you get the same number of cubes, but in a different formation.

The braces, brackets and backslash show groups of ten cubes (up to 5 groups stacked).

123CountingTiles1

May require 2 or more keystrokes.

- Arrows can be placed to overlap the 10-frames using the brackets [], braces { }, and slash \.

Type r|Y to make

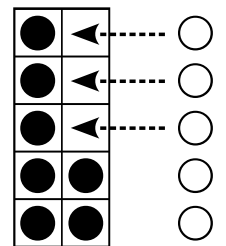

This font provides a variety of tiles with 10-frames. The lowercase keys show a 10-frame with a pre-set number of tiles, while the uppercase keys show tiles without the 10-frame.

The first row of letters uses circle tiles, the second row uses square tiles, and the last row uses triangle tiles.

Arrows can be placed with the bracket and bracer keys.

123CountingTiles2

Require 2 or more keystrokes.

- Place an empty 10-frame using the bar |, single quote ', or double quote ".
- Type any key to place tiles within the 10-frame.

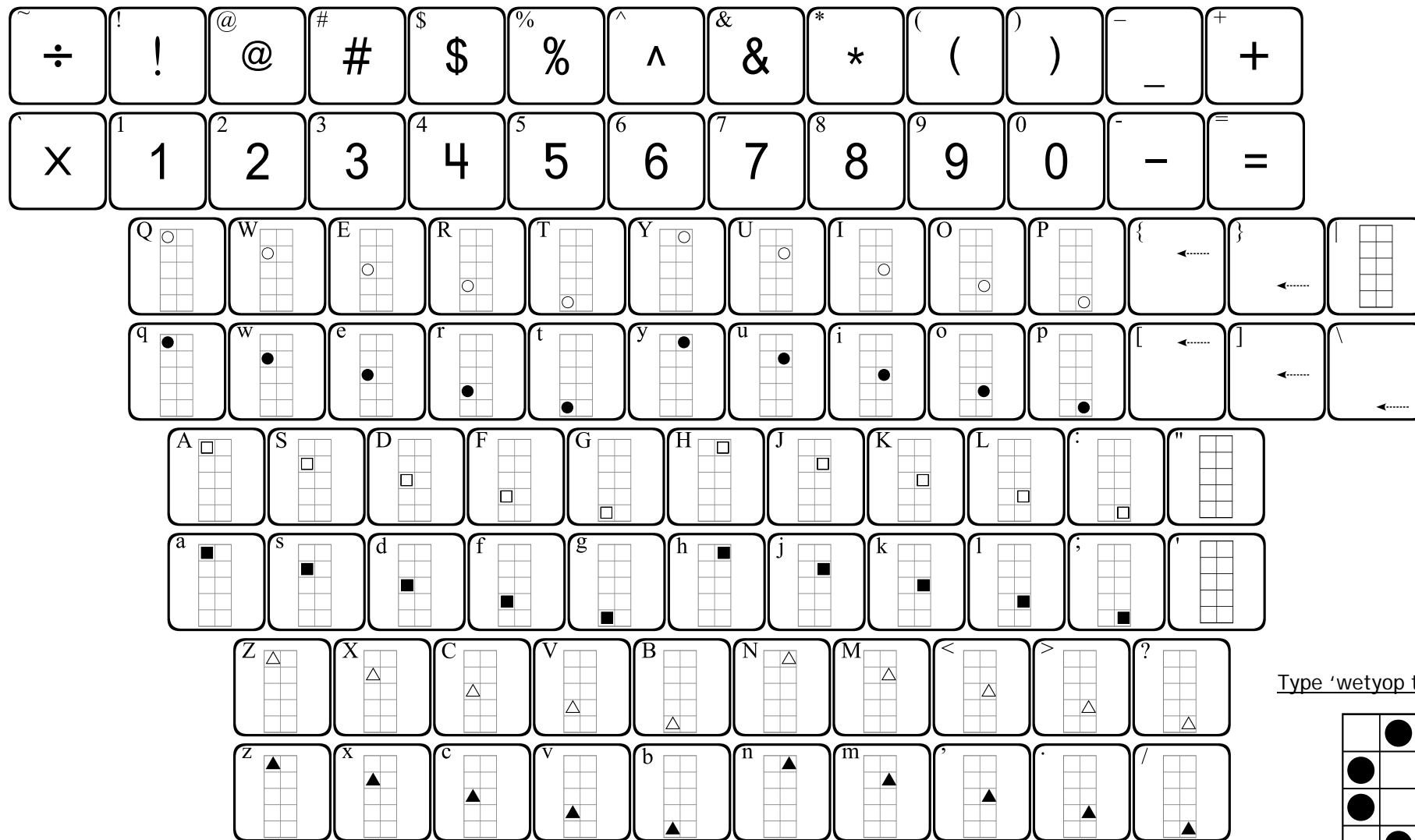

123CountingTiles2 allows you to place tiles in a variety of positions onto a 10-frame. You may first place a 10-frame using the bar (|) key, or the quotation keys (' ").

You may then place tiles anywhere you wish on the 10-frame. The tiles will overlap onto the 10-frame until you press the space bar several times.

The lowercase keys provide outlines of tiles, while the uppercase keys show solid tiles.

123Decimals

May require 2 or more keystrokes.

- When creating models with hundredths, use the lowercase qwerty row to first place a frame with the appropriate number of columns filled in.
- Use the uppercase QWERTY row to fill in the remaining hundredths.

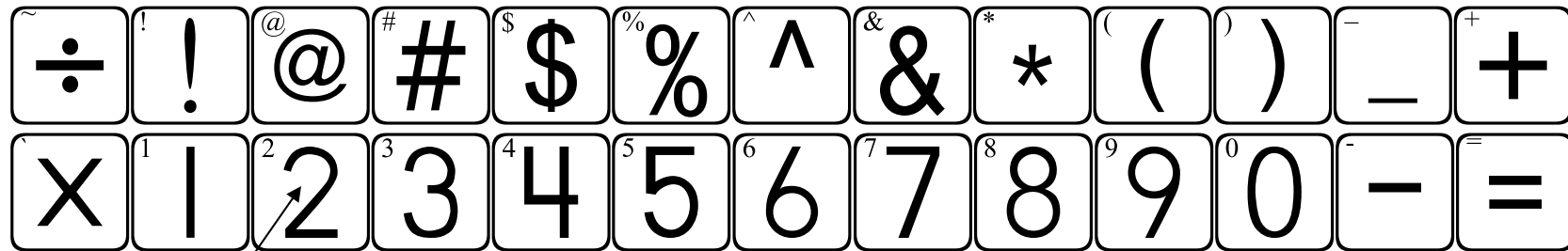

Frames are shown only for reference and do not appear when typing.

NOTE: The number of filled columns and individual blocks on each key is equivalent to the number key above it.

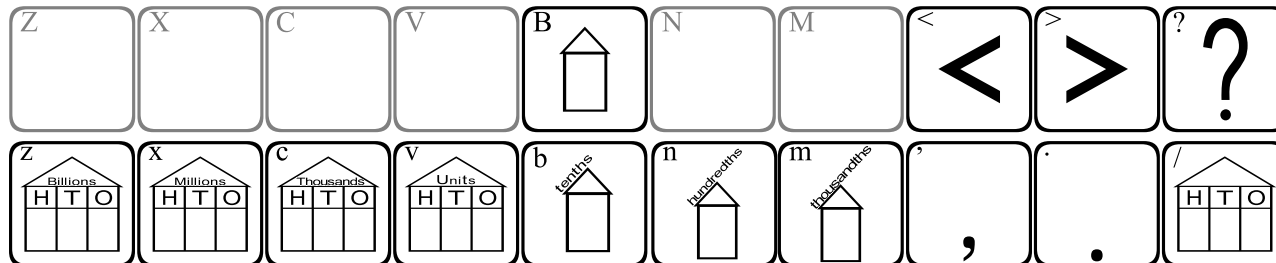
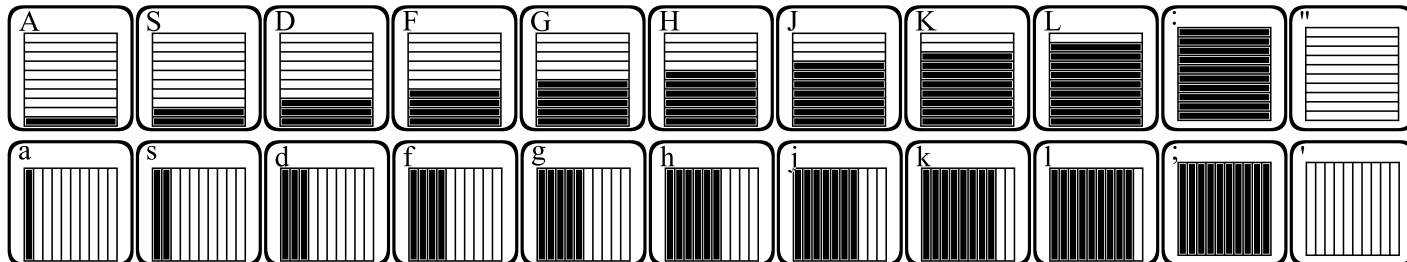
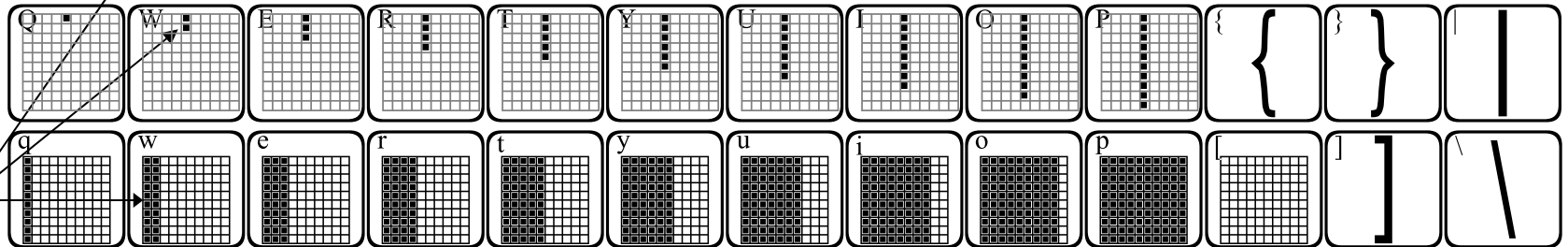

Type rU to make

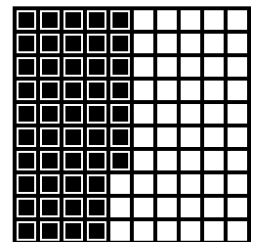

123Decimals can be used to create decimal models of tenths and hundredths.

To create hundredths, first type in the number of filled columns you need from the lowercase qwerty row. The image will appear, but the cursor will remain inside the frame. Next, type in the remaining hundredths that you need from the uppercase QWERTY row. They will appear in the inside the frame.

Tenths models are located on the asdf row.

123Dice

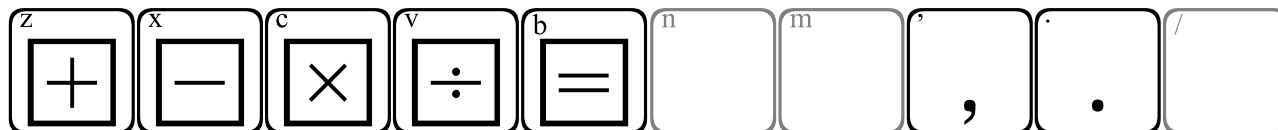
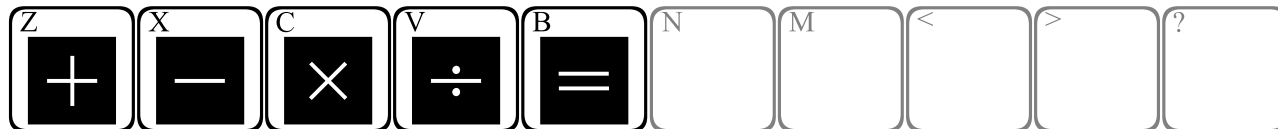
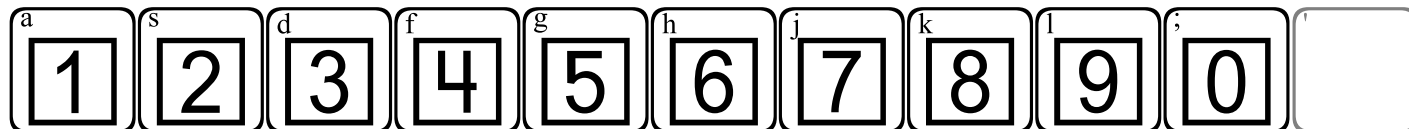
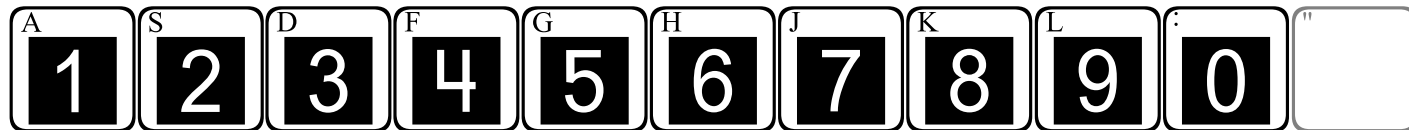
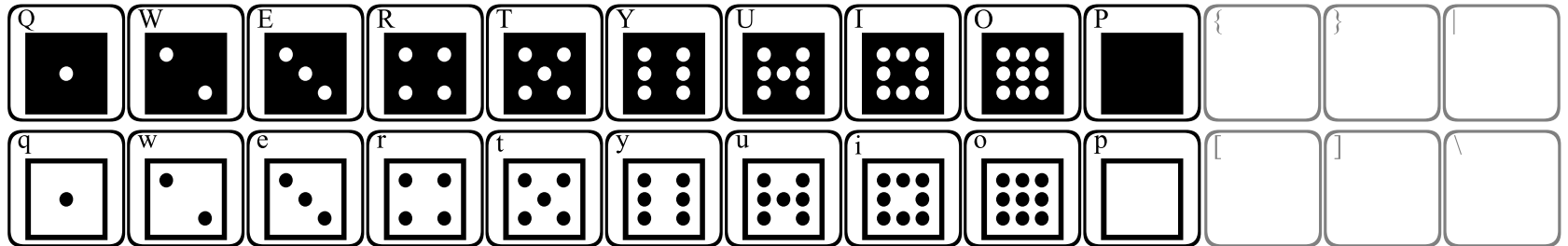
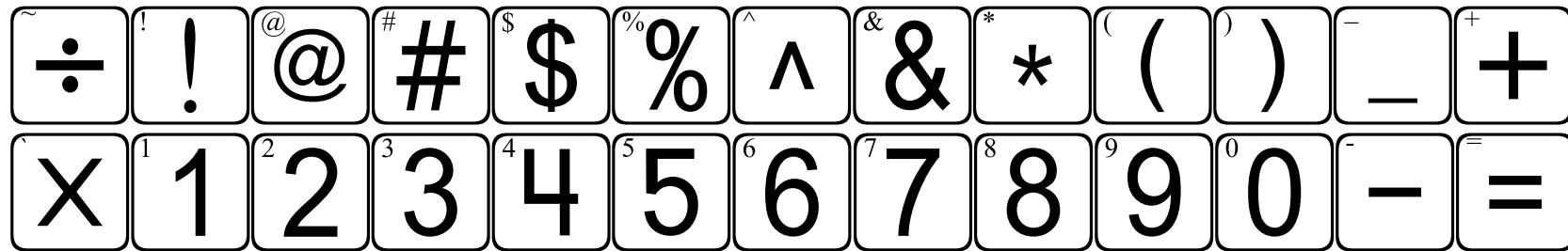

123Dominos1

Requires 2 or more keystrokes.

- Use the bracket keys to place the frame of a domino.
- Use the letter keys to place the dots on each portion of the domino.

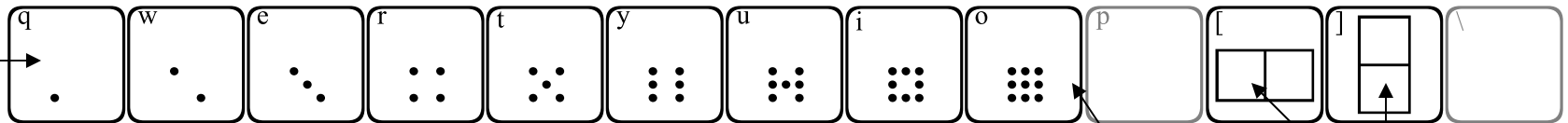
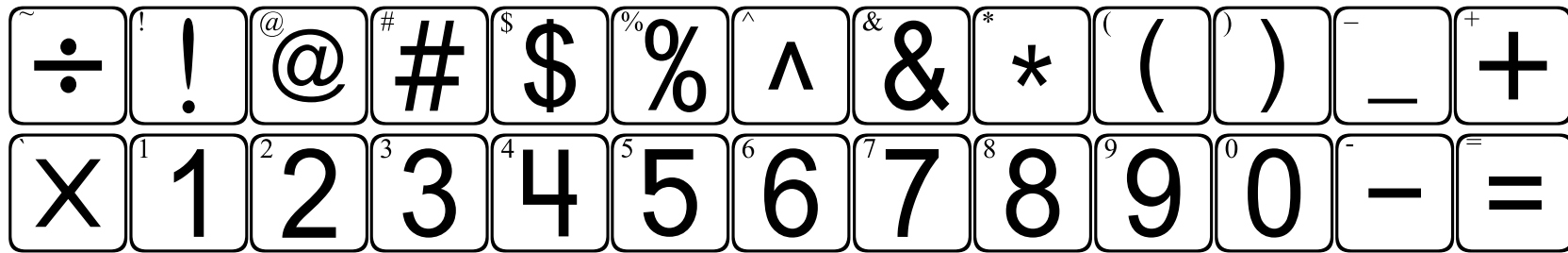

Use these keys to add the dots to horizontal dominos.

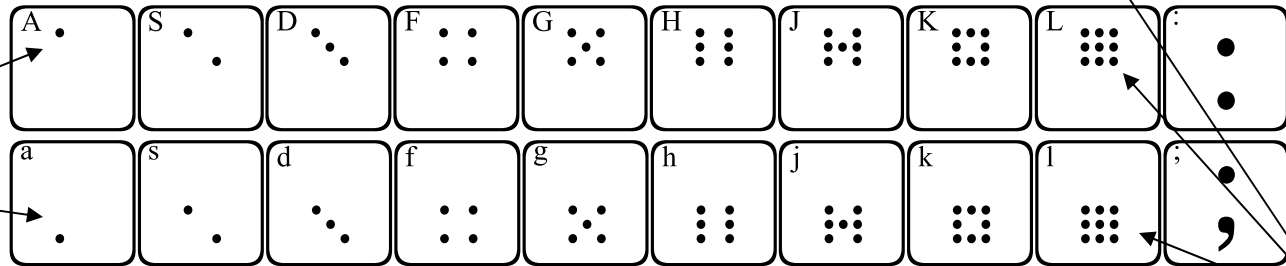

Use these keys to add the dots to vertical dominos.

Bottom of domino

Place one of the domino frames *first!*

Then place the dots in each portion!

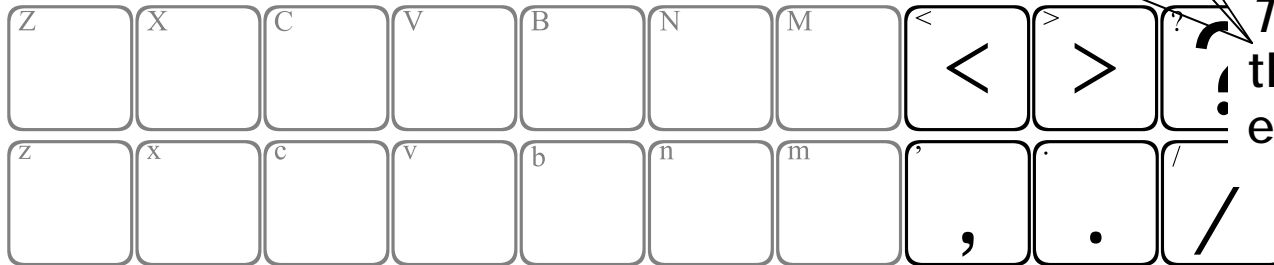

To create a domino, first place a frame using one of the bracket keys. The left bracket [places a domino in a horizontal position, and the right bracket] creates a vertical domino. After placing a domino frame, the cursor will remain inside the frame, allowing you to place any number of pips (dots) onto the domino.

For horizontal dominos, use the lowercase qwerty row of keys. If you want to leave the left half of the domino blank, just press the space bar one time. You will then be able to place dots on the right half.

For vertical dominos, use the asdf row of keys. The lowercase keys place dots on the bottom half of the domino, while the uppercase keys place dots on the top half of the domino.

123Dominos2

Requires 2 or more keystrokes.

- Use the bracket keys to place the frame of a domino.
- Use the letter keys to place numbers on each portion of the domino.

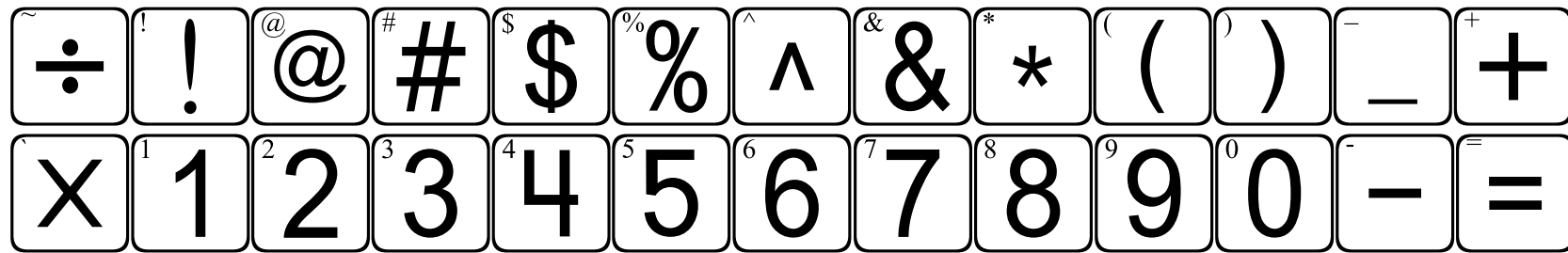

Use these keys to add numbers to horizontal dominos.

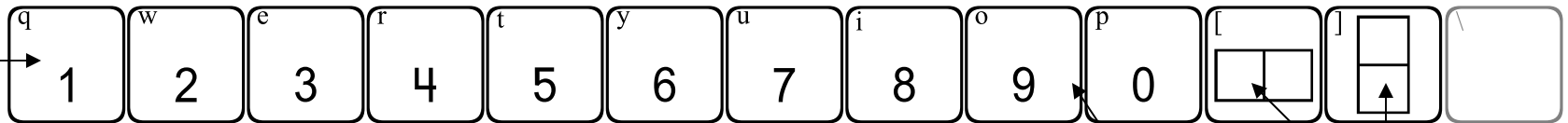

Top of domino

Use these keys to add numbers to vertical dominos.

Bottom of domino

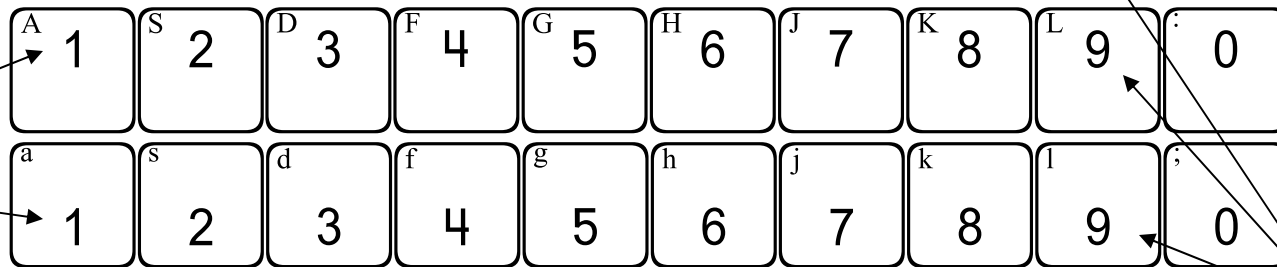

Place one of the domino frames *first!*

Then place numbers in each portion!

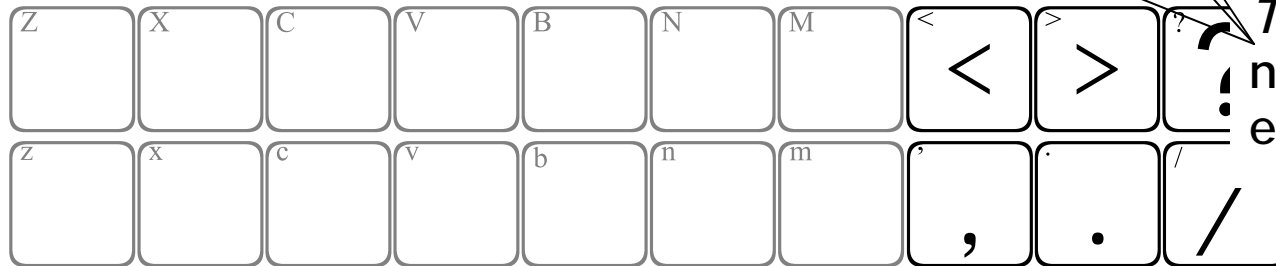

To create a domino, first place a frame using one of the bracket keys. The left bracket [places a domino in a horizontal position, and the right bracket] creates a vertical domino. After placing a domino frame, the cursor will remain inside the frame, allowing you to place any digit onto the domino.

For horizontal dominos, use the lowercase qwerty row of keys. If you want to leave the left half of the domino blank, just press the space bar one time. You will then be able to place a number on the right half.

For vertical dominos, use the asdf row of keys. The lowercase keys place numbers on the bottom half of the domino, while the uppercase keys place numbers on the top half of the domino.

123FractionCircles

May require 2 or more keystrokes.

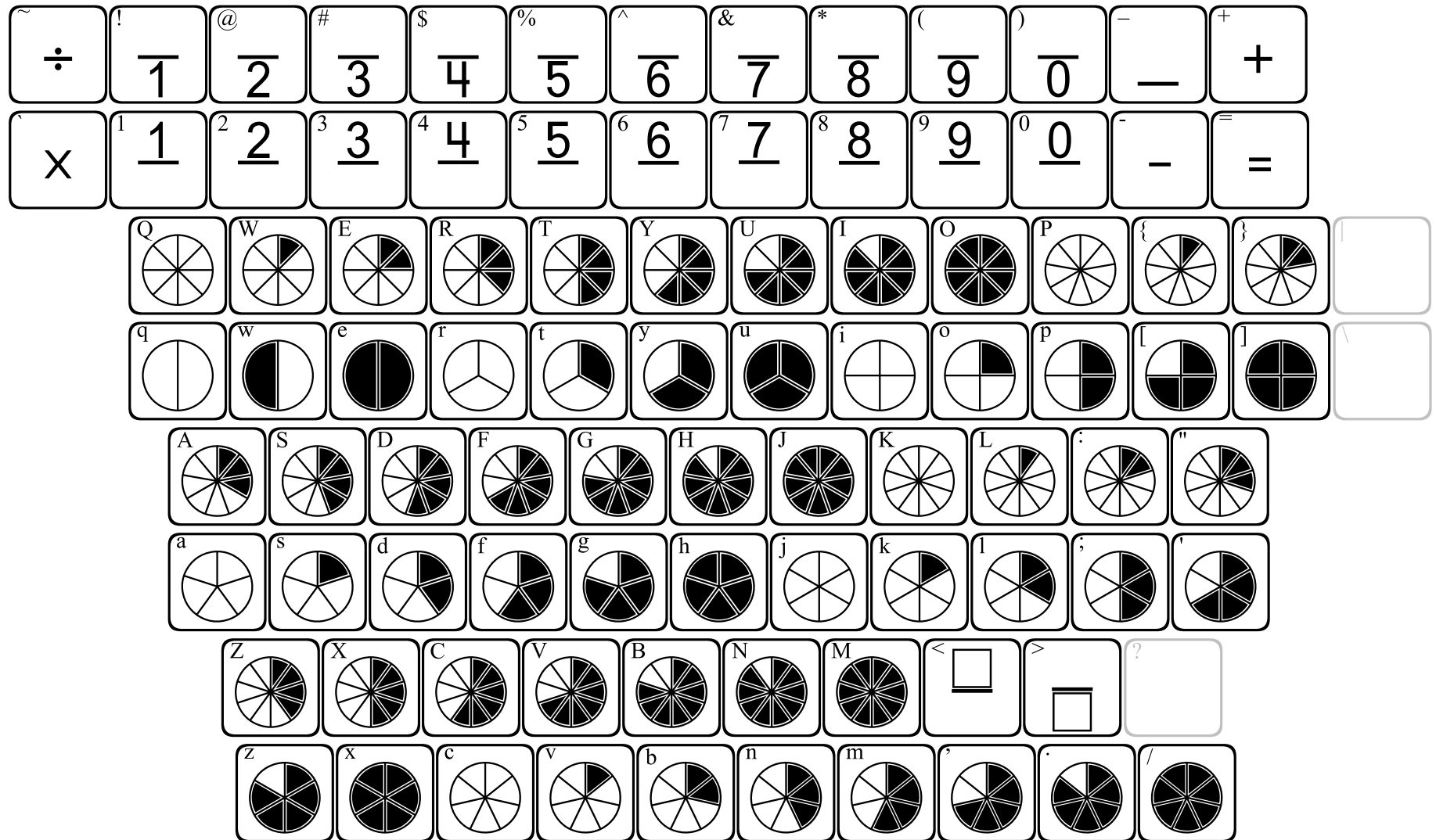

To create fractions with...

an equal number of digits in the numerator and denominator...

- Select a fraction font and size.
- Type the 1st digit of the numerator.
- Press SHIFT and type the 1st digit of the denominator.
- Press the space bar 2 times (previously just one time).
- Repeat the steps for next digit.

2-digit denominator and 1-digit numerator...

- Select a fraction font and size.
- Start with the denominator.
- Press SHIFT and type first digit of the denominator.
- Press the space bar 1 time.
- Type the number for the numerator.
- Press the space bar 1 time.
- Press SHIFT and type the second digit of the denominator.
- Repeat the steps to extend the fraction further.

2-digit numerator and 1-digit denominator...

- Select a fraction font and size.
- Start with the numerator.
- Type first digit of the numerator.
- Press the space bar 1 time.
- Press SHIFT and type the number for the denominator.
- Press the space bar 1 time.
- Type the second digit of the numerator.
- Repeat the steps to extend the fraction further.

123FractionRectangles

May require 2 or more keystrokes.

To create fractions with...

an equal number of digits in the numerator and denominator...

- Select a fraction font and size.
- Type the 1st digit of the numerator.
- Press SHIFT and type the 1st digit of the denominator.
- Press the space bar 2 times (previously just one time).
- Repeat the steps for next digit.

2-digit denominator and 1-digit numerator...

- Select a fraction font and size.
- Start with the denominator.
- Press SHIFT and type first digit of the denominator.
- Press the space bar 1 time.
- Type the number for the numerator.
- Press the space bar 1 time.
- Press SHIFT and type the second digit of the denominator.
- Repeat the steps to extend the fraction further.

2-digit numerator and 1-digit denominator...

- Select a fraction font and size.
- Start with the numerator.
- Type first digit of the numerator.
- Press the space bar 1 time.
- Press SHIFT and type the number for the denominator.
- Press the space bar 1 time.
- Type the second digit of the numerator.
- Repeat the steps to extend the fraction further.

123Fractions

May require 2 or more keystrokes.

NOTE: The subdivisions and groupings on each key are equivalent to the number key at the top of the keyboard.

To create fractions with...

2-digit denominator and 1-digit numerator...

2-digit numerator and 1-digit denominator...

an equal number of digits in the numerator and denominator...

- Select a fraction font and size.
- Start with the denominator.
- Press SHIFT and type first digit of the denominator.
- Press the space bar 1 time.
- Type the number for the numerator.
- Press the space bar 1 time.
- Press SHIFT and type the second digit of the denominator.
- Repeat the steps to extend the fraction further.

- Select a fraction font and size.
- Start with the numerator.
- Type first digit of the numerator.
- Press the space bar 1 time.
- Press SHIFT and type the number for the denominator.
- Press the space bar 1 time.
- Type the second digit of the numerator.
- Repeat the steps to extend the fraction further.

- Select a fraction font and size.
- Type the 1st digit of the numerator.
- Press SHIFT and type the 1st digit of the denominator.
- Press the space bar 2 times (previously just one time).
- Repeat the steps for next digit.

123Fractions2

May require 2 or more keystrokes.

Fraction models range from $\frac{0}{2}$ to $\frac{6}{6}$.

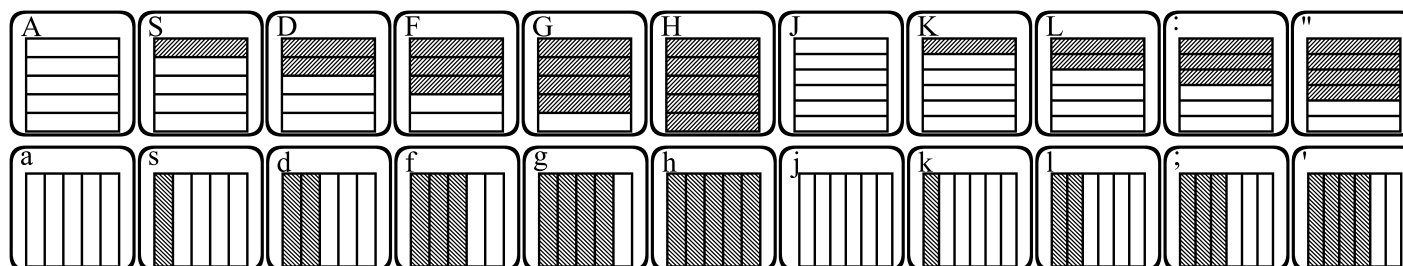
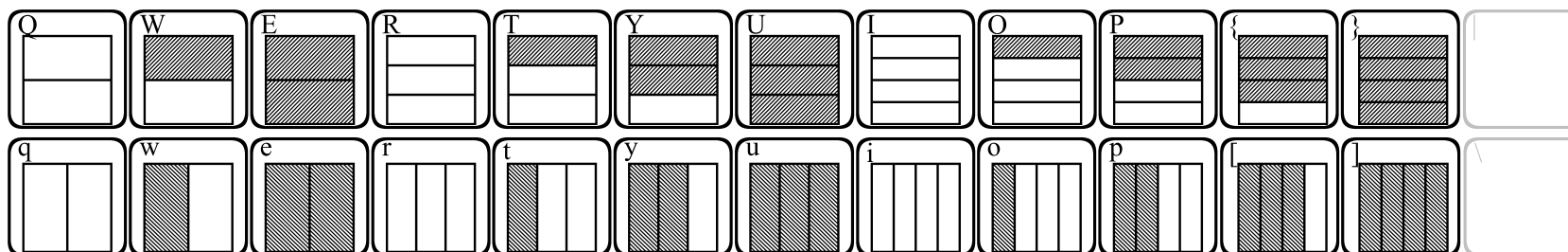
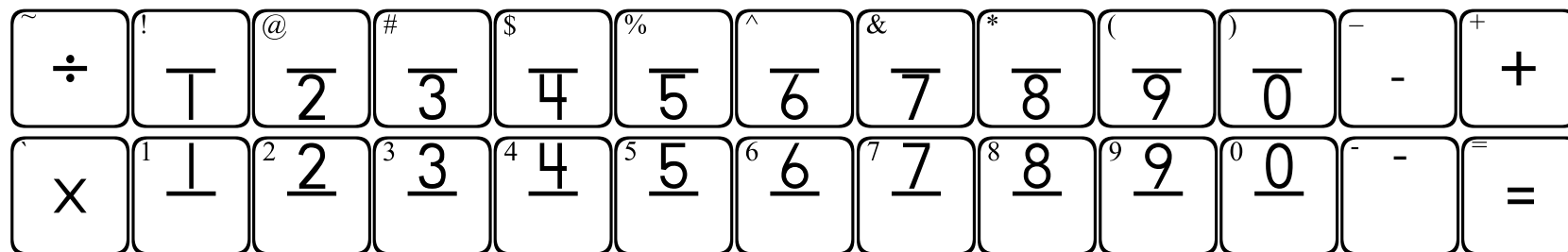

See 123Fractions on page 25 for steps to create numeric fractions.

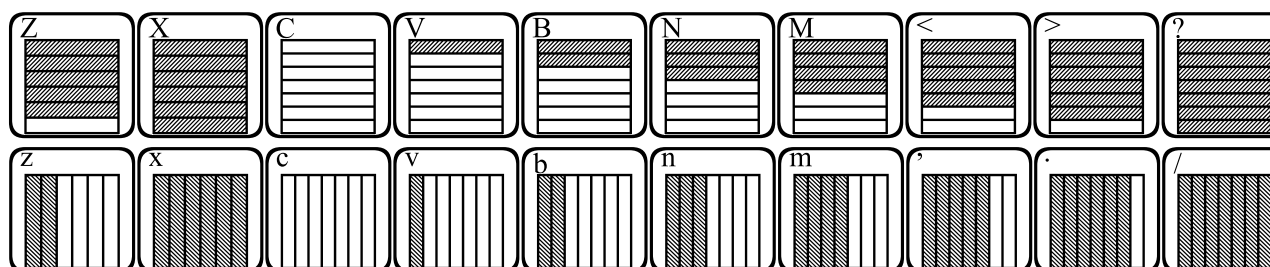

Type wY to make

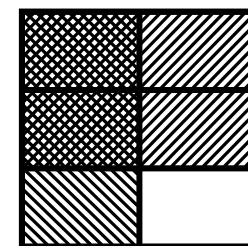

to show $\frac{1}{2} \times \frac{2}{3} = \frac{2}{6}$

123Fractions2 and 123Fractions3 can be used to model multiplication with fractions. Typing any 2 keys (1 lowercase and 1 uppercase) will cause the fraction models to overlap, and the resulting intersection shows the product. Note that each lowercase key provides a fraction model, while each uppercase key shows the same model rotated 90°.

It will be necessary to press the space bar several times after you have created your model. Alternately, you can press the slash \ key to advance the cursor the full length of a fraction model.

123Fractions3

May require 2 or more keystrokes.

Fraction models range from $\frac{1}{2}$ to $\frac{10}{10}$.

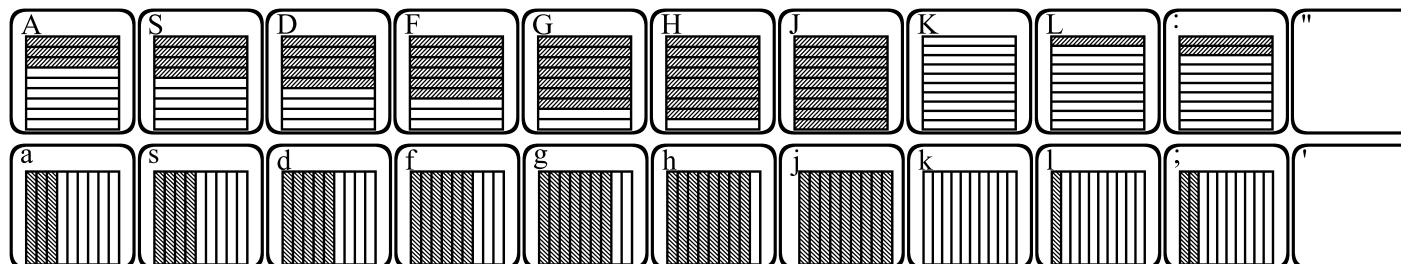
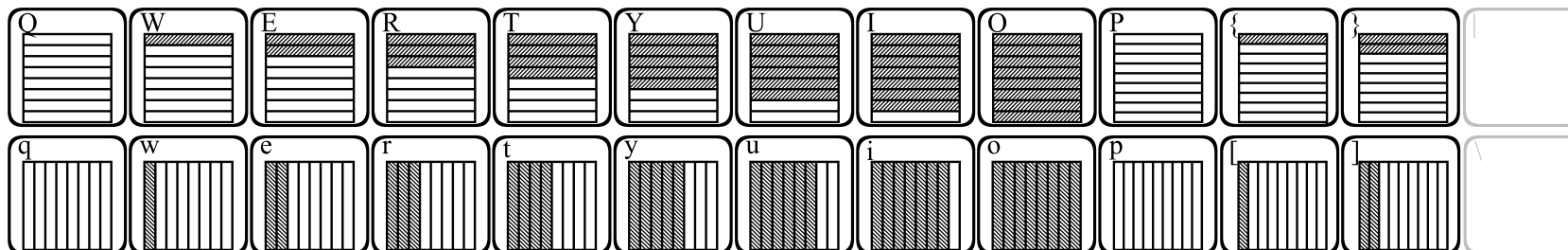
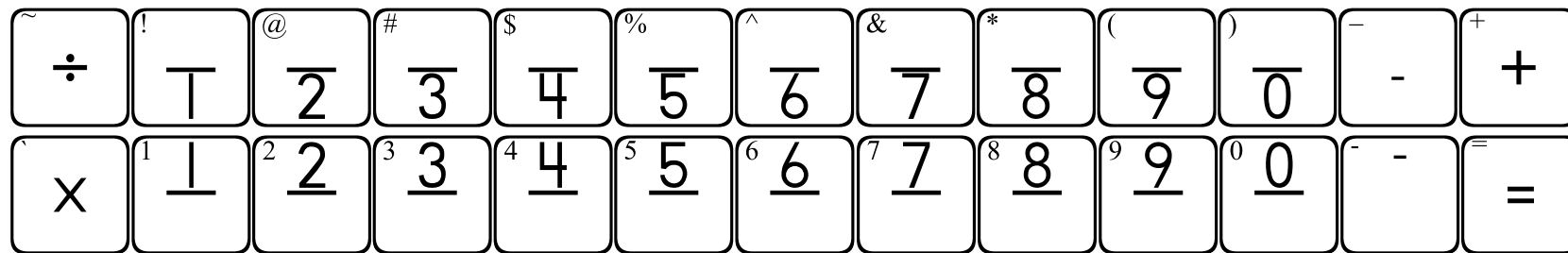

See 123Fractions on page 25 for steps to create numeric fractions.

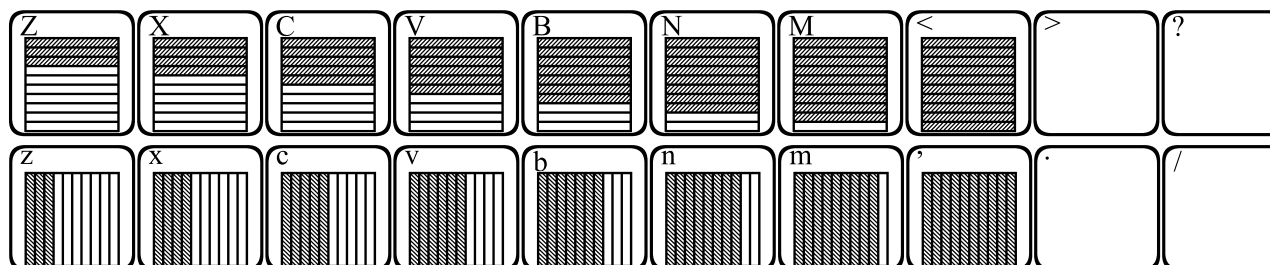

Type wY to make

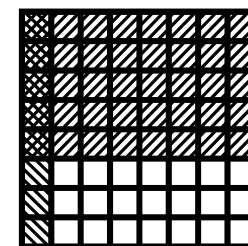

to show $\frac{4}{5} \times \frac{4}{5} = \frac{16}{25}$

123Fractions2 and 123Fractions3 can be used to model multiplication with fractions. Typing any 2 keys (1 lowercase and 1 uppercase) will cause the fraction models to overlap, and the resulting intersection shows the product. Note that each lowercase key provides a fraction model, while each uppercase key shows the same model rotated 90°.

It will be necessary to press the space bar several times after you have created your model. Alternately, you can press the slash \ key to advance the cursor the full length of a fraction model.

123FractionSquares

May require 2 or more keystrokes.

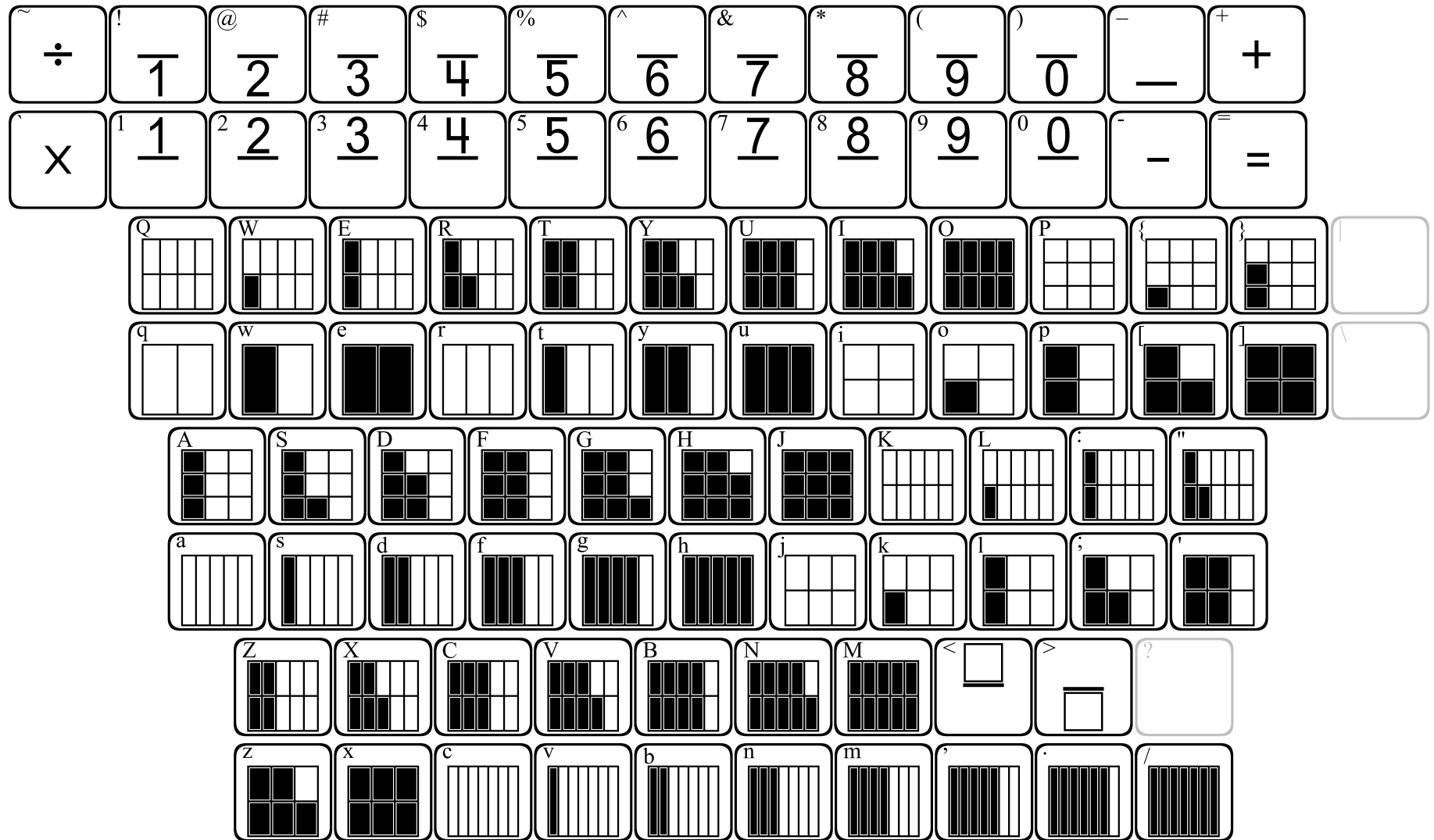

To create fractions with...

an equal number of digits in the numerator and denominator...

- Select a fraction font and size.
- Type the 1st digit of the numerator.
- Press SHIFT and type the 1st digit of the denominator.
- Press the space bar 2 times (previously just one time).
- Repeat the steps for next digit.

2-digit denominator and 1-digit numerator...

- Select a fraction font and size.
- Start with the denominator.
- Press SHIFT and type first digit of the denominator.
- Press the space bar 1 time.
- Type the number for the numerator.
- Press the space bar 1 time.
- Press SHIFT and type the second digit of the denominator.
- Repeat the steps to extend the fraction further.

2-digit numerator and 1-digit denominator...

- Select a fraction font and size.
- Start with the numerator.
- Type first digit of the numerator.
- Press the space bar 1 time.
- Press SHIFT and type the number for the denominator.
- Press the space bar 1 time.
- Type the second digit of the numerator.
- Repeat the steps to extend the fraction further.

123Geometry1

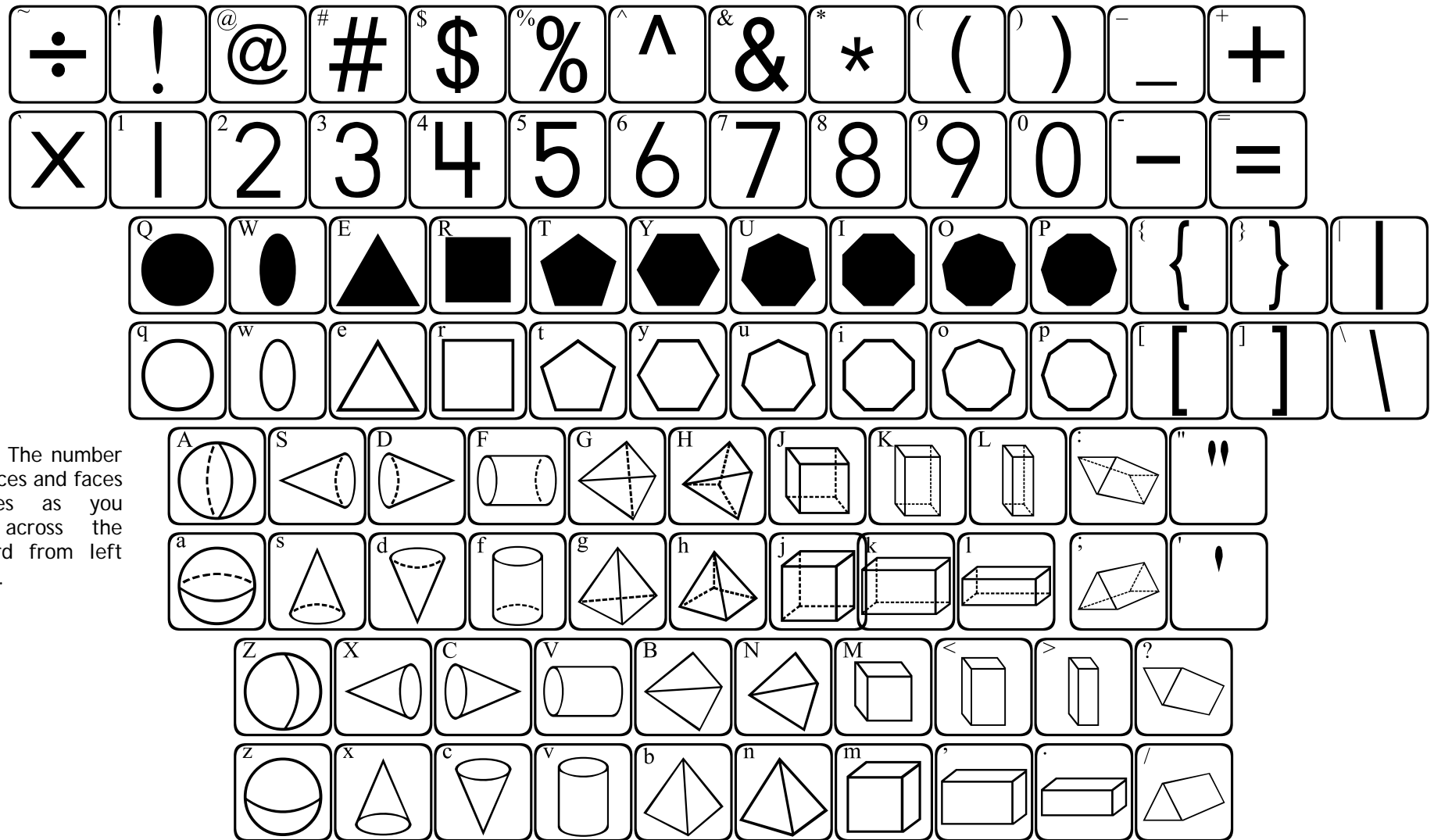

NOTE: The number of vertices and faces increases as you move across the keyboard from left to right.

123Geometry1 contains representations of many types of polygons and solids. The qwerty row of letters shows plane figures. The lowercase keys provide outlines of the shapes, while the uppercase keys provide the same shape completely filled in.

The remaining rows contain images of solid figures. Shapes are provided on each lowercase key, with the same shape in a different position on the uppercase keys.

123Geometry2

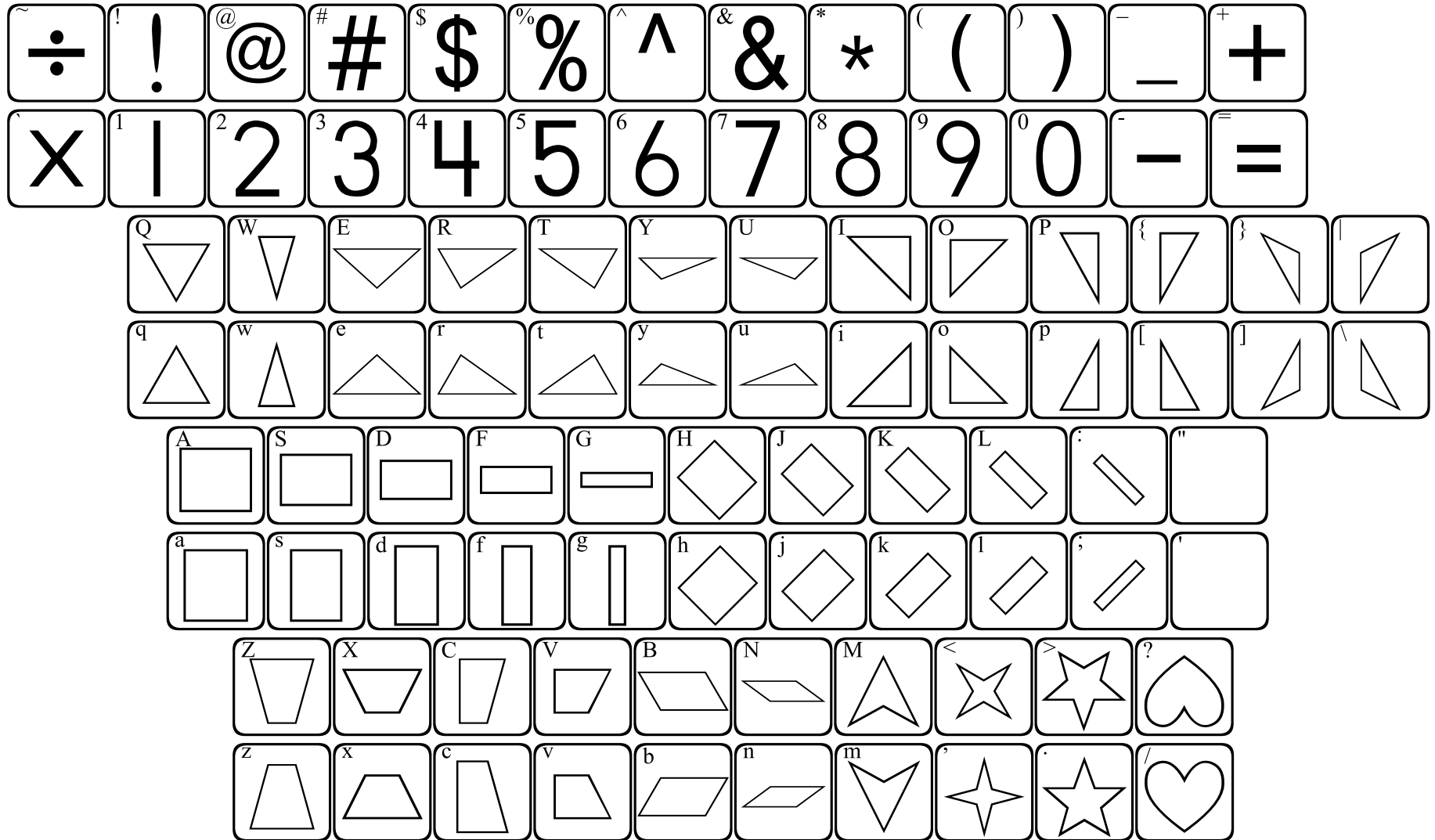

This font supplies a variety of geometric shapes. The first row of letters provides triangles, the second row provides rectangles, while the last row contains an assortment of shapes.

The lowercase keys will show each shape in one position, while the uppercase keys show the same shape in a different position.

123MathSymbols

May require 2 or more keystrokes.

~	!	@	#	\$	%	^	&	*	()	-	+
÷		2	3	4	5	6	7	8	9	0	-	+
×	¹	² 2	³ 3	⁴ 4	⁵ 5	⁶ 6	⁷ 7	⁸ 8	⁹ 9	⁰ 0	-	=
^Q 1	^W 2	^E 3	^R 4	^T 5	^Y 6	^U 7	^I 8	^O 9	^P 0	{	}	
^q √	^w √	^e √	^r √	^t √	^y □	^u □	ⁱ □	^o □	^p □	[]	\
^A □	^S □	^D □	^F □	^G	^H	^J	^K	^L □	:	"	"	"
□	Billions	Millions	Thousands					□	:	"	"	"
^a √	^s √	^d √	^f √	^g √	^h ○	^j ≈	^k ≤	^l ≥	;	'	'	'
^Z □	^X □	^C □	^V ∕	^B ∕	^N □	^M □	<	>	?	?	?	?
^z π	^x ∅	^c ¢	^v ∩	^b ∩	ⁿ €	^m €	,	.	/	/	/	/

Type 3e402 to make

$$3\overline{)402}$$

Type 4% to make

$$4^5$$

This font contains a variety of useful symbols.

Long division and square root: Type the appropriate symbol using the q w e r t keys, or the a s d f g keys. Next, type the numbers, which will appear under the bar of the symbol you are using. You can place up to 5 digits under the bar.

Superscript: Pressing SHIFT and a number will cause the number to appear in a raised position as an exponent. You can also use the underscore key to add a negative sign to an exponent.

123Mayan

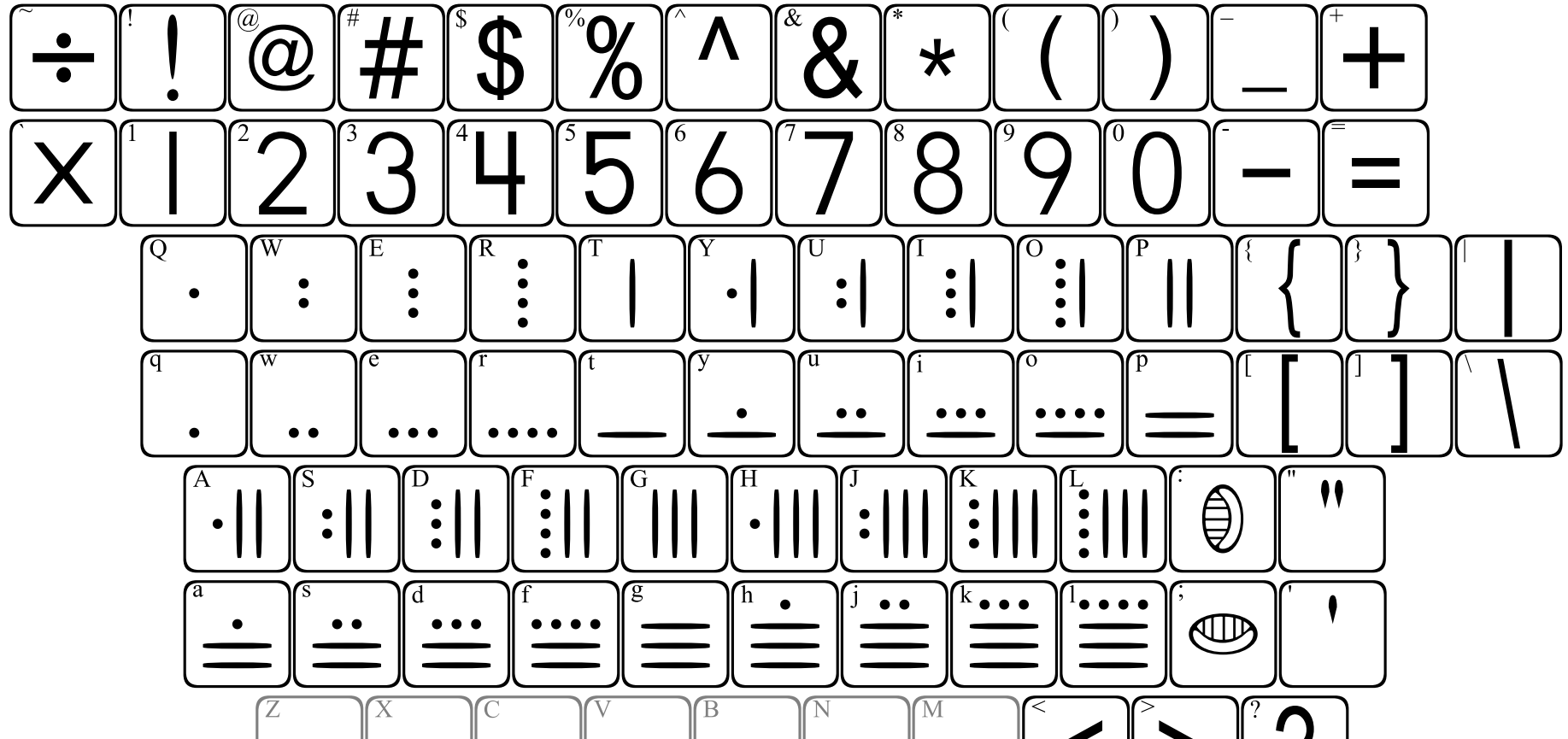

Mayan numerals are built on a base-20 system. Each dot represents 1, while each line represents 5. The "eye" represents 0 (zero).

.	= 1	..	= 2	...	= 3	= 4	_	= 5
⋅	= 6	⋆	= 7	⋇	= 8	⋈	= 9	≡	= 10
⋉	= 11	⋊	= 12	⋋	= 13	⋌	= 14	≡	= 15
⋍	= 16	⋎	= 17	⋏	= 18	⋐	= 19	👁	= 0

123Money

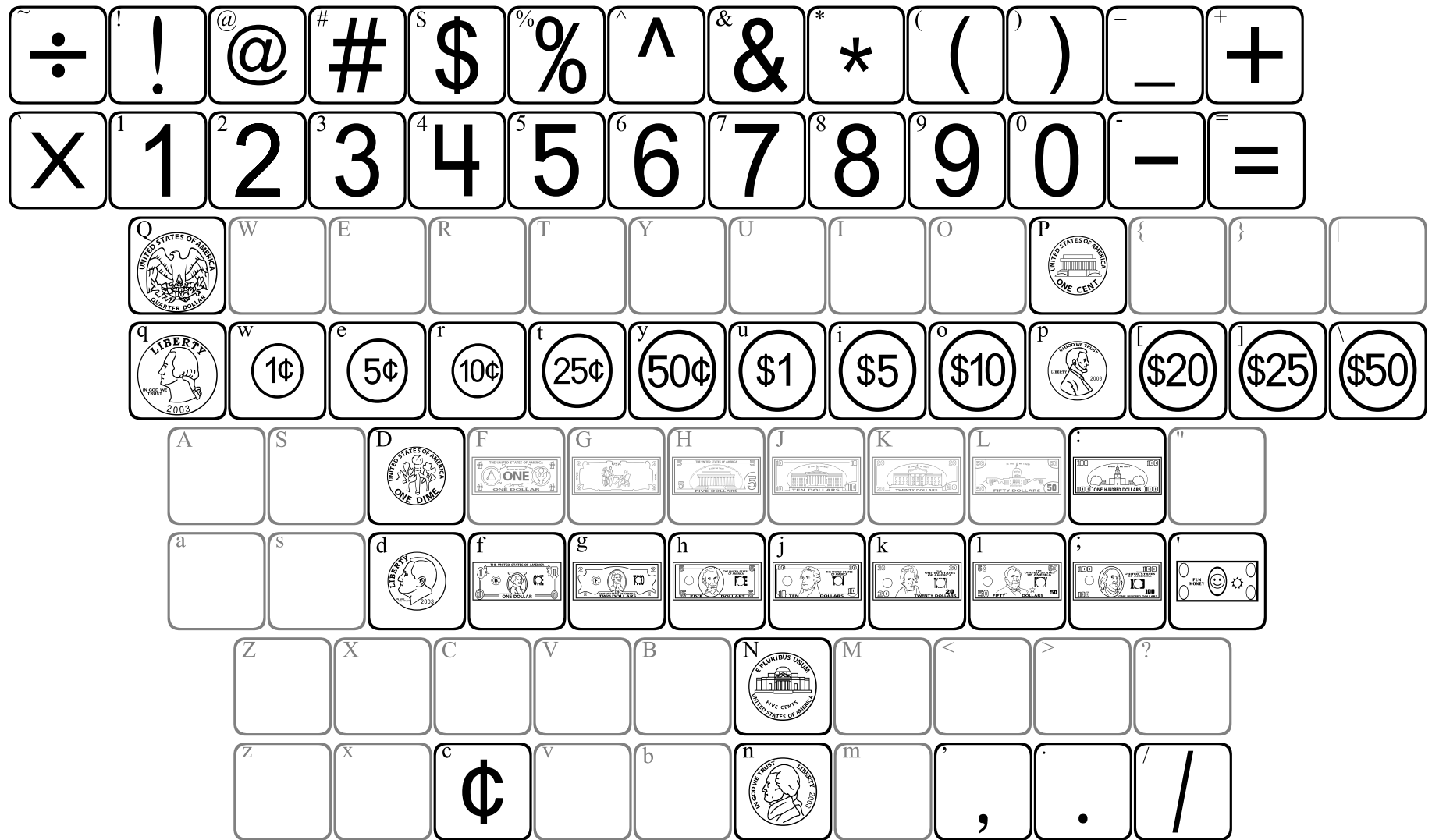

This font shows pennies, nickels, dimes and quarters, both heads and tails. Each coin can be found on the key with its beginning letter ("p" for penny, "n" for nickel, "d" for dime and "q" for quarter). Pressing the shift key with each letter will show you the back side of each coin.

Representations of paper currency begin on the "f" key with a 1 dollar bill, with the value of the bills increasing as you move across the keyboard from left to right. Pressing the shift key with each letter will show you the back side of the bill.

123Money2

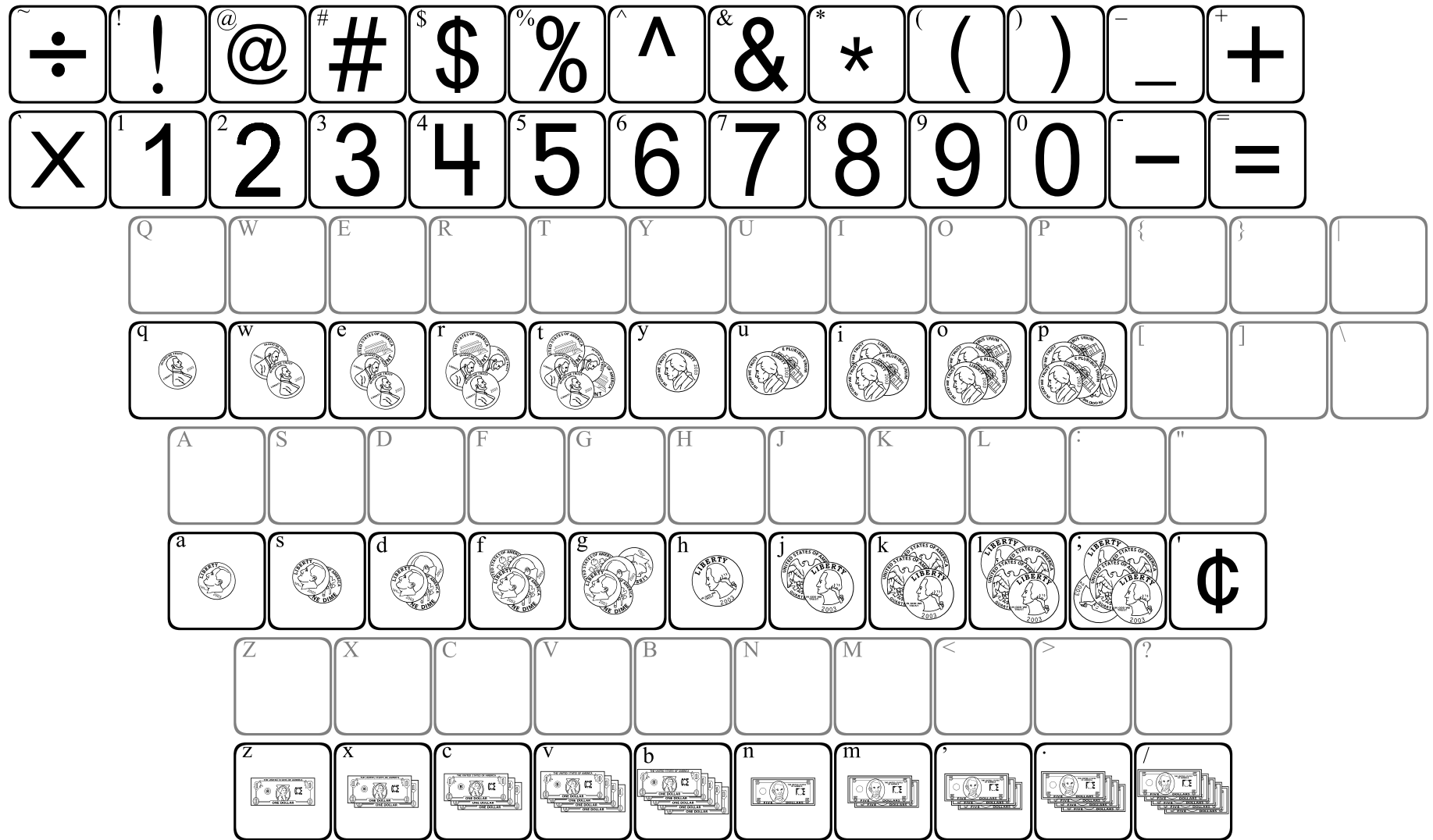

123Money2 shows coins and bills in sets off 1, 2, 3, 4 and 5. The value increases as you move across the keyboard from left to right.

123Nets1

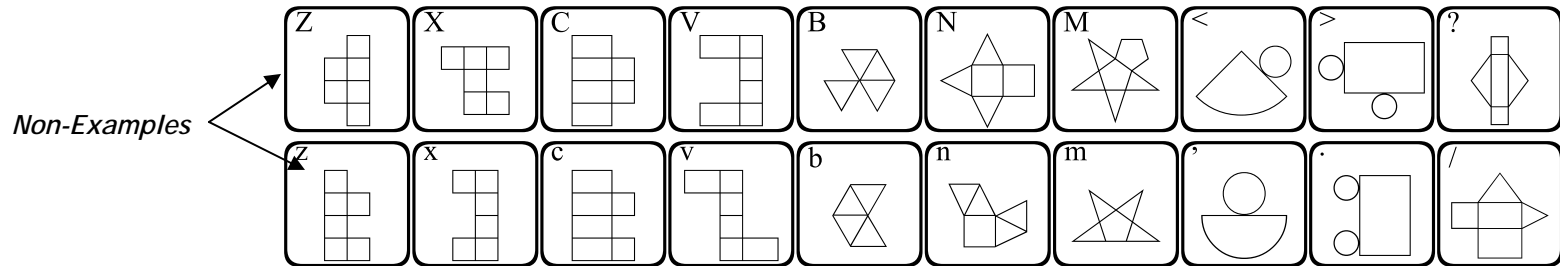
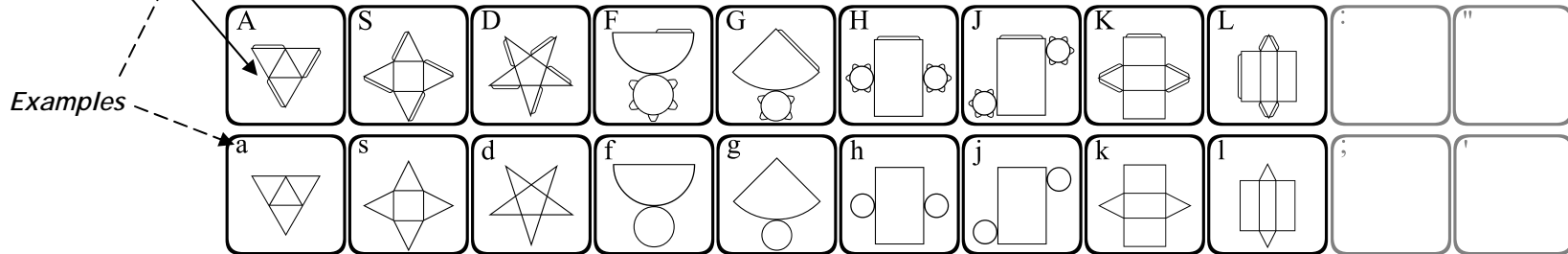
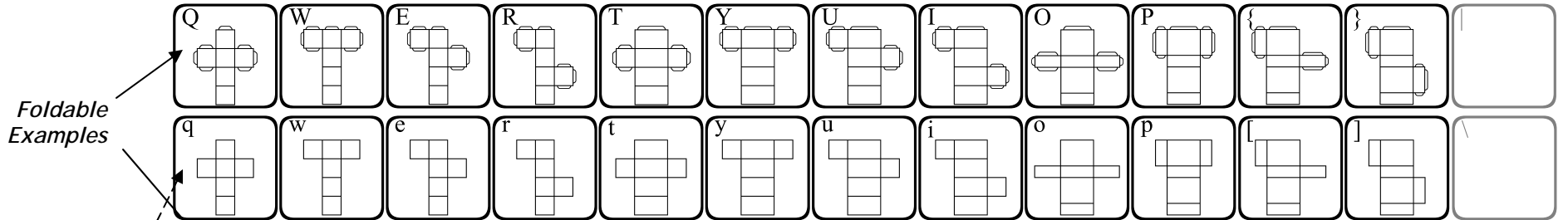
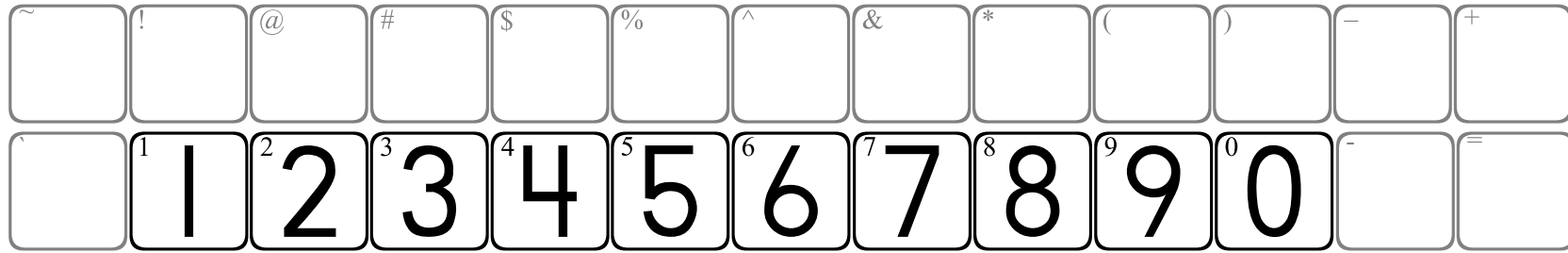

123NumberLines

May require 2 or more keystrokes.

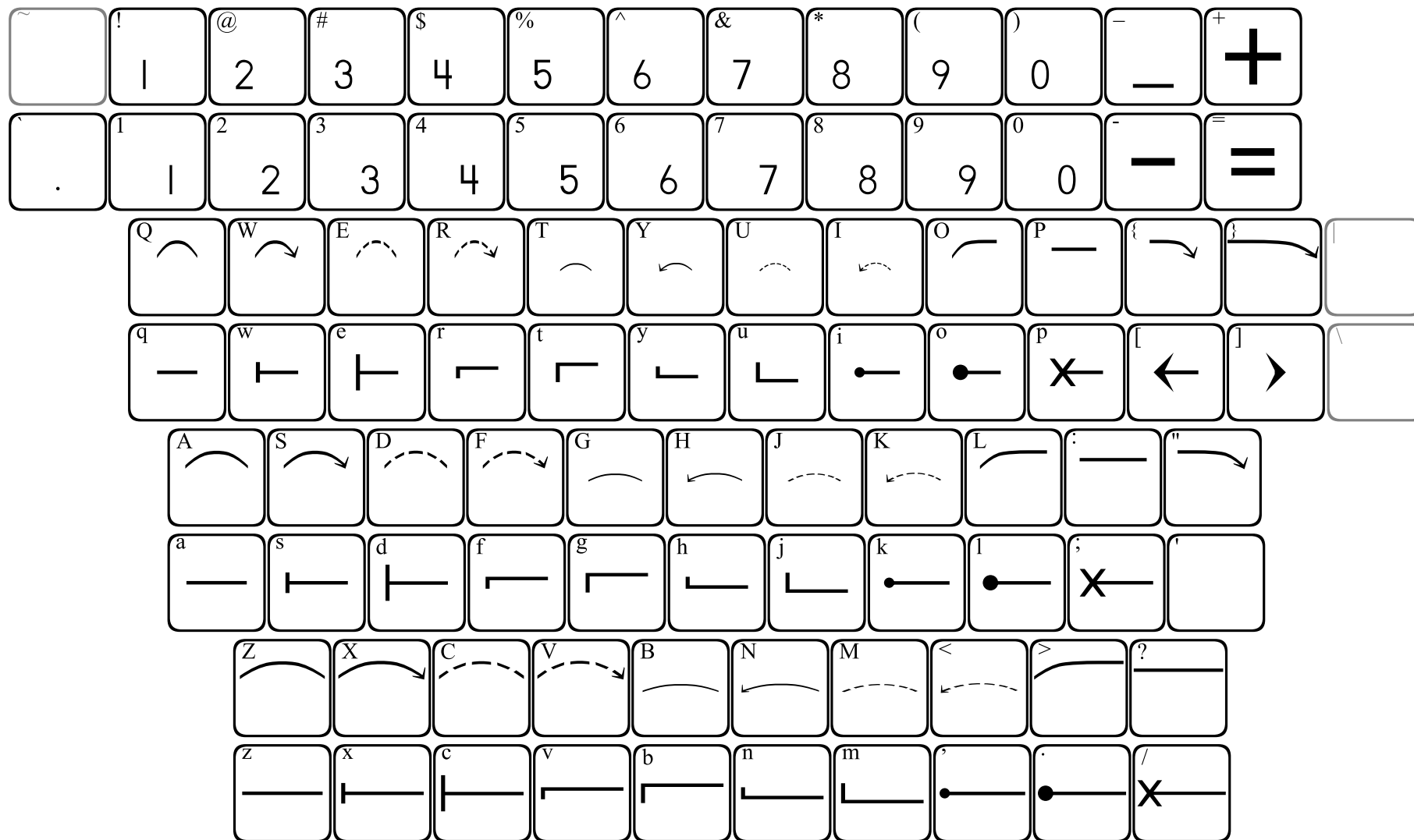

123NumberLines can be used to create number lines with 3 different spacings. Choose the spacing and style you would like, then press the appropriate key repeatedly until your number line is the length you wish.

Type
[0 d L 1 d : 2 d K : 3 d J " 4 d]
to make

The arrows can be used to show "bounces" for addition and subtraction, but each arrow should be placed just *after* each section of the number line is constructed.

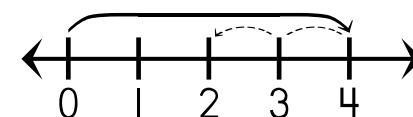

Numbers up to 99 can be placed beneath a number line, but must be placed just *before* each section of the number line is constructed.

123PatternBlocks

May require 2 or more keystrokes.

Overlapping blocks

Preset combinations

123PatternBlocks allows you to place standard pattern blocks into a variety of positions. On each row of letters, the lowercase letters place an outline of a block, while the uppercase keys place the same blocks in solid forms. The color of each block can be formatted individually if you would like to make them match actual pattern blocks.

The first row of letters (qwerty) allows you to place blocks in overlapping positions. When using this row of keys, the cursor will not advance until you press the spacebar.

The second row of letters provides preset combinations of blocks. The last row provides each pattern block individually.

123PlaceValue2D

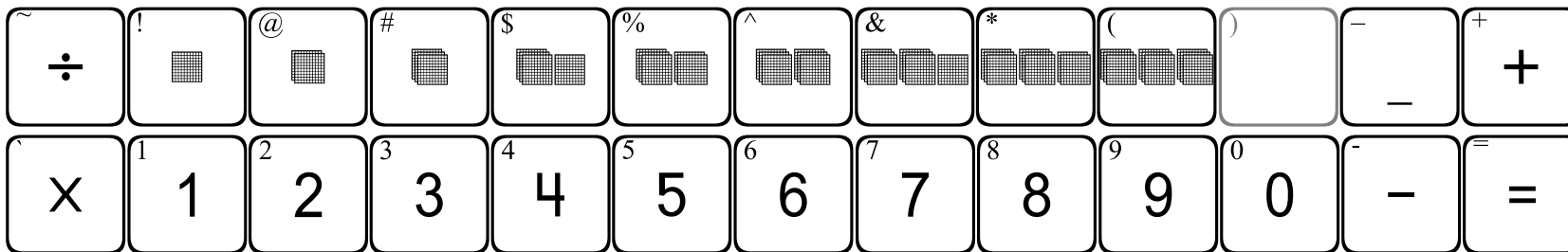

NOTE: The number of items on each letter key is equal to the number key above it.

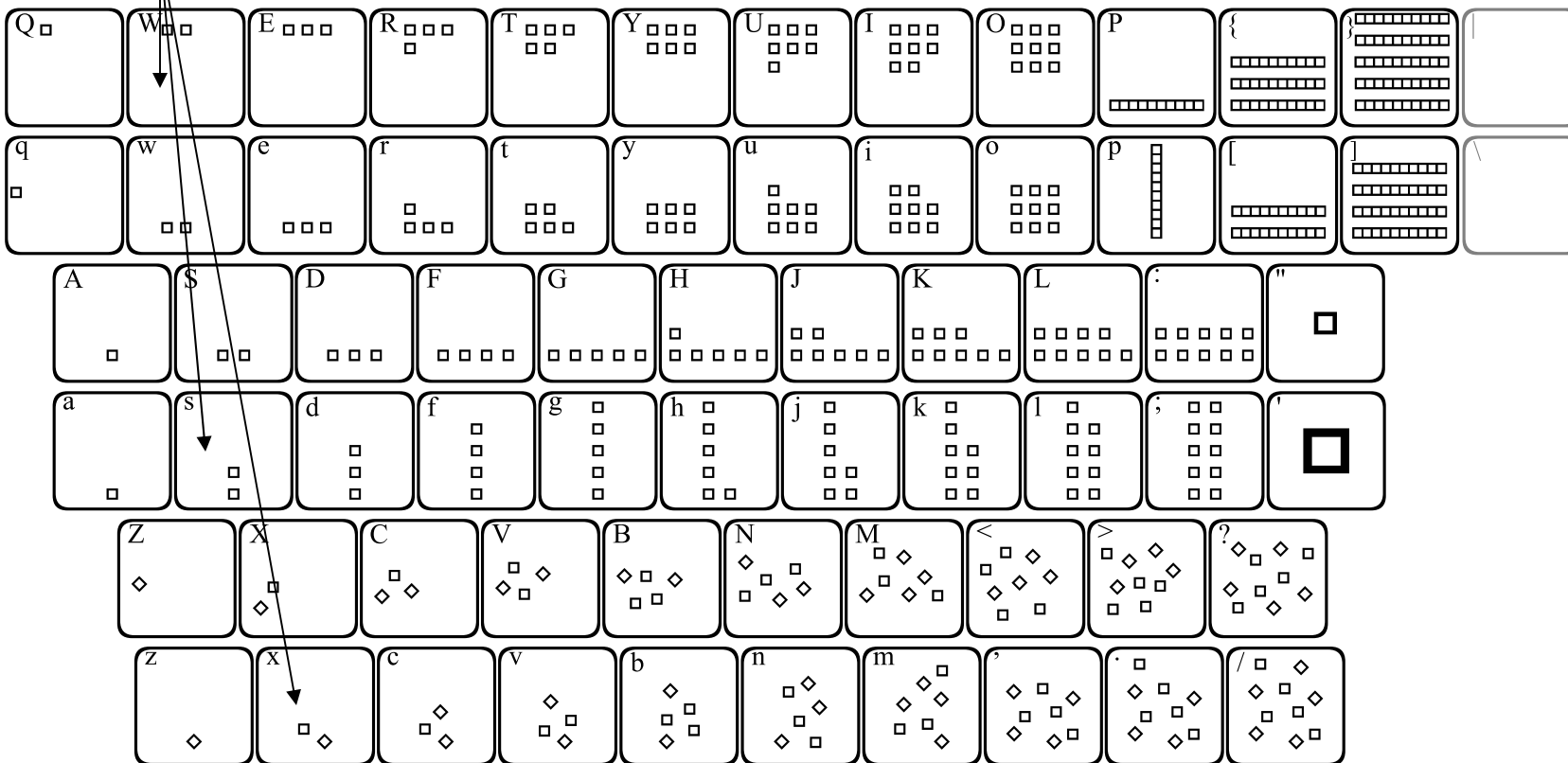

This font provides images of 2-dimensional squares that can be used in teaching number concepts and place value.

Pressing the SHIFT key with each number will give you a corresponding number of hundreds squares (SHIFT 1 = 1 hundred square, SHIFT 2 equals 2 hundred squares, etc.)

Each letter row shows the squares in a certain formation in ascending order. By using the SHIFT key with each letter row, you get the same number of squares, but in a different formation. The braces, brackets and backslash show groups of ten squares (up to 5 groups stacked).

123PlaceValue3D

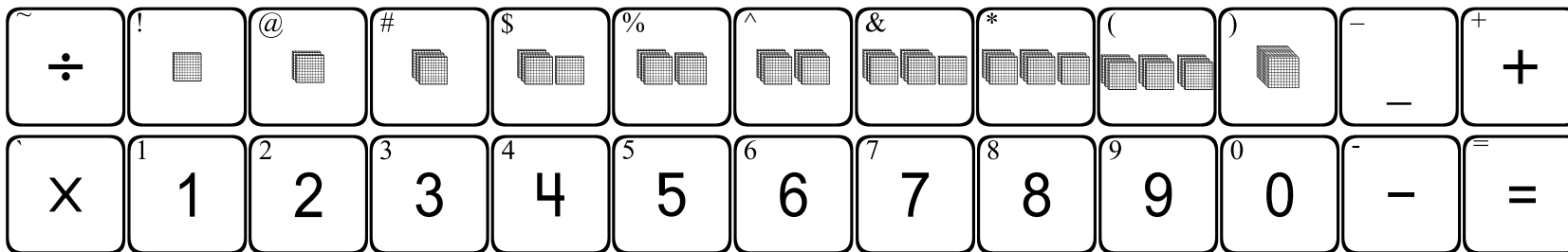

NOTE: The number of items on each letter key is equal to the number key above it.

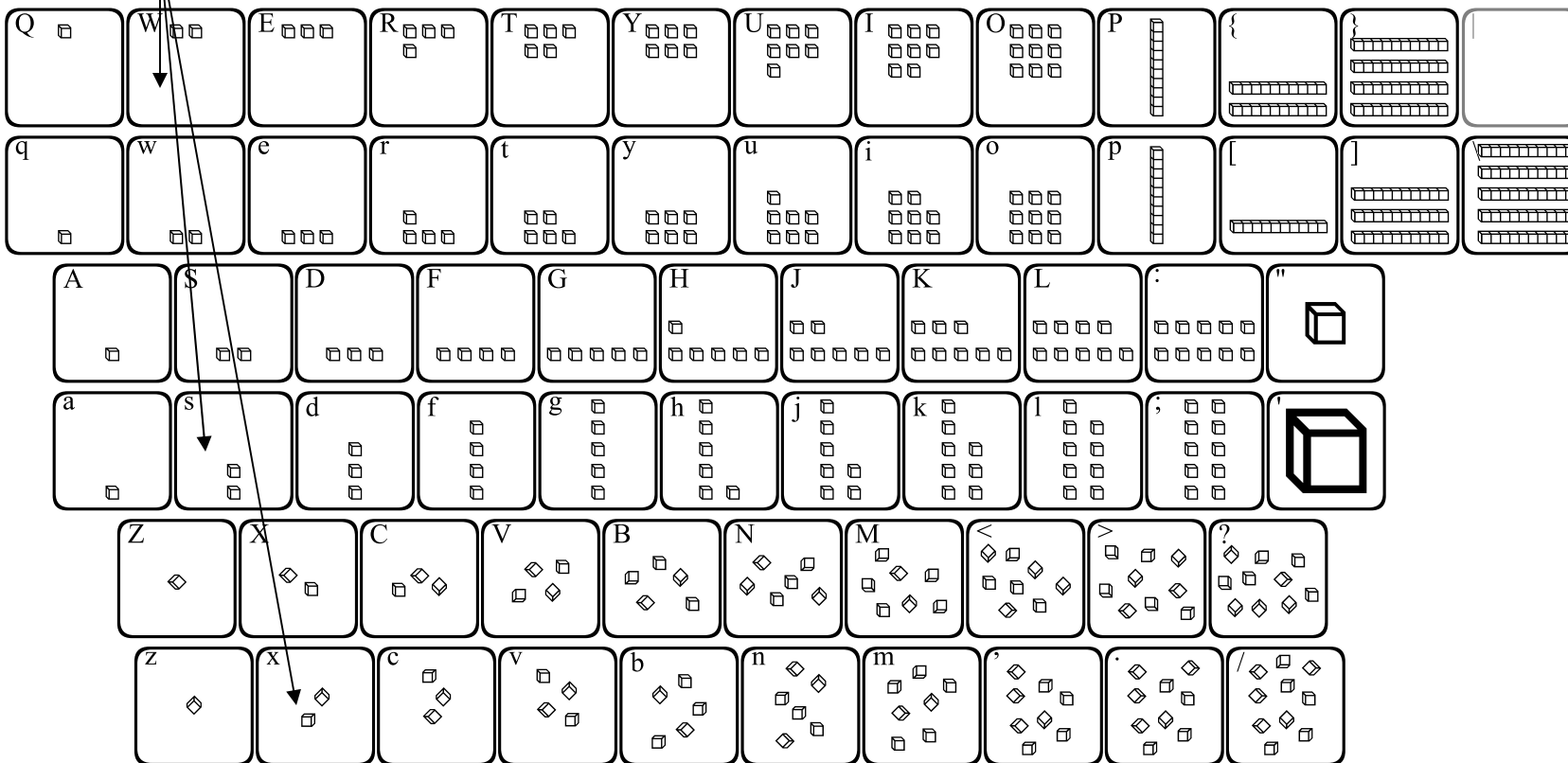

This font provides images of 3-dimensional cubes that can be used in teaching number concepts and place value.

Pressing the SHIFT key with each number will give you a corresponding number of hundreds cubes (SHIFT 1 = 1 hundred cube, SHIFT 2 equals 2 hundred cubes, etc.)

Each letter row shows the cubes in a certain formation in ascending order. By using the SHIFT key with each letter row, you get the same number of cubes, but in a different formation. The braces, brackets and backslash show groups of ten cubes (up to 5 groups stacked).

123Rulers1

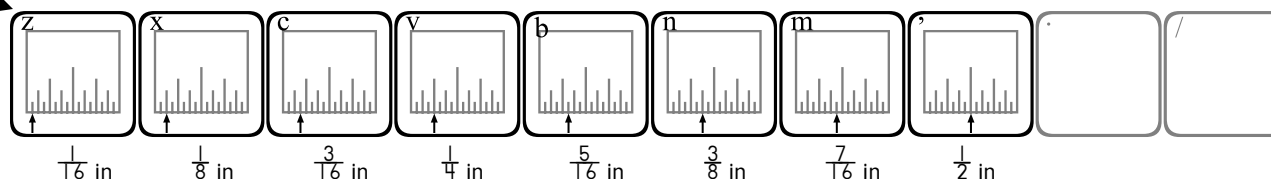
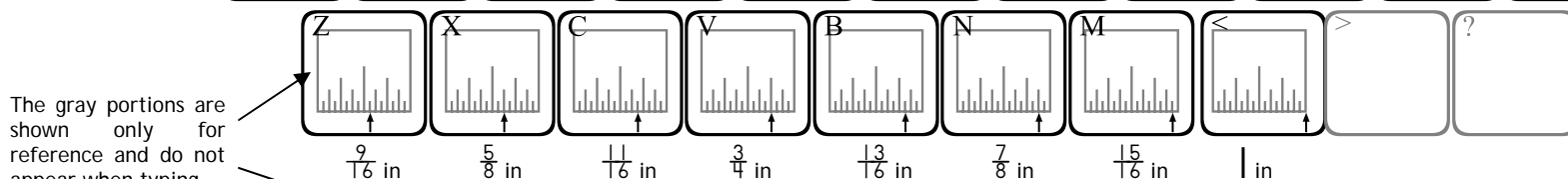
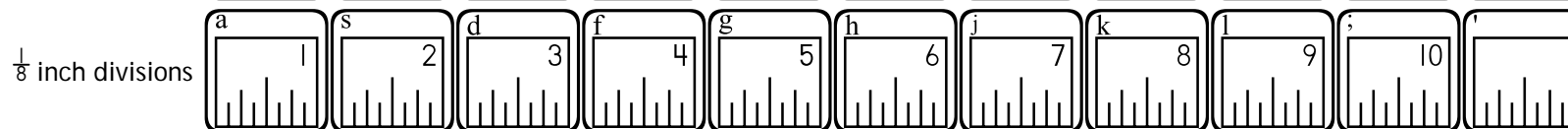
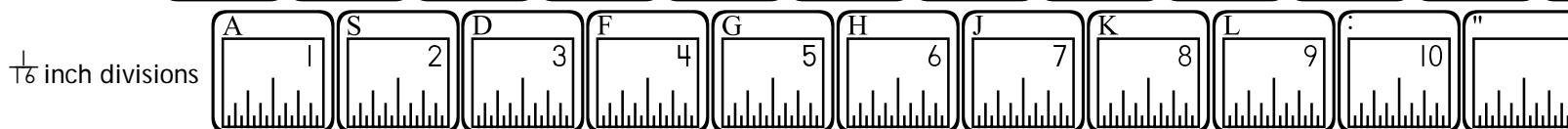
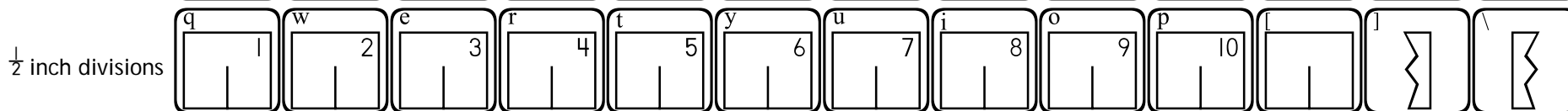
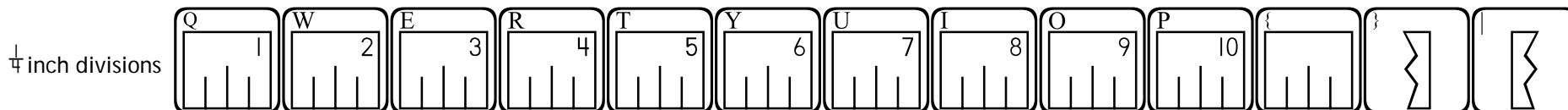
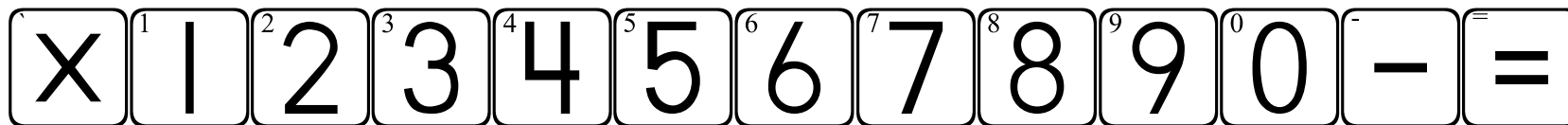
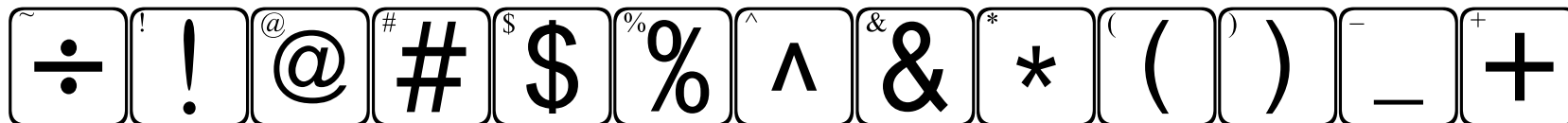

Arrows can be placed on any subdivision of the ruler. Press the appropriate arrow key on the "z" or "Z" row *after* you have placed a ruler piece.

123Rulers2

May require 2 or more keystrokes.

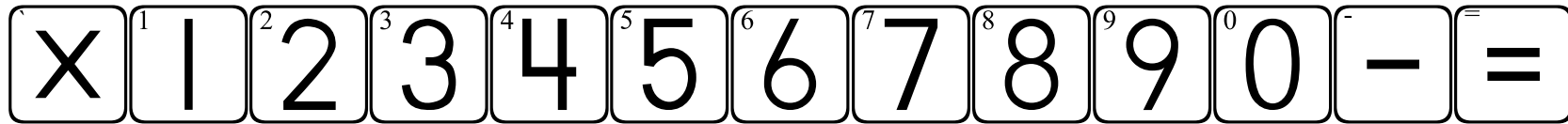
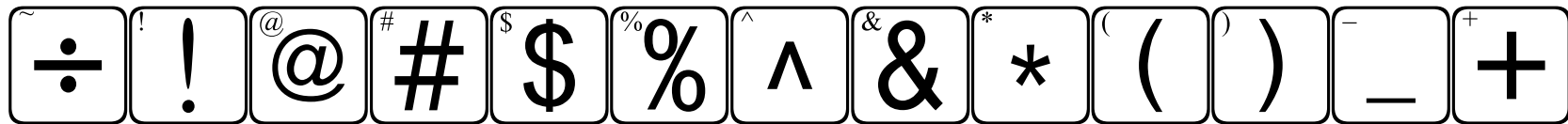

½ cm divisions

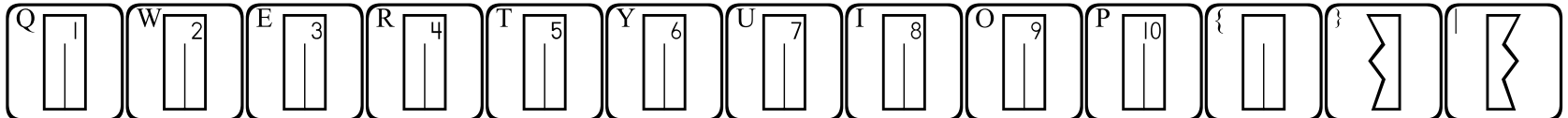

Centimeter divisions

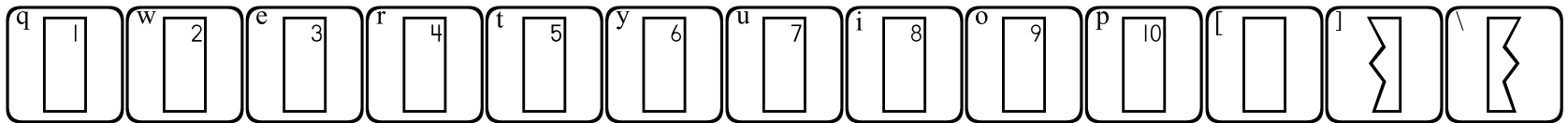

Millimeter divisions

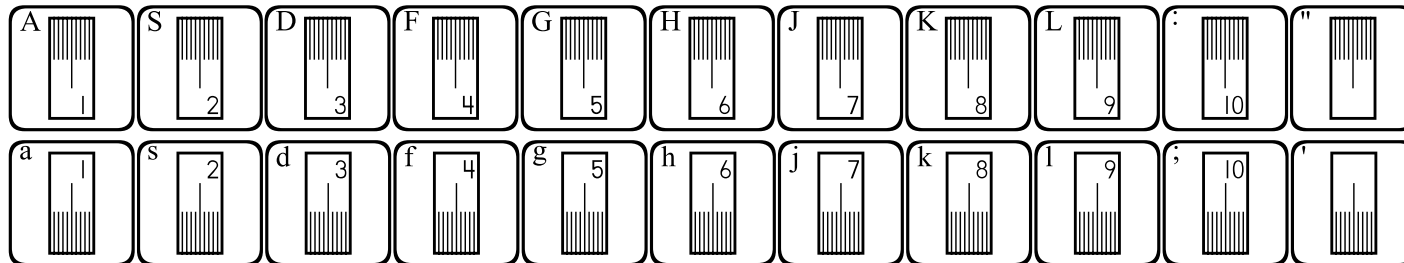

The gray portions are shown only for reference and do not appear when typing.

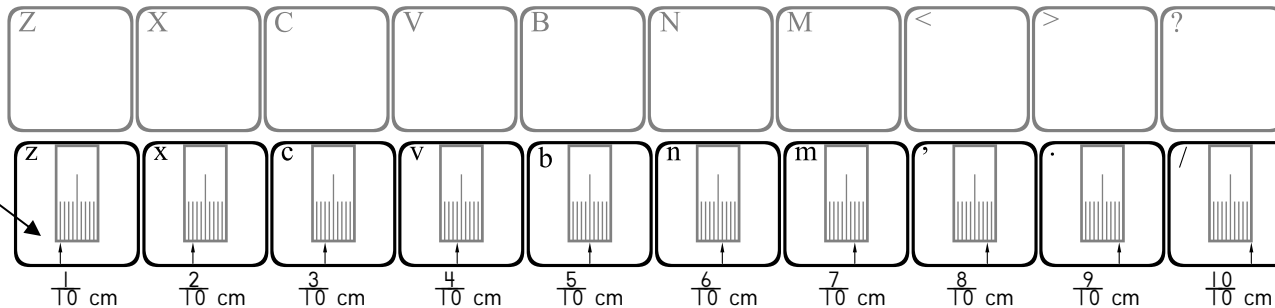

Arrows can be placed on any subdivision of the ruler. Press the appropriate arrow key on the "z" or "Z" row *after* you have placed a ruler piece.

123TeddyBears

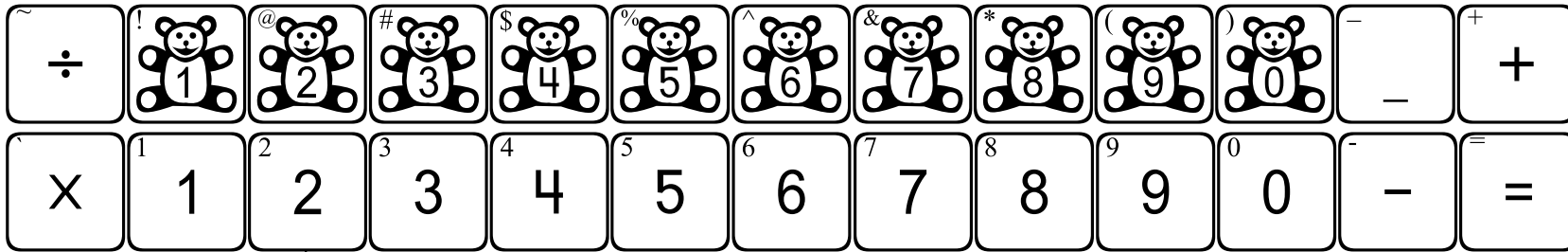

NOTE: The number of items on each letter key is equal to the number key above it.

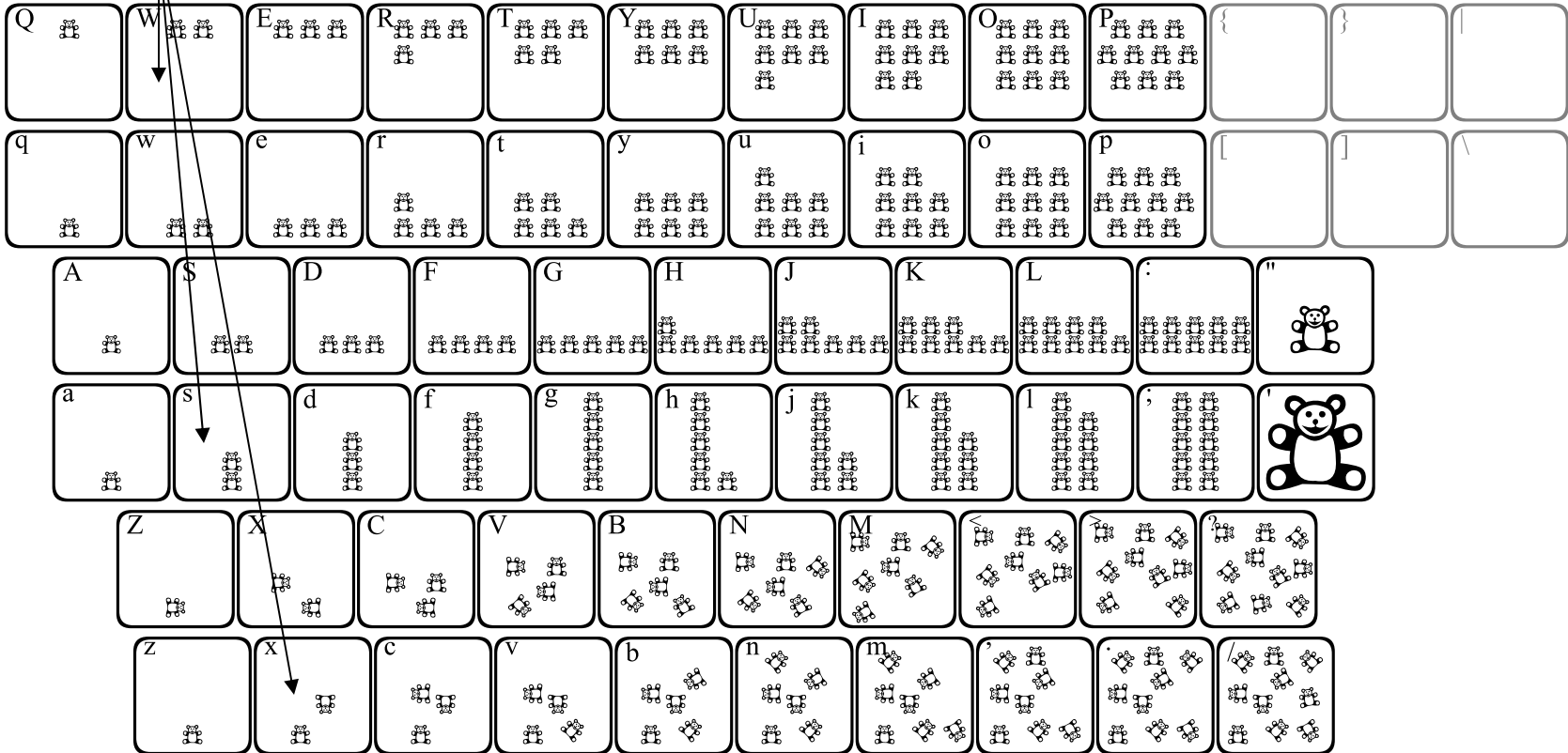

This font provides images of teddy bears that can be used in teaching number concepts. The layout is almost exactly the same as 123CountingBlocks. The primary difference is that numbered bears have been placed on the top row of symbol keys

Each letter row shows the teddy bears in a certain formation in ascending order. By using the shift key with each letter row, you get the same number of teddy bears, but in a different formation.

123Testing

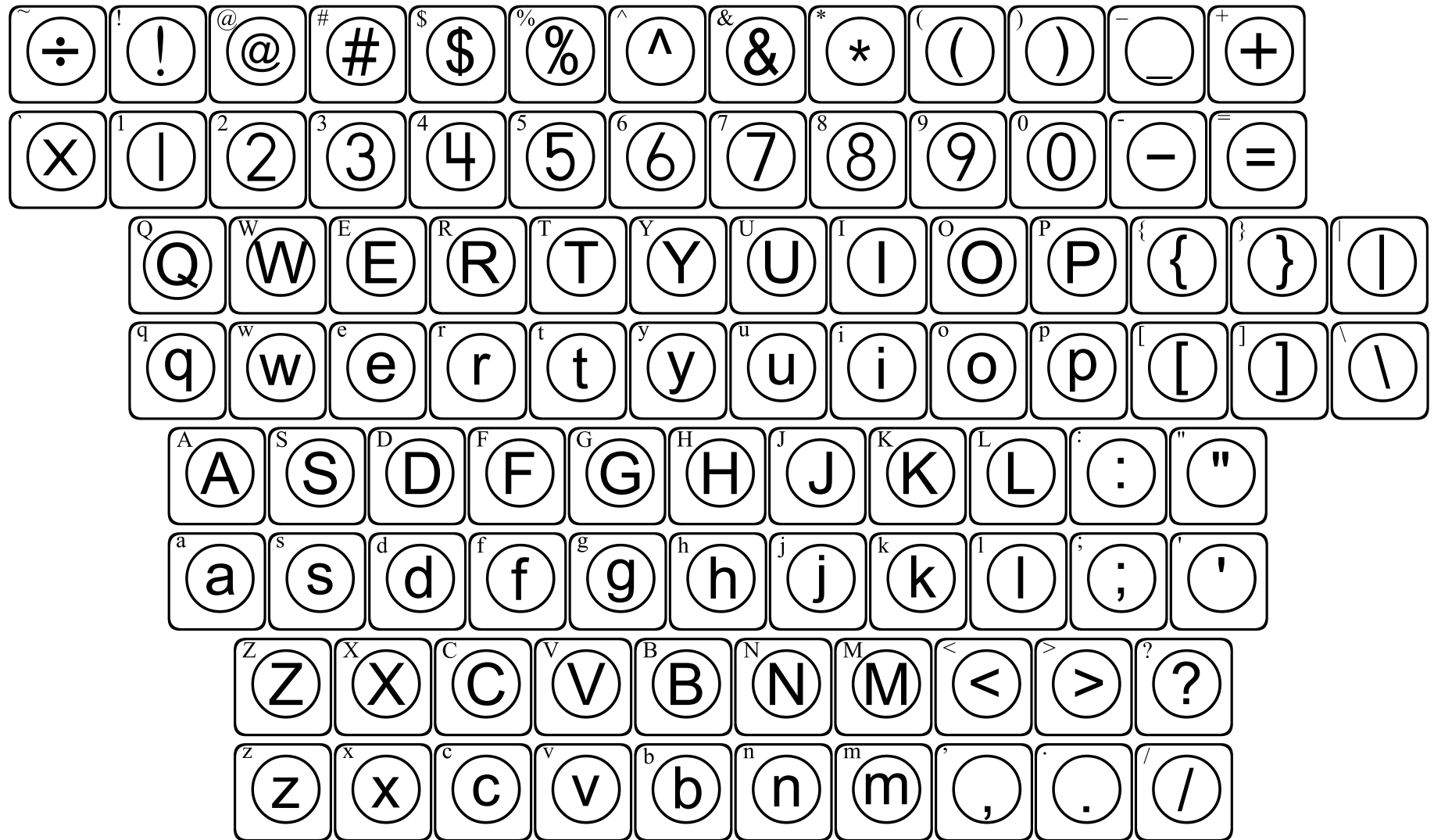

123Testing can be used to create bubble-in style answer documents for multiple choice tests.

123Transformations

May require 2 or more keystrokes.

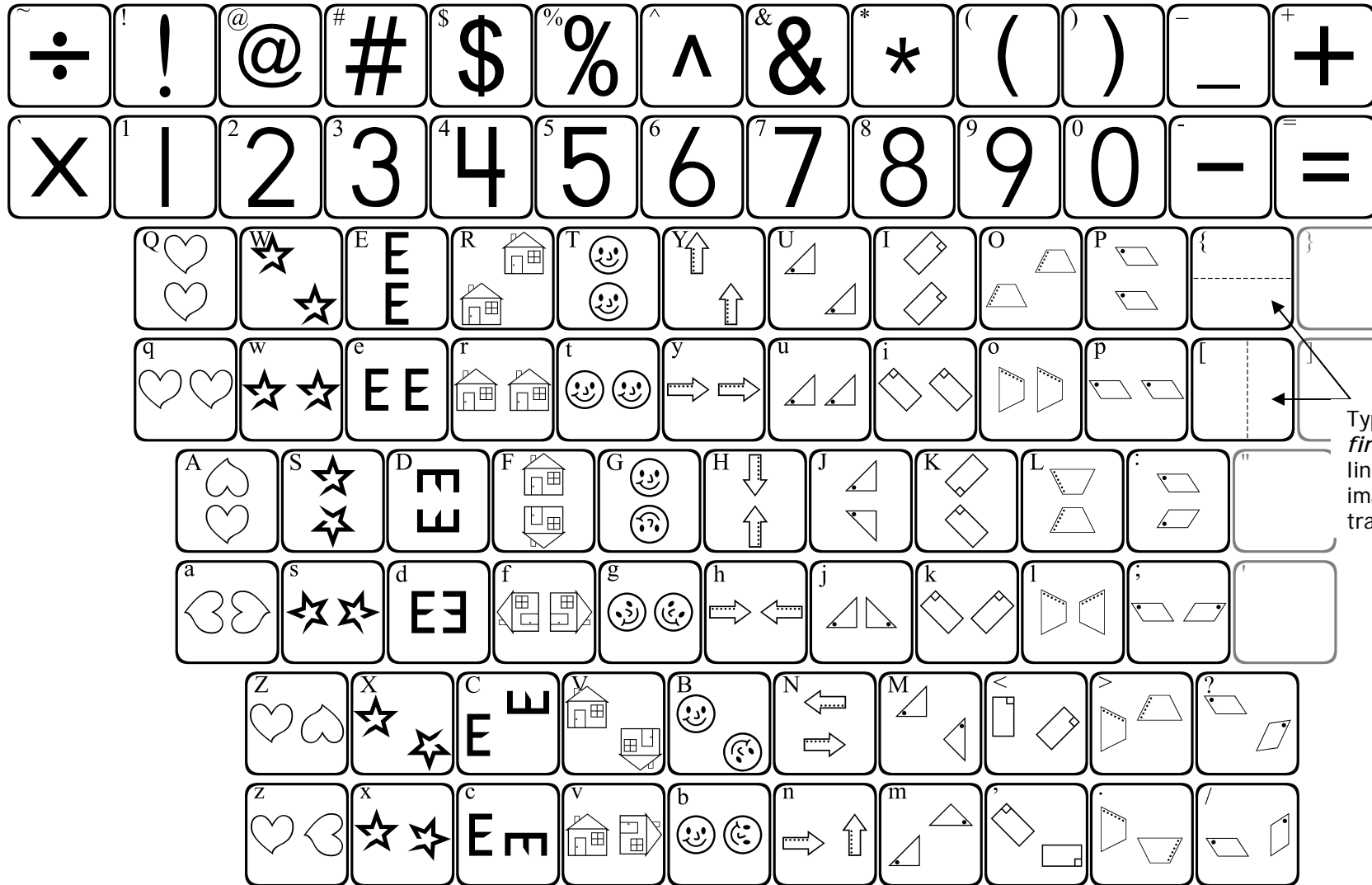

Type one of these **first** to place a line between the images of the transformation.

123Transformations provides images that show Slides (translations), Flips (reflections) and Turns (rotations).

"q" and "Q" = Slides "a" and "A" = Flips "z" and "Z" = Turns

A vertical line can be placed between many of the figures by pressing the [key before placing the figure.

A horizontal line can be placed between many of the figures by pressing the { key before placing the figure.

123Volume1

May require 2 or more keystrokes.

	!	@	#	\$	%	^	&	*	()	-	+
	1	2	3	4	5	6	7	8	9	0	-	=
	1x1	1x2	1x3	1x4	1x5	1x6	2x1	2x2	2x3	2x4		
Q	W	E	R	T	Y	U	I	O	P	{	}	
q	w	e	r	t	y	u	i	o	p	[]	\
	2x5	2x6	3x1	3x2	3x3	3x4	3x5	3x6	4x1	4x2		
A	S	D	F	G	H	J	K	L	:	"		
a	s	d	f	g	h	j	k	l	:	"		
	4x3	4x4	4x5	4x6	5x1	5x2	5x3	5x4	5x5			
Z	X	C	V	B	N	M	<	>	?			
z	x	c	v	b	n	m						
	5x6	6x1	6x2	6x3	6x4	6x5	6x6					

Type `jjjjJ` to make

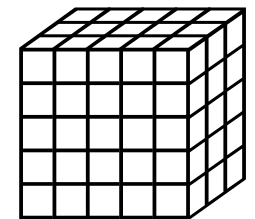

Use lowercase keys to build your volume model.

Use uppercase keys to close off the end of a volume model.

The lowercase keys place an "open" piece of a volume model, while the uppercase keys provide the "closed" portions. Type any "open" piece repeatedly to build a volume model to the desired width. Type the corresponding uppercase key last to finish the model.

123Volume2

May require 2 or more keystrokes.

	!	@	#	\$	%	^	&	*	()	-	+
	1	2	3	4	5	6	7	8	9	0	-	=
	1x7	1x8	1x9	1x10	1x11	1x12	2x7	2x8	2x9	2x10		
Q	W	E	R	T	Y	U	I	O	P	{	}	
q	w	e	r	t	y	u	i	o	p	[]	\
2x11	2x12	3x7	3x8	3x9	3x10	3x11	3x12	4x7	4x8			
A	S	D	F	G	H	J	K	L	:	"		
a	s	d	f	g	h	j	k	l	;	'		
4x9	4x10	4x11	4x12	5x7	5x8	5x9	5x10	5x11				
Z	X	C	V	B	N	M	<	>	?			
z	x	c	v	b	n	m	.	,	/			
5x12	6x7	6x8	6x9	6x10	6x11	6x12						

Use lowercase keys to build your volume model.

Use uppercase keys to close off the end of a volume model.

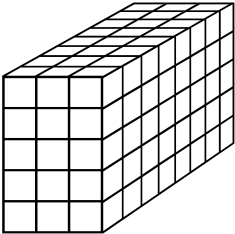
Type hhH to make 

The lowercase keys place an "open" piece of a volume model, while the uppercase keys provide the "closed" portions. Type any "open" piece repeatedly to build a volume model to the desired width. Type the corresponding uppercase key last to finish the model.

123Volume3

May require 2 or more keystrokes.

~	!	@	#	\$	%	^	&	*	()	-	+
	1	2	3	4	5	6	7	8	9	0		
	7x7	7x8	7x9	7x10	7x11	7x12	8x7	8x8	8x9	8x10		
Q	W	E	R	T	Y	U	I	O	P	{	}	
q	w	e	r	t	y	u	i	o	p	[]	\
8x11	8x12	9x7	9x8	9x9	9x10	9x11	9x12	10x7	10x8			
A	S	D	F	G	H	J	K	L	:	"		
a	s	d	f	g	h	j	k	l	:	"		
10x9	10x10	10x11	10x12	11x7	11x8	11x9	11x10	11x11				
Z	X	C	V	B	N	M	<	>	?			
z	x	c	v	b	n	m	<	>	?			
11x12	12x7	12x8	12x9	12x10	12x11	12x12						

Use lowercase keys to build your volume model.

Use uppercase keys to close off the end of a volume model.

Type `tttT` to make

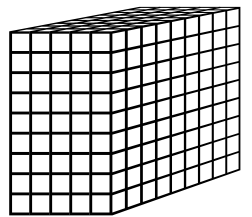

The lowercase keys place an "open" piece of a volume model, while the uppercase keys provide the "closed" portions. Type any "open" piece repeatedly to build a volume model to the desired width. Type the corresponding uppercase key last to finish the model.