



An EU funded project managed  
by the European Union Office in Kosovo



# AWARE

## MANUAL OF GOOD PRACTICES IN PIG FARMING



VOLONTARI NEL MONDO



UNIMORE  
UNIVERSITÀ DEGLI STUDI DI  
MODENA E REGGIO EMILIA



Agjencia e Ushqimit dhe Veterinarisë



**Edited by: Luisa Antonella Volpelli – Professor at the University of Modena and Reggio Emilia.**

**With contributions from Nicola Battistella - RTM Project Coordinator – and the Kosovo Veterinary Agency.**

**Printed in Pristina, May 2017**

**Produced by NGO Reggio Terzo Mondo**

This publication has been realized with the contribution of European Union. The contents of this manual are the sole responsibility of RTM, UNIMORE and AVUK and do not reflect in any way the views of the European Union.

## **TABLE OF CONTENTS**

Introduction and acknowledgments	7
Overview of the Project A.W.A.R.E.	9
Management and feed of sows	13
Management of piglets	39
The stage of growth and fattening	51
Livestock facilities	61
Main pathologies	75
Feed summary tables	79



## **INTRODUCTION AND ACKNOWLEDGMENTS**

This Manual is a result of training activities delivered between February 2015 and March 2016 under the *A.W.A.R.E. Project – Action of Women in Agribusiness for a new Regional Economy*, to farmers of EVA Cooperative and a group of veterinarians working in the Western Region of Kosovo. As these activities were of fundamental importance for a rural development project aiming empowerment and improvement of the pork production chain in Kosovo, it was decided to address some important elements in a short, user friendly manual, rich in practical aspects.

The schematic basis of the manual therefore responds to this need and the willingness to produce not merely a book, but a practical and immediate support to the daily activities of medium size pig farming management.

The manual is a summary of best practices of all farmers involved in the project and, at the same time, a tool for gradually introducing new techniques and reaching the standards of pig farmers in EU member states.

It should therefore be seen as a result of a process lasting more than a year, but also as a starting point for the development of the pig farming sector in Kosovo.

For this reason, although it has been developed within the A.W.A.R.E. Project, this text was designed with the hope that it would become a useful tool for all operators involved in this sector.

The preparation of this manual was made possible thanks to the generous support provided by the University of Modena and Reggio Emilia, and in particular by Professor Luisa Antonelli Volpelli, who has visited Kosovo several times in order to deliver trainings and to monitor the developments in the Project area.

The Kosovo Veterinary Agency has guaranteed continuous support and facilitated the synergies and collaborations, that have helped give density to the training.

RTM would like to thank them and all other institutions and organizations that have contributed in various ways to the designing of this manual.



Title:	<p style="text-align: center;"><b>AWARE</b></p> <p style="text-align: center;"><b>Action of Women in Agribusiness for a new Regional Economy</b></p>
Location:	Kosovo – Western Economic Region
Total duration:	24 months
Objectives:	<p><u>General objectives:</u> contribute to EU standards compatible farming, processing and retail and marketing practices implemented in the meat sector.</p> <p><u>Specific objectives:</u> support the development of the complete chain of pork production in the Western Region through the valorization of cooperative production and traditional knowledge of minority rural women.</p>
Expected outcomes:	<p>(1) Increased production capacities and management standards of target pig farms in the Western Region.</p> <p>(2) Increased pork processing capacities in the Western Region.</p> <p>(3) Local pork products introduced in the region and Kosovo market.</p> <p>(4) A regional quality brand is developed and distributed to protect and promote typical pork production</p>

	at regional and national level.
Key activities:	<p><u>ACTIVITY CLUSTER 1 – COOPERATIVE PRODUCTION</u></p> <p>Implementation of a training program on management of pig farms for veterinarians and pig breeders in the cooperative.</p> <p>Providing technical assistance to pig breeders in the cooperative for drafting individual plans for the expansion of pig farms.</p> <p>Financial and technical support for pig breeders in the cooperative for the expansion of pig farms.</p> <p><u>ACTIVITY CLUSTER 2 – DEVELOPMENT OF THE PRODUCTION</u></p> <p>Construction and equipping of a modern small-scale slaughterhouse for slaughtering and processing of pigs in Klině/Klina.</p> <p>Implementation of a training program for pig breeders in cooperative on pig slaughtering and processing techniques.</p> <p>Study visit to Emilia Romagna Region (Italy) and observation of slaughter and pig farming techniques for pig farmers in the cooperative.</p> <p>Provision of technical and financial assistance to pig farmers in the cooperative for the management of the plant and start of production.</p>

	<p><u>ACTIVITY CLUSTER 3 – MARKETING AND GROUP PROMOTION</u></p> <p>Implementation of a training program on marketing and promotion of quality agricultural products for producers, retailers and tourism enterprises.</p> <p>Provision of technical assistance in defining sales contracts, introducing pork and secondary products into regional and Kosovo market.</p> <p>Provision of financial assistance to producers, retailers and tourism companies in the promotion of pork products on the market.</p> <p><u>ACTIVITY CLUSTER 4 – DEFINING A REGIONAL BRAND</u></p> <p>Provision of technical assistance in defining and adopting a Regulation on Production for Pig Farms and Pork Processing.</p> <p>Designing a regional quality brand to be used for pork products.</p> <p>Designing of an information campaign to promote the regional brand.</p>
--	---



# **MANAGEMENT OF SOWS**

## THE CULTURE OF PIG FARMING

### Key objectives

- Improving cultivation performance:
  - Production efficiency;
  - Growth speed;
  - Efficiency of changing the feed.
- Improving structural quality of meat.

### Main points

- Income earning for farmers: from the sale of meat, the derived products and from animals.
- Obtaining high quality products safe for consumer health.
- Preserving the wellbeing of animals and humans.
- Reducing the impact of breeding on the environment.

## PHASES OF THE BREEDING CYCLE

Sow	<ul style="list-style-type: none"><li>• Fertilization</li><li>• Conception (114-115 days)</li><li>• Farrowing</li><li>• Nursing (21-28 days)</li><li>• Covered rest (~ 6 days)</li></ul>
Piglets	<ul style="list-style-type: none"><li>• Weaning (21-28 days, 5-7 kg of body weight)</li></ul>

	<ul style="list-style-type: none"> <li>• Post-weaning (up to ~ 30 kg)</li> </ul>
Followed by	<ul style="list-style-type: none"> <li>• Fattening of a light pig</li> <li>• Fattening of a heavy pig</li> <li>• Breeding new sows</li> </ul>
Growth-fattening	<ul style="list-style-type: none"> <li>• ~ 100kg light pig ~ 6 months</li> <li>• ~ 160kg heavy pig ~ 10 months</li> </ul>

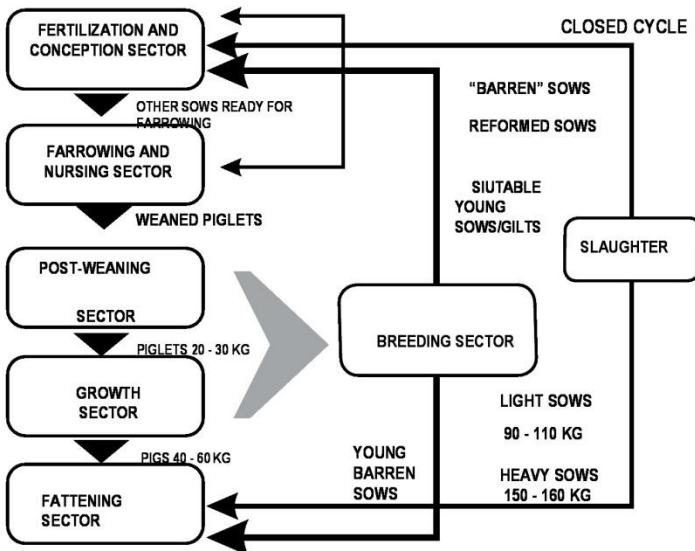

A3

## HEAT SIGNS

In the pro-estrus and estrus phases animals face **anatomic and behavioural changes**, particularly at the level of genitals, that facilitate the identification of standing heat and draw the attention of the handler.

<b>PRO-ESTRUS PHASE</b>	<ul style="list-style-type: none"><li>• Thickening and reddening of the vulva.</li><li>• The animal is not calm.</li><li>• The animal shows interest in human presence (e.g. when the handler passes by, the animal is the first to rise).</li><li>• Appetite begins to reduce.</li><li>• If the sow is free, she attempts to lean on other pigs, and if other pigs attempt the same, she does not resist and stands still.</li><li>• Presence of vaginal fluid (mucus).</li></ul>
<b>ESTRUS PHASE</b>	<ul style="list-style-type: none"><li>• The redness of the vulva begins to reduce.</li><li>• The edema of the vulva begins to reduce.</li><li>• The presence of the mucus is increased (it becomes increasingly bigger towards the end of standing heat).</li><li>• The sow requires a boar.</li><li>• It loses appetite.</li><li>• Makes a characteristic roar.</li><li>• Keeps leaning on other sows and if they do the same she does not move.</li></ul>



	<ul style="list-style-type: none"><li>• In the presence of the pig she stands still, lowers and raises the ears.</li><li>• Accepts mating.</li></ul>
--	--

RECOMMENDED: take the sow to the boar once the standing heat has begun and leave her there until the emergence of the immobility reflex.

If **artificial fertilization** occurs, the first fertilization at the time of the appearance of heat; then fertilization is repeated after 24 hours until the appearance of the reflex of immobilization.

### **BREEDING NEW REPRODUCERS: YOUNG SOWS/GILTS**

The following should be considered:

- It is recommended that the gilt begin the reproduction cycle as early as possible = pregnant and nursing = income.
- However, starting too early when the gilt is too young may negatively affect her physical development in the future.

**Solution – When to fertilize?** The beginning of her reproductive life, i.e. puberty and first ovulation, mostly occurs from 5 to 8 months of age (on average about 200 days, weight 90-100kg). **But, it is advisable to wait and carry out the first mating at about 7.5 to 8 months of age, when the body weight reaches 135 to 140 kg.**

### **LET'S HELP GILTS BEGIN ...**

The beginning of the reproduction of gilts may be supported by a number of actions:

- Exposure to boar, at least 10 – 15 min/day, starting at 150 days of age.
- Luminated environments.
- Space of around 2,5 m<sup>2</sup>/head.
- Abundant feed, but not to excess.

Give them more feed 7-10 days prior to standing heat in which they should be fertilized.

If a gilt has never come into estrus for 8 to 9 months of life, it is better to move her to fattening, **NOT to reproduction!**

### **WHAT WE SEE IN BOARS**

The young boar reaches **sexual maturity at about 5 to 6 months of age, but** due to poor seed quality it is advisable **NOT** to use boars before **7 to 8 months of age. Boar fertility**

**increases with age and reaches its maximum between 15 and 20 months of age.**

- It is better to breed **in pens with external fences** → faster puberty and better sexual behavior.
- They should be able **to see** other pigs = they should **NOT** be kept in isolated pens and in dark.
- It is preferable to have **gilts/sows** in breeding facilities.

## **ASPECTS OF CONTROLLING FERTILIZATION**

**From the next insemination to the farrowing, we should CONTROL:**

- Feed.
- ONGOING control of recurrent standing heat: we should realize if she is not pregnant!
- Ecographic control is necessary (starting with the 21<sup>st</sup> day of pregnancy).
- Environment control: watch for high temperatures, they might disrupt the pregnancy.

**The shelter should have a number of characteristics:**

- Possibly individual feed, peace, rest.
- Facilitate potential recurrence of the estrus phase → the passage of a boar and/or handler.

- **Individual shelter** facilitates feed, control, treatment of the animal; reduces aggression.
- However, if the sows/gilts have more space to move (**collective pens**, fences, open meadows) it will improve the psycho-physical wellbeing and reduce bowel problems.

***Ways of sheltering sows caused a big debate in the EU (see more).***

## **FARROWING**

- It is preferable for the sow to fast on the day of farrowing, however WATER should be available.
- The farrowing pen should be the cleanest space of the farms: excrement is systematically removed.
- Heat lamps are turned on for the piglets before the farrowing starts.
- Usually, sows do not require assistance, however, “cautious” monitoring may significantly reduce post-partum mortality in case of problems: “weak” farrowing (oxytocin i.m.), badly positioned piglets, weak piglets ...

## **NURSING**

Sows are good milk producers = they produce lots of milk, containing lots of fat and protein... as long as it gets enough feed = proper feed.

## **MILK PRODUCTION**

- Depends on the number of piglets to nurse (NOT on the number of newborn piglets ... adoptions are important!).
- Does not depend on the body weight of sows (exception: those at first farrowing).
- Depends on the amount of daily feed/energy intake!

## **DURATION OF WEANING**

Weaning normally occurs between days 28 – 35.

- If it occurs too soon (at less than 21 days), in addition to difficulties with piglets, delays may often occur with the sow returning to estrus, when they could be fertilized again.
- If it occurs beyond day 35 there are no advantages for piglets, and the sow would continue breastfeeding in vain.

In order to disrupt the production of milk after the piglets have been weaned, it will be sufficient to put the sow on fast for one day, but with water available to her.

## **BREEDING**

Replacement of sows once they have completed their reproduction cycle because of age or because they have stopped reproducing.

## BREEDING CAN BE:

- INTERNAL (*Reproducing new sows from those farrowed in the stall*): the advantage is that the animals are known and there are no risks of the appearance of pathologies from outside; in addition, the costs are lower.
- EXTERNAL (*purchase of new sows*): genetically better sows can be purchased, with better reproductive potential, no blood connections; more costly.

It is advisable to keep a few of the sows born in the stall, as well as to buy some new sows from outside.

**When buying sows from outside, they should be of age 4-5 months, and not yet mated. Purchasing pregnant sows poses a risk in terms of pathologies, however, it can be done if the seller is known and close.**

## QUANTITATIVE PRODUCTION OF SOWS

Sow management involves high costs in terms of housing structures and the feed they consume.

The only voice **of their reproduction = farrowing of piglets.**

**It should be as high as possible**, this means:

- Increase of the **number of farrowings /years.**

- Increase of the **number of weaned piglets for each group of newborns.**

It is important to **RECORD** all events related to the reproductive life of sows.

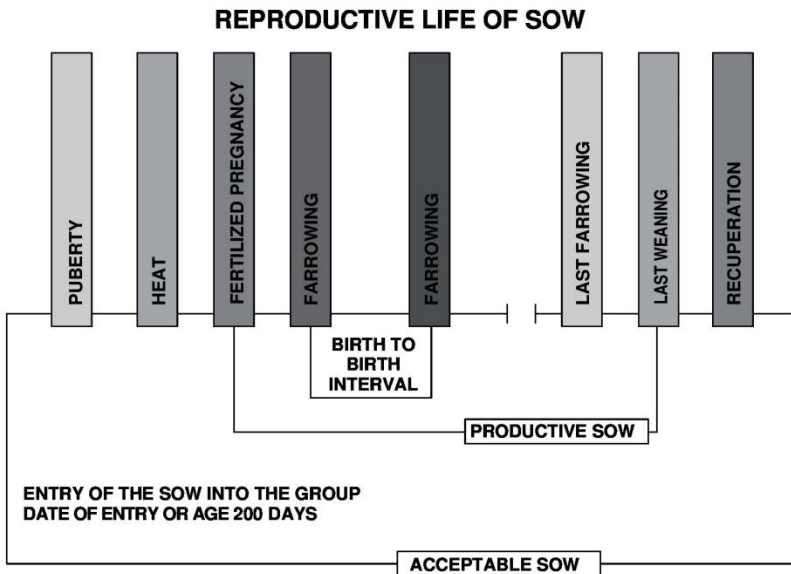

A17

For every productive sow we should know:

- The average number of live farrowed piglets/farrowings ( $T_n$ ).
- Mortality % between farrowing and weaning ( $T_m$ ).
- $I$  (interval between farrowings) = the duration of nursing  $A$  + weaning/fertilization interval (ISF) + duration of conception  $G$ .

$$P_{Spro} = \frac{T_n * (1 - T_m) * 365}{I}$$

For every present sow we should know:

- The interval between the entry of the sows and the first farrowing.
- The interval between last weaning and recuperation.



## THE IMPROVEMENT OF THE PRODUCTIVITY OF THE SOW MEANS

On the one side, there is improvement of the parameter of the **“NUMBER OF PIGLETS BORN AND WEANED/FARROWINGS”**; this may depend on a number of factors:

- **Genetic**, affecting the breeding and (less) the health of piglets.
- **Environmental**: characteristics of recuperation, a microclimate suitable for conception and then during the first weeks of the life of piglets.
- **Pathogenic**: protection against diseases that cause abortion, pre-natal embryonic mortality.
- **Feed**: the feed served to sows and piglets is an important factor affecting the health and the growth of piglets.
- **Management**: assistance with farrowing when necessary, continuous monitoring of piglets, which significantly reduce mortality.

On the one side, **“PERIODS OF NON-PRODUCTIVITY ARE REDUCED”**, so not everything is conception and nursing.

- Young sows/gilts are, in such a case, very often “a weakness”.
  - Delays between first mating and effective fertilization.

- Delays in recurrence of first estrus after weaning, and lost conceptions.
- Increase of the number of fertilization/conception interventions.
- Loss of time and money, in the case of lack of conception, **during the days from fertilization up to identification of a failed conception** (return to standing heat, abortion/re-absorption, pseudo-conception).
- The same goes for the intervals that follow the reform, they are usually unnecessarily extended by trying the fertilization several times.

## DEVELOPMENT OF REPRODUCTION IN BOAR STALLS

	Optimal level	Tolerable level
<b>Average N° farrowings/sow/year</b>	<b>2,4</b>	<b>2,2</b>
<b>Weaning – fertilization interval:</b>		
Less than 8 days	<b>85%</b>	<b>75%</b>
Less than 15 days	<b>92%</b>	<b>82%</b>
<b>Abortions</b>	<b>1,0%</b>	<b>3,0%</b>
<b>Average N° of live farrowed piglets per farrowing</b>	<b>12</b>	<b>11</b>
<b>Still births</b>	<b>4,0%</b>	<b>7,0%</b>
<b>MORTALITY (UP TO WEANING)</b>	<b>10%</b>	<b>15%</b>
<b>Average N° of weaned piglets/farrowing</b>	<b>10,5</b>	<b>9,3</b>
<b>Average N° of weaned piglets/sow/year</b>	<b>25</b>	<b>21</b>

## FEED DURING PREGNANCY

- During pregnancy, because of low demand, the feed should be rationed.
- Towards the end of pregnancy it is desirable to increase the nutrition (practically up to additional 1 kg of feed /day).
- This can be done by increasing the content of lipids → colostrum and milk + high fat + production + survival and growth of piglets.
- Excessive diet at conception is useless and costly (\$!!), causes excess fat in the sow: this then reduces her appetite and consequently her (already insufficient) capacity to swallow at the next lactation, causing the sow to loose even more weight!

## FEED DURING PREGNANCY should be RATIONED

- 2-3 DAYS UPON FERTILIZATION: 2,0 kg/head is sufficient.
- From the FIRST to the THIRD month: 2,5 kg/head up to 3,0 kg/head.
- THE LAST MONTH: increase by 3,5 kg/head, gaining in fetus size, the body weight of piglets at birth and their vitality.
- By the end of the pregnancy the sow should gain **in shape but not in fat**: fat animal have problems at farrowing and lack of appetite at the onset of nursing.

**NOTE:** The quantities of **COMPLETE CONCENTRATE FEED** should be shown. It will be seen case by case, as well as when using self-produced feed (corn, barley, soybean, forage, vegetable waste, bran, etc.).

- Be careful to avoid feed contaminated with **toxins** (e.g. micro toxins).
- Always provide sufficient water, they can drink up to 18 l/day.
- This is a period when the sow makes the best use of rations rich in **fiber**: grass, forage, bran, beet pulp, silage, vegetable waste...

## **FEED DURING NURSING**

Feed given during nursing affects milk production, and consequently piglet growth and weight loss of the sow.

### **In practice:**

- The sow be provided UNRESTRICTED feed, especially if nursing 9-10 or more piglets,
  - It should be given feed that provides around 3300 kcal ED/kg.
- ➔ Should gain (depending on the size, genetic type, nursing phase, environmental conditions...) from 4,5 kg/d to 5,5 kg/d from week two onwards.

**It should be assessed case by case according to feed produced independently and those bought as to how to feed the animals.**

If there are fewer piglets, the sow could be given less feed. If there are more sows that have farrowed within few days, It is more beneficial to have **adoptions**, in order to avoid too large a number of piglets with any of the sows.

Remember that her already reduced ability to swallow is now insufficient and deteriorated.

- If she has gained too much weight (fat).
- If the feed provides little energy, unprocessed.
- If there is little water.
- If the environment is warm.

For very productive sows, the fattening diet is recommended.

- Ensures higher concentration of energy in equal feed.
- Desirable improvement.
- The sow feels less heat after feeding → improvement in summer season.

## **REVIEW OF FEED FOR SOWS**

Given the very different requirements in terms of feed during pregnancy and nursing, **it is advisable to use a variety of feed in both phases:**

- **The nursing phase** requires large quantities of feed, with more energy and protein.
- **During pregnancy** less feed is given, with less energy and protein.

The following table contains information regarding:

- Levels of **energy, protein, lysine, calcium and phosphorus** advisable in feed rations for sows **during** both phases.
- Examples of **composition** of whole feeds.

It will be seen case by case how to use raw materials to follow these instructions.

### **AVERAGE NUTRITIONAL CHARACTERISTICS OF FEED FOR SOWS**

	<b>PREGNANCY</b>	<b>NURSING</b>
<b>ED Kcal/kg (min-max)</b>	<b>2800 -3300</b>	<b>3100 – 3400</b>
<b>EN Kcal/kg (min-max)</b>	<b>2150</b>	<b>2350</b>
<b>Protein %</b>	<b>13 -14</b>	<b>15 – 17</b>

<b>Lysine %</b>	<b>0,6</b>	<b>0,9 – 1</b>
<b>Calcium %</b>	<b>1,1</b>	<b>0,9</b>
<b>Phosphorus %</b>	<b>0,5</b>	<b>0,6</b>
<b>Quantity of feed (kg /head/day)</b>	<b>2,5 - 3</b>	<b>4,5 - 6</b>

#### **EXAMPLES OF COMPOSITION OF WHOLE FEED FOR SOWS**

<b>%</b>	<b>PREGNANCY</b>	<b>NURSING</b>
<b>Grains, beet pulp</b>	<b>55 - 70</b>	<b>55 - 70</b>
<b>Bran</b>	<b>15 - 20</b>	<b>10 - 15</b>
<b>Protein flour</b>	<b>10 - 15</b>	<b>15 - 20</b>
<b>Fat</b>	<b>0 - 1</b>	<b>2 - 4</b>

**Grains: corn, barley, wheat, etc.**

**Protein flour: soy, sunflower**



**Two examples of feed that can be produced in the company:**

<b>%</b>	<b>PREGNANCY</b>	<b>NURSING</b>
<b>Corn flour</b>	<b>48</b>	<b>53</b>
<b>Barley flour</b>	<b>15</b>	<b>10</b>
<b>Bran</b>	<b>20</b>	<b>13</b>
<b>Soy flour extract</b>	<b>15</b>	<b>20</b>
<b>Fat</b>	<b>-</b>	<b>2</b>
<b>Vitamin and mineral supplements</b>	<b>2</b>	<b>2</b>

### **SUMMARY OF DIFERENT PHASES OF FEED FOR SOWS**

**SOW:** should have good growth/development, but should not fatten.

Good practice → as needed up to 50-60 kg, afterwards the feed should be rationed.

**DISTRIBUTION** before the fertilization of sows: increase in the quality of feed in the following 2 weeks.

**First part of pregnancy** → reduce size, up to above 2,5 kg/head/day.

If the sow loses weight as a result of previous nursing, adding fat to feed rations may be efficient for fast recovery of weight.

Always give feed rich in fibers (bran, grass, clover,...) to fight constipation.

**Second and third part of pregnancy** → keep the nutritional level, the sow recuperates equally in weight and rebuilds reserves for lactation.

**The last part of pregnancy** → fetuses grow fast, diet supplements improve the weight at birth and are thus vital.

In a mother, more energy favours the development of the quantity, which is a basis for the production of colostrum and then milk.

Remember: excessive fattening is counterproductive.

The needs of embryos are still almost none, but be careful with vitamins and minerals.

## **MANAGEMENT AND WELLBEING**

The system of sow treatment and all animal treatment in general should meet their needs in all phases of the reproductive cycle.

THE NEEDS OF THE SOW	THE NEEDS OF THE FARMER
<ul style="list-style-type: none"> <li>• Should not be malnourished;</li> <li>• Should not have physical and thermal problems;</li> <li>• Should not suffer injuries or pathologies;</li> <li>• Should not have fear or stress;</li> <li>• Should have normal behavior.</li> </ul>	<ul style="list-style-type: none"> <li>• Good performance of the animal;</li> <li>• Reduction of labour;</li> <li>• Ease in treatment;</li> <li>• Acceptable capital costs;</li> <li>• Acceptable financial return.</li> </ul>

**The debate around the two main ways of sheltering sows during the phase of conception:**

### **INDIVIDUAL SHELTER *versus* GROUP SHELTER**

#### **Group shelter**

<b>Advantages:</b>	<b>Problems:</b>
<ul style="list-style-type: none"> <li>• Simple construction, lower fixed costs;</li> <li>• Freedom of movement for the sow, healthy bones;</li> <li>• Lower costs of feed distribution.</li> </ul>	<ul style="list-style-type: none"> <li>• Competition among animals, feed distribution is not equal;</li> <li>• Difficult individual control (e.g. therapy);</li> <li>• Hierarchy fights dangerous during the phase of embryonic development (first 30 days).</li> </ul>

## Individual shelter

<b>Advantages:</b>	<b>Problems:</b>
<ul style="list-style-type: none"><li>• Weighted feed for every animal;</li><li>• Reduction of feed consumed in vain;</li><li>• No problems with hierarchy, no attacks;</li><li>• Individual control of animals (e.g. pathologies, treatments);</li><li>• Better working conditions for the handlers.</li></ul>	<ul style="list-style-type: none"><li>• Lack of movement;</li><li>• Problems with microclimate, cold and warm;</li><li>• Winter: heating and/or increase in feed;</li><li>• Problems with arthritis, difficulties at farrowing, piglets less healthy;</li><li>• More difficult occurrence of estrus;</li><li>• Less WELLBEING of the sow.</li></ul>

## LAW ON THE PROTECTION OF ANIMALS ON FARMS

From 1976, the European Union has formulated conventions and has issued indirect directives for specific species on the protection of animals in breeding. One important step was the issuing Directives CE 98/58 (indirect).

### **In general:**

- Qualified personnel assistance;
- Freedom of movement;
- Recuperation;
- Treatment;
- Control of automatic systems;
- Nutrition;
- No darkness or full illumination.

### **MINIMAL NORMS FOR THE PROTECTIONS OF PIGS**

Currently, "**Minimum Standards for the Protection of Pigs**" were originally set by **Directive 91/630 / EC**, and the application of cultivation > 6 heads or > 5 sows.

- Stabilization of minimal possible spaces.
- Prohibition of attacks on sows and gilts.
- Control of automatic installations, ventilation, full darkness is not allowed, adequate nutrition, at least 1 time/day.
- More rigorous provisions by individual states.

Later directives have included or partially modified previous directives.

The European Union has issued to all Member States Directive 120/2008/EC, which is the basis for **Regulation No.**

### **3/2015 of the Republic of Kosovo on the establishment of minimum standards for the protection of pigs.**

#### **Let's see the main points of the directives and the so-called Regulation:**

- It is forbidden to use individual shelters for pregnant sows from 28 days after fertilization and 1 week before birth, including for gilts.
- Expanding possible spaces; the presentation of the size and density of the animals even in the collective stall.
- Cracks: minimum distance from small beams, maximum distance from cracks.
- Supply with exploration and manipulation material (straw,...).
- Provide temporary access to feed without attacks; Minimize cases of battle and assaults.
- Adult pigs: at least 10 m<sup>2</sup> if the stall is also used for couples.
- Indications of noise and lightning.
- Training of employees on topics related to wellbeing.

# **MANAGEMENT OF PIGLETS**

## **FARROWING: FIRST CARE/STEPS TO TAKE**

**COLOSTRUM:** it is the milk produced by the breasts in the first 1-2 days, contains irreplaceable substances that protect piglets from pathologies (antibodies).

**VERY IMPORTANT:** to make sure all the piglets receive mother's milk, because they can only absorb antibodies during the first 12 hours. Moreover, it is very rich in nutrients, irreplaceable for their livelihood and for protection against cold.

During the first 3 – 5 days of their life they need to be in a **warm environment**, above 35°C ⇨ place heating lamps and turn them on before the farrowing; the temperature in the rest of the pen should be the most suitable for the sow, the ideal is over 18-22°C.



## RECOMMENDED TEMPERATURES FOR THE WELLBEING OF THE SOW AND THE PIGLETS

PERIOD	IN FARROWING FACILITY	IN PIGLET AREA
Before farrowing	20°C	----
Days 1°- 2°	20°C	34°C
Days 3°- 7°	18°C	28°C
Days 8°- 14°	18°C	26°C
Days 14°- 25°	18°C	24°C

### HANDLING AFTER FARROWING

**Cutting off the umbilicus:** it should be approximately 2 cm from the abdomen and immediately disinfected.

**Cutting off the tail:** Only if there are many cases of tail bite in the stall, the tail is trimmed to about 4 cm. Traditionally, the tails of new reproducers should NOT be cut. It is usually done on the first day of life.

**Cutting off incisor teeth:** it is not advisable nowadays, there is greater risk of injury to young pigs; it is only done if the sow demonstrates irritation.

**Castration:** it is a drastic but necessary step to overcome the unwanted effects of testicular function: internal meat of a boar of over 90-100kg of live weight would develop unpleasant odour.

It is an unavoidable step to slaughter pigs with the highest weight, but the consequences for the farming are evident: the castrated animal reduces the potential of muscle synthesis in favour of lipid deposition, negatively affecting:

- The quality of the pig;
- The production economy.

**When is castration performed? At early age, within the first two weeks of life.**

Nowadays, there are available injections that inhibit the activity of sexual hormones = and alternative to castration that will increasingly be requested by EU.

**Iron injections:** piglets show modest iron reserves from the birth and nursing cannot compensate this shortage.

The injection is administered in the neck and never in the lower part of the body.

Generally, complex iron is used, with a highly absorbent and useful composition, and usually does not cause anomalous pigmentation of meat.

### **AFTERBIRTH WEIGHT**

It is the number of litter that affects the most the weight of growth and the farrowing cycle.

Underweight piglets weighting under <900g or worse under <700g, even in perfect hygiene conditions in stalls, become subject to high mortality, or if they survive:

- They do not grow much and consequently this prolongs the time necessary to achieve the weight for the market ⇒ **waste of money.**
- They need more feed to grow ⇒ **waste of money.**
- They will have less muscle and more fat ⇒ **low quality meat.**

More advantageous is the elimination of badness at birth or during weaning, forming homogeneous and "reversible" portions".

### **CAUSES OF MORTALITY OF PIGLETS**

Most of cases of piglet mortality are a consequence of **kicking** by the mother → the pen should have certain structure

that will protect piglets, especially when the sow stretches or rises.

In addition, they should be protected from the cold, the mother of the piglets should be fed quality feed, mixing with other animals should be avoided... in order to reduce mortality losses.

### **PROBLEMS WITH WEANING – FEED**

“Weaning” is not only the moment of separation from the mother: it involves **gradual replacement of milk with solid feed**, so it is a whole phase of nursing and integrating other feeds ... just as it is done with humans!

### **FEED AND PRINCIPLES OF PIGLET NUTRITION**

**Lipid:** sow milk has plenty of fat, which piglets use well as they need large amounts of energy for growth, normally 5-6% in the early age diet.

Vegetable fat is more digestible; if we use **fat animals**, they should be of very good quality.

**Proteins:** *early age* diet should be rich in **high quality proteins**.

- Animal proteins (skim milk and whey, fish meal flour) are the best to use.
- Vegetable protein (soy, grains) are less expensive and the digestive tract adapts easily ⇨ we use both sources.
- We should never use big quantities of vegetable protein, they cause digestion problem.

### **Carbohydrates**

- Lactose is highly digestible and favors the necessary microflora (lactobacilli). There should always be a small amount of digestible fibers (pulp, barn).
- Starch (= grains; barley is better than corn) unprocessed, separated and chopped.

### **Keep in mind:**

A good ration for the initial age is costly... however,

- Mortality and pathologies cost a lot, too!
- **It is used only up to 10 days after weaning**, so the consumption is very low.

**Second age ration** (from ~10 to ~25-30 kg of weight): can be less expensive if the necessary attention has been paid be-

fore!! ⇒ no more milk and fish derivatives, no more chopping of feed, the piglet has now adapted.

Every **feed should ALWAYS be introduced gradually**, by mixing feeds for a few days.

## **FEED MANAGEMENT**

DURING NURSING, introduction of solid feed starts from day 5-7 by a few grams, in the piglet pen; from day ~ 10 the piglets should be placed at the feed-through, the feed is gradually increased and it is advisable to change it every day.

AFTER WEANING: if the health condition is good, the feed should be distributed as needed. If they develop diarrhea ⇒ use **rations**.

**Noodle feed is recommended.**

## **THE COMPOSITION OF FEED FOR PIGLETS**

The requirements vary greatly from the stage of nursing (= mother's milk) to the next stage, therefore **two kinds of feeds are advised**:

- The first during nursing, adapted for this phase and in order to facilitate weaning.
- The second to start with **from 10-15 days upon weaning**.

The following indicators should be reported in the tables below:

- Levels of **energy, proteins, lysine, calcium and phosphorus**, advised for the diet of pigs in both phases.
- Examples of the **composition** of whole feeds.

It will be shown case by case how to use raw foods in order to follow these instructions.

**It is difficult to provide the feeds for the initial age because it requires raw feeds.**

**AVERAGE NUTRITIONAL CHARACTERISTICS OF THE FEED FOR PIGS**

	<b>Age 1°</b>	<b>Age 2°</b>
<b>Age in days</b>	40 - 45	65 - 70
<b>Weight in kg</b>	10 - 12	25 - 30
<b>Soluble energy Kcal/kg</b>	3300 - 3600	3300 - 3600
<b>Net energy Kcal/kg</b>	2250 - 2500	2250 - 2500
<b>Maximum fat %</b>	5,0	10
<b>Proteins %</b>	21 - 23	18,5 – 20,0
<b>Lysine %</b>	1,5	1,2
<b>Calcium %</b>	1,3	1,1
<b>Phosphorus %</b>	0,9	0,7

Initial age = from birth for the next 10-15 days.

Second age = from age 10-15 days after weaning up to age 65-70 days and at weight 25-30 kg.



**EXAMPLES OF THE COMPOSITION OF WHOLE FEEDS FOR PIGS**

<b>%</b>	<b>Up to 10 Kg</b>	<b>10 – 25 Kg</b>
<b>Grains and barn</b>	40 - 50	60 – 70
<b>Milk derivatives and fish meal</b>	15 -25	0 - 8
<b>Soy flour extract</b>	10 – 16	15 – 20
<b>Fat</b>	4 - 8	3 - 5
<b>Salts, vitamins</b>	3 - 4	3 - 4



# **GROWTH – FATTENING**

## OBJECTIVES

- Increase in weight;
- Feeding during growth;
- Body quality (%CUTS of THIN SLICES);
- Meat quality (for processing and for direct consumption).

### Factors affecting the composition of pigs during growth:

- **Genetic type and sex;**
- **Feed rationing:** the quantity of the feed or energy/head/day;
- **Environmental conditions:** hot, cold, sheltering systems.

**The quantity of the feed** a pig intakes depends primarily on:

- The genetic type (*“weak”*: less swallowing);
- Sex (castrated > *females*).

**Genetic types of larger bodily mass and meat quality requirements require rationing of feed.**

FEED PER CHOICE is applied only to:

- Subjects with large content of soft tissue.
- With the aim of slaughtering subjects with low weight and at early age (100-110 kg).

**RATIONED FEED** is applied in all other cases, **at least upon reaching the weight of 60 kg:**

- Increase to lower weights, but less spending in feed.
- Development of more muscle, less fat.
- Females should be given more feed with more proteins in comparison to castrated male animals.

### **LIGHT BOAR**

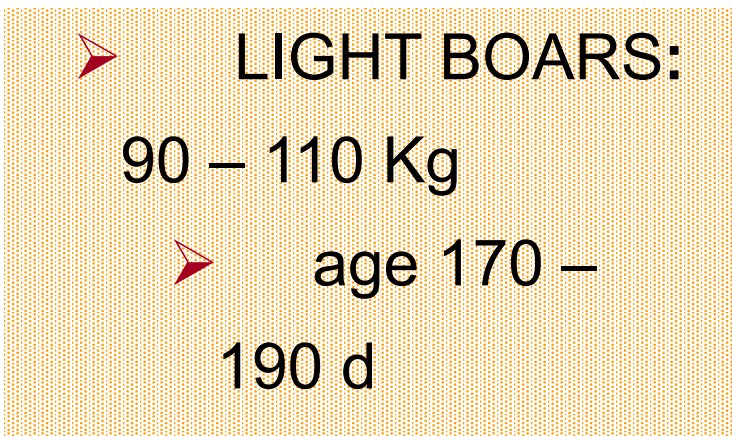

➤ **LIGHT BOARS:**  
90 – 110 Kg  
➤ age 170 –  
190 d

**All feed programs are aimed at:**

- Limiting the development of lard.
- Improvement of the ratio between the weak and the fat subjects.

**One technique that has proven efficient includes:**

1. **HIGH FEED PROGRAM**, a daily quantity of feed equal to 4% of live weight up to reaching the weight of 60 kg.
2. Then, from 60 kg up to slaughter, **LIMITED FEED PROGRAM**: a consistent daily quantity calculated for the weight from 60 kg up to slaughter.

**Feed is distributed IN DRY CONDITION in two daily rations**

#### **GROWTH PHASE – LIGHT BOAR**

Growth: from 25 kg to 60 kg of weight.

Completion: from 60 kg to slaughter.

<b>FEED CHARACTER- ISTICS</b>	<b>GROWTH (26 – 60 kg)</b>	<b>COMPLETION (60 – 110 kg)</b>
ED Kcal/kg	3200 - 3300	3200 – 3300
EN Kcal/kg	2250 - 2300	2250 – 2300
Proteins %	17 - 18	15 – 16
Lysine %	0,95	0,80

## HEAVY BOAR



# HEAVY

**BOARS: 150 – 160**

**Kg**



**age 270 –**

**300 d**

Always use rationed feed, from 30 (or up to 60) kg of weight upward.

**Liquid feed** is preferred to dry feed (better appetite, less powder, if managed well and feed is better):

- **Diluted with water** ⇒ the dilution norm under 2 and 4 (increases with age).
- **With milk whey** ⇒ up to 5-6; it should also be considered that, thanks to the nutrients, 10 liters of food equals about 700-800g of food, and a 150 kg pig can consume up to 15 liters of ⇒ saving feed!

## **GROWTH PHASES – HEAVY BOAR**

From 25 kg up to 60 kg of weight;

From 60 kg up to 110 kg of weight;

From 110 kg up to slaughter.

<b>CAHRACTERISTICS OF FEED</b>	<b>25 – 60 kg</b>	<b>60 – 110 kg</b>	<b>&gt; 110 kg</b>
ED Kcal/kg	3250	3250	3250
EN Kcal/kg	2250	2250	2250
Proteins %	16 - 17	14 - 15	12 – 13
Lysine %	0,85	0,75	0,65

### **What feed do we use for boars in the fattening phase?**

- Grains (corn, barley, wheat, ...) to provide them with energy.
- Protein flours (soy, sunflower) to provide them with proteins and essential amino acids.
- Barn, beat pulp,... to provide them with fiber.
- Integration of vitamins and minerals, because they are sufficiently contained in the raw food.



As for other categories, it will be shown case by case how to use raw materials to ensure **good growth, and good quality of body and meat.**

## **A USEFUL AND EASY TO APPLY TECHNIQUE**

During growth the needs of the pigs for proteins decline constantly, while the needs for energy remain constant.

To meet this continuity of needs without having to frequently change the feed, we can:

- Keep on the farm a **“core feed” with high content of proteins** (e.g. soy flour extract) **and integrate purchased minerals and vitamins.**
- Mix **grains and barn**, produced on the farm or purchased.

At the beginning use more “core” feed and less grains, because protein requirements of the pigs are higher, and preceding further the % of the “core” will progressively decline, while the % of grains will increase.

## **VERY IMPORTANT**

For pigs in the fattening stage it should be noted that some foods may have adverse effects on the quality of the meat and the processed products (salami, etc. ...).

During the last two months before slaughter, avoid feeding:

- Food scraps from our table, human food remains;
- Added fats;
- Raw food containing fats (e.g. semi-integral soy and sunflower).

### **Why?**

They are foods that can transmit **abnormal odour and flavour** to meat. Rationed fats, in particular, cause changes, the fats that the pigs deposit in their body and consequently will be part of the meat and the derived products ⇒ soft fatty parts, which spoil easily and in short time. Conserved, dried, canned products, etc., would be included.

### **HEAVY BOAR – THE QUANTITY OF FEED DISTRIBUTION**

The quantities are **rationed**, on the basis of the weight of boars. We start with a quantity equal to 4% of live weight in the beginning of the cycle, and progressively get down to the quantity equal to 2% of live weight.

The table below is used to report, on the basis of the live weight of pigs, **one example of growth and the quantity of feed distributed in kg and by % of the weight.**

<b>WEIGHT kg</b>	<b>Weight in- crease g/d</b>	<b>Quantity of feed in kg/d</b>	<b>Quantity of feed in % of weight</b>
30-35	633	1,4	4,1
35-40	655	1,5	4,0
40-45	677	1,6	3,8
45-50	699	1,8	3,8
50-55	721	1,9	3,7
55-60	748	2,0	3,6
60-65	765	2,1	3,4
65-70	776	2,2	3,3
70-75	776	2,3	3,2
75-80	776	2,4	3,1
80-85	776	2,5	3,0
85-90	776	2,6	3,0
90-95	776	2,6	2,9
95-100	770	2,7	2,8
100-105	770	2,8	2,7
105-110	759	2,8	2,6
110-115	748	2,9	2,6
115-120	737	2,9	2,5
120-125	726	3,0	2,5
125-130	715	3,1	2,5
130-135	704	3,1	2,4
135-140	693	3,2	2,3
140-145	677	3,2	2,2
145-150	660	3,2	2,2
150-155	638	3,2	2,1
155-160	616	3,2	2,0

**It should be kept in mind that females differ from castrated males:**

**Castrated males:**

- Tend to have fatter body forms.
- Considering the intake of feed, they grow less and consequently the feed is more costly.

**Females:**

- Gain less fat and have lower digestion of feed.
- Need feed with more protein.

**It is therefore recommended to raise males and females in separate pens.**

# **LIVESTOCK FACILITIES**

Various choices in sheltering facilities have a crucial impact on two things:

- Management of animals, and
- Their productivity.

Many aspects are decided in the planning stage: among them are:

- ENVIRONMENTAL SUITABILITY: structures that can be treated with minor "effects" on the surrounding environment (air, water, soil, noise).
- SANITARY FACILITIES (everything full – everything empty), at the end of the cycle – emptying, cleaning, disinfecting and leaving the facilities empty for several days ⇒ significantly reduces microbial presence.
- Moreover, obviously, the structures are selected according to the number of animals, category, etc.

What we will show are the structures used in:

#### INTENSIVE BREEDING

They will serve as an inspiring example, even if in our breeding the choices are much more

#### SIMPLE

Moreover, we will see:

#### LEGISLATIVE NORMS

required by the European Union with regard to pig sheltering structures.

## THE FARROWING – NURSING SECTOR

Sows should be placed there 7 days before farrowing.

**The most widely used structure in intensive breeding is the farrowing pen:**

- Specific equipment for the protection of pigs.
- Restricting the movement of the sow with the least possible threat to her wellbeing.
- Lesser demand for human labor, facilitation of control, facilitated work.
- Better environmental and hygienic conditions for both humans and animals.

An example of a stall, farrowing – nursing pen (Scappi & Gelsi).



The sanitary space should be systematic:

- After the exiting of the animals, wash, disinfect, and leave empty for a few days.
- Structures should be such that they can be washed.

Flooring: make of metal sheets (with holes/cracks, in some cases coated with rubber) or other materials (cement).

A MUST!:

- keep in mind the differences between sows and boars.
- it should be solid and such that it can be washed.
- it should not be harmful to others.

The temperature requirements are very different for sows and for piglets, respectively: plan to use a **heat lamp** for piglets.

**N° of required PLACES**  
**N° of sows x (n° of far-**  
**rowings/sow/year) x period**  
**of use**

**365**



## FUNCTIONAL AREA OF THE STALL

### 1. The sow sheltering area:

- Cage with nursing barriers, closed from above.
- Facing feeder, the one that rises or the one fixed at the door.
- Sufficient width to stretch and to release milk freely.
- Length: depends on the size ..., certainly at least 200 cm (240 cm tot).
- Flooring with large cracks.

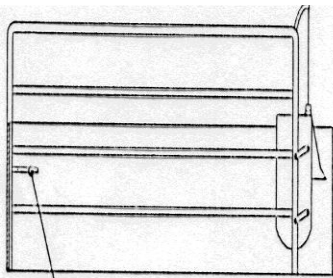

Back tube  
for piglets

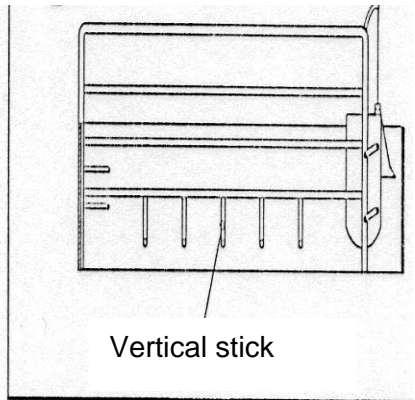

Vertical stick

The farrowing pen: the specifics of the area where the sow is kept:

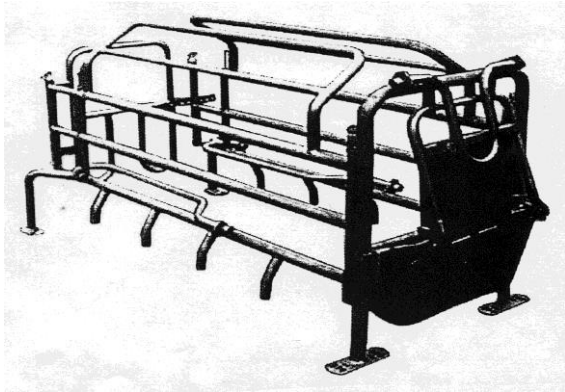

## **2. The nursing area – piglets practicing area:**

- A space aside to the sow area, at least 30 cm wide.
- At least one passage is required from side to side, or rather two: it is usually behind the place where the sow is placed, sometimes even before the feeder.
- Floor with narrow cracks.
- There is a need for a place to drink water from the bottle, otherwise they will not eat the food.
- It is necessary to have a feeder for piglets in their second week of life, to avoid a feeder in the “warm nest”.

### 3. The Rest Area for piglets (“the warm nest”):

- It is inevitable because of the thermal requirement of piglets, at least for the first two weeks: **infrared and light beam lamps**, or
- Continued floor, closed wall.
- Sufficient space for all piglets to lie at the same time.

The farrowing pen, in its various forms, is the most used structure in the maternity sector.

At the farms of our Cooperative, we can have sow pens that meet several conditions:

- Facilitation of washing and cleaning.
- The use of straw as a layer is good, as long as you continually add clean straw and remove everything at the end of the cycle.
- The sow can be free to move, but a space should be created (with pipes, barriers) where only piglets can enter, and it should have heating lamps, straw, a feeder a place where they can drink water.
- If there are a large number of sows at the farm, when in gestation they can all be placed together in the same pen, however, a separate pen for each sow is recommended for the farrowing and nursing periods.
- If too many sows are kept together during nursing, than the space available should significantly be expanded.

## **THE GESTATION SECTOR**

**During gestation** two types of sheltering can be sketched:

- A. Group sheltering;
- B. Individual sheltering;
- C. Intermediate solution: collective pens with individual feeder spots.

### **A. GROUP SHELTERING**

#### **With multiple stalls**

- Requires more space depending on the number of sows; the size of the collective stalls depends on the number of sows expected to come (the farmer's decision) and the minimum calculated space per head (according to the law).
- It becomes a cause for "hierarchical" wars between sows, putting pregnant sows at risk.
- However, the current tendency is that they nevertheless be kept together with the view to the wellbeing of the animal.

#### **2 Types of collective pens:**

- With partial cracks in the floor.
- With full floor and drainage channels.

Keep in mind: feed is rationed (2 times/day): pay attention to the feeder space, which should ensure simultaneous access to all sows!

### **Collective pens**

- **With partial cracks in the floor.** The cracks make 30-40% of the floor, water tubes are positioned in this area. In addition, the pen includes a “full” area with no cracks, for feeding and resting; if straw is laid, it is necessary to have a separating pavement in order not prevent blockage of cracks.
- **With full floor and drainage channels.** If the floor is complete, it would be useful to have a drainage channel with cracks, which can be internal or external (in any case it should be covered). Small pools for washing are also foreseen; or a layer of straw can be provided, but it should be changed often and removed at the end of the cycle.

**A more complete description is made for growth-fattening → similar structures.**

## B. INDIVIDUAL SHELTERING

<b><i>Advantages</i></b>	<b><i>Disadvantages</i></b>
No attacks or aggression that could endanger the pregnant sows, the control of individual sows is much easier.	Requires more expensive equipment, sows cannot move → poorer wellbeing.

The pen of the "cage" type with rear doors according to the new EU norms, the space should be 1.64 m<sup>2</sup> for young pregnant sows and 2.25 m<sup>2</sup> for sows, of which at least 0.95 m<sup>2</sup> and 1.3 m<sup>2</sup> with full surface.

The current European legislation on the protection of pigs allows limited use of such sheltering **up to one third of the pregnancy.**

## C. INTERMEDIATE SOLUTION

Collective pens with individual feeder spots. A collective box with a resting area with permanent bed covers or other types of floors, and single feeders. These can be equipped with swing doors. This reduces aggression at the time of leaving feeder.

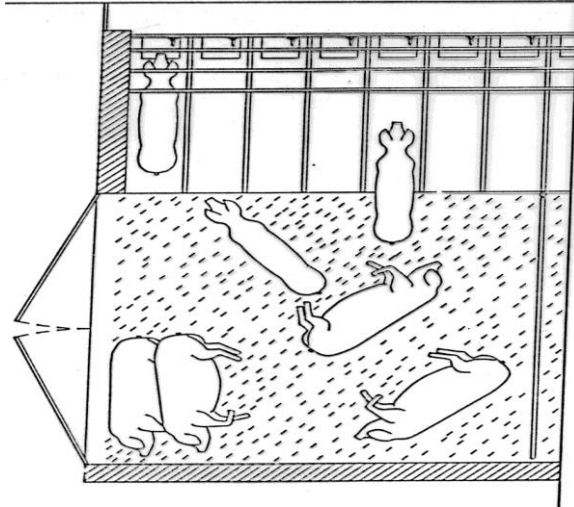

## POST-WEANING SECTOR

From 5-7 kg up to 20-30 kg of live weight: collectives pens. This is a very **delicate period** for piglets, in which the needs are diverse. In this phase pigs feed as per their own choice → abundant **feeders**, water available at all times.

## SHELTERING OF BOARS

**Individual pens** – it is better if the pen in which boars are kept is situated in the same area where the sow pens are situated. Characteristics of the pen:

- At least 8 m<sup>2</sup> (10 for mating);

- External shades useful;
- Full flooring at least 70-80%.

It would be good to have a separate pen for natural mating (min 3,5 x 3,5 m), instead of having it take place in the boar's pen.

Important: the flooring should always be non-slippery and with no barriers.

### **BOARS IN GROWTH –FATTENING: TYPES OF STALLS**

- **PEN WITH FULLY CRACKED FLOOR:** the type that allows the elimination (or almost...!!) of manual cleaning.
- **PEN WITH PARTIALLY CRACKED FLOOR:** the ratio between the partially and fully cracked floors can be different: the most widely used are floor with crack covering 1/3 up to 1/4 of the area.
- **PEN WITH FULL FLOOR (AND DRAINAGE CHANNELS):** if the floor is full, it would be useful to have a drainage channel with cracks, which can be internal or external (in this case it should be covered). It is connected with the pen through the entrance, preferably with swinging doors. Certainly, water pools for washing are foreseen; or, less common, a layer of straw can be created.



Note: the food is rationed (2 times/day): be careful with feeder space, because it should allow simultaneous access to all the pigs.

With regard to the use of STRAW BED – it is not widely used, but there is a revival of interest in order to achieve welfare standards and positive environmental impacts. Usable in all sectors: sows, piglets, fattening. It may be over the entire surface, both in rest areas and in drainage areas.

It is cheaper: simple facilities (old usable structures), without urban wastewater pits, without heating/ventilation facilities.

Organic, non-polluted fertilizers are produced! → better use in agronomy.

THE WELLBEING OF PIGS IS NOT AFFECTED... IF IT IS ADMINISTERED AND MANAGED WELL.

### **MINIMAL FACILITIES FOR VARIOUS CATEGORIES OF PIGS IN GROWTH**

<b>Live weight (Kg)</b>	<b>m<sup>2</sup></b>
<b>&lt; 10</b>	<b>0.15</b>
<b>10-20</b>	<b>0.20</b>
<b>20-30</b>	<b>0.30</b>
<b>30-50</b>	<b>0.40</b>
<b>50-85</b>	<b>0.55</b>
<b>85-110</b>	<b>0.65</b>
<b>&gt;110</b>	<b>0.10</b>



# MAIN PATHOLOGIES

## **Measles**

Infectious bacterial disease of pigs, caused by **eryspelothrix rhusiopothive**, characterized by sudden deaths, fever, skin rashes, arthritis and abortions.

### **Specific and sanitary prevention**

Vaccines are successfully used. Vaccination is done to prevent measles at age above three months, so that the disease is kept under control, it is recommended to disinfect pig stalls.

### **Treatment**

In affected pigs antibiotic therapy and anti-measles serum are successfully used.

## **CLASSIC PLAGUE**

It is infectious viral contagious disease of pigs. This disease usually occurs through contact with diseased animals. Pigs contract various diseases by contact, digestive or breathing routes, with their secretions and excretions. Vaccinations may transmit the disease, and pregnant sows may be carriers of this infection. However, vaccinating sows within the first

10 days of pregnancy increases the immunity and enables the birth of healthy piglets.

### **Clinical signs**

High temperature of 41 degrees Celsius, diarrhea, and conjunctivitis with abnormal drainage, nausea, white color, and neurotic manifestations are indicators that may lead to suspecting the disease and administering the drug therapy. The disease may last 5-10 days.

### **Prophylaxis**

It is based on the mandatory declaration of the disease, slaughter of all diseased and infected animals, in order not to spread the disease further. **Vaccination is done once a year.**

## **CONTAGIOUS GASTROENTERITIS – DISEASE OF THE DIGESTIVE TRACT**

It is a highly contagious viral disease that affects pigs of all ages, but is more noticeable in small pigs, causing high mortality of piglets.

### **Clinical signs**

Piglets suffer diarrhea, yellow-colored vomit of undigested milk, signs of dehydration appear and consequently death.

### **Prophylaxis and treatment**

There is no kind of medication that can treat this coronavirus. Protective or prophylactic measures to prevent this virus in

clean pig farms include vaccination of pregnant sow before farrowing.

## **AFRICAN PLAGUE**

African plague is a viral pig disease characterized by signs of hemorrhagic septicemia and death. This disease is similar to classical plague.

### **Clinical signs**

It lasts for a period of 3 to 15 days, and is characterized by nose secretion, high temperature of up to 42 degrees, anorexia, abdominal digestive problems, and respiratory problems. These signs last from 24 to 48 hours and end with death. The treatment does not yield results, it is not curable.

### **Sanitary prophylaxis**

It includes measures of a general nature to improve the sanitary conditions of pig farms, and to create adequate conditions for the marketing and industrialization of pig products. These are mandatory standard measures for all EU countries.

## **ENZOOTIC PNEUMONIA OF PIGS**

It is a contagious pulmonary disease caused by mycoplasma hyopneumoniae, which is characterized by cough and low death rate. This disease has spread throughout the world, which is a cause for economic loss; over 50% of cases in slaughter are manifested with signs of damage to the lungs.

**Clinical signs**

Anorexia, cough, temperature up to 41.5 degrees Celsius.

**Therapy or treatment**

It can be treated with medications. There exists a vaccine, but it is not administered in our country.

**SWINE FLU**

It is a viral contagious disease that appears as acute pneumonic disease.

**Clinical signs**

Temperature, anorexia, respiratory disorders and cough. Swine flu is a disease treatable with medication.

**Prevention measures – prophylaxis**

As with other diseases, necessary measures should be taken.

# **FEED SUMMARY TABLE**

**FEED RECOMMENDED FOR BOARS IN GROWTH****(KG/HEAD/DAY)**

	<b>WEIGHT FROM 7 TO 30 KG</b>	<b>WEIGHT FROM 30 TO 60 KG</b>	<b>WEIGHT FROM 60 TO 100 KG</b>	<b>WEIGHT FROM 100 TO 150 KG</b>
<b>TOTAL QUANTITY OF FEED KG/D</b>	<b>FREE CHOICE (FEED FROM 0,5 TO 1,5 KG)</b>	<b>FROM 1,5 TO 2,0</b>	<b>FROM 2,0 TO 2,8</b>	<b>FROM 2,8 TO 3,2</b>
<b>CORN, BARLEY, WHEAT, TROTICAL</b>	<b>FROM 0,3 TO 0,9</b>	<b>FROM 0,9 TO 1,5</b>	<b>FROM 1,5 TO 1,8</b>	<b>FROM 2,0 TO 2,2</b>
<b>BARN, DRY CLO- VER, BEAT</b>	<b>FROM 0,1 TO 0,3</b>	<b>FROM 0,3 TO 0,4</b>	<b>FROM 0,4 TO 0,6</b>	<b>FROM 0,5 TO 0,6</b>
<b>SOY, BEANS</b>	<b>FROM 0,1 TO 0,3</b>	<b>FROM 0,3 TO 0,4</b>	<b>FROM 0,3 TO 0,4</b>	<b>0,3</b>



## FEED RECOMMENDED FOR SOWS

(KG/HEAD /DAY)

	STANDING HEAT	CONCEPTION	LACTATION
TOTAL QUAN- TITY OF FEED KG/D	FROM 3,0 TO 4,0	AROUND 3,0	BY CHOICE (FEED FROM 4,0 TO 6,0 KG)
CORN, BAR- LEY, WHEAT, TROTICAL	FROM 2,1 TO 2,8	2,1	FROM 2,5 TO 4,0
BARN, DRY CLOVER, BEAT	FROM 0,5 TO 0,6	0,5	FROM 0,6 TO 0,9
SOY, BEANS	FROM 0,5 TO 0,6	0,5	FROM 0,7 TO 1,1

**“CLASSIC” INDICATIONS FOR FORMULATING DIET FOR PIG-  
LETS (%)**

	<b>UP TO 10 KG</b>	<b>10 – 25 KG</b>
<b>GRAINS (PARTIALLY CHOPPED) AND BARN</b>	<b>30 - 50</b>	<b>60 – 70</b>
<b>MILK DERIVATIVES (WHEY)</b>	<b>15 - 25</b>	<b>0 - 8</b>
<b>SOY, PROCESSED OR INTEGRAL FLOUR</b>	<b>10 – 18</b>	<b>15 – 20</b>
<b>FAT</b>	<b>4 - 8</b>	<b>3 - 5</b>