

M7000VET Veterinary Monitor User's Manual

BIOLIGHT MEDITECH USA

535 Broadhollow Road Ste B-24, Melville, New York 747

[Http://www.biolightmeditechusa.com](http://www.biolightmeditechusa.com)

J/M7000vet-046-2011B2

Preface

Thank you for using M7000VET veterinary monitor.

In order to enable you to skillfully operate the monitor as soon as possible, we provide this user's manual with delivery. When you install and use this instrument for the first time, it is imperative that you read carefully all the information that accompanies this instrument.

Based on the need to improve the performance and reliability of the parts and the whole instrument, we sometimes will make some amendments to the instrument (including the hardware and software). As a result, there might be cases of discrepancies between the manual and the actual situation of products. When such discrepancies occur, we will try our best to amend or add materials. Your comments and suggestions are welcome.

Our liaison-way:

Address: 535 Broadhollow Road Ste B-24, Melville, New York 747

Fax: 888-785-8948

Toll-free consultation hot line: 888-82-BLUSA (888-822-5887)

Statement

This manual contains exclusive information protected by copyright laws and we reserve its copyright. Without written approval of manufacturer no parts of this manual shall be photocopied, Xeroxed or translated into other languages.

The contents and version contained in this manual are subject to amendments without notification.

The version number of this manual: B2

Liabilities of the Manufacturer

Only under the following circumstances will manufacturer be responsible for the safety, reliability and performance of the instrument.

⇒ All the installation, expansion, readjustment, renovation or repairs are conducted by the personnel certified by manufacturer.

⇒ The electrical safety status at the installation site of the instrument conforms to the national standards;

⇒ The instrument is used in accordance with the operation procedures.

Copyright reserved © 2011 Guangdong Biolight Meditech Co., Ltd.

CONTENTS

CHAPTER 1 GENERAL INTRODUCTION.....	1
1.1 INTENDED USE.....	1
1.2 ABOUT THIS MANUAL.....	1
1.3 BRIEF INTRODUCTION TO THE MONITOR.....	3
1.4 APPEARANCE AND STRUCTURE OF THE MONITOR.....	4
CHAPTER 2 IMPORTANT SAFETY NOTES.....	1
2.1 GENERAL SAFETY.....	1
2.2 SOME IMPORTANT NOTES FOR SAFETY.....	3
2.3 CLASSIFICATIONS.....	5
2.4 SAFE OPERATING AND HANDLING CONDITIONS.....	5
CHAPTER 3 GETTING STARTED.....	1
3.1 OPEN THE PACKAGE AND CHECK.....	1
3.2 CONNECT POWER.....	1
3.3 CONNECT TO THE CENTRAL MONITOR SYSTEM.....	4
3.4 POWER ON THE MONITOR.....	4
3.5 CONNECT PATIENT SENSORS.....	4
3.6 CHECK THE RECORDER.....	5
CHAPTER 4 OPERATION INSTRUCTIONS.....	1
4.1 MAIN MENU.....	1
4.2 WORK SCREEN.....	1
4.3 SETUP VOLUME.....	3
4.4 SETUP WAVE SWEEP SPEED.....	3
4.5 SETUP PATIENT INFORMATION.....	3
4.6 SYSTEM SETUP.....	4
4.7 SETUP RECORDER.....	6
4.8 RESTORE DEFAULT SYSTEM SETUP.....	7
4.9 DISPLAY OF TREND.....	7
4.10 DISPLAY INFORMATION ON THE SCREEN.....	9
CHAPTER 5 PARAMETERS MEASUREMENT.....	1
5.1 MEASUREMENT OF ECG/HR.....	1
5.2 MEASUREMENT OF RESP.....	8

5.3 MEASUREMENT OF SpO ₂ /PULSE.....	10
5.4 MEASUREMENT OF TEMP.....	14
5.5 MEASUREMENT OF NIBP.....	17
CHAPTER 6 ALARM.....	1
6.1 ALARM PRIORITY.....	1
6.2 ALARM MODES.....	1
6.3 ALARM SETUP.....	2
6.4 ALARM STATE ICON.....	3
6.5 SILENCE/ALARM PAUSED.....	4
6.6 PARAMETER ALARM.....	4
6.7 WHEN AN ALARM OCCURS.....	5
6.8 ALARM DESCRIPTION AND PROMPT.....	5
CHAPTER 7 RECORDING.....	1
CHAPTER 8 THE MAINTENANCE AND CLEANING.....	1
8.1 SYSTEM CHECK.....	1
8.2 BATTERY MAINTENANCE.....	2
8.3 GENERAL CLEANING.....	3
8.4 CLEANING AGENTS.....	4
8.5 DISINFECTION.....	4
CHAPTER 9 ACCESSORIES AND ORDERING INFORMATION.....	1
APPENDIX A TECHNICAL SPECIFICATIONS.....	1
A.1 ENVIRONMENTAL SPECIFICATIONS.....	1
A.2 PHYSICAL SPECIFICATIONS.....	1
A.3 HARDWARE SPECIFICATIONS.....	1
A.4 PARAMETER SPECIFICATIONS.....	3
APPENDIX B DEFAULT SYSTEM SETUP.....	7
B.1 SYSTEM.....	7
B.2 ECG.....	8
B.3 SpO ₂ /PR.....	8
B.4 NIBP.....	9
B.5 RESP.....	9
B.6 TEMP.....	10
APPENDIX C GUIDANCE AND MANUFACTURE'S DECLARATION OF EMC.....	11

Chapter 1 General Introduction

1.1 Intended use

This veterinary monitor is intended to be used in special procedure labs and other areas of a veterinary hospital or clinic where veterinary monitoring systems are needed. The monitoring parameters include 3-lead or 5-lead electrocardiography (ECG), respiration (Resp), non-invasive blood pressure (NIBP), pulse oximetry (SpO₂) and temperature (Temp).

1.2 About this Manual

This user's manual consists of the following chapters:

Chapter 1 gives an introduction to the content and the specific signs of this manual, the main features and appearance of the monitor, the basic operations of various buttons, the meanings of the signs on the monitor.

Chapter 2 gives important safety notes **Please do read this chapter before using the monitor!**

Chapter 3 gives an introduction to the preparatory steps before using the monitor.

Chapter 4 provides general operation instruction for the monitor, including illustrations of the screen display, normal selection for soft button on screen, details for entry of patient data and trend maps, also.

Chapter 5 gives details of specific parameter measurement, preparatory steps, cables or probes connection, setup of parameters, maintenance and cleaning of equipments and sensors.

Chapter 6 gives detailed description of system alarm, including level and mode of alarm, default setting and changing procedure of alarm parameters, prompt of specific alarms, and the general operation to carry out when an alarm occurs.

Chapter 7 gives detailed description of record function.

Chapter 8 gives general maintenance and cleaning methods of the monitor and its parts.

Signs in this manual:



Warning: Indicates a potential hazard or unsafe practice which, if not avoided, could result in death or serious injury.



Caution: Indicates a potential hazard or unsafe practice which, if not avoid, could result in minor personal injury or product/property damage.



Note: Provides application tips or other useful information to assure that you get the most from your equipment.



Note: This user manual introduced the product that with full configuration. Some functions of the product you bought may be has not provided.

1.3 Brief Introduction to the Monitor

The monitor has features as follows:

- ⇒ Multiple measuring functions include 3-lead, 7-lead ECG/HR, RESP, SpO₂/Pulse, NIBP, Dual TEMP.
- ⇒ Complete built-in module design ensures stable and reliable performance
- ⇒ Can store the trend data for 72 hours and has the function of displaying trend data and trend maps
- ⇒ Function of NIBP measurement reviewing, can store 600 pieces of NIBP measurement data
- ⇒ Optional built-in recorder supports real-time recording, present screen printout and trigger printout by alarm
- ⇒ Parameter display with big character
- ⇒ 7" color high brightness TFT LCD monitor
- ⇒ Portable design, stylish and convenient
- ⇒ Rechargeable maintenance-free battery, can continue working when AC power is off
- ⇒ Nurse call function guarantee patient alarm draws enough attention
- ⇒ Can be connected with the central station to realize centralized monitoring
- ⇒ Is resistant to high-frequency electrostatic and is protected against defibrillation effects

1.4 Appearance and Structure of the Monitor

1.4.1 The Front Appearance

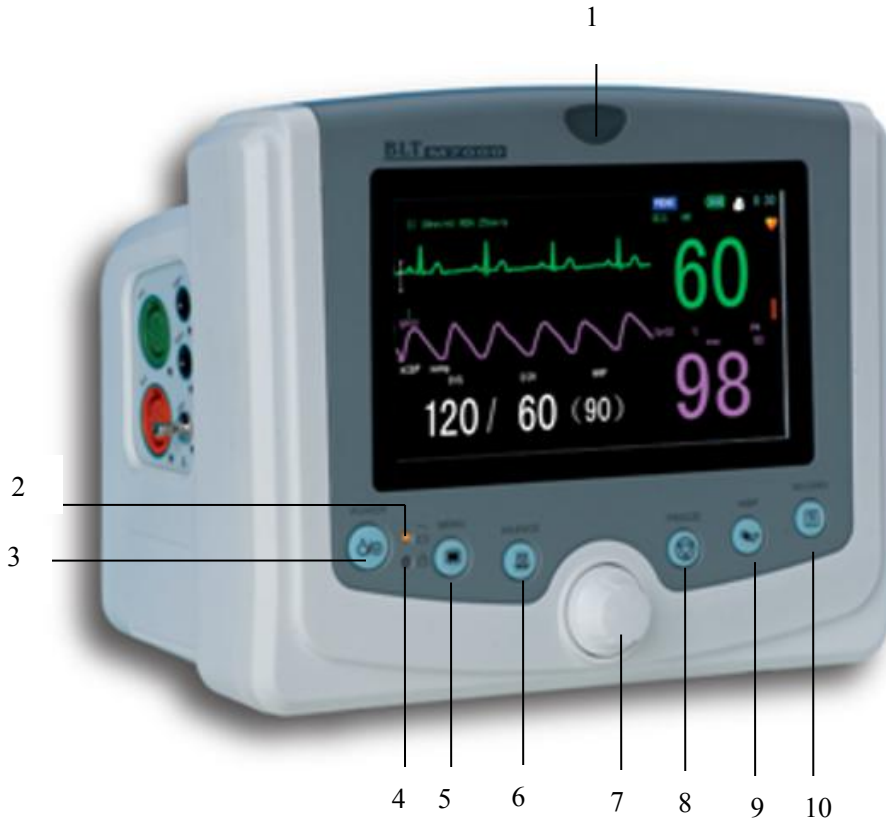

1. Alarm indicator lamp

2. AC power indicator lamp

It is illuminated green when AC power is connected.

It is illuminated orange when AC power is not connected and monitor is powered by battery.

It is turned out when then AC power is not connected.

3.  Power switch

4. Battery charging indicator lamp

It is illuminated when the battery is being charged.

It is go out when the battery is fully charged or no battery in monitor.

5.  Press this key to open the menu dialog when there is no dialog on the screen, otherwise, pressing this key can close the dialog on the screen.

6.  Press this key less than 2 seconds can make the monitor alarm paused or cancel the pause.

Pressing this key over 2 seconds can silence the monitor's audio system or cancel the silence.

7. Trim Knob

The Trim Knob is used for:

Turn left or turn right to move the cursor.

Press down to perform an operation, such as open the menu dialog or selects one option.

8.  Press this key to freeze or defreeze the wave display on screen.

9.  Press this key to start or stop the NIBP measurement.

10.  Press this key to start or stop the real-time recording.

1.4.2 The Left Side Appearance

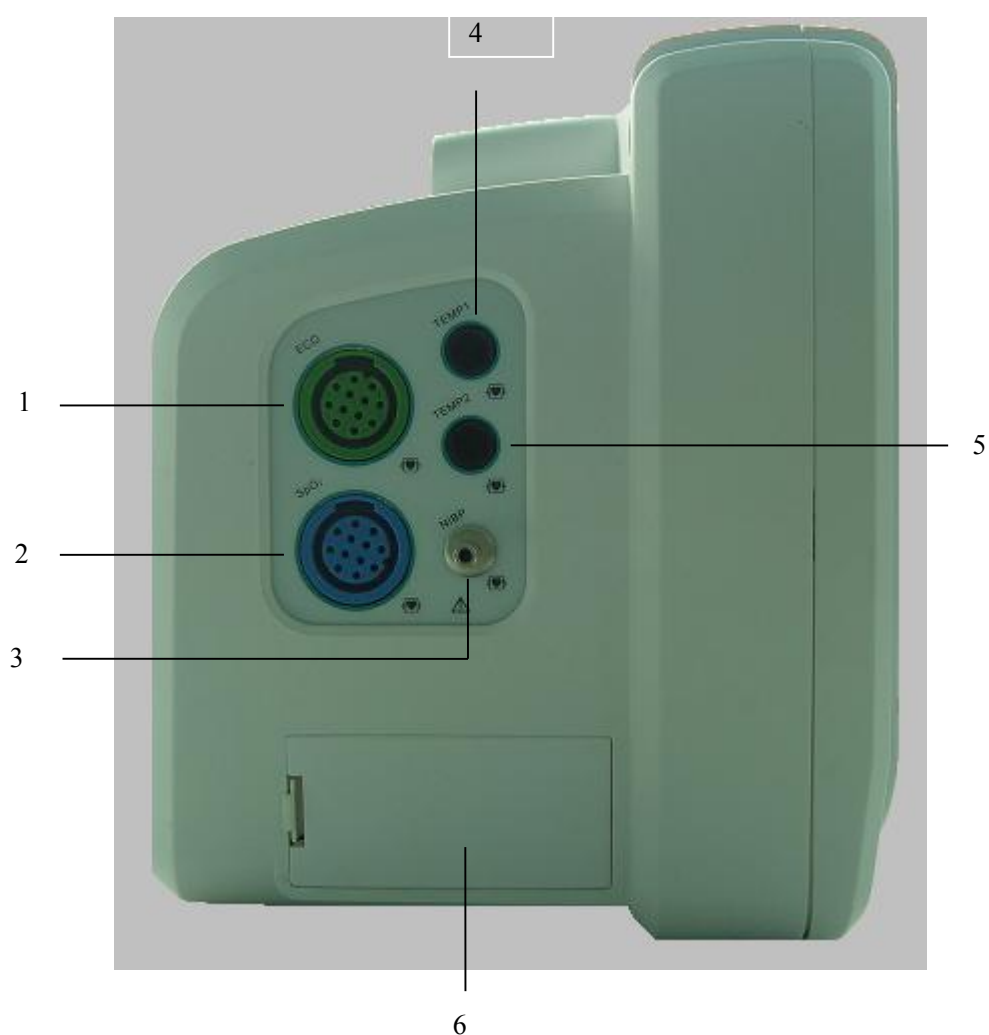

- 1. ECG socket
- 2. SpO₂ socket
- 3. NIBP cuff connector
- 4. TEMP1 socket
- 5. TEMP2 socket

6. Battery cabin

Warning: The sensor cable sockets on the monitor can only be connected with the sensor cables supplied with this instrument and no other cables shall be used.

1.4.3 The Back Appearance



1. AC input socket

Caution: The AC input at the back panel of the Monitor should be connected with the 100V~240V AC Power by electrical wires supplied with this instrument.

2. Network connector

Standard RJ45 socket. It is used for connection with the central monitoring system provided by manufacturer.

3. RS232 socket

The 9 PIN D type socket. The socket is only used for maintenance and upgrading of the monitor by the technical personnel authorized by manufacturer.

4. Nurse Call connector

Nurse call output signal connector.

5. Potential equalization conductor terminal







Base on the requirements of safety and anti-interference, the monitor must be connected with potential equalization system individual. Connect the Potential equalization conductor terminal to the potential equalization system with the green and yellow potential equalization cable. If the protection earth system is damaged, the potential equalization system can take on the safety function of protection earth conductor.



6. FUSE

Fuse specs: T1.6AL250V $\Phi 5 \times 20$ mm

7. Hidden handle

1.4.4 Notes on the signs on the monitor

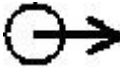
Signs	Notes on the signs
	<p>Defibrillator-proof type CF equipment (Refer to IEC 60601-2-27)</p> <p>The unit displaying this symbol contains an F-Type isolated (floating) applied part providing a high degree of protection against shock, and is defibrillator-proof.</p>
	<p>Attention! Please refer to the document supplied with this instrument (this manual)!</p>
	<p>Potential equalization conductor terminal</p>
	<p>Dangerous voltage</p>
	<p>AC/Battery power indicator</p>
	<p>Battery charge indicator</p>
	<p>Non-ionizing radiation</p>

Signs	Notes on the signs
	Auxiliary output
ECG	Short for “Electrocardiogram”.
SpO₂	Short for “Pulse Oxygen Saturation”
TEMP 1	Short for “Temperature” channel 1
TEMP 2	Short for “Temperature” channel 2
NIBP	Short for “Non-invasive Blood Pressure”
RESP	Short for “Respiration”
	Symbol for the marking of electrical and electronics devices according to Directive 2002/96/EC. The device, accessories and the packaging have to be disposed of waste correctly at the end of the usage. Please follow Local Ordinances or Regulations for disposal.

Chapter 2 Important Safety Notes



Warning: The monitor is intended for VETERINARY USE ONLY. Do not use on human patients.



Warning: Only trained doctors and nurses can use the device.



Warning: The Monitor is not a therapeutic instrument nor is it a device that can be used at home.

2.1 General Safety

1. Safety precautions for safe installation

- ⇒ The AC input socket of the monitor can be connected to the electrical wires and common electrical wire can be used.
- ⇒ Only the power supply type of AC 100V~240V 50/60Hz specified by the Monitor can be used.
- ⇒ Connect the electrical wire to a properly grounded socket. Avoid putting the socket used for it in the same loop of such devices as the air conditioners, which regularly switch between ON and OFF.
- ⇒ Avoid putting the monitor in the locations where it easily shakes or wobbles.
- ⇒ Enough room shall be left around the monitor so as to guarantee normal ventilation.
- ⇒ Make sure the ambient temperature and humidity are stable and avoid the occurrence of condensation in the work process of the monitor.



Warning: Never install the monitor in an environment where flammable anesthetic gas is present.

- #### 2. The Monitor conforms to the safety requirements of IEC 60601-1:1988+A1:1991 +A2:1995 The Monitor is protected against defibrillation effects.

3. Notes on signs related to safety



Defibrillator-proof type CF equipment (refer to IEC 60601-2-27)

The unit displaying this symbol contains an F-Type isolated (floating) applied part providing a high degree of protection against shock, and is defibrillator-proof.

The type CF applied parts provide a higher degree of protection against electric shock than that provided by type BF applied parts.



Attention! Please refer to the documents accompanying this monitor (this manual)!

4. When a defibrillator is applied on a patient, the monitor may have transient disorders in the display of waveforms. If the electrodes are used and placed properly, the display of the monitor will be restored within 10 seconds. During defibrillation, please note to remove the electrode of chest lead and move the electrode of limb lead to the side of the limb. The electrode of the defibrillator should not come into direct contact with the monitoring electrodes. Please ensure the monitor is reliably grounded and the electrodes used repeatedly should be kept clean.



Warning: When conducting defibrillation, do not come into contact with the patient, the bed and the monitor. Otherwise serious injury or death could be resulted in.

5. To guarantee the safe operation of the monitor, the Monitor is provided with various replaceable parts, accessories and consuming materials (such as sensors and their cables, electrode pads). Please use the products provided or designated by the manufacturer.

6. The Monitor only guarantees its safety and accuracy under the condition that it is connected to the devices provided or designated by manufacturer. If the monitor is connected to other undesignated electrical equipment or devices, safety hazards may occur for causes such as the cumulating of the leakage current.

7. To guarantee the normal and safe operation of this monitor, a preventive check and maintenance should be conducted for the monitor and its parts every 6-12 months (including performance check and safety check) to verify the instrument can work in a safe and proper condition and it is safe to the medical personnel and the patient and has met the accuracy required by clinical use.

! **Caution: The Monitor does not contain any parts for self-repair by users. The repair of the instrument must be conducted by the technical personnel been authorized by manufacturer.**

2.2 Some important notes for safety

PATIENT NUMBER

The Monitor can only be applied to one patient at one time.

INTERFERENCE

Do not use cellular phone in the vicinity of this equipment. High level of electromagnetic radiation emitted from such devices may result in strong interference with the monitor performance.

ACCIDENTAL SPILLS

To avoid electric shock or device malfunction, liquids must not be allowed to enter the device. If liquids have entered the device, take it out of service and have it checked by a service technician before it is used again.

ACCURACY

If the accuracy of any value displayed on the monitor or printed on a printout paper is questionable, determine the patient's vital signs by alternative means. Verify that all equipment is working correctly.

ALARMS

Do not rely exclusively on the audible alarm system for patient monitoring. Adjustment of alarm volume to a low level or off during patient monitoring may result in a hazard to the patient. Remember that the most reliable method of patient monitoring combines close personal surveillance and correct operation of monitoring equipment.

The functions of the alarm system for monitoring the patient must be verified at regular intervals.

BEFORE USE

Before putting the system into operation, please visually inspect all connecting cables for signs of damage. Damaged cables and connectors must be replaced immediately.

Before using the system, the operator must verify that it is in correct working order and operating condition.

Periodically, and whenever the integrity of the product is in doubt, test all functions.

CABLES

Route all cables away from patient's throat to avoid possible strangulation.

DISCHARGE TO CLEAR PATIENT DATA

When monitoring a new patient, you must clear all previous patient data from the system. To accomplish this, shut down the device, and then turn on it.

DISPOSAL OF PACKAGE

Dispose of the packaging material, please observe the applicable waste control regulations and keep it out of children's reach.

EXPLOSION HAZARD

Do not use this equipment in the presence of flammable anesthetics, vapors or liquids.

LEAKAGE CURRENT TEST

When interfacing with other equipment, a test for leakage current must be performed by qualified biomedical engineering personnel before using with patients.

BATTERY POWER

The device is equipped with a battery pack. The battery discharges even when the device is not in use. Store the device with a fully charged battery and take out the battery, so that the service life of the battery will not be shortened.

DISPOSAL OF ACCESSORIES AND DEVICE

Disposable devices are intended for single use only. They should not be reused as performance could degrade or contamination could occur.

The service life of this monitor is five years. At the end of its service life, the product described in this manual, as well as its accessories, must be disposed of in compliance with the guidelines regulating the disposal of such products. If you have questions concerning disposal of products, please contact us.

EMC

Magnetic and electrical fields are capable of interfering with the proper performance of the device. For this reason, make sure that all external devices operated in the vicinity of the monitor comply with the relevant EMC requirements. X-ray equipment or MRI devices are a possible source of interference as they may emit higher levels of electromagnetic radiation. Also, keep cellular phones or other telecommunication equipment away from the monitor.

INSTRUCTION FOR USE

For continuous safe use of this equipment, it is necessary that listed instructions were followed. However, instructions listed in this manual in no way can supersede established medical practices concerning patient care.

LOSS OF DATA

Should the monitor at any time temporarily lose patient data, close patient observation or alternative monitoring devices should be used until monitor function is restored.

If the monitor does not automatically resume operation within 60 seconds, restart the monitor using the power on/off switch. Once monitoring is restored, you should verify correct monitoring state and alarm function.

2.3 Classifications

The Monitor is classified, according to IEC601-1: 1988 as:

Type of protection against electric shock:	I
Degree of protection against electric shock:	CF: ECG, Temp, RESP, NIBP, SpO ₂
Degree of protection against harmful ingress of water:	Ordinary Equipment (enclosed equipment without protection against ingress of water)
Degree of safety of application in the presence of a flammable anesthetic-mixture with air or with oxygen or nitrous oxide:	Not suitable
Mode of operation:	Continuous operation

I: Class I equipment

CF: Type CF applied part

Not suitable: Equipment is not suitable for use in the presence of flammable anesthetic mixture with air or with oxygen or nitrous oxide.

2.4 Safe Operating and Handling Conditions

Method(s) of sterilization or disinfection recommended by the manufacturer:	Sterilization: not applicable Disinfection: See "The Maintenance and Cleaning of the System->General Cleaning"
Electromagnetic interference	No cellular telephone nearby
Electro surgical interference damage	No damage
Diathermy instruments influence	Displayed values and prints may be disturbed or erroneous during diathermy
Defibrillation shocks	The Monitor specifications fulfill the requirements of IEC 601-1, IEC 60601-2-27, IEC 60601-2-49
Auxiliary outputs	The system must fulfill the requirements of standard IEC 60601-1-1

Chapter 3 Getting Started

3.1 Open the Package and Check

- ⇒ Unpack the packaging case

Open the packaging case and the accessory box, accessories include electrical wire, various patient sensors and user's manual (this manual), warranty card, certificate and particular paper and the foam case contains the monitor.

- ⇒ Remove the monitor and accessories

! **Caution: please place the monitor on level and stable supporting plane, not on the places that can easily shock or wake. Enough room should be left around the monitor so as to guarantee normal ventilation.**

- ⇒ Keep all the packaging materials for future use in transportation or storage.

- ⇒ Check the monitor and accessories

Check the monitor and its accessories one by one in accordance with the particular paper. Check to see if the parts have any mechanical damages. In case of problems, please contact us or our agent.

3.2 Connect Power

3.2.1 AC Power



- ⇒ Confirm the rated AC current is: AC 100V~240V 50/60Hz

- ⇒ Use the electrical wires provided along with the instrument, put its output end plug (round headed) into the AC current socket on the back of the monitor, and the plug of input end into a grounded socket of the mains (It must be a special socket of the hospital), connect the monitor through the earth one of electrical wires.

- ⇒ When the AC indicating light beside the power switch on the panel of the monitor is green, it means the AC power is on. And when the monitor is not connected to AC power and the built-in DC battery is used as the power source, the indicating light is orange.

 **Warning:** The monitor must be connected to a properly installed power outlet with protective earth contacts only. If the installation does not provide for a protective earth conductor, disconnect the monitor from the power line and operate it on battery power.

 **Note:** The equipment has no mains switch. The equipment is switched completely only by disconnecting the power supply from the wall socket. The wall socket has to be easily accessible.

 **Note:** For measurements in or near the heart we recommend connecting the monitor to the potential equalization system. Use the green and yellow potential equalization cable and connect it to the pin labeled with the  symbol.

3.2.2 Battery Power

The Monitor has a battery pack to provide power to the monitor whenever AC power is interrupted. The battery is generally referred to as the “battery”.

You must charge the battery before using it. There is no external charger. The battery is charged when the monitor is connected to AC power. A fully depleted battery will take about 10 hours to fully charge. To assure a fully charged battery that is ready for use, we recommend that the monitor be plugged into AC power whenever it is not in use.

Depending on usage, you can get about 120 minutes of battery power with a new, fully-charged battery on the monitor. NIBP and SpO₂ monitoring and the usage of the recorder will drain battery power faster than other parameters.

 **Note:** When the monitor is connected to AC current, the battery is in a state of being recharged. When it is unable to be connected to the AC current, the battery can be used to supply power, and at this time it is unnecessary to use the electrical wires, and the instrument can be switched on directly.

 **Note:** A “BATTERY LOW” message at the technical alarm information display area of the screen and an audible system alarm indicate approximate 5 minutes of battery life remaining. You should connect the monitor to an AC power source when the message is displayed.

 **Note: This monitor contains a rechargeable battery. The average life span of this type of battery is approximately three years. When replacement becomes necessary, contact a qualified service representative to perform the replacement.**

Disposal Notice

Should this product become damaged beyond repair, or for some reason its useful life is considered to be at an end, please observe all local, state, and federal regulations that relate to the disposal of products that contain lead, batteries, plastics, etc.

■ Install Battery

The battery storage is located at the bottom of the monitor, following the steps to install a battery.

- 1、 Open the battery gate according to the direction marked on the monitor.
- 2、 Turn the baffle up clockwise.
- 3、 Push the battery into the gate with the electrode point to the bottom of the monitor.
- 4、 After pushing the battery inside the storage withdraw, turn the baffle back to the middle position.
- 5、 Close the gate.

■ Uninstall battery

- 1、 Open the battery gate according to the direction marked on the monitor.
- 2、 Turn the baffle up clockwise.
- 3、 Take out the battery. Then close the gate.

3.3 Connect to the Central Monitor System

 **Warning:** Accessory equipment connected to the analog and digital interface must be certified according to the respective IEC standards (e.g. IEC 60950 for data processing equipment and IEC 601-1:1988 for medical equipment). Furthermore all configurations shall comply with the valid version of the system standard IEC 60601-1-1. Everybody who connects additional equipment to the signal input part or signal output part configures a medical system, and is therefore responsible that the system complies with the requirements of the valid version of the system standard IEC 60601-1-1. If in doubt, consult the technical service department or your local representative.

If the user intends to connect the monitor to the central monitoring system, plug its connecting electrical cable into the Network Connector interface at the back of the monitor.

 **Note:** This monitor can only be connected to the central monitoring system provided by manufacturer, do not attempt to connect this monitor to other central monitoring system.

3.4 Power on the Monitor

- ⇒ Press the power switch on the front panel of the monitor
- ⇒ About 10 seconds after the monitor is switched on, after passing the self-examination of the system, the monitor enters the monitoring screen.

 **Warning:** In case the monitor is found to be working abnormally or indication of errors appears, please do not use this monitor for monitoring and should contact the after-sale service center as soon as possible.

3.5 Connect Patient Sensors

Connect sensor cables to the relevant sockets on the monitor and put sensors on the monitored locations on the body of the patient. Refer to the relevant content of **Chapter 5** for details.



Warning: For safety reasons, all connectors for patient cables and sensor leads (with the exception of temperature) are designed to prevent inadvertent disconnection, should someone pull on the leads. Do not route cables in a way that they may present a stumbling hazard. Do not install the monitor in a location where it may drop on the patient. All consoles and brackets used must have a raised edge at the front.

3.6 Check the Recorder

If the monitor you use has been provided with a recorder, before starting of monitoring please check if the recorder has had recording thermal paper installed. The thermal side (that is the smoother side) should face upwards and a small section should be pulled out onto the outlet of the paper (on the right side of the monitor).

If recording paper has been used up, following the steps to install recording paper.

1. Push down the switch to open recorder.
2. Install the paper with the thermal side upwards.
3. Close the recorder with a section of paper outside of the storage.

For detailed operation information, refer to Fig. following

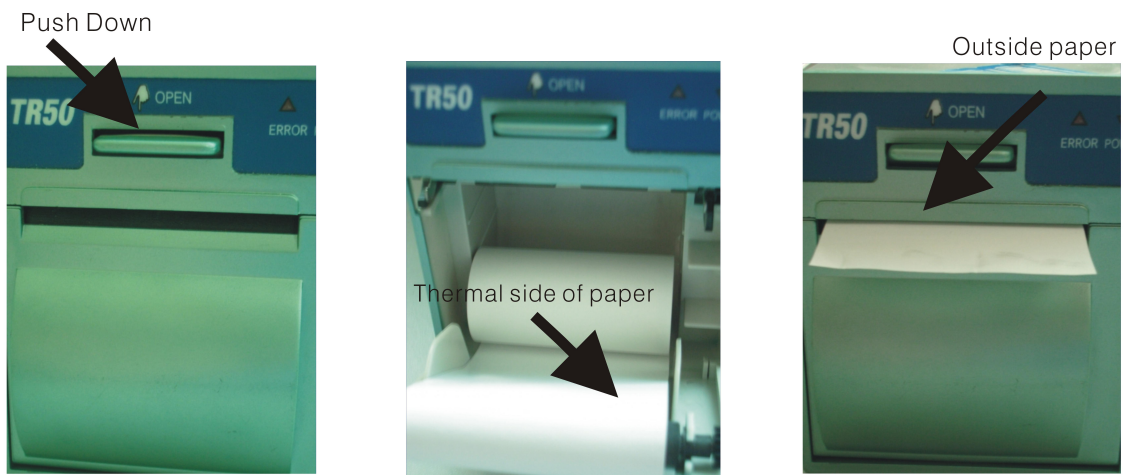





Fig. Install Recording Paper

Chapter 4 Operation Instructions

 **Note: For Concision, the following terms are used to describe one or more operations**
Choose—Turn on the Trim Knob and move the cursor onto the item that needs to be changed.
Conform-- press the Trim Knob.
Select-- move the cursor onto the item and press the Trim Knob.

 **Note: The monitor applies to large animals, medium-size animals and small animals. The patient types include Horse, Dog and Cat. When monitoring a cat or small animal, set to cat; when monitoring dogs or medium-size animals, set to dog; when monitoring horses or large animals, set to horse.**

4.1 Main Menu

Press the  key on front panel to open **【MAIN Setup】** dialogue window, press the  key again can close the dialogue window.

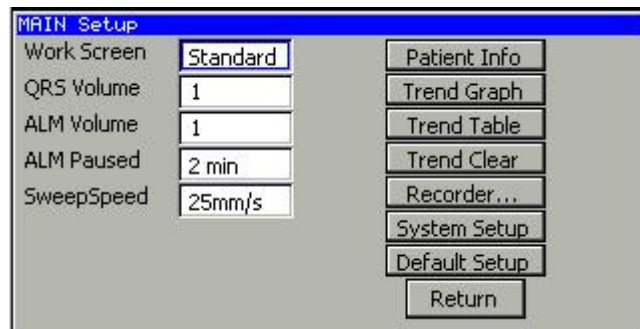

4.2 Work screen

Select **【MENU】** --> **【Work Screen】**, can choose which work screen is used in patient monitoring.

Standard

Standard display screen. Display one ECG wave, PLETH wave, RESP wave and all measurement parameters.



☰ Big Char

Big char display screen. Display one ECG wave, PLETH wave and vital measurement parameters are displayed in magnified characters.

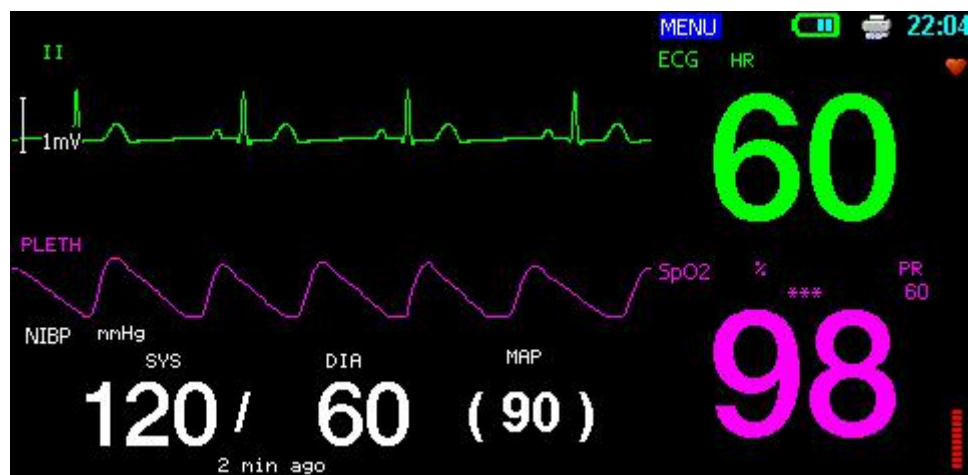

☰ Short Trend

Short trend display screen. Dynamic short trends of HR/PR, SpO₂ and RR and one ECG wave, PLETH wave, RESP wave and all measurement parameters display on the screen synchronously.

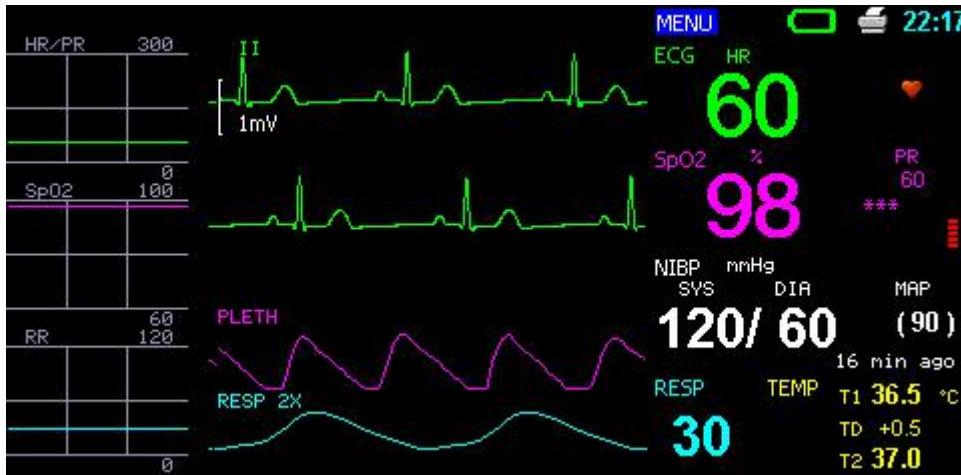

4.3 Setup volume

☰ QRS volume

Select **【MENU】** --> **【QRS volume】**, options are 0~3. Select 0 to close the QRS volume, Select 3 to setup maximal QRS volume.

👉 Note: While SpO₂ is monitoring, the system will adjust the pitch tone of QRS volume according to SpO₂ value measured automatically.

☰ Alarm volume

Select **【MENU】** --> **【ALM volume】**, options are 0~3. Select 0 to close the alarm volume, Select 3 to setup maximal alarm volume.

4.4 Setup wave sweep speed

Select **【MENU】** --> **【Sweep Speed】**, options are 6.25 mm/s, 12.5mm/s, 25mm/s and 50mm/s. This option influences ECG, PLETH waveform displays and recording speed of the recorder.

4.5 Setup patient information

Select **【MENU】** --> **【Patient Info】** button, and a following patient information dialogue window will be displayed.

Patient Info Setup			
ID	<input type="text"/>	Sex	Male
Name	<input type="text"/>	Age	<input type="text"/> Year
Room	<input type="text"/>	Height	<input type="text"/> cm
Bed	<input type="text"/>	Weight	<input type="text"/> Kg
Return			

Patient information includes:

ID	The ID number of patient (setup due to the actual condition of the hospital).
Name	The name of patient. The length of name can be 10 characters at most.
Room	The number of patient sickroom.
Bed	The bed number of patient.
Height	The height of patient.
Sex	The sex of patient (male, female).
Age	The age of patient.
Weight	The weight of patient.

4.6 System setup

Select **【MENU】** --> **【System Setup】** button, and a following system setup dialogue window will be displayed.



4.6.1 System setup

1. Select **【MENU】** --> **【System Setup】** --> **【Language】** , select the displaying language of the system according to the user's favorite.
2. Exit the dialogue windows.

4.6.2 Setup demo function

≡ Enter demo mode

Select **【MENU】**--> **【System Setup】** --> **【Demo】**, select <ON>, input the DEMO password and enter OK.

≡ Exit demo mode

Select **【MENU】** --> **【System Setup】** --> **【Demo】** , select <OFF>.

Note: The purpose of waveform demonstration is only to demonstrate the machine performance, and for training purpose. In clinical application, this function is not recommended because the DEMO will mislead the hospital workers to treat the waveform and parameter as actual data of the patient, which may result in delay of treatment or mistreatment.

4.6.3 Setup system time

Select **【MENU】** --> **【System Setup】** : setup <Year>, <Mon>, <Date>, <Hour>, <Min>, <Sec> and select **【OK】** to confirm.

Caution: The change of time will influence the trend data saved, or lose data. Setup time before monitoring and restart the monitor after setup is suggested. The changed time will be available after exit the current window.

4.6.4 Setup display color

Select **【MENU】** --> **【System Setup】** --> **【Color Setup】**, and a following color setup window will be displayed.

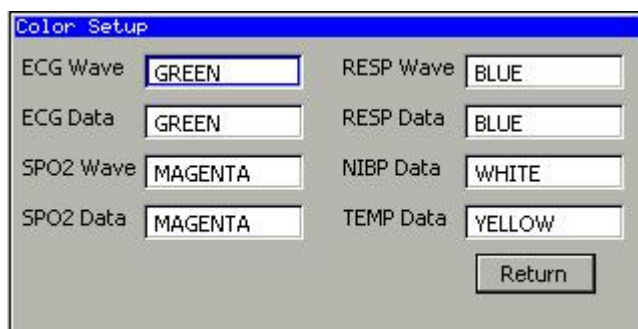

User can change the display colors of waveforms and data displayed on screen freely.

4.6.5 Setup nurse call function

Nurse Call is a function that the monitor will send signal to call nurse when the alarm conditions destined are occurred.

The monitor has a nurse call output socket, connect the socket to the nurse call system of the hospital by the nurse-call cable provided along with the monitor, the nurse call function can be realized.

The nurse call function is valid when the following conditions are concurrent:

1. The nurse call function is open.
2. An alarm condition destined is occurred.
3. The monitor is not in the state of alarm paused or system silence.

Select **【MENU】** --> **【System Setup】** --> **【Nurse Call】** , and a following nurse call setup window will be displayed.



ALM Condition	Select the alarm condition type that can trigger the nurse call action. The options of alarm condition type include physical alarm condition and technical alarm condition.
ALM Level	Select the alarm level that can trigger the nurse call action. The options of alarm level include low, medium and high alarm levels.

If there are nothing selected in the **【ALM Condition】** and the **【ALM Level】** , any alarm occurrence will not trigger the nurse call action.

Warning: The nurse call function should not be used as the primary patient alarm inform source. It is necessary for combining the auditory and visual alarm signal and the patient clinical feature and symptom as the primary information to medical and nursing staff about the physiological condition of the patient.

4.6.6 System information

Select **【MENU】** --> **【System Setup】** --> **【About】**, the system information window will be displayed, system information includes software version and manufacturer information.

4.7 Setup recorder

Select **【MENU】** --> **【Recorder...】** , a following setup recorder window will be displayed.

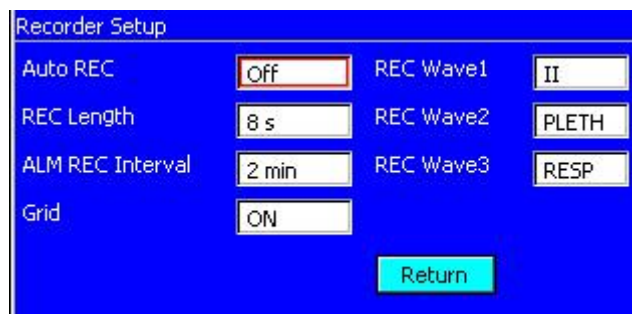

Auto REC	Turn off auto recording or select the interval to do auto recording. The content of auto recording includes three optional waveforms and all parameters measured.
REC Length	Select the recording length of waveform in auto recording. The Options are 8s, 12s and 16s.
ALM REC Interval	Select the interval of alarm recording when the alarm is occurring continuous. Alarm recording function will be disabled when <OFF> is selected.
Grid	Select if the grid is recorded in the waveform recording area of the recording paper. Options are <OFF>, <ON>.
REC Wave1	Select the waveform recording in the first line. Select <Off> close the wave display or select certain waveform to record.
REC Wave2	Select the waveform recording in the second line. Select <Off> close the wave display or select certain waveform to record.
REC Wave3	Select the waveform recording in the third line. Select <Off> close the wave display or select certain waveform to record.

4.8 Restore default system setup

Select **【MENU】** → **【Default Setup】**, and a following default system setup window will be displayed, select one item in this window will restore the system setup to default setup. There are three options: Horse, Dog, Cat. When monitoring a cat or small animal, set to **cat**, when monitoring dogs or medium-size animals, set to **dog**, when monitoring horses or large animals, set to **horse**.



4.9 Display of trend

4.9.1 Display of trend map

Select **【MENU】** → **【Trend Graph】**, and a following trend graph window will be displayed.

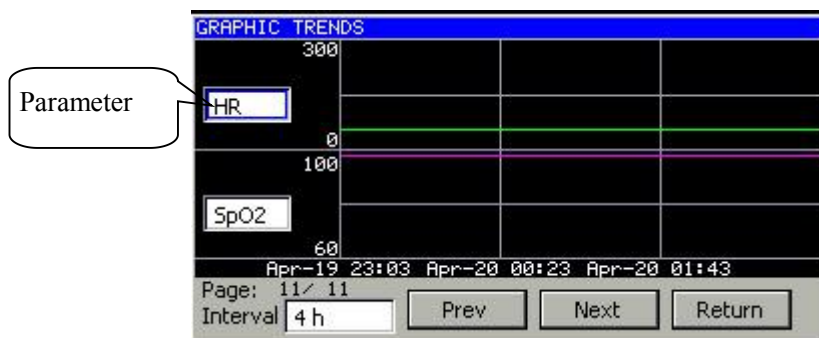

Parameter	One of the parameters of HR, SpO ₂ , RR and NIBP can be chosen to see over its trend graph.
Interval	User can choose from 4, 8, 12, 16, 24, 48 and 72 hours, which is the displayed length of trend graph time in one page.
Prev	Turn to previous page.
Next	Turn to next page.
Return	Exit trend graph window.

4.9.2 Display of trend data

Select **【MENU】** --> **【Trend Table】**, and a following trend data window will be displayed.

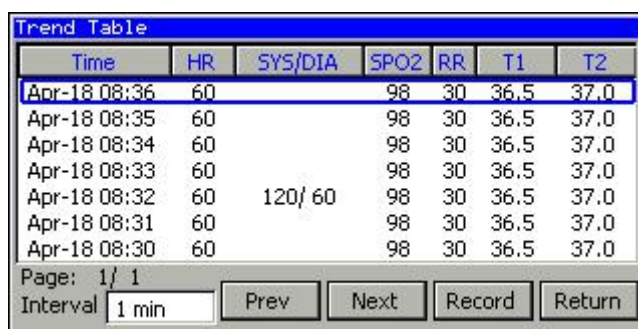

Interval	User can choose from 1, 2, 3, 4, 5, 10, 15, 30, 60, 90 minutes and 2, 4, 8 hours, which is the displayed interval between trend data item.
Prev	Turn to previous page.
Next	Turn to next page.
Record	Print the trend data in current screen through recorder.
Return	Exit trend table window.

4.9.3 Clear trend data

Select **【MENU】** --> **【Trend Clear】**, and a following trend clear prompt window will be displayed.



Select **【YES】** will delete all data in trend graph, trend table and NIBP review table.

Note: The Monitor can store maximum 72 hours trend data and 600 items of NIBP measurement result. When the maximum trend data storage time is achieved, the monitor would not save new trend data unless the old trend data cleared.

4.10 Display information on the screen

4.10.1 System state display area

The system state is displayed at the right top of the screen.



The auditory alarm signal turns off, that is to say, when an alarm takes place, the monitor will not make any sound.



The recorder is ready. The icon will flicker when the recorder is working.



Recorder is lack of paper, the door is not closed or other faults.



The battery is full.



The battery is half-full.



The battery is empty.

Note: When the battery is empty, the system will alarm, in order to remind the users to engage the AC power and charge up. If the monitor has not been charged up in time, the monitor will shut down in 5 to 15 minutes because of short of power.

4.10.2 Alarm information display area

Alarm information is displayed at the top of the screen.

Alarm information region:

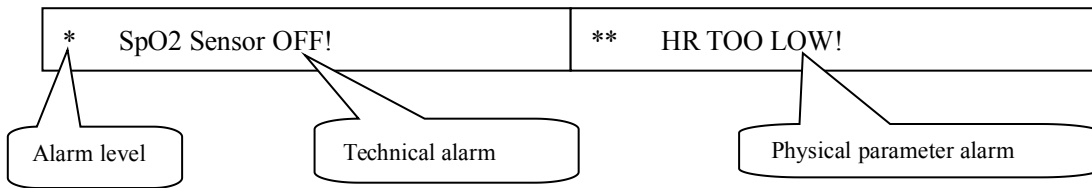

Alarm level:

- * Low-level alarm
- ** Middle-level alarm
- *** High-level alarm

Parameter alarm, the parameter will display flickeringly in order to warn.

Chapter 5 Parameters Measurement

5.1 Measurement of ECG/HR

5.1.1 Principles of Measuring

Before the mechanical contraction, the heart will firstly produce electrization and biological current, which will be conducted to body surface through tissue and humors; the current will present difference in potential in different locations of the body, forming potential difference ECG, also known as body surface ECG or regular ECG, is obtained by recording this changing potential difference to form a dynamic curve. The Monitor measures the changes in the body surface potentials caused by the heart of the patient, observes the cardioelectric activities, records the cardioelectric waveforms and calculates the HR through the multiple electrodes connected to various cables. The measurement range of HR is 10~350bpm.

5.1.2 Precautions during ECG Monitoring

 **Warning: Before connecting the ECG cables to the monitor, please check if the lead wires and cables have been worn out or cracked. If so, they should be replaced.**

 **Warning: It is imperative to only use the ECG cables provided with the instrument by manufacturer.**

 **Warning: The EQUIPMENT is capable of displaying the ECG signal in the presence of pacemaker pulses without rejecting pacemaker pulses.**

 **Warning: To avoid burning, when the electrotome operation is performed, the electrodes should be placed near the middle between ESU grounding pad and electrotome and the electrotome should be applied as far as possible from all other electrodes, a distance of at least 15 cm/6 in. is recommended.**

 **Warning: When the electrotome operation is performed, electrodes should be placed on the circle which centre is the operation area, the ECG leadwires should be intertwined as much as possible. The main unit of the instrument should be placed at a distance from the operation table. Electrical wires and the ECG lead cables should be partitioned and should not be in parallel.**

 **Note:** When several parts of equipment are interconnected, the total leakage current is limited to the safety range according to standards IEC 60601-2-27.

 **Warning:** The monitor is protected against defibrillation effect. When applying defibrillator to the patient, the monitor will experience transient disorderly waveforms. If the electrodes are used and placed correctly, the display of the monitor will be restored within 10 seconds. During defibrillation, the chest leads such as V₁~V₆ should be removed and such limb electrodes as RA, LA, RL, LL should be moved to the side of the limbs.

 **Warning:** All the electrodes and conducting part shall not be into contact with any other conductors including the ground. For the sake of patient safety, all the leads on the ECG cables must be attached to the patient.

 **Warning:** When conducting defibrillation, it is imperative to only use the electrodes recommended by manufacturer.

 **Warning:** Do not come into contact with the patient, bed and the monitor during defibrillation.

 **Warning:** The Monitor cannot be directly applied to heart and cannot be used for the measurement of endocardio ECG.

5.1.3 Preparing the Measurement of ECG/HR

- 1) Plug the ECG cable into the ECG socket of the monitor.
- 2) Place the electrodes onto the body of the patient and connect them to the relevant lead wires of the ECG cables, and at this moment ECG waveforms will appear on the screen.
- 3) Set the parameters relevant to ECG monitoring.

5.1.4 Connecting the ECG Cables to the Monitor

The Monitor is provided with three different ECG cables relevant to 3-Lead or 7-Lead ECG monitoring:

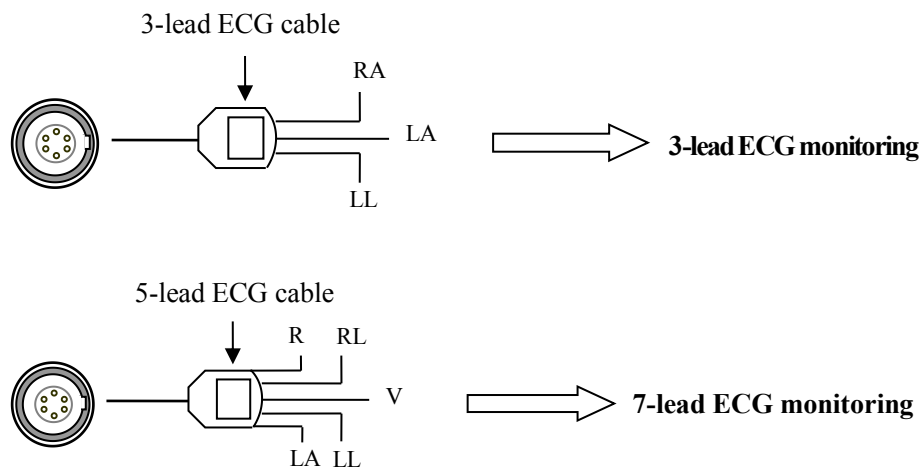

1) 3-lead ECG cable

- ⇒ Including three limb leads: RA, LL, and LA.
- ⇒ Realize 3-lead ECG monitoring.

2) 5-lead ECG cable

- ⇒ Including four limb leads: RA, RL, LL, LA and one chest-lead V.
- ⇒ Realize 7-lead ECG monitoring.

5.1.5 Connecting the ECG Electrodes to the Patient

1) Connection steps

⇒ Lead contact

Sites where leads are attached to the body must be properly prepared to optimize contact.

Dogs and cats have enough electrolyte material on their skin and hair so that merely moistening lead sites with 70% isopropyl alcohol is appropriate. This will usually be sufficient for ECG monitoring for a short time, 30 to 60 minutes, depending upon the relative humidity.

For monitoring during longer periods, an electrode paste should be used. It is best to first wet the hair at the lead attachment site with alcohol; then place paste on the moistened hair and skin. It is important that the paste be in direct contact with skin. For patients with dense undercoat, rub paste with fingers to assure that it has made contact with skin. Crocodile clips are supplied with this monitor and they must open wide enough to firmly but gently grasp the skin.

- ⇒ Connect the cable leads to the electrodes.

 **Note:** For patients who tremble a lot or patients with especially weak ECG signals, it might be difficult to extract the ECG signals, and it is even more difficult to conduct HR calculation. For severely burnt patients, it may be impossible to stick the electrodes on and it may be necessary to use the special pin-shape electrodes. In case of bad signals, care should be taken to place the electrodes on the soft portions of the muscle.

 **Note:** Check the irritation caused by each electrode to the skin, and in case of any inflammations or allergies, the electrodes should be replaced and the user should relocate the electrodes every 24 hours or at a shorter interval.

 **Note:** When the amplifier is saturated or overloaded, the input signal is medical meaningless, then the equipment gives an indication on the screen.

2) Location for electrode placement

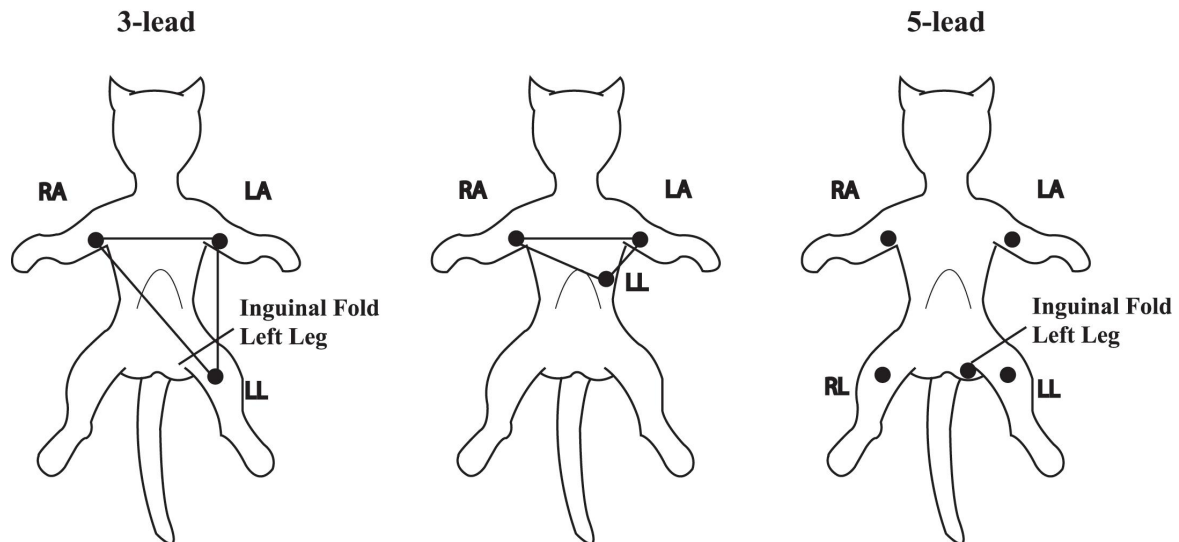

The following table shows the lead name to identify each lead wire and its associated color of AHA and IEC standards.

AHA Label	AHA Color	IEC Label	IEC Color	Location
RA	White	R	Red	Right foreleg.
LA	Black	L	Yellow	Left foreleg.
RL	Green	N	Black	Right hind leg.
LL	Red	F	Green	Left hind leg.
V	Brown	C	White	4th Intercostal Space (left)

When conducting 3-leads ECG monitoring, use 3-lead ECG cable. The three limb-leads of RA, LA and LL should be placed on the relevant locations. This connection can establish the lead of I, II, III.

When conducting 7-leads ECG monitoring, use 5-lead ECG cable. The four limb-leads of RA, LA, RL and LL should be placed on the relevant locations. This connection can establish the lead of I, II, III, aVR, aVL, aVF; according to actual needs, chest lead V can be placed on any of the locations between V₁~V₆, respectively making one lead of V₁~V₆ established.

5.1.6 ECG Setup menu

Select the <ECG> button on the screen, and a following ECG setup window will be displayed.

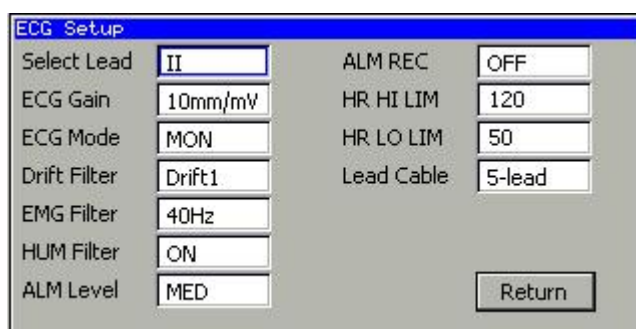



Select Lead	Select the monitoring lead, the selections: <I>, <II>, <III>, <aVR>, <aVL>, <aVF> and <V->.
ECG Gain	Select the gain of the ECG waveform, the selections: <2.5mm/mV>, <5mm/mV>, <10mm/mV>, <20mm/mV>, <40mm/mV> and <AUTO>.
ECG Mode	There are four operation modes, which are unfiltered, operation, monitoring and user. They are identified as: <UNFI >, <OPS>, <MON>, <USER> in the ECG menu.
Drift Filter	Drift filter. Three options are provided: <OFF> (time-constant > 3.2 seconds, the comeback time of ECG waveform is long, and the distortion of the waveform is little), <Drift 1> (time-constant > 0.3 second, the comeback time of ECG waveform is shorter), <Drift 2> (time-constant > 0.15 second, the comeback time of ECG waveform is

	shortest, and the distortion of the waveform is obvious).
EMG Filter	The low pass filter in order to filtrate the EMG noise, the selections: <OFF>, <25Hz > and <40Hz >.
HUM Filter	The notch filter in order to filtrate the HUM noise. Select <ON> open the filter, select <OFF> close the filter.
ALM Level	Set the alarm level of ECG parameter, the selections: <OFF>, <LOW >, <MED > and <HIGH >.
ALM REC	Select <ON>, the alarm of ECG/HR parameter will trigger alarm recording. Select <OFF>, the alarm of ECG/HR parameter will not trigger alarm recording.
HR HI LIM	Select the upper limit of HR alarm, adjustable range: 0 ~ 350bpm , adjust continuously, equal or above the lower limit.
HR LO LIM	Select the lower limit of HR alarm, adjustable range: 0 ~ 350bpm , adjust continuously, equal or below the upper limit.
LEAD Cable	Select the ECG input cable, the selections: <3- lead>, <5-lead>.

The states of the filter under various modes of ECG:

ECG mode \ Filter	Drift filter	HUM filter	EMG filter
UNFI	OFF	OFF	OFF
OPS	Drift 2	ON	25Hz
MON	Drift 1	ON	40Hz
USER	Optional	Optional	Optional

 **Note:** Under the mode of UNFI, OPS and MON, the state of the filter cannot be regulated. Only under the state of USER can the state be regulated.

 **Caution:**

- When “3 Lead” is selected as <Lead Cable>, ECG is in 3-lead input mode, and only Lead I, II or III can be measured.
- When “5 Lead” is selected as <Lead Cable>, ECG is in 5-lead input mode, and Lead I, II, III, aVR, aVL and aVF and one chest lead can be measured.

5.1.7 Display of ECG parameter

≡ Waveform display



≡ Data display



! **Caution:** Whenever ECG leads are connected, heart rate measured by ECG will display on the position of heart rate parameter. When ECG leads are not connected, while SpO₂ sensor is connected, pulse rate will display on the position of heart rate parameter automatically.

5.1.8 Maintenance and Cleaning

If there is any sign that the ECG cable may be damaged or deteriorated, replace it with a new one instead of continuing its application on the patient.

To avoid extended damage to the equipment, disinfection is only recommended when stipulated as necessary in the hospital maintenance schedule, disinfection facilities should be cleaned first.

■ **Cleaning:**

Use a piece of clean cloth moistened in water or mild soap solution to clean the ECG cable.

■ **Disinfection:**

Use a piece of clean cloth to wipe the surface of the cable with a 10% bleach solution or 2% Cidex®, clean with clear water and wipe it dry.

5.2 Measurement of RESP

5.2.1 Principles of Measuring

The Monitor measures RESP with the method of impedance. When a patient exhales and inhales, changes will take place in the size and shape of the thoracic cavity, causing consequent changes in the impedance between the two electrodes installed at the patient's chest. Based on the cycle of impedance changes, the respiration rate can be calculated. The measuring range of respiration rate is 0~150 rpm.

5.2.2 Preparing the Measurement of RESP

- 1) Plug the ECG cable into the ECG socket of the monitor.
- 2) Place the various pads of the electrodes onto the body of patient and connect them to the relevant lead cables. At this moment, the screen will show RESP waves and the RESP rate will be calculated.
- 3) Set the parameters relevant to RESP monitoring.

5.2.3 Connect the ECG Cable with Patient and the Monitor

To measure RESP parameters, it is unnecessary to use other cables and it is only necessary to use the two RA and LL leads in the ECG cable.

 **Warning: For the sake of safety, all the leads on the ECG cable must be connected to the body of patient.**

5.2.4 RESP Setup menu

Select the <RESP> button on the screen, and a following RESP setup window will be displayed.

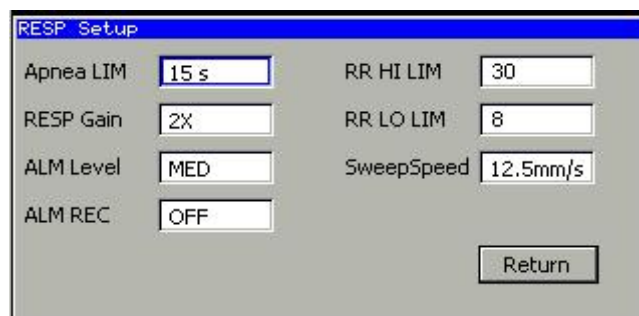

RESP Setup			
Apnea LIM	15 s	RR HI LIM	30
RESP Gain	2X	RR LO LIM	8
ALM Level	MED	SweepSpeed	12.5mm/s
ALM REC	OFF		
Return			

Apnea LIM	Define the concept of choke. When the duration of no RESP reaches this limit, apnea alarm will be triggered. Range: 10~60s.
RESP Gain	Select the magnify times of RESP gain. Options: <1x>, <2x>, <4x>.
ALM Level	Setup alarm level of RESP parameters, the selections: <OFF>, <LOW>, <MED> and <HIGH> are optional.
ALM REC	Select <ON>, the alarm of RESP parameter will trigger alarm recording. Select <OFF>, the alarm of RESP parameter will not trigger alarm recording.
RR HI LIM	Select the alarm upper limit of RESP rate. Range: 0~120rpm, adjust continuously, equal or above the lower limit.
RR LO LIM	Select the alarm lower limit of RESP rate. Range: 0~120rpm, adjust continuously, equal or below the upper limit.
Sweep Speed	Set the sweep speed of RESP waveform. Options are <25mm/s>, <12.5mm/s>, <6.25mm/s>.

5.2.5 Display of RESP parameter

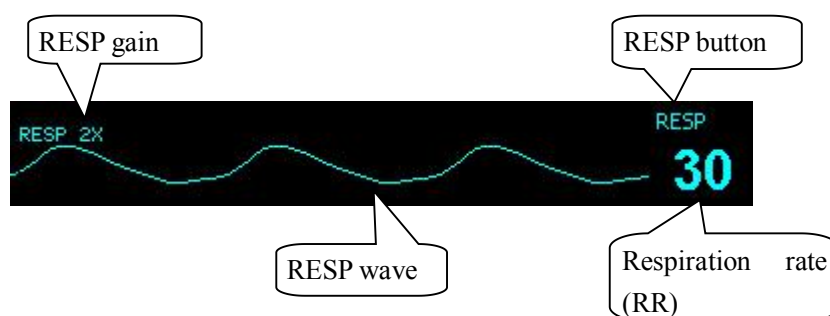

5.2.6 Maintenance and Cleaning

No special operation demanded. Please refer to **chapter 5.1.8**.

5.3 Measurement of SpO₂/Pulse

5.3.1 Principles of Measuring

The measurement of degree of blood oxygen saturation (also known as pulse oxygen saturation, usually shortened as SpO₂) adopts the principles of light spectra and volume tracing. The LED emits lights with two specific bandwidths, which are selectively absorbed by hemoferrum and desoxyhemoglobin. The optical receptor measures the changes in the light intensity after the light passes the capillary network and estimates the ratio of hemoferrum and the total hemoglobin. The measurement range of SpO₂ is 0~100%.

$$\text{Degree of pulse oxygen saturation \%} = \frac{\text{hemoferrum}}{\text{hemoferrum} + \text{desoxyhemoglobin}} \times 100\%$$

Abnormal hemoglobin, carboxyhemoglobin, oxidative hemoglobin are not directly measured, for they are not the affecting factors in the measurement of SpO₂

The sensor measurement wavelengths are nominally 660nm for the Red LED and 940nm for infrared LED.

The Monitor adopts FFT filter and signal correlation techniques to deal with SpO₂ module's pulse waveform signals. Before the measurement of SpO₂, the noise produced in the false trace is smoothed so as to the eliminate disturbance in the measurement of saturation. In case of weak blood pulse, the noise produced by some confinements of electrical properties is greatly reduced.

The Monitor is designed for measurement and recording of functional saturation.

5.3.2 Preparing the Measurement of SpO₂/Pulse

- 1) Plug the SpO₂ sensor cable into the SpO₂ socket of the monitor.
- 2) Select a sensor and clip that is appropriate for the patient.
- 3) Clean the sensor and sensor clip separately before and after each use.
- 4) Put the sensor on the tongue or ear of animal. The preferred sensor application site for canine, feline and equine animals is on the tongue, with the sensor's optical components positioned on the center of the tongue. Alternatively, the sensor and clip may be applied to the animal's lip, toe, ear, prepuce, or vulva.
- 5) Set up the parameters relevant to SpO₂ and pulse monitoring.

 **Caution:** In case it is necessary to add a clip to fix the fingertip sensor, the cable instead of the sensor itself should be clipped. Please note that the cable of sensor should not be pulled with force.

 **Note:** Frequent movements of the sensor may result in errors in the readings of the monitor.

 **Warning:** In case NIBP and SpO₂ are measured at the same time, please do not place the SpO₂ sensor and the NIBP cuff on the same end of the limb, for the measurement of NIBP will block blood flow, affecting the measurement of SpO₂.

 **Warning:** Do not conduct SpO₂ measurement on the finger smeared with fingernail oil, otherwise unreliable measurement results might be produced.

 **Note:** When using SpO₂ sensor, care should be taken to shield external light sources, such as light of thermo therapy or ultraviolet heating light, otherwise the measurements may be disturbed. Under such conditions as shock, hypothermia, anemia or the use of blood vessel-activating drugs, and with the existence of such substances as carboxyhemoglobin, methemoglobin, methylene blue the result of the SpO₂ measurement will be possibly not accurate.

 **Note:** SpO₂ waveform is not proportional to the pulse volume.

 **Warning:** Do not use the sterile supplied SpO₂ sensors if the packing or the sensor is damaged and return them to the vendor.

 **Warning:** Prolonged use or the patient's condition may require changing the sensor site periodically. Change the sensor site and check skin integrity, circulatory status, and correct alignment at least every 4 hours.

5.3.3 SpO₂ Setup menu

Select the <SpO₂> button on the screen, and a following SPO₂ setup window will be displayed.

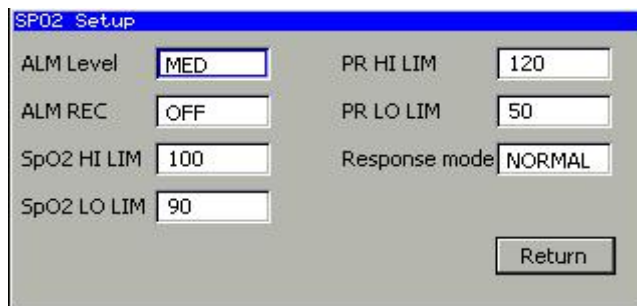

The screenshot shows a window titled "SP02 Setup" with the following settings:

ALM Level	MED	PR HI LIM	120
ALM REC	OFF	PR LO LIM	50
SpO2 HI LIM	100	Response mode	NORMAL
SpO2 LO LIM	90		

Return

ALM Level	Setup alarm level of SpO ₂ parameters, the selections: <OFF>, <LOW>, <MED> and <HIGH> are optional.
ALM REC	Select <ON>, the alarm of SpO ₂ parameter will trigger alarm recording. Select <OFF>, the alarm of SpO ₂ parameter will not trigger alarm recording.
SpO₂ HI LIM	Select the SpO ₂ alarm high limit, range: 0~100% , adjust continuously, equal or above the lower limit.
SpO₂ LO LIM	Select the SpO ₂ alarm low limit, range: 0~100% , adjust continuously, equal or below the upper limit.
PR HI LIM	Select the PR alarm high limit, range: 0~255bpm , adjust continuously, equal or above the lower limit.
PR LO LIM	Select the PR alarm low limit, range: 0~255bpm , adjust continuously, equal or below the upper limit.
Response mode	Select how fast of SpO ₂ value calculation, the selections: <FAST>, <NORMAL> and <SLOW> are optional.

5.3.4 Display of SpO₂ parameter

☰ Waveform display

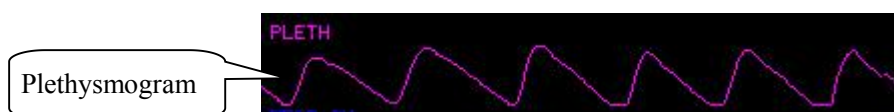

☰ Data display

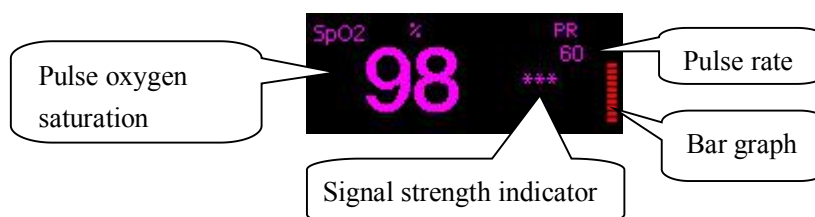

Signal strength indicator: Uses to indicate if the SpO₂ signal strength measured is adequacy.

Indicator	Description
“Weak Signal”	The signal strength is too weak to measuring.
“*”	The signal strength is low.
“**”	The signal strength is good.
“***”	The signal strength is best.

 **Warning:** When the “Weak Signal” is indicated, it means the quality of the signal obtained by the SpO₂ probe is too bad. User should check the patient's condition and move the probe to other appropriate position.

 **Note:** When ECG leads are not connected, while SpO₂ sensor is connected, pulse rate will display on the position of heart rate parameter automatically.

5.3.5 Maintenance and Cleaning

-  **Warning:**
- Do not subject the sensor to autoclaving.
 - Do not immerse the sensor into any liquid.
 - Do not use any sensor or cable that may be damaged or deteriorated.
-

 **Note:** When disposing the disposable SpO₂ probe or useless SpO₂ probe, please observe all local, state, and federal regulations that relate to the disposal of this products or similar products.

For reusable SpO₂ sensor

Please unplug the sensor from the monitor before cleaning or disinfection.

Clean or disinfect the sensor before attaching to a new patient.

■ **Cleaning:**

Use a piece of clean cloth moistened in water or mild soap solution to clean the sensor and patient contact surfaces.

■ **Disinfection:**

Use a piece of clean cloth to wipe the sensor and patient contact surfaces with a 10% bleach solution or 70% isopropyl alcohol, clean with clear water and wipe it dry.

5.4 Measurement of TEMP

5.4.1 Brief Introduction to Measurement of TEMP

The Monitor measures temperatures with TEMP sensors, and the measurement range is 0.0~50.0°C (32.0~122.0°F).

The TEMP module of the monitor uses TEMP cable compatible with YSI-400. The minimum time to get accurate temperature measuring value is 3 minutes.

The Monitor has two TEMP measurement sockets, and can measure the temperature of two channels at the same time.

5.4.2 Preparing the Measurement of TEMP

- 1) Plug the TEMP cables into the TEMP sockets of the monitor.
- 2) Place the TEMP sensors on body of patient and the screen will show the value of TEMP measurement.
- 3) Set the parameters relevant to TEMP.

5.4.3 Connecting Patient and Monitor

Plug the TEMP cable into the sockets marked with TEMP (either of TEMP1 and TEMP2), and then stick the TEMP sensor securely onto the body of patient.

 **Caution: The TEMP sensor and cables should be handled with care. When not in use, the sensor and the cable should be rounded into loose ring shape.**

 **Warning: The calibration of temperature measurement is necessary for every two years (or as frequently as dictated by your Hospital Procedures Policy). When you need calibrate the temperature, contact the manufacture please.**

 **Note: The self-test of the temperature measurement is performed automatically once every 10 minutes during the monitoring. The test procedure lasts about one second and does not affect the normal measurement of the temperature monitoring.**

 **Note: If Temperature to be measured beyond probe's measuring range, over measuring range alarm will display on the screen. Check out if probe is on the corresponding patient body site, or change it to other site on the patient.**

 **Note: if "TEMP self-check error" displays on the screen, it is possibly that something is wrong with the temperature capture circuit, the operator should stop using the monitor and contact with the company.**

5.4.4 TEMP Setup menu

Select the <TEMP> button on the screen, and a following TEMP setup window will be displayed.

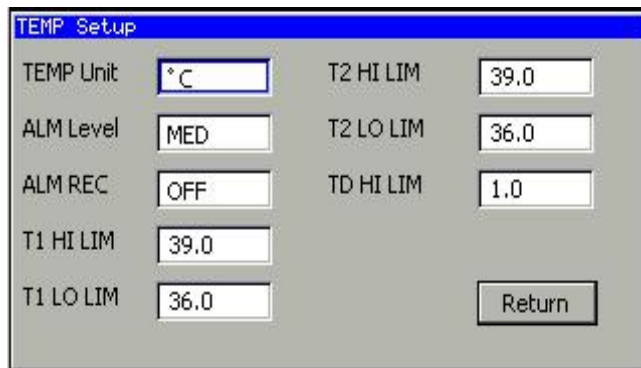

TEMP Unit	Select the unit of the TEMP value displayed, the selections: <°C>, <°F>.
ALM Level	Set TEMP parameters' alarm level, the selections: <OFF>, <LOW>, <MED> and <HIGH>.
ALM REC	Select <ON>, the alarm of TEMP parameter will trigger alarm recording. Select <OFF>, the alarm of TEMP parameter will not trigger alarm recording.
T1 HI LIM	Select the channel 1 TEMP alarm high limit, set range: 0~50 °C , adjust continuously, equal or above the lower limit.
T1 LO LIM	Select the channel 1 TEMP alarm low limit, set range: 0~50 °C , adjust continuously, equal or below the upper limit.
T2 HI LIM	Select the channel 2 TEMP alarm high limit, set range: 0~50 °C , adjust continuously, equal or above the lower limit.
T2 LO LIM	Select the channel 2 TEMP alarm low limit, set range: 0~50 °C , adjust continuously, equal or below the upper limit.
TD HI LIM	Select the difference alarm high limit between channel 1 and channel 2 TEMP, set range: 0~5 °C.

5.4.5 Display of TEMP parameter

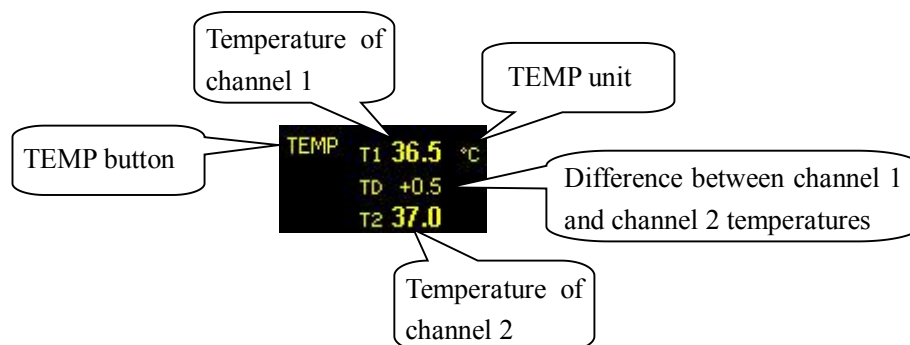

5.4.6 Maintenance and Cleaning

Reusable temp probes

1. The temp probe should not be heated above 100 °C . It should only be subjected briefly to temperatures between 80°C and 100°C .
2. Only detergents containing no alcohol can be used for disaffection.
3. The rectal probes should be used, if possible, in conjunction with a protective rubber cover.

■ **Cleaning:**

Use a piece of clean cloth moistened in water or mild soap solution to clean the probe.

■ **Disinfection:**

Use a piece of clean cloth to wipe the surface of the cable with 70% isopropyl alcohol, a 10% bleach solution or 2% Cidex®, clean with clear water and wipe it dry.

 **Warning: Disposable TEMP probes must not be re-sterilized or reused.**

 **Note: For protecting environment, the disposable TEMP probe must be recycled or disposed of properly.**

 **Disposal Notice: Should the TEMP probe become damaged beyond repair, or for some reason its useful life is considered to be at an end, please observe all local, state, and federal regulations that relate to the disposal of this products or similar products.**

5.5 Measurement of NIBP

5.5.1 Brief Introduction to Measurement of NIBP

The Monitor automatically conducts measurement of NIBP with the method of shockwave. The method of shockwave indirectly estimates the systolic and diastolic pressures within the blood vessels by measuring the change of the pressure within blood pressure cuff along with the volume of the arteries and calculates the average pressure.

The measurement time of BP on a calm patient is less than 40 seconds, and when each measurement ends, the cuff automatically deflates to zero.

The monitor applies to large animals, medium-size animals and small animals.

The monitor measures the blood pressure during the time of deflation. The monitor automatically conducts the second and third inflation measurements in case during the first inflation it is unable to measure the value of BP, and gives out the information for measurement failures.

The longest cuff pressure maintaining duration is 120 seconds, and when the time is exceeded, the air will be deflated automatically. The monitor has been designed with hardware protection circuit regarding overpressure, errors of microprocessors, and the occurrence of power failure.

5.5.2 Preparing Measurement of NIBP

1) Plug the air hose of cuff into the NIBP socket of the monitor and tighten it clockwise to ensure secure contact of the plug and the socket (Please note that the plug should be loosened by turning counterclockwise first before unplugging).

2) Place the cuff on the veterinary patient.

Place the patient on a padded surface or chair to provide comfort. Shivering will inhibit the monitor from making a determination.

■ Cuff placement for a cat

A cat may be left in its owner's lap to keep it calm. Measurements are best done in an area of the hospital away from noise and bright lights. The animal may be held so that the front limbs are free for cuff placement. In conscious patients, the tail may be the most appropriate location for placement of the cuff. Cats may be most comfortable in sternal recumbency making the tail a more preferable site.

For the median artery on the foreleg, place the cuff around the forelimb, between the elbow and carpus. It is not necessary to center the cuff over the artery which is on the medial side of the leg because of the fully encircling bladder design. Hair need not be clipped except when heavily matted. In cats less than five pounds when measurements are difficult to obtain, place the cuff around the leg above the elbow to obtain measurements from the brachial artery. Measurements from the coccygeal artery may be used by placing the cuff around the base of the tail but not in anesthetized patients.

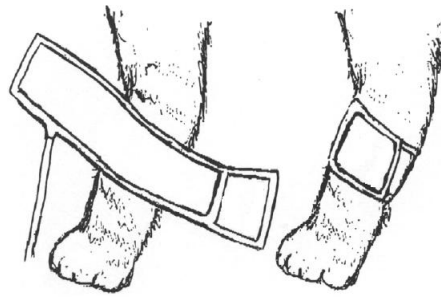

Fig. Cat cuff placement

■ Cuff placement for a dog

For measurements in dogs, it is preferable to use the right lateral, sternal or dorsal recumbent positions. That is not a problem in anesthetized patients, but it may be difficult to get large dogs to cooperate for proper positioning. If the dog is in a sitting position, place the front paw on the operator's knee and take measurements from the metacarpus.

Sites for cuff placement are the metacarpus, metatarsus and anterior tibial. In anesthetized patients, most surgeries are done on the posterior part of the body so the metacarpal area of the forelimb is most convenient. In situations where this is not possible, the cuff should be wrapped around the metatarsus just proximal to the tarsal pad or around the hind leg just distal to the hock. The tail site should not be used for cuff placement during anesthesia.

It is not necessary to center the cuff over the artery because of the fully encircling bladder design. If the hair over the artery site is too thick or matted for good contact, it should be clipped.

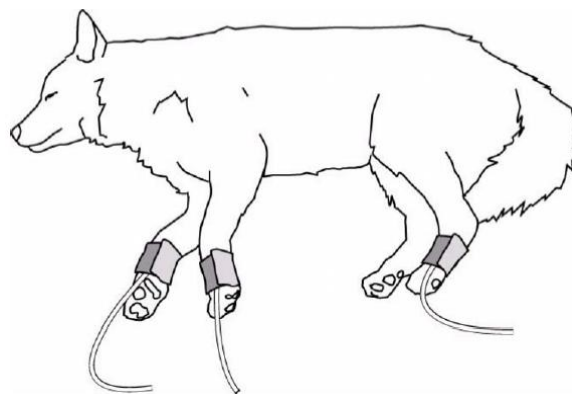



Fig. Dog cuff placement

■ Large animals

A large animal such as a horse should be in a stock, standing still, or lying down.

For horses and cows, the cuff can be wrapped around the base of the tail using the coccygeal artery on the ventral surface.

3) Set the parameters and modes relevant to NIBP.

 **Note: Make sure that the air conduit connecting the blood pressure cuff and the monitor is neither blocked nor tangled, and avoid compression or restriction of air conduit.**

5.5.3 Connecting to Patient and the Monitor

Plug the connector of air hose on cuff into the socket marked with NIBP and install the cuff onto the arm of patient. Make sure the mark of Φ on the cuff is placed on the femoral artery of the arm and the air hose should be below the cuff so as to ensure the air hose is not snarled after coming out of the cuff. The white line on the cuff should be within the range of “ \longleftrightarrow ”, otherwise it will be necessary to replace it with a more suitable cuff (smaller or bigger one). The cuff should be placed on the same plane with the heart so as to prevent the errors in readings caused by the effects of hydrostatics of the blood column between the heart and the cuff. If the position of the cuff is higher than the plane of heart, the measured BP readings tend to be smaller; in case the position of the cuff is lower than the plane of the heart, the measured BP readings tend to be higher.

 **Note: The accuracy of measurement of BP depends on the suitability of the cuff. Select the size of the cuff according to the size of the arm of patient. The width of the cuff should be 40% of the circumference of the upper arm or 2/3 of the length of the upper arm.**

Warning:

- **You must not perform NIBP measurements on patients with sickle-cell disease or under any condition that the skin is damaged or expecting to be damaged.**
 - **For a thrombasthenia patient, it is important to determine whether measurement of the blood pressure shall be done automatically. The determination should be based on the clinical evaluation.**
 - **Prolonged non-invasive blood pressure measurements in Auto mode may be associated with purport, ischemia and neuropathy in the limb wearing the cuff. When monitoring a patient, examine the extremities of the limb frequently for normal color, warmth and sensitivity. If any abnormality is observed, stop the blood pressure measurements.**
-

5.5.4 NIBP Setup menu

Select the <NIBP> button on the screen, and a following NIBP setup window will be displayed.

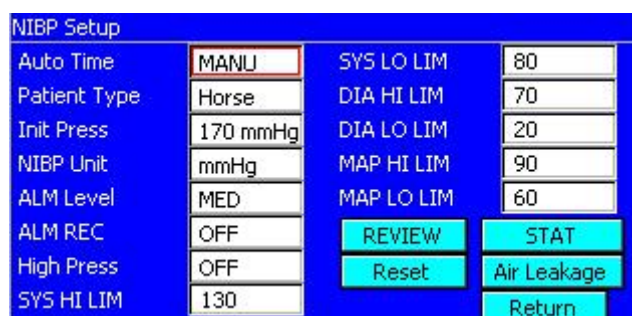

Auto Time	Interval time for automatic measuring, the selections: MANU, 1, 2, 3, 4, 5, 10, 15, 20, 30, 45, 60, 90 minutes, 2, 4, 8, 12 hours. Pick MANU selection to set up the measuring mode to manual.
Patient Type	Select the patient type of measurement, the selections: <Horse>, <Dog>, <Cat>. When monitoring a cat or small animal, set the object to cat , when monitoring dogs or medium-size animals, set to dog , when monitoring horses or large animals, set to horse .
Init Press	Select the inflation pressure. You can change the cuff inflation pressure before any measurement. If you change the pressure, the monitor will use the new value for the next NIBP measurement.
NIBP Unit	Selects the unit of NIBP measurement, option: <kPa>, <mmHg>.
ALM Level	Set NIBP parameters' alarm level, the selections: <OFF>, <LOW>, <MED> and <HIGH>.
ALM REC	Select <ON>, the alarm of NIBP parameters will trigger alarm recording. Select <OFF>, the alarm of NIBP parameters will not trigger alarm recording.
High Press	This item is optional when the <Patient type> is Horse. It is usually used when the systolic blood pressure of patient is over 180 mmHg. The selections: <OFF>, <ON>.
SYS HI LIM	Selects the warning upper limit of systolic blood pressure, the range is 0~300 mmHg continuously, and can not lower than the lower limit.
SYS LO LIM	Selects the warning lower limit of systolic blood pressure, the range is 0~300 mmHg continuously, and can not higher than the upper limit.
MAP HI LIM	Selects the warning upper limit of mean blood pressure, the range is 0~300 mmHg continuously, and can not lower than the lower limit.
MAP LO LIM	Selects the warning lower limit of mean blood pressure, the range is 0~300 mmHg continuously, and can not higher than the upper limit.
DIA HI LIM	Selects the warning upper limit of diastolic blood pressure, the range is 0~300 mmHg continuously, and can not lower than the lower limit.

DIALO LIM	Selects the warning lower limit of diastolic blood pressure, the range is 0~300 mmHg continuously, and can not higher than the upper limit.
Review	Select this button for reviewing NIBP measurement data stored before.
STAT	Select this button will start continuous NIBP measurement within 5 minutes. No STAT measurement for cat.
RESET	Select this button will reset NIBP module. This option is only used at periodic check or maintenance.
Air Leakage	Select this option will configure NIBP module work at air leakage check mode. This option is only used at periodic check or maintenance.

 **Note:**

- **AUTO measurement mode means the system automatically activates the air pump to conduct measurement according to the set intervals of cycles, MANU measurement mode means the user starts the air pump manually to conduct measurement, and STAT measurement mode means the system will swiftly and continuously measure BP within 5 minutes. STAT mode is invalid for cat.**
- **While measuring hypertension patient, please set < High Press > on < ON >, so NIBP module can go up automatically to a higher pressure to start measuring, reduce the times of inflation, make the blood pressure measurement of hypertensive more quickly and accurately.**

5.5.5 Review NIBP measurement

Select the **【NIBP】** --> **【Review】** , and a following NIBP review window will be displayed.

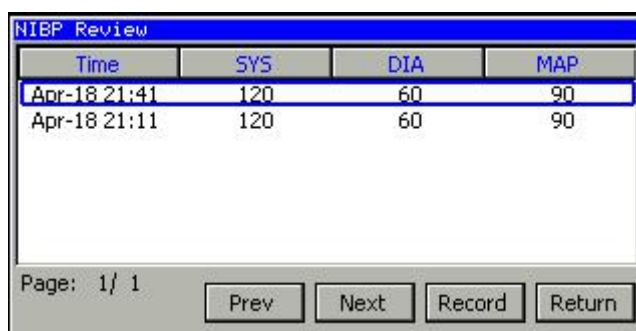

Prev	Turn to previous page.
Next	Turn to next page.
Record	Print the NIBP measurement results in current screen through recorder.
Return	Exit NIBP review window.

Note: The monitor can store maximum 600 items of NIBP measurement result. When the maximum storage capability is achieved, the monitor would not save new NIBP measurement data unless the old NIBP measurement cleared.

5.5.6 Display of NIBP parameter

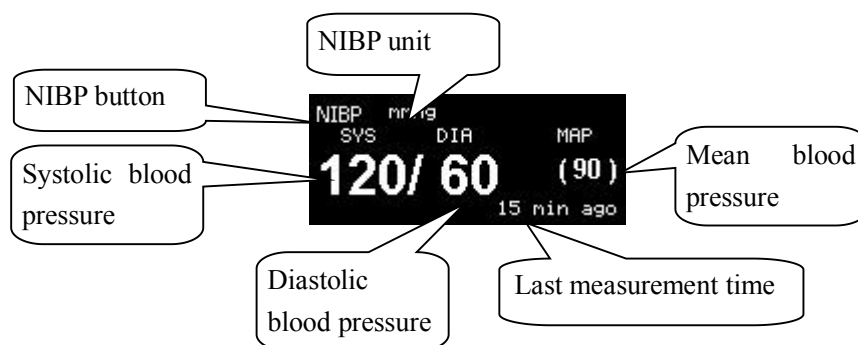

Fig. NIBP parameter area

5.5.7 Precautions during Measurement

⇒ If the BP of the patient is above 180mmHg, set **【 High Press 】** to <ON> is recommended.

⇒ When using the STAT measurement or AUTO measurement, if the time duration is relatively long, care must be taken to check such abnormalities as purple spots, coldness and numbness at the limb end. If there are such phenomena, the cuff should be relocated or the measurement of NIBP should be halted.

⇒ The presence of factors that change the properties of the cardiovascular dynamics of patient will adversely affect the measurement value of the monitor, and shock and hypothermia will also affect the accuracy of the measurement.

⇒ When the built-in main artery balloon pump is applied on the patient, the measurement value of NIBP will be affected.

⇒ For the limb that is on an intravenous drip or in a catheter insertion, or if the patient is connected to the heart-lung machine, or the patient is experiencing shiver or convulsions, the measurement of NIBP cannot be conducted.

⇒ When errors occur in the measurement of NIBP, the error codes will appear in the parameter display area of the NIBP, and for the cause of the errors, please refer to **The NIBP Technical Alarm Information**.

5.5.8 Blood pressure reference values

The blood pressure values for cats are not breed-specific. However, the most sensitive way to detect changes in feline blood pressure is also by comparing individual blood pressure readings taken over time.

Normal feline blood pressure: 124/84.

The normal values for dogs are breed-specific. Those for Golden Retrievers, Labradors and giant breeds tend to be lower than the overall average, and those for greyhounds and in general racing hounds tend to be higher. The table that follows lists the normal values for common dog breeds using oscillometric blood pressure monitors.

Average canine blood pressure: 133/75.

Breed	Systolic(mmHg)	Diastolic(mmHg)	Pulse Rate(bpm)
Labrador Retriever	118 ± 17	66 ± 13	99 ± 19
Golden Retriever	122 ± 14	70 ± 11	95 ± 15
Great Pyrenees	120 ± 16	66 ± 6	95 ± 15
Yorkshire Terrier	121 ± 12	69 ± 13	120 ± 14
West Highland	126 ± 6	83 ± 7	112 ± 13
Border Collie	131 ± 14	75 ± 12	101 ± 21
King Charles Spaniel	131 ± 16	72 ± 14	124 ± 24
German Shepherd	132 ± 13	75 ± 10	108 ± 23
Terrier	136 ± 16	76 ± 12	104 ± 16
Bullterrier	134 ± 12	77 ± 17	122 ± 6
Chihuahua	134 ± 9	84 ± 12	109 ± 12
Miniature Breeds	136 ± 13	74 ± 17	117 ± 13
Pomeranian	136 ± 12	76 ± 13	131 ± 14
Beagle	140 ± 15	79 ± 13	104 ± 16
Dachshound	142 ± 10	85 ± 15	98 ± 17
Saluki	143 ± 16	88 ± 10	98 ± 22
Greyhound	149 ± 20	87 ± 16	114 ± 28
Pointer	145 ± 17	83 ± 15	102 ± 14

5.5.9 Periodic Check

☰ Calibration

 **Warning:** The calibration of the NIBP measurement is necessary for every two years (of as frequently as dictated by your Hospital Procedures Policy). The performance should be checked according to the following details.

Procedure of the Pressure Transducer Calibration:

- 1) Replace the cuff of the device with a rigid metal vessel with a capacity of 500 ml $\pm 5\%$.
- 2) Connect a calibrated reference manometer with an error less than 0.8mmHg and a ball pump by means of a T-piece connector and hoses to the pneumatic system.
- 3) Access the <Maintenance> window.
- 4) Select the **【Manometer】** button and press. Then the prompt “Manometer test” will appear on the NIBP parameter area indicating that the system has started performing calibration.
- 5) Inflate the pneumatic system to 0, 50 and 200 mmHg by ball pump separately. The difference between the indicated pressure of the reference manometer and the indicated pressure of the monitor will not exceed $\pm 3\text{mmHg}$. Otherwise, please contact our customer service.
- 6) Press the  key on front panel can stop the calibration.

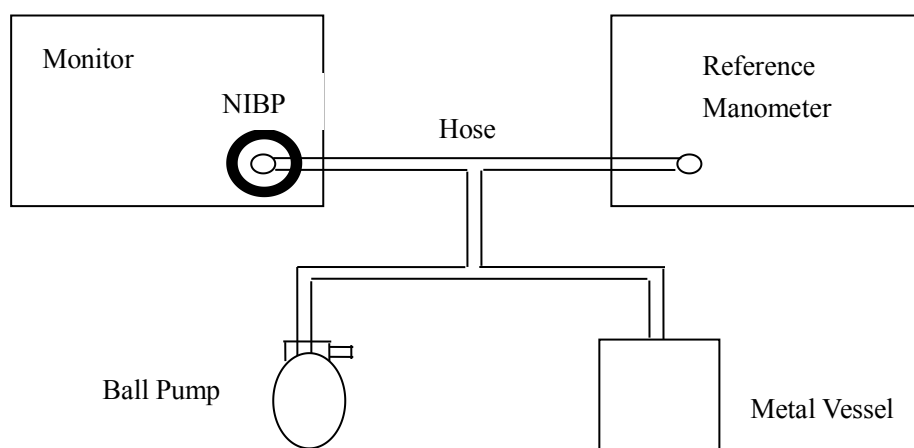



Fig. Diagram of NIBP calibration

Procedure of Safety Pressure Limits check:

- 1) Replace the cuff of the device with a rigid metal vessel with a capacity of 500 ml $\pm 5\%$.
- 2) Connect a calibrated reference manometer and a ball pump by means of a T-piece connector and hoses to the pneumatic system.
- 3) Access the <Maintenance> window.
- 4) Select the **【Over Press】** button and press. Then the prompt “Over Pressure test” will appear on the NIBP parameter area indicating that the system has started performing Safety Pressure Limit test.
- 5) The Safety Pressure Limit in Horse mode is 315 ± 10 mmHg. Inflate the pneumatic system upper to this limits, the system will automatically open the deflating valve and the prompt “OVERPRESSURE SENSED” will appear on the NIBP parameter

area indicating that the system has completed a Safety Pressure Limit test.

- 6) Press the  key on front panel can also stop the test.
- 7) According to steps 1) - 7) for Safety Pressure Limit test of Dog and Cat modes. The Safety Pressure Limit in Dog mode is 265 ± 10 mmHg and the Safety Pressure Limit in Cat mode is 255 ± 10 mmHg.

Air Leakage check

Procedure of the air leakage test:

- 1) Connect the cuff securely with the socket for NIBP air hole.
- 2) Wrap the cuff around the cylinder of an appropriate size.
- 3) Access the NIBP setup window.
- 4) Select the **【Air Leakage】** button and press. Then the prompt “Air Leakage test” will appear on the NIBP parameter area indicating that the system has started performing Air Leakage test.
- 5) The system will automatically inflate the pneumatic system to about 180mmHg.
- 6) After 20 seconds or so, the system will automatically open the deflating valve, which marks the completion of an air leakage test.
- 7) If no error information displays on NIBP parameter area, it indicates that the airway is in good situation and no air leaks exist. However if the prompt “AIR SYSTEM LEAK” appears in the place, it indicates that the airway may have air leaks. In this case, the user should check for loose connection. After confirming secure connections, the user should re-perform the air leakage test. If the failure prompt still appears, please contact the manufacturer for repair.
- 8) Press the  key on front panel can also stop the test.

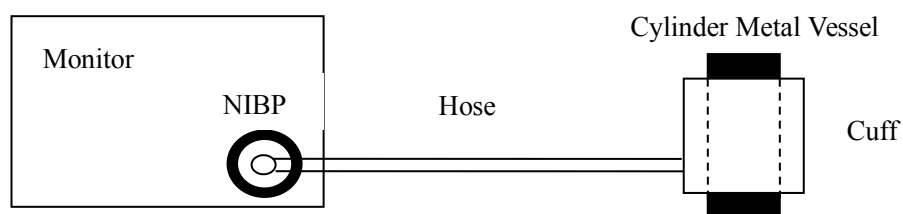

5.5.10 Maintenance and Cleaning

 **Warning: Do not squeeze the rubber hose on the cuff. Do not allow liquid to enter the connector socked at the front of the monitor. Do not wipe the inner part of connector socked when cleaning the monitor.**



Warning: if liquid is inadvertently splashed on the equipment or its accessories, or may enter the conduit or inside the monitor, contact local customer service center.



Warning: Disposable blood pressure cuff must not be re-sterilized or reused.



Disposal Notice: Should the blood pressure cuff become damaged beyond repair, or for some reason its useful life is considered to be at an end, please observe all local, state, and federal regulations that relate to the disposal of this products or similar products.

For Reusable Blood Pressure Cuff:

■ **Cleaning:**

1. Please clean the cuff termly.
 2. Take down the cuff from the connector, take out the bladder from the cover of the cuff.
 3. Use a piece of clean cloth moistened in water or mild soap solution to clean the bladder and the tube.
 4. Clean the cover of the cuff with the mild soap solution.
 5. Dry the cover and the bladder, then take the bladder into the cover to use again.
-



Warning:

- **Clean the bladder frequently will cause the bladder scathed, except the necessary, do not clean the bladder.**
 - **Do not dry the bladder and cover with high temperature.**
 - **If need the high level disinfecting, please selecting the disposable cuff.**
-

Chapter 6 Alarm

This chapter gives general information about the alarm and corresponding remedies.



Note: The equipment generates all the auditory and visual alarms through speaker, LED and screen.

6.1 Alarm Priority

There are two kinds of alarms, defined as physiological alarm and technical alarm. Physiological alarms refer to those alarms triggered by patient's physiological situation that could be considered dangerous to his or her life, such as SpO₂ exceeding alarm limit (parameter alarms). Technical alarms refer to system failure, which can make certain monitoring process technically impossible or make monitoring result unbelievable. Each alarm, either technical or physiological, has its own priority.

Alarms in the monitor are divided into three priorities, that is: high priority, medium priority and low priority.

- High priority alarm indicates the patient's life is in danger. It is the most serious alarm.
- Medium priority alarm means serious warning.
- Low priority alarm is a general warning.

Only alarm priority of parameters exceeding limits alarm can be modified by the user, the other alarm priorities of physiological and technical alarms are preset by the system and they can not be changed by the user.

6.2 Alarm Modes

When alarm occurs, the monitor may raise the user's attention in two ways, which are auditory prompt, visual prompt and description. Visual prompt is given by alarm indicator lamp of the monitor, auditory prompt is given by speaker in the device. Physiological alarm information is displayed in the Physiological Alarm area. Most of technical alarm information is displayed in the Technical Alarm area. Technical alarms related to NIBP measurement are displayed in the NIBP parameter area.

The alarm sound and visual display comply with clause 201.3.2 of the standard IEC 601-1-8.

 **Note: The concrete presentation of each alarm prompt is related to the alarm priority.**

☰ Alarm sound

The high/medium/low-level alarms are indicated by the system in following different audio ways:

Alarm level	Audio prompt
High	Mode is “DO-DO-DO-----DO-DO, DO-DO-DO-----DO-DO”, which is triggered once every 10 seconds.
Medium	Mode is “DO-DO-DO”, which is triggered once every 25 seconds.
Low	Mode is “DO-”, which is triggered once every 25 seconds.

☰ Lamp light

Alarm level	Visual prompt
High	Alarm indicator flashes in red with 2 Hz.
Medium	Alarm indicator flashes in yellow with 0.5 Hz.
Low	Alarm indicator lights on in yellow.

☰ Screen Display

Physiological alarm: The parameter, which triggers the alarm, splashes in the frequency of 2Hz on the screen. The physiological alarm area displays alarm message, and red “****” indicates high priority alarm, yellow “***” indicates medium priority alarm, yellow “**” indicates low priority alarm.

Technical alarm or General message: The technical alarm area provides text prompt, red “****” indicates high priority alarm, yellow “***” indicates medium priority alarm, yellow “**” indicates low priority alarm, cyan indicates general message.

 **Note: When alarms of different priorities occur at the same time, the monitor prompts the one of the highest priority.**

6.3 Alarm Setup

☰ Set Alarm volume

Select **【MENU】** --> **【ALM volume】** , options are 0~3. Select 0 to close the alarm sound, Select 3 to setup maximal alarm volume.

The alarm sound is closed, that is to say, when an alarm takes place, the monitor will not make any sound.

☰ **Set alarm limits of physiological parameters**

The alarm limit of each physiological parameter can be set in its menu, and they are continuous in alarm range. For example:

ECG alarm setup:

1. Select <ECG> button
2. Configure the following parameters related to ECG alarm, <ALM Level>, <ALM REC>, <HR LO LIM> and <HR HI LIM>.

Please refer to above operation for Methods of Alarm setup of the other parameters

It is important to set physiological alarm limits properly. The monitor can't give medicinal alarm prompt in clinical application with improper setting of physiological alarm limit.

The physiological alarm occurs when the measurement exceeds the set parameter limits.

Please refer to above operation for Methods of alarm setup of the other parameters.

☰ **Alarm indication of physiological parameters**

Auditory: when alarm occurs, the system generates alarm sound to raise the user's attention (auditory alarm can be disabled).





Visual: The parameter flashes on the display area of the screen and alarm indicator lights.

 **Warning:** The lower limit and the upper limit of parameter must be set based on clinical practices and general clinical experiences.

 **Note:** When parameter alarm level is off, alarm will be disabled, even if the measurement results exceed the limits.

6.4 Alarm state icon



According to alarm setup of the monitor, the following icons would be displayed on screen.

-  The alarm is suspended.
-  The system sound is silenced.
-  The alarm sound is off.
-  The parameter alarm is off.

The system sound includes alarm sound and QRS sound.



6.5 SILENCE/ALARM PAUSED

☰ SILENCE

Press the  key on the front panel for more than 2 seconds can shut off all sounds until the  key is pressed again. When the system is in SILENCE status, any newly generated alarm will cancel the SILENCE status and make the system back to normal status giving auditory alarm prompt.



When in the SILENCE status, the icon  will be displayed in the right undersurface of the screen.

☰ ALARM PAUSED

Press the  key on the front panel for less than 2 seconds can close all auditory and visual prompt and description about all the physiological alarms and to make the system enter ALARM PAUSED status. The rest seconds for ALARM PAUSED is displayed in the Physiological Alarm area. And the icon  will be displayed in the physiological alarm area.

The user may set up the time for ALARM PAUSED. Select **【MENU】** --> **【ALM Paused】**, two selections are available: 1, 2 minutes.

When in the ALARM PAUSED status, press the  key again to restore the normal alarm status. Besides, during ALARM PAUSED status, newly occurring technical alarm will cancel the ALARM PAUSED status and the system will come back to the normal alarm status.

 **Note: Whether an alarm will be reset depends on the status of the alarm cause. But by pressing  key can permanently shut off audio sound of Lead Off/Sensor Off alarms.**

6.6 Parameter Alarm

The setup for parameter alarm is in their menus. In the menu for a specific parameter, you can check and set the alarm limit, alarm status. The setup is isolated from each other.

When a parameter alarm level is off, the icon  displays near the parameter.

For the parameters whose alarm level is not off, the alarm will be triggered when at least one of them exceeds alarm limit. The following actions take place:

1. Alarm message displays on the screen as described in alarm mode;
2. The monitor beeps in its corresponding alarm level and volume;
3. If alarm recording is on, the recorder starts alarm recording at set interval.

6.7 When an Alarm Occurs

 **Note: When an alarm occurs, you should always check the patient's condition first.**

Check the alarm message appeared on the screen. It is needed to identify the alarm and act appropriately, according to the cause of the alarm.

1. Check the patient's condition.
2. Identify which parameter is alarming or which kind of alarm it is.
3. Identify the cause of the alarm.
4. Silence the alarm, if necessary.
5. When cause of alarm has been over, check that the alarm is working properly.

You will find the alarm messages for the individual parameter in their appropriate parameter chapters of this manual.

6.8 Alarm Description and Prompt

6.8.1 ECG alarm information

Physiological Alarm Information:

Message	Cause	Alarm Level
HR too high	HR measuring value is above the upper alarm limit	User-Selectable
HR too low	HR measuring value is below the lower alarm limit	

Technical Alarm Information:

Message	Cause	Alarm Level
RA/LA/LL/V- OFF LEADS OFF	ECG electrode fall off the patient's skin or ECG cables fall off the monitor	Low
ECG Signal Saturated	ECG electrode polarized	Low

6.8.2 RESP alarm information

Physiological Alarm Information:

Message	Cause	Alarm Level
RR too high	RR measuring value is above the upper alarm limit	User-Selectable
RR too low	RR measuring value is below the lower alarm limit	
RESP Apnea	No signal for breath in specific interval	

6.8.3 SpO₂ alarm information

Physiological Alarm Information:

Message	Cause	Alarm Level
SpO ₂ too high	SpO ₂ measuring value is above the upper alarm limit	User-Selectable
SpO ₂ too low	SpO ₂ measuring value is below the lower alarm limit	
PR too high	PR measuring value is above the upper alarm limit	
PR too low	PR measuring value is below the lower alarm limit	
SpO ₂ Pulse timeout	Search pulse too long, weak signal	High

Technical Alarm Information:

Message	Cause	Alarm Level
SpO ₂ OFF	SpO ₂ sensor may be disconnected from the patient or the monitor	Low
SpO ₂ Motion	There us some interference signal or great patient motion	Defined by the degree of motion
SpO ₂ sensor failure	SpO ₂ sensor failure	Low

Prompt:

Message	Cause	Alarm Level
SpO ₂ pulse search	SpO ₂ module is searching for pulse	No alarm

6.8.4 TEMP Alarm information

Physiological Alarm Information:

Message	Cause	Alarm Level
T1 too high	TEMP1 measuring value is above upper alarm limit	User-Selectable
T1 too low	TEMP1 measuring value is below lower alarm limit	User-Selectable
T2 too high	TEMP2 measuring value is above upper alarm limit	User-Selectable
T2 too low	TEMP2 measuring value is below lower alarm limit	User-Selectable
TD too high	The difference between channel 1 and channel 2 TEMP is above upper alarm limit	User-Selectable

Technical Alarm Information:

Message	Cause	Alarm Level
T1 OFF	TEMP1 sensor may be disconnected from monitor	Low
T2 OFF	TEMP2 sensor may be disconnected from monitor	Low
T1 OH	TEMP1 over upper measuring range	Low
T1 OL	TEMP1 below lower measuring range	Low
T2 OH	TEMP2 over upper measuring range	Low
T2 OL	TEMP2 below lower measuring range	Low
TEMP Self checking error	TEMP module self check failure	Low

6.8.5 NIBP Alarm

Physiological Alarm Information:

Message	Cause	Alarm Level
SYS too high	NIBP SYS measuring value is above upper alarm limit	User-Selectable
SYS too low	NIBP SYS measuring value is below lower alarm limit	
DIA too high	NIBP DIA measuring value is above upper alarm limit	
DIA too low	NIBP DIA measuring value is below lower alarm limit	
MAP too high	NIBP MAP measuring value is above upper alarm limit	
MAP too low	NIBP MAP measuring value is below lower alarm limit	

Technical Alarm Information (Displayed in NIBP parameters display area):

Message	Cause	Alarm Level
SELF-TEST FAILED	Transducer or other hardware failure.	Low
LOOSE CUFF	a. Cuff is completely unwrapped. b. The cuff is not connected. c. Horse cuff used in cat mode.	Low
AIR LEAK	Air leak in pneumatics, hose, or cuff.	Low
AIR PRESSURE ERROR	Unable to maintain stable cuff pressure, e.g. kinked hose	Low

WEAK SIGNAL	a. Very weak patient signal due to a loosely wrapped cuff. b. The pulse of patient is too weak.	Low
RANGE EXCEEDED	Measurement range exceeds module specification.	Low
EXCESSIVE MOTION	a. Too many retries due to interference of motion artifact. b. Signal is too noisy during measurement, e.g. patient has severe tremor. c. Irregular pulse rate, e.g. arrhythmia.	Low
OVERPRESSURE SENSED	Cuff pressure exceeds the specified upper safety limit. Could be due to rapid squeezing or bumping of cuff.	Low
SGNAL SATURATED	Large motion artifact that saturates the BP amplifier's amplitude handing capability.	Low
AIR SYSTEM LEAK	Module reports Air Leakage failure while in the Pneumatic Test mode.	Low
SYSTEM FAILURE	Module occurs abnormal processor event.	Low
TIME OUT	Measurement took more than 120 seconds in horse, 105 seconds in cat mode.	Low
CUFF TYPE ERR	Cat cuff used in Horse mode.	Low

Prompt (Displayed in NIBP parameters display area):

Message	Cause	Alarm Level
Resetting...	Module is reset.	No alarm
Over Pressure test	Module is in the Over Pressure Test mode.	
Manometer Testing	Module is in the Manometer Test mode.	No alarm
Air Leakage Test	Module is in the Pneumatic Test mode.	

6.8.6 System Alarm and Prompt

Technical Alarm Information:

Message	Cause	Alarm Level
Battery failure	Battery failure	Low
BATTERY LOW	Energy of battery is exhausted.	Medium

KB ERR		Keyboard error	Low
REC ERR		No paper in the recorder or the recorder door is open.	Low
RTC RESET		System time error, user should reset the system time.	Low
RTC USELESS		System time failure.	Low
ECG error	communication	ECG module failure or communication failure	Low
SpO ₂ error	communication	SpO ₂ module failure or communication error	Low
TMEMP error	communication	TEMP module error or communication error	Low
NIBP error	communication	NIBP module failure or communication failure	Low

Prompt Information

Message	Cause	Alarm Level
Wave Frozen	The waveform display on the screen is frozen.	No alarm

Chapter 7 Recording

☰ The monitor carries out the recording function by a built-in recorder optional.



This icon will be displayed in the system information area of the screen when the monitor has been equipped with a recorder.



This icon will be displayed in the system information area of the screen when the recorder is lack of paper, the door is not closed or other faults.

☰ Alarm recording

The monitor has the function of alarm trigger recording.

- Select **【MENU】** --> **【Recorder...】** --> **【ALM REC Interval】**, setup the alarm recording interval when alarm is occurring continuous. Alarm recording function will be disabled when <OFF> is selected.
- Access the parameter setup windows and set the **【ALM REC】** to <ON>, and setup the parameter alarm level and alarm limit correctly.
- When the parameter alarm occurs and the **【ALM REC】** is <ON>, all the parameter values during the alarm will be printed out. And the parameter value which trigger the alarm recording will be marked with “*”.
- If duration of the parameter alarm is over alarm recording interval, the monitor will print out all the parameter values again.



Note: The <ALM REC> is included in any parameter setup menu. If the option is at <OFF>, the parameter alarm cannot trigger the alarm recording.

☰ Auto recording

The monitor has the function of auto recording.

- Select **【MENU】** --> **【Recorder...】** --> **【Auto REC】**, setup interval time of auto recording.
- Select **【MENU】** --> **【Recorder...】** --> **【REC Length】**, setup the recording length of waveform in auto recording.
- The monitor prints out waveforms and parameter values according to interval time set in **【Auto REC】**.

☰ Real-Time Recording

The monitor has the function of real time recording. Press the  key on front panel to start the real-time recording of waveforms and parameter values, press the key again to end the real-time recording. The waveform recorded is selected by **【REC wave】** in Recorder setup window.

Chapter 8 The Maintenance and Cleaning

8.1 System Check

An effective maintenance schedule should be established for your monitoring equipment and reusable supplies. This should include inspection as well as general clearing on a regular basis. The maintenance schedule must comply with the policies of your institution's infection control unit and/or biomedical department.

Check with your biomedical department to be sure preventive maintenance and calibration has been done. The User Maintenance Instruction contains detailed information.

Before using the monitor, check the equipment following these guidelines:

- ⇒ Check the equipment for obvious mechanical damage.
- ⇒ Check all the outer cables, inserted modules and accessories for fraying or other damage. Qualified service personnel should repair or replace damaged or deteriorated cables.
- ⇒ Check all the functions relevant to patient monitoring, make sure that the monitor is in good condition.

If you find any damage on the monitor, stop using the monitor on patient, and contact the biomedical engineer of the hospital or Manufacturer's Customer Service immediately.



Note: Refer to the User Maintenance Instruction for more comprehensive checkout procedures.

The overall check of the monitor, including the safety check, should be performed only by qualified personnel once every 6 to 12 month, and whenever the monitor is fixed up.

- Inspect the safety relevant labels for legibility.
- Verify that the device functions properly as described in the instructions for use.
- Test the protection earth resistance according IEC 601-1:1988, Limit 0.1ohm.
- Test the earth leakage current according IEC 601-1:1988, Limit: NC 500uA, SFC 1000uA.
- Test the patient leakage current according IEC 601-1:1988, Limit: 100uA(BF), 10uA(CF).
- Test the patient leakage current under single fault condition with mains voltage on the applied part according IEC 601-1:1988, Limit: 5mA(BF), 50uA(CF).

The leakage current should never exceed the limit. The data should be recorded in an equipment log. If the device is not functioning properly or fails any of the above tests, the device has to be repaired.

The synchronism of the defibrillator should be checked by in the frequency described in the hospital regulations. At least every 3 months, it should be checked by the biomedical engineer of the hospital or qualified service technician.

All the checks that need to open the monitor should be performed by qualified service technician. The safety and maintenance check can be conducted by persons from the manufacturer. You can obtain the material about the customer service contract from the local office.

The circuit diagrams, parts lists and calibration instructions of the patient monitor can be provided by the manufacturer.



Warning: If the hospital or agency that is responding to using the monitor does not follow a satisfactory maintenance schedule, the monitor may become invalid, and the human health may be endangered.



Note: To ensure maximum battery life, please ensure that the battery is always fully charged when you are keeping the device in storage for an extended period of time, and check the battery status at least once every month and recharge the battery.



Warning: Refer the battery replacement only to manufacturer's service technician.

8.2 Battery Maintenance

A built-in rechargeable battery is designed for the patient monitor, which enables continuous working when AC power off. Special maintenance is not necessary in the normal situation. Please pay attention to the followings in using for more durable usage and a better capability.

⇒ Operate the patient monitor in the environment according to the specification of this manual.

⇒ Use AC power for the patient monitor when available.

⇒ Recharge the battery sooner when it is off. The volume of battery will not be charged to what it should be, when the battery has not been charged for a long time.

⇒ Recharge the battery for every half a year when the patient monitor is not operated for a long period.

⇒ Avoid exposed and sun shine.

⇒ Avoid infrared and ultraviolet radiation.

⇒ Avoid moist, dust and erosion from acid gas.

For Lithium ion battery:

A lithium ion battery needs at least two conditioning cycles when it is put into use for the first time. A battery conditioning cycle is one complete, uninterrupted charge of the battery, followed by a complete, uninterrupted discharge of the battery. A lithium ion battery should be conditioned regularly to maintain its useful life. Condition a battery once when it is used or stored for two months, or when its run time becomes noticeably shorter.

To condition a lithium ion battery, follow this procedure:

1. Disconnect the monitor from the patient and stop all monitoring and measuring procedures.
2. Place the lithium ion battery in need of conditioning into battery compartment of the monitor.
3. Connect the monitor to the AC mains. Allow the battery to be charged uninterruptedly for above 6 hours.
4. Remove the AC mains and allow the monitor to run from the battery until it shuts off.
5. Reconnect the monitor to the AC mains. Allow the battery to be charged uninterruptedly for above 6 hours.

Now the battery is conditioned and the monitor can be returned to service.

8.3 General Cleaning

 **Warning: Before cleaning the monitor or the sensors, make sure that the equipment is switched off and disconnected from the power line.**

The Patient Monitor must be kept dust-free.

Regular cleaning of the monitor shell and the screen is strongly recommended. Use only non-caustic detergents such as soap and water to clean the monitor shell.

Please pay special attention to the following items:

1. Avoid using ammonia-based or acetone-based cleaners such as acetone.
2. Most cleaning agents must be diluted before use. Follow the manufacturer's directions carefully to avoid damaging the monitor.

3. Don't use the grinding material, such as steel wool etc.
4. Don't let the cleaning agent enter into the chassis of the system.
5. Don't leave the cleaning agents at any part of the equipment.

8.4 Cleaning Agents

Examples of disinfectants that can be used on the instrument casing are listed below:

- Diluted soap solution
- Diluted Ammonia Water
- Diluted Sodium Hypochlorite (Bleaching agent).

 **Note: The diluted sodium hypochlorite from 500ppm (1:100 diluted bleaching agent) to 5000ppm (1:10 bleaching agents) is very effective. The concentration of the diluted sodium hypochlorite depends on how many organisms (blood, mucus) on the surface of the chassis to be cleaned.**

- Hydrogen Peroxide 3%
- Alcohol 70%
- Isopropyl alcohol 70%

The surface of patient monitor can be cleaned with hospital-grade ethanol and dried in air or with crisp and clean cloth.

The manufacturer has no responsibility for the effectiveness of controlling infectious disease using these chemical agents. Please contact infectious disease experts in your hospital for details.

8.5 Disinfection

To avoid extended damage to the equipment, disinfection is only recommended when stipulated as necessary in the Hospital Maintenance Schedule. Disinfection facilities should be cleaned first.

Appropriate disinfection materials for ECG lead, SpO₂ sensor, blood pressure cuff, TEMP probe are introduced in the corresponding chapters respectively.



Warning: Do not use EtO gas or formaldehyde to disinfect the monitor.

Chapter 9 Accessories and Ordering Information

This chapter lists the recommendation accessories used in this device.



Warning: The accessories listed below are specified to be used in this device. The device will be possibly damaged or lead some harm if any other accessories are used.

1. ECG

ECG Electrode

Accessory	Description
ECG Electrode	Electrode with snap clips
	Binding Electrode (4.0 mm aperture)

ECG cable

Accessory	Description
ECG Cable	5-lead ECG cable(6pin, snap, IEC)
	3-lead ECG cable(6pin, snap, IEC)
	5-lead ECG cable(6pin, snap, AHA)
	3-lead ECG cable(6pin, snap, AHA)
	5-lead ECG cable(6pin, 4mm inserted, IEC)
	3-lead ECG cable(6pin, 4mm inserted, IEC)
	5-lead ECG cable(6pin, 4mm inserted, AHA)
	3-lead ECG cable(6pin, 4mm inserted, AHA)

2. SpO₂

Accessory	Description
SpO ₂ sensor	Ear Clip sensor (5Pin)
	Tongue clip

3. NIBP

Accessory	Patient Type	Limb Girth (cm)	Cuff Size (cm)
NIBP CUFF (Disposable)	Small	3.3-5.6	1.6
	Small	4.2-7.1	3.2
	Medium	5-10.5	4

NIBP CUFF (Disposable)	Medium	6.9-10.7	5
	Medium	8.9-15	6
	Medium	12.4-16.8	7.5
	Large	20-27	11
	Super large	25.3-34.3	14
	Super large	32.1-43.4	17
NIBP CUFF (Reusable)	Medium	9-16	5
	Large	13-20	8
	Large	20-28	11
	Super large	25-35	14.4

4. TEMP

Accessory	Description
Temperature Probe	YSI 400 Series

Appendix A Technical Specifications

A.1 Environmental Specifications

Ambient Temperature	Working temperature: 0~+40°C Transportation and storage temperature: -20~+50°C
Relative humidity	Working ≤85% Transportation and storage ≤93%
Atmospheric pressure	Working 860~1060 hPa Transportation and storage 500~1060 hPa
Power Voltage	AC 100V~240V 50/60Hz
Power Input	≤ 70 VA
FUSE	T 1.6AL 250V, Φ5×20 (mm)
Anti-electroshock type	Class I equipment and internal powered equipment

A.2 Physical Specifications

Size	258mm×210mm×180mm
Weight	<3.5 kg (Includes recorder and battery, no other accessories)

A.3 Hardware Specifications

Display

LCD Type	7" Color TFT, of 480×234 Resolution
Number of trances	4 Waveforms Maximum
Indicator	1 Alarm LED (Yellow/Red) 1 AC power LED (Green/Orange) 1 Battery Charge LED (Yellow)

Battery

Size	182mm×61mm×24mm
Type	Rechargeable Lead acid cell, 12V/2.0AH
Charge time	≤10 hours

Operating time under the normal use and full charge	$\geq 120\text{min}$ New and fully charged battery at 25°C ambient temperature and NIBP work on AUTO mode for 20 minutes interval.
Operating time after the first alarm of low battery	≥ 5 minutes

Battery (option)

Type	Rechargeable Lithium ion battery
	11.1V/4.0AH
Charge time	≤ 6 hours
Operating time under the normal use and full charge	≥ 330 minutes
	New and fully charged battery at 25 °C ambient temperature and NIBP work on AUTO mode for 20 minutes interval.
Operating time after the first alarm if low battery	≥ 10 minutes

Recorder (Option)

Method	Thermal dot array
Paper width	50 mm (1.97 in)
Paper Speed	12.5/25/50 (mm/sec)
Traces	3 tracks Maximum
Recording types	Real-time recording Auto recording Alarm recording Trend table recording NIBP review recording

Audio indicator

Speaker	QRS Sound with Pitch Tone Alarm Sound, according to the requirement of IEC 60601-1-8
---------	---

Signal Interface

Network	Ethernet
RF Wireless LAN	433 MHz, 10 mW (Option)
Nurse Call	Driver mode: Relay Specs: $\leq 60W$, $\leq 2A$, $\leq 36VDC$, $\leq 25VAC$ Isolated Voltage: 1500VAC Type: N.C., N.O.

Alarm

Level	Low, medium and high
Indication	Sound and light indication
Setup	Default and custom
Silence	All alarms can be silenced
Volume	45~85 dB measured at 1 meter

A.4 Parameter Specifications

ECG

Lead Mode	1. 5-leads ECG input 2. 3-leads ECG input
Lead selection	1. I, II, III, aVR, aVL, aVF, V- 2. I, II, III
Gain	2.5mm/mV, 5mm/mV, 10mm/mV, 20mm/mV, 40mm/mV, Auto
Differential Input Impedance	≥ 5.0 Mohm
CMRR	MON ≥ 105 dB OPS ≥ 105 dB
Frequency response	MON 0.5~40Hz OPS 1~25Hz
Electrode offset potential	± 500 mV d.c.
Leakage Current	< 10 uA
ECG Signal Range	± 6.0 mV
Baseline recovery	< 5 sec After Defibrillation. (MON or OPS mode)
Pacemaker pulses	No rejection of pulses with amplitudes of ± 2 mV ~ ± 700 mV and durations of 0.5 ~ 2.0 ms.

Insulation	Breakdown Voltage 4000VAC 50Hz/60Hz
Indication of electrode separation	Every electrode (exclusive of RL)
Sweep speed	6.25 mm/s, 12.5mm/s, 25mm/s, 50mm/s

HR

Range	10~350bpm
Refreshing time	Per 4 pulses
Resolution	1bpm
Accuracy	±1% or ±1bpm, whichever is greater
Sensitivity	≥0.2mVpp
Alarm range	0~350bpm, continuously adjustable between high limit and low limit
Alarm	User-selectable upper and lower heart rate limits

NIBP

Method	Oscillometric	
Measurement Mode	Horse	Manual, Auto and STAT
	Dog	Manual, Auto and STAT
	Cat	Manual, Auto
Measurement Interval in Auto Mode	1,2,3,4,5,10,15,20,30,45,60,90 minutes 2,4,8 hours	
Measurement Period in STAT Mode	5 minutes	
Normal Measuring Range	SYS	30~270 mmHg
	DIA	10~220 mmHg
	MEAN	20~235 mmHg
Cuff pressure range	0~280 mmHg (0~300 mmHg in High Pressure mode)	
Resolution	1 mmHg	
Pressure Accuracy	Static Clinical	
	±2% or ±3 mmHg, whichever is greater ±5 mmHg average error 8 mmHg standard deviation	
Unit	mmHg, kPa	
Pulse rate range	40 ~ 240bpm	

Inflation time for cuff	Less than 40 sec. (standard cuff)
Total cycle time	20 to 45 seconds typical (dependent on heart rate and motion artifact)
Overpressure Protection Horse Dog Cat	Hardware and software double protections 315±10 mmHg 265±10 mmHg 255±10 mmHg
Alarm	User-selectable upper and lower limits for systolic, diastolic and mean pressures

SpO₂

BLT-SpO₂	
Measurement Range	0~100%
Resolution	1%
Accuracy	At 70~100%, ±2% At 0~69%, unspecified
Data update period	<13 Sec
PR	
Measurement Range	25~250bpm
Resolution	1bpm
Accuracy	±1% or ±1bpm, whichever is greater
Data update period	<13 Sec
Alarm	User-selectable upper and lower limits for SpO ₂ and PR
Nellcor-SpO₂ (option)	
Measurement Range	1~100%
Resolution	1%
Accuracy	At 70~100%, ±2 digits At 0~69%, unspecified
Perfusion Range	0.03% ~ 20%
Data update period	Average 7 Sec
PR	
Measurement Range	20~250bpm
Resolution	1bpm
Accuracy	±3 digits
Data update period	Average 7 Sec
Alarm	User-selectable upper and lower limits for SpO ₂ and PR

TEMP

Measurement Range	0.0~50.0°C
Resolution	0.1°C
Unit	Celsius (°C), Fahrenheit (°F)
Refreshing time	1s
Self check	Every 10 minutes
Accuracy	At 45.1~50.0°C, ±0.2°C(exclusive of probe) At 25.0~45.0°C, ±0.1°C(exclusive of probe) At 0.0~24.9°C, ±0.2°C (exclusive of probe)
Connecting cable	Compatible with YSI-400
Alarm	User-selectable upper and lower limits for TEMP1, TEMP2

RESP

Method	Impedance between RA-LL (R-F)
Measuring impedance range	0.2 ~3 Ohms
Excitation frequency	64.8 kHz
Excitation current	≤300 μ A @ 64.8 kHz
Base line impedance range	500~4000 Ohms (50~120 kHz exciting frequency)
Measurement Range	0~150 rpm
Resolution	1 rpm
Accuracy	±2 rpm
Gain	x1, x2, x4
Delay of Apnea Alarm	10~60s
Alarm	User-selectable upper and lower respiration rate limits, and user-selectable apnea limit
Sweep speed	6.25mm/s, 12.5mm/s, 25mm/s

Appendix B Default System Setup

There are three options of default system setup: Horse, Dog, Cat. The followings are the detail:

B.1 System

MAIN Setup	
Work-Screen	Standard Screen
QRS Volume	1
ALM Volume	1
ALM Paused	2 min
Sweep Speed	25mm/s
Trend Graph	
Interval	4 h
Trend Table	
Interval	1 min
Recorder Setup	
Auto REC	OFF
REC Length	8 s
ALM REC	2 min
Grid	ON
Color Setup	
ECG Wave	GREEN
ECG Data	GREEN
SpO2 Wave	MAGENTA
SpO2 Data	MAGENTA
RESP Wave	CYAN

RESP Data	CYAN
NIBP Data	WHITE
TEMP Data	YELLOW
Nurse Call Setup	
ALM Condition	PHYS、TECH
ALM Level	HIGH、MED

B.2 ECG

ECG Setup	Horse	Dog	Cat
Select Lead	II		
ECG Gain	10mm/mv		
ECG Mode	MON		
ALM Level	MED		
ALM REC	OFF		
HR HI LIM	50	160	200
HR LO LIM	30	70	90
Lead Cable	Keep the last selection		

B.3 SpO2/PR

SpO2 Setup	Horse	Dog	Cat
ALM Level	MED		
ALM REC	OFF		
SpO2 HI LIM	100	100	100
SpO2 LO LIM	90	90	90
PR HI LIM	50	160	200
PR LO LIM	30	70	90

Response mode	NORMAL
---------------	--------

B.4 NIBP

NIBP Setup	Horse	Dog	Cat
Auto Time	MANU		
Patient type	Cat		
NIBP Unit	mmHg		
ALM Level	MED		
ALM REC	OFF		
High Press	OFF		
SYS HI LIM	130	180	200
SYS LO LIM	80	70	90
DIA HI LIM	70	90	105
DIA LO LIM	20	35	40
MAP HI LIM	90	125	110
MAP LO LIM	60	60	60

B.5 RESP

RESP Setup	Horse	Dog	Cat
Apnea LIM	15 s		
RESP Gain	2x		
ALM Level	MED		
ALM REC	OFF		
RR HI LIM	35	40	40
RR LO LIM	5	8	8
Sweep Speed	12.5 mm/s		

B.6 TEMP

TEMP Setup	Horse	Dog	Cat
TEMP Unit	°C		
ALM Level	MED		
ALM REC	OFF		
T1 HI LIM	38.6	39.2	39.2
T1 LO LIM	37.5	38.1	38.1
T2 HI LIM	38.6	39.2	39.2
T2 LO LIM	37.5	38.1	38.1
TD HI LIM	1.0		

Appendix C Guidance and Manufacture's Declaration of EMC

Guidance and manufacture's declaration – electromagnetic emissions- for all EQUIPMENT and SYSTEMS

Guidance and manufacture's declaration – electromagnetic emission		
The Monitor is intended for use in the electromagnetic environment specified below. The customer of the user of the Monitor should assure that it is used in such an environment.		
Emission test	Compliance	Electromagnetic environment – guidance
RF emissions CISPR 11	Group 1	The Monitor uses RF energy only for its internal function. Therefore, its RF emissions are very low and are not likely to cause any interference in nearby electronic equipment.
RF emission CISPR 11	Class A	The Monitor is suitable for use in all establishments other than domestic and those directly connected to the public low-voltage power supply network that supplies buildings used for domestic purposes.
Harmonic emissions IEC 61000-3-2	Class A	
Voltage fluctuations/ flicker emissions IEC 61000-3-3	Complies	

Guidance and manufacture's declaration – electromagnetic immunity – for all EQUIPMENT and SYSTEMS

Guidance and manufacture's declaration – electromagnetic immunity			
The Monitor is intended for use in the electromagnetic environment specified below. The customer or the user of the monitor should assure that it is used in such an environment.			
Immunity test	IEC 60601 test level	Compliance level	Electromagnetic environment - guidance
Electrostatic discharge (ESD) IEC 61000-4-2	±6 kV contact ±8 kV air	±6 kV contact ±8 kV air	Floors should be wood, concrete or ceramic tile. If floor are covered with synthetic material, the relative humidity should be at least 30%.
Electrical fast transient/burst IEC 61000-4-4	±2 kV for power supply lines ±1 kV for input/output lines	±2 kV for power supply lines ±1 kV for input/output lines	Mains power quality should be that of a typical commercial or hospital environment.
Surge IEC 61000-4-5	±1 kV differential mode ±2 kV common mode	±1 kV differential mode ±2 kV common mode	Mains power quality should be that of a typical commercial or hospital environment.
Voltage dips, short interruptions and voltage variations on power supply input lines IEC 61000-4-11	<5% U_T (>95% dip in U_T) for 0.5 cycle 40% U_T (60% dip in U_T) for 5 cycles 70% U_T (30% dip in U_T) for 25 cycles <5% U_T (>95% dip in U_T) for 5 sec	<5% U_T (>95% dip in U_T) for 0.5 cycle 40% U_T (60% dip in U_T) for 5 cycles 70% U_T (30% dip in U_T) for 25 cycles <5% U_T (>95% dip in U_T) for 5 sec	Mains power quality should be that of a typical commercial or hospital environment. If the user of the monitor requires continued operation during power mains interruptions, it is recommended that the WED-3000 B Ultrasound Scanner be powered from an uninterruptible power supply or a battery.
Power frequency (50/60Hz) magnetic field IEC 61000-4-8	3A/m	3A/m	Power frequency magnetic fields should be at levels characteristic of a typical location in a typical commercial or hospital environment.
NOTE U_T is the a.c. mains voltage prior to application of the test level.			

Guidance and manufacture's declaration – electromagnetic immunity –

for EQUIPMENT and SYSTEMS that are not LIFE-SUPPORTING

Guidance and manufacture's declaration – electromagnetic immunity			
The Monitor is intended for use in the electromagnetic environment specified below. The customer or the user of the monitor should assure that it is used in such an environment.			
Immunity test	IEC 60601 test level	Compliance level	Electromagnetic environment - guidance
Conducted RF IEC 61000-4-6	3 Vrms 150 kHz to 80 MHz	3 V	Portable and mobile RF communications equipment should be used no closer to any part of the monitor, including cables, than the recommended separation distance calculated from the equation applicable to the frequency of the transmitter. Recommended separation distance $d = \left[\frac{3.5}{V_1} \right] \sqrt{P}$ $d = \left[\frac{3.5}{E_1} \right] \sqrt{P}$ 80 MHz to 800 MHz $d = \left[\frac{7}{E_1} \right] \sqrt{P}$ 800 MHz to 2.5 GHz Where P is the maximum output power rating of the transmitter in watts (W) according to the transmitter manufacturer and d is the recommended separation distance in metres (m). ^b Field strengths from fixed RF transmitters, as determined by an electromagnetic site survey, ^a should be less than the compliance level in each frequency range. ^b Interference may occur in the vicinity of equipment marked with the following symbol: 
Radiated RF IEC 61000-4-3	3 V/m 80 MHz to 2.5 GHz	3 V/m	
NOTE 1 At 80 MHz and 800 MHz, the higher frequency range applies. NOTE 2 These guidelines may not apply in all situations. Electromagnetic propagation is affected by absorption and reflection from structures, objects and people.			
a Field strengths from fixed transmitters, such as base stations for radio (cellular/cordless) telephones and land mobile radios, amateur radio, AM and FM radio broadcast and TV broadcast cannot be predicted theoretically with accuracy. To assess the electromagnetic environment due to fixed RF transmitters, an electromagnetic site survey should be considered. If the measured field strength in the location in which the monitor is used exceeds the applicable RF compliance level above, the monitor should be observed to verify normal operation. If abnormal performance is observed, additional measures may be necessary, such as reorienting or relocating the monitor.			
b Over the frequency range 150 kHz to 80 MHz, field strengths should be less than 3 V/m.			

**Recommended separation distances between portable and mobile
RF communications equipment and the EQUIPMENT or SYSTEM –
for EQUIPMENT or SYSTEM that are not LIFE-SUPPORTING**

Recommended separation distances between portable and mobile RF communications equipment and the SL-F SL Series Anti-decubitus Mattress			
The Monitor is intended for use in an electromagnetic environment in which radiated RF disturbances are controlled. The customer or the user of the monitor can help prevent electromagnetic interference by maintaining a minimum distance between portable and mobile RF communications equipment (transmitters) and the monitor as recommended below, according to the maximum output power of the communications equipment.			
Rated maximum output power of transmitter (W)	Separation distance according to frequency of transmitter (m)		
	150 kHz to 80 MHz $d = \left[\frac{3.5}{V_1} \right] \sqrt{P}$	80 MHz to 800 MHz $d = \left[\frac{3.5}{E_1} \right] \sqrt{P}$	800 MHz to 2.5 GHz $d = \left[\frac{7}{E_1} \right] \sqrt{P}$
0.01	1.2	0.12	0.23
0.1	3.8	0.38	0.73
1	12	1.2	2.3
10	38	3.8	7.3
100	120	12	23
For transmitters rated at a maximum output power not listed above, the recommended separation distance d in metres (m) can be estimated using the equation applicable to the frequency of the transmitter, where P is the maximum output power rating of the transmitter in watts (W) according to the transmitter manufacturer.			
NOTE 1 At 80 MHz and 800 MHz, the separation distance for the higher frequency range applies.			
NOTE 2 These guidelines may not apply in all situations. Electromagnetic propagation is affected by absorption and reflection from structures, objects and people.			

Product name: Veterinary monitor

Product type: M7000VET

Address: 535 Broadhollow Road Ste B-24, Melville, New York 747

[Http//www.biolightmeditechusa.com](http://www.biolightmeditechusa.com)

Tel: 888-82-BLUSA (888-822-5887)

Fax: 888-785-8948

Email: sales@biolightmeditechusa.com

PN: 22-027-0004