

CREATING POWER SOLUTIONS.

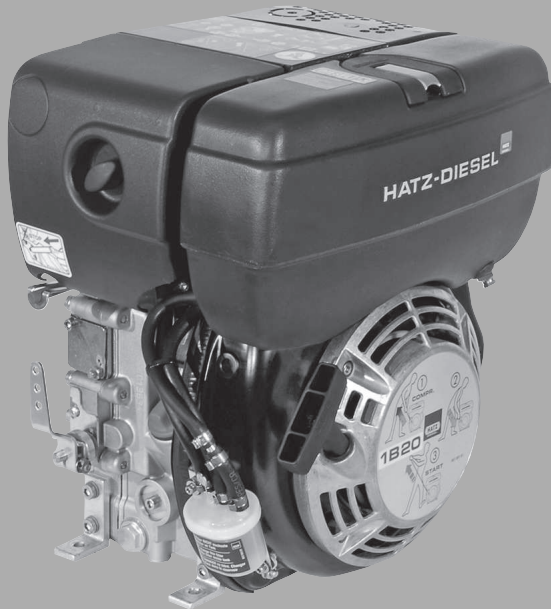

---

1B20 | 1B30 | 1B40 | 1B50

---

## MANUAL for diesel engine

**Hatz Diesel**

[www.hatz-diesel.com](http://www.hatz-diesel.com)



<b>1</b>	<b>Notices .....</b>	<b>5</b>
<b>2</b>	<b>General information .....</b>	<b>6</b>
<b>3</b>	<b>Safety .....</b>	<b>7</b>
3.1	General information .....	7
3.1.1	Intended use and foreseeable misuse .....	7
3.1.2	Machine user or machine manufacturer obligations .....	8
3.1.3	Representation of safety notes .....	9
3.1.4	Meaning of safety symbols .....	10
3.2	Safety notes .....	12
3.2.1	Operational safety .....	12
3.2.2	Machine-specific safety instructions for operation .....	15
3.2.3	Machine-specific safety instructions for maintenance work .....	16
3.2.4	Electrical equipment .....	18
3.3	Labels .....	20
<b>4</b>	<b>Technical data .....</b>	<b>22</b>
4.1	Engine information and filling quantities .....	22
4.2	Engine type plate .....	23
4.3	Physical operating conditions .....	24
4.4	Engine oil .....	25
4.5	Fuel .....	26
<b>5</b>	<b>Engine design .....</b>	<b>27</b>
<b>6</b>	<b>Transport, assembly and commissioning .....</b>	<b>29</b>
6.1	Transport .....	29
6.2	Installation notes .....	31
6.3	Preparations for commissioning .....	32
6.4	Filling engine oil (first filling) .....	32
6.5	Filling the oil bath air filter (option) .....	34
<b>7</b>	<b>Operation and use .....</b>	<b>35</b>
7.1	Safety notes .....	35
7.2	Performing tests .....	36
7.3	Setting the speed control .....	37
7.4	Starting the engine .....	38
7.4.1	Starting the engine with recoil start (up to -6 °C) .....	39
7.4.2	Starting the engine with a starter .....	40
7.5	Switching off the engine .....	44
7.5.1	Switching off the engine (mechanical) .....	44
7.5.2	Switching off the engine (electrical) .....	46
7.6	Check the oil level .....	48
7.6.1	Engine oil level .....	49
7.6.2	Oil level in the oil bath filter (option) .....	50

7.7	Refueling.....	51
7.8	Checking the water separator.....	53
7.9	Check the air filter warning indicator (option).....	55
<b>8</b>	<b>Maintenance .....</b>	<b>56</b>
8.1	General maintenance instructions .....	56
8.2	Maintenance work.....	57
8.2.1	Maintenance notice label .....	57
8.2.2	Maintenance plan .....	58
8.2.3	Checking the intake area .....	60
8.2.4	Change the engine oil.....	61
8.2.5	Clean the oil filter .....	64
8.2.6	Check and set the tappet clearance .....	66
8.2.7	Maintaining the oil bath filter .....	70
8.2.8	Clean the cooling air area.....	71
8.2.9	Check the screw connections.....	74
8.2.10	Clean the exhaust screen .....	75
8.2.11	Changing the fuel filter.....	79
8.2.12	Maintaining the dry air filter.....	84
8.2.13	Checking and cleaning the air filter cartridge.....	85
<b>9</b>	<b>Faults.....</b>	<b>87</b>
9.1	Troubleshooting.....	87
9.2	Emergency start.....	92
<b>10</b>	<b>Storage and disposal.....</b>	<b>94</b>
10.1	Storing the machine.....	94
10.2	Disposing of the machine .....	96
<b>11</b>	<b>Installation declaration .....</b>	<b>97</b>
<b>12</b>	<b>Declaration of the manufacturer.....</b>	<b>98</b>

# 1 Notices

## Contact data

© 2021  
Motorenfabrik HATZ  
Ernst-Hatz-Straße 16  
94099 Ruhstorf  
Germany  
Tel. +49 (0)8531 319-0  
Fax +49 (0)8531 319-418  
marketing@hatz-diesel.de  
www.hatz-diesel.com  
All rights reserved!

## Copyright

The copyright for this manual rests entirely with Motorenfabrik HATZ, Ruhstorf.

This manual may only be copied or distributed if written approval has been received. This also applies to the copying or distribution of excerpts of this manual. The same conditions apply to distribution of this manual to third parties in digital form.

## Original manual

This manual has been translated into multiple languages.

The German version is the **original manual**. All other language versions are **translations** of the **original manual**.

## 2 General information

### Information on the document

This manual was created with due care. It is exclusively intended to offer a technical description of the machine and to provide instructions on commissioning, operating and maintaining the machine. When operating the machine, the applicable standards and legal regulations as well as any in-house regulations apply.

Before commissioning, during operation and before maintenance work is begun on the machine, read this manual carefully and keep it close by for ready access.

### Machine

This manual describes the following machine.

Machine name	HATZ diesel engine
Type number	1B20, 1B30, 1B40, 1B50

### Customer service

Have service work performed by qualified technicians only. We recommend that you work with one of the over 500 **HATZ service stations**. Trained specialists there will repair your machine with **Hatz original spare parts** and with **HATZ tools**. The global HATZ service network is at your disposal to advise you and supply you with spare parts. For the address of the **Hatz service station** nearest you, please see the enclosed spare parts list or visit us in the Internet at: **[www.hatz-diesel.com](http://www.hatz-diesel.com)**

Installation of unsuitable spare parts can lead to problems. We cannot accept responsibility for direct damage or secondary damage that results from this.

We therefore recommend the use of **Hatz original spare parts**. These parts are manufactured according to strict Hatz specifications and achieve maximum operational reliability through their perfect fit and functionality. The order number can be found in the enclosed spare parts list or on the Internet at: **[www.hatz-diesel.com](http://www.hatz-diesel.com)**

### Exclusion of liability

The manufacturer cannot be held responsible for personal injury, damage to property or damage to the machine itself caused by improper use, foreseeable misuse, or failure to follow or adequately follow the safety measures and procedures described in this manual. This also applies to changes made to the machine and the use of unsuitable spare parts.

Modifications, which serve the technical improvements, are reserved

## 3 Safety

### 3.1 General information

#### Introduction

This chapter contains the information you need to work safely with this machine.

To prevent accidents and damage to the machine, it is imperative that these safety instructions be followed.

Read this chapter carefully before beginning work.

#### 3.1.1 Intended use and foreseeable misuse

##### Intended use

The machine described in this manual fulfills the following functions:

- Diesel engine intended for installation in a machine or for assembly with other machines to form a machine. See chapter *11 Installation declaration*, page 97.

This engine is intended exclusively for the purpose specified and tested by the manufacturer of the machine in which the engine is installed.

Any other use is not intended and therefore not permitted. Violations compromise the safety of the personnel working with the machine. Motorenfabrik HATZ does not accept any liability for damage resulting from this.

The operational safety of the machine is only guaranteed if it is used as intended.

Use according to the intended purpose also includes observance of the instructions in this Operator's Manual.

##### Foreseeable misuse

The following is considered to be foreseeable misuse:

- Any use that varies from or extends beyond the uses specified above.
- Failure to comply with the instructions given in this manual.
- Failure to comply with the safety instructions.
- Failure to immediately eliminate malfunctions that impact safety before continuing work with the machine (working with the machine when it is not in perfect condition, either functionally or in terms of safety).
- Failure to perform the necessary inspection and maintenance work.
- Any unauthorized modification of or removal of safety equipment.
- Use of spare parts and accessories that are unsuitable or have not been approved by HATZ.
- Operation in flammable or hazardous environments.
- Operation in closed-off or poorly ventilated rooms.

- Operation in an aggressive atmosphere (e.g. high salt content) without further measures for corrosion protection.
- Installation of the device on movable supports (e.g. vehicles, trailers) without HATZ approval.
- Improper operation at variance with DIN ISO 3046 -1 and DIN ISO 8528 (climate, load, safety).

### Residual risks

Residual risks result during daily use and in association with maintenance work.

These residual risks will be pointed out in chapter 3.2.2 *Machine-specific safety instructions for operation, page 15* and in chapter 3.2.3 *Machine-specific safety instructions for maintenance work, page 16* as well as in the further contents of the manual, directly in front of the descriptions or operating instructions concerned.

## 3.1.2 Machine user or machine manufacturer obligations

### Machine manufacturer obligations

If you have an engine that is not yet installed in a machine, it is imperative that you follow the **Assembly Instructions for HATZ Diesel Engines** before installing the engine. These assembly instructions contain important information on how to safely install the engine and are available at your nearest **HATZ service station**.

**It is prohibited to start the engine before it is fully installed.**

In addition, please note that it is prohibited to start up the machine before it has been determined that the machine into which this engine is installed fulfills all safety-related requirements and legal regulations.

### User obligations

The operator is obliged to only operate the machine when it is in perfect condition. The operator must check the condition of the machine before use and ensure that any defects are eliminated before it is taken into service. Running the machine while identified defects exist is not permitted. The user must also ensure that all persons who work on the machine are familiar with the contents of this manual.



### **Obligations of the operating and maintenance personnel**

Personnel assigned with operating and maintaining the machine must have read and understood this manual or must possess the qualifications necessary for working with this equipment, acquired in training/instructional courses. No one may work with the machine without the necessary qualifications, even if for just a brief period.

The operating and maintenance personnel must not be under the influence of drugs, medication or alcohol.

All work performed on the machine must be in compliance with the information provided in this manual.

### **Storing this manual**

This manual is an integral component of the machine (also when being sold). It must be stored in the direct vicinity of the machine and be accessible to personnel at all times.

## **3.1.3 Representation of safety notes**

### **Overview**

This machine has been designed and built according to state-of-the-art technology and the recognized safety standards. Despite these precautions, risks exist when operating the machine and during maintenance work.

These risks are identified in this manual by means of safety notes.

The safety notes precede the related description or operating step.

### **Structure of the safety notes**

The safety notes consist of:

- Danger symbol
- signal word
- Description of danger
- Possible consequences
- Preventative measures



### **General danger symbol**



The general danger symbol is used to identify the danger of personal injury.

## Signal words





Signal words identify the magnitude of the risk and the seriousness of the possible injuries:







Danger symbol/ signal word	Meaning
 <b>DANGER</b>	This signal word is used to indicate imminently dangerous situations which, if not avoided, will lead to serious injury or death.
 <b>WARNING</b>	This signal word is used to indicate potentially dangerous situations which, if not avoided, may lead to serious injury or death.
 <b>CAUTION</b>	This signal word is used to indicate potentially dangerous situations which, if not avoided, may lead to minor or moderate injury.
<b>CAUTION</b>	This signal word, without a danger symbol, is used to indicate the risk of property damage.
<b>NOTICE</b>	This signal word indicates additional useful information, such as operating tips and cross references.

### 3.1.4 Meaning of safety symbols

#### Explanation of symbols

The following table describes the meanings of the safety symbols used in this manual.

Symbol	Meaning
	Smoking, fire, and open flames are prohibited!
	Warning of personal injury!
	Warning of hot surfaces!
	Warning of flammable substances!



Symbol	Meaning
	Warning of explosive substances!
	Warning of toxic engine exhaust!
	Warning of corrosive substances!
	Warning of heavy loads!
	Warning of environmental damage!
	Comply with this manual or additional documentation from other manufacturers or the carrier.
	Additional information that is useful to the reader.

## 3.2 Safety notes

### 3.2.1 Operational safety

#### Introduction

This chapter contains all of the important safety instructions for personal protection and for safe and reliable operation. Additional, task-related safety instructions can be found at the beginning of each chapter.

 <b>DANGER</b>	
	<p><b>Danger to life, danger of injury or danger of property damage due to failure to comply with this manual and the safety instructions contained therein.</b></p> <ul style="list-style-type: none"><li>▪ As the operator of the machine, you must ensure that all people working on the machine are familiar with the content of this manual.</li><li>▪ Before working on the machine, read this manual carefully, paying special attention to the safety notes.</li><li>▪ Fulfill all required safety conditions before working on the machine.</li><li>▪ Follow all general safety instructions as well as the specific task-related safety instructions contained in the individual chapters.</li></ul>

#### Using the machine

- Only operate the machine for the purposes described in chapter 3.1.1 *Intended use and foreseeable misuse*, page 7.

#### Compliance with other regulations

- The applicable regulations of the relevant professional associations must be observed.
- Comply with the regulations concerning the minimum safety and health requirements for the use of work equipment by workers at work.
- In addition, local safety, accident prevention and environmental regulations also apply when operating the machine.

#### Personal protective equipment

During operation and maintenance of the machine, personal protective equipment must be available and must be used if necessary. The use of personal protective equipment is specified in the description of the operating steps.

Personal protective equipment	Pictogram	Function
Safety shoes		Safety shoes offer protection against: <ul style="list-style-type: none"> <li>▪ Slipping</li> <li>▪ Falling objects</li> </ul>
Hearing protection		Hearing protection offers protection against ear injuries due to excessive and constant noise.
Safety gloves		Safety gloves protect the hands against injury, e.g. from battery acid.
Safety goggles (with side protection)		Safety goggles protect the eyes from flying objects (e.g. dust particles, spraying liquids, spraying acid).
Fine dust mask		A fine dust mask protects the wearer against particulate pollutants.
Working clothes		Wear close-fitting clothing. It must not restrict the wearer's freedom of movement, however.

### Warning labels and information signs on the machine

The warning labels and information signs on the machine must be followed (see chapter "Labels" 3.3 *Labels*, page 20).

The warning labels and information signs must be kept legible and must be replaced if necessary. For this purpose, contact your nearest **HATZ service station**.

### Maintenance work







Maintenance work that goes beyond the scope described in this manual must only be performed by qualified technicians (see chapter 2 *General information*, page 6).

Independent maintenance work and constructional changes to the machine, especially to the safety equipment, are not permitted.

## Safety equipment

Safety equipment must not be modified and must not be rendered ineffective during normal operation.

## General safety instructions

 <b>DANGER</b>	
	<p><b>Danger to life and danger of injury due to failure to follow the warnings on the machine and in this manual.</b></p> <ul style="list-style-type: none"> <li>▪ Heed the warnings on the machine and in this manual.</li> </ul>
 <b>WARNING</b>	
	<p><b>Danger of injury and danger of incorrect operation due to inadequate personnel qualifications.</b></p> <ul style="list-style-type: none"> <li>▪ The personnel must have read and understood this manual or must possess the qualifications necessary for working with this equipment, acquired in training/instructional courses.</li> <li>▪ Only qualified personnel is permitted to operate and maintain this machine.</li> <li>▪ Failure to comply will cause the warranty to become void.</li> </ul>
 <b>WARNING</b>	
	<p><b>Danger of injury from failure to follow the operating instructions and from performing unauthorized tasks on the machine.</b></p> <ul style="list-style-type: none"> <li>▪ Follow all instructions.</li> <li>▪ Do not perform activities for which no qualification is available. Contact properly trained personnel if necessary.</li> </ul>
 <b>CAUTION</b>	
	<p><b>Danger of injury from overloading the body.</b></p> <p>Lifting the machine to transport it or to move it to another location can lead to injuries (of the back, for example).</p> <ul style="list-style-type: none"> <li>▪ Only lift the machine with a hoist (see chapter 6.1 <i>Transport</i>, page 29).</li> </ul>

## 3.2.2 Machine-specific safety instructions for operation

### Introduction

The machine can pose residual risks during operation. To eliminate these risks, all persons working on the machine must follow the general and machine-specific safety instructions.

If you have an engine that is not yet installed in a machine, it is imperative that you follow the **Assembly Instructions for HATZ Diesel Engines** before installing the engine.

These assembly instructions contain important information on safe installation.

If the engine is installed in a machine or assembled with other machines to form a machine, it is prohibited to start the engine before it has been determined that the newly created machine fulfills all safety-related requirements and applicable legal regulations.



### Safe operation







- Before switching on the machine, ensure that no one can be injured when the machine is started up.
- During machine operation, ensure that unauthorized persons do not have access to the area in which the machine has an impact.
- Parts of the exhaust gas system and the surface of the engine become hot during operation. Risk of injury from touching hot parts! Let the engine cool before maintenance.
- Do not refuel during operation.

### Faults

- Immediately eliminate faults that compromise safety.
- Switch off the machine and do not take into service again until all faults have been eliminated.

### Safety instructions for operation

 <b>DANGER</b>	
	<p><b>Danger to life from inhaling exhaust gases.</b></p> <p>Toxic engine exhaust gases can lead to loss of consciousness and even death in closed-off and poorly ventilated rooms.</p> <ul style="list-style-type: none"> <li>▪ Never operate the machine in closed-off or poorly ventilated rooms.</li> <li>▪ Do not breathe in the exhaust gases.</li> </ul>

 <b>DANGER</b>	
	<p><b>Danger of fire from hot exhaust gas system.</b></p> <p>If inflammable materials come into contact with the exhaust gas flow or the hot exhaust gas system, these materials can ignite.</p> <ul style="list-style-type: none"> <li>▪ Keep inflammable materials away from the exhaust gas system.</li> <li>▪ Do not operate the engine (exhaust flow or hot exhaust gas system) in the direct vicinity of combustible materials.</li> </ul>
 <b>DANGER</b>	
 	<p><b>Fire hazard from fuel.</b></p> <p>Leaked or spilled fuel can ignite on hot engine parts and cause serious burn injuries.</p> <ul style="list-style-type: none"> <li>▪ Only refuel when the engine is switched off and has cooled down.</li> <li>▪ Never refuel in the vicinity of open flames or sparks that can cause ignition.</li> <li>▪ Do not smoke.</li> <li>▪ Do not spill fuel.</li> </ul>
 <b>CAUTION</b>	
	<p><b>Danger of injury from faulty starter rope.</b></p> <p>A chafed starter rope can rip and cause injuries.</p> <ul style="list-style-type: none"> <li>▪ Before using the starter rope, check for abrasion; replace the rope if necessary.</li> </ul>

### 3.2.3 Machine-specific safety instructions for maintenance work

#### Introduction

The machine can pose residual risks during maintenance. To eliminate these risks, all persons working on the machine must follow the general and machine-specific safety instructions.

#### Maintenance intervals

- Strictly adhere to the maintenance intervals.
- Check the safety equipment regularly to ensure it is in good condition and functioning properly.
- Check connections, cables and fasteners regularly to ensure they are in good condition.



## Maintenance work

Maintenance work that goes beyond the scope described in this manual must only be performed by qualified technicians. We recommend that you work with one of the over 500 **HATZ service stations**.





## Replacing parts





- When replacing defective components, we recommend that you use **genuine HATZ original spare parts** (see chapter 2 *General information*, page 6).
- When disposing of parts that can no longer be used, do so in accordance with local environmental regulations or send them to a recycling center.

## Measures following maintenance and troubleshooting

- Securely reconnect loose electrical connections; check that the electrical components and equipment are functioning properly.
- Check the entire machine for foreign bodies; remove any foreign bodies.



## Safety instructions for maintenance work

 <b>DANGER</b>	
	<p><b>Danger of explosion from flammable cleaning agents.</b></p> <p>Cleaning with benzene is an explosion hazard. It is highly flammable, can become electrostatically charged, and can generate an explosive gas/air mixture.</p> <ul style="list-style-type: none"> <li>▪ Use halogen-free, cold cleaners with a high flashpoint for cleaning.</li> <li>▪ Comply with manufacturer's instructions.</li> </ul>
 <b>WARNING</b>	
 	<p><b>Danger of injury from compressed air and dust particles.</b></p> <p>Eye injuries may occur when cleaning with compressed air.</p> <ul style="list-style-type: none"> <li>▪ Wear safety goggles.</li> </ul>

 <b>CAUTION</b>	
	<p><b>Danger of injury if maintenance instructions are not followed.</b></p> <ul style="list-style-type: none"> <li>▪ Only perform maintenance when the engine is switched off.</li> <li>▪ Protect start-up devices (crank handle, recoil start or starting key) from unauthorized access.</li> <li>▪ For engines with a starter: Disconnect the negative battery terminal.</li> <li>▪ When the maintenance work has been completed, ensure that all tools are removed from the machine.</li> </ul>
 <b>CAUTION</b>	
	<p><b>Danger of burns.</b></p> <p>There is a danger of burns when working on a hot engine.</p> <ul style="list-style-type: none"> <li>▪ Let the engine cool before maintenance.</li> </ul>

### 3.2.4 Electrical equipment

#### Safety notes

 <b>DANGER</b>	
	<p><b>Danger to life, danger of injury or danger of property damage due to incorrect use of batteries.</b></p> <ul style="list-style-type: none"> <li>▪ Do not place tools or other metal objects on the battery.</li> <li>▪ Before performing work on the electrical equipment, always disconnect the negative battery terminal.</li> <li>▪ Never swap the positive (+) and negative (–) battery terminals.</li> <li>▪ When installing the battery, first connect the <b>positive cable</b> and then the <b>negative cable</b>.</li> <li>▪ When removing the battery, first disconnect the <b>negative cable</b> and then the <b>positive cable</b>.</li> <li>▪ It is imperative to prevent short circuits and mass contact of current carrying cables.</li> <li>▪ If faults occur, check the cable connections for good contact.</li> </ul>

**DANGER****Danger of explosion from flammable substances.**

There is a danger of explosion from flammable gases.

- Keep batteries away from open flames and incendiary sparks.
- Do not smoke when working with batteries.

**CAUTION****Danger of chemical burns**

Chemical burns can occur when using batteries for the electrical operation.

- Protect your eyes, skin, and clothing from corrosive battery acid.
- Immediately rinse areas affected by splashed acid with clear water and consult a physician if necessary.

**NOTICE**



- We cannot be held liable for electrical equipment that is not designed according to HATZ wiring diagrams.

- Promptly replace faulty indicator lamps.
- Do not pull out the starting key during operation.
- Do not disconnect the battery while the machine is running. Resulting voltage peaks could destroy the electronic components.
- When performing a manual emergency start, leave the (possibly depleted) battery connected.
- When cleaning, do not spray the electrical equipment components with a water jet or high pressure cleaner.
- When performing welding work on the machine, disconnect the battery and place the ground clamp of the welding equipment as close as possible to the welding area. Disconnect the plug-in connections to the voltage regulator.
- The following additionally applies before starting emergency operation without the battery:
  - In models with an instrument box on the engine, disconnect the plug-in connection to the voltage regulator. Turn the starting key to pos. "0" and remove.
  - In models with an external instrument box, disconnect the plug-in connection to the instrument box.

### 3.3 Labels

#### Warning labels and information signs on the engine

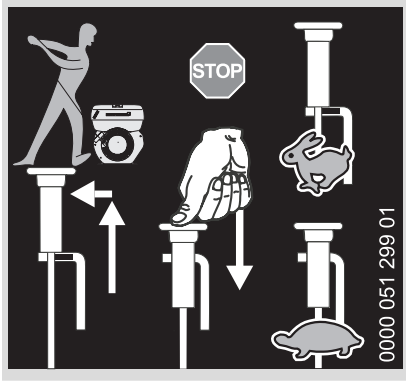
Label	Meaning
	<p>Maintenance instructions (see chapter 8.2 <i>Maintenance work</i>, page 57)</p>
	<p>Start the engine with the recoil start (see chapter 7.4.1 <i>Starting the engine with recoil start</i> (up to -6 °C), page 39)</p>
	<p><b>CAUTION!</b>          Danger of injury from faulty starter rope.          A chafed starter rope can rip and cause injuries.</p> <ul style="list-style-type: none"> <li>Before using the starter rope, check for abrasion; replace the rope if necessary.</li> </ul>

Label	Meaning
	<p>Speed adjustment with connecting rod (additional equipment)</p>
	<p>Refuel with diesel fuel only. For the specification, see chapter 4.5 <i>Fuel</i>, page 26.</p>
	<p>Changing the fuel filter (see chapter 8.2.11 <i>Changing the fuel filter</i>, page 79)</p>

## 4 Technical data

### 4.1 Engine information and filling quantities

Type		1B20	1B30	1B40	1B50
Type		Air-cooled, four stroke diesel engine			
Combustion system		Direct injection			
Number of cylinders		1	1	1	1
Bore/Stroke	mm	69 / 65	80 / 69	88 / 76	93 / 76
Displacement	cm <sup>3</sup>	243	347	462	517
Tank capacity	Ltr.	3	5	5	5
Engine oil capacity					
Without oil sump	Approx. ltr.	0.9 <sup>1)</sup>	1.1 <sup>1)</sup>	1.5 <sup>1)</sup>	1.5 <sup>1)</sup>
With oil sump	Approx. ltr.	2.6 <sup>1)</sup>	2.8 <sup>1)</sup>	3.2 <sup>1)</sup>	-
Difference between "max" and "min" marking					
Without oil sump	Approx. ltr.	0.5 <sup>1)</sup>	0.5 <sup>1)</sup>	0.8 <sup>1)</sup>	0.8 <sup>1)</sup>
With oil sump	Approx. ltr.	1.6 <sup>1)</sup>	1.8 <sup>1)</sup>	2.2 <sup>1)</sup>	-
Engine oil consumption (after running-in period)	Max.	1 % of fuel consumption, pertaining to full load			
Engine oil pressure at oil temperature of 100 °C	Approx.	2.5 bar at 3000 rpm			
Sense of rotation on power take-off side		Left			
Tappet clearance at 10–30 °C inlet/outlet	mm	0.20	0.10	0.10	0.10
Max. perm. inclination during continuous operation in direction		Flywheel low 25° <sup>2)</sup> Other directions 35° <sup>2)</sup>			
Weight (incl. fuel tank, air filter, silencer and electric start)	Approx. kg	33	40	55	57
Battery capacity	Min/max	12 V – 36/55 Ah/24 V – 24/44 Ah			

<sup>1)</sup> These specifications are approximate values. The max. mark on the dipstick is decisive in any case (see chapter 7.6 *Check the oil level*, page 48).

<sup>2)</sup> Exceeding these limit values causes engine damage.

## Engine specifications

Model	Description
R	for rammer operation (1B20R only)
T	normal counter balance (1B40T and 1B50T only)
U	additional counter balance (1B40U and 1B50U only)

## Screw tightening torque

Designation	Nm
Oil drain screw	50

## 4.2 Engine type plate

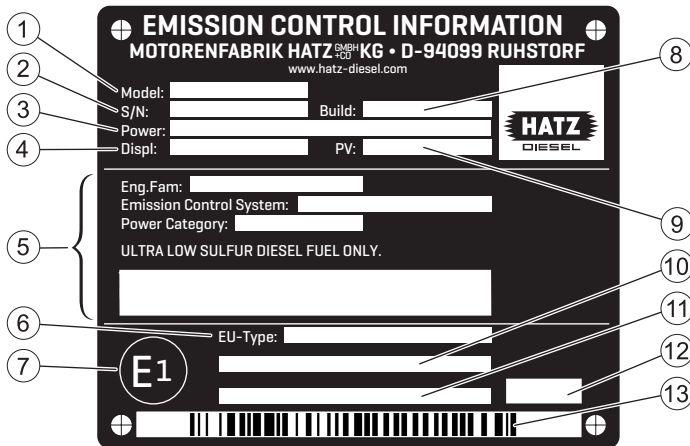

The engine type plate is located on the sound protection hood and contains the following engine information:

1	Model designation of the engine
2	Engine serial number
3	Engine power (kW) at rated speed (rpm)
4	Displacement (liters)
5	Information for US emission certification (EPA/CARB)
6	EU type approval number
7	EU country of origin (Germany)
8	Model year (month/year)
9	Test specification for special settings

10	Engine family designation or exception code (EM) or transition code (TM) according to regulation (EU) 2016/1628
11	Additional specifications according to Regulation 2017/656 (exceptions) or "Separate shipment information"
12	Code for type plate variant
13	Barcode (engine serial number)

The following data must always be specified in case of queries and for spare parts orders:

1	Model designation
2	Engine serial number
3	Rated speed (rpm)

### 4.3 Physical operating conditions

#### Engine adjustment

The engine is normally adjusted to operate within the standard reference conditions stipulated in ISO 3046-1:

Parameter	Unit	Value
Intake air temperature	°C	+25
	K	298
Relative humidity	%	30
Air pressure (at approx. 100 meters above sea level)	kPa	100

#### NOTICE



If the machine is operated at high altitudes and high temperatures, adjustment of the engine setting may be necessary if the climatic conditions were not taken into account when the machine was ordered. If this is the case, please contact your nearest **HATZ service station**.



## 4.4 Engine oil

### Oil quality

All oil brands that meet at least one of the following specifications are suitable:

- **ACEA – B3 / E4** or better
- **API – CF / CH-4** or better

If engine oils of a low quality standard are used, the oil change interval must be reduced to 150 operating hours.

### Oil viscosity

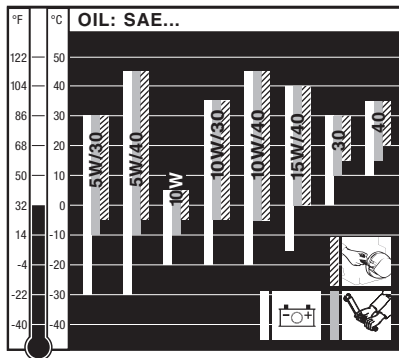

Choose the recommended viscosity based on the type of start (recoil, crankhandle or electric) and on the engine temperature at which the engine will be operated.

### CAUTION

#### Engine damage from unsuitable engine oil.

Unsuitable engine oil considerably reduces engine service life. Only use engine oil that fulfills the specifications stipulated above.

## 4.5 Fuel

### Fuel type

All types of diesel fuel that meet the minimum requirements of the following specifications are suitable:

- **Europe: EN 590**
- **UK: BS 2869 A1 / A2**
- **USA: ASTM D 975-09a 1-D S15 or 2-D S15**
- **USA: ASTM D 975-09a 1-D or 2-D <sup>1)</sup>**

<sup>1)</sup> Only suitable for engines without engine family designation on the engine type plate. For details, see chapter 12 *Declaration of the manufacturer*, page 98.

<b>CAUTION</b>	
	<p><b>Danger of engine damage from low quality fuel.</b></p> <p>The use of fuel that does not meet the specifications can lead to engine damage.</p> <ul style="list-style-type: none"> <li>▪ The use of fuel that does not meet specifications requires approval by Motorenfabrik HATZ (main plant).</li> </ul>

<b>CAUTION</b>	
	<p><b>Danger of malfunctions due to old fuel.</b></p> <p>When diesel fuel is stored in a fuel tank or canister for lengthy periods, deposits may form on account of fuel aging. These deposits result in malfunctions due to clogged fuel filters and damage to the injection system.</p> <ul style="list-style-type: none"> <li>▪ Perform the prescribed storage steps in machines that will be out of use for more than three months (see section 10.1 <i>Storing the machine</i>, page 94).</li> <li>▪ Only refuel with fresh diesel fuel such as can be obtained from filling stations.</li> </ul>

### Winter fuel

Diesel fuel loses its fluidity at low temperatures, which can lead to operating problems. Use cold-resistant winter diesel fuel for outside temperatures below 0 °C.

## 5 Engine design

### Overview

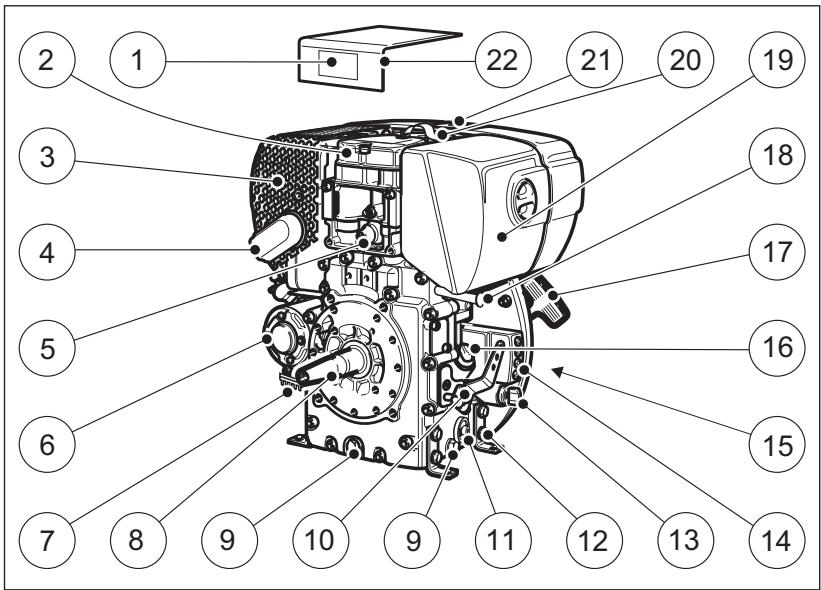

1	Type plate
2	Cylinder head cover
3	Silencer with contact protection
4	Exhaust manifold with exhaust screen
5	Oil pressure switch <sup>1)</sup>
6	Starter <sup>1)</sup>
7	Voltage regulator <sup>1)</sup>
8	Crankshaft – power take-off (pto)
9	Oil drain screw
10	Speed control lever
11	Screw cap for oil filter
12	Engine mount
13	Starting key <sup>1)</sup>
14	Indicators <sup>1)</sup>
15	Intake opening for cooling and combustion air
16	Oil filling opening and dipstick

17	Recoil start
18	Stop pin (option)
19	Dry air filter
20	Lifting eye
21	Fuel cap
22	Sound protection hood







<sup>1)</sup> Only in model with electrical equipment.

The engine can optionally be supplied with an **external** instrument box.

## 6 Transport, assembly and commissioning

### 6.1 Transport

#### Safety notes

 <b>WARNING</b>	
	<p><b>Danger of injury from improper lifting and transport.</b></p> <p>Danger of crushing from the engine falling or tipping.</p> <ul style="list-style-type: none"> <li>▪ Only use the lifting eye already mounted on the machine for lifting.</li> <li>▪ Before lifting the engine, check the lifting eye for damage. Lifting with a damaged lifting eye is not permitted. Replace a damaged lifting eye before using it for lifting.</li> <li>▪ Only use a suitable hoist with a sufficient carrying capacity.</li> <li>▪ Do not remain under suspended loads.</li> </ul>
 <b>CAUTION</b>	
	<p><b>Only use the lifting eye for transporting the engine.</b></p> <p>Do not use for lifting the entire machine.</p>
 <b>CAUTION</b>	
	<p><b>Danger of injury from overloading the body.</b></p> <p>Lifting the machine to transport it or to move it to another location can lead to injuries (of the back, for example).</p> <ul style="list-style-type: none"> <li>▪ Only lift the machine with a hoist.</li> </ul>
<b>NOTICE</b>	
	<p><b>Danger of environmental damage from leaking fluid.</b></p> <p>If the machine is tilted, engine oil and fuel can run out.</p> <ul style="list-style-type: none"> <li>▪ Only transport the machine in an upright position.</li> </ul>

### Transport conditions

- When transporting the machine, follow the safety instructions.
- When transporting, follow the applicable safety and accident prevention regulations.
- After delivery, check the machine for completeness and transport damage.
- Only transport the machine when it is switched off and has cooled down.
- If you have questions on transporting the machine, please contact your nearest **HATZ service station**. For contact data, see chapter 1 *Impressum*, page 5 or [www.hatz-diesel.com](http://www.hatz-diesel.com).

### Access to the lifting eye

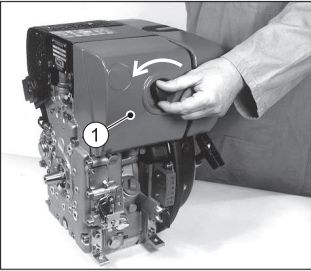
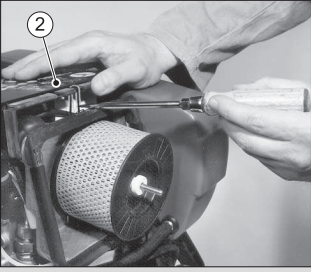
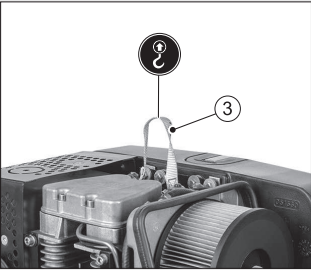
Step	Activity	Figure
1	Unscrew the air filter cover (1).	
2	Remove the sound protection hood (2).	
3	Attach the hoist securely to the lifting eye (3).	

Step	Activity	Figure
4	After completion of transportation, refit the sound protection hood and cover for the air filter.	

## 6.2 Installation notes

HATZ diesel engines are efficient, robust, and have a long service life. Therefore, they are usually installed in machines that are used for commercial purposes.

The machine manufacturer must follow the applicable regulations regarding machine safety – the engine is a part of a machine.

Depending on the use and installation of the engine, it may be necessary for the machine manufacturer and machine user to install safety equipment to prevent inappropriate use. Note the following:

- Parts of the exhaust gas system and the engine surface become hot during operation and may not be touched until they cool down after the engine is switched off.
- Incorrect cable connections and incorrect operation of the electrical equipment can lead to sparking and must be avoided.
- After the engine is installed in the machine, rotating parts must be protected against contact.  
HATZ safety equipment is available for the belt drive of the cooling fan and alternator.
- Comply with all notices and warning labels on the engine and keep them in a legible condition. If a label should become detached or difficult to read, it must be replaced promptly. For this purpose, contact your nearest **HATZ service station**.
- Any improper modification of the engine will result in a loss of liability coverage for resulting damage.



Only regular maintenance, as specified in this manual, will maintain the operating readiness of the engine.

The **assembly instructions** contain important information on how to safely assemble the engine. They are available from any **Hatz service station**.

If you have any questions, please contact your nearest **HATZ service station** before commissioning the engine.

### 6.3 Preparations for commissioning



- Check the delivered parts for completeness, damage, and other noticeable issues.
- Ensure that the setup location is adequately ventilated.

 <b>DANGER</b>	
	<p><b>Danger to life from inhaling exhaust gases.</b></p> <p>Toxic engine exhaust gases can lead to loss of consciousness and even death in closed-off and poorly ventilated rooms.</p> <ul style="list-style-type: none"> <li>▪ Never operate the machine in closed-off or poorly ventilated rooms.</li> <li>▪ Do not breathe in the exhaust gases.</li> </ul>

### 6.4 Filling engine oil (first filling)

Engines are normally delivered without an engine oil filling.

#### Safety notes

 <b>CAUTION</b>	
 	<p><b>Danger of injury</b></p> <p>Prolonged contact with engine oil can lead to irritation of the skin.</p> <ul style="list-style-type: none"> <li>▪ Wear safety gloves.</li> <li>▪ If there is contact with the skin, thoroughly wash the affected areas of the skin with soap and water.</li> </ul>

<b>CAUTION</b>	
	<p><b>Danger of later engine damage.</b></p> <ul style="list-style-type: none"> <li>▪ Operating the engine with an oil level below the <b>min.</b> mark or above the <b>max.</b> mark can lead to engine damage.</li> <li>▪ When checking the oil level, the engine must be horizontal and have been switched off for a few minutes.</li> </ul>



## Overview

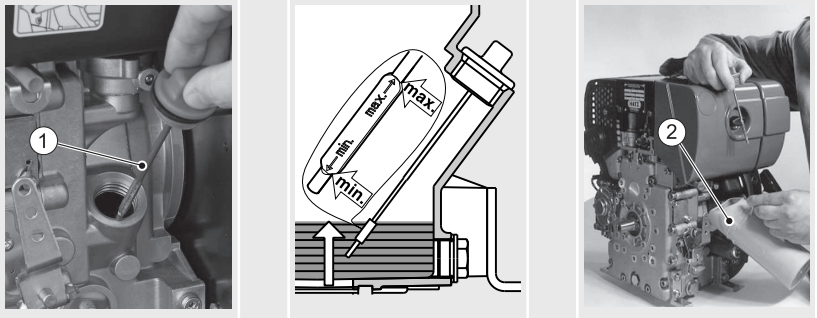

1	Dipstick
2	Oil refilling container

## Procedure

Step	Activity
1	Unscrew the dipstick (1) and clean it.
2	Fill engine oil. For the specification and viscosity, see chapter 4.4 <i>Engine oil</i> , page 25. See chapter 4.1 <i>Engine information and filling quantities</i> , page 22 for the engine oil capacity.
3	Reinsert the dipstick and screw it tight.
4	Unscrew the dipstick and check the oil level.
5	If required, top up engine oil to the max. mark.
6	Reinsert the dipstick and screw it tight.

## 6.5 Filling the oil bath air filter (option)

### Overview

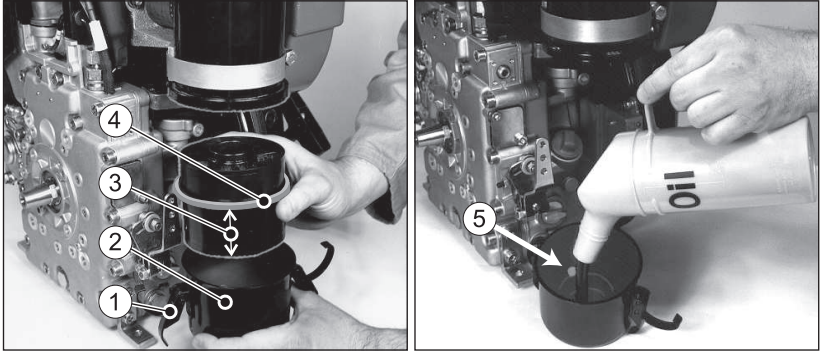

1	Clamp fastener (2x opposing)
2	Oil container
3	Filter insert
4	Gasket
5	Level mark

### Procedure

Step	Activity
1	Release the clamp fasteners (1).
2	Remove the oil container (2).
3	Take the filter insert (3) out of the oil container.
4	Fill the oil container with engine oil up to the level mark (5).
5	Insert the long end of the filter insert (3) into the oil container.
6	Mount the oil container, ensuring that the gasket (4) is properly positioned and the locks (1) are correctly fastened.

## 7 Operation and use

### 7.1 Safety notes

#### NOTICE



#### Comply with the safety chapter!

Follow the basic safety instructions in chapter 3 *Safety*, page 7.



#### WARNING



#### Danger of injury from damage and defects on the machine.

- Do not take the machine into service if damage has been localized and identified.
- Replace faulty components.



#### WARNING



#### Danger of injury from failure to follow the operating instructions and from performing unauthorized tasks on the machine.

- Define the responsibilities of the personnel taking the machine into service.
- Replace faulty machine parts immediately.
- Check the installation conditions when the machine is first taken into service and after the machine has been inactive for a lengthy period.

#### CAUTION

#### Danger of engine damage from low load operation.

Operating the engine at no load or at very low load for an extended period can impair the running characteristics of the engine.

- Make sure that the engine load is at least 15 %.
- Before switching off the engine following low load operation, briefly operate it at a considerably higher load.

#### CAUTION

#### Exceeding of the permissible forces at the speed control lever and stop pin can cause damage to the stops and inside regulator parts.

Please note the following figure.

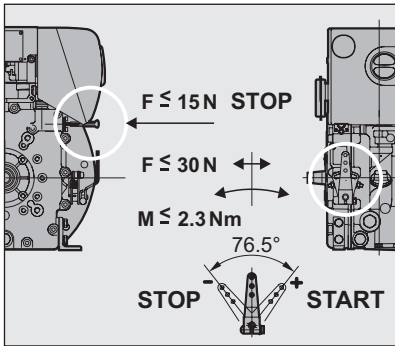
**Max. permissible forces on the speed control lever and stop pin****7.2 Performing tests****Before starting**

Before starting the engine, several tests need to be performed to ensure the machine is working properly.

**Procedure**

Step	Test
1	The machine is standing securely and on a level surface.
2	The installation location is adequately ventilated.
3	There is a sufficient amount of fuel in the fuel tank (see chapter 7.7 <i>Refueling</i> , page 51).
4	There is a sufficient amount of engine oil in the engine housing (see chapter 7.6 <i>Check the oil level</i> , page 48).
5	The starter rope of the recoil start does not exhibit abrasion (hand start).
6	Fill the oil bath air filter (option) with engine oil (see chapter 7.6.2 <i>Oil level in the oil bath filter (option)</i> , page 50).
7	No persons are located in the danger zone of the engine or machine.
8	All safety equipment is in place.

## 7.3 Setting the speed control

### Safety note

#### CAUTION

##### Damage to the diesel engine due to inadequate lubrication.

- After the engine has been out of use for an extended period (approx. 6 months or longer) or when the engine is first taken into service, operate the engine at a low set speed and without a load for approx. 20 seconds after starting. This ensures good lubrication of all bearing points before the speed and load are increased.

### Overview

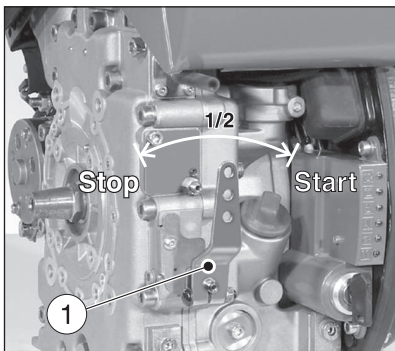

1	Speed control lever
---	---------------------

### Procedure

Step	Activity
1	First move the speed control lever (1) to the "Stop" position.
2	Depending on the situation, place the speed control lever in either the "1/2" or "Start" position.

#### NOTICE



A lower speed setting will cause less exhaust smoke when starting.







## 7.4 Starting the engine

### Starting options

A hand start mechanism is standard equipment for the engine. A starter can be installed as an option.

If possible, separate the engine from the machine being driven by uncoupling it. Always switch the machine into idle mode.

### Safety notes

 <b>DANGER</b>	
	<p><b>Danger to life from inhaling exhaust gases.</b></p> <p>Toxic engine exhaust gases can lead to loss of consciousness and even death in closed-off and poorly ventilated rooms.</p> <ul style="list-style-type: none"> <li>▪ Never operate the machine in closed-off or poorly ventilated rooms.</li> <li>▪ Do not breathe in the exhaust gases.</li> </ul>
 <b>WARNING</b>	
	<p><b>Danger of injury from faulty starter rope.</b></p> <p>A chafed starter rope can rip and cause injuries.</p> <ul style="list-style-type: none"> <li>▪ Before using the starter rope, check for abrasion; replace the rope if necessary.</li> </ul>
 <b>CAUTION</b>	
	<p><b>Danger of injury and danger of engine damage from the use of starting fluid.</b></p> <ul style="list-style-type: none"> <li>▪ Danger of injury during hand starting because the use of starting fluid can result in uncontrolled ignitions.</li> <li>▪ Engine damage from uncontrolled ignition.</li> <li>▪ Never use starting fluid.</li> </ul>

## 7.4.1 Starting the engine with recoil start (up to -6 °C)

### Overview

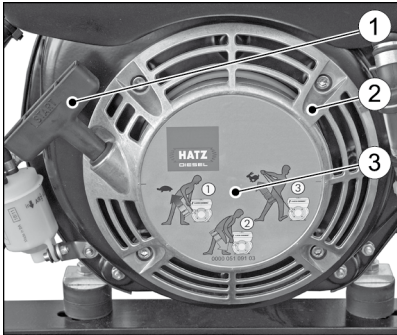

1	Grip
2	Recoil start cover
3	Diagram of starting procedure

### Procedure



Step	Activity
1	Check the speed adjustment (see chapter 7.3 <i>Setting the speed control</i> , page 37).
2	Slowly pull out the grip with the rope until you encounter slight resistance.
3	Let the rope run back in to be able to use the entire rope length for the starting procedure.
4	Hold the grip with both hands.
5	Pull the starting rope evenly and with increasing speed (do not tear at it jerkily) until the engine starts.

**NOTICE**



**When the exhaust emits white smoke after several failed start procedures:**

- Move the speed controller lever to the "Stop" position.
- Pull the starting rope all the way out five times.
- Reset the speed adjustment (see chapter 7.3 *Setting the speed control, page 37*).
- Repeat the start procedure.

**7.4.2 Starting the engine with a starter**

**Overview – HATZ instrument boxes**

**Standard (instrument box attached on the engine)**

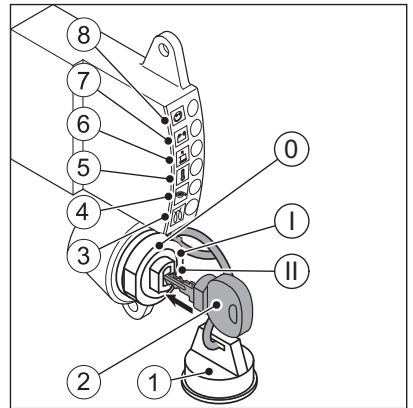
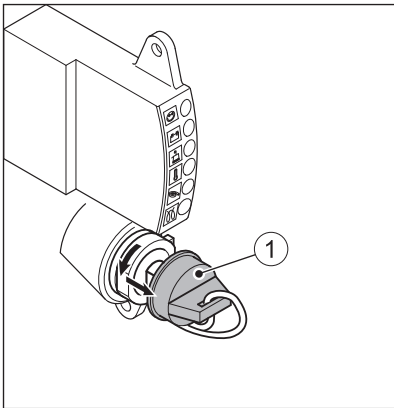

**Option (external instrument box)**

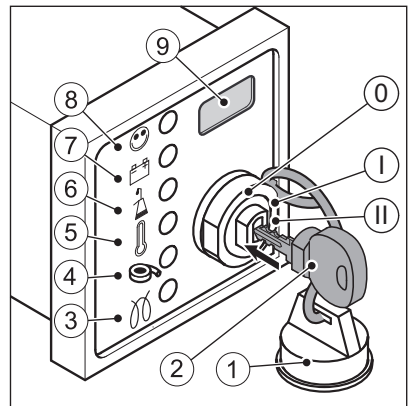
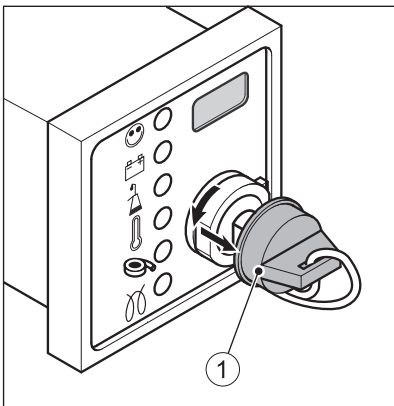







1	Protective cap
2	Starting key
3	Pre glow display (option)
4	Air filter maintenance indicator (not activated)
5	Engine temperature display (option)
6	Oil pressure display
7	Charge control
8	Operating display
9	Operating hours counter (option)
Ignition lock	
0	Off
I	Operation
II	Start

### Indicator lamps

When the starting key is turned to position "I" various indicator lamps flash or light up (depending on the equipment version). If there is a fault, the applicable indicator does not go out after the engine start or it lights up again during operation.

### Explanation of symbols

Symbol	Meaning
	<b>Operating indicator</b> Lights up during operation when there is no engine fault.
	<b>Charge control</b> Fault in the alternator or alternator charging circuit. The battery is no longer charged. Eliminate the fault immediately.
	<b>Oil pressure indicator</b> Engine oil pressure too low. Danger of engine damage. Stop the engine immediately and check the oil level (see section 7.6 <i>Check the oil level, page 48</i> ). Contact the HATZ service if the oil level is correct.
	<b>Engine temperature indicator</b> Engine temperature is impermissibly high. Danger of engine damage. Switch off the engine immediately! For details of troubleshooting, see section 9.1 <i>Troubleshooting, page 87</i> .

Symbol	Meaning
	<b>Pre glow indicator</b> Lights at temperatures below 0 °C. Start the engine when the indicator has gone out.

### Overview – Fuel shut-off valve (option)

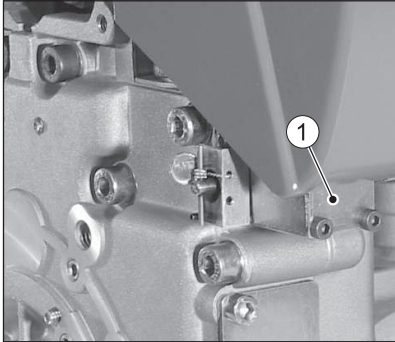

1	Fuel shut-off valve
---	---------------------

### Functional description

When the starting key is moved to **position I**, the fuel shut-off valve (1) is electrically unlocked. The fuel supply to the injection pump is enabled, the engine is ready to start. When the engine is running, turning the starting key to **position 0** locks the fuel shut-off valve and thereby blocks the fuel supply to the injection pump, the engine switches off.

This fuel shut-off valve is also used in association with the electrical automatic shutoff. When faults occur, the automatic shutoff switches off the engine. For troubleshooting details, see chapter *9.1 Troubleshooting, page 87*.

In special situations, an **emergency start** can also be attempted (see chapter *9.2 Emergency start, page 92*).

### Procedure – Starting the engine with a starter

#### NOTICE



- Start for max. 30 seconds. If the engine is still not running after that, turn the starting key back to position "0" and eliminate the cause (see chapter *9.1 Troubleshooting, page 87*).
- Turn the starting key to position "0" every time you want to start the engine.
- The anti repeat device in the ignition lock makes it impossible for the starter to engage while the engine is running and become damaged.

Step	Activity
1	Check the speed adjustment (see chapter 7.3 <i>Setting the speed control</i> , page 37).
2	Remove the protective cap (1) from the ignition lock.
3	Insert the starting key all the way and turn to position "I". When the pre glow display (3) lights up, wait until it goes out then continue with step 4.
4	Turn the starting key to position "II".
5	As soon as the engine is running, release the starting key. <ul style="list-style-type: none"> <li>▪ The starting key springs back to position "I" and remains in this position during operation.</li> <li>▪ The charge control (7) and oil pressure display (6) go out.</li> <li>▪ Operating display (8) lights up and signals there is no engine fault.</li> </ul>

### NOTICE



- In case of irregularities, switch off the engine immediately.
- Identify the fault and eliminate it.
- For details of troubleshooting, see chapter 9.1 *Troubleshooting*, page 87.

### Automatic electrical shutoff (option)

### NOTICE





- If the engine stops again immediately after starting, or stops independently during operation, this is an indication that a monitoring element of the automatic shutoff has activated.
- Remedy the fault before making further starting attempts (see chapter 9.1 *Troubleshooting*, page 87).
- The automatic shutoff is **no** protection against low oil level. This means that the oil level must be checked every 8 - 15 operating hours despite the automatic shutoff. (see section 7.6 *Check the oil level*, page 48).

### Procedure when faults occur

Step	Activity
1	Check the indicators (5-7). After the engine comes to a standstill, the fault will continue to be displayed by the indicator for approx. another 2 minutes.
2	Then the electrical equipment switches off automatically.

Step	Activity
3	Set the starting key to position "0".
4	Turn the starting key back to position "I". The fault display lights up again. Remedy the fault before making further starting attempts (see chapter 9.1 <i>Troubleshooting</i> , page 87). The indicator then goes out at the next start.

## 7.5 Switching off the engine

 <b>CAUTION</b>	
	<p><b>Danger of injury from unauthorized access.</b></p> <p>There is a danger of injury if unauthorized persons handle the machine.</p> <ul style="list-style-type: none"> <li>Protect the starting key against unauthorized access during breaks in operation or after completing work.</li> </ul>
<b>CAUTION</b>	
	<p><b>Protect the ignition lock against dirt and moisture.</b></p> <ul style="list-style-type: none"> <li>With the starting key pulled out, seal the ignition lock with the protective cap.</li> </ul>

### Methods of switching off the engine

The engine can be switched off in different ways depending on how it is equipped:

- Speed control lever (mechanical)
- Stop pin (mechanical)
- Starting key (electrical)

#### 7.5.1 Switching off the engine (mechanical)

<b>NOTICE</b>	
	Engines with a blocked lower idle speed cannot be switched off with the speed control lever. In this case, the engine is switched off with the stop pin or starting key, depending on how the engine is equipped.

## Overview

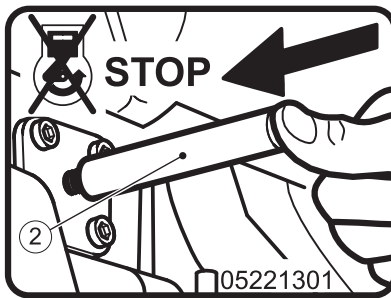
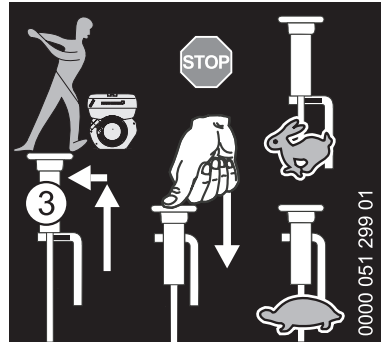
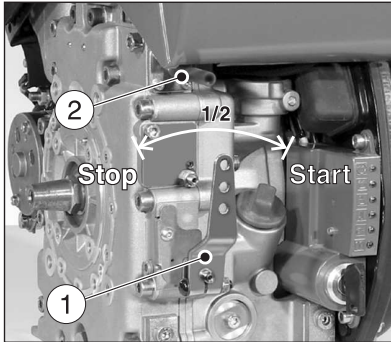

1	Speed control lever
2	Stop pin (additional equipment)
3	Connecting rod (additional equipment)

## Procedure

Step	Activity
<b>Speed control lever</b>	
1	Push the speed control lever (1) all the way to the "STOP" position. The engine switches off.
<b>Stop pin</b>	
1	Press and hold the stop pin (2) until the engine switches off.
2	Release the stop pin and ensure that it returns to its original position.
<b>Speed adjustment with connecting rod (additional equipment)</b>	
1	Move the speed adjustment with the connecting rod (3) to the "STOP" position and press it until the engine switches off.

**NOTICE**



After it is switched off, the engine continues running for a few seconds. Before performing any further activities, wait until all moving components have come to a complete standstill.

**7.5.2 Switching off the engine (electrical)**

**Overview — HATZ instrument boxes**

**Standard**

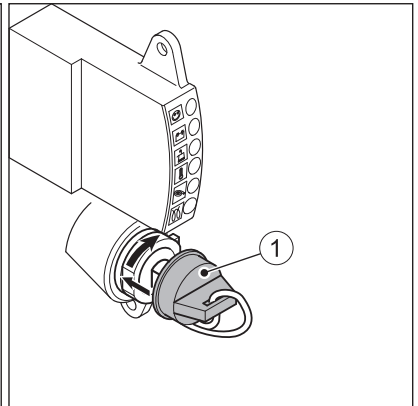
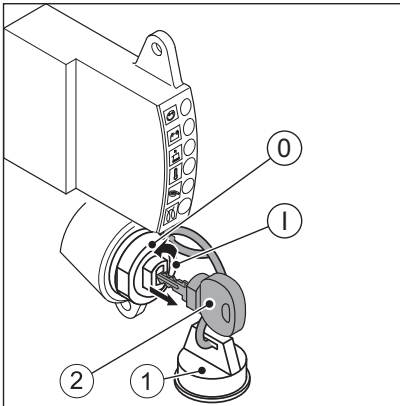

**Option**

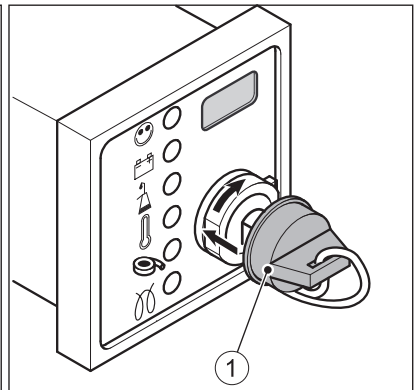
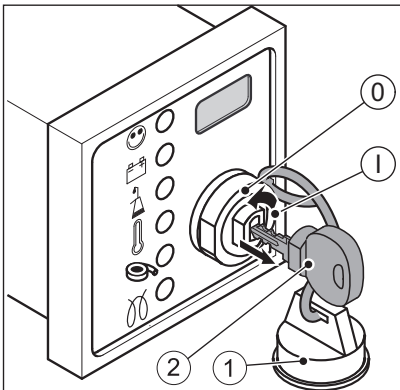

## Fuel shut-off valve

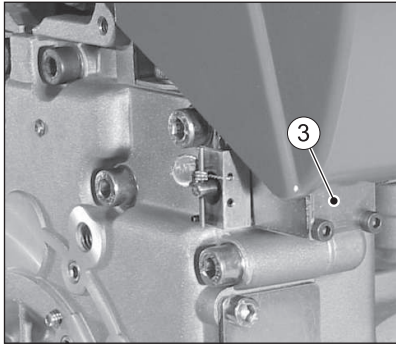

1	Protective cap
2	Starting key
3	Fuel shut-off valve
Ignition lock	
0	Off
I	Operation

### Procedure

Step	Activity
1	<p>Turn the starting key (2) to position "0".</p> <ul style="list-style-type: none"> <li>The fuel shut-off valve shuts off the fuel supply to the injection pump. The engine switches off.</li> <li>All indicator lamps go out.</li> </ul> <p><i>Note:</i> The engine continues running for several seconds after it is switched off. Before performing any further activities, wait until all moving components have come to a complete standstill.</p>
2	Remove the starting key.
3	Seal the ignition lock with the protective cap (1).

### NOTICE









#### Danger of exhaustive battery discharge.

- When the machine is switched off, always turn the starting key to position "0" or else the battery may become fully discharged.

## 7.6 Check the oil level

### Safety notes

 <b>CAUTION</b>	
 	<p><b>Danger of burns.</b></p> <p>There is a danger of burns when working on a hot engine.</p> <ul style="list-style-type: none"><li>▪ Wear safety gloves.</li></ul>
 <b>CAUTION</b>	
 	<p><b>Danger of injury</b></p> <p>Prolonged contact with engine oil can lead to irritation of the skin.</p> <ul style="list-style-type: none"><li>▪ Wear safety gloves.</li><li>▪ If there is contact with the skin, thoroughly wash the affected areas of the skin with soap and water.</li></ul>
<b>CAUTION</b>	
	<p><b>Danger of later engine damage.</b></p> <ul style="list-style-type: none"><li>▪ Operating the engine with an oil level below the <b>min.</b> mark or above the <b>max.</b> mark can lead to engine damage.</li><li>▪ When checking the oil level, the engine must be horizontal and have been switched off for a few minutes.</li></ul>



## 7.6.1 Engine oil level

### Overview

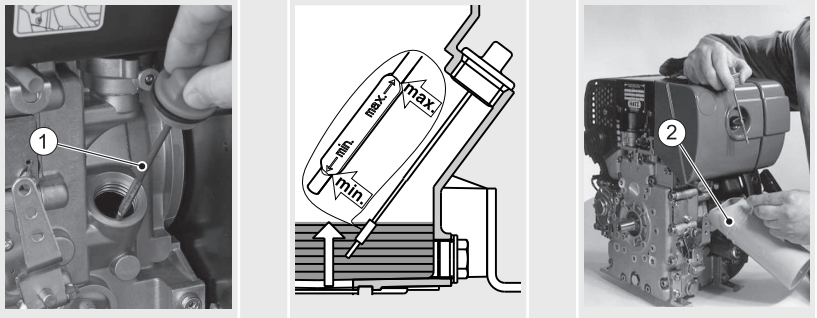

1	Dipstick
2	Oil refilling container

### Procedure

Step	Activity
1	Switch off the engine and wait several minutes for the engine oil to collect in the crankcase. Engine must be level.
2	Remove contamination on the engine in the area of the dipstick.
3	Unscrew the dipstick and clean it.
4	Reinsert the dipstick and screw it tight.
5	Unscrew the dipstick and check the oil level.
6	If the oil level is close to the min. mark, add engine oil to the max. mark.
7	Reinsert the dipstick and screw it tight.

## 7.6.2 Oil level in the oil bath filter (option)

### Overview

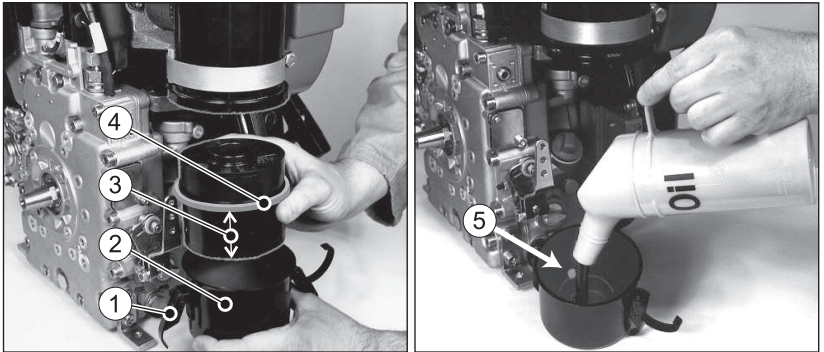









1	Clamp fastener (2x opposing)
2	Oil container
3	Filter insert
4	Gasket
5	Level mark

### Procedure

Step	Activity
1	Release the clamp fasteners (1).
2	Remove the oil container (2).
3	Take the filter insert (3) out of the oil container.
4	Check for dirt. When the deposited dirt has reached approximately half the height of the oil filling or the oil has become viscous, clean the oil bath air filter (see chapter 8.2.7 <i>Maintaining the oil bath filter</i> , page 70).
4	Otherwise check the oil level and fill with engine oil up to the level mark (5) as required.
5	Mount the oil container, ensuring that the gasket (4) is properly positioned and the clamp fasteners (1) are correctly fastened.

## 7.7 Refueling

### Safety notes

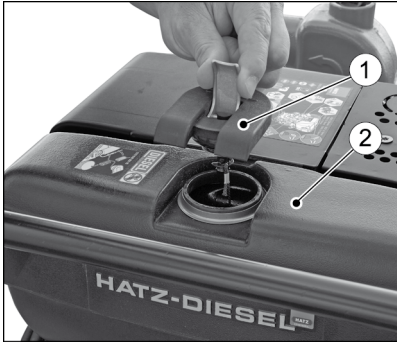

 <b>DANGER</b>	
 	<p><b>Fire hazard from fuel.</b></p> <p>Leaked or spilled fuel can ignite on hot engine parts and cause serious burn injuries.</p> <ul style="list-style-type: none"> <li>▪ Only refuel when the engine is switched off and has cooled down.</li> <li>▪ Never refuel in the vicinity of open flames or sparks that can cause ignition.</li> <li>▪ Do not smoke.</li> <li>▪ Do not spill fuel.</li> </ul>
 <b>CAUTION</b>	
	<p><b>Danger of environmental damage from spilled fuel.</b></p> <p>Do not overfill the fuel tank and do not spill fuel.</p> <ul style="list-style-type: none"> <li>▪ Collect any leaking fuel and dispose of it according to local environmental regulations.</li> </ul>
 <b>CAUTION</b>	
 	<p><b>Danger of injury.</b></p> <p>Repeated contact with diesel fuel can cause chapped and cracked skin.</p> <ul style="list-style-type: none"> <li>▪ Wear safety gloves.</li> <li>▪ If there is contact with the skin, thoroughly wash the affected areas of the skin with soap and water.</li> </ul>
<b>CAUTION</b>	
	<p><b>Engine damage from using low quality fuel.</b></p> <p>The use of fuel that does not meet the specifications can lead to engine damage.</p> <ul style="list-style-type: none"> <li>▪ Only use the fuel specified in chapter 4.5 <i>Fuel</i>, page 26.</li> <li>▪ The use of fuel that does not meet specifications requires approval by Motorenfabrik HATZ (main plant).</li> </ul>

**Overview**



1	Fuel cap
2	Fuel tank

**Procedure**

Step	Activity	Figure
1	Open the fuel cap.	
2	Fill the fuel tank with diesel fuel.	

Step	Activity	Figure
3	Close the fuel cap.	

### NOTICE



- Before starting for the first time or if the fuel system is empty, fill the fuel tank fully with diesel fuel. This causes the fuel system to be bled automatically.
- Automatic bleeding is completed after a waiting period of 1-2 minutes. The engine is ready to start.

## 7.8 Checking the water separator

### Safety notes



### CAUTION



#### Danger of environmental damage from spilled fuel.

When water is drained from the water separator, a small amount of fuel is drained as well.

- Collect any escaped water/fuel mixture and dispose of it according to local environmental regulations.

### NOTICE



The interval for checking the water separator depends entirely on the proportion of water in the fuel and on the care exercised during refueling; the water separator should be checked at least once a week.

## Overview

Water in the fuel tank collects at the lowest point of the fuel tank in the water separator.

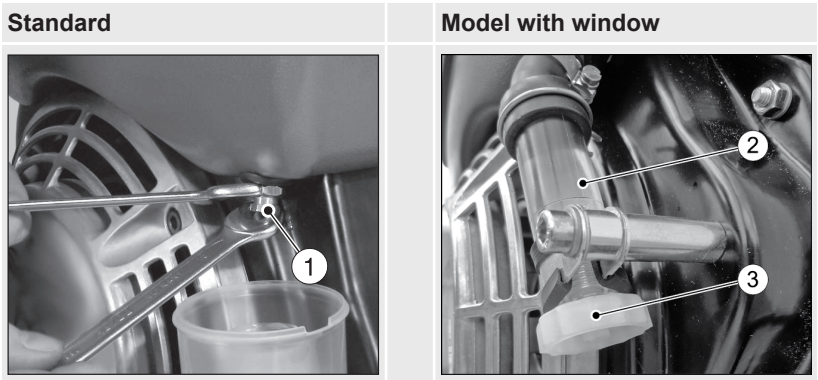

1	Drain screw, hex (standard)
2	Window (additional equipment)
3	Drain screw (manually operated)

## Procedure

Step	Activity
1	Model with window: Check the window (2) for water content. Collected water can be clearly identified by the noticeable separating line between the water and the diesel fuel above it.
2	Place a suitable container under the drain screw (1) or (3). <i>NOTE:</i> In inaccessible locations, an extension hose can be mounted on the drain screw (3).
3	Open the drain screw (1) or (3) and drain the water into the container.
4	When fuel emerges, close the drain screw.
5	Dispose of the water/fuel mixture in accordance with the local environmental regulations.

## 7.9 Check the air filter warning indicator (option)

### Overview

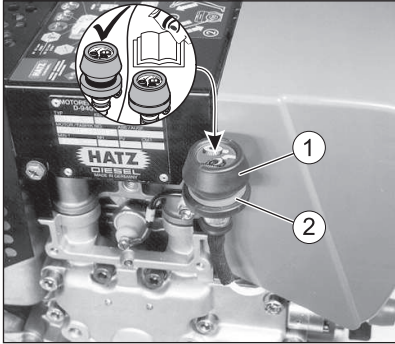

1	Rubber bellow
2	Green field



### Procedure

Step	Activity
1	Bring the engine briefly to maximum speed.
2	When the rubber bellow (1) contracts and covers over the green field (2), immediately check the air filter system (see chapter 8.2.12 <i>Maintaining the dry air filter</i> , page 84).
3	Check the rubber bellow (1) several times daily under dusty conditions.

## 8 Maintenance

### 8.1 General maintenance instructions

#### Safety notes

 <b>WARNING</b>	
	<p><b>Danger of injury from failure to follow the operating instructions and from performing unauthorized tasks on the machine.</b></p> <ul style="list-style-type: none"> <li>▪ Follow all instructions.</li> <li>▪ Do not perform activities for which no qualification is available. Contact properly trained personnel if necessary.</li> </ul>

<b>NOTICE</b>	
	<p><b>Comply with the safety chapter!</b></p> <p>Follow the basic safety instructions in chapter 3 <i>Safety</i>, page 7.</p>

- Maintenance tasks may only be performed by trained personnel.
- Accident prevention measures must be in accordance with the local accident prevention regulations.
- Perform setting and maintenance work at the specified intervals.
- Replace faulty machine parts as soon as possible.
- Always wear personal protection equipment.
- Only use fully functional tools.
- Installation of unsuitable spare parts can lead to problems. We cannot accept responsibility for direct damage or secondary damage that results from this. We therefore recommend the use of **Hatz original spare parts**.
- Closely adhere to the maintenance conditions prescribed in this manual.
- Only make changes to the machine in agreement with the manufacturer.
- Only perform maintenance work when the engine is stopped.
- Protect start-up devices (crank handle, recoil start or starting key) from unauthorized access.
- For engines with an electric starter: Disconnect the negative battery terminal before carrying out maintenance work.
- Adhere to legal regulations when handling and disposing of used oil, filters, and cleaning agents.
- After completing maintenance work, check that all tools, bolts, aids, and other objects are removed from the machine, and that all safety equipment has been replaced.



- Before starting, ensure that no persons are located in the danger zone of the engine or machine.



### Performance of maintenance work

The entire machine is designed to be maintenance friendly. Parts that require maintenance are easily accessible.

- Perform maintenance work faithfully at the specified intervals to prevent premature wear of the machine.
- Follow the notice and warning labels on the machine.
- Always retighten screw connections loosened during maintenance work.
- After the necessary maintenance and repair work is completed, perform a function test (test run).
- For maintenance work that is not listed and described in the maintenance documentation, please contact your nearest **HATZ service station**.

## 8.2 Maintenance work

### Safety note

 <b>CAUTION</b>	
	<p><b>Danger of injury if maintenance instructions are not followed.</b></p> <ul style="list-style-type: none"> <li>▪ Only perform maintenance when the engine is switched off.</li> <li>▪ Protect start-up devices (crank handle, recoil start or starting key) from unauthorized access.</li> <li>▪ For engines with a starter: Disconnect the negative battery terminal.</li> <li>▪ When the maintenance work has been completed, ensure that all tools are removed from the machine.</li> </ul>

### 8.2.1 Maintenance notice label

<b>NOTICE</b>	
	<p>The illustrated maintenance label is delivered with every engine.</p> <ul style="list-style-type: none"> <li>▪ It should be mounted on the engine or machine in a clearly visible location.</li> <li>▪ The maintenance intervals specified on the maintenance plan must be adhered to (see chapter 8.2.2 <i>Maintenance plan, page 58</i>)</li> </ul>

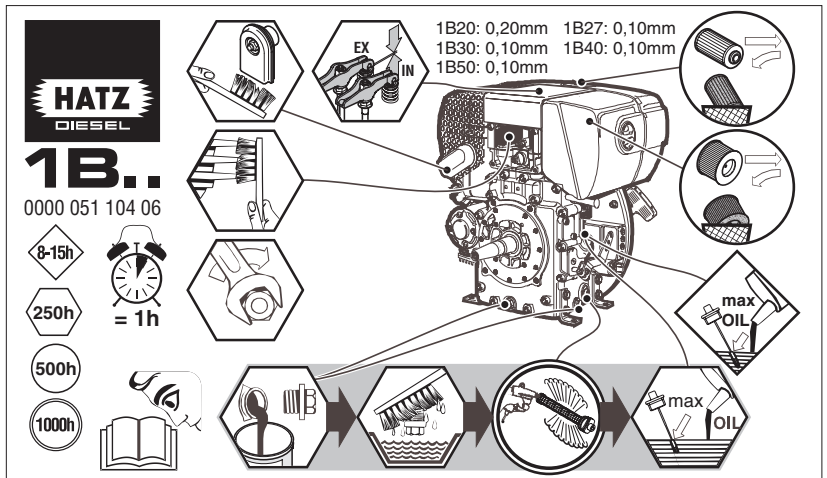





### 8.2.2 Maintenance plan

In new and generally overhauled engines, after **25 operating hours**:

- Change the engine oil
- Check the tappet clearance and adjust if necessary
- Check the screw connections (do not retighten the screws for attaching the cylinder head)





In case of a low number of operating hours, change the engine oil no later than every 12 months, regardless of the actual number of operating hours.

The interval at which maintenance work should be performed on the fuel filter depends on the cleanliness of the fuel in use and may need to be shortened to 250 operating hours.

Symbol	Maintenance interval	Maintenance step/check	Chapter
	Every 8–15 operating hours or every day before starting	Check the oil level.	7.6 <i>Check the oil level, page 48</i>
		Check the engine oil level in the bottom section of the oil bath air filter and examine the oil for contamination. Change the oil if it is sludgy.	7.6.2 <i>Oil level in the oil bath filter (option), page 50</i>
		In models with a cyclone pre-cleaner, remove the dust trap.	8.2.7 <i>Maintaining the oil bath filter, page 70</i>
		Check the intake area of the combustion and cooling air.	8.2.3 <i>Checking the intake area, page 60</i>
		Check the air filter maintenance indicator.	7.9 <i>Check the air filter warning indicator (option), page 55</i>
	Weekly	Check the water separator.	7.8 <i>Checking the water separator, page 53</i>
	Every 250 operating hours	Maintain the oil bath air filter.	8.2.7 <i>Maintaining the oil bath filter, page 70</i>
		Change the engine oil.	8.2.4 <i>Change the engine oil, page 61</i>
		Check and set the tappet clearance.	8.2.6 <i>Check and set the tappet clearance, page 66</i>
		Clean the cooling air area.	8.2.8 <i>Clean the cooling air area, page 71</i>
		Check the screw connections.	8.2.9 <i>Check the screw connections, page 74</i>
		Clean the exhaust screen.	8.2.10 <i>Clean the exhaust screen, page 75</i>
	Every 500 operating hours	Change the fuel filter.	8.2.11 <i>Changing the fuel filter, page 79</i>
		Maintain the dry air filter.	8.2.12 <i>Maintaining the dry air filter, page 84</i>
	Every 1000 operating hours	Clean the oil filter.	8.2.5 <i>Clean the oil filter, page 64</i>

## 8.2.3 Checking the intake area

### Safety notes

 <b>CAUTION</b>	
 	<p><b>Danger of burns.</b></p> <p>There is a danger of burns when working on a hot engine.</p> <ul style="list-style-type: none"> <li>▪ Let the engine cool.</li> <li>▪ Wear safety gloves.</li> </ul>
<b>NOTICE</b>	
	<p>In case of heavy contamination, shorten the maintenance intervals accordingly (see chapter 8.2.2 <i>Maintenance plan, page 58</i>).</p>

### Overview

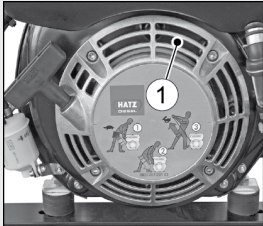
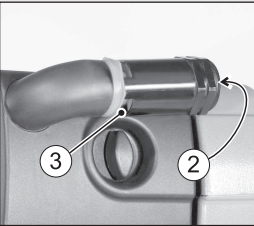
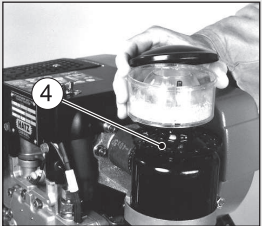
Standard	Model with cyclone precleaner	Model with oil bath filter
		
1	Air intake opening	
2	Intake area of cyclone precleaner	
3	Dust outlet opening	
4	Intake area of oil bath filter	

### Procedure

Step	Activity
1	Check the air intake opening (1) for coarse contamination such as leaves, heavy dust deposits, etc., and clean if necessary.









Step	Activity
2	In models with a <b>cyclone precleaner</b> , also check and if necessary clean the intake area (2) in addition to step 1. Check that the dust outlet opening (3) is clear and clean it if necessary.
3	In models with an <b>oil bath filter</b> , also check and if necessary clean the intake area (4) in addition to step 1.

### 8.2.4 Change the engine oil

This section contains the following subsections:

- **Draining the engine oil**
- **Filling the engine oil**

#### Safety notes

 <b>CAUTION</b>	
 	<p><b>Danger of burns.</b></p> <p>When working on the engine there is a danger of burns from hot oil.</p> <ul style="list-style-type: none"> <li>▪ Wear personal protective equipment (gloves).</li> </ul>
 <b>CAUTION</b>	
	<p><b>Danger of environmental damage from spilled used oil.</b></p> <p>Used oil is water-polluting.</p> <ul style="list-style-type: none"> <li>▪ Do not allow it to enter the ground water, water bodies, or sewage system.</li> <li>▪ Collect the used oil and dispose of it according to local environmental regulations.</li> </ul>
 <b>CAUTION</b>	
 	<p><b>Danger of injury</b></p> <p>Prolonged contact with engine oil can lead to irritation of the skin.</p> <ul style="list-style-type: none"> <li>▪ Wear safety gloves.</li> <li>▪ If there is contact with the skin, thoroughly wash the affected areas of the skin with soap and water.</li> </ul>

**CAUTION****Danger of later engine damage.**

- Operating the engine with an oil level below the **min.** mark or above the **max.** mark can lead to engine damage.
- When checking the oil level, the engine must be horizontal and have been switched off for a few minutes.

**NOTICE**

- The engine must be level.
- The engine must be switched off.
- Only drain engine oil while it is warm.

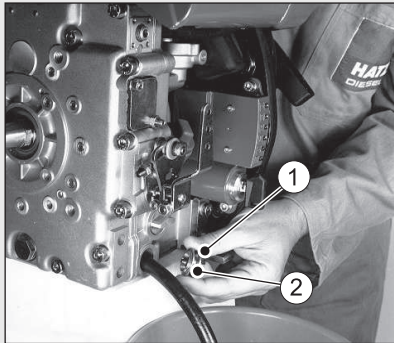
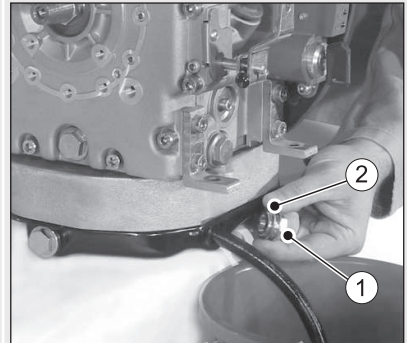
**Draining the engine oil****Overview****Without oil sump****With oil sump**

1	Oil drain screw
2	Seal ring

**Procedure**

Step	Activity
1	Keep a container ready for collecting the used oil. The container must be large enough to hold the entire amount of engine oil.
2	Unscrew the oil drain screw (1) and drain the oil entirely.
3	Clean the oil filter when required (every 1000 hours of operation), see chapter 8.2.5 <i>Clean the oil filter</i> , page 64.

Step	Activity
4	Screw in the cleaned oil drain screw (1) with the new gasket (2) and tighten. Tightening torque: 50 Nm.

## Filling the engine oil

### Overview

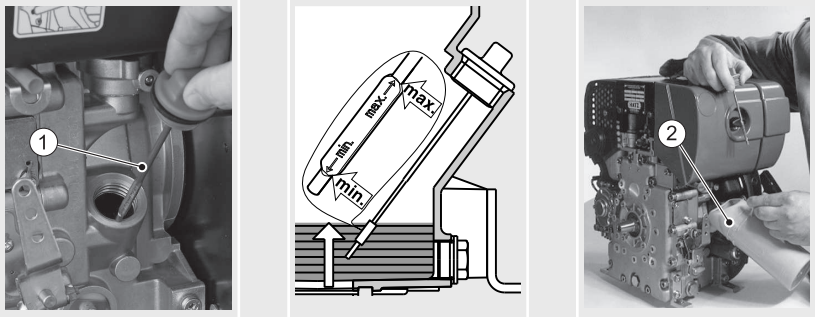











1	Dipstick
2	Oil refilling container

### Procedure

Step	Activity
1	Unscrew the dipstick (1) and clean it.
2	Fill engine oil. For the specification and viscosity, see chapter 4.4 <i>Engine oil</i> , page 25. See chapter 4.1 <i>Engine information and filling quantities</i> , page 22 for the engine oil capacity.
3	Reinsert the dipstick and screw it tight.
4	Unscrew the dipstick and check the oil level.
5	If required, top up engine oil to the max. mark.
6	Reinsert the dipstick and screw it tight.



## 8.2.5 Clean the oil filter

### Safety notes

 <b>CAUTION</b>	
	<p><b>Danger of burns.</b></p> <p>There is a danger of burns when working on a hot engine.</p> <ul style="list-style-type: none"> <li>▪ Let the engine cool before maintenance.</li> </ul>
 <b>CAUTION</b>	
 	<p><b>Danger of injury</b></p> <p>Prolonged contact with engine oil can lead to irritation of the skin.</p> <ul style="list-style-type: none"> <li>▪ Wear safety gloves.</li> <li>▪ If there is contact with the skin, thoroughly wash the affected areas of the skin with soap and water.</li> </ul>
 <b>CAUTION</b>	
 	<p><b>Danger of injury.</b></p> <p>When working with compressed air, foreign bodies may fly into your eyes.</p> <ul style="list-style-type: none"> <li>▪ Wear safety goggles.</li> <li>▪ Never direct the compressed air jet toward people or toward yourself.</li> </ul>
<b>NOTICE</b>	
	<ul style="list-style-type: none"> <li>▪ Collect the emerging oil and dispose of it according to local environmental regulations.</li> </ul>
<b>NOTICE</b>	
	<ul style="list-style-type: none"> <li>▪ The oil filter should be cleaned when the engine oil is changed (see chapter 8.2.4 <i>Change the engine oil, page 61</i>), since oil will run out when the filter is pulled out.</li> </ul>

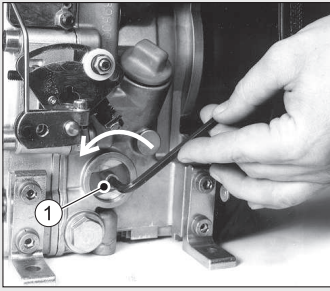
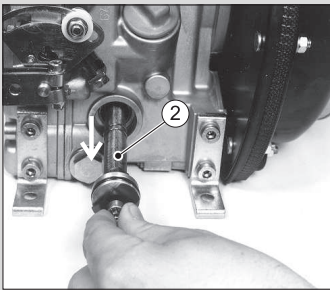

## Procedure

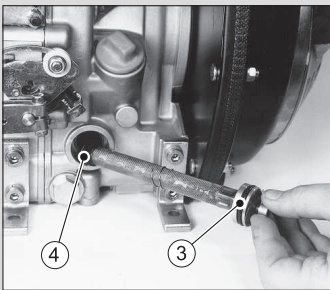
Step	Activity	Figure
1	Loosen the screw (1) by approx. five turns.	
2	Pull the oil filter (2) out of the housing.	
3	Blow out the oil filter from the inside to the outside with compressed air.	
4	Check the gaskets (3+4) for damage and renew if necessary.	
5	Lightly oil the gaskets before mounting.	

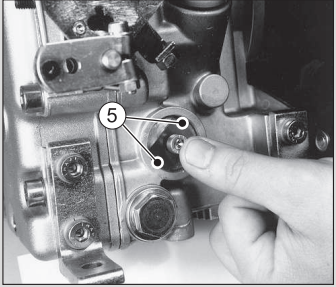
Step	Activity	Figure
6	Insert the oil filter and press it all the way in.	
7	Before tightening the screw, ensure that the tension springs (5) rest against the oil filter at both ends. Tighten the screw.	
8	Check the oil level and add oil to the max. mark if necessary (see chapter 7.6 <i>Check the oil level, page 48</i> ).	

## 8.2.6 Check and set the tappet clearance

### Safety notes



#### CAUTION



#### Danger of burns.

There is a danger of burns when working on a hot engine. Only perform the settings while the engine is cold (10-30°C).

- Let the engine cool.



#### CAUTION



#### Damage from inadequate engine cooling.

Only operate the engine when all covers are installed.

### Preparations

The preparations are performed in different ways depending on how the engine is equipped:

- Preparations on engine model with dry air filter
- Preparations on engine model with oil bath air filter
- Preparations on engine model for rammer operation (1B20 R)

**Preparation - Engine model with dry air filter**

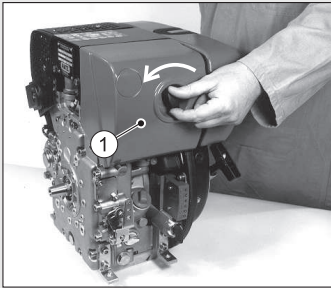
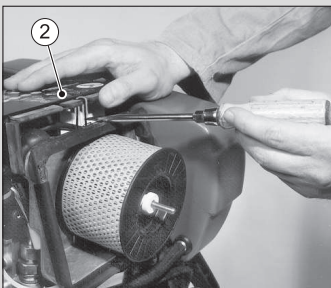
Step	Activity	Figure
1	Unscrew the air filter cover (1).	
2	Remove the sound protection hood (2).	

**Preparation - Engine model with oil bath filter**

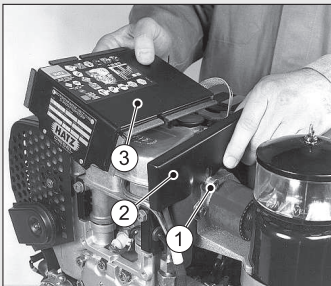
Step	Activity	Figure
1	Release the screw (1).	
2	Take off the cover plate (2) with the sound protection hood (3).	

### Preparations - Engine model with rammer operation (1B20 R)

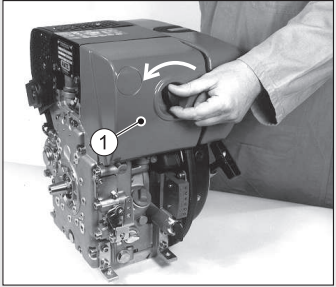
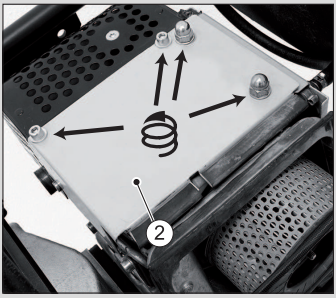
Step	Activity	Figure
1	Unscrew the air filter cap (1).	
2	Remove the screws and nuts. Remove the sound protection hood (2).	

### Procedure

#### NOTICE





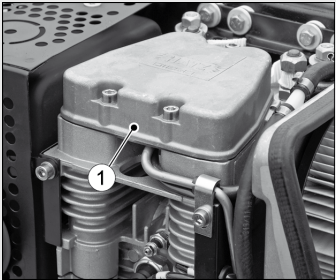

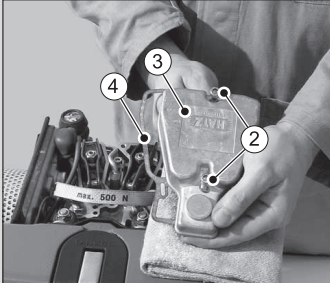
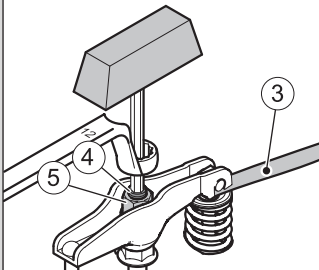



The steps described here can only be performed after the appropriate preparations have been completed.

Step	Activity	Figure
1	Remove dirt in the area of the cylinder head cover (1).	

Step	Activity	Figure
2	Remove the screws (2). (2 screws in 1B20 and 1B30, 3 screws in 1B40 and 1B50).	
3	Take off the cover (3) with the gasket (4).	
4	Turn the engine in the sense of rotation until the rocker arm (1) has fully opened the outlet valve. Then check the tappet clearance at the rocker arm (2) with a feeler gauge (3). For the setting, see chapter 4.1 <i>Engine information and filling quantities</i> , page 22.	
5	Turn the engine in the sense of rotation until the rocker arm (2) has fully opened the intake valve. Now check the tappet clearance at the rocker arm (1).	
6	If the tappet clearance needs to be corrected:  Release the screw (4) and turn the hex nut (5) so the feeler gauge (3) can be pulled through with a barely perceptible resistance after the screw (4) is tightened again.	
7	Mount the cylinder head cover with the new gasket and tighten evenly.	
8	Fully assemble the engine.	
9	Perform a test run. Check the cylinder head cover for tightness.	

## 8.2.7 Maintaining the oil bath filter

### Safety notes

 <b>CAUTION</b>	
	<p><b>Danger of burns.</b></p> <p>There is a danger of burns when working on a hot engine.</p> <ul style="list-style-type: none"> <li>▪ Let the engine cool before maintenance.</li> </ul>
 <b>CAUTION</b>	
 	<p><b>Danger of injury</b></p> <p>Prolonged contact with engine oil can lead to irritation of the skin.</p> <ul style="list-style-type: none"> <li>▪ Wear safety gloves.</li> <li>▪ If there is contact with the skin, thoroughly wash the affected areas of the skin with soap and water.</li> </ul>
 <b>CAUTION</b>	
 	<p><b>Danger of injury.</b></p> <p>Repeated contact with diesel fuel can cause chapped and cracked skin.</p> <ul style="list-style-type: none"> <li>▪ Wear safety gloves.</li> <li>▪ If there is contact with the skin, thoroughly wash the affected areas of the skin with soap and water.</li> </ul>
<b>CAUTION</b>	
	<ul style="list-style-type: none"> <li>▪ Do not repair the oil bath filter (weld/solder, etc.) as this may lead to destruction of the filter or damage to the engine.</li> <li>▪ For model with cyclone precleaner: Never add oil to the dust trap.</li> </ul>

### Procedures

The procedure differs depending on how the engine is equipped:

- Procedure – Cleaning the cyclone precleaner
- Procedure – Cleaning the oil bath air filter

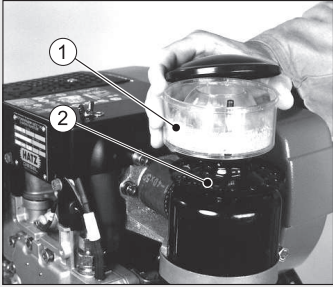

**Procedure – Cleaning the cyclone precleaner**

Step	Activity	Figure
1	Take off the dust collection container (1), empty it and clean it without using liquids.	
2	Also clean the intake opening (2) without liquids.	
3	Fully assemble the cyclone precleaner and tighten with the wing nut.	

**Procedure – Cleaning the oil bath air filter**

Step	Activity	Figure
1	Remove the oil container (1).	
2	Remove the dirty oil and sludge and clean the container.	
3	Rinse the filter insert (2) in diesel fuel. Before assembling the filter, drip or wipe dry.	
4	Clean the filter housing (3) if it is very dirty.	
5	Fully assembly the filter and prepare it for operation by filling it with oil (see chapter 7.6.2 <i>Oil level in the oil bath filter (option), page 50</i> ).	

**8.2.8 Clean the cooling air area****Safety notes**

 <b>CAUTION</b>	
	<p><b>Danger of burns.</b></p> <p>There is a danger of burns when working on a hot engine.</p> <ul style="list-style-type: none"> <li>▪ Let the engine cool before maintenance.</li> </ul>

**CAUTION****Danger of injury.**

When working with compressed air, foreign bodies may fly into your eyes.



- Wear safety goggles.
- Never direct the compressed air jet toward people or toward yourself.



**CAUTION****Danger of damage to the machine from incorrect engine cleaning.**

- Let the engine fully cool down before cleaning.
- Do not spray components of the electrical equipment with a water jet or high pressure jet during cleaning.

**Procedure**

Step	Activity	Figure
<b>Dry contamination</b>		
1	Remove the screws (1).	
2	Take off the recoil start (2) and clean it.	

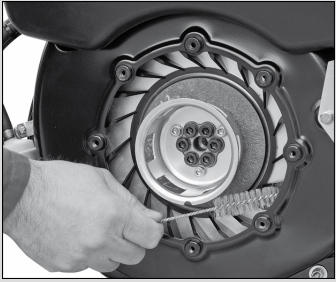
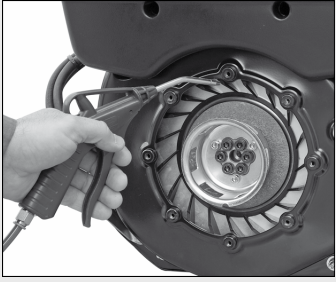
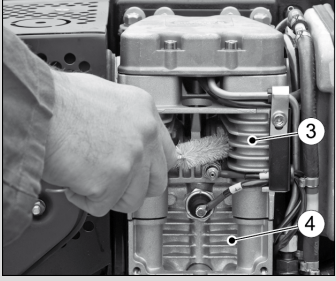

Step	Activity	Figure
3	Clean the fan blades with a suitable brush.	
4	Then blow it out with compressed air.	
5	Also clean the cooling ribs of the cylinder head (3) and cylinder (4) and blow out with compressed air.	
6	<p>Check the air gap (5) for dirt and clean with compressed air if necessary.</p> <p>Note: In 1B20 the air gap (5) is markedly smaller than the gap shown in the figure (size approx. 5 mm).</p>	

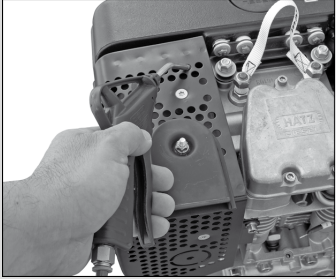
Step	Activity	Figure
7	The element can be checked and cleaned through the holes in the contact guard.	
8	Mount the recoil start (2) again.	
<b>Moist or oily contamination</b>		
1	Contact HATZ service.	

### 8.2.9 Check the screw connections

#### NOTICE





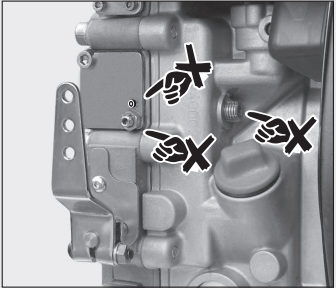

- Do not retighten the screws for attaching the cylinder head.
- The adjustment screws on the speed governor and the injection system are secured with locking varnish and are not permitted to be tightened or adjusted.
- Only retighten loose screw connections. Screw connections can be secured with thread locking adhesive or tightened to a defined torque. Retightening tight screw connections can cause damage.

#### Procedure

Step	Activity	Figure
1	Check the condition of all screw connections and ensure that they are tight (for exceptions, see note and picture on the right).	
2	Tighten any loose screw connections.	

## 8.2.10 Clean the exhaust screen

### Safety notes

 <b>CAUTION</b>	
	<p><b>Danger of burns.</b></p> <p>There is a danger of burns when working on a hot engine.</p> <ul style="list-style-type: none"> <li>▪ Let the engine cool before maintenance.</li> </ul>
 <b>CAUTION</b>	
 	<p><b>Danger of injury</b></p> <p>There is a danger of injury when performing cleaning work at the exhaust screen.</p> <ul style="list-style-type: none"> <li>▪ Wear safety gloves.</li> </ul>

### Procedures

The exhaust screen can be cleaned in different ways depending on how the engine is equipped:

- Cleaning the exhaust screen in standard models
- Cleaning the exhaust screen in models for rammer operation (1B20 R)

### Cleaning the exhaust screen in standard models

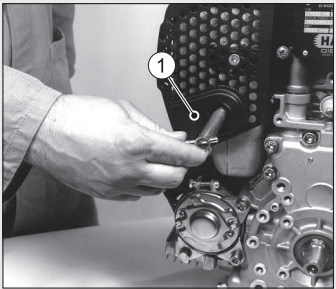
Step	Activity	Figure
1	Release the hex nut and take off the exhaust manifold (1).	

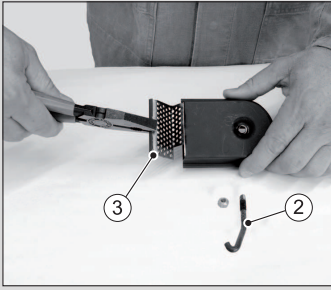
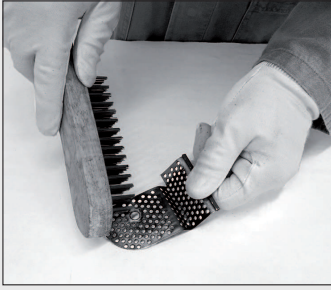
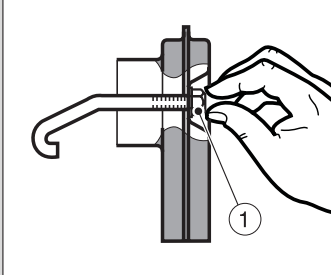
Step	Activity	Figure
2	Remove the hex nut from the bracket (2) and pull out the screen insert (3).	
3	Remove the deposits in the screen insert with a suitable wire brush.	
4	Check the screen insert for cracks or breakage, and replace if necessary.	
5	Mount the screen insert and bracket again.	
6	Tighten the hex nut (1) by approx. one turn.	

Step	Activity	Figure
7	Insert the exhaust manifold with the bracket (2) into the hole and pull it back to the outside so that the bracket can no longer become unhooked.	
8	Tighten the hex nut.	

### Clean the exhaust screen in models for rammer operation (1B20 R)

Step	Activity	Figure
1	Release the hex nut and take off the exhaust manifold (1).	
2	Remove the hex nut from the bracket (2) and pull out the screen insert (3).	
3	Remove the deposits in the screen insert with a suitable wire brush.	

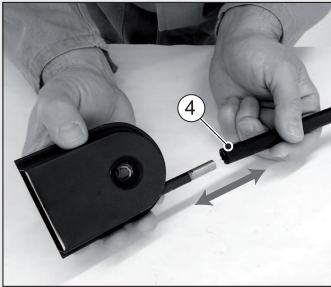
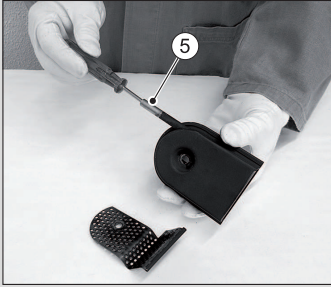
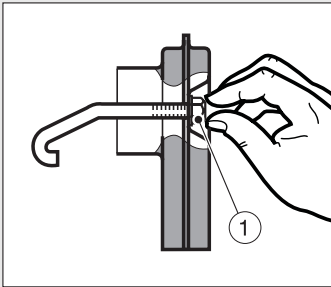
Step	Activity	Figure
4	Check the screen insert for cracks or breakage, and replace if necessary.	
5	Pull the hose (4) off of the exhaust manifold.	
6	Check that the pipe connection (5) is clear. Remove deposits using a screwdriver or similar instrument.	
7	Attach the hose again.	
8	Mount the screen insert and bracket again.	
9	Tighten the hex nut (1) by approx. one turn.	

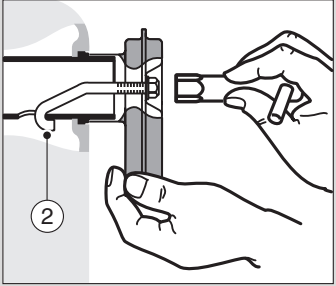
Step	Activity	Figure
10	Insert the exhaust manifold with the bracket (2) into the hole and pull it back to the outside so that the bracket can no longer become unhooked.	
11	Tighten the hex nut.	

### 8.2.11 Changing the fuel filter

#### Safety notes

 <b>DANGER</b>	
	<p><b>Fire hazard from fuel</b></p> <p>Leaked or spilled fuel can ignite on hot engine parts and cause serious burn injuries.</p> <ul style="list-style-type: none"> <li>▪ Do not spill fuel.</li> <li>▪ No open flames when working on the fuel system.</li> <li>▪ Do not smoke.</li> </ul>
	
 <b>CAUTION</b>	
	<p><b>Danger of injury.</b></p> <p>Repeated contact with diesel fuel can cause chapped and cracked skin.</p> <ul style="list-style-type: none"> <li>▪ Wear safety gloves.</li> <li>▪ If there is contact with the skin, thoroughly wash the affected areas of the skin with soap and water.</li> </ul>
	
 <b>CAUTION</b>	
	<p><b>Danger of environmental damage from spilled fuel.</b></p> <p>When the filter is removed, a small amount of fuel is drained as well.</p> <ul style="list-style-type: none"> <li>▪ Collect any escaping fuel and dispose of it according to local environmental regulations.</li> </ul>

**CAUTION****Dirt particles can damage the injection system.**

- Maintain clean conditions to ensure dirt does not enter the fuel line.

**Procedures**

The fuel filter can be changed in different ways depending on how the engine is equipped:

- Model with fuel filter in tank
- Model with double fuel filter system
- Model with external fuel filter

**Model with fuel filter in tank**

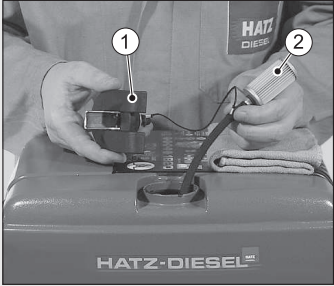
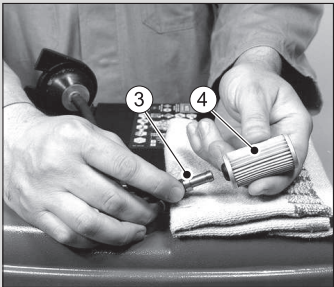
Step	Activity	Figure
1	Open the fuel cap (1) and pull the fuel filter (2) out of the tank by the cord.	
2	Pull the fuel feed line (3) off of the fuel filter (4) and insert a new filter.	
3	Insert the fuel filter back into the tank.	
4	Close the fuel cap. The fuel system is bled automatically.	



### Model with double fuel filter system

#### NOTICE



- The advantage of this system is that dirt particles that may enter the fuel line during a filter change are captured by the downstream outside filter and are therefore unable to endanger the injection system.
- **This outside filter is NOT permitted to be changed. Only change the fuel filter in the tank.**

Step	Activity	Figure
1	Do <b>not</b> change the maintenance-free outside filter (1).	
2	Open the fuel cap (2) and pull the fuel filter (3) out of the tank by the cord.	
3	Pull the fuel feed line (4) off of the fuel filter (5) and insert a new filter.	
4	Insert the fuel filter back into the tank.	

Step	Activity	Figure
5	Close the fuel cap. The fuel system is bled automatically.	

### Model with external fuel filter

#### NOTICE



In the model with an external fuel filter, there is no fuel filter in the tank.

Step	Activity	Figure
1a	<b>Water separator without window:</b> Empty the fuel tank (1). Open the screw (2) and let the fuel drain into a clean container. The fuel can be used again later.	
1b	<b>Water separator with window:</b> Empty the fuel tank (1). Open the screw (2) and let the fuel drain into a clean container. The fuel can be used again later.	
2	Unscrew the fuel filter (3) from the holder.	

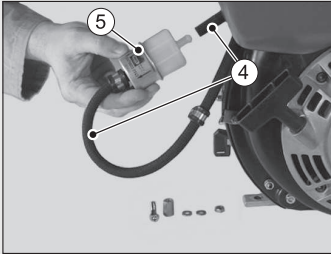
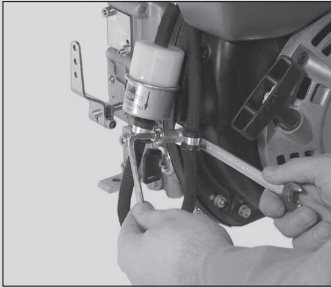
Step	Activity	Figure
3	Place a suitable container under the fuel filter to collect the remaining fuel.	
4	<p>Pull the fuel line (4) off of the fuel filter (5) on both sides and insert a new filter.</p> <p>Observe the flow-through direction (arrows).</p>	
5	Attach the fuel filter to the holder.	
6	<p>Fill the fuel tank with diesel fuel (see chapter 7.7 <i>Refueling</i>, page 51).</p> <p>The fuel system is bled automatically.</p>	
7	Check the fuel filter and lines for tightness after a brief trial run.	

## 8.2.12 Maintaining the dry air filter

### NOTICE



- Immediately clean the filter cartridge if the maintenance display appears at maximum speed.
- Always renew the filter cartridge after a use period of 500 operating hours.



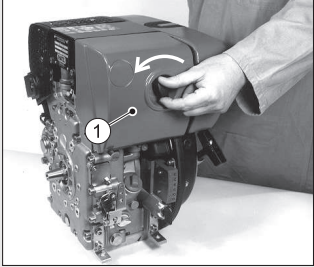
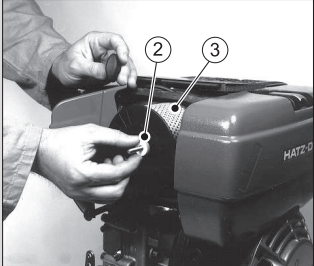
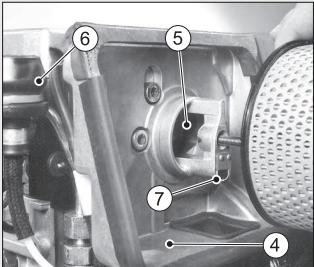

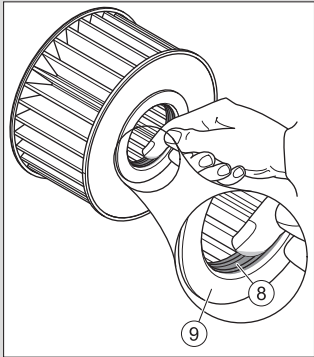
### Installing and removing the filter cartridge

Step	Activity	Figure
1	Unscrew the air filter cover (1).	
2	Unscrew the knurled nut (2) and remove the air filter cartridge (3).	
3	Clean the filter housing (4) and cover for the air filter. Ingress of dirt or other foreign bodies into the intake opening (5) of the engine absolutely must be avoided.	
4	In the model with an air filter maintenance display (6), check the condition and cleanliness of the valve shim (7).	

Step	Activity	Figure
5	The air filter cartridge either needs to be replaced, or cleaned or checked depending on the degree of contamination (see chapter 8.2.13 <i>Checking and cleaning the air filter cartridge, page 85</i> ).	
6	Thinly coat the gasket (8) with grease or engine oil to make assembly and disassembly of the air filter cartridge easier. Do <b>not</b> coat the face side (9).	
7	Assemble in reverse order.	

### 8.2.13 Checking and cleaning the air filter cartridge

#### Safety notes

 <b>CAUTION</b>	
 	<p><b>Danger of injury.</b></p> <p>When working with compressed air, foreign bodies may fly into your eyes.</p> <ul style="list-style-type: none"> <li>▪ Wear safety goggles.</li> <li>▪ Never direct the compressed air jet toward people or toward yourself.</li> </ul>
 <b>CAUTION</b>	
	<p><b>Danger of injury.</b></p> <p>When blowing out the filter cartridge, the ambient air becomes contaminated with dust.</p> <ul style="list-style-type: none"> <li>▪ This dust may contain harmful particles.</li> <li>▪ Wear a fine dust mask.</li> </ul>

**NOTICE**

- The pressure must not exceed 5 bar.
- Even minor damage in the areas of the sealing surface, filter paper or filter cartridge makes it impossible to reuse the filter cartridge.

**Checking and cleaning the air filter cartridge**

Step	Activity	Figure
<b>Dry contamination</b>		
1	Blow out the filter cartridge (1) with dry compressed air from the inside to the outside until dust no longer emerges.	
2	Check the sealing surface (2) of the filter cartridge for damage.	
3	Check the filter cartridge for cracks in the filter paper and other damage by holding it against the light at a slant or letting light from a lamp shine through it.	
4	Replace the filter cartridge if necessary (see note).	
<b>Moist or oily contamination</b>		
1	Renew the filter cartridge.	

## 9 Faults

### 9.1 Troubleshooting

#### General troubleshooting notes

If the cases listed below have been worked through but the fault continues to persist, please contact your nearest **Hatz service station**.

#### The engine does not start or is difficult to start, but can be turned easily as usual

Possible causes	Remedy	Chapter
Speed control lever in stop or idle position.	Set the speed control lever to the START position.	<i>7.3 Setting the speed control, page 37</i>
Stop pin in STOP position.	Move the stop pin by pulling it lightly into the operating position.	<i>7.5.1 Switching off the engine (mechanical), page 45</i>
No fuel at the injection pump.	Refuel.	<i>7.7 Refueling, page 51</i>
	<b>Systematically check the entire fuel supply. If this does not yield results:</b>	
	<ul style="list-style-type: none"> <li>▪ Check the feed line to the engine.</li> </ul>	
	<ul style="list-style-type: none"> <li>▪ Check the fuel filter.</li> </ul>	<i>8.2.11 Changing the fuel filter, page 79</i>
Injection nozzle is not functional.	Contact Hatz Service.	
<b>Insufficient compression:</b>		
<ul style="list-style-type: none"> <li>▪ Wrong tappet clearance.</li> </ul>	Check the tappet clearance and adjust if necessary.	<i>8.2.6 Check and set the tappet clearance, page 66</i>
<ul style="list-style-type: none"> <li>▪ Cylinder and/or piston ring wear.</li> </ul>	Contact Hatz Service.	

**If equipped with a fuel shut-off valve or electrical automatic shutoff (engine does not start)**

Possible causes	Remedy	Chapter
The fuel shut-off valve is not functional and/or irregularities in the electrical equipment.	Contact Hatz Service.	

**For low temperatures (engine does not start)**

Possible causes	Remedy	Chapter
Temperature below start limit temperature.	Activate the pre glow system (option).	<i>7.4.2 Starting the engine with a starter, page 40</i>
Pre glow system (option) defective.	Contact Hatz Service.	
Fuel gelled due to insufficient cold resistance.	Check whether the fuel that emerges from the fuel feed line is clear and not cloudy. If the fuel has gelled, either thaw the engine or drain the entire fuel supply system. Fill with a temperature-resistant fuel mixture.	<i>4.5 Fuel, page 26</i> <i>8.2.11 Changing the fuel filter, page 79</i>
Oil is too viscous and causes a too low starter speed.	Change the engine oil. Add engine oil with a suitable viscosity class.	<i>8.2.4 Change the engine oil, page 61</i>
Insufficiently charged battery.	Check the battery and contact the service center if necessary.	<i>3.2.4 Electrical equipment, page 18</i>
Machine is not uncoupled.	If possible, separate the engine from the machine by uncoupling it.	

**The engine fires but then fails to continue running**

Possible causes	Remedy	Chapter
The speed control lever is not sufficiently set to the Start direction.	Set the lever to the Start position.	<i>7.3 Setting the speed control, page 37</i>
Machine is not uncoupled.	If possible, separate the engine from the machine by uncoupling it.	



Possible causes	Remedy	Chapter
Fuel filter is clogged.	Change the fuel filter.	8.2.11 <i>Changing the fuel filter, page 79</i>
<b>Stop signal from monitoring elements that are associated with the automatic switch-off (optional):</b>		
▪ No oil pressure.	Check the oil level.	7.6 <i>Check the oil level, page 48</i>
▪ Defective alternator (only for "External valve box" version).	Contact HATZ Service.	
▪ Engine temperature too high.	Check the cooling air guides for contamination or other impairments.	8.2.8 <i>Clean the cooling air area, page 71</i>
▪ Motor runs at over-speed (only in "Valve box mounted on the engine" version).	Contact HATZ Service.	
<b>Fault signal from the overvoltage and polarity protection system in the voltage regulator:</b>		
Battery and/or other cable connections are incorrectly connected.	Check the electrical equipment and its components or contact Hatz service.	Electrical equipment
Loose cable connections.		

**The starter does not switch on and the engine does not turn.**

Possible causes	Remedy	Chapter
<b>Irregularities in the electrical equipment:</b>		
Battery and/or other cable connections are incorrectly connected.	Check the electrical equipment and its components or contact Hatz service.	3.2.4 <i>Electrical equipment, page 18</i>
Cable connections are loose and/or oxidized.		
Battery is faulty and/or not loaded.		
Faulty starter.		
Faulty relay, monitoring elements, etc.		

**Engine switches off spontaneously during operation**

Possible causes	Remedy	Chapter
The tank ran out of fuel during operation.	Fill with fuel.	<i>7.7 Refueling, page 51</i>
Fuel filter is clogged.	Change the fuel filter.	<i>8.2.11 Changing the fuel filter, page 79</i>
Tank vent is clogged.	Ensure that the tank is sufficiently vented.	
Air in the fuel system.	Check the fuel system for air ingress. Check the bleed valve.	
Mechanical faults.	Contact Hatz Service.	

**With automatic electrical switch-off mechanism (option)**

Possible causes	Remedy	Chapter
<b>Stop signal of monitoring elements for:</b>		
▪ Oil pressure too low.	Check the oil level.	<i>7.6 Check the oil level, page 48</i>
▪ Engine temperature too high.	Check the cooling air guides for contamination or other impairments.	<i>8.2.8 Clean the cooling air area, page 71</i>
▪ Defective alternator (only for "External valve box" version).	Contact HATZ Service.	
▪ Motor runs at over-speed (only with "Valve box mounted on the engine" version).	Contact HATZ Service.	
<b>Fault signal from the overvoltage and polarity protection system in the voltage regulator:</b>		
▪ Battery and/or other cable connections are incorrectly connected.	Check the electrical equipment and its components or contact Hatz service.	Electrical equipment
▪ Loose contacts on cable connections.		

**The engine loses power and speed**

Possible causes	Remedy	Chapter
The speed adjustment lever does not stay in the desired position.	Block the speed adjustment.	
<b>The fuel supply is impaired:</b>		
▪ The tank ran out of fuel during operation.	Add fuel.	<i>7.7 Refueling, page 51</i>
▪ Fuel filter is clogged.	Change the fuel filter.	<i>8.2.11 Changing the fuel filter, page 79</i>
▪ Inadequate tank venting.	Ensure that the tank is sufficiently vented.	
▪ Air in the fuel system.	Check the fuel system for air ingress. Check the bleed valve.	

**The engine loses power and speed, and black smoke emerges from the exhaust**

Possible causes	Remedy	Chapter
Dirty air filter unit.	Check the degree of dirt contamination of the air filter, and clean or renew it if necessary.	<i>8.2.12 Maintaining the dry air filter, page 84</i>
Tappet clearance not OK.	Adjust the tappet clearance.	<i>8.2.6 Check and set the tappet clearance, page 66</i>
Injection nozzle not OK.	Contact Hatz Service.	

**Engine becomes very hot. Indicator lamp for engine temperature (option) lights up**

Possible causes	Remedy	Chapter
Too much engine oil in the engine.	Drain the engine oil to the upper mark of the dipstick.	<i>7.6 Check the oil level, page 48</i>
<b>Inadequate cooling:</b>		
▪ Contamination in the entire area of the cooling air guides.	Clean the cooling air area.	<i>8.2.8 Clean the cooling air area, page 71</i>

Possible causes	Remedy	Chapter
<ul style="list-style-type: none"> <li>Incompletely closed air guide parts.</li> </ul>	Check the air guide parts and shafts for completeness and good sealing properties.	

**Condensate emerges from the exhaust silencer**



Possible causes	Remedy	Chapter
Operation under no load or very low load for an extended period.	Operate the machine at a load of approx. 70 % if possible until the exhaust outlet is dry again.	

**9.2 Emergency start**

If an electrical fault signal occurs, the optional automatic switch-off locks the fuel shut-off valve (1) and thereby stops the fuel supply to the injection pump – the engine switches off. Also, a fault in the electrical equipment can cause the engine to switch off.

If this occurs at a critical location, such as at a railroad crossing or intersection, an emergency start can be activated.

**Safety notes**

 <b>CAUTION</b>	
	<p><b>Danger when switching off the engine from the emergency operation mode.</b></p> <p>During the emergency operation mode, the engine can only be switched off with the starting key if the emergency start lever is first returned to its home position <b>in a clockwise direction</b>.</p>
<b>CAUTION</b>	
	<p><b>Danger of later engine damage.</b></p> <p>The monitoring components (oil pressure, charge control and engine temperature) are deactivated in emergency operation.</p> <ul style="list-style-type: none"> <li>The oil level must be checked before the emergency operation phase.</li> </ul>
<b>NOTICE</b>	
	<p>If the emergency operation mode is used, the risk transfers to the operator (<b>the Motorenfabrik HATZ does not accept liability in this case</b>).</p> <ul style="list-style-type: none"> <li>Immediately after the emergency operation phase, determine the cause of the fault.</li> <li>Have the <b>Hatz service station</b> supply the emergency start lever with a new lead seal.</li> </ul>

## Overview

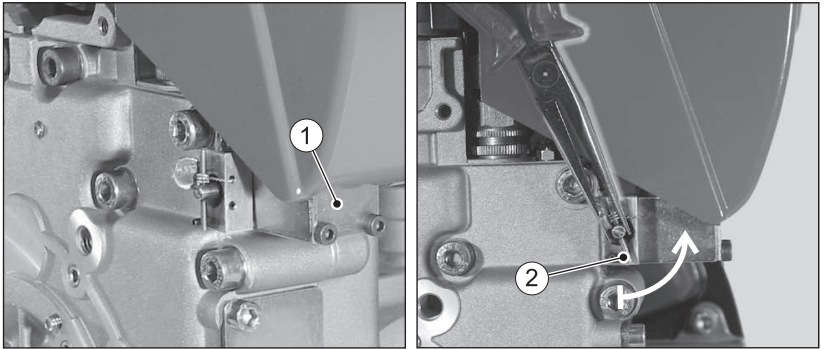

1	Fuel shut-off valve (option)
2	Emergency start lever









## Procedure

Step	Activity
1	Using suitable pliers, turn the emergency start lever (2) counterclockwise by at least 90° (seal wire tears). The emergency start lever is now located in the start position, and the fuel shut-off valve (1) is mechanically unlocked.
2	Start the engine with the starter or recoil start (see chapter 7.4 <i>Starting the engine, page 38</i> ).
3	Turn the emergency start lever back to the stop in a clockwise direction. Otherwise, it will not be possible to switch off the machine using the starting key.

## 10 Storage and disposal

### 10.1 Storing the machine

#### Safety notes

 <b>DANGER</b>	
	<p><b>Danger to life from inhaling exhaust gases.</b></p> <p>Toxic engine exhaust gases can lead to loss of consciousness and even death in closed-off and poorly ventilated rooms.</p> <ul style="list-style-type: none"> <li>▪ Never operate the machine in closed-off or poorly ventilated rooms.</li> <li>▪ Do not breathe in the exhaust gases.</li> </ul>
 <b>DANGER</b>	
 	<p><b>Fire hazard from fuel.</b></p> <p>Leaked or spilled fuel can ignite on hot engine parts and cause serious burn injuries.</p> <ul style="list-style-type: none"> <li>▪ Only refuel when the engine is switched off and has cooled down.</li> <li>▪ Never refuel in the vicinity of open flames or sparks that can cause ignition.</li> <li>▪ Do not smoke.</li> <li>▪ Do not spill fuel.</li> </ul>
 <b>CAUTION</b>	
	<p><b>Danger of environmental damage from spilled fuel.</b></p> <p>Do not overfill the fuel tank and do not spill fuel.</p> <ul style="list-style-type: none"> <li>▪ Collect any leaking fuel and dispose of it according to local environmental regulations.</li> </ul>
<b>NOTICE</b>	
	<p><b>Comply with the safety chapter!</b></p> <p>Follow the basic safety instructions in chapter 3 <i>Safety, page 7.</i></p>

### Storing the machine for a lengthy period

Take the following measures if you intend to take the machine out of service for a lengthy period (3-12 months):

Step	Activity
1	Drain the fuel tank until it is nearly empty and fill with FAME*-free fuel. Operate the engine for a few minutes so that only FAME-free fuel is still in the fuel system.
2	Change the engine oil (see chapter 8.2.4 <i>Change the engine oil, page 61</i> ).
3	Change the fuel filter (see chapter 8.2.11 <i>Changing the fuel filter, page 79</i> ).
4	Let the machine cool down.
5	Remove the battery in accordance with the Operator's Manual for the machine and store at ambient temperature. Comply with the local regulations as well as the regulations of the battery manufacturer for the storage of batteries.
6	Close and seal all engine openings (air intake openings, air outlet openings and the exhaust gas opening) so that no foreign bodies can enter, but a small amount of air can still be exchanged. This avoids condensation.
7	After the machine has cooled down, cover it to protect it against dust and store it in a dry and clean place.

\*FAME = Fatty Acid Methyl Ester

### Ambient conditions during storage

- Max. permissible storage temperature: -25 °C to +60 °C
- Max. permissible humidity: 70%
- Protect the engine from direct sunlight

### Recommissioning

Step	Activity
1	Remove all covers.
2	Check the cables, hoses and lines for cracks and leak tightness.
3	Check the engine oil level.
4	Install the battery in accordance with the Operator's Manual for the machine.

The brand new engine can normally be stored for up to 12 months. The protection lasts up to approx. 6 months at very high humidity and with sea air.

For storage periods of more than 12 months, please contact the nearest **Hatz service**.

## 10.2 Disposing of the machine

### Disposal information

Dispose of the machine (including machine parts, engine oil and fuel) according to the local disposal regulations and the environmental laws in the country of use.

Because of the danger of possible environmental damage, only permit an approved specialist company to dispose of the machine.

#### **NOTICE**



When the machine has reached the end of its lifecycle, ensure that it is disposed of safely and properly, especially parts and substances that can be dangerous to the environment. These also include fuel, lubricants, plastics, and batteries (if present).

- Do not dispose of the battery with the household trash.
- Dispose of the battery at a collection point for possible recycling.



# 11 Installation declaration

## Extended Declaration of Incorporation EC Machinery Directive 2006/42/EC

The manufacturer: **Motorenfabrik Hatz GmbH & Co.KG**  
**Ernst-Hatz-Straße 16**  
**94099 Ruhstorf a. d. Rott (Germany)**

hereby declares that the incomplete machine: product description: **Hatz diesel engine**

Type designation and as of serial number:

**1B20=10034; 1B20V=11124; 1B20R=14413**

**1B30=10129; 1B30V=11220; 1B30E=18210; 1B30VE=18310**

**1B40=11019;**

**1B50=12416; 1B50V/W=12616; 1B50E=18410**

satisfies the following basic safety and health protection requirements in acc. with Annex I to the above-mentioned Directive.

- Annex I, General principles no. 1

- No. 1.1.2., 1.1.3., 1.1.5., 1.2.1., 1.2.2., 1.2.3., 1.2.4.1., 1.2.4.2., 1.2.6, 1.3.1., 1.3.2., 1.3.3., 1.3.4., 1.3.7., 1.3.9., 1.4.1., 1.5.1., 1.5.3., 1.5.8., 1.5.9., 1.5.10, 1.5.11, 1.6.1., 1.6.2., 1.6.4., 1.7.

All relevant basic safety and health protection requirements down to the interfaces described

in the manual for diesel engine

in the enclosed data sheets

in the enclosed technical documents

have been complied with.

The following standards have been applied (fully or in part):

- EN 1679-1: 092011

- EN ISO 12100: 032011

- EN ISO 13857: 062008

- EN 60204-1: 062007

The manual for the diesel engine has been attached to that of the incomplete machine and the Assembly Instructions have been provided to the customer electronically together with the order confirmation.

The special technical documents in acc. with Annex VII B of the Directive 2006/42/EC have been prepared. If necessary, I will submit the above-mentioned special technical documents in electronic form to the competent authority.

The above-mentioned special technical documents can be requested from:

Wolfgang Krautloher, address, see manufacturer

Commissioning is prohibited until it has been established, where applicable, that the machine into which the above-mentioned incomplete machine is to be incorporated, satisfies the provisions of the Machinery Directive.

04/11/2020

Date

  
 Maximilian Eder  
 Series manager air-cooled engines

  
 Dr.-Ing. Simon Thierfelder  
 Chief Technical Officer - CTO

## 12 Declaration of the manufacturer

The following "Manufacturer's declaration of compliance with regulation (EU) 2016/1628" only applies to engines with an engine family designation in accordance with section 1.5 (see next page).

The corresponding engine family designation is noted on the engine type plate (see chapter 4.2 *Engine type plate*, page 23).

### CO<sub>2</sub> emissions\*

Engine family designation	CO <sub>2</sub> g/kWh	Test cycle	Parent engine	Speed
1B20/30 - constant speed	937.56	NRSC-D2	1B30	3000
1B20/30 - variable speed	986.79	NRSC-G2	1B30	3000
1B40/50 - constant speed	829.69	NRSC-D2	1B50	3000
1B40/50 - variable speed	888.00	NRSC-G2	1B50	3000

\*According to EU Regulation 2016/1628, Article 43 Paragraph (4)

## Declaration by manufacturer on compliance with Regulation (EU) 2016/1628

The undersigned: Manfred Wührmüller, Head of Quality Management GMQ

Hereby declares that the following engine type/engine family (\*) complies in all respects with the requirements of Regulation (EU) 2016/1628 of the European Parliament and of the Council <sup>(1)</sup>, Commission Delegated Regulation (EU) 2017/654 <sup>(2)</sup>, Commission Delegated Regulation (EU) 2017/655 <sup>(3)</sup> and Commission Implementing Regulation (EU) 2017/656 <sup>(4)</sup> and does not use any defeat strategy.

All emission control strategies comply, where applicable, with the requirements for Base Emission Control Strategy (BECS) and Auxiliary Emission Control Strategy (AECS) set-out in section 2 of Annex IV to Delegated Regulation (EU) 2017/654, and have been disclosed in accordance with that Annex and with Annex I to Implementing Regulation (EU) 2017/656.

- 1.1. Make (trade name(s) of manufacturer): **Hatz**
- 1.2. Commercial name(s) (if applicable): **Hatz-Diesel**
- 1.3. Company name and address of manufacturer:  
**Motorenfabrik Hatz GmbH & Co. KG, Ernst-Hatz-Str. 16, 94099 Ruhstorf a.d. Rott**
- 1.4. Name and address of manufacturer's authorised representative (if any): –
- 1.5. Engine type designation/ engine family designation/ FT (\*):  
**1B20/30 - variable Drehzahl, 1B20/30 - konstante Drehzahl,  
1B40/50 - variable Drehzahl, 1B40/50 - konstante Drehzahl**

(Place) (Date):

*Ruhstorf a.d. R. 04.07.18*  

<sup>(1)</sup> Regulation (EU) 2016/1628 of the European Parliament and of the Council of 14 September 2016 on requirements relating to gaseous and particulate pollutant emission limits and type-approval for internal combustion engines for non-road mobile machinery, amending Regulations (EU) No 1024/2012 and (EU) No 167/2013, and amending and repealing Directive 97/68/EC (OJ L 252, 16.9.2016, p. 53).

<sup>(2)</sup> Commission Delegated Regulation (EU) 2017/654 of 19 December 2016 supplementing Regulation (EU) 2016/1628 of the European Parliament and of the Council with regard to technical and general requirements relating to emission limits and type-approval for internal combustion engines for non-road mobile machinery (OJ L 102, 13.4.2017, p. 1).

<sup>(3)</sup> Commission Delegated Regulation (EU) 2017/655 of 19 December 2016 supplementing Regulation (EU) 2016/1628 of the European Parliament and of the Council with regard to monitoring of gaseous pollutant emissions from in-service internal combustion engines installed in non-road mobile machinery (OJ L 102, 13.4.2017, p. 334).

<sup>(4)</sup> Commission Implementing Regulation (EU) 2017/656 of 19 December 2016 laying down the administrative requirements relating to emission limits and type-approval of internal combustion engines for non-road mobile machinery in accordance with Regulation (EU) 2016/1628 of the European Parliament and of the Council (OJ L 102, 13.4.2017, p. 364).

<sup>(5)</sup> Regulation (EU) No 910/2014 of the European Parliament and of the Council of 23 July 2014 on electronic identification and trust services for electronic transactions in the internal market and repealing Directive 1999/93/EC (OJ L 257, 28.8.2014, p. 73).

**Motorenfabrik Hatz GmbH & Co. KG**

Ernst-Hatz-Str. 16

94099 Ruhstorf a. d. Rott

Deutschland

Tel. +49 8531 319-0

Fax. +49 8531 319-418

marketing@hatz-diesel.de

www.hatz-diesel.com



**CREATING POWER SOLUTIONS.**

**0000 433 802 16 - 05.2021**

Printed in Germany

EN