

Poulan®

ENGLISH



Please do not return unit to retailer.
Por favor, no devuelva el aparato al lugar de compra.
Veuillez ne pas retourner l'outil au détaillant.

1-800-554-6723

www.poulan.com

Operator's Manual Manual del Operador Manuel de L'utilisateur

1950 / 2025 / 2050 / 2075
2150 / 2175 / 2350 / 2375

ESPAÑOL



For Occasional Use Only



WARNING:

Read and follow all Safety Rules and Operating Instructions before using this product. Failure to do so can result in serious injury.

ADVERTENCIA:

Lea el manual del operador y siga todas las advertencias e instrucciones de seguridad. El no hacerlo puede resultar en lesiones graves.

AVERTISSEMENT:

Lire le manuel de l'utilisateur et bien respecter tous les avertissements et toutes les instructions de sécurité. Tout défaut de le faire pourrait entraîner des blessures graves.

Electrolux Home Products
North America
Div. of WCI Outdoor Products, Inc.
Augusta, GA 30907

FRANÇAIS

SAFETY RULES

WARNING: Always disconnect spark plug wire and place wire where it cannot contact spark plug to prevent accidental starting when setting up, transporting, adjusting or making repairs except carburetor adjustments.

Because a chain saw is a high-speed wood-cutting tool, special safety precautions must be observed to reduce the risk of accidents. Careless or improper use of this tool can cause serious injury.

PLAN AHEAD

- Read this manual carefully until you completely understand and can follow all safety rules, precautions, and operating instructions before attempting to use the unit.
- Restrict the use of your saw to adult users who understand and can follow safety rules, precautions, and operating instructions found in this manual.

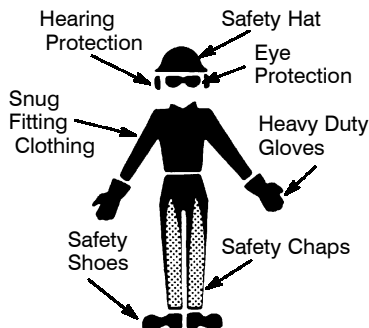

- Wear protective gear. Always use steel-toed safety footwear with non-slip soles; snug-fitting clothing; heavy-duty, non-slip gloves; eye protection such as non-fogging, vented goggles or face screen; an approved safety hard hat; and sound barriers (ear plugs or mufflers) to protect your hearing. Regular users should have hearing checked regularly as chain saw noise can damage hearing. Secure hair above shoulder length.
- Keep all parts of your body away from the chain when the engine is running.
- Keep children, bystanders, and animals a minimum of 30 feet (10 Meters) away from the work area. Do not allow other people or animals to be near the chain saw when starting or operating the chain saw.
- Do not handle or operate a chain saw when you are fatigued, ill, or upset, or if you have taken alcohol, drugs, or medication. You must be in good physical condition and mentally alert. Chain saw work is strenuous. If you have any condition that might be aggravated by

strenuous work, check with your doctor before operating a chain saw.

- Carefully plan your sawing operation in advance. Do not start cutting until you have a clear work area, secure footing, and, if you are felling trees, a planned retreat path.

OPERATE YOUR SAW SAFELY

- Do not operate a chain saw with one hand. Serious injury to the operator, helpers, bystanders or any combination of these persons may result from one-handed operation. A chain saw is intended for two-handed use.
- Operate the chain saw only in a well-ventilated outdoor area.
- Do not operate saw from a ladder or in a tree, unless you are specifically trained to do so.
- Make sure the chain will not make contact with any object while starting the engine. Never try to start the saw when the guide bar is in a cut.
- Do not put pressure on the saw at the end of the cut. Applying pressure can cause you to lose control when the cut is completed.
- Stop the engine before setting the saw down.
- Be alert for springback when cutting a limb that is under tension so you will not be struck by the limb or saw when the tension in the wood fibers is released.

MAINTAIN YOUR SAW IN GOOD WORKING ORDER

- Have all chain saw service performed by a qualified service dealer with the exception of the items listed in the maintenance section of this manual. For example, if improper tools are used to remove or hold the flywheel when servicing the clutch, structural damage to the flywheel can occur and cause the flywheel to burst.
- Make certain the saw chain stops moving when the throttle trigger is released. For correction, refer to "Carburetor Adjustments."
- Never modify your saw in any way. Use only attachments supplied or specifically recommended by the manufacturer.
- Keep the handles dry, clean, and free of oil or fuel mixture.
- With the engine stopped, hand carry the chain saw with the muffler away from your body, and the guide bar and chain to the rear, preferably covered with a scabbard.
- Keep fuel and oil caps, screws, and fasteners securely tightened.
- Use only Poulan accessories and replacement parts as recommended.

HANDLE FUEL WITH CAUTION

- Do not smoke while handling fuel or while operating the saw.
- Eliminate all sources of sparks or flame in the areas where fuel is mixed or poured. There should be no smoking,

open flames, or work that could cause sparks. Allow engine to cool before refueling.

- Mix and pour fuel in an outdoor area on bare ground; store fuel in a cool, dry, well ventilated place; and use an approved, marked container for all fuel purposes. Wipe up all fuel spills before starting saw.
- Move at least 10 feet (3 meters) from fueling site before starting engine.
- Turn the engine off and let saw cool in a non-combustible area, not on dry leaves, straw, paper, etc. Slowly remove fuel cap and refuel unit.
- Store the unit and fuel in an area where fuel vapors cannot reach sparks or open flames from water heaters, electric motors or switches, furnaces, etc.

KICKBACK

WARNING: Kickback can occur when the moving chain contacts an object at the upper portion of the tip of the guide bar or when the wood closes in and pinches the saw chain in the cut. Contact at the upper portion of the tip of the guide bar can cause the chain to dig into the object, which stops the chain for an instant. The result is a lightning fast, reverse reaction which kicks the guide bar up and back toward the operator. If the saw chain is pinched along the top of the guide bar, the guide bar can be driven rapidly back toward the operator. Either of these reactions can cause loss of saw control which can result in serious injury. **Guard against kickback**

Rotational Kickback is the rapid upward and backward motion of the chain saw that can occur when the moving saw chain near the upper portion of the tip of the guide bar contacts an object such as a log or a branch.

Pinch-Kickback and Pull-In occur when the chain is suddenly stopped by being pinched, caught, or by contacting a foreign object in the wood. This sudden stopping of the chain results in a reversal of the chain force used to cut wood and causes the saw to move in the opposite direction of the chain rotation. Pinch-Kickback drives the saw straight back toward the operator. Pull-In pulls the saw away from the operator. Either reaction can result in loss of control and serious injury.

Avoid Pinch-Kickback:

- Be extremely aware of situations or obstructions that can cause material to pinch the top of or otherwise stop the chain.
- Do not cut more than one log at a time.
- Do not twist the saw as the bar is withdrawn from an undercut when bucking.

Avoid Pull-In:

- Always begin cutting with the engine at full speed and the saw housing against wood.
- Use wedges made of plastic or wood. Never use metal to hold the cut open.

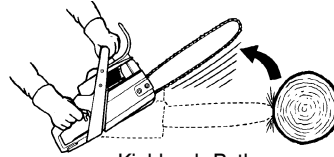

Kickback Path

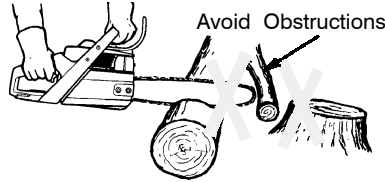

Avoid Obstructions

Clear The Working Area

REDUCE THE CHANCE OF KICKBACK

- Recognize that kickback can happen. With a basic understanding of kickback, you can reduce the element of surprise which contributes to accidents.
- Never let the moving chain contact any object at the tip of the guide bar.
- Keep the working area free from obstructions such as other trees, branches, rocks, fences, stumps, etc. Eliminate or avoid any obstruction that your saw chain could hit while you are cutting through a particular log or branch.
- Keep your saw chain sharp and properly tensioned. A loose or dull chain can increase the chance of kickback occurring. Follow manufacturer's chain sharpening and maintenance instructions. Check tension at regular intervals with the engine stopped, never with the engine running. Make sure the bar clamp nuts are securely tightened after tensioning the chain.
- Begin and continue cutting at full speed. If the chain is moving at a slower speed, there is greater chance of kickback occurring.
- Cut one log at a time.
- Use extreme caution when re-entering a previous cut.
- Do not attempt cuts starting with the tip of the bar (plunge cuts).
- Watch for shifting logs or other forces that could close a cut and pinch or fall into chain.
- Use the Reduced-Kickback Guide Bar and Low-Kickback Chain specified for your saw.

MAINTAIN CONTROL

Stand to the left of the saw

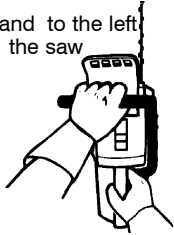

Never reverse hand positions

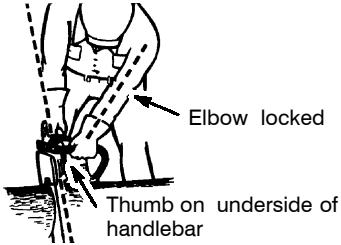

- Keep a good, firm grip on the saw with both hands when the engine is running and don't let go. A firm grip will help you reduce kickback and maintain control of the saw. Keep the fingers of your left hand encircling and your left thumb under the front handlebar. Keep your right hand completely around the rear handle whether you are right handed or left handed. Keep your left arm straight with the elbow locked.
- Position your left hand on the front handlebar so it is in a straight line with your right hand on the rear handle when making bucking cuts. Never reverse right and left hand positions for any type of cutting.
- Stand with your weight evenly balanced on both feet.
- Stand slightly to the left side of the saw to keep your body from being in a direct line with the cutting chain.
- Do not overreach. You could be drawn or thrown off balance and lose control of the saw.
- Do not cut above shoulder height. It is difficult to maintain control of saw above shoulder height.

KICKBACK SAFETY FEATURES

WARNING: The following features are included on your saw to help reduce the hazard of kickback; however, such features will not totally eliminate this dangerous reaction. As a chain saw user, do not rely only on safety devices. You must follow all safety precautions, instructions, and maintenance in this manual to help avoid kickback and other forces which can result in serious injury.

- Reduced-Kickback Guide Bar, designed with a small radius tip which reduces the size of the kickback danger zone on the bar tip. A Reduced-Kick-

back Guide Bar has been demonstrated to significantly reduce the number and seriousness of kickbacks when tested in accordance with safety requirements for gasoline powered chain saws as set by ANSI B175.1.

- Low-Kickback Chain, designed with a contoured depth gauge and guard link which deflect kickback force and allow wood to gradually ride into the cutter. Low-Kickback Chain has met kickback performance requirements when tested on a representative sample of chain saws below 3.8 cubic inch displacement specified in ANSI B175.1.
- Handguard, designed to reduce the chance of your left hand contacting the chain if your hand slips off the front handlebar.
- Position of front and rear handlebars, designed with distance between handles and "in-line" with each other. The spread and "in-line" position of the hands provided by this design work together to give balance and resistance in controlling the pivot of the saw back toward the operator if kickback occurs.

Reduced Kickback Symmetrical Guide Bar

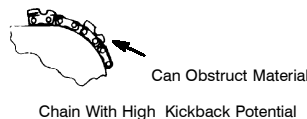
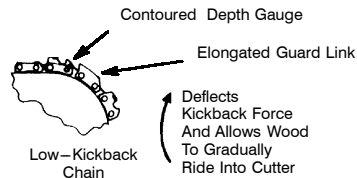
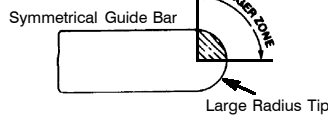

ANSI B175.1-1991 "American National Standard for Powered Tools – Gasoline Powered Chain Saw – Safety Requirements."

NOTE: If this saw is to be used for commercial logging, you must order and install a chain brake to comply with Federal OSHA Regulations for Commercial Logging. Contact your Authorized Service Dealer or call 1-800-554-6723.

SAFETY NOTICE: Exposure to vibrations through prolonged use of gasoline powered hand tools could cause blood vessel or nerve damage in the fingers, hands, and joints of people prone to circulation disorders or abnormal swellings. Prolonged use in cold weather has been linked to blood vessel damage in otherwise healthy people. If symptoms occur such as numbness, pain, loss of strength, change in skin color or texture, or loss of feeling in the fingers, hands, or joints, discontinue the use of this tool and seek medical attention. An anti-vibration system does not guarantee the avoidance of these problems. Users who operate power tools on a continual and regular basis must monitor closely their physical condition and the condition of this tool.

SPECIAL NOTICE: Your saw is equipped with a temperature limiting muffler and spark arresting screen which meets the requirements of California Codes 4442 and 4443. All U.S. forest land and the states of California, Idaho, Maine, Minnesota, New Jersey, Oregon, and Washington require many internal combustion engines to be equipped with a spark arrester screen by law. If you operate a chain saw in a state or locale where such regulations exist, you are legally responsible for maintaining the operating condition of these parts. Failure to do so is a violation of the law. Refer to the SERVICE section for maintenance of the Spark Arrester.

Failure to follow all Safety Rules and Precautions can result in serious injury. If situations occur which are not covered in this manual, use care and good judgement. If you need assistance, contact your Authorized Service Dealer or call 1-800-554-6723.

ASSEMBLY

The assembly tool provided with your saw is the only tool needed for assembly. Protective gloves (not provided) should be worn during assembly.

ATTACHING THE BAR & CHAIN (If not already attached)

WARNING: Recheck each assembly step if the saw is received assembled. Always wear gloves when handling the chain. The chain is sharp and can cut you even when it is not moving!

- Loosen and remove the clamp nuts and the bar clamp from the saw.
- Remove the plastic shipping spacer (if present).

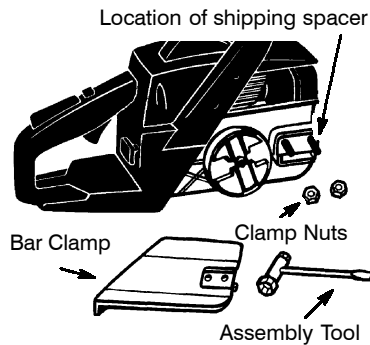

- An adjusting pin and screw are used to adjust the tension of the chain. It is very important when assembling the bar that the pin located on the adjusting screw aligns with a hole in the bar. Turning the screw will move the adjustment pin up and down the screw. Locate this adjustment pin before you begin mounting the bar onto the saw. See illustration below.

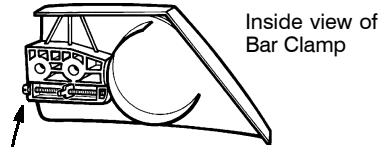

- Turn the adjusting screw counterclockwise to move the adjusting pin almost as far as it will go to the rear. This should allow the pin to be near the correct position. Further adjustment may be necessary as you mount the bar.
- Mount the bar as illustrated.
- Slide the bar toward the rear of the saw as far as possible.
- Prepare the chain by checking the proper direction. Without following the illustration it is easy to place the chain on the saw the wrong direction. Use the illustration of the chain to determine the proper direction.
- Place the chain onto the sprocket located behind the clutch drum. Fit the chain between the teeth in the sprocket.
- Start at the top of the bar and fit chain into groove around the guide bar.
- Pull the bar forward until the chain is snug in the groove of the bar.
- Hold guide bar against the saw frame and install the bar clamp. Make sure the adjusting pin is aligned with the hole in the bar. Remember this pin moves the bar forward and backward as the screw is turned.

- Replace the bar clamp nuts and tighten finger tight. Once the chain is tensioned you will need to tighten bar clamp nuts.

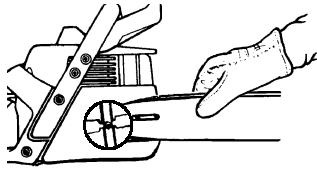

Mount the Bar

Tip of Bar →



Proper chain direction

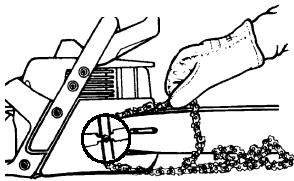

Place chain onto the sprocket

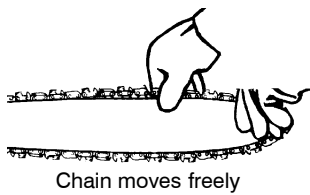

Chain moves freely



Lifts only 1/8 of an inch from bar.

FUELING & LUBRICATION

FUELING ENGINE

This engine is certified to operate on unleaded gasoline. Before operation, gasoline must be mixed with a good quality 2-cycle air-cooled engine oil. We recommend Poulan/Weed Eater brand oil. If you do not use this oil, use a good quality 2-cycle air-cooled oil designed to be mixed at a ratio of 40:1 (A 40:1 ratio is obtained by mixing 3.2 ounces of oil with 1 gallon of unleaded gasoline). When mixing fuel, follow the instructions printed on the container. Always read and follow the safety rules relating to fuel before fueling your unit.

BAR AND CHAIN LUBRICATION

The bar and chain require continuous lubrication. Lubrication is provided by the automatic oiler system when the oil tank is kept filled. Lack of oil will quickly ruin the bar and chain. Too little oil will cause overheating shown by smoke coming from the chain and/or discoloration of the bar.

In freezing weather oil will thicken, making it necessary to thin bar and chain oil with a small amount (5 to 10%) of #1 Diesel Fuel or kerosene. Bar and chain oil must be free flowing for the oil system to pump enough oil for adequate lubrication.

Genuine POULAN or POULAN PRO bar and chain oil is recommended to protect your unit against excessive wear from heat and friction. POULAN or POULAN PRO oil resists high temperature thinning. If POULAN or POULAN PRO bar and chain oil is not available, use a good grade SAE 30 oil.

- Never use waste oil for bar and chain lubrication.
- Always stop the engine before removing the oil cap.

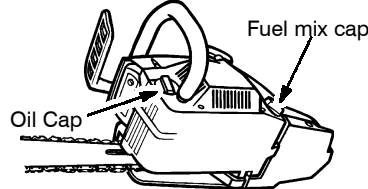

CHAIN TENSION (Including units with chain already installed)

NOTE: When adjusting chain tension, make sure the bar nuts are finger tight only. Attempting to tension the chain when the bar nuts are tight can cause damage.

Checking the tension:

Use the screwdriver end of the combination screwdriver/wrench tool to move the chain around the bar. If the chain does not rotate, it is too tight. If too loose, the chain will sag below the bar.

Adjusting the tension:

Chain tension is very important. Chain stretches during use. This is especially true during the first few times you use your saw. Always check chain tension each time you use and refuel your saw.

You can adjust the chain tension by loosening the bar clamp nuts and turning the adjusting screw 1/4 of a turn while lifting up on the bar.

- If chain is too tight, turn adjusting screw 1/4 turn counterclockwise.
- If chain is too loose, turn adjusting screw 1/4 turn clockwise.
- Lift up the tip of the bar and tighten the bar clamp nuts with the combination screwdriver/wrench.
- Recheck chain tension.

STARTING

WARNING: The chain must not move when the engine runs at idle speed. If the chain moves at idle speed refer to CARBURETOR ADJUSTMENT within this manual. Avoid contact with the muffler. A hot muffler can cause serious burns.

To stop the engine move the switch to the **STOP** or **OFF** position.

To start the engine hold the saw firmly on the ground as illustrated. Make sure the chain is free to turn without contacting any object.

Use only 15"–18" of rope per pull.
Hold saw firmly while pulling starter rope

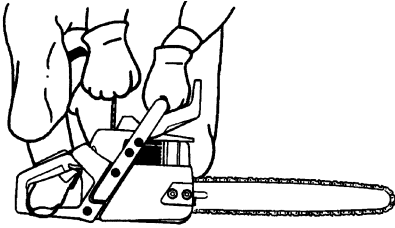

Important points to remember

When pulling the starter rope, do not use the full extent of the rope as this can cause the rope to break. Do not let starter rope snap back. Hold the handle and let the rope rewind slowly.

NOTE: Do not attempt to cut material with the fast idle lock button in the locked position.

For cold engine or warm engine after running out of fuel:

- Move switch to the **START** or **ON** position.
- Pull choke knob out to the full extent.
- Slowly press primer bulb six times.
- Squeeze and hold throttle trigger. With thumb press fast idle lock down; then release throttle trigger.
- Sharply pull the starter rope handle 5 times with your right hand.
- Fully push in choke knob; pull the starter rope until the engine starts.
- Allow the engine to run for approximately five seconds. Then, squeeze and release throttle trigger to allow engine to return to idle speed.



IGNITION SWITCH

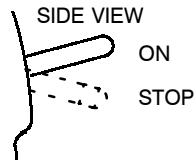

CHOKE (SIDE VIEW)

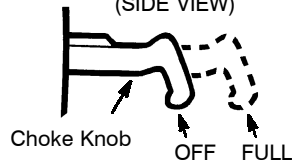

For a warm engine:

- Fully push in choke knob.
- Move switch to the **START** or **ON** position.
- Slowly press primer bulb six times.
- Squeeze and hold throttle trigger. With thumb press fast idle lock down; then release throttle trigger.
- Sharply pull the starter rope with your right hand until the engine starts.
- Squeeze and release throttle trigger to allow engine to return to idle speed.

Difficult starting or flooded engine:

The engine may be flooded with too much fuel if it has not started after 10 pulls.

Flooded engines can be cleared of excess fuel by following the warm engine starting procedure listed above. Insure the ignition switch is in the **ON** or **START** position.

Starting could require pulling the starter rope handle many times depending on how badly the unit is flooded. If engine fails to start, refer to troubleshooting chart or call 1-800-554-6723.

CUTTING METHODS

IMPORTANT POINTS

- Cut wood only. Do not cut metal, plastics, masonry, non-wood building materials, etc.
- Stop the saw if the chain strikes a foreign object. Inspect the saw and repair or replace parts as necessary.
- Keep the chain out of dirt and sand. Even a small amount of dirt will quickly dull a chain and thus increase the possibility of kickback.
- Practice cutting a few small logs using the following techniques to get the "feel" of using your saw before you begin a major sawing operation.
 - Squeeze throttle trigger and allow engine to reach full speed before cutting.
 - Begin cutting with the saw frame against the log.
 - Keep the engine at full speed the entire time you are cutting.

- Allow the chain to cut for you. Exert only light downward pressure. If you force the cut, damage to the bar, chain, or engine can result.
- Release the throttle trigger as soon as the cut is completed, allowing the engine to idle. If you run the saw at full throttle without a cutting load, unnecessary wear can occur to the chain, bar, and engine.
- To avoid losing control when cut is complete, do not put pressure on saw at end of cut.
- Stop the engine before setting the saw down after cutting.

TREE FELLING TECHNIQUES

Carefully plan your sawing operation in advance. Clear the work area. You need a clear area all around the tree so you can have secure footing. Study the natural conditions that can cause the tree to fall in a particular direction.

Natural conditions that can cause a tree to fall in a particular direction include:

- The wind direction and speed.
- The lean of the tree. The lean of a tree might not be apparent due to uneven or sloping terrain. Use a plumb or level to determine the direction of tree lean.
- Weight and branches on one side.
- Surrounding trees and obstacles.

Look for decay and rot. If the trunk is rotted, it can snap and fall toward the operator. Check for broken or dead branches which can fall on you while cutting.

Make sure there is enough room for the tree to fall. Maintain a distance of 2-1/2 tree lengths from the nearest person or other objects. Engine noise can drown out a warning call.

Remove dirt, stones, loose bark, nails, staples, and wire from the tree where cuts are to be made.

Plan a clear retreat path to the rear and diagonal to the line of fall.

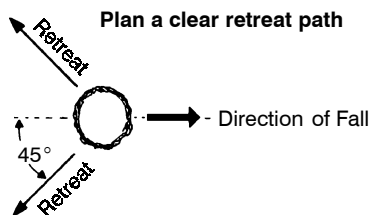

WARNING: Do not cut near buildings or electrical wires if you do not know the direction of tree fall, at night since you will not be able to see well, or during bad weather such as rain, snow, or strong winds. etc.

FELLING LARGE TREES

(6 inches in diameter or larger)

The notch method is used to fell large trees. A notch is cut on the side of the tree in the desired direction of fall. After a felling cut is made on the opposite side of tree, the tree will tend to fall into the notch.

NOTE: If the tree has large buttress roots, remove them before making the notch.

NOTCH CUT AND FELLING THE TREE

- Make notch cut by cutting the top of the notch first. Cut through 1/3 of the diameter of the tree. Next complete the notch by cutting the bottom of the notch. See illustrated. Once the notch is cut remove notch of wood from the tree.

Final cut here. 2 inches above center of notch.

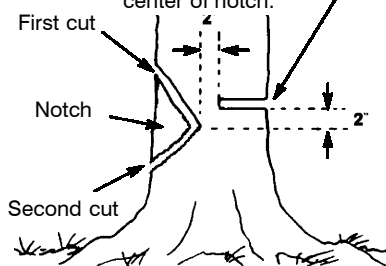

- After removing the cutout of wood, make the felling cut on the opposite side of the notch. This is done by making a cut about two inches higher than the center of the notch. This will leave enough uncut wood between the felling cut and the notch to form a hinge. This hinge will help prevent the tree from falling in the wrong direction.

Hinge holds tree on stump and helps control fall

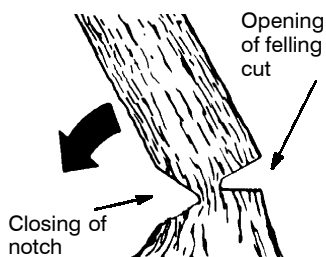

NOTE: Before felling cut is complete, use wedges to open the cut when necessary to control the direction of fall. Use wood or plastic wedges, but never steel or iron, to avoid kickback and chain damage.

- Be alert to signs that the tree is ready to fall: cracking sounds, widening of the felling cut, or movement in the upper branches.
- As tree starts to fall, stop saw, put it down, and get away quickly on your planned retreat path.
- Be extremely cautious with partially fallen trees that may be poorly supported. When a tree doesn't fall completely, set the saw aside and pull down the tree with a cable winch, block and tackle, or tractor. To avoid injury, do not cut down a partially fallen tree with your saw.

CUTTING A FALLEN TREE (BUCKING)

Bucking is the term used for cutting a fallen tree to the desired log size.

WARNING: Do not stand on the log being cut. Any portion can roll causing loss of footing and control. Do not stand downhill of the log being cut.

IMPORTANT POINTS

- Cut only one log at a time.
- Cut shattered wood very carefully; sharp pieces of wood could be flung toward operator.
- Use a sawhorse to cut small logs. Never allow another person to hold the log while cutting and never hold the log with your leg or foot.
- Do not cut in an area where logs, limbs, and roots are tangled such as in a blown down area. Drag the logs into a clear area before cutting by pulling out exposed and cleared logs first.
- Make the first bucking cut 1/3 of the way through the log and finish with a 2/3 cut on the opposite side. As the log is being cut, it will tend to bend. The saw can become pinched or hung in the log if you make the first cut deeper than 1/3 of the diameter of the log.
- Give special attention to logs under strain to prevent the saw from pinching. Make the first cut on the pressure side to relieve the stress on the log.

TYPES OF CUTTING USED FOR BUCKING

WARNING: If saw becomes pinched or hung in a log, don't try to force it out. You can lose control of the saw resulting in injury and/or damage to the saw. Stop the saw, drive a wedge of plastic or wood into the cut until the saw can be removed easily. Restart the saw and carefully reenter the cut. To avoid kickback and chain damage, do not use a metal wedge. Do not attempt to restart your saw when it is pinched or hung in a log.

Overcutting begins on the top side of the log with the bottom of the saw against the log. When overcutting use light downward pressure.

Undercutting involves cutting on the underside of the log with top of saw against the log. When undercutting use light upward pressure. Hold saw firmly and maintain control. The saw will tend to push back toward you.

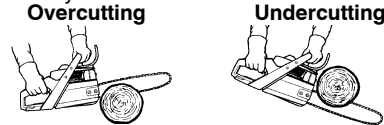

WARNING: Never turn saw upside down to undercut. The saw cannot be controlled in this position.

BUCKING WITHOUT A SUPPORT

- Overcut through 1/3 of the diameter of the log.
- Roll the log over and finish with a second overcut.
- Watch for logs with a pressure side. See illustration for cutting logs with a pressure side.

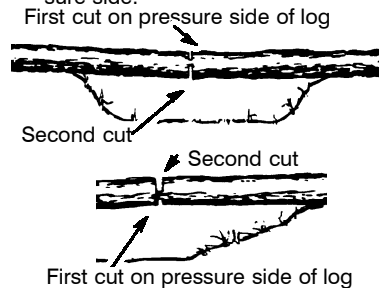

BUCKING USING A LOG OR SUPPORT STAND

- Remember your first cut is always on the pressure side of the log. (Refer to the illustration below for your first and second cut)
- Your first cut should extend 1/3 of the diameter of the log.
- Finish with your second cut.

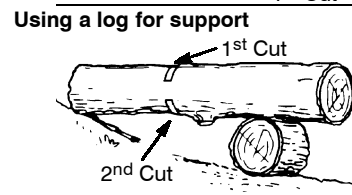
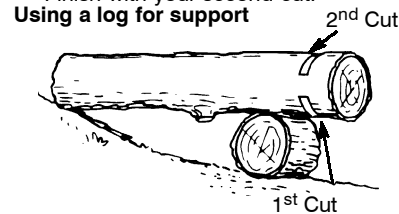

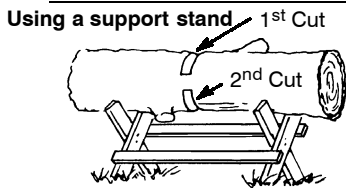
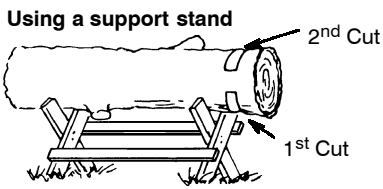

**REMOVING A PINCHED SAW
(A SAW HUNG IN THE LOG)**

- If saw becomes pinched or hung in a log, don't try to force it out. You can lose control of the saw resulting in personal injury and/or damage to the saw. Stop the saw and drive plastic or wooden wedge into the cut until the saw can be removed easily.
- Restart the saw and carefully reenter the cut. To avoid kickback and chain damage, do not use a metal wedge. Do not attempt to restart your saw when it is pinched or hung in a log.

Use a wedge to remove pinched saw

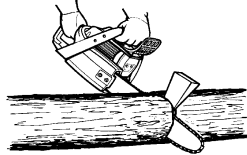

Turn saw OFF and use a plastic or wooden wedge to force cut open.

LIMBING AND PRUNING

WARNING: Never climb into a tree to limb or prune. Do not stand on ladders, platforms, a log, or in any position which can cause you to lose your balance or control of the saw.

IMPORTANT POINTS

- Work slowly, keeping both hands firmly gripped on the saw. Maintain secure footing and balance.
- Watch out for springpoles. Use extreme caution when cutting small size limbs. Slender material may catch the saw chain and be whipped toward you or pull you off balance.
- Be alert for springback. Watch out for branches that are bent or under pres-

sure. Avoid being struck by the branch or the saw when the tension in the wood fibers is released.

- Keep a clear work area. Frequently clear branches out of the way to avoid tripping over them.

LIMBING

- Always limb a tree after it is cut down. Only then can limbing be done safely and properly.
- Leave the larger limbs underneath the felled tree to support the tree as you work.
- Start at the base of the felled tree and work toward top, cutting branches and limbs. Remove small limbs with one cut.
- Keep the tree between you and the chain. Cut from the side of the tree opposite the branch you are cutting.
- Remove larger, supporting branches with the 1/3, 2/3 cutting techniques described in the bucking section.
 - Undercut 1/3 of the way through the log.
 - Finish with an overcut.
- Always use an overcut to cut small and freely hanging limbs. Undercutting could cause limbs to fall and pinch saw.

PRUNING

WARNING: Be alert for and guard against kickback. Do not allow the moving chain to contact any other branches or objects at the nose of the guide bar when limbing or pruning. Allowing such contact can result in serious injury.

- Limit pruning to limbs shoulder height or below. Do not cut if branches are higher than your shoulder. Get a professional to do the job.
- See illustration for the pruning technique.
 - Make your first cut 1/3 of the way through the bottom of the limb.
 - Next make a 2nd cut **all the way through the limb**. Then cut a third overcut leaving a 1 to 2 inch collar from the trunk of the tree.

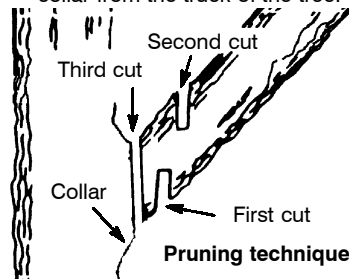

SERVICE

We recommend all service and adjustments not listed in this manual be performed by an authorized or Master Service Dealer.

MAINTENANCE SCHEDULE

Check:

Fuel Mixture Level . . .	Before each use
Bar Lubrication	Before each use
Chain Tension	Before each use
Chain Sharpness	Before each use
For damaged parts	Before each use
For loose caps.	Before each use
For loose fasteners	Before each use

Inspect and Clean:

Bar	Before each use
Complete saw	After each use
Air filter	Every 5 hours *
Spark arrestor	Every 25 hours *

Replace spark plug . . . Yearly

Replace fuel filter . . . Yearly

* Hours of Operation

AIR FILTER

CAUTION: Do not clean filter in gasoline or other flammable solvent to avoid creating a fire hazard or producing harmful evaporative emissions.

Cleaning the air filter:

A dirty air filter decreases engine performance and increases fuel consumption and harmful emissions. Always clean after every 5 hours of operation.

- Clean the cover and the area around it to keep dirt and sawdust from falling into the carburetor chamber when the cover is removed.
- Remove the parts as illustrated below.
- Wash the filter in soap and water.

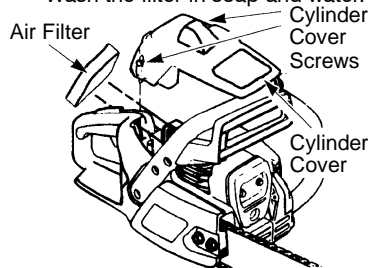

CARBURETOR ADJUSTMENTS

Your carburetor is equipped with limiter caps. Carburetor adjustment is a complicated task. We recommend that you take your unit to an Authorized Service Dealer. Damage will occur if you turn the needles beyond the limiter stops.

BAR MAINTENANCE

If your saw cuts to one side, has to be forced through the cut, or been run with an improp-

er amount of bar lubrication it may be necessary to service your bar. A worn bar will damage your chain and make cutting difficult.

Replace your bar if bent or the inside rails of the bar are worn.

- Clean the oil holes after each 5 hours of operation
- Remove sawdust from bar groove periodically with a wire or putty knife.

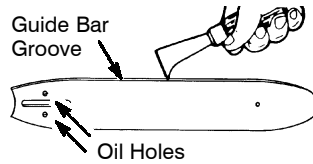

CHAIN SHARPENING

Chain sharpening is a complicated task that requires special tools. We recommend you refer chain sharpening to a professional chain sharpener.

IGNITION TIMING

Ignition timing is fixed and nonadjustable.

SPARK PLUG

Replace the spark plug yearly.

STORAGE

WARNING: Stop engine and allow to cool, and secure the unit before storing or transporting in a vehicle. Store unit and fuel in an area where fuel vapors cannot reach sparks or open flames from water heaters, electric motors or switches, furnaces, etc. Store unit with all guards in place. Position so that any sharp object cannot accidentally cause injury to passersby. Store the unit out of reach of children.

- Before storing, drain all fuel from the unit. Start engine and allow to run until it stops.
- Clean the unit before storing. Pay particular attention to the air intake area, keeping it free of debris. Use a mild detergent and sponge to clean the plastic surfaces.
- Do not store the unit or fuel in a closed area where fuel vapors can reach sparks or an open flame from hot water heaters, electric motors or switches, furnaces, etc.
- Store in a dry area out of the reach of children.

CAUTION: It is important to prevent gum deposits from forming in essential fuel system parts such as the carburetor, fuel filter, fuel hose, or fuel tank during storage. Alcohol blended fuels (called gasohol or using ethanol or methanol) can attract moisture which leads to fuel mixture separation and formation of acids during storage. Acidic gas can damage the engine.

TROUBLESHOOTING

Engine will not start.

- Ignition switch off.
- Engine flooded.
- Fuel tank empty.
- Spark plug not firing.
- Fuel not reaching carburetor.

Engine will not idle properly.

- Carburetor requires adjustment.
- Crankshaft seals worn.

Engine will not accelerate, lacks power, or dies under a load.

- Air filter dirty.
- Spark plug fouled.
- Carburetor requires adjustment.

Engine smokes excessively.

- Too much oil mixed with gasoline

NEED ASSISTANCE?

Need Assistance?

Call 1-800-554-6723.

Need Service Parts?

Contact your dealer or call 1-800-554-6723.

LIMITED WARRANTY

ELECTROLUX HOME PRODUCTS NORTH AMERICA, Division of WCI Outdoor Products, Inc. warrants to the original purchaser that each new Poulan or Poulan Pro brand gasoline chain saw is free from defects in material and workmanship and agrees to repair or replace under this warranty any defective gasoline chain saw as follows from the original date of purchase.

1 YEAR – Parts and Labor, when used for Household purposes.

90 DAYS – Parts and Labor, when used for Commercial, Professional, or Income Producing purposes.

30 DAYS – Parts and Labor, if used for rental purposes.

This warranty **is not** transferable and **does not** cover damage or liability caused by improper handling, improper maintenance, or the use of accessories and/or attachments not specifically recommended by **ELECTROLUX HOME PRODUCTS NORTH AMERICA** for this chain saw. Additionally, this warranty **does not** cover damage caused by improper handling, improper maintenance, or if the saw is altered in any way which in our judgement affects its condition or operation. This warranty does not cover tune-up, spark plugs, filters, starter ropes, starter springs, chain sharpening, bars, chains, and other parts which wear and require replacement with reasonable use during the warranty

period. This warranty **does not** cover pre-delivery set-up, installation of guide bar and chain, and normal adjustments explained in the operator's manual such as carburetor adjustments and chain tension adjustments. This warranty **does not** cover transportation costs.

THIS WARRANTY GIVES YOU SPECIFIC LEGAL RIGHTS, AND YOU MAY HAVE OTHER RIGHTS WHICH VARY FROM STATE TO STATE.

NO CLAIMS FOR CONSEQUENTIAL OR OTHER DAMAGES WILL BE ALLOWED, AND THERE ARE NO OTHER EXPRESS WARRANTIES EXCEPT THOSE EXPRESSLY STIPULATED HEREIN.

SOME STATES DO NOT ALLOW LIMITATIONS ON HOW LONG AN IMPLIED WARRANTY LASTS OR THE EXCLUSION OR LIMITATIONS OF INCIDENTAL OR CONSEQUENTIAL DAMAGES, SO THE ABOVE LIMITATIONS OR EXCLUSION MAY NOT APPLY TO YOU.

ELECTROLUX HOME PRODUCTS NORTH AMERICA'S policy is to continuously improve its products. Therefore, **ELECTROLUX HOME PRODUCTS NORTH AMERICA** reserves the right to change, modify, or discontinue models, designs, specifications, and accessories of all products at any time without notice or obligation to any purchaser.

U.S. EPA EMISSION CONTROL WARRANTY STATEMENT

YOUR WARRANTY RIGHTS AND OBLIGATIONS: The U. S. Environmental Protection Agency and **POULAN/WEED EATER, DIVISION OF WCI OUTDOOR PRODUCTS** are pleased to explain the emissions control system warranty on your lawn and garden equipment engine. All new utility and lawn and garden equipment engines must be designed, built, and equipped to meet the stringent anti-smog standards. **POULAN/WEED EATER** must warrant the emission control system on your lawn and garden equipment engine for the periods of time listed below provided there has been no abuse, neglect, or improper maintenance of your lawn and garden equipment engine. Your emission control system includes parts such as the carburetor and the ignition system. Where a warrantable condition exists, **POULAN/WEED EATER** will repair your lawn and garden equipment engine at no cost to you. Expenses covered under warranty include diagnosis, parts and labor. **MANUFACTURER'S WARRANTY COVERAGE:** If any emissions related part on your engine (as listed under Emissions Control Warranty Parts List) is defective or a defect in the materials or workmanship of the engine causes the failure of such an emission related part, the part will be repaired or replaced by

POULAN/WEED EATER. OWNER'S WARRANTY RESPONSIBILITIES: As the lawn and garden equipment engine owner, you are responsible for the performance of the required maintenance listed in your Owner's Manual. **POULAN/WEED EATER** recommends that you retain all receipts covering maintenance on your lawn and garden equipment engine, but **POULAN/WEED EATER** cannot deny warranty solely for the lack of receipts or for your failure to ensure the performance of all scheduled maintenance. As the lawn and garden equipment engine owner, you should be aware that **POULAN/WEED EATER** may deny you warranty coverage if your lawn and garden equipment engine or a part of it has failed due to abuse, neglect, improper maintenance, unapproved modifications, or the use of parts not made or approved by the original equipment manufacturer. You are responsible for presenting your lawn and garden equipment engine to a **POULAN/WEED EATER** authorized repair center as soon as a problem exists. Warranty repairs should be completed in a reasonable amount of time, not to exceed 30 days. If you have any questions regarding your warranty rights and responsibilities, you should contact your nearest authorized service center or call **POULAN/WEED EATER** at 1-800-554-6723. **WARRANTY COMMENCEMENT DATE:** The warranty period begins on the date the lawn and garden equipment engine is purchased. **LENGTH OF COVERAGE:** This warranty shall be for a period of two years from the initial date of purchase. **WHAT IS COVERED: REPAIR OR REPLACEMENT OF PARTS.** Repair or replacement of any warranted part will be performed at no charge to the owner at an approved **POULAN/WEED EATER** servicing center. If you have any questions regarding your warranty rights and responsibilities, you should contact your nearest authorized service center or call **POULAN/WEED EATER** at 1-800-554-6723. **WARRANTY PERIOD:** Any warranted part which is not scheduled for replacement as required maintenance, or which is scheduled

only for regular inspection to the effect of "repair or replace as necessary" shall be warranted for 2 years. Any warranted part which is scheduled for replacement as required maintenance shall be warranted for the period of time up to the first scheduled replacement point for that part. **DIAGNOSIS:** The owner shall not be charged for diagnostic labor which leads to the determination that a warranted part is defective if the diagnostic work is performed at an approved **POULAN/WEED EATER** servicing center. **CONSEQUENTIAL DAMAGES:** **POULAN/WEED EATER** may be liable for damages to other engine components caused by the failure of a warranted part still under warranty. **WHAT IS NOT COVERED:** All failures caused by abuse, neglect, or improper maintenance are not covered. **ADD-ON OR MODIFIED PARTS:** The use of add-on or modified parts can be grounds for disallowing a warranty claim. **POULAN/WEED EATER** is not liable to cover failures of warranted parts caused by the use of add-on or modified parts. **HOW TO FILE A CLAIM:** If you have any questions regarding your warranty rights and responsibilities, you should contact your nearest authorized service center or call **POULAN/WEED EATER** at 1-800-554-6723. **WHERE TO GET WARRANTY SERVICE:** Warranty services or repairs shall be provided at all **POULAN/WEED EATER** service centers. call: 1-800-554-6723. **MAINTENANCE, REPLACEMENT AND REPAIR OF EMISSION RELATED PARTS:** Any **POULAN/WEED EATER** approved replacement part used in the performance of any warranty maintenance or repair on emission related parts will be provided without charge to the owner if the part is under warranty. **EMISSION CONTROL WARRANTY PARTS LIST:** Carburetor, Ignition System: Spark Plug (covered up to maintenance schedule), Ignition Module. **MAINTENANCE STATEMENT:** The owner is responsible for the performance of all required maintenance as defined in the owner's manual.