



Marine Remote Commander System

MC20

- Operating Instructions
Please read before using this equipment.

ALPINE ELECTRONICS MARKETING, INC.

1-1-8 Nishi Gotanda
Shinagawa-ku
Tokyo 141-0031, Japan
Phone 03-5496-8231

ALPINE ELECTRONICS OF AMERICA, INC.

19145 Gramercy Place
Torrance, California 90501 U.S.A.
Phone 1-800-ALPINE-1 (1-800-257-4631)

ALPINE ELECTRONICS OF CANADA, INC.

777 Supertest Road Toronto
Ontario M3J 2M9, Canada
Phone 1-800-ALPINE-1 (1-800-257-4631)

ALPINE ELECTRONICS OF AUSTRALIA PTY, LTD.

161-165 Princess Highway, Hallam
Victoria 3803, Australia
Phone 03-8787-1200

ALPINE ELECTRONICS GmbH

Wilhelm-Wagenfeld-Str. 1-3 80807 München, Germany
Phone 089-32 42 640

ALPINE ELECTRONICS OF U.K., LTD.

ALPINE House
Fletchamstead Highway, Coventry CV4 9TW, U.K.
Phone 0870-33 33 763

ALPINE ELECTRONICS FRANCE S.A.R.L.

(RCS PONTOISE B 338 101 280)
98, Rue de la Belle Etoile, Z.I. paris Nord II,
B.P. 50016, 95945 Roissy Charles de Gaulle
Cedex, France
Phone 01-48638989

ALPINE ITALIA S.p.A.

Viale C. Colombo 8, 20090 Trezzano
Sul Naviglio (MI), Italy
Phone 02-484781

ALPINE ELECTRONICS DE ESPAÑA, S.A.

Portal de Gamarra 36, Pabellón, 32
01013 Vitoria (Alava)-APDO 133, Spain
Phone 945-283588

ALPINE ELECTRONICS (BENELUX) GmbH

Leuvensesteenweg 510-B6,
1930 Zaventem, Belgium
Phone 02-725 1315

Operating Instructions

WARNING

WARNING

This symbol means important instructions. Failure to heed them can result in serious injury or death.

DO NOT OPERATE ANY FUNCTION THAT TAKES YOUR ATTENTION AWAY FROM SAFELY DRIVING YOUR BOAT.

Any function that requires your prolonged attention should only be performed after coming to a complete stop. Always stop the boat in a safe location before performing these functions. Failure to do so may result in an accident.

KEEP THE VOLUME AT LEVEL WHERE YOU CAN STILL HEAR OUTSIDE NOISES WHILE DRIVING.

Excessive volume levels that obscure sounds such as emergency vessel sirens or approaching vessels can be dangerous and may result in an accident. LISTENING AT LOUD VOLUME LEVELS IN A BOAT MAY ALSO CAUSE HEARING DAMAGE.

MINIMIZE DISPLAY VIEWING WHILE DRIVING.

Viewing the display may distract the driver from looking ahead of the boat and cause an accident.

DO NOT DISASSEMBLE OR ALTER.

Doing so may result in an accident, fire or electric shock.

DO NOT CONNECT A POWER SUPPLY OTHER THAN A DC 12V NEGATIVE GROUND TYPE.

Failure to do so may result in accident or fire.

KEEP SMALL OBJECTS SUCH AS BOLTS OR SCREWS OUT OF THE REACH OF CHILDREN.

Swallowing them may result in serious injury. If swallowed, consult a physician immediately.

USE THE CORRECT AMPERE RATING WHEN REPLACING FUSES.

Failure to do so may result in fire or electric shock.

USE THIS PRODUCT FOR MOBILE 12V APPLICATIONS.

Use for other than its designed application may result in fire, electric shock or other injury.

CAUTION

This symbol means important instructions. Failure to heed them can result in injury or material property damage.

HALT USE IMMEDIATELY IF A PROBLEM APPEARS.

Failure to do so may cause personal injury or damage to the product. Return it to your authorized Alpine dealer or the nearest Alpine Service Center for replacing.

PRECAUTIONS

Product Cleaning

Use a soft dry cloth for periodic cleaning of the product. For more severe stains, please dampen the cloth with water only. Anything else has the chance of dissolving the paint or damaging the plastic.

Temperature

Be sure the temperature inside boat is between +60°C (+140°F) and -10°C (+14°F) before turning your unit on.

Maintenance

If you have problems, do not attempt to repair the unit yourself. Return it to your Alpine dealer or the nearest Alpine Service Station for servicing.

FCC COMPLIANCE STATEMENT

Operation is subject to the following two conditions:

- (1) This device may not cause harmful interference, and
- (2) This device must accept any interference received, including interference that may cause undesired operation.

Changes or modifications not expressly approved by the party responsible for compliance could void the user's authority to operate the equipment.

Basic Operation

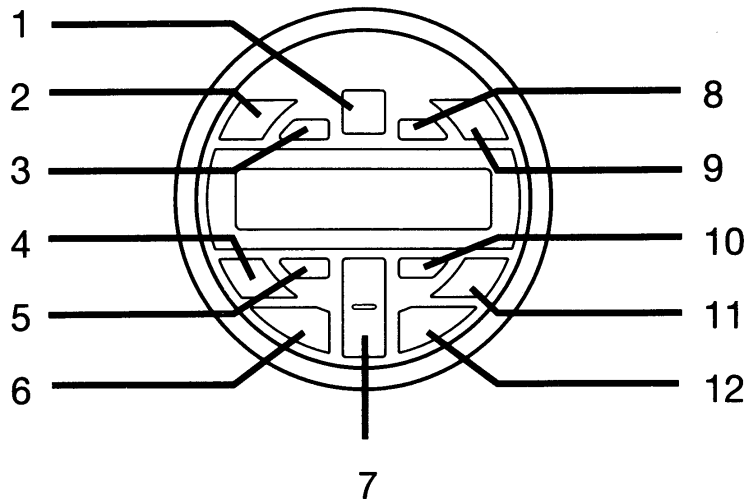

- | | |
|---------------------|-----------------------------|
| 1. Source and Power | 7. Volume Up/Down |
| 2. Play/Pause | 8. Subw. Level/Control Mode |
| 3. Mute/Mute Zone | 9. Band/Volume Zone |
| 4. Track Down | 10. Direct Up |
| 5. Direct Down | 11. Track Up |
| 6. Search/Enter | 12. Return/Escape |

Installation

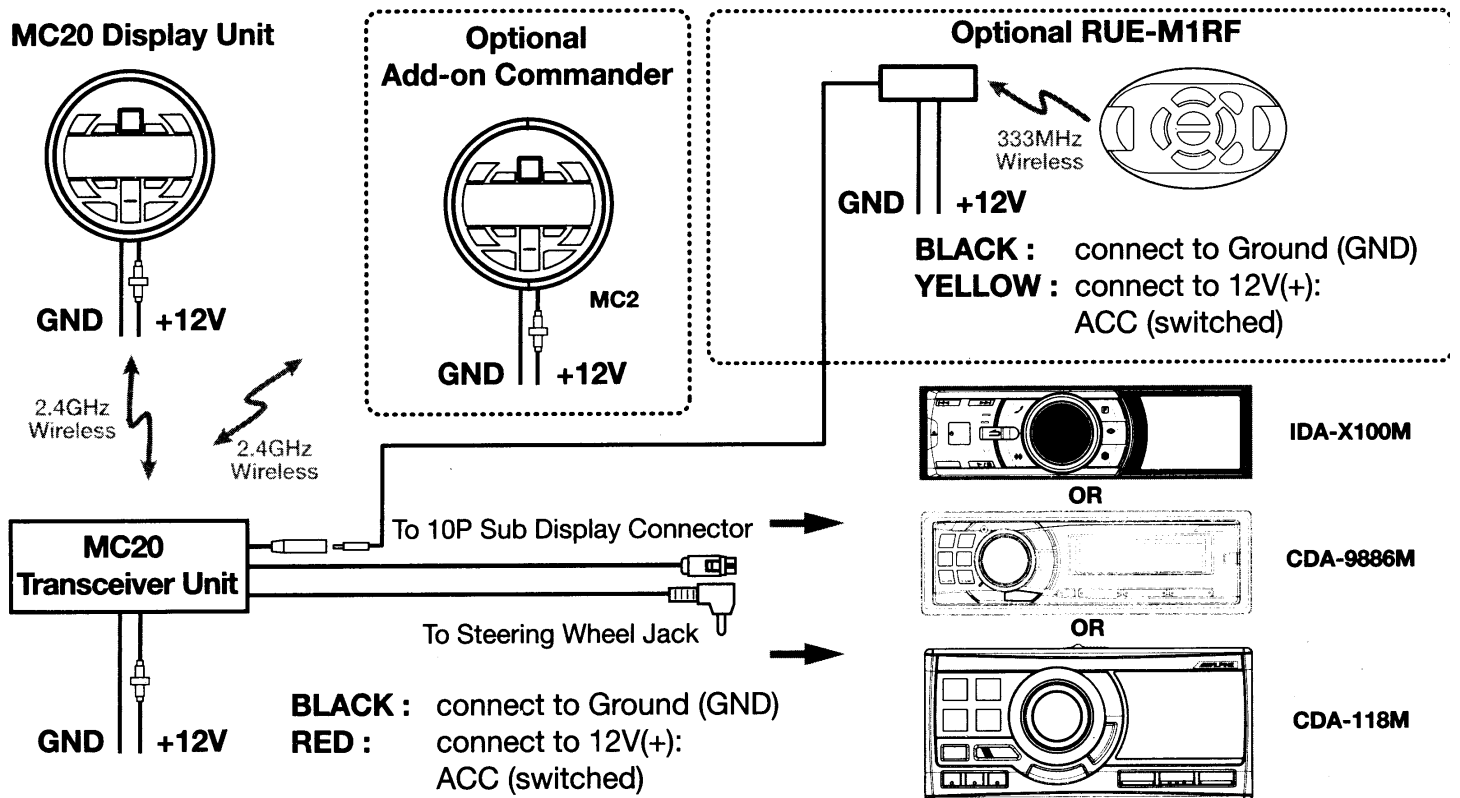

Program Menu

Enter Program Mode

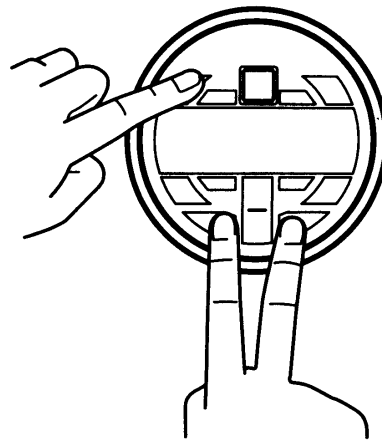
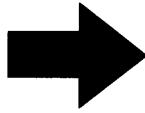

MC20
Display unit

Program Menu Options

1. ID NUMBER This is the serial number of the display unit.
* Range of serial numbers: 00001 to 99999

2. RF STRENGTH Signal strength between a display unit and the closest display or
transceiver unit in the MC20 wireless system
* Range of strength: [... to]

3. SIGNAL STATUS Wireless signal connection status between a display unit and the
transceiver unit
* Values: [CONNECTED, NO CONNECT]

4. CONTRAST Sets brightness or dimness of LCD display characters
* Values: [5, 4, **3**, 2, 1, 0]

5. BL DISPLAY Turns LCD backlighting **ON** or OFF

6. BL KEYPAD Turns keypad button backlighting **ON** or OFF

7. TEMPERATURE Sets temperature scale to **DEGREES F** or DEGREES C

8. RESET MC2 Menu selection for pairing or re-pairing any MC2 or MC20
display units with any existing MC20 system.
RESET MC2 also restores factory default setting

* Note: Bold indicates default menu selection for this program menu option

Program Mode Example

1. Enter Program Mode

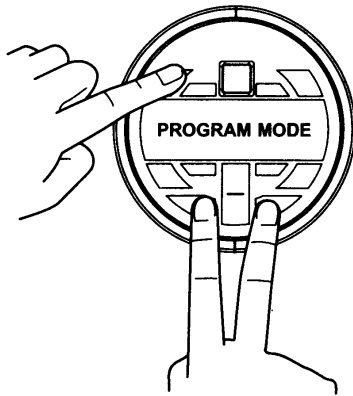

4. Press **VOL +** or **VOL -** to adjust the current **CONTRAST** value

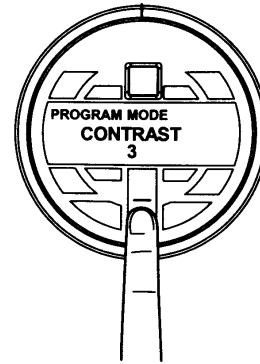

2. Press **VOL +** or **VOL -** until **CONTRAST** shows on top line of display

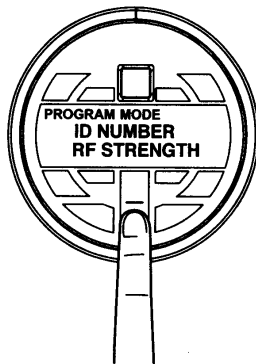

5. Press **ENT** to save new **CONTRAST** value

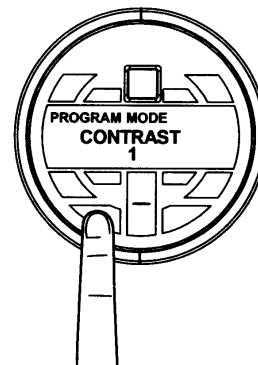

3. Press **ENT** to program new **CONTRAST** value

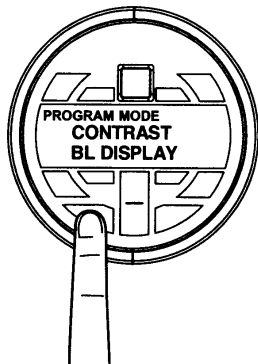

6. Press **ESC** to exit Program Mode

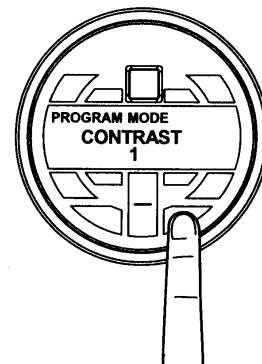

MC2 Add-on Commander Pairing Procedure

1. Power on existing MC20 system
2. Connect power and ground wires of MC2 add-on commander (see Installation)
3. MC2 add-on commander display will turn on and automatically go to the pairing screen in the program menu with ADD MC2 showing on the display

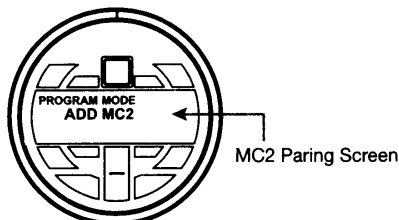

4. On marine radio, select FM Tuner as source (make sure that tuner seek mode is DX or LOCAL , not MANUAL)
5. Found Radio will appear on the display below ADD MC2 when add-on commander is ready to pair with MC20 system *



6. On marine radio, press **SEEK UP** (**▶▶**) once
7. **PRESS ENTER** will appear below ADD MC2 on the display



8. Press **ENT** to finish pairing operation and save new settings
9. Press **ESC** to exit Program Menu
10. Turn off the existing MC20 system, then turn it back on. Pairing procedure is now completed.

*If Found Radio does not appear on the display, MC2 location may be out of MC20 system range (typical ~ 40 feet/12 m)

Example Systems

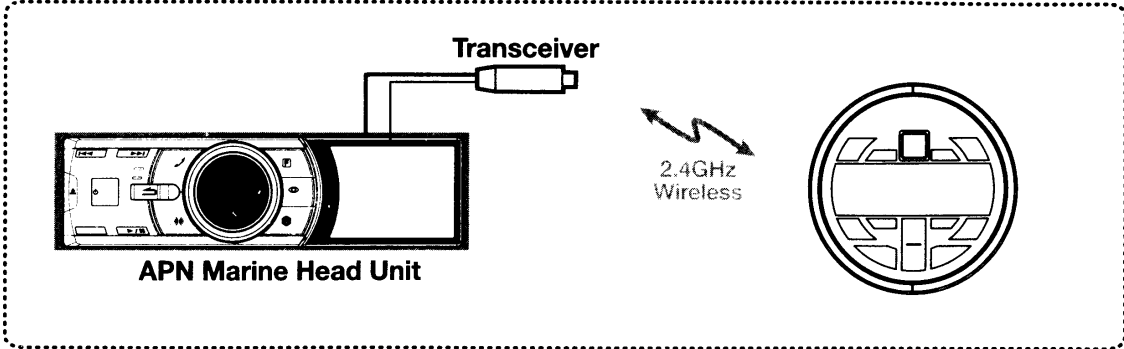

MC20 Marine Commander System

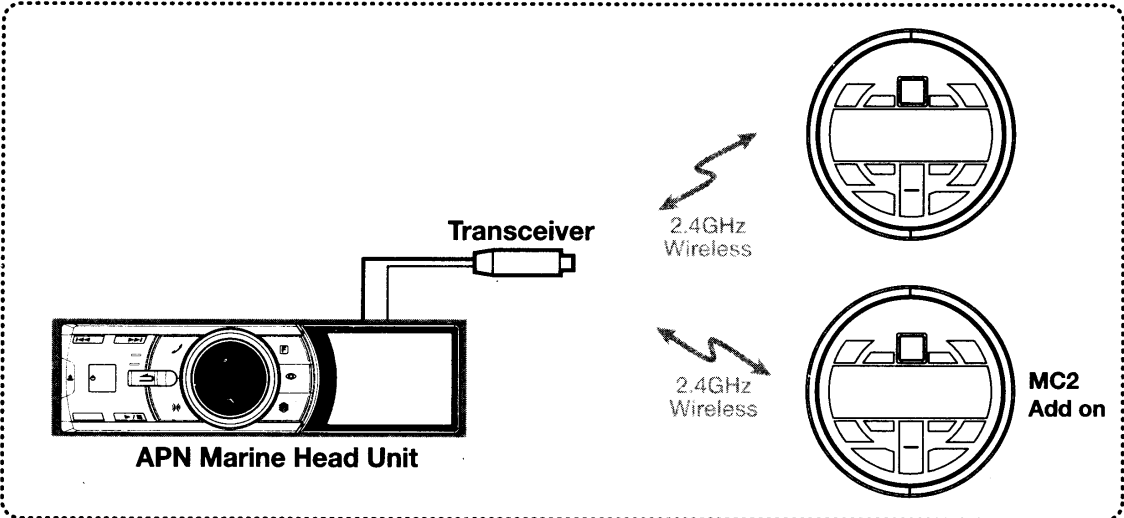

MC20 Marine Commander System with MC2 Add on Commander

MC20 Display Unit Re-Pairing Procedure

* To pair an MC20 display unit with a different MC20 system than the one it was purchased with (just like adding an MC2 Commander) follow the instructions below:

1. Power on the MC20 system that you want to add the additional MC20 display unit to
2. Connect power and ground wires of new MC20 display unit
3. Wait at least 20 seconds, then enter the Program Menu (see Program Menu Example)
4. Go to the RESET MC2 option, then press ENT button
5. MC20 display unit will reset itself (including factory default settings) and display will show ADD MC2 like in step 3 of the previous section (MC2 Add-on Commander Pairing Procedure)
6. Follow the remaining steps of the previous section to complete this operation

Dual Zone Volume and Mute Control

Volume Control

1. Press and hold the VOLUME ZONE button to change zones

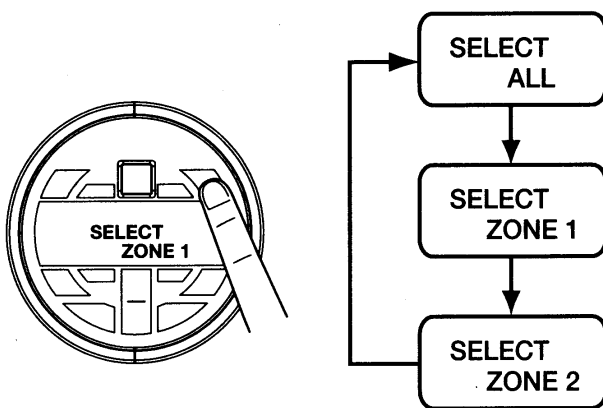

2. After zone is selected, use the volume \wedge or \vee buttons to adjust the volume level

Mute Control

1. Press and hold the MUTE button to select the mute zone(s)

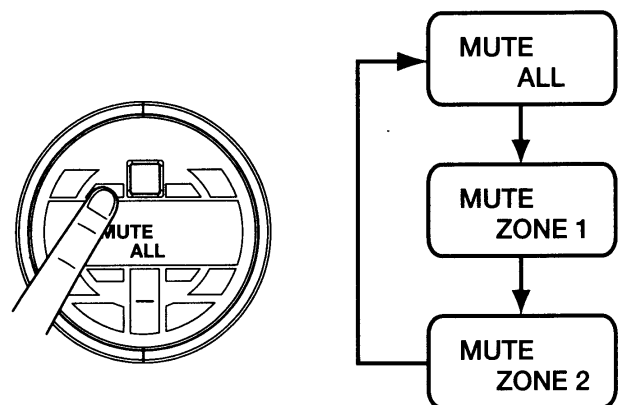

2. After mute zone is selected, press the MUTE button again momentarily to mute the selected zone(s)