Plug-in hybrid electric cars:

Market development, technical analysis and CO₂ emission scenarios for Germany

Study on behalf of the German Federal Ministry for the Environment,
Nature Conservation and Nuclear Safety

Julius Jöhrens, Dominik Räder, Jan Kräck | ifeu – Institute for Energy and Environmental Research Heidelberg
Lucien Mathieu | Transport & Environment
Ruth Blanck, Peter Kasten | Öko-Institut e.V.

Heidelberg / Brussels / Berlin, September 2020



Content

Executive Summary	4
Executive Summary (German)	8
Figures	12
Abbreviations	15
1 Introduction, Goal & Scope	16
2 Overview of PHEV technology	17
2.1 Vehicle Configurations	17
2.2 Operating Modes	19
3 Regulatory Situation	20
3.1 Test cycle emissions (WLTP)	20
3.2 European CO ₂ fleet emission targets	21
3.3 German National Regulation affecting PHEV	22
4 Market Situation	24
4.1 Number of registrations and vehicle stock	24
4.2 Availability of vehicle models	27
4.3 Vehicle mass and power	30
4.4 Range, energy consumption and CO ₂ emissions	36
4.5 Vehicle list prices	40
5 Real-world Energy Consumption of PHEV	41
5.1 Real-world specific energy consumption	41
5.2 Real-world utility factors	47
5.3 Sensitivities of Energy Consumption	51
5.4 Average energy consumption estimates per vehicle segment	57
6 Evolution of PHEV technology, market and utilization until 2030	61
6.1 Model availability and production forecast	61
6.2 Evolution of technical vehicle parameters	63
6.3 Vehicle Utilization and specific energy consumption	65
7 Scenario analysis of PHEV CO₂ emissions until 2030	69
7.1 Overview over scenario assumptions	69
7.2 New registrations	70
7.3 Vehicle stock and mileage	71
7.4 CO ₂ emissions	72

Inhalt

8	Alternative scenarios without PHEVs	75
8.1	Scenario assumptions	75
8.1.1	CO ₂ emissions of equivalent ICE cars	75
8.1.2	Share of petrol and diesel cars of total ICE registrations	78
8.1.3	Yearly mileage of petrol, diesel, and BEV cars	78
8.2	New registrations	79
8.3	CO ₂ emissions	80
8.4	Discussion	82
9	Approaches for Regulatory Measures	83
9.1	Reduce gap between real world and WLTP	84
9.2	Restrict incentives and subsidies to low-emission PHEVs	86
9.3	Incentivize reasonable charging behaviour	87
9.4	Set requirements for Operation modes	90
9.5	Increase transparency	91
	References	92

Executive Summary

This study examines the deviation of real-world CO₂ emissions of plug-in hybrid vehicles (PHEVs) from type-approval values, the driving factors of these deviations, and implications for achieving the German climate protection targets for transport by 2030. Following a comprehensive market analysis, the energy consumption for typical vehicle configurations under various conditions is calculated using a vehicle simulation model. Using the model results, the expected real-world tailpipe emissions for the PHEV fleet up to the year 2030 are determined. The main findings of the study are presented below.

The market share of plug-in hybrids has been increasing significantly since the beginning of 2020. Motorization and weight of PHEVs are above average for new passenger vehicles.

- The number of new PHEV registrations in Germany is currently growing at a fast pace. The market share was on average 4.1 % in the first half of 2020, and increased substantially with 10.5 % of new registrations until November 2020. At around 80 %, the share of commercial vehicles among new registrations (many of them company cars) is significantly higher than the average for the new car fleet (65%).
- Newly registered PHEVs increasingly belong to the upper vehicle segments and are heavier than average (+ 37% average vehicle mass for PHEVs compared to the weighted average of gasoline and diesel vehicles). The combined power output (system power) is even higher (+ 83 % for PHEVs compared to combustion vehicles).

High real-world consumption of plug-in hybrids is both due to the design of the vehicles and to the charging and driving behavior of their users.

- A recent study by Fraunhofer ISI and ICCT that has been conducted parallel to this project discovered a gap between specific fuel consumption determined in real-world operation and NEDC type-approval values in the range of 100 % to 600 %¹. Hence, real-world CO₂ emissions from the German PHEV fleet are severely underestimated at present. The switch to the WLTP method will only marginally reduce this discrepancy. The main reason for the discrepancy is that in real life, vehicles are driven much more frequently using their combustion engine and much less in electric mode than assumed in the type approval. For PHEV company cars with an electric range of 50 km according to WLTP, an electric driving share of only about 15% on average was observed. For private vehicles, the electric driving shares are higher (about 50 % in the example), but still well below the value of about 75 % assumed in WLTP. These results were considered in the scenario calculation described later on.
- Low electric driving shares in real-world operation are induced by lack of charging infrastructure at the vehicles' parking locations and a lack of economic incentives for users to charge them. However, especially in the case of company cars, high mileage and trip

¹ Plötz, P.; Moll, C.; Mock, P.; Bieker, G.; Li, Y.; Gasmi, J.; El-Deeb, A. (2020): Real-world usage of plug-in hybrid electric vehicles - Fuel consumption, electric driving, and CO₂ emissions. Karlsruhe, Berlin, Washington: Fraunhofer Institute for System and Innovation research ISI, International Council of Clean Transportation ICCT

length typically limit the maximum achievable electric driving share regardless of charging discipline.

- The real-world electric range is on average around 30 % below the WLTP values. Real-world specific consumption in electric mode and in internal combustion engine mode is often significantly higher than according to the WLTP method.
- The potential power output of the electric motor in today's PHEVs is significantly lower than that of the combustion engine. On average, only around 30% of the maximum system output is attributable to the electric motor. As a result, PHEVs often activate the combustion engine in dynamic driving situations, although the charge level of the battery would not require it. Additionally, a comparatively weak electric motor may recuperate less energy when braking, which can increase overall energy consumption compared to systems with more powerful electric motors.
- The user's choice of PHEV operating mode can have a significant impact on fuel consumption, especially in very demanding driving patterns. The combustion engine kicks in frequently when the user chooses operating modes optimized for performance in order to achieve higher accelerations or speeds. Additionally, in some driving modes the batteries are charged by the internal combustion engine, which can lead to high real-world consumption. However, based on the available data, it is not possible to quantify the additional consumption from an unfavourable choice of operating mode.

If the framework conditions remain unchanged, additional annual tailpipe emissions (TtW) from PHEVs of up to 4.3 million metric tons of CO₂ in 2030 are possible compared with the scenarios of the German climate protection program for the year 2030.

- Until 2030, the system power of PHEVs is expected to further increase by an average of 10%. The internal combustion engine's share of system power is expected to decline by a few percentages, but will remain to be the dominant component of system power. Battery size is expected to increase by 20% by 2030, but due to the increase in vehicle mass the all-electric range is expected to increase less than the battery capacity.
- Based on market data of planned production capacities and the requirements of the CO₂ fleet target values, the scenario analysis carried out in this study assumes 2.6 million PHEVs registered in Germany in 2030. Since many company cars are sold to private owners after some years, around one in four vehicles of the 2030 PHEV fleet will be a company car.
- If private owners will charge their PHEVs every day by then, real-world CO₂ emissions would only slightly exceed WLTP values for this vehicle group. For company cars, real-world emissions would still be twice as high compared to the WLTP values even with daily charging due to the high mileage and average trip length of those vehicles. In contrast, if the current charging behaviour continues, the average tailpipe emissions for the PHEV fleet in 2030 will be 130 g/km (factor of 2.8 compared to WLTP), and 172 g/km for company cars (factor 3.7 compared to WLTP).

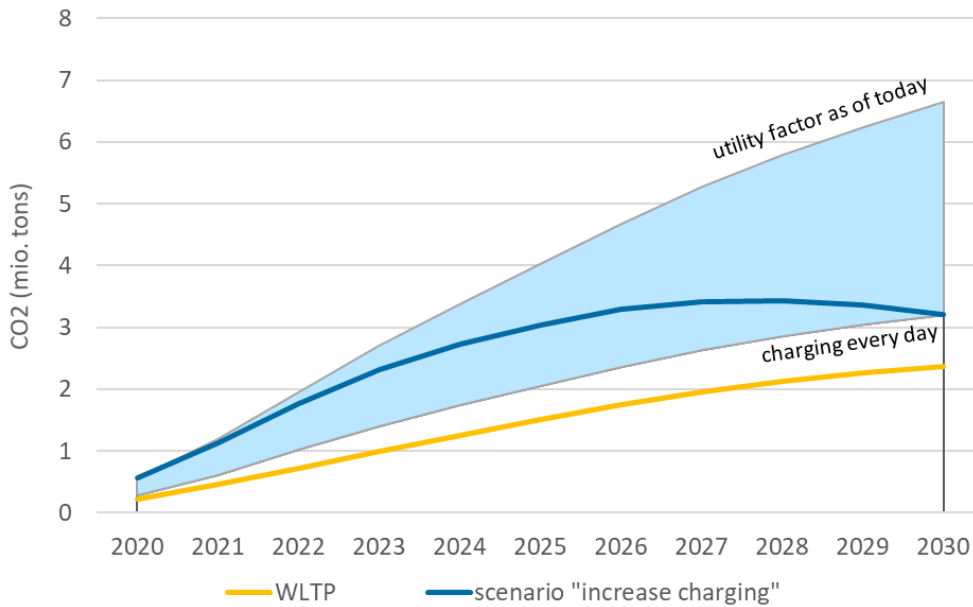

Annual tailpipe CO₂ emissions from PHEV in Germany in the timeframe 2020-2030 based on WLTP assumptions (yellow) and different real-world charging assumptions (blue).

- Assuming the WLTP values, the German PHEV passenger car fleet will emit 2.4 million metric tons of CO₂ in 2030. On the other hand, if electric driving shares remain as low as with today's PHEVs, this is expected to result in additional emissions of 4.3 million tons (6.7 Mt in total). If daily charging gradually becomes standard practice by 2030, the additional emissions compared with WLTP will be around 0.8 Mt (3.2 Mt in total).

Under given EU CO₂ standards, national subsidy instruments for plug-in hybrids can lead to additional CO₂ emissions.

Passenger cars with a large gap between the test cycle (WLTP) and real-world CO₂ emissions reduce the impact of EU passenger car CO₂ standards, as those only regulate test cycle emissions, not real-world emissions. Currently, this gap is particularly high for plug-in hybrids. Indeed, this is the reason why additional promotion of such vehicles through national policies – under given CO₂ standards - ultimately leads to an increase in passenger car fleet CO₂ emissions (if not at the national level, then at least at the EU level). This is especially accurate for the use of PHEVs as company cars, as they currently account for the lowest electric driving shares, whilst being most privileged.

In order to ensure a contribution of plug-in hybrids to CO₂ mitigation in the transport sector, the policy framework in Germany has to be adjusted.

The results of this study pose a considerable threat to compliance with German climate protection targets in the transport sector if the number of PHEVs continues to grow rapidly without a significant increase in the real-world share of electric driving. Hence, the following starting points for regulatory adjustments should be considered:

- Further develop the type approval process to significantly reduce the gap to real-world emissions. Data from on-board fuel consumption metering (OBFCM) should be used as soon as possible.
- Restrict government subsidies for PHEVs to situations with demonstrably low real-world CO₂ emissions.
- Ensure economic and practical incentives for PHEV users to charge frequently.
- Set requirements for the design of PHEVs and their operating modes, e.g. require a minimum all-electric range significantly above the current average.
- Implement measures to increase transparency on real-world consumption for users, academia, and policymakers.

In view of the grave doubts about the environmental benefits of currently approved PHEVs, the first step should be to suspend or fundamentally revise the current subsidies (in particular the purchase premium and the tax benefits for company car users) and to conduct in-depth scientific studies on the real-world emissions of PHEVs, e.g. using OBFCM data.

Executive Summary (German)

Im Zentrum der vorliegenden Untersuchung stand die Frage, in welchem Maße die realen CO₂-Emissionen von Plug-in-Hybridfahrzeugen (PHEV) im Betrieb von den Normwerten abweichen, von welchen Faktoren diese Abweichungen abhängen und welche Relevanz dies für die Erreichung der Klimaschutzziele im Verkehr bis 2030 hat. Neben einer umfangreichen Marktanalyse wurde der Energieverbrauch für typische Fahrzeugauslegungen unter verschiedenen Bedingungen modelliert. Mithilfe der ermittelten Verbrauchswerte wurden die zu erwartenden Realemissionen (tailpipe) für die PHEV-Flotte bis zum Jahr 2030 bestimmt. Nachfolgend sind die wesentlichen Erkenntnisse der Untersuchung dargestellt.

Der Marktanteil von Plug-In-Hybriden nimmt seit Anfang 2020 deutlich zu. Motorisierung und Gewicht von PHEVs sind überdurchschnittlich.

- Die Anzahl der PHEV-Neuzulassungen in Deutschland wächst gegenwärtig in hohem Tempo. Der Marktanteil lag in der ersten Hälfte des Jahres 2020 im Mittel bei 4,1%, im November hatten PHEV bereits einen Anteil von 10,5 % an den Neuzulassungen. Der Anteil gewerblicher Neuzulassungen (viele davon Dienstwagen) liegt mit rund 80% deutlich höher als im Durchschnitt der Neuwagenflotte (65%).
- Neu zugelassene PHEV gehören dabei zunehmend den oberen Fahrzeugsegmenten an und sind überdurchschnittlich schwer (+ 37 % mittlere Fahrzeugmasse bei PHEV gegenüber dem gewichteten Mittel aus Benzinern und Dieseln). Die Motorisierung (Systemleistung) ist auch im Vergleich zum Gewicht überdurchschnittlich (+ 83 % bei PHEV gegenüber Verbrennungsfahrzeugen).

Hohe Realverbräuche von Plug-In-Hybriden sind sowohl auf die Auslegung der Fahrzeuge als auch auf das Lade- und Fahrverhalten der Nutzer zurückzuführen.

- Die in realitätsnahen Testverfahren (z.B. ADAC EcoTest) sowie im Realbetrieb ermittelten spezifischen Kraftstoffverbräuche liegen nach Ergebnissen einer parallel zu diesem Vorhaben durchgeführten Untersuchung des Fraunhofer ISI und des ICCT¹ derzeit typischerweise um ein Mehrfaches (um 100 % bis hin zu 600 %) über den Werten nach Typgenehmigung (NEFZ), die für die in 2020/2021 zu erreichenden CO₂-Flottenzielwerte maßgeblich sind. Die Umstellung auf das WLTP-Verfahren wird diese Diskrepanz nur geringfügig reduzieren.

Hauptgrund für die genannte Abweichung ist, dass die Fahrzeuge real viel häufiger mit Verbrennungsmotor und viel weniger elektrisch fahren als bei der Typgenehmigung angenommen. Insbesondere bei Dienstwagen wurden beispielsweise für PHEV mit einer elektrischen Reichweite von 50 km nach WLTP im Mittel nur ein elektrischer Fahranteil von etwa 15 % beobachtet. Bei Privatfahrzeugen sind die elektrischen Fahranteile zwar

¹ Plötz, P.; Moll, C.; Mock, P.; Bieker, G.; Li, Y.; Gasmi, J.; El-Deeb, A. (2020): Real-world usage of plug-in hybrid electric vehicles - Fuel consumption, electric driving, and CO₂ emissions. Karlsruhe, Berlin, Washington: Fraunhofer Institute for System and Innovation research ISI, International Council of Clean Transportation ICCT

höher (im Beispiel etwa 50 %), aber immer noch deutlich unterhalb des im WLTP angenommenen Werts von etwa 75 %.

- Ursachen für niedrige elektrische Fahranteile in der Praxis können fehlende Ladeinfrastruktur an den Standorten der Fahrzeuge sowie fehlende wirtschaftliche Anreize für die Nutzer zum Laden sein. Vor allem bei Dienstwagen spielt allerdings auch die oftmals hohe Fahrleistung und Fahrlänge eine wichtige Rolle, die auch bei großer Ladedisziplin den erzielbaren elektrischen Fahranteil begrenzt.
- Die im rein elektrischen Modus erzielte Reichweite liegt in der Realität um durchschnittlich etwa 30 % unterhalb der WLTP-Werte. Die spezifischen Verbräuche im elektrischen Betrieb sowie auch im verbrennungsmotorischen Betrieb liegen real oftmals signifikant höher als nach WLTP-Verfahren.
- Die mögliche Leistungsabgabe des E-Motors ist bei heutigen PHEV deutlich geringer als die des Verbrenners. Nur etwa 30% der maximalen Systemleistung gehen im Mittel auf den E-Motor zurück. Infolgedessen wird der Verbrennungsmotor oftmals in dynamischen Fahrsituationen zusätzlich aktiviert, auch wenn dies aufgrund des Ladestands der Batterie nicht notwendig wäre. Auch kann ein vergleichsweise schwacher E-Motor beim Bremsen weniger Energie rekuperieren, wodurch sich der gesamte Energieverbrauch gegenüber Systemen mit stärkeren E-Motoren erhöhen kann.
- Vor allem bei sehr dynamischen Fahrmustern kann die Wahl des PHEV-Betriebsmodus durch den Nutzer einen erheblichen Einfluss auf den Kraftstoffverbrauch haben. Hier wird der Verbrenner in auf Leistung optimierten Betriebsmodi oftmals hinzugezogen, um höhere Beschleunigungen oder Geschwindigkeiten zu erreichen. Zudem können Fahrmodi gewählt werden, bei denen die Batterien verbrennungsmotorisch geladen werden, was zu sehr hohem Realverbrauch führen kann. Welche Zusatzverbräuche sich in der Praxis durch verbrauchstechnisch ungünstige Wahl des Betriebsmodus ergeben, kann auf Grundlage der verfügbaren Daten allerdings nicht beantwortet werden.

Bei gleichbleibenden Rahmenbedingungen sind durch PHEV gegenüber den Szenarien des Klimaschutzprogramms im Jahr 2030 jährliche Mehremissionen (TtW) von bis zu 4,3 Mio. Tonnen CO₂ möglich.

- Für die kommenden Jahre bis 2030 wird eine weitere Erhöhung der Systemleistung von PHEV um durchschnittlich 10 % erwartet. Der Anteil des Verbrenners an der Systemleistung dürfte dabei um einige Prozentpunkte zurückgehen, aber immer noch dominieren. Für die Batteriegröße wird ein Plus von 20 % bis 2030 erwartet, was aufgrund der ebenfalls zu erwartenden Gewichtszunahme jedoch nicht in gleichem Maße die elektrische Reichweite erhöhen dürfte.
- Die in dieser Studie durchgeführte Szenariobetrachtung geht basierend auf Marktdaten zu geplanten Produktionskapazitäten und den Erfordernissen der CO₂-Flottenzielwerte von 2,6 Mio. in Deutschland zugelassenen PHEV im Jahr 2030 aus. Da PHEV typischerweise als Dienstwagen zugelassen werden und später in den Privatmarkt übergehen, wird dann nur noch etwa jedes vierte Fahrzeug ein Dienstwagen sein.
- Gelingt es, bei privaten PHEV bis dahin in der Regel eine tägliche Vollladung zu realisieren, so werden bei dieser Fahrzeuggruppe die nach WLTP zu erwartenden Auspuffemissionen nur geringfügig überschritten. Bei Dienstwagen sind hingegen auch unter dieser optimistischen Annahme in 2030 gegenüber WLTP noch etwa doppelt so hohe CO₂-Emissionen zu erwarten. Besteht das heutige Ladeverhalten hingegen fort, so ergeben sich im PHEV-Flottenmittel Auspuffemissionen von 130 g/km, für Dienstwagen sogar 172 g/km.

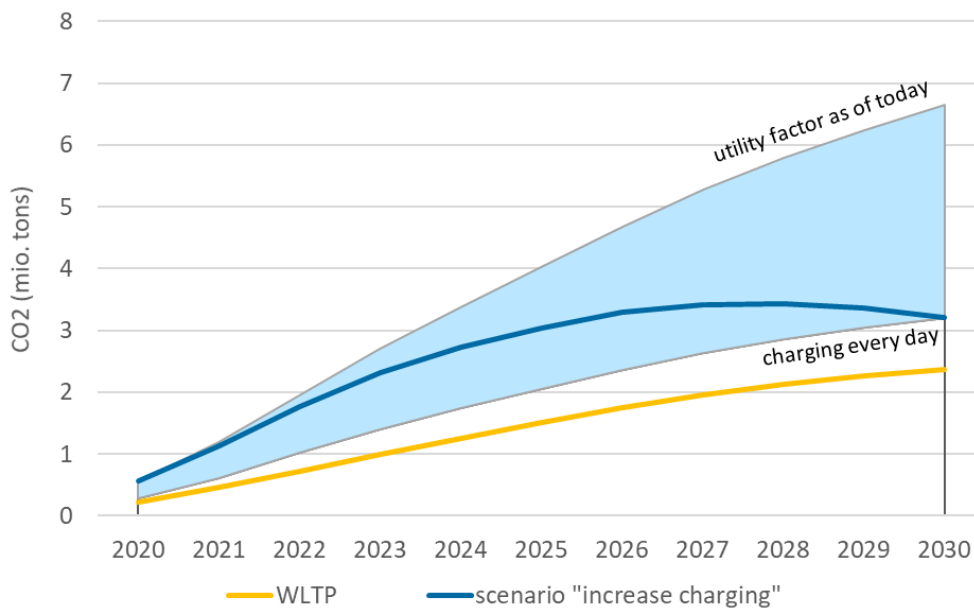

Jährliche CO₂-Auspuffemissionen der deutschen PHEV-Flotte im Zeitraum 2020-2030 auf Basis der WLTP-Annahmen (gelb) sowie unter Annahme realer Nutzungsprofile mit unterschiedlichem Ladeverhalten.

- Unter Annahme der WLTP-Werte ergeben sich für die deutsche PHEV-Pkw-Flotte im Jahr 2030 CO₂-Emissionen von 2,4 Mio. Tonnen. Bleiben die elektrischen Fahranteile hingegen so gering wie bei heutigen PHEV, so ergeben sich Mehremissionen von 4,3 Mio. Tonnen (insgesamt 6,7 Mt). Gelingt es, das tägliche Laden bis 2030 sukzessive zum Standardfall zu machen, so liegen die Mehremissionen ggü. WLTP bei etwa 0,8 Mt (insgesamt 3,2 Mt).

Unter gegebenen CO₂-Standards können nationale Förderinstrumente für Plug-In-Hybride real zu Mehremissionen führen.

Pkw mit einer großen Lücke zwischen dem Testzyklus (WLTP) und den realen CO₂-Emissionen mindern die Wirkung der Pkw-CO₂-Standards, da die EU-CO₂-Standards nur den Testzyklus, nicht aber die realen Emissionen regulieren. Bei Plug-In-Hybriden ist diese Lücke derzeit besonders hoch. Die zusätzliche Förderung solcher Fahrzeuge durch nationale Politiken führt daher – bei gegebenen CO₂-Standards – letztendlich zu einem Anstieg der Pkw-Flottenmissionen (wenn nicht auf nationaler Ebene, so doch zumindest auf EU-Ebene). Dies gilt insbesondere für PHEV als Firmenwagen, da diese derzeit die geringsten elektrischen Fahranteile aufweisen, gleichzeitig aber am stärksten subventioniert werden.

Die Sicherstellung des Klimaschutzbeitrags von Plug-In-Hybriden erfordert veränderte politische Rahmenbedingungen.

Aus diesen Ergebnissen ergibt sich eine erhebliche Gefahr für die Einhaltung der deutschen Klimaschutzziele im Verkehrsbereich, sollte der Bestand an PHEV weiterhin schnell anwachsen, ohne dass der reale elektrische Fahranteil schnell und deutlich gesteigert werden kann. Folgende regulatorische Ansatzpunkte kommen dafür in Frage:

- Weiterentwicklung des Typgenehmigungsverfahrens, um die Lücke zu den realen Emissionen signifikant zu reduzieren. Hierzu sollten zum frühestmöglichen Zeitpunkt Daten der europaweiten Realverbrauchserfassung (On-board fuel consumption metering, OBCFM) zum Einsatz kommen.

- Beschränkung staatlicher Fördermaßnahmen für PHEV auf Tatbestände mit nachweislich geringen Realemissionen
- Sicherstellung wirtschaftlicher und praktischer Anreize für PHEV-Nutzer zu häufigem Laden
- Anforderungen an die Auslegung von PHEV und ihrer Betriebsmodi, insbesondere Festsetzung einer elektrischen Mindestreichweite, die deutlich über dem derzeitigen Durchschnitt liegt.
- Maßnahmen zur Erhöhung der Transparenz über den Realverbrauch für Nutzer, Wissenschaft und Politik

Angesichts der gravierenden Zweifel an der umweltpolitischen Sinnhaftigkeit derzeit zugelassener PHEV sollten in einem ersten Schritt die derzeitigen Fördermaßnahmen (insbesondere die Kaufprämie sowie der Steuervorteil für Dienstwagennutzer) auf den Prüfstand gestellt werden und vertiefte wissenschaftliche Untersuchungen zu den Realemissionen von PHEV durchgeführt werden, beispielsweise auf Basis der ab Anfang 2021 erhobenen OBFCM-Daten.

Figures

Figure 2.1: Exemplary topology of a parallel hybrid powertrain	17
Figure 2.2: Exemplary topology of a serial hybrid powertrain	18
Figure 4.1: Vehicle stock in Germany by fuel type in January 2020. Source: (Kraftfahrtbundesamt 2020a)	24
Figure 4.2: Monthly and cumulative BEV and PHEV new registrations from 01/2014 to 03/2020. Source: (GoingElectric 2020).	25
Figure 4.3: Shares by owners for the total stock and only for PHEV's in January 2020. Sources: (Kraftfahrtbundesamt 2020b).	25
Figure 4.4: Number of models available by fuel type	27
Figure 4.5: Number of PHEV new registrations by car manufacturer and model from 01/2015 to 03/2020	28
Figure 4.6: Number and shares of PHEV new registrations by segment from 01/2015 to 03/2020	29
Figure 4.7: Average total power by fuel type (new registrations weighted average 2019)	30
Figure 4.8: Average total power by segment (new registrations weighted average 2019)	31
Figure 4.9: Shares and number of PHEV new registrations by total power from 01/2015 to 03/2020. The dashed red line shows the sales-weighted total power average.	32
Figure 4.10: Average empty weight by engine type (new registrations weighted average 2019)	33
Figure 4.11: Average empty weight by segment (new registrations weighted average 2019)	33
Figure 4.12: Average empty weight and average total power of PHEV new registrations from 01/2015 to 03/2020 by segment (sales-weighted)	34
Figure 4.13: Shares and number of PHEV new registrations by empty weight from 01/2015 to 03/2020. The dashed red line shows the sales-weighted mass average.	35
Figure 4.14: Number of PHEV new registrations by battery capacity from 01/2015 to 03/2020. The dashed red line shows the sales-weighted capacity average.	36
Figure 4.15: Share of PHEV models and new registrations by battery capacity, electric range and type-approval CO ₂ emissions. Timeframe: 01/2015 to 03/2020. Sources: (EFahrer.com 2020; GoingElectric 2020)	37
Figure 4.16: Average WLTP electric energy and fuel consumption by segment	38

Figure 4.17: WLTP and NEFZ fuel and electrical energy consumption for individual car models. The red dashed lines indicate the sales-weighted average values.	39
Figure 4.18: Shares and number of PHEV new registrations by list price from 01/2015 to 03/2020	40
Figure 5.1: Average fuel consumption of different models derived from spritmonitor.de	44
Figure 5.2: Comparison between WLTP and ADAC Ecotest fuel and electric energy consumption (combined values)	46
Figure 5.3: Utility factor according to type-approval as well as based on mobility surveys	48
Figure 5.4: Relation to NEDC test-cycle fuel consumption by user group. Source Fraunhofer ISI based on (Plötz et al. 2020)	49
Figure 5.5: UF vs. NEDC range by model variant. Source Fraunhofer ISI based on (Plötz et al. 2020)	50
Figure 5.6: Resulting utility factors according to type-approval (NEDC and WLTP), based on the mobility panel as well as based on empirical data from Fraunhofer ISI (see Figure 5.5).	51
Figure 5.7: WLTC-Simulation in CD mode (left) and CS mode (right) with VEHMOD (own calculations)	53
Figure 5.8: Discrepancy of electric consumption, fuel consumption and all-electric range for the example vehicle in HBEFA cycle simulation as compared to WLTP (own calculations)	55
Figure 5.9: Progression of actual speed and state of charge for the example vehicle in different operating modes in a demanding drive cycle with significant slopes.	56
Figure 5.10: Specific electricity and fuel consumption of example vehicle for the considered demanding driving cycle in different operating modes (own calculations)	56
Figure 5.11: Electric and fuel consumption according to WLTP for example vehicle in different ambient temperatures (own calculations)	57
Figure 5.12: Tailpipe CO ₂ emissions for defined vehicle segments, baseline 2020 (own calculations)	60
Figure 6.1: Number of available PHEV models on the EU market by manufacturer. Source: (IHS Markit 2019)	62
Figure 6.2: PHEV share in European vehicle production per segment. Source: (IHS Markit 2019)	62
Figure 6.3: Average battery capacity in the considered vehicle segments (IHS Markit data, calibrated to German PHEV market)	64
Figure 6.4: Average system power in the considered vehicle segments (IHS Markit data, calibrated to German PHEV market)	64
Figure 6.5: Average vehicle mass in the considered vehicle segments (IHS Markit data, calibrated to German PHEV market)	64
Figure 6.6: Annual mileage of petrol and diesel cars in Germany by user (Source: Moibility Panel, 2016/17-2018/19)	67
Figure 6.7: Utility factors applied in the scenario calculations; based on the mobility panel (MOP) for charging every day (dotted) and every	

other day (dashed) as well as based on empirical data from (Plötz et al. 2020).	68
Figure 7.1: New registrations of PHEV in Germany by segment and user, 2020-2030	70
Figure 7.2: PHEV vehicle stock in Germany by segment and user, 2020-2030	71
Figure 7.3: PHEV mileage in Germany by segment and user, 2020-2030	72
Figure 7.4: PHEV CO ₂ tailpipe emissions per km depending on charging behaviour, 2020 and 2030	73
Figure 7.5: Total PHEV CO ₂ emissions in Germany 2030 for different charging behaviours	73
Figure 7.6: Total PHEV CO ₂ emissions in Germany in the case of increased charging, 2020-2030	74
Figure 8.1: CO ₂ emissions per km for PHEV and equivalent ICEV (weighted average)	77
Figure 8.2: Substituted PHEV registration per powertrain for PHEV scenario and alternative scenarios. Source: own calculations.	79
Figure 8.3: WLTP CO ₂ emissions per km for new registrations in Germany. Source: own calculations.	80
Figure 8.4: CO ₂ tailpipe emissions per km for PHEV and ICE, 2020 and 2030. Source: own calculations.	81
Figure 8.5: CO ₂ tailpipe emissions for PHEV scenarios and alternative scenarios (2030)	81
Figure 9.1: Overview of possible regulatory approaches	83

Abbreviations

AER	All-electric range
BEV	Battery-electric vehicle
CD mode	Charge-depleting mode
CS mode	Charge-sustaining mode
EAER	Equivalent all-electric range
ICE	Internal combustion engine
NEDC	New European drive cycle
OBFCM	On-board fuel consumption meter
PHEV	Plug-in hybrid electric vehicle
UF	utility factor (= proportion of electric drive in overall mileage of PHEV)
WLTC	Worldwide harmonized Light Duty Test Cycle
WLTP	Worldwide harmonized Light vehicles Test Procedure
ZLEV	zero and low emission vehicles

1 Introduction, Goal & Scope

In order to facilitate the expected transition towards electric drive systems in passenger cars, plug-in hybrid vehicles (PHEVs) are seen as an important bridge-technology by most car manufacturers and some politicians in Germany. Since the beginning of 2020, new registrations of PHEV have been surging in Germany. The main drivers are likely to be the stricter EU CO₂ emission standards for vehicle manufacturers since the beginning of the year as well as the increased purchase premium for battery and plug-in hybrid vehicles.

For some time now, there have been indications that exhaust emissions of PHEVs in real operation considerably exceed the emissions according to type approval. This raises questions to which extent PHEVs can actually contribute to achieving the agreed climate protection targets in the transport sector. The present study addresses this question by analyzing the technical characteristics of the current fleet of new PHEVs and usage patterns.

First, the current state of PHEV technology development is summarized (chapter 2) as well as the regulatory situation at national and European level (chapter 3). Thereafter, key parameters of the PHEV market are analysed (chapter 4). Subsequently, the energy consumption of PHEVs is examined under different conditions and compared to the official values according to type approval (chapter 5). With the help of market analyses, a scenario for the technical development of PHEVs up to the year 2030 is then derived and estimates are made of expected changes in vehicle use during this period (chapter 6). On this basis, a scenario for the development of the PHEV fleet in Germany is then drawn up and its expected real-world CO₂ emissions are calculated and compared with the German government's targets (chapter 7). Additionally, two hypothetical scenarios without PHEV are investigated in order to draw specific conclusions (chapter 8). Finally, the results are used to derive approaches for policy measures to ensure the climate policy benefits of PHEVs (chapter 9).

2 Overview of PHEV technology

2.1 Vehicle Configurations

The possible topologies of the drive trains of plug-in hybrid vehicles are manifold. They are fundamentally differentiated according to two factors: the degree of hybridization and the structure or arrangement of the drive components. The present study is limited to plug-in hybrids. Similar to non-externally chargeable hybrids, they can be further divided into three main groups according to the energy flows in the drive trains: Parallel hybrids, serial hybrids, and mixed topologies.

Parallel hybrids

Parallel hybrid powertrains are characterized by the fact that both the combustion engine and the electric motor can act mechanically on the drive axle(s). It is possible to drive with one drive system each or to couple both in order to add the mechanical drive power (Reif 2016). Figure 2.1 illustrates this structure for the case where both systems act on the rear axle. They can be coupled with each other or with the drive axle via a clutch, a summation gear or a freewheel.

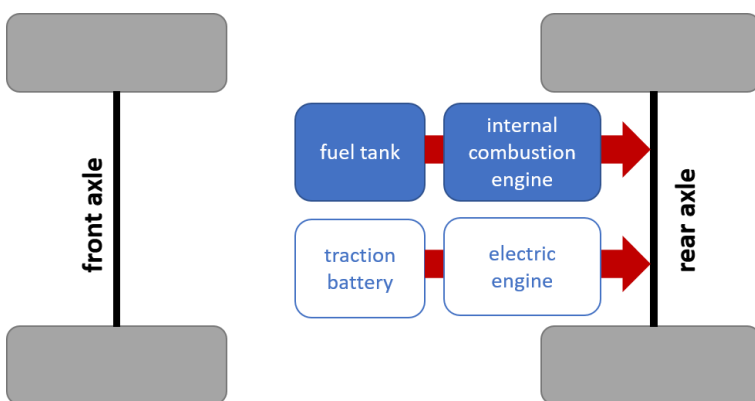

Figure 2.1: Exemplary topology of a parallel hybrid powertrain

However, it should be noted that the drive systems are not limited in their effect on one and the same axis. It is also possible (as for example with the BMW i8) that the combustion engine transmits its drive power to one axis while the electric drive system drives the other. This special form is known as an axlesplit hybrid or, in some cases, hybrid-through-the-road (Keilhof 2015).

The possibility of adding the drive torques can increase the dynamics of the vehicle. This is one of the reasons why this type of drive topology is currently being used by manufacturers

to appeal to customers in market segments with a sporting focus. Typical representatives are the rear-wheel drive plug-in hybrids from Mercedes (C350e, S500e) and BMW (330e, 530e) as well as the front-wheel drive GTE family from Volkswagen (Golf GTE, Passat GTE).

Serial hybrids

In serial hybrid powertrains (Figure 2.2), the combustion engine drives a generator that feeds the traction battery, while the actual vehicle propulsion is provided by one or more electric motors. The front axle can also be driven instead of the rear axle.

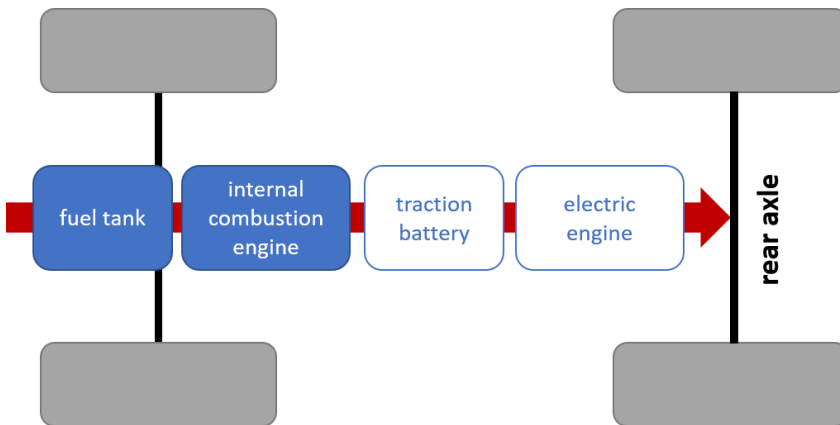

Figure 2.2: Exemplary topology of a serial hybrid powertrain

While parallel hybrids are also frequently found in conventional hybrids, serial connection of the drive systems is particularly suitable for equipping battery electric vehicles with range extenders. Since the speed and torque of the combustion engine are not linked to the vehicle speed, the combustion engine can operate at a comparatively efficient operating point at any time. A typical example is the BMW i3 with range extender.

Mixed Topologies

The combination of several electric motors with an internal combustion engine by means of a planetary gearbox offers the possibility, depending on the design of the system and the motors, to add up torques and transfer load ranges between the drives. Such combinations can act like a continuously variable transmission (CVT) and generate both serial and parallel hybrid operating modes in one system. For example, the Opel Ampera and the identical Chevrolet Volt have both two purely electric-motor-driven operating modes as well as a serial and a parallel hybrid mode.

Mixed topologies are also used by the Toyota group, e.g. some Lexus models (GS450h, LS600h, RX450h) and the Toyota Prius. The latter is available as a conventional full hybrid and as a plug-in hybrid version. Furthermore, there are conversion solutions that extend an existing hybrid vehicle (Toyota Prius) to a PHEV.

2.2 Operating Modes

PHEVs typically offer different operating modes which can be selected by the driver. Depending on the selected mode, the operation strategy of the powertrain is adjusted. As a result, the interaction between the electric motor and the combustion engine are adjusted differently. In practice, this leads to different utility factors as well as electric energy and fuel consumption. The most commonly used operating modes of recent car models are summarized in the following table.

Operating mode	Hybrid mode	E-save mode	E-drive mode	Sport-mode	E-charge mode
Description	Standard start mode: Hybrid operation with automatic selection of the most efficient energy source.	Electrical energy save mode: The E-save mode helps to save battery power, for example for later city centre driving.	Pure electric mode: The vehicle operates purely electrically as long as possible, the maximum speed is reduced	Sport mode: Maximum total performance can be achieved by combining the electric motor and combustion engine.	Battery charging mode – serial PHEV’s only: Continuously charges the battery while standing, driving and during braking.
Electric engine	on	off	on	on	off
Combustion engine	on	on	off	on	on
Examples	Mitsubishi Outlander: “D” BMW 225xe Active Tourer iPerformance: “COMFORT” Audi A3 e-tron: “Hybrid Auto” Mercedes E300de: “Hybrid” VW Passat GTE: „Hybrid“	Mitsubishi Outlander: “Save” BMW 225xe Active Tourer iPerformance: “SAVE BATTERY” Audi A3 e-tron: “Hybrid Hold” Mercedes E300de: “E-Save” VW Passat GTE: „E-Mode“+Button	Mitsubishi Outlander: “EV-Priority” BMW 225xe Active Tourer iPerformance: “MAX eDRIVE” Audi A3 e-tron: “EV” Mercedes E300de: “E-Mode” VW Passat GTE: „E-Mode“	Mitsubishi Outlander: “Sport” BMW 225xe Active Tourer iPerformance: “SPORT” Audi A3 e-tron: “Dynamic” Mercedes E300de: “Sport” VW Passat GTE: „GTE“	Mitsubishi Outlander: “Charge” BMW 225xe Active Tourer iPerformance: - Audi A3 e-tron: “Hybrid Charge” Mercedes E300de: “Charge” VW Passat GTE: „Battery Charge”

In addition to the different operating modes, most cars offer different levels of recuperation, which can also be individually selected by the driver. The intensity of the recuperation can therefore usually be selected between several stages. Hence, besides the operating modes, the recuperation is an additional parameter which can be adjusted by the driver and which influence energy and fuel consumption.

3 Regulatory Situation

3.1 Test cycle emissions (WLTP)

As of September 2017, the new WLTP test procedure became mandatory in the EU. It aims to be more representative of average driving behaviour than the NEDC test cycle it replaces. A comprehensive description of the application of the WLTP procedure to PHEV can be found in (Riemersma / Mock 2017). The WLTC is subdivided into four phases: low, medium, high, and extra-high vehicle speed, which can be regarded as typical driving for an urban, rural, 100-km/h limit, and 130-km/h limit motorway, respectively. Fuel and electrical energy consumption are determined for each of these phases and aggregated according to the phase's specific utility factor into one combined average, which forms the basis for vehicle CO₂ regulation.

If a vehicle has a high electric range, it likely will be driven mostly in charge-depleting mode (CD mode), whereas if it has a low electric range, it likely will be driven more in charge-sustaining mode (CS mode). The WLTP introduced a novel approach for determination of the weighting factor (referred to as the utility factor) that describes the ratio of driving in CD and CS mode as a function of the electric range. It is based on historical driving patterns of a particular vehicle fleet and the assumption of a daily full-charge. Calculation of the average weighted fuel consumption, C , in WLTP is done according to the following formula:

$$C = UF * C1 + (1 - UF) * C2$$

Where:

C = weighted fuel consumption in liters per 100 kilometers;

$C1$ = fuel consumption in liters per 100 kilometers in *charge-depleting* (CD) mode when the vehicle is mainly driven using the electric motor;

$C2$ = fuel consumption in liters per 100 kilometer in *charge-sustaining* (CS) mode when the battery is depleted and the vehicle is mainly driven using the internal combustion engine; and

UF = utility factor as a function of the electric range R_{CD} , defined as the distance driven up to and including the transition cycle, see (Riemersma / Mock 2017).

WLTP uses an interpolation family approach for CO₂, fuel and electric energy consumption, and electric range. Effectively this means that for every vehicle family member, depending on its actual mass, aerodynamic resistance, and rolling resistance, dedicated values for these parameters will be calculated by interpolation between the vehicles of the family that have the highest and lowest energy consumption over the test cycle.

3.2 European CO₂ fleet emission targets

To reduce CO₂ emissions from new cars, CO₂ fleet targets have been set¹ at EU level. By 2021, the (average) emissions of all new passenger car registrations in the EU are to be reduced to 95 g/km. While the type approval procedure transitioned to WLTP in 2017 as described above, the fleet emission target for 2020 is still defined based on the NEDC procedure. In 2020, carmakers have to reach the 95g/km target over 95% of their fleet of new sales, effectively eliminating the 5% most polluting vehicles from the calculation. Depending on the composition of the product portfolio, a specific target value is calculated for each manufacturer based on the mass of vehicles offered. Failure to meet this target results in penalties of 95 €/g excess CO₂ emissions per vehicle.

The EU CO₂ fleet targets regulates tailpipe emissions, hence battery electric vehicles (BEVs) are counted as 0 gCO₂/km. The emissions from PHEV are calculated as a result of the test cycle procedure described above. The increased vehicle weight as a result of the traction battery leads to higher permitted CO₂ emissions for the entire fleet within the regulations on fleet target values.

PHEVs, like BEVs, also play a separate role in this context, as vehicles that emit less than 50 g CO₂ per km in the test cycle (which largely includes PHEVs) benefit from so-called super-credits towards reaching the 95 gCO₂/km target from 2020. Zero and low emission vehicles (ZLEVs) below 50g CO₂/km may be considered with a multiplication factor of 2 in 2020, 1.67 in 2021 and 1.33 in 2022 onto the calculation of a manufacturer's fleet average.

In 2019 the post-2020 EU car CO₂ emission reduction targets were approved which set the objective of a 15 % CO₂ emission reduction target in 2025 and 37.5 % in 2030 (compared to a 2021 baseline). For the 2025 and 2030 targets, a new calculation method comes into force with the Zero and Low Emission Vehicle (ZLEV) benchmark (starts in 2025): when over-achieving the ZLEV benchmark, carmakers are allowed to relax their overall CO₂ targets. Under this new formula, PHEVs benefit from a multiplier of 0.7 in the formula (see T&E's 2019 analysis (Transport & Environment 2019) of the post-2020 car CO₂ standards). In December 2019, the European Green Deal communication has announced the plan to revise this post-2020 car CO₂ targets with a proposal in June 2021.

¹ EU Directive 333/2014

3.3 German National Regulation affecting PHEV

PHEVs combine the drive of conventional combustion engine and pure electric drive. However, in many areas they are legally treated in a similar way to pure battery electric vehicles if they fulfil certain requirements.

Electric Mobility Act

The German Electromobility Act¹ regulates support measures for vehicles with CO₂ emissions below 50 g/km or 40 km purely electric range in the NEDC (transitional regulation: 30 km) and thus largely includes PHEVs. The regulations include the possibility of reserving parking spaces or making them free of charge for these vehicles. Furthermore, advantages can be granted for entry or passage into certain areas. The prerequisite for granting and checking such privileges is the clear recognition of the vehicles entitled to them. For this purpose, the possibility of adding an "E" to vehicle registration plates was introduced. In addition to BEV and fuel cell vehicles, plug-in hybrids can also be marked in this way. In addition to the granting of privileges, this makes it clearer for rescue services, for example, in the event of an accident whether high-voltage components are installed in the vehicle and whether appropriate precautions must be taken.

Purchase premium for electric vehicles

Since May 2016 there has also been direct financial support for the purchase of new vehicles. BEVs, PHEVs or fuel cell vehicles that are newly purchased, registered and owned for at least six months are eligible for funding. Part of the subsidy is paid for by the manufacturer in the form of a corresponding discount, while another part is subsequently reimbursed to the buyer from the federal budget. Starting with a government subsidy of 2.000 Euro for BEV and 1.500 Euro for BEV, the government decided to increase the subsidy in the course of the climate action package (2019) and the stimulus package (June 2020), differentiated according to the net list price of the vehicle. The following table shows the current incentives paid for BEV and PHEVs.

Table 1: Subsidies for plug-in vehicles in Germany

	Discount by manufacturer	Government incentive (June 2020- Dec 2021)	Government incentive (2022 onwards) ²
BEV < 40.000	3.000	6.000	3.000
BEV 40 – 65.000	2.500	5.000	2.500
PHEV < 40.000	2.250	4.500	2.250
PHEV 40 – 65.000	1.875	3.750	1.875

¹ Act on the Preferential Use of Electrically Operated Vehicles (Electromobility Act - EmoG)

² On November 17, 2020 the Government announced that the current amount of the purchase subsidy will be maintained until 2025.

Eligible for application are private individuals as well as companies and institutions such as foundations, corporations and associations. In order to secure the automotive industry's own contribution, the federal share is only paid if the net purchase price is lower than the BAFA list price by the corresponding amount of support; the invoice must be presented when the premium is applied for. So far (as of 1.7.2020), 214,269 applications for funding have been submitted, including 76,625 plug-in hybrids.

Energy consumption labelling

The ¹Passenger Car Energy Consumption Labelling Ordinance transposes a European directive into German law and regulates a label that is intended to inform consumers about the CO₂ efficiency of a vehicle when buying or leasing it. Similar to the efficiency classes for household appliances, passenger cars are also classified into CO₂ efficiency classes A+ to G, shown as coloured arrows from green to red. The official CO₂ emissions are set in relation to the vehicle weight, which favours heavier vehicles with the same fuel consumption. PHEVs benefit in two ways: First, the battery capacity of PHEVs is advantageously taken into account when determining the CO₂ emissions. On the other hand, the additional weight due to the more complex drive system increases the CO₂ limit to be observed for a certain efficiency class.

Motor vehicle tax

According to Kraftfahrzeugsteuergesetz (KraftStG) §3d, all BEVs that were or will be registered for the first time in the period from 18 May 2011 to 31 December 2025 are tax-exempt from the motor vehicle tax for 10 years from their date of first registration. The exemption will be granted until 31 December 2030 at the latest. Vehicles with CO₂ emissions below 95 g (i.e. especially plug-in hybrids), which are registered for the first time by 31.12.2024, will receive a tax reduction of 30 euros per year, limited until the end of 2025. The tax exemption for PHEVs will thus be granted for a maximum of 5 years and will amount to up to 150 euros for passenger cars registered at the beginning of 2021.

After 2025, PHEV will be taxed according to the regulations for conventionally powered vehicles. The motor vehicle tax is based on the engine capacity and on CO₂ emissions. However, the CO₂ component only applies to vehicles emitting more than 95 g CO₂/km (WLTP). This means that PHEVs are favoured by the rules for calculating and reporting CO₂ emissions. In the case of plug-in hybrid vehicles with petrol engines, the engine capacity component amounts to 2 euros per 100 cc, i.e. depending on the engine capacity of the PHEV, the motor vehicle tax is as low as 32-54 euros per year (for an engine capacity of 1,600-2,700 cc).

Company car taxation

If company cars are used for private purposes, their users have to pay taxes. The benefits in kind are calculated using the so-called "1% method", which adds 1% of the car's list price (not the actual price paid) to an employee's taxable income each month. Since January 2019, only half as much tax has to be paid for plug-in hybrids and only a quarter for e-cars with a list price of less than 60,000 euros.

¹ Ordinance on consumer information on fuel consumption, CO₂ emissions and electricity consumption of new passenger cars (Passenger Car Energy Consumption Labelling Ordinance - Pkw-EnVKV)

4 Market Situation

For the development of political recommendations regarding PHEVs, it is important to understand the current market situation for passenger cars in general and especially the situation of PHEVs. To this end, data about vehicle stock, technical parameters and prices of current PHEVs in Germany are analysed in this section.

4.1 Number of registrations and vehicle stock

As of January 2020, a total of 47.7 million passenger cars were registered in Germany. Most of them are powered by gasoline (65.9 %) and diesel (31.7 %). The total market share of electric vehicles is about 0.5%. Within these vehicles, battery-electric vehicles (BEVs) account for 57 % (about 135,000 vehicles) and PHEVs for 43 % (about 100,000 vehicles). From January to August 2020 alone, another 85,000 new PHEV were registered in Germany, which demonstrates the rising demand.

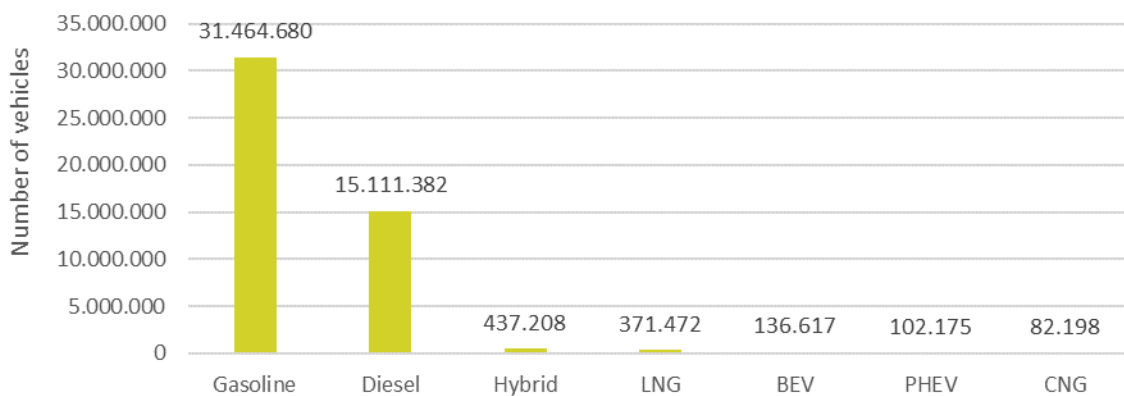

Figure 4.1: Vehicle stock in Germany by fuel type in January 2020. Source: (Kraftfahrtbundesamt 2020a)

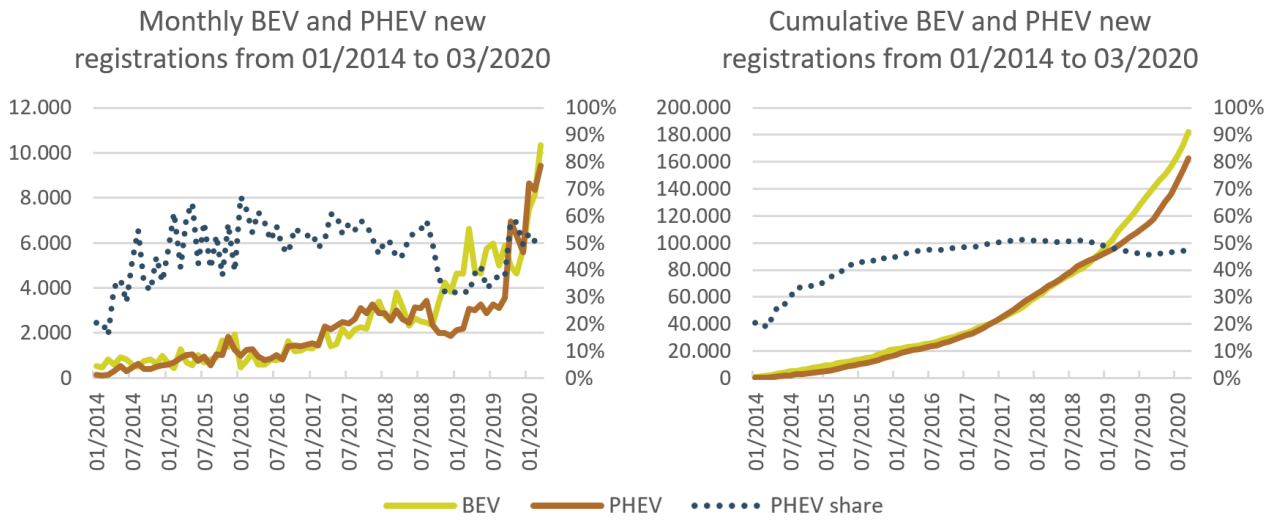

Figure 4.2: Monthly and cumulative BEV and PHEV new registrations from 01/2014 to 03/2020. Source: (GoingElectric 2020).

Even if the total number of electric cars has just a small share in the car fleet yet, in recent years the new registrations of BEV and PHEV increased (Figure 4.2), particularly gaining momentum in mid-2019. While for 2019 the average market share of PHEV new registrations was just 1.3 %, the share increased to 4.4% in March 2020.

When comparing BEVs and PHEVs from 01/2014 to 09/2018, the monthly numbers of BEV and PHEV new registrations were relatively similar. In 2019, BEV new registrations were slightly higher than PHEV new registrations. Since 10/2019 PHEVs caught up and since April 2020, there have been more PHEV new registrations than those for BEV. .



Figure 4.3: Shares by owners for the total stock and only for PHEV's in January 2020. Sources: (Kraftfahrtbundesamt 2020b).

Figure 4.3 shows the division of PHEV stock between private and commercial owners as of January 2020. Most cars in Germany were owned by private owners (89 %) and just 11 % were owned by commercial owners. When looking at this distribution just for PHEVs the share of commercial owners within the PHEV stock was significantly higher with about 53 % in January 2020. This number is currently also growing over time: While commercially owned PHEV amounted to only 50 % in January 2019, it was 58% as of Apr 1st 2020. This is due to an exceptionally high commercial share of around 80 % for PHEV new registrations (April 2020). Generally, the overall share of commercial vehicles in new registrations in Germany is between 60% and 66% (2011-2019).

Possible reasons for the disproportionately high importance of commercial PHEV new registrations are tax privileges for these vehicles (see section 3.3) as well as the fact that PHEV are mostly offered in the upper vehicle segments which are also over-represented in the German commercial vehicle fleet. Over time, it can be expected that PHEVs enter the 2nd hand market, which will increase the share of private ownership. This is also considered in the scenario calculations (chapter 7).

4.2 Availability of vehicle models

When comparing the number of car models available by fuel type (Figure 4.4), it can be seen that the number of PHEV models¹ available on the German market is still quite limited (about 3 % of the available gasoline vehicle models). However, this number is expected to surge in the following years (cf. Figure 6.1). Most of the PHEV models today are equipped with a gasoline engine (92 %).

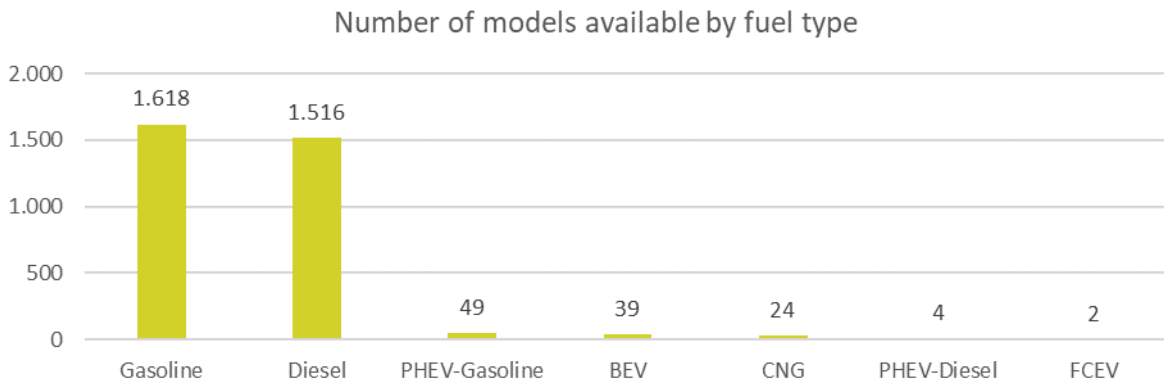

Source: (DAT 2019)
 Figure 4.4: Number of models available by fuel type

¹ These PHEV numbers contain different fuel types per model. The Mercedes E-Class for example is available in both a Diesel-PHEV and Gasoline-PHEV version.

Number of PHEV new registrations by segment

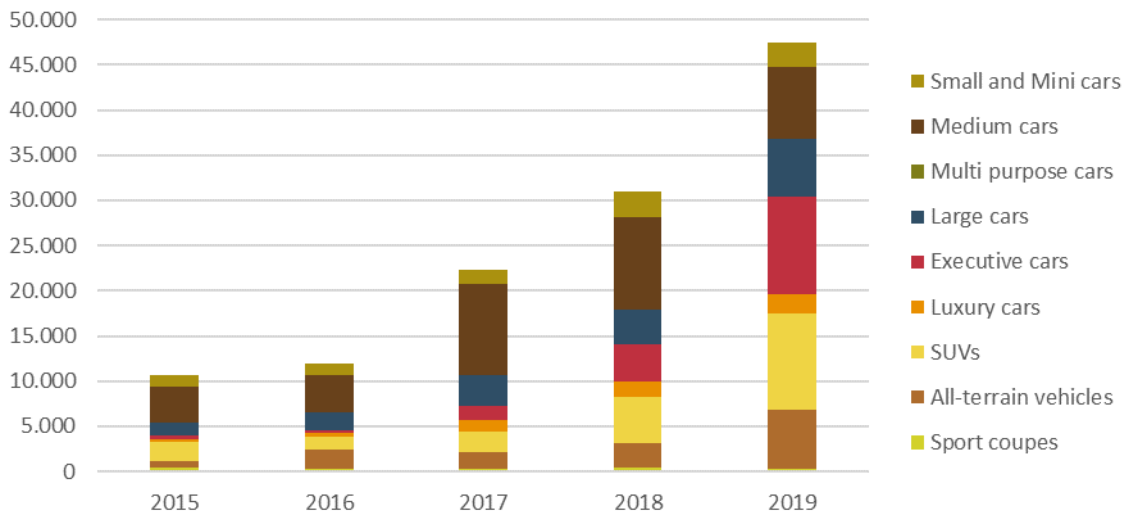

Share of new registrations by segment PHEVs

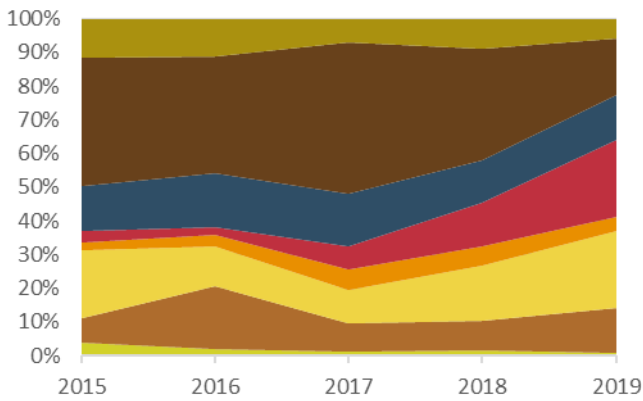

Share of new registrations by segment All passenger cars

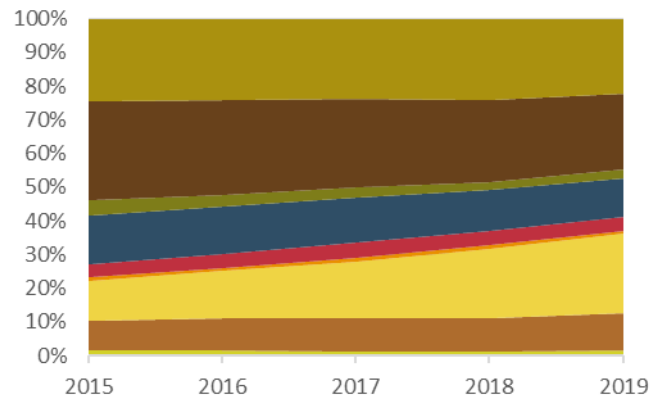

Source: (GoingElectric 2020) (KBA 2020a)

Figure 4.6: Number and shares of PHEV new registrations by segment from 01/2015 to 03/2020

4.3 Vehicle mass and power

When comparing the average total power of PHEVs, BEVs, FCEVs and conventional cars, Figure 4.7 shows that the sales-weighted average total power of PHEVs is by far the highest, an average PHEV having about 188 % total power in comparison to a conventional gasoline combustion model.

Since the distribution onto vehicle segments is different for PHEVs and ICEVs, we also did an analysis separately for the segments, also looking at the power rating of the PHEVs' combustion engine separately (Figure 4.8). For the most significant PHEV segments, some notable differences turn out: While for medium and executive cars the total power of the PHEV models is somewhat similar to the gasoline cars in these segments, we see considerably higher total power ratings for SUVs and all-terrain vehicles. For the latter, even the power of the combustion engine in PHEVs is higher than the average system power of the conventional vehicles. One possible explanation is that for these segments, the switch to PHEV is seen as an opportunity by the OEMs to offer improved driving performance to their customers.

Generally, it has to be considered that the need for sufficient driving performance in pure electric mode and the presence of an additional combustion engine may imply a combined power rating that is greater than the power of an equivalent vehicle with only one drivetrain. On the other hand, since in hybrid mode, the electric motor can assist in case of spontaneous power demand for acceleration, it is reasonable to assume that the combustion engine could be configured with considerably lower power compared to a combustion-only vehicle.

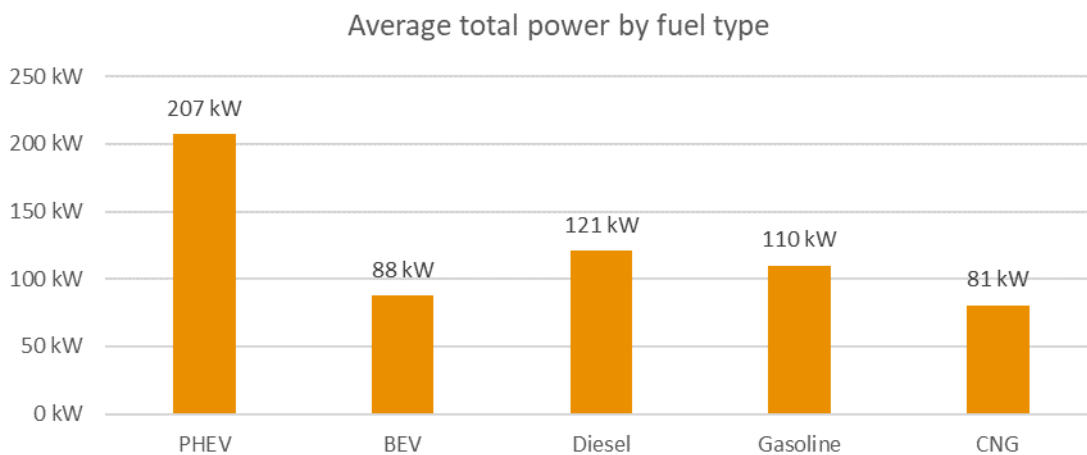

Source: (EFahrer.com 2020; GoingElectric 2020; KBA 2020a)
Figure 4.7: Average total power by fuel type (new registrations weighted average 2019)

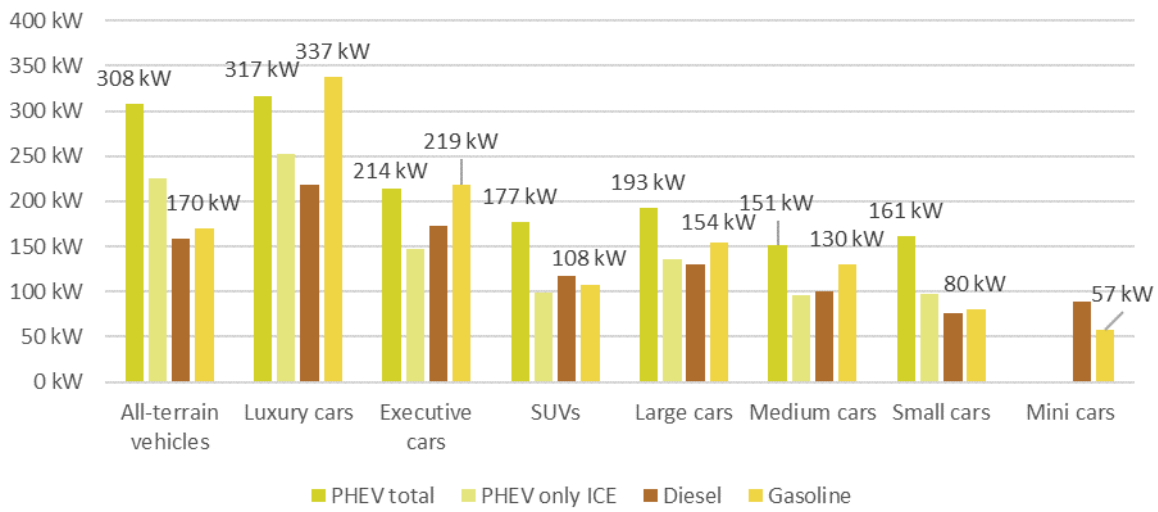

Source: (EFahrer.com 2020; GoingElectric 2020; KBA 2020a)
 Figure 4.8: Average total power by segment (new registrations weighted average 2019)

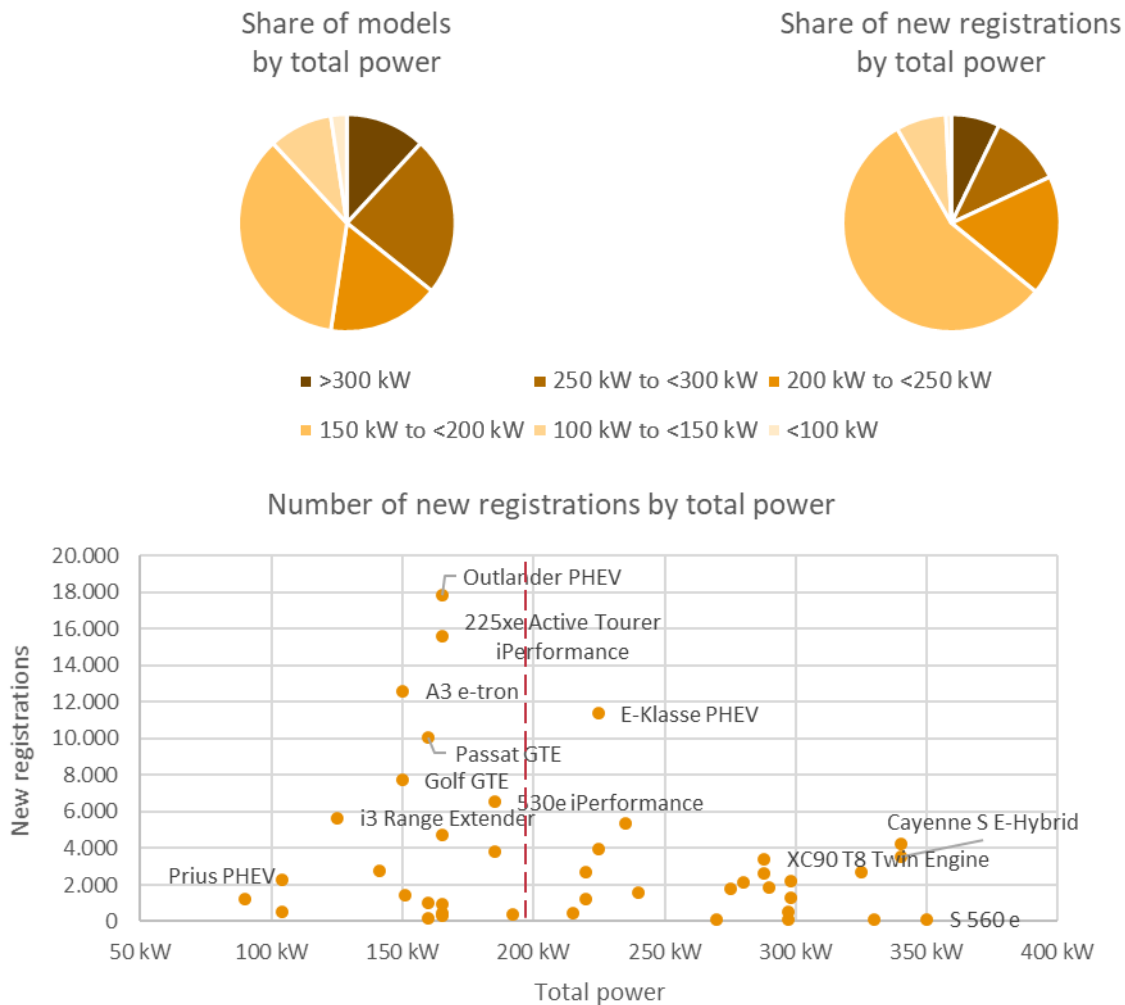

Sources: (EFahrer.com 2020; GoingElectric 2020)

Figure 4.9: Shares and number of PHEV new registrations by total power from 01/2015 to 03/2020. The dashed red line shows the sales-weighted total power average.

When looking at the new registered PHEV models in Germany, about half of the models exceed a system power rating of 200 kW (Figure 4.9). Most of the PHEV models with high new registrations numbers, however, offer a total power of less than 200 kW. This includes the models Mitsubishi Outlander, BMW 225xe Active Tourer and Audi A3 e-tron for example. Hence, the new registrations weighted average total power is 197 kW (see dashed red line).

Looking at the vehicle mass, PHEVs are heaviest on average compared to other fuel types. An average PHEV has an official vehicle mass of almost 2,000 kg and is about 43 % heavier than an average gasoline car and 21 % heavier than an average diesel car. This can partly be explained by PHEVs carrying two drivetrains instead of one. In addition to that, PHEVs are over-represented in the large segments, as discussed above. Therefore, once more we look at the breakdown to vehicle segments (Figure 4.11). In the most important PHEV segments, the results correspond to the findings for the vehicle power: For executive and medium cars, we see an additional vehicle mass of 200-300 kg, which can be attributed to the additional drivetrain. For SUVs and all-terrain vehicles, however, the additional mass amounts to about 500-600 kg compared to the gasoline vehicles. This may partly be due to the higher power

rating and bigger batteries of these vehicles which could result in a heavier drivetrain. However, it seems likely that the weight is at least partly driven by additional accessories in the vehicles. Figure 4.12 additionally gives a graphical overview of the relation between vehicle mass and power separately for the vehicle segments.

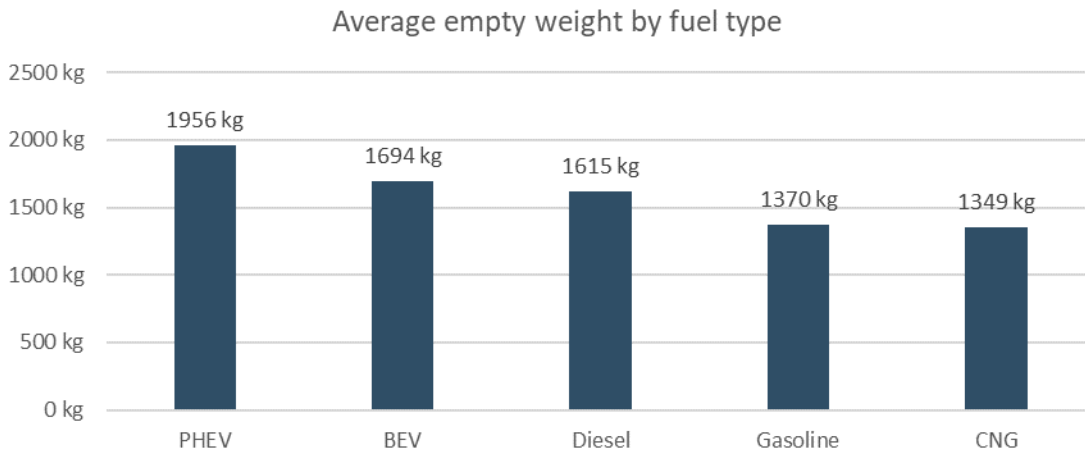

Source: (EFahrer.com 2020; GoingElectric 2020; KBA 2020a)
 Figure 4.10: Average empty weight by engine type (new registrations weighted average 2019)

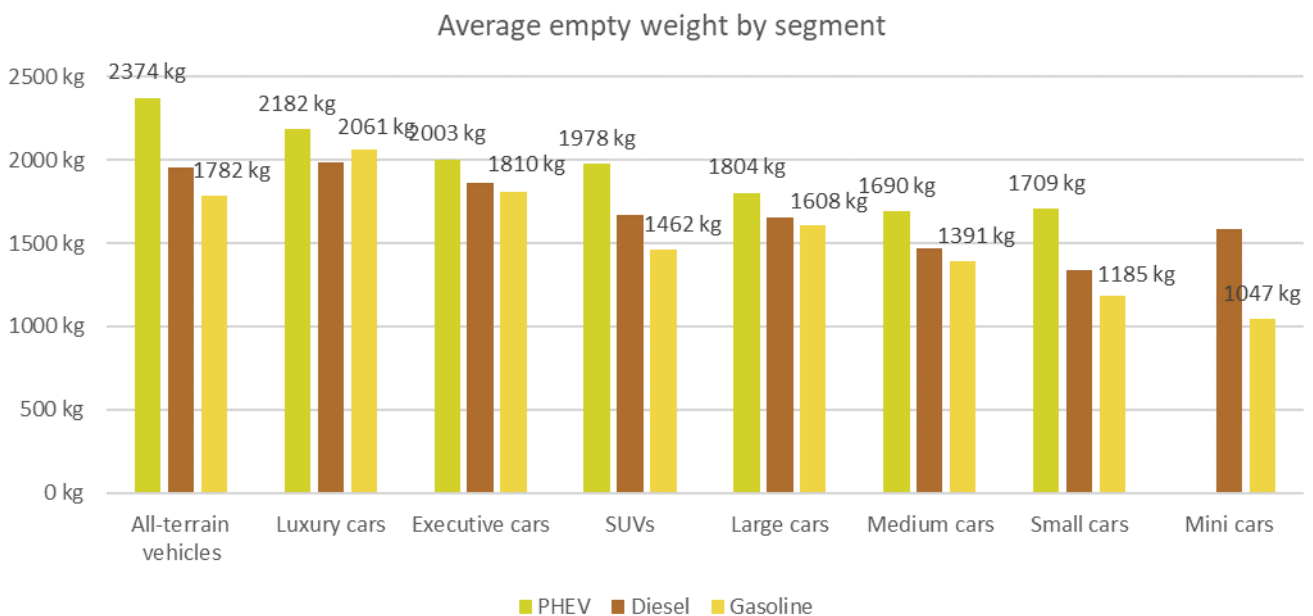

Source: (EFahrer.com 2020; GoingElectric 2020; KBA 2020a)
 Figure 4.11: Average empty weight by segment (new registrations weighted average 2019)

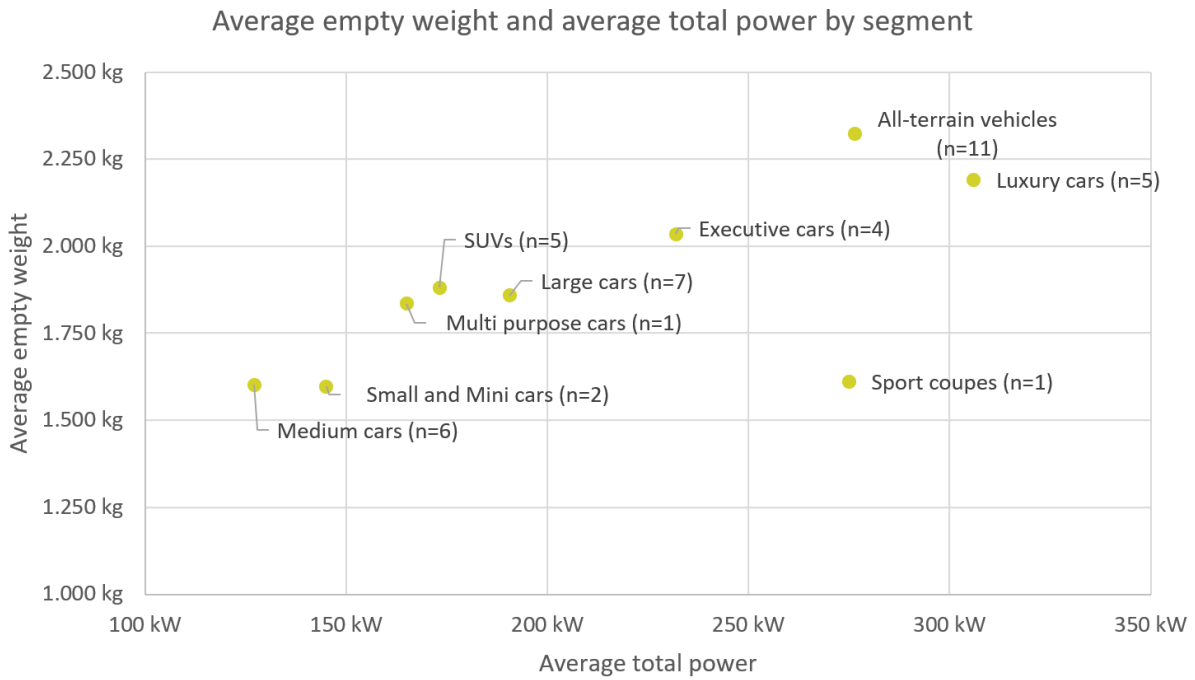

Source: (EFahrer.com 2020)
 Figure 4.12: Average empty weight and average total power of PHEV new registrations from 01/2015 to 03/2020 by segment (sales-weighted)

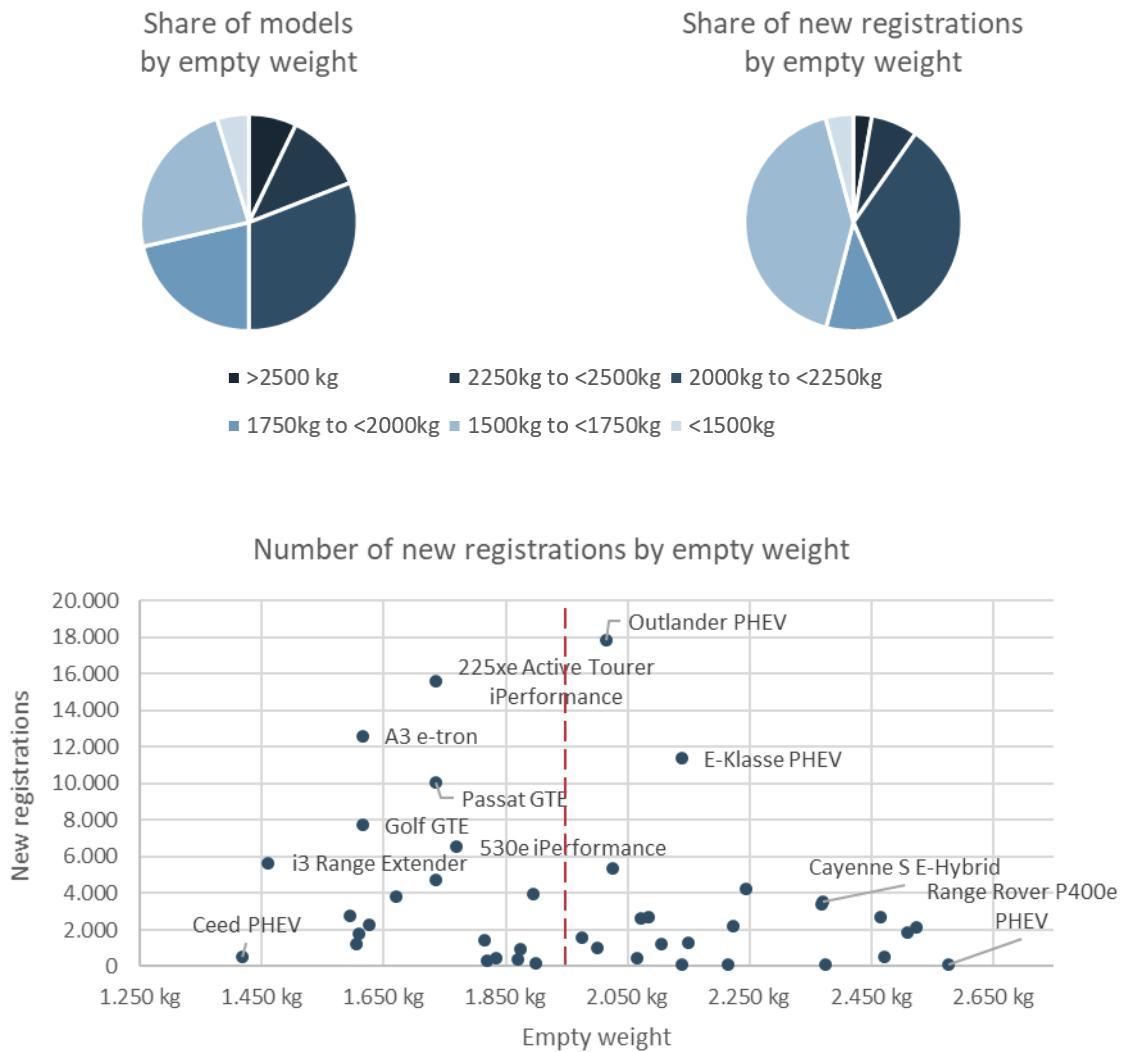

Sources: (EFahrer.com 2020; GoingElectric 2020)

Figure 4.13: Shares and number of PHEV new registrations by empty weight from 01/2015 to 03/2020. The dashed red line shows the sales-weighted mass average.

Figure 4.13 provides some further insights on the distribution of vehicle mass within the PHEV market. The empty weight of about half of all PHEV models on the market exceeds 2.000 kg. Many of the newly registered cars, however, weight less than 2.000 kg. This includes many top selling models (e.g. BMW 225xe Active Tourer, Audi A3 e-tron, Passat GTE). Hence, the new registrations weighted average empty weight is about 1.900 kg (see dashed red line).

4.4 Range, energy consumption and CO₂ emissions

Figure 4.15 gives an overview of the distribution of battery capacity, electric power and CO₂ emissions according to type approval for all PHEV models present on the German market since 2015, as well as weighted by the number of registrations to date. Regarding the official range, about half of all models are below 50 km according to WLTP. When looking at the registration-weighted figures, the picture shifts somewhat: about two thirds of all registered PHEVs have an electric range of less than 50 km according to WLTP, about a quarter are below 40 km and thus below the relevant limit of the German Electric Mobility Act.

Since the electric range is decisive for the CO₂ emissions according to type approval, a similar picture emerges here: About two thirds of the vehicle models and about 80 % of the approved PHEVs have standard emissions of less than 50 g/km and thus fall particularly below the relevant limit of the German Electric Mobility Act.

The battery capacities per vehicle are mostly in the range between 7.5 kWh and 15 kWh (on average about 12 kWh) and are shown in Figure 4.14 for the individual vehicle models. It can be seen that there are only a few outliers in terms of battery capacity. Production of the i3 Range Extender has been discontinued in the meantime.

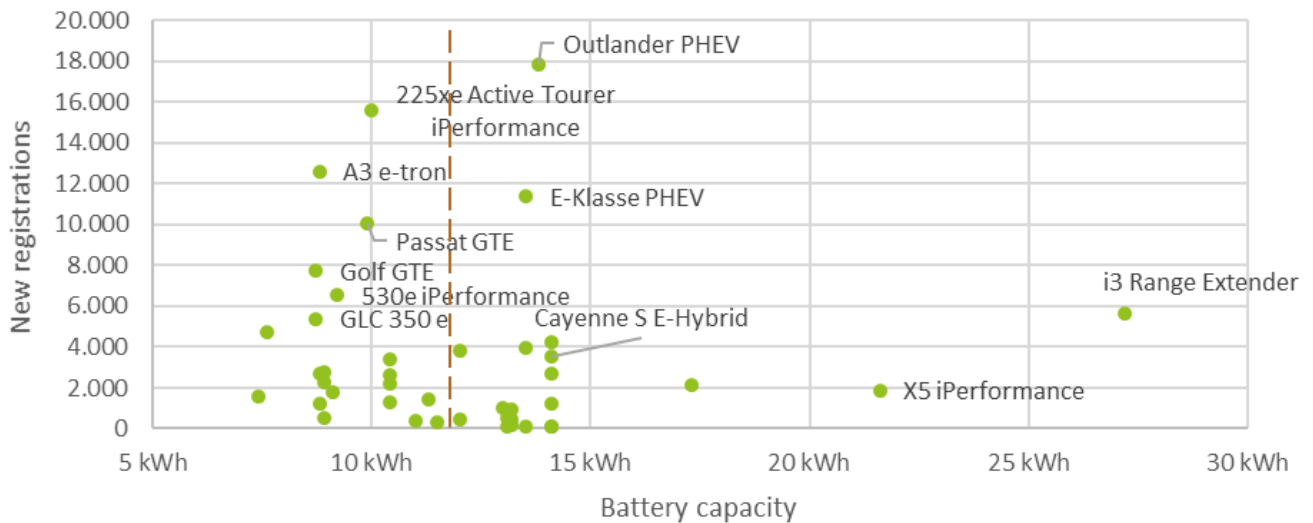

Figure 4.14: Number of PHEV new registrations by battery capacity from 01/2015 to 03/2020. The dashed red line shows the sales-weighted capacity average.

Share of models by battery capacity



■ >17,5kWh
 ■ 15kWh to <17,5kWh
 ■ 12,5kWh to <15kWh
■ 10kWh to <12,5kWh
 ■ 7,5kWh to <10kWh
 ■ <7,5kWh

Share of new registrations by battery capacity



Share of models by electric range (WLTP)



■ >60km
 ■ 55km to <60km
 ■ 50km to <55km
■ 45km to <50km
 ■ 40km to <45km
 ■ <40 km

Share of new registrations by electric range (WLTP)



Share of models by CO₂ emissions (WLTP)



■ >70 g/km
 ■ 60 g/km to <70 g/km
 ■ 50 g/km to <60 g/km
■ 40 g/km to <50 g/km
 ■ 30 g/km to <40 g/km
 ■ <30 g/km

Share of new registrations by CO₂ emissions (WLTP)



Figure 4.15: Share of PHEV models and new registrations by battery capacity, electric range and type-approval CO₂ emissions. Timeframe: 01/2015 to 03/2020. Sources: (EFahrer.com 2020; GoingElectric 2020)

Looking at the energy consumption differentiated for different vehicle segments reveals certain characteristics (Figure 4.16). Unsurprisingly, smaller segments have a lower overall energy consumption and thus tend to be located in the lower left-hand area. All-terrain vehicles have the highest driving resistances of all classes and are therefore to be found in the upper right area with WLTP CO₂ emissions well above 50 g/km, meaning that most of those vehicles will not be eligible for super-credits when calculating the CO₂ fleet average. It is remarkable the most important PHEV vehicle segments (medium cars, SUVs, large cars and executive cars) perform rather similar in terms of fuel consumption and mainly differ in power consumption. The higher the energy requirement, the larger the battery is obviously designed to stay below the limit of 50 g CO₂/km and thus to benefit from super-credits in the CO₂ fleet limits.

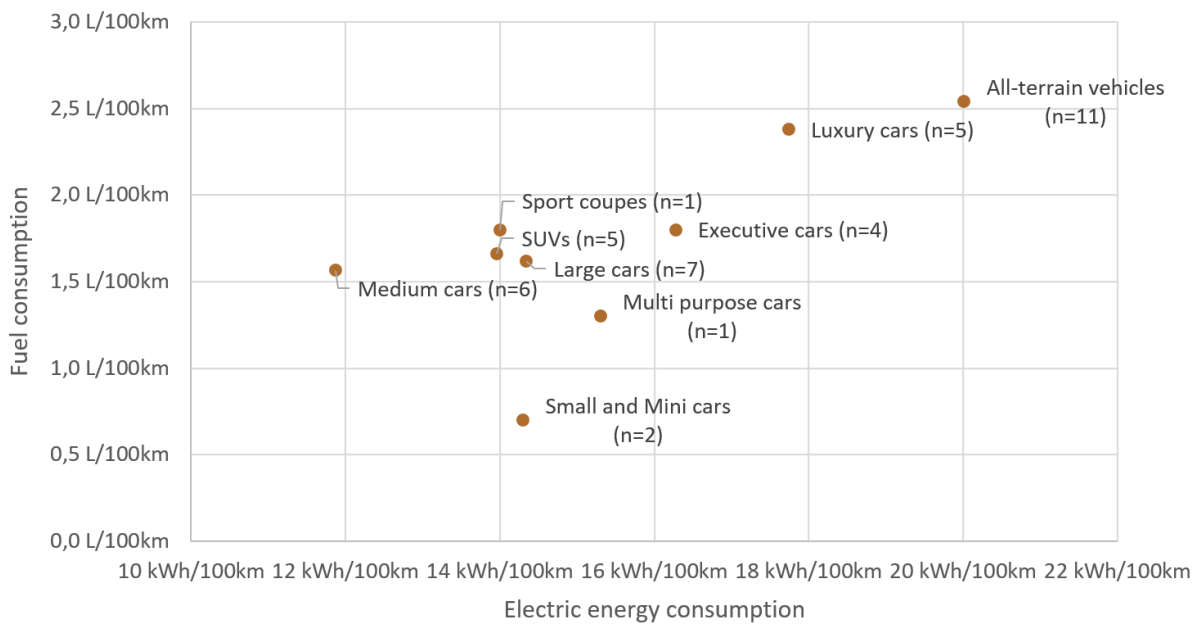

Source: (EFahrer.com 2020)

Figure 4.16: Average WLTP electric energy and fuel consumption by segment

Finally, Figure 4.17 contains a similar representation for individual vehicle models. Additionally the sales-weighted average values for fuel and electricity consumption are indicated, which are 1.8 litres/100 km and 14.4 kWh/100 km, respectively. Please note that most values are given in WLTP, but some are given in NEFZ if there was no WLTP test available for the respective vehicle.

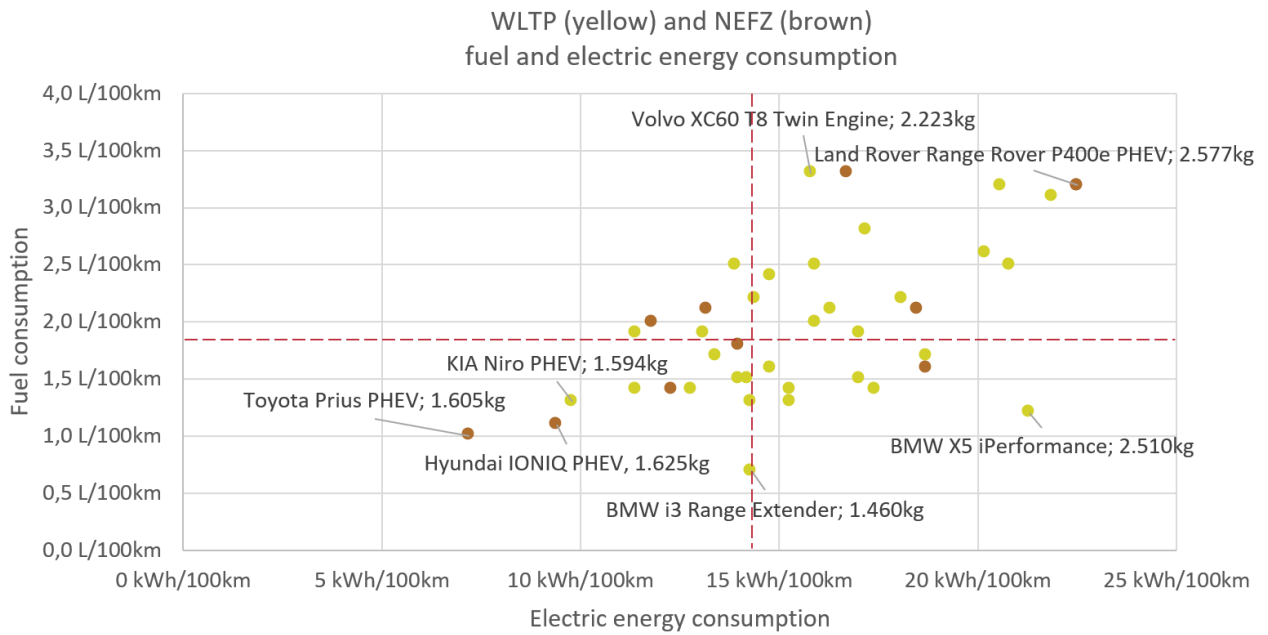

Sources: (EFahrer.com 2020; GoingElectric 2020)

Figure 4.17: WLTP and NEFZ fuel and electrical energy consumption for individual car models. The red dashed lines indicate the sales-weighted average values.

4.5 Vehicle list prices

Figure 4.18 gives an overview of the list prices (contains the value added tax) of the PHEVs available on the market. Between different models the variation of the list prices can be very high. The cheapest models start from around 35.000 € while the most expensive model (BMW i8) costs more than 140.000 €.

A share of about 40 % of the models available exceed a list price of 60.000 €. Most of the top selling models, however, cost less than 50.000 €. This includes the Mitsubishi Outlander, BMW 225xe Active Tourer and Audi A3 e-tron. Hence, the new registrations weighted average list price is about 53.000 € (see dashed red line).

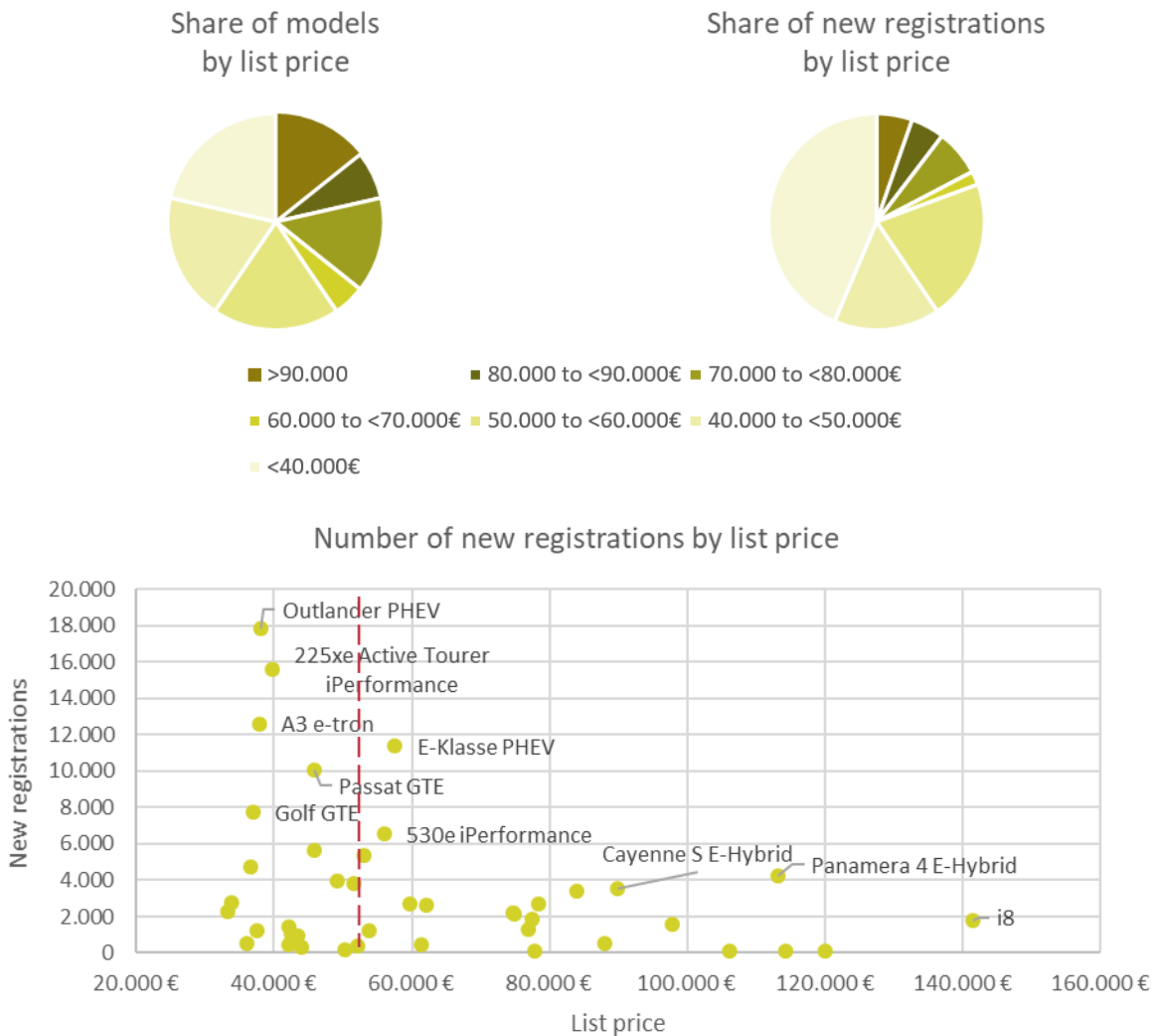

Sources: (EFahrer.com 2020; GoingElectric 2020)

Figure 4.18: Shares and number of PHEV new registrations by list price from 01/2015 to 03/2020

5 Real-world Energy Consumption of PHEV

5.1 Real-world specific energy consumption

The real-world consumption of PHEVs depends both on the specific energy consumption in electric and hybrid operation and on the frequency of electric operation ("utility factor"). Both factors can differ significantly from the values resulting from the type approval procedure. Below, available real-world data on specific energy consumption is examined. These data as well as data from mobility surveys is used to establish realistic utility factors for real-world operation in the following section 5.2.

In terms of real-world specific energy consumption of PHEV, a total of five popular European portals was examined which provide fuel consumption data at least for conventional vehicles. The following Table 2 summarizes the characteristics of the data sources as well as their limitations. Only Spritmonitor, ADAC and EmissionsAnalytics contain data based on real driving profiles or dyno tests and thus could provide "real world" electric energy and fuel consumption. EV-Database, HonestJohn and Fiches-Auto provide energy and fuel consumption values only from manufacturers' data. Data from EmissionAnalytics is only available upon purchase.

For this project a short analysis of Spritmonitor and ADAC data was carried out. We analyse these two data sources for a selection of vehicles as follows: First, we give an overview of the average fuel consumption derived from the Spritmonitor data. Second, we compare the fuel and electric energy consumption separately for the CD and CS driving modes measured in ADAC Ecotest, and draw a comparison between the resulting CD ranges and the official WLTP data. Finally, the total energy and fuel consumption between the WLTP manufacturer data and data derived from the ADAC Ecotest are compared.

Table 2: Characteristics of different fuel consumption databases

	Spritmonitor.de	ADAC.de	EV-Database.uk	HonestJohn.co.uk	EmissionsAnalytics.com	Fiches-Auto.fr
Description	Spritmonitor is a publicly accessible platform which enables users to enter empiric fuel and energy consumption of their vehicles	Is a public platform which provides technical information and dyno test data for passenger cars	Electric Vehicle Database is a public platform which provides technical information from BEV's and PHEV's	HonestJohn is a public platform which compares real-world fuel consumption with official manufacturer fuel consumption	Emissions Analytics provides independent measurement data of real-world emissions and fuel efficiency	Fiches-Auto is a public platform which provides technical data of cars
Parameters covered	Electric energy and fuel consumption, daily/annual Mileage, driving conditions	Technical specifications, prices, energy consumption in NEDC, WLTP as well as fuel consumption from dyno tests	Technical specifications, price, NEDC, WLTP and "real" energy and fuel consumption as well as electric range	Fuel consumption	Technical specifications, real driving energy and fuel consumption as well as electric range	Technical specifications, price, energy and fuel consumption as well as electric range
Data derived from	Real world driving	Dyno tests ("ADAC Ecotest")	Manufacturer data, model calculations	Manufacturer data, real-world driving	Real-world driving	Manufacturer data
Number of PHEV models covered	40	Dyno tests: 10 selected PHEVs Technical data: covers German market	44	<10	More than 1600 passenger cars, about 500 per year (all fuel types), number of PHEVs unknown	75 (includes different variants per model)
Sample size	Varies between models and users, currently about 3500 PHEV users	One dyno test procedure per car	No real world/dyno test data available	Unknown	Unknown	No real world/dyno test data available
Time covered	Varies between models and users	Recent models	Unknown	Unknown	Unknown	Unknown
Scope	Typically Germany	Germany	EU	Typically Great Britain	EU, US, Korea	EU
Type of fleet	Mixture of private and commercial cars	Test vehicles	No real world/dyno test data available	Mixture of private and commercial cars	Test vehicles	No real world/dyno test data available
Limitations	High effort to derive reliable data - Individual analysis of each user profile necessary, Electric energy consumption is not given as an average per vehicle, it must be derived from every single user	Dyno test cycle is called ADAC Ecotest, No real world data	Only manufacturer data and modelled calculation data provided, no real-world data available	Only fuel consumption data available, no electric energy consumption, just few PHEV's	Data must be purchased	Data does not include electrical energy and fuel consumption data

Spritmonitor offers PHEV users the possibility to enter and monitor their electric energy and fuel consumption data as well as additional information e.g. driving profile and behaviour of each trip. Since aggregated querying of electricity consumption is not possible on Spritmonitor and many users do not record their charging behaviour, only the fuel consumption of the registered Spritmonitor users is analysed in the following considerations. Since it cannot be checked during the analysis whether the user inputs contain inaccuracies or incorrect entries, it has to be pointed out that the values can only serve as an indication.

Table 3 shows the number of users and corresponding mileage-unweighted¹ average fuel consumption derived from Spritmonitor for both drive train configurations PHEV-Diesel and PHEV-Gasoline and additionally for the entirety of all conventional diesel and gasoline vehicles. In addition, the average WLTP fuel consumption values of the considered vehicle models according to (DAT 2019) are shown in the columns on the right.

	Spritmonitor		WLTP
	Number of users	Average fuel consumption [l/100 km] ¹	Average fuel consumption [l/100 km] ²
PHEV-Diesel	189	5.2	1.6
Diesel	34966	6.5	5.3
PHEV-Gasoline	3455	4.7	1.9
Gasoline	57102	7.3	7.0

Table 3: Comparison between Spritmonitor and WLTP fuel consumption

The table shows that PHEVs with a diesel engine have higher fuel consumption than PHEVs with a gasoline engine. This can be due to the fact that they are often large, heavy and powerful vehicles e.g. Volvo V60 D6 (5.4 l/100km), Mercedes-Benz e300de (5.4 l/100km). When compared to the combined fuel consumption of the WLTP, however, there are high deviations for both vehicle configurations. Even when compared to the models with the highest fuel consumption (PHEV-Gasoline: Porsche Cayenne S E-Hybrid, PHEV-Diesel: Mercedes-Benz E300de) there is a significant gap. When compared to the ADAC Ecotest data (see Figure 5.2 in this chapter), the fuel consumption according to Spritmonitor is in the same range (ADAC Ecotest: Between 3.1 l/100 km and 5.5 l/100 km).

In the next step, the Spritmonitor data were extracted for each vehicle model on the market according to the KBA new registration numbers from chapter 4.1. The goal was to determine the average fuel consumption per vehicle model as well as the user weighted³ average fuel consumption. Figure gives an overview of the average fuel consumption and also shows the respective number of registered users per model.

¹ Filtered Spritmonitor data from 2015 to 2020

² Vgl. (DAT 2019)

³ In comparison to the user unweighted average value the user weighted value considers the number of Spritmonitor users per vehicle model. Hence, the total average fuel consumption is weighted by the number of users per model.

Model	EU-Seg- ment	ADAC EcoTest			WLTP
		Fuel consump- tion in CS mode [l/100 km]	Electric energy con- sumption CD mode [kWh/100 km] ¹	All electric range [km] ²	All electric range WLTP [km]
Hyundai IONIQ PHEV	C	5.3	19.9	45	63
Volvo XC 40 T5 Twin Engine	C	7.9	29.6	Not pub- lished yet	45
Peugeot 508 SW Hybrid	D	6.8	23.5	49	52
BMW 330e	D	6.8	26.8	45	66
VW Passat Variant GTE	D	6.9	25.2	48	54
Kia Optima Sportswagon	D	7.0	23.4	48	62
Mercedes GLE 350 de	E	8.1	32.6	80	100
BMW X5 xDrive45e	E	10.7	41.4	62	97
BMW 745e	F	8.6	28.8	44	58

Table 4: Comparison of the energy and fuel consumption in different modes between ADAC Ecotest and WLTP

When comparing the fuel consumption in charge sustaining mode between the vehicles it can be seen that the fuel consumption ranges from 5.3 l/100 km (Hyundai IONIQ) to 10.5 l/100 km (BMW X5). This means, the BMW X5 needs about twice as much fuel, when compared to the Hyundai IONIQ. The same applies to the CD mode, in which the BMW also requires about twice as much electrical energy in comparison to the Hyundai, according to the ADAC Ecotest. As a consequence, the all-electric range in CD-mode derived from the ADAC Ecotest is about 30 % below the values according to type approval, with deviations ranging from 6 % (Peugeot 508) to 56 % (BMW X5).

In a next step the combined energy and fuel consumption of ten PHEVs tested on the ADAC Ecotest are compared to the official WLTP combined weighted numbers (Figure 5.2). To calculate combined energy consumption, the Ecotest assumes a total driven distance of 100 km, beginning with fully charged battery (ADAC 2020a). It turns out that the fuel consumption of the ADAC dyno test data is about 2,4 to 3,1 times higher (depending on the vehicle model) compared to the WLTP. The ADAC Ecotest electric energy consumption figures on the other hand are lower in comparison to the numbers derived from the WLTP (range -3% to -49%). The table shows that the electric driving share and thus the UF applied in the WLTP test procedure is significantly higher compared to the values determined by the ADAC Ecotest.

¹ (ADAC 2020b)

² Since the assumed trip distance in the Ecotest is 100 km, the values in this column can also roughly be interpreted as the utility factor (proportion of electric driving) for the Ecotest in %.

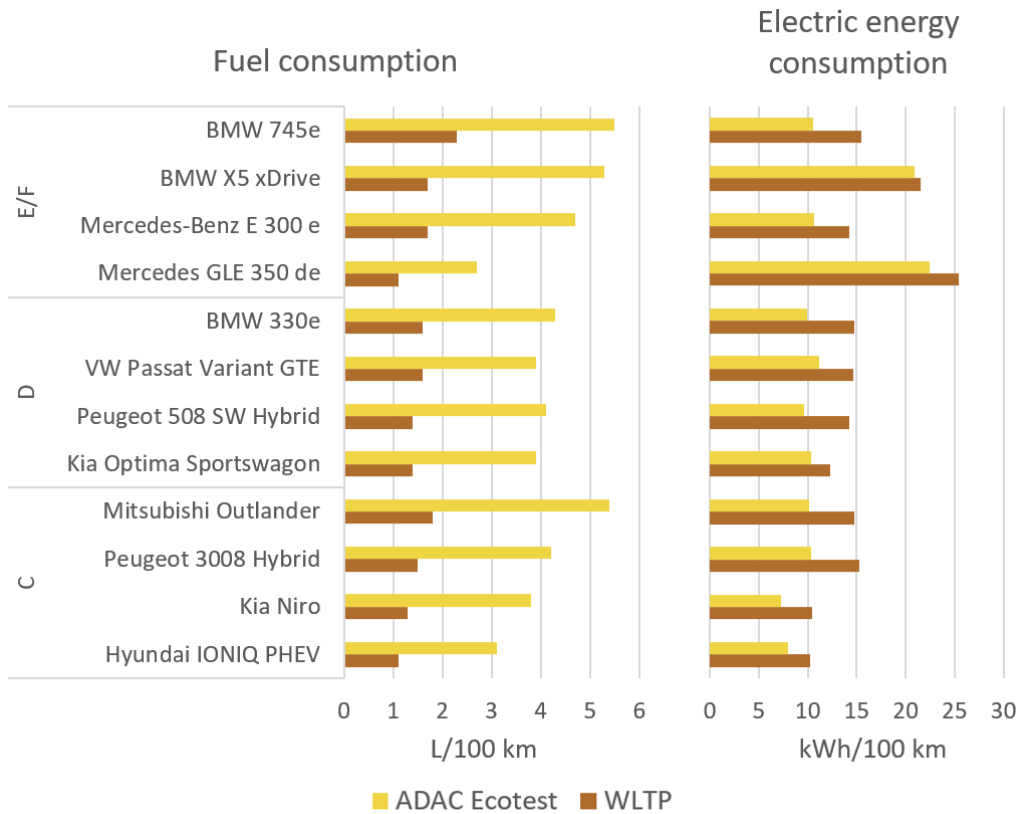

Figure 5.2: Comparison between WLTP and ADAC Ecotest fuel and electric energy consumption (combined values)

The Spritmonitor and ADAC data reflect average fuel consumption entered by users or dyno tests. However, the data cannot be used to investigate the influence of factors such as all operating modes, driving profile and weather conditions. Therefore either specific dyno or PEMS test would be necessary or a simulation model which can estimate those influencing factors. The latter approach was pursued within this study, the results are shown in section 5.3.

5.2 Real-world utility factors

Utility factors derived from Mobiliy Panel data

Using the all-electric range as an input variable, the share of electric driving (utility factor) of PHEVs can be derived on the basis of typical usage profiles from mobility surveys if assumptions are made about charging behaviour. For Germany, the mobility panel (MoP) is a popular mobility survey with a broad coverage. The vehicle usage profiles contained in the MoP were evaluated separately for private cars and company vehicles for this study. Two cases were considered for the charging behaviour: In the first case a full charge of the PHEV was assumed every night. In the second case, a full charge takes place only every other day¹. The Fleet-UFs according to (SAE 2010) were calculated using the following formula:

$$UF(R_{CD}) = \frac{\sum_{d_{k \in S}} \min(d_k, R_{cd})}{\sum_{d_{k \in S}} d_k}.$$

With d_k := daily driven distance, R_{cd} := electric range.

The population of driving profiles consists of about 5000 weekly profiles (private and company cars) from 2002 to 2014. It is assumed that PHEV owners behave like any conventional car owner in terms of the average daily driving distances. Considering that there are no range restrictions for PHEV, this is regarded as a valid assumption, as long as there is no comprehensive dataset available which describes significant peculiarities of PHEV driving patterns in Germany.

Figure 5.3Figure shows the resulting utility factors for the considered cases as a function of the all-electric range. While the utility factor according to the WLTP method is in the range of about 60% to 80% for all-electric ranges between 30 and 60 km (which represents the current market reality), it is lower for the MoP profiles, but to varying degrees depending on the user group and charging assumption: If one assumes a daily full charge for private users in the MoP, the UF is roughly in the range of the WLTP curve. For company cars, however, it is about 25 % lower. If charging is only carried out every other day, the electric driving shares are reduced by about 10 % in each case.

¹ In the MoP, the usage of the individual vehicles is monitored for the duration of one week. The case of charging every other day was modelled by assuming a full overnight charge on Sunday, Tuesday, Thursday and Saturday.

private cars, the data on the company cars also provide reliable initial findings. The main results are as follows:

- The empirically observed fuel consumption figures vary widely, but almost completely exceed the NEDC type-approval values by some factor. The ratio between real consumption and NEDC value ranges from 100% to up to 600% of NEDC fuel consumption.
- In general, the empirically observed UFs are mostly below the curve specified by the type approval in NEDC.
- The additional fuel consumption of company cars is much more pronounced than that of private vehicles (see Figure 5.4). This is mainly explained by the significantly lower proportion of electric driving compared to private vehicles.
- The utility factor clearly depends on the annual mileage of the vehicle. One reason for this is that higher annual mileage also means higher daily mileage on average and thus more distance between two overnight charging processes. On the other hand, the average range of a trip increases with the annual mileage.

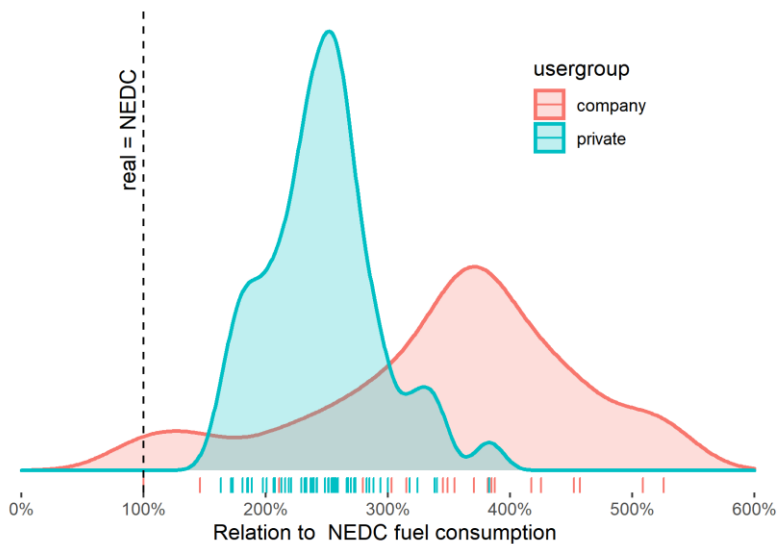

Figure 5.4: Relation to NEDC test-cycle fuel consumption by user group. Source Fraunhofer ISI based on (Plötz et al. 2020)

According to the Fraunhofer ISI evaluation, the current average UF is 45 - 50 % for privately used vehicles and 7 - 17 % for company cars in Germany. The average UF increases with the range. Assuming a mean correlation of $UF = 1 - \exp(-\text{Range}/L)$ the following values (non-linear regression using the least squares method) result for the best fit ± 2 standard deviation:

- Private cars: $L = 80 \pm 5$ km
- Company cars: $L = 330 \pm 160$ km

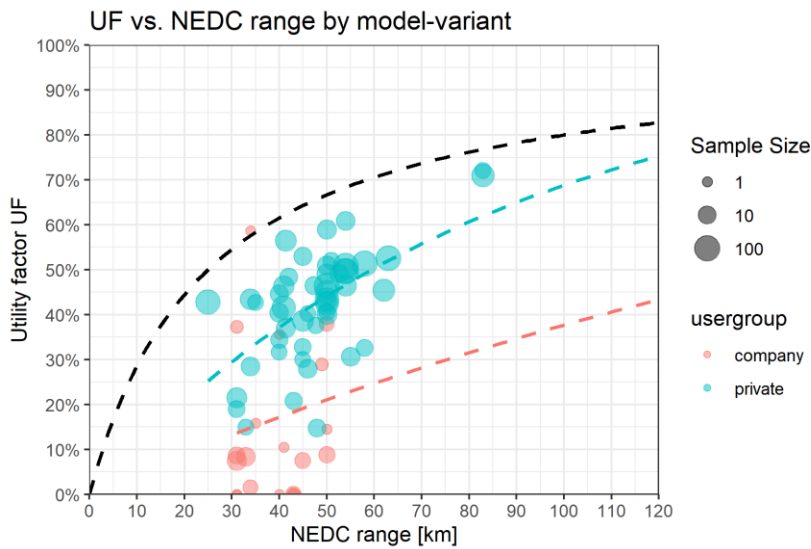

Figure 5.5: UF vs. NEDC range by model variant. Source Fraunhofer ISI based on (Plötz et al. 2020)

Comparison of modelled, empirical and WLTP utility factors

In Figure 5.6, the resulting curves are compared to the utility factors previously derived based on mobility surveys. It can be seen that the empirically determined electric driving shares for the status quo are once again significantly lower than the modelled values for a charge on every other day. This probably also reflects the fact that for a significant number of today's PHEVs no infrastructure exists for regular charging of the vehicle. This is particularly true for PHEVs used as company cars. They receive massive tax incentives, but for many users it is economically irrational to charge them regularly, given the fuel card provided by their employer. However, it also has to be taken into account that company cars in the observed sample tend to have lower electric ranges (see Figure) and higher annual mileages (company cars: 29.500 km; private cars: 21.500 km). These factors bring down the effective utility factor significantly and limit possible UFs in real-world regardless of the users' charging discipline.

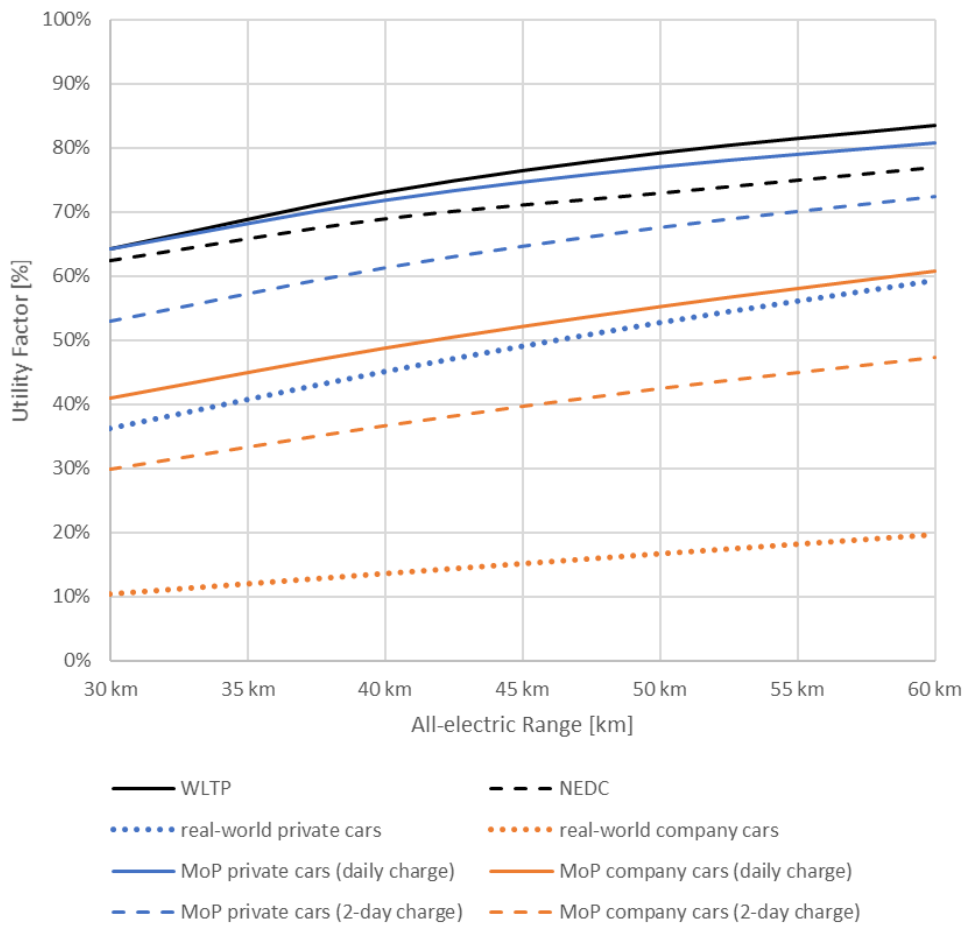

Figure 5.6: Resulting utility factors according to type-approval (NEDC and WLTP), based on the mobility panel as well as based on empirical data from Fraunhofer ISI (see Figure 5.5).

According to EU Commission Regulation 2018/1832, fuel consumption of new vehicles determined by On-board fuel consumption meters (OBFCM) must be made available to the EU Commission for monitoring purposes from the beginning of year 2021. This could provide far more reliable information on fuel consumption and utility factors in everyday use across the entire fleet than has been possible with the comparatively small samples used so far. It remains to be seen how granular the data will be available. This is decisive for the possibility of using this data through regulatory instruments and is discussed again in chapter 9.

5.3 Sensitivities of Energy Consumption

The previous sections show that there is considerable bandwidth in the real-world consumption of individual PHEV models. In the following, important factors influencing this bandwidth will be examined in more detail. For this purpose, we will look at an example vehicle that is based on the Mercedes E300e PHEV in terms of its technical parameters. This vehicle model currently has a high market relevance in Germany particularly among company cars. We calculate the fuel and electricity consumption for the example vehicle under different conditions using the ifeu vehicle simulation model VEHMOD (Kräck et al. 2015).

It should be noted that the simulation does not claim to represent the Mercedes E300e exactly. Rather, the simulated vehicle model was calibrated for the E300e using known vehicle parameters and measured values.

Definition and vehicle characteristics of example vehicle

The Mercedes E300 is available as a plug-in hybrid in a diesel version (E300de) and a petrol version (E300e). The E300(d)e belongs to the EU segment of executive cars (Segment E) and was one of the best-selling PHEVs on the German vehicle market in recent months (11.368 new registrations from 2015 to 03/2020, thereof 7.503 from 2019 to 03/2020, share on the PHEV market: 7.6%). Key technical data on the gasoline version of the E300e are summarized in Table 5. The Mercedes E-Class is particularly popular as a company car, with commercial registrations accounting for around 74% of the total (KBA 2020b).

Table 5: Key parameter assumptions for the chosen example vehicle (similar to Mercedes E300e)

Vehicle mass	2005 kg ¹
Battery capacity	13.5 kWh ²
Frontal Area	2.28 m ²
Aerodynamic drag	0.27 ²
Rolling resistance	0.0090
System power	235 kW ²
Engine Power	155 kW ²

With combined CO₂ emissions in the WLTP of 38 g/km, the model meets eligibility criteria for PHEV subsidies and privileges in Germany. Table 6 compiles the consumption values of the vehicle from the type-approval process and real data sources known to us.

Table 6: Comparison of the Mercedes E300e's fuel and electric energy consumption

Fuel consumption [l/100 km]			Electric energy consumption [kWh/100 km]		All electric range [km]	
WLTP ³	ADAC Ecotest ⁴	Spritmonitor ⁵ Min/Avg/Max	WLTP ³	ADAC Ecotest ⁴	WLTP ⁴	ADAC Ecotest ⁴
1.8	4.7	2.7/6.7/14.1	16.7	10.7	50	44

¹ (GreenCarGuide 2020)

² (Mercedes-Benz 2020)

³ (Mercedes Benz 2020)

⁴ (ADAC n.d.)

⁵ (Fisch und Fischl GmbH 2020)

Simulation in HBEFA and WLTC test cycles

Based on the known technical parameters and its WLTP consumption, the vehicle was calibrated in VEHMOD and the consumption values for different cycles were determined in CD mode and CS mode. The following Figure 5.7 shows cumulated power and fuel consumption and the SOC over the distance driven for the WLTP simulation.

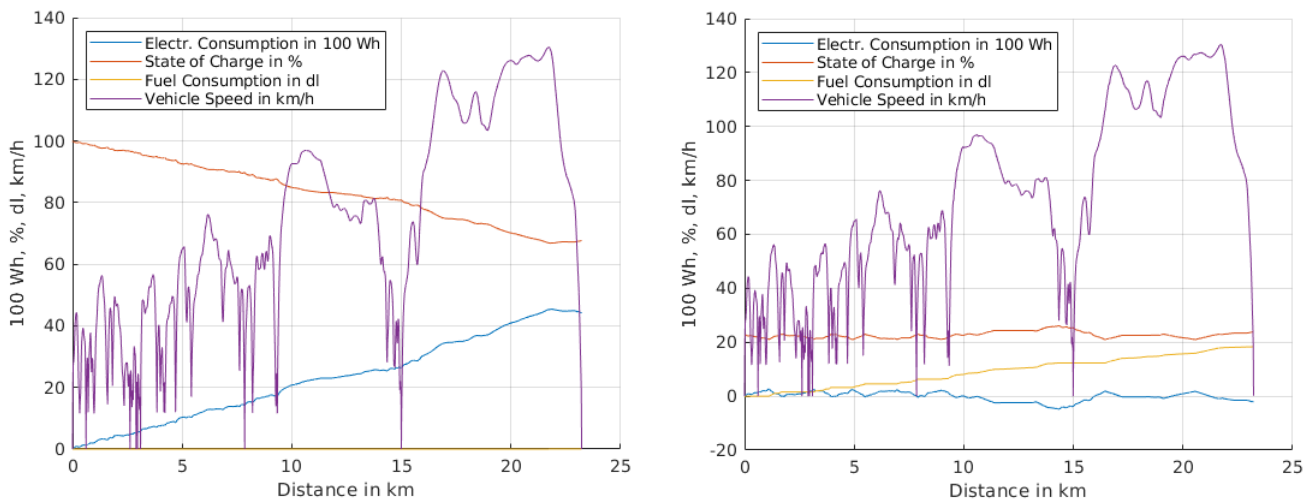

Figure 5.7: WLTC-Simulation in CD mode (left) and CS mode (right) with VEHMOD (own calculations)

A better approximation of traffic conditions on German roads is delivered by the driving cycles of the “Handbuch der Emissionsfaktoren” (HBEFA; current version: HBEFA 4.1)¹. The inner-urban, extra-urban and freeway traffic are each characterized by a certain combination of traffic situations. For the mentioned road categories, the consumption of the Mercedes E-Class PHEV was calculated by VEHMOD based on the HBEFA cycles. The simulation results for fuel and power consumption are shown in Table 7, the direct comparison of essential parameters between HBEFA cycles and WLTC is shown in Figure 5.8.

¹ (TU Graz 2019)

Table 7: Simulation results for example vehicle on different road types using HBEFA cycles and WLTC (own calculations)

	HBEFA			WLTC		
	urban	extra-urban	motor-way	urban	extra-urban	motor-way
Electric Consumption CD-Mode [kWh / 100 km]	25.9	22.9	22.9	19.2	18.1	22.9
Fuel Consumption CD-Mode [Liter / 100 km]	0.0	0.0	2.0	0.0	0.0	0.1
Electric Consumption CS-Mode [kWh / 100 km]	0.3	-2.1	-1.0	3.6	-7.4	2.0
Fuel Consumption CS-Mode [Liter / 100 km]	10.2	8.6	9.9	6.3	10.0	7.4
Estimated Range in CD-Mode [km]	41.7	47.2	47.2	56.2	59.6	47.2

Overall, the consumption values using the HBEFA cycles are considerably higher than in the WLTC, but there are significant differences between the individual sub-cycles in urban, sub-urban and freeway areas. The vehicle can complete the urban and extra-urban sections in both cycles without switching on the combustion engine when the battery is charged (CD mode). The electricity consumption in the HBEFA cycles exceeds the values modelled in WLTC by about 35% (urban) and 26% (extra-urban). The main reasons for this are the consideration of auxiliary consumers in the HBEFA cycles and the fact that a higher payload is assumed. The increased electricity consumption results in a reduction of electric range in urban and extra-urban areas of 26 % and 21 %, respectively. On the freeway sections, the combustion engine kicks in in both HBEFA and WLTP cycles, but runs much shorter in the WLTP freeway cycle than in the HBEFA freeway cycle. The reason is the shorter duration of high speeds above 120 km/h in the WLTC.

At low battery level (CS mode) the operating dynamics are more complex. In this case, the electric motor is temporarily supported in the city to enable the combustion engine to switch off. For extra-urban driving, on the other hand, the operating strategy often causes an increase of engine power output in order to increase its efficiency while charging the battery, which is reflected in negative power consumption. On the highway, the electrical part of the powertrain is mainly used to provide additional power at short notice ("boosting"). However, the ratio of power and fuel consumption in CS mode is strongly dependent on the length of the driving cycle and therefore has only limited significance.

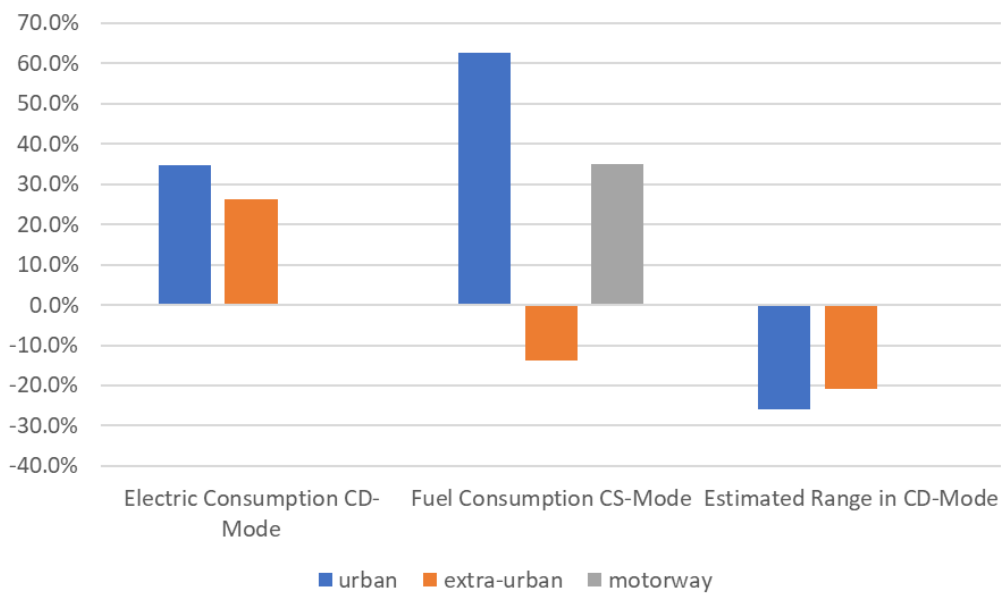

Figure 5.8: Discrepancy of electric consumption, fuel consumption and all-electric range for the example vehicle in HBEFA cycle simulation as compared to WLTP (own calculations)

Sensitivity on operating modes

Up to this point, the simulation has always been based on the vehicle's default operating mode ("hybrid mode"), in which the vehicle automatically determines the most efficient operating mode (see section 2.2). In order to determine the influence of a different choice of operating mode by the user, the simulation was also carried out for the "E-mode" and the "Sport Mode". Since the choice of the operating mode is particularly noticeable in dynamic driving, a different, relatively demanding cycle was chosen (Figure 5.9).

The speed and state-of-charge curves shown in Figure 5.9 show significant differences. In electric mode, the speed is assumed to be limited to 130 km/h. The time-speed profile of the hybrid and sport mode is identical in some parts, but higher accelerations are achieved in the sport mode only when steep climbs start suddenly. However, the SOC curves show that the combustion engine tends to be used more intensively in sport mode even with the same time-speed profile.

The resulting energy consumption in the different modes is compared in Figure 5.10. Compared to the hybrid mode, the electric mode shows a significant reduction in consumption of about 2 liters of gasoline per 100 km, which is due to the assumed limitation of top speed to about 130 km/h in electric mode¹. In sport mode, the model shows an increase in fuel consumption of 0.7 liters per 100 km. However, this value can only serve as an indication, as the exact design of the operating modes can vary greatly for specific vehicles.

¹ Whether or not the electric operating mode effectively limits the top speed of the car in order to maintain electric driving, depends on the implementation of the electric operating mode in individual vehicle models.

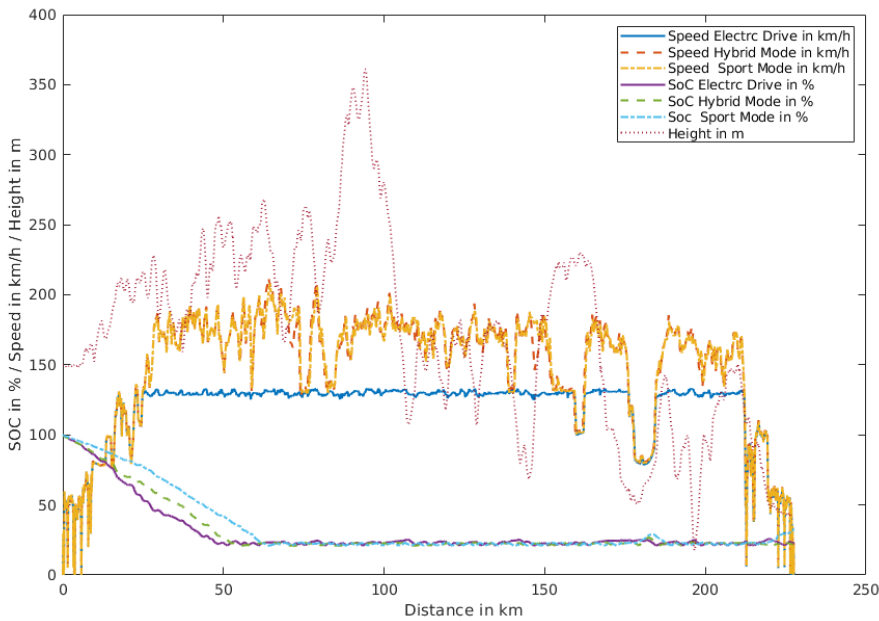

Figure 5.9: Progression of actual speed and state of charge for the example vehicle in different operating modes in a demanding drive cycle with significant slopes.

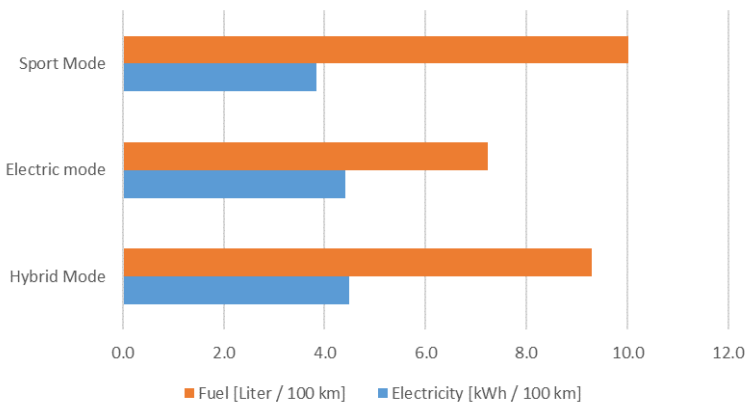

Figure 5.10: Specific electricity and fuel consumption of example vehicle for the considered demanding driving cycle in different operating modes (own calculations)

Sensitivity on outside temperature

The outside temperature affects energy consumption of PHEVs in several ways. On the one hand, the auxiliary consumption for heating and cooling is strongly dependent on the outside temperature, and on the other hand the performance and storage capacity of the traction battery as well as the charging capacity. To illustrate these effects, the technical data of the Mercedes E300e were used as far as possible and unknown parameters were estimated.

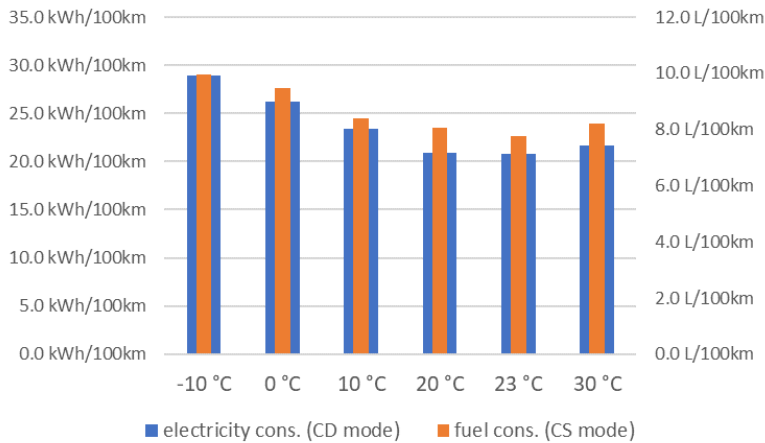

Figure 5.11: Electric and fuel consumption according to WLTP for example vehicle in different ambient temperatures (own calculations)

On this basis, the energy consumption in WLTC (standard hybrid mode) at 0 °C, 10 °C, 20 °C, 23 °C and 30 °C was determined. The results are shown in Figure 5.11. At low temperatures, especially the power consumption rises sharply (at -10 °C + 35% compared to 23 °C), since the interior must be heated by the battery. In CS mode, the additional fuel consumption is somewhat less pronounced at 28%, since waste heat can be used here. There are indications that some PHEV models will turn on the combustion engine at low temperatures even when electric mode is activated (Jolly 2020). One reason for this is probably the manufacturers' efforts to avoid high power consumption and thus rapid battery depletion.

Discussion

The sensitivity analysis described in this section showed a significant increase in energy consumption when using realistic driving profiles compared to the WLTP, in line with the measurements analysed in section 5.1. The electric range under real conditions is thus considerably less than that according to WLTP. A comparison of different operating modes selectable by the user shows noticeable differences in consumption during dynamic cycles. In order to estimate their effects on real-world CO₂ emissions, however, additional information about the driving profiles of individual users and their respective choice of operating mode would be necessary. With variation of the outside temperature, finally a strong increase of the current consumption shows up, connected with drastically reduced electrical ranges at low temperatures. This has been confirmed by a large number of previous studies at BEV and PHEV.

5.4 Average energy consumption estimates per vehicle segment

The goal of this section is to derive energy consumption estimates, utility factors and thus real-world CO₂ emission performance for different vehicle segments as of today. Starting from this baseline, a projection for technological development and CO₂ emission performance until 2030 is conducted in chapter 7.

For the allocation of vehicles to different segments there are different approaches (ifeu 2016). In Germany for example the Kraftfahrtbundesamt (KBA) has defined 13 different vehicle segments (Kraftfahrtbundesamt 2020c). Across Europe vehicles are mostly subdivided according to REGULATION (EEC) No 4064/89 (European Commission 1999) of the European Commission. In this regulation cars were allocated to nine different vehicle segments. For allocation, both KBA and European Commission use a number of criteria e.g. engine size or length of the car.

For the scenario calculations of the project, EU vehicle categories were combined to some extent in order to cover important differences with limited calculation effort. In total, four vehicle categories B, C, D and E/F were considered. EU vehicle category A is neglected since no PHEVs are currently available on the market in this category. For SUVs additional information about the size class was available from the IHS Markit data (some SUVs share the same vehicle platform with non SUVs models). With this additional information SUVs and multi-purpose cars were allocated to the corresponding segments B, C, D and E/F. A Volvo XC40 for example is classified as a Medium SUV (Segment JC) and is allocated to segment C. Within the sports cars segment only the BMW i8 was available and is considered to be a niche application for PHEVs (market share about 1 %). Segment E and F were combined to one segment (segment E/F), because Luxury Cars (F) account for just 8 % of the total new registrations. In total, the four defined categories represent 98,8 % of the actual number of PHEVs registered in Germany from 2015 to March 2020.

Table 8 gives an overview of the European and KBA vehicle segments. In addition, in the column on the right hand side, the allocation to the four categories used for the scenario calculations are shown (indicated green).

Table 8: Allocation of the vehicle segments for energy consumption modelling

EU Abbreviations	EU Segments	KBA Segments	Segments for scenario calculations
A	Mini Cars	Mini	Not considered, no vehicles available
B	Small Cars	Kleinwagen	Small Cars, SUVs, Multi purpose Cars
C	Medium Cars	Kompaktklasse, Utilities	Medium Cars, SUVs, Multi purpose Cars
D	Large Cars	Mittelklasse	Large Cars, SUVs, Multi purpose Cars
E	Executive Cars	Obere Mittelklasse	Executive Cars, SUVs, Multi purpose Cars, Luxury Cars
F	Luxury Cars	Oberklasse	Allocated to E
S	Sport Coupes	Sportwagen, Cabrios	Not considered, niche application
M	Multi purpose Cars	Mini-Vans, Großraum Vans	Allocated to B,C, D, E
J	SUVs	SUVs, Geländewagen	Allocated to B,C, D, E

With the definition of the vehicle segments, the technical specifications for each segment were derived from the KBA market data in combination with the efahrer.chip data (EFahrer.com 2020). For this purpose, average values regarding empty weight, total power and battery capacity were derived for each segment. When deriving this data, SUVs were also considered in the respective categories B to E/F. Table 9 gives an overview of these values.

Table 9: Technical specifications per segment (2020)

Segment	Share in new registrations in Germany %	Average total power [kW]	Average empty weight [kg]	Average battery capacity [kWh]
B	3.8	125	1460	11
C	44.8	146	1711	10
D	21.0	204	1929	11
E/F	29.2	271	2210	13

In combination with further assumptions ($c_w \cdot A$, wheel radius, gear ratio, and final drive ratio) the electric and fuel consumption were calculated for these segments using ifeu's vehicle simulation model VEHMOD (Kräck et al. 2015). In order to get a real-world approximation, the driving cycles of the Handbuch der Emissionsfaktoren (HBEFA) have been used (TU Graz 2019).

Table 10: VEHMOD results for energy consumption of generic vehicle segments (PHEV 2020)

Segment	Electricity consumption in CD mode [kWh/100 km]			Fuel consumption in CS mode [l/100 km]		
	HBEFA	WLTP	HBEFA/WLTP	HBEFA	WLTP	HBEFA/WLTP
B	19.7	18.8	+ 5%	6.7	5.9	+ 14%
C	21.9	20.3	+ 8%	7.6	7.0	+ 9%
D	23.6	21.9	+ 8%	8.9	8.0	+ 11%
E/F	24.7	22.8	+ 8%	10.4	10.2	+ 2%

The results of the VEHMOD simulations are summarized in Table 10. Larger segments tend to have higher energy and fuel consumption in comparison to smaller segments. This is mainly because of the higher weight as well as the tendency to have a higher total power. The gap in terms of energy and fuel consumption between the HBEFA and WLTP cycles is about 10 %.

Table 10 shows the VEHMOD simulation results for the energy consumption along with the empirical-based utility factors for each vehicle segment in private and company car operation. In addition, the resulting tailpipe CO₂ emissions are shown for the two user groups as well as for simulation of the respective vehicle segment in WLTP.

Table 11: Energy consumption and utility factor for the vehicle segments and usage patterns (PHEV 2020)

Segment	Electricity consumption in CD mode [kWh/100 km]	Petrol consumption in CS mode [l/100 km]	Observed utility factor ¹		Tailpipe CO ₂ emissions [g/km]		
			Private cars	Company cars	Private cars	Company cars	WLTP
B	19.7	6.7	45.1	13.5	85.3	134.3	36.2
C	21.9	7.6	38.7	11.2	108.5	157.2	51.4
D	23.6	8.9	39.4	11.4	124.9	182.6	58.2
E/F	24.7	10.4	43.2	12.8	137.7	211.3	64.4

The results show that the real world CO₂-emissions are significantly higher when compared to the WLTP CO₂-emissions. This relates to both private cars and company cars and is true for all vehicle segments. The deviation range between WLTP and real world emissions is between 111 % (Private Cars, Segment C) and 271 % (Company cars, Segment B). The table also shows the large differences of the usage patterns and thus also CO₂ emissions between private cars and company cars. Since the UFs of company cars are significantly lower in comparison to the UFs of private cars (about 12% compared to about 40%, depending on the vehicle segment), the CO₂ emissions of company cars are about 50 % higher when compared to private cars.

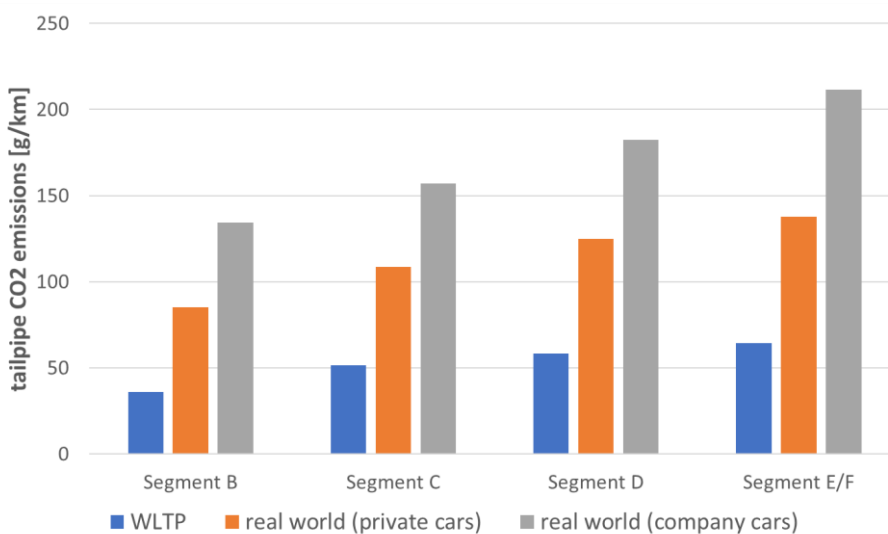
Figure 5.12: Tailpipe CO₂ emissions for defined vehicle segments, baseline 2020 (own calculations)

¹ Utility factors are calculated for the all-electric range of the respective segment based on empirical observations in (Plötz et al. 2020)

6 Evolution of PHEV technology, market and utilization until 2030

This chapter lays out several of the technical and market parameters used as assumptions for forecasting PHEV fleet CO₂ emissions in chapter 7. Furthermore, assumptions regarding PHEV utilization in the next years are deducted. Technical assumptions are mainly based on a forecast of light duty vehicle production in the EU performed by IHS Markit (IHS Markit 2019) and acquired by T&E in early 2020. In a 2019 report, T&E evaluated the expected supply of BEV and PHEV models in Europe based on this data (Transport & Environment 2019). The forecast covers the period 2020 to 2027 and assumptions for 2028, 2029 and 2030 in this report are obtained with a linear forecast of the data.

6.1 Model availability and production forecast

The availability of PHEV models increases rapidly in 2020 as PHEVs are an important means for carmakers to comply with CO₂ fleet emission targets (95 g/km beginning in 2020). Overall, the total number of PHEVs on the market is expected to increase up to 140 models in the mid-2020s. Along with the number of available PHEV models, also the European production for PHEVs would increase from about 1% of total EU car production in 2019 to 4% in 2020 and 6% in 2021, according to IHS Markit. Subsequently, the share of production of PHEV is likely to continue increasing up to 2025 and then 2030 as carmakers need to reach new CO₂ reduction targets. PHEVs would account for 10% of EU car production in 2026 and 2027 according to the forecast.

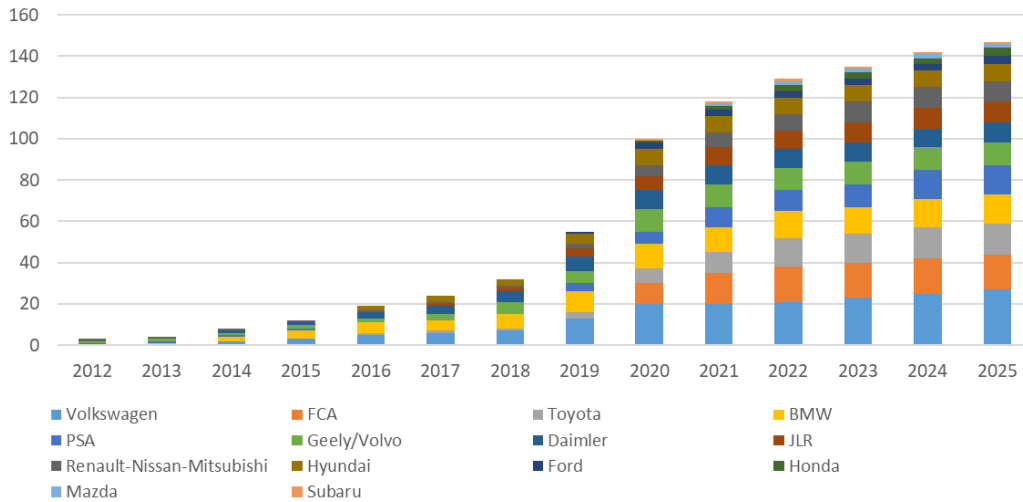

Figure 6.1: Number of available PHEV models on the EU market by manufacturer. Source: (IHS Markit 2019)

It can be noted that the share of PHEV production varies greatly from one vehicle size category to another. In the mini (A) and small (B) vehicle categories, there is no (A) or low (B) production of PHEV expected. Indeed, it is technically and economically easier to fit both electric motor (and battery) and combustion engine in a larger vehicle. Therefore, in the large (D) and executive (E) segments, PHEV account for close to 20% of the production in 2026 and 2027. For sports cars, however, PHEV are neither presently observed on the market¹ nor expected for the future in a significant amount.

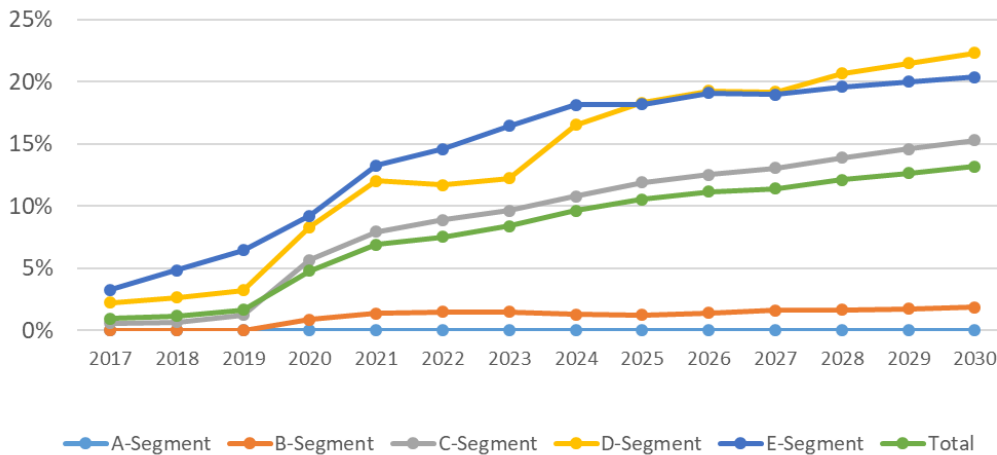

Figure 6.2: PHEV share in European vehicle production per segment. Source: (IHS Markit 2019)

It is expected that the imports and exports of PHEV from the European market would roughly balance each other out while there would be a surplus of exported internal combustion vehicles to other markets which could mechanically increase the share of PHEV sales in the EU beyond the figure for the share of production presented here.

¹ The BMW i8 has been the only PHEV sports car on the market, but is not produced any longer.

In 2020, T&E has published a report which builds upon a EU Green Deal compliant scenario for EV roll-out. In this scenario, T&E has calculated that on average at EU level there would be about 8% PHEV sales (15% BEV sales) in 2025 and 13% in 2030 (40% BEV sales)¹. In this scenario, T&E assumes 65%/35% split between BEV/PHEV in 2025 and 75%/25% BEV/PHEV in 2030 based on expected market trends and technological improvements.

The number of PHEV registrations in Germany depends on both EU CO₂ emission standards and national policy measures, such as purchase premiums, charging infrastructure, incentives for company cars, and fuel taxes or CO₂ prices. Interaction of national and EU level policies result in some level of uncertainty regarding the allocation of xEV vehicles to the European market. For the scenario analysis, the T&E market shares for PHEV sales on EU level are used for Germany.

6.2 Evolution of technical vehicle parameters

Technical parameters of the PHEV expected on the market in the upcoming years were also derived based on IHS Markit data. However, absolute averages of key technical parameters like battery capacity, power and vehicle mass have been calibrated for the status quo to the PHEV sales statistics for Germany.

The results for the parameter evolution are depicted in the following diagrams. The average battery capacity of PHEVs produced in the EU increases from 11.8 kWh in 2020 to 13.3 kWh in 2027 and 14.2 kWh in 2030. The average system power of PHEVs increases from 184 kW in 2020 to 205 kW in 2030. The vehicle mass is not included in the IHS Markit database. However, the correlation between weight and power is rather strong and vehicle power is a good proxy for vehicle mass. Linear regression shows the correlation factor to be $R^2=0.73$. The power-to-weight ratio is not expected to evolve much in the future given that the use of lightweight materials could increase this ratio but PHEV will also be using more on-board treatment systems (Euro 7) and other technologies (infotainment, digital screen, sensors, connectivity) which would balance the effect from the former. Thus, the vehicle mass was assumed to increase proportionally with the vehicle power. We assume the average PHEV vehicle mass to increase from 1,853 kg in 2020 to 2,079 in 2030.

¹ (Transport & Environment 2020)

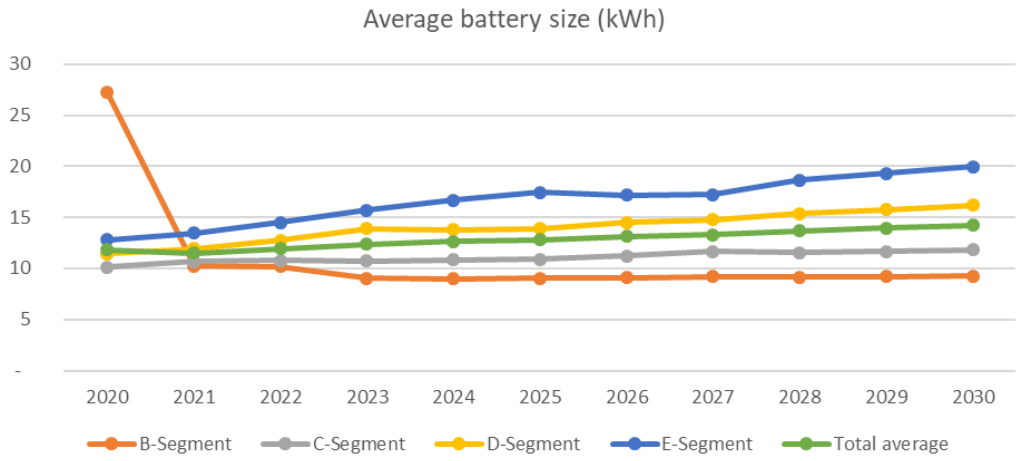

Figure 6.3: Average battery capacity in the considered vehicle segments (IHS Markit data, calibrated to German PHEV market)

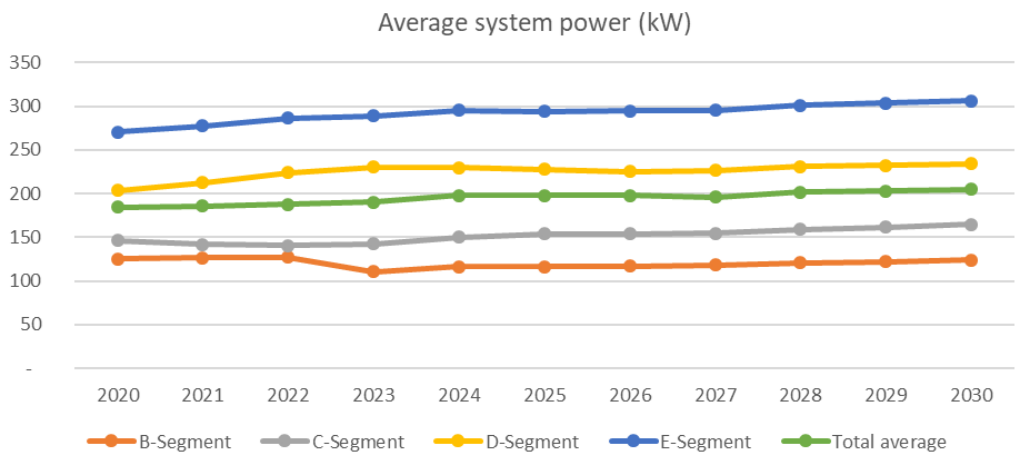

Figure 6.4: Average system power in the considered vehicle segments (IHS Markit data, calibrated to German PHEV market)

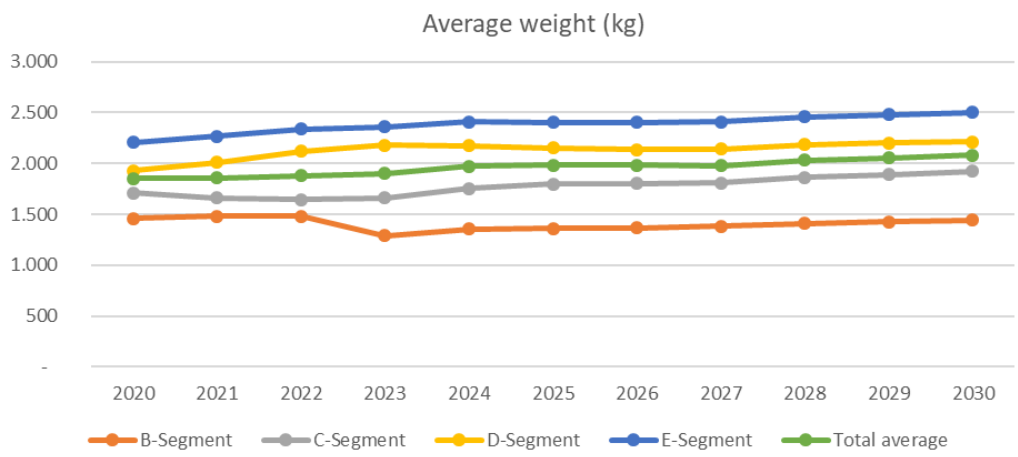

Figure 6.5: Average vehicle mass in the considered vehicle segments (IHS Markit data, calibrated to German PHEV market)

6.3 Vehicle Utilization and specific energy consumption

Specific energy consumption

The specific energy consumption of the PHEV fleet for the following scenarios was determined using the vehicle simulation model VEHMOD. For the year 2020 (baseline), the consumption values determined in section 5.4 were determined for four generic vehicle segments. These consumptions were compared with empirical data of current PHEVs. The driving profile was based on the cycles of the Handbook of Emission Factors (HBEFA) in a composition typical for operation on German roads (TU Graz 2019).

Table 12: Technical specifications per segment (PHEV 2020+2030)

Segment	Average total power [kW]		Average empty weight [kg]		Average battery capacity [kWh]	
	2020	2030	2020	2030	2020	2030
B	125	124	1460	1445	11	9
C	146	165	1711	1924	10	12
D	204	234	1929	2215	11	16
E/F	271	306	2210	2500	13	20

For the year 2030 the energy consumption for the same vehicle segments was simulated taking into account the development of technical parameters derived in section 6.2. The vehicle parameters derived for the simulation are shown in Table 12, the simulation results are presented in Table 13. With regard to the driving profile, no significant changes are expected in the fleet average, so identical assumptions are made as for the year 2020 (with the exception of the utility factor, see below). Although a significant penetration of the fleet with autonomous vehicles could lead to changes in the driving profile, this is considered unlikely by 2030. From a regulatory point of view, the introduction of a general speed limit could potentially cause relevant changes in the medium term and also have a noticeable impact on specific consumption in motorway traffic. However, no such limitation is currently planned.

In order to be able to compare the results of the scenario calculations with an emission development based on the type approval values, fuel and electricity consumption were also simulated in the WLTC for the defined vehicle segments.

Table 13: VEHMOD results for energy consumption of generic vehicle segments (PHEV 2020+2030)

Segment	Electricity consumption in CD mode [kWh/100 km]				Fuel consumption in CS mode [l/100 km]			
	HBEFA		WLTP		HBEFA		WLTP	
	2020	2030	2020	2030	2020	2030	2020	2030
B	19.7	17.9	18.8	16.8	6.7	6.2	5.9	5.7
C	21.9	19.9	20.3	18.6	7.6	7.2	7.0	6.3
D	23.6	21.8	21.9	20.3	8.9	8.7	8.0	7.8
E/F	24.7	23.7	22.8	21.6	10.4	11.2	10.2	10.4

Vehicle ownership

Vehicle ownership may significantly influence usage patterns and annual mileage. We differentiate between company cars (provided to employees as part of the salary) and other cars (mainly private, but also other commercial cars).

As shown in section 3, 83% of new vehicle registrations of PHEVs between January and April 2020 were made by commercial users and the share of commercial PHEV in vehicle stock (as of Apr 1st 2020) is 58%. Commercial registrations include not only company cars provided as part of the salary, but also other commercial vehicles and registrations by automobile manufacturers and car dealers. A share of 60% of company cars within commercial vehicles is assumed based on (Oeko Institut 2017), which corresponds to a share of 50% company cars of PHEV registrations (=83%*60%).

The share of 50% company cars within registrations of PHEVs is assumed to remain constant until 2030. We assume an average use phase of 3.5 years until company cars are sold on the 2nd hand market (typically to private owners). This “trickle-down” effect results in an increasing share of PHEVs owned by private users.

As soon as vehicles registered as company cars are sold to private owners, use patterns (i.e. annual mileages and utility factors) change according to the assumptions described below.

Survival curves

Survival curves in German vehicle stock are taken to be the same as for diesel cars, as use patterns seem to be similar to diesel cars.

Annual mileage

Annual mileage of vehicles varies with main influencing factors being ownership (private vs. company cars), powertrain, vehicle age and segment. Vehicles with higher purchase prices and lower operating costs such as diesel cars typically have higher annual mileages than petrol cars. Data from the mobility panel shows that company cars provided for employees as part of the salary tend to have high annual mileages (diesel: around 35,000 km on average and petrol around 17,000 km). Data shows averages over the three last available years from the German Mobility Panel (2016/17 – 2018/19).

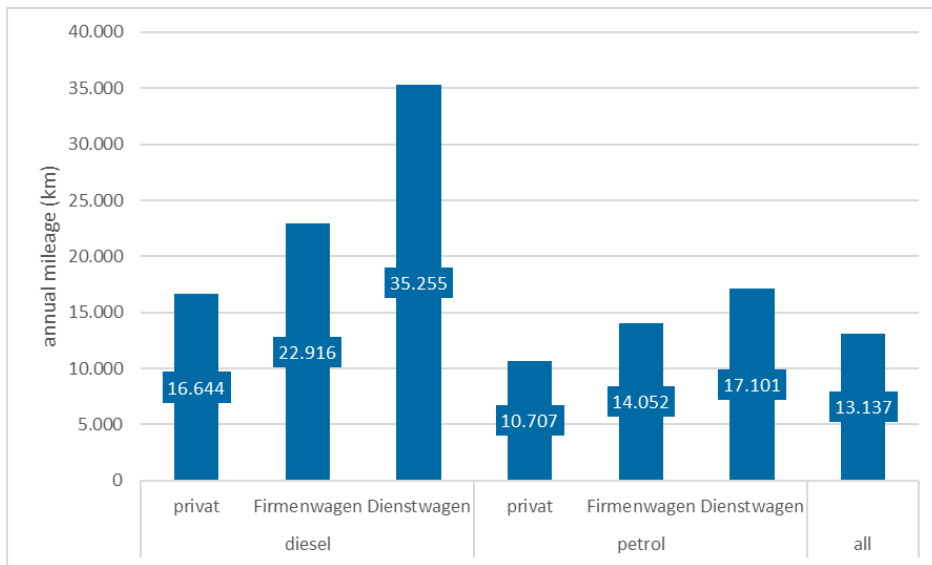

Figure 6.6: Annual mileage of petrol and diesel cars in Germany by user (Source: Moibility Panel, 2016/17-2018/19)

In real-world data compiled by ISI, observed average annual mileages of PHEVs were 21,500 for private cars and 29,500 for company cars. PHEV typically have similar attributes as diesel vehicles (high purchase prices and low operating costs). A use pattern comparable to diesel cars seems plausible. Over time, with rising vehicle age, average mileages especially for privately owned cars may decrease over time.

Based on this data, the following assumptions are made for scenario calculations regarding annual mileages:

- Average annual mileages for 2020 for PHEVs are taken from real-world observations (21,500 for private cars and 29,500 for company cars).
- Annual mileage for company cars is assumed to stay at 29,500 km per year, given that this is in line with the mobility panel observations for company car diesel vehicles and it is plausible that use patterns for company cars may stay similar.
- Average annual mileages for private cars and other commercial cars are assumed to decrease over time (with increasing age of vehicle stock) from 21,500 in 2020 to 16,500 in 2030.

Utility factor

Scenarios are calculated with different utility factors. Utility factors are determined empirically for the 2020 baseline (see chapter 5.2). Policy has a strong influence on utility factors (company car subsidies, difficulties in approving private charging infrastructure, etc.). Depending on policies, the utility factors might improve considerably until 2030. That’s why we analyse two additional scenarios for utility factors. These are derived from the Mobility Panel assuming daily or two-day charging. The utility factors are derived separately for private and company cars.

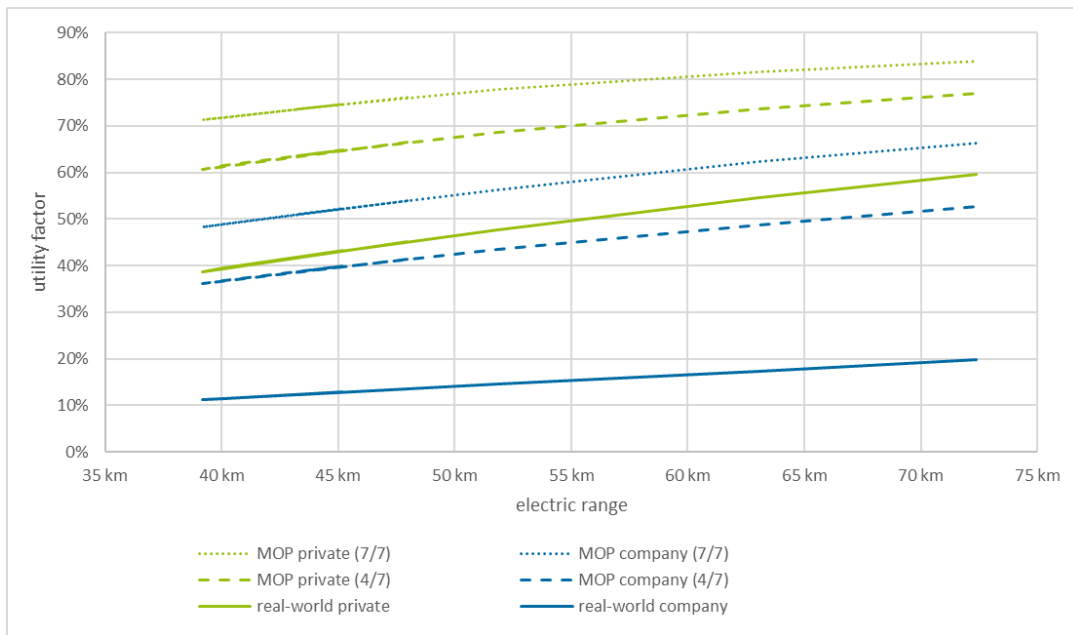

Figure 6.7: Utility factors applied in the scenario calculations; based on the mobility panel (MOP) for charging every day (dotted) and every other day (dashed) as well as based on empirical data from (Plötz et al. 2020).

7 Scenario analysis of PHEV CO₂ emissions until 2030

This chapter contains a scenario analysis of PHEV registrations, stock and CO₂ emissions based on the market data, energy consumptions, and further assumptions described in chapter 6.

The scenario analysis mainly aims at understanding the influence of utility factors and the share of company cars vs. private cars on CO₂ emissions until 2030.

7.1 Overview over scenario assumptions

The following table gives an overview over key scenario assumptions as described in section 6.

Parameter	description
total new car registrations	3 mio. per year
share of PHEV in registrations	4,8% in 2020, 10,5% in 2025 and 13% in 2030
survival curve of PHEV in stock	survival curve like diesel cars; company cars enter 2nd hand market after 3.5 years
annual mileage per PHEV	company cars: 29,000; private cars: 21,500 (2020) decreasing to 16,500 (2030)
share of company cars	50% of registrations of PHEVs are company cars
utility factor	2020 based on real-world data; development until 2030: analysis with a range from “no improvement” to “charging every day”

7.2 New registrations

The total share of PHEV registrations in Germany is assumed to increase over time to 13% by 2030 (see section 6), with a 50% share of company cars. Private cars (17% of total registrations) and other commercial cars (33% of total registrations) are summarized in the category “other cars”.

For the 1st half of 2020, the observed share of PHEV in new car registrations was 4.1% according to KBA data. A slight increase is to be expected for the 2nd half of 2020 due to higher purchase subsidies. A further increase by 2021 is plausible because in 2021 the EU CO₂ standard of 95g/km fully comes into force, whereas in 2020 a phase-in (95% of fleet has to fulfil the target) is still in place. The overall number of newly registered PHEV cars in the scenario doubles from around 200.000 in 2021 to 400.000 in 2030.

Overall, around 50% of PHEV registrations are C segment vehicles. No A segment PHEVs are expected on the market, and the share of B segment stays low. The share of D and E segment is higher for company cars than for private cars.

The number of PHEV registrations is subject to uncertainty and depends on the development of both EU and national policies. More ambitious CO₂ standards could result in higher PHEV shares on the market by 2030. On the other hand, if concerns about real-world CO₂ reduction lead to more restrictive policies and less public acceptance, registrations might be lower and a faster transition to purely battery-electric vehicles might take place. Furthermore, it seems possible that OEMs will try and reduce the gap between WLTC and real-world emissions to increase public acceptance of PHEV, e.g. by increasing battery capacity of PHEV.

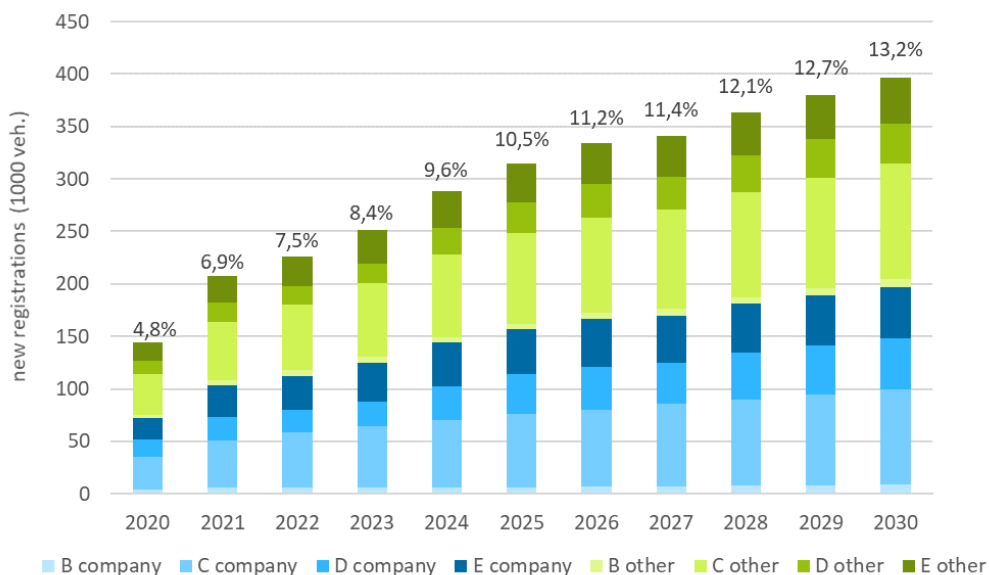

Figure 7.1: New registrations of PHEV in Germany by segment and user, 2020-2030

7.3 Vehicle stock and mileage

Vehicle stock is calculated based on new registrations and survival curves. Data shown refers to the vehicle stock as of 1st of July of each year. PHEV stock increases to around 1 million by 2024 and 2.6 million by 2030, which is around 5.5% of total vehicle stock in 2030.

We assume that company cars shift to private market after an average of 3.5 years. This results in a “trickle down” of company cars to private market: The share of company cars in stock increases to 43% in 2023, then decreases to 23% in 2030. By 2030, 600.000 company car PHEV would account for around 20% of all company cars. The share of company cars within the PHEV stock is significantly higher than the current share of company cars in overall stock in Germany (estimated at around 6% in ePoweredFleets (Oeko Institut 2017)).

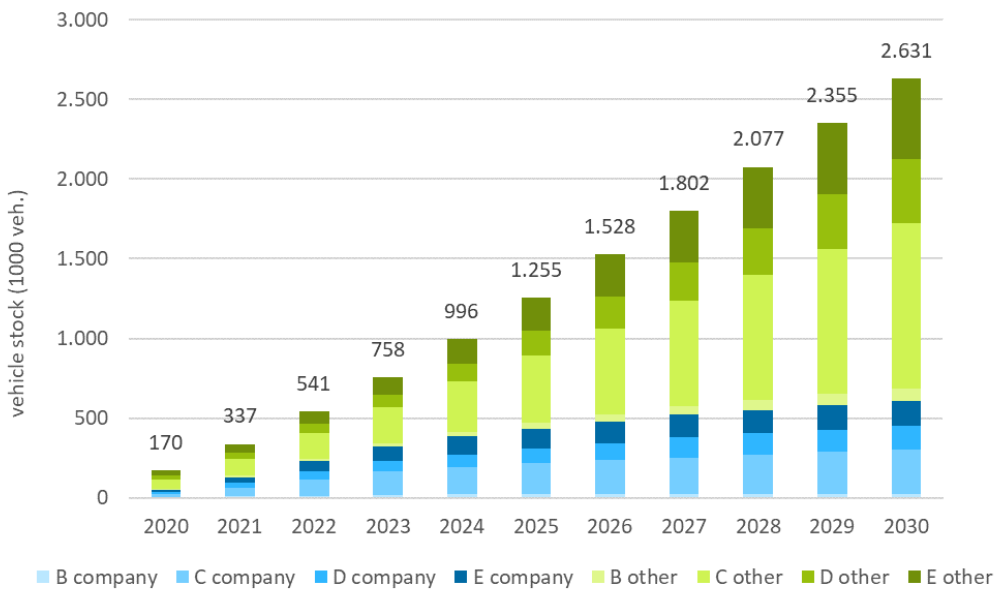

Figure 7.2: PHEV vehicle stock in Germany by segment and user, 2020-2030

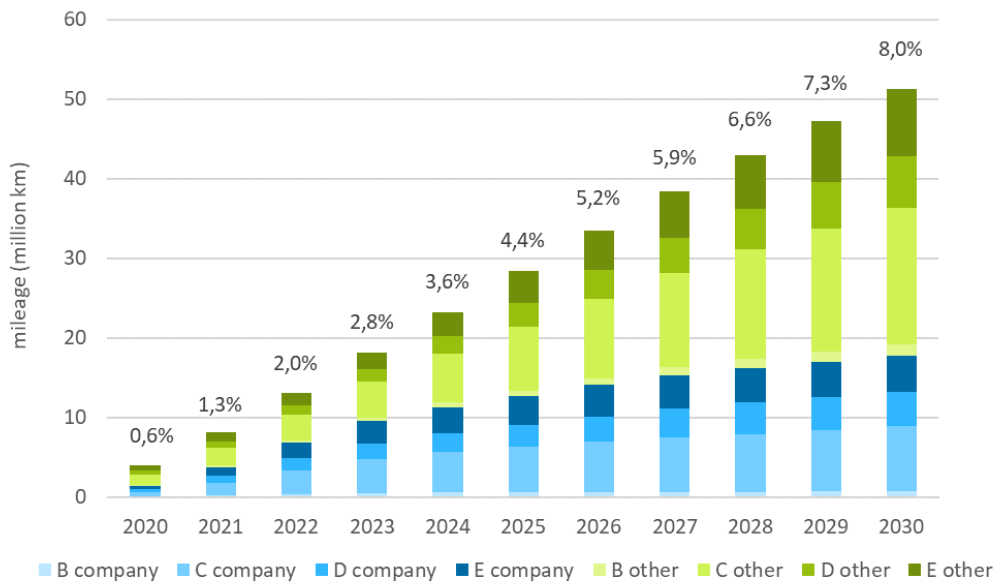

Figure 7.3: PHEV mileage in Germany by segment and user, 2020-2030

The overall mileage of PHEVs in the scenario increases from 4 million km in 2020 to 51 million km in 2030, representing 8% of total mileage in 2030. Share of mileage is higher than share in stock (5%) because of higher average annual mileages of PHEVs. Due to higher average mileages of company cars, they account for 23% of stock but 35% of mileage in 2030.

7.4 CO₂ emissions

We calculate direct CO₂ emissions of PHEVs for a range of utility factors (see section 6). The Figure 7.4 above shows CO₂ emissions per kilometre in vehicle stock depending on ownership and year. WLTC emissions per km are similar between owners; the small variation is due to a slightly higher share of large cars for company cars. WLTC CO₂ emissions are expected to decrease until 2030 due to increasing battery capacities and some efficiency improvements.

Both real-world data and calculations based on the Mobility panel for the “charging every day” and “charging every other day” scenarios result in lower utility factors for company cars than for private cars, which leads to higher specific CO₂ emissions for company cars.

With utility factors as of today, direct CO₂ emissions in the scenario are as high as 139 g/km in 2020. This is below the average CO₂ emissions of an average conventional car, but far above the WLTC value. In the case of every-day charging, private vehicles with comparatively low mileages can achieve CO₂ emissions as low as in WLTC. On the contrary, average company cars have significantly higher CO₂ emissions even if charged every day due to high mileages. Company cars would have to be charged more than once per day to achieve low direct CO₂ emissions.

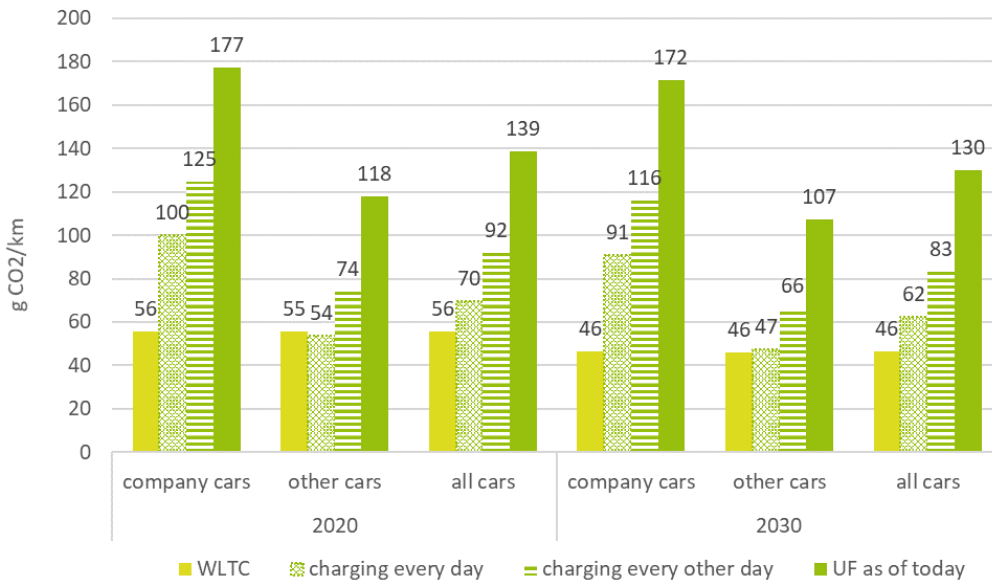

Figure 7.4: PHEV CO₂ tailpipe emissions per km depending on charging behaviour, 2020 and 2030

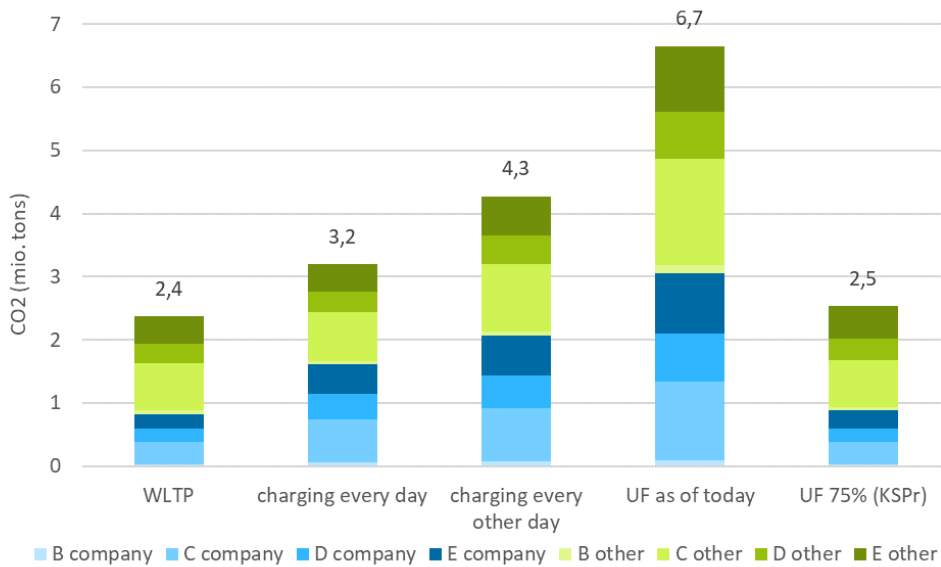

Figure 7.5: Total PHEV CO₂ emissions in Germany 2030 for different charging behaviours

According to WLTC, CO₂ emissions of PHEV would be 2.4 million tons in 2030 with a 35% share of company cars (equivalent to their share in mileage). If use patterns and charging behaviour do not change compared to today, direct CO₂ emissions might increase to 6.7 million tons by 2030.

Within the KSPR scenario, a utility factor of 75% was used which compares to a typical WLTP utility factor (due to the lack of better data). Figure 7.5 above shows that in this case, CO₂ emissions of 2.5 million tons are nearly as low as in the WLTC case. Within the KSPR scenario, average annual mileage for PHEV is 19,500 km, which is the same as the 2030 value in the scenario above. Number of new registrations and vehicle stock is quite similar. Within the KSPR scenario, the total number of PHEVs in 2030 is slightly lower (2.2 million in the KSPR scenario compared to 2.6 million).

Charging behaviour might improve over time, provided policies and incentives are adjusted (see section 9). The central scenario (dark blue line) shows CO₂ emissions in the case that charging behaviour improves from today's observed values (upper boundary of light blue area) to charging every day (lower boundary). With optimized charging, CO₂ emissions per km could go down by nearly 50%. On the other hand, if use patterns do not change, CO₂ emissions might be significantly higher than expected.

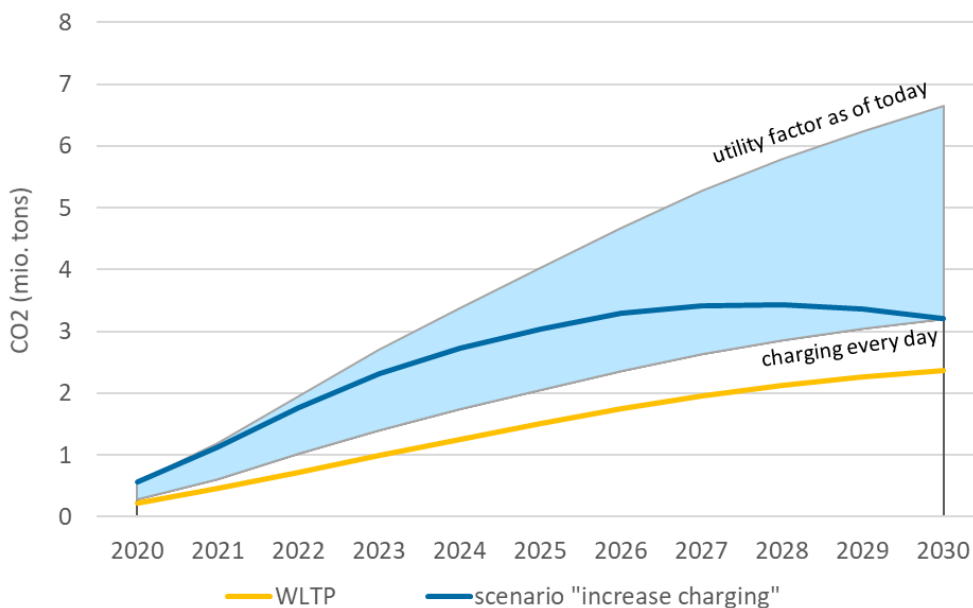

Figure 7.6: Total PHEV CO₂ emissions in Germany in the case of increased charging, 2020-2030

8 Alternative scenarios without PHEVs

We have seen that real-world CO₂ emissions of PHEV strongly depend on driving patterns and charging behaviour, and that divergence between test cycle and real-world CO₂ emissions of PHEVs might be quite high. Still, the question arises as to how CO₂ emissions would develop in a world without plug-in hybrids and whether PHEV can still contribute to CO₂ emissions reduction compared to ICE cars.

If plug-ins were sold less or even not sold at all anymore, OEMs would have to sell more battery electric vehicles or more efficient ICEs or both to meet the EU CO₂ standards for cars. That's why under current policies, PHEV will not just substitute ICEs, but probably substitute a mix of BEV and ICEs – or lead to a higher efficiency for ICE cars.

In order to illustrate the effect of reduced PHEV sales, we calculate an extreme scenario in which all PHEVs are replaced by a mix of battery electric vehicles and combustion engines. We calibrate the share of BEV and ICE registrations so that test-cycle WLTP CO₂ emissions of new registrations are equal to the CO₂ emissions in the PHEV scenario (chapter 7).

Additionally, we calculate a hypothetical scenario in which all PHEVs are replaced by equivalent ICEs. In such a scenario, however, the type-approval CO₂ emissions of new car registrations are higher and the EU CO₂ standards for 2025 and 2030 are not met.

8.1 Scenario assumptions

We assume that the PHEV registrations in chapter 7 are substituted by equivalent cars. We take the market share of segments, the share of owners and survival curves to be the same as described in chapter 7, but with different powertrains:

- In Scenario “PHEV=>ICE”, all PHEV are substituted by ICEV. In this scenario, CO₂ emission standards are not met.
- In Scenario “PHEV=>ICEV&BEV”, all PHEV are substituted by a mix of ICEV and BEV.

8.1.1 CO₂ emissions of equivalent ICE cars

As for the PHEV, the CO₂ emissions of equivalent ICE cars were derived separately for each vehicle segment. In a first step, the engine power bandwidth of Diesel/Gasoline equivalent vehicle models were determined. For each PHEV model, an ICEV model variant was chosen which has about the same engine power rating as the PHEV. The new registration figures of each PHEV model were then used to calculate weighted averages of the technical specifications and the WLTP fuel consumption of the chosen equivalent ICE vehicles.

Table 14: Technical specifications per segment (Gasoline+Diesel 2020)

Segment	Diesel		Gasoline	
	Average total power [kW]	Average empty weight [kg]	Average total power [kW]	Average empty weight [kg]
B	85	1280	100	1265
C	110	1518	115	1435
D	141	1651	145	1633
E/F	227	1983	243	1910

In a next step, the average weighted real-world fuel consumption was derived. For this purpose, the segment-specific ratio between WLTP and HBEFA fuel consumption was used that had earlier been determined for PHEVs in the Charge Sustaining mode (CS-mode), see chapter 5.4. This means a correction factor of 7.3 % between WLTP and HBEFA cycles.

After this step, efficiency improvements from the TREMOD Trend scenario¹ were applied in order to model the assumed fuel consumption of diesel and petrol vehicles in 2030. Thereby, the same efficiency improvements across all segments, diesel and petrol cars were applied (-15.8%). In a last step, the CO₂ emissions were calculated with the specific emission factors for diesel and petrol from TREMOD.

Table 15: Average fuel consumption per segment (Gasoline+Diesel 2020+2030)

Segment	Diesel				Gasoline			
	Fuel consumption WLTP [L/100km]		Fuel consumption Real [L/100km]		Fuel consumption WLTP [L/100km]		Fuel consumption Real [L/100km]	
	2020	2030	2020	2030	2020	2030	2020	2030
B	4.3	3.6	4.6	3.9	5.9	5.0	6.3	5.3
C	4.9	4.1	5.3	4.4	6.5	5.5	7.0	5.9
D	5.7	4.8	6.1	5.1	7.6	6.4	8.1	6.8
E/F	7.0	5.9	7.5	6.3	9.0	7.6	9.6	8.1

¹ (ifeu 2020)

Table 16: Specific CO₂ emissions per segment (Gasoline+Diesel 2020+2030)

Segment	Diesel				Gasoline			
	CO ₂ emissions ¹ WLTP [L/100km]		CO ₂ emissions ¹ Real [L/100km]		CO ₂ emissions ² WLTP [L/100km]		CO ₂ emissions ² Real [L/100km]	
	2020	2030	2020	2030	2020	2030	2020	2030
B	113	95	121	102	137	95	147	102
C	129	109	138	116	150	109	161	116
D	149	125	160	134	175	125	188	134
E/F	183	154	197	166	208	154	223	166

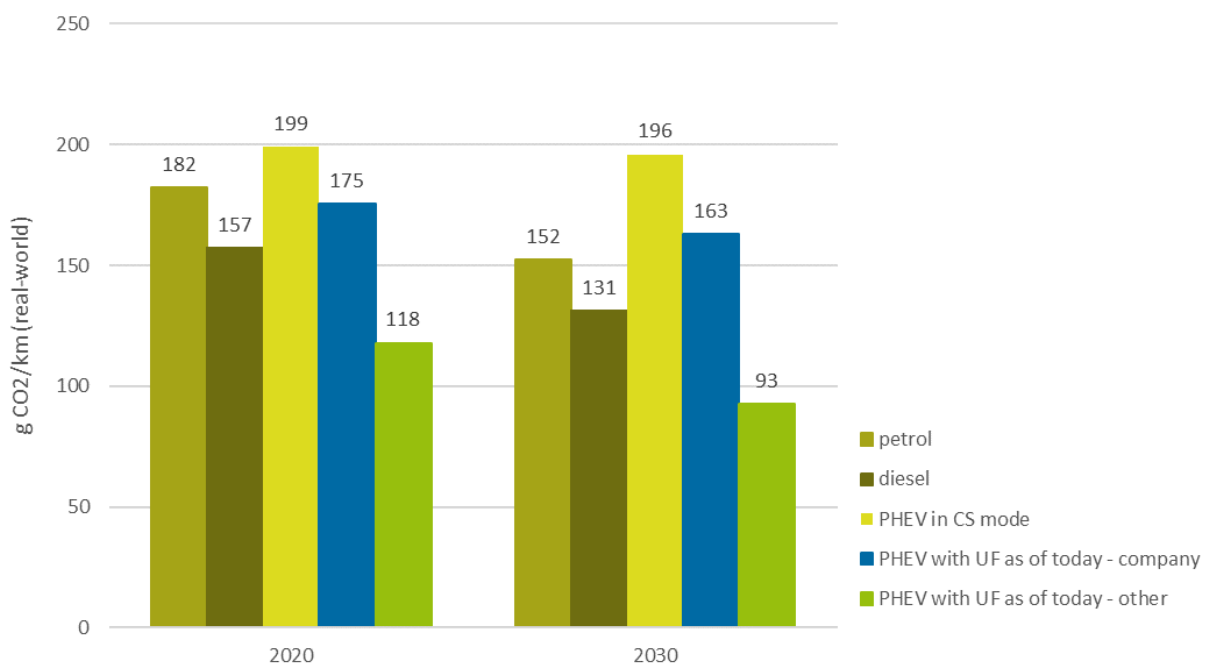

Figure 8.1: CO₂ emissions per km for PHEV and equivalent ICEV (weighted average)

Figure 8.1 shows real-world CO₂ emissions of new registrations of PHEV and equivalent ICEV in 2020 and 2030 as a sales-weighted average over the 4 considered segments. In 2020, CO₂ emissions of PHEV in fossil mode (CS mode) are on average 9 % higher than CO₂ emissions of equivalent petrol cars and 27 % higher than those of equivalent diesel cars. Until 2030, efficiency of ICEV is assumed to increase by 15.8 %, whereas PHEV only slightly reduce their CO₂ emissions in CS mode.

Thus, CS mode CO₂ emissions of PHEV registered in 2030 are 29 % higher than CO₂ emissions of equivalent petrol cars and 49% higher than those of equivalent diesel cars.

¹ CO₂ emission factor Diesel: 2.619 [kg CO₂/L] according to https://www.umweltbundesamt.de/sites/default/files/medien/1410/publikationen/2020-06-29_texte_116-2020_tremod_2019_0.pdf

² CO₂ emission factor Gasoline: 2.316 [kg CO₂/L] according to https://www.umweltbundesamt.de/sites/default/files/medien/1410/publikationen/2020-06-29_texte_116-2020_tremod_2019_0.pdf

The fact that the PHEVs are not becoming more efficient is due to the assumed weight increase derived in section 6.2. Under current CO₂ standards, an increased weight of PHEV (and thus higher energy consumption) has little consequences for type-approval CO₂ values because most of the mileage is assumed electric and thus free of tailpipe emissions. ICEVs, on the other hand, cannot "afford" this weight increase because of the CO₂ standards, at least as long as they continue to play a central role in sales.

It is important to keep in mind that all PHEV in this figure are PHEV-petrol cars. Real-world CO₂ emissions of PHEV strongly depend on utility factors. In the case of (very) low utility factors as observed for company cars, CO₂ emissions of PHEV may be higher than those of equivalent ICEs.

8.1.2 Share of petrol and diesel cars of total ICE registrations

The share of diesel and petrol cars of ICE registrations per segment for the alternative scenario is calculated based on KBA data for the year 2019. The share of diesel cars (as a percentage of total petrol and diesel registrations) of new car registrations was around 1/3 for the C segment and 2/3 for the D-F segments, whereas most of the A/B ICEV registrations were petrol cars. For commercial registrations and the company car market, the share of diesel cars is higher than for private cars. We calculate the share of diesel cars as a weighted average, taking into account that around 50 % of PHEV registrations are company cars, 17 % are private cars and 33 % are other commercial users.

Table 17: Assumptions on share of diesel cars per segment (based on KBA data)

	KBA all cars	Scenario PHEV => ICE and PHEV=> ICE&BEV
A/B	4%	6%
C	35%	44%
D	65%	68%
E/F	66%	68%
total	35%	53%

8.1.3 Yearly mileage of petrol, diesel, and BEV cars

CO₂ standards for cars regulate average CO₂ emissions of new car registrations, but they have no mileage weighting. If annual mileages of zero and low emitting vehicles (ZLEV) are significantly lower than typical ICE mileages (as observed in the past), real-world CO₂ emissions will be higher than in the case of similar annual mileages for all powertrains.

When substituting PHEV cars with petrol, diesel, and BEV cars, it is possible that diesel cars will mainly substitute PHEVs with higher mileages, whereas petrol and BEV cars will substitute PHEV with lower mileages. In order to take different mileages into account, we use the assumption from TREMOD that annual mileages of diesel vehicles are 1.9 times higher than annual mileages of petrol cars, whereas annual mileages of BEV are on average only 0.8 times the annual mileage of diesel cars (ifeu 2020).

If charging infrastructure improves over time and mileage-dependent costs for BEV (energy costs and maintenance) are competitive with diesel cars, BEV might become more and more attractive for users with high annual mileages. As a sensitivity analysis, we analyse the effect on CO₂ emissions if annual mileages of BEV and ICE cars will be similar.

8.2 New registrations

The figure shows new registrations per powertrain for the PHEV scenario and the two alternative scenarios in 2020 and 2030. Not all new registrations are shown, but only the substituted PHEV registrations. Other new registrations are assumed to remain unchanged between the scenarios. In the “PHEV=> ICE” scenario, all PHEV are substituted by petrol and diesel cars with a share of 53 % diesel (see assumptions above). The share of BEV in the “PHEV=> ICE&BEV” scenario is calculated in order to secure that average WLTP emissions of the ICE&BEV-mix are the same as in the PHEV scenario (i.e. 56 g/km in 2020 and 33 g/km in 2030).

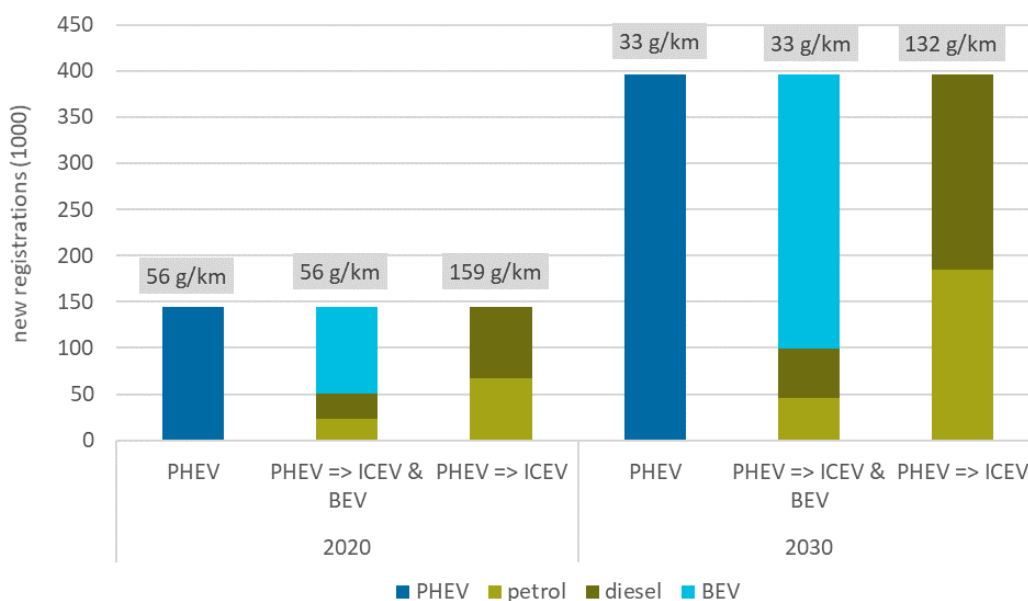

Figure 8.2: Substituted PHEV registration per powertrain for PHEV scenario and alternative scenarios. Source: own calculations.

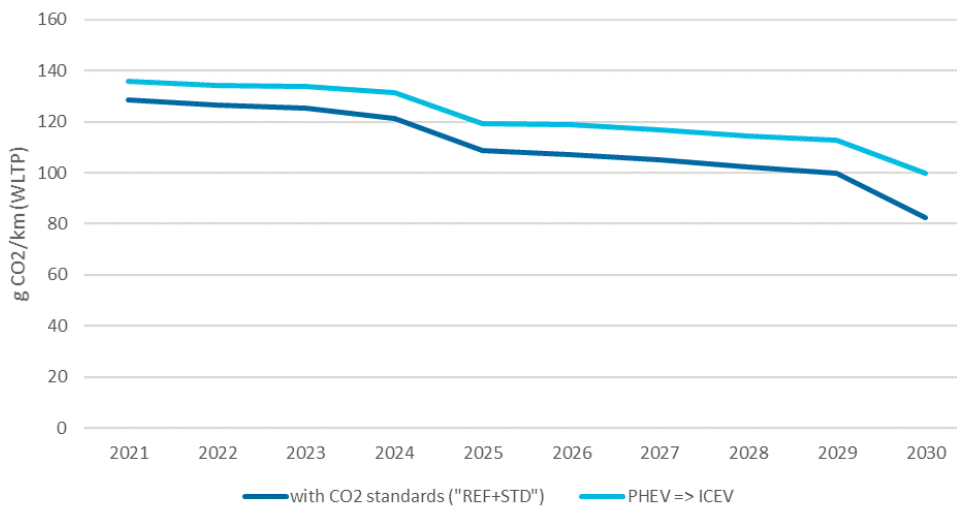

Figure 8.3: WLTP CO₂ emissions per km for new registrations in Germany. Source: own calculations.

The figure above shows WLTP CO₂ emissions for new registrations. Two scenarios are shown: The dark blue line shows a scenario where EU CO₂ emission standards for 2025 (-15 % compared to 2021) and 2030 (-37,5 % compared to 2021) are met – that is the baseline for our PHEV scenario. Assumptions for the development of CO₂ emissions in this scenario are taken from the report (Öko-Institut et al. 2020), scenario “REF+STD”. In the “PHEV=> BEV&ICE” scenario, the CO₂ standards are met and thus we have the same development of WLTP CO₂ emissions as in the base scenario “REF+STD”. On the contrary, in the “PHEV=>ICE” scenario, average emissions are higher: 7 g/km in 2021 and 17 g/km in 2030.

8.3 CO₂ emissions

Figure 8.4 shows CO₂ emissions per kilometre in vehicle stock depending on ownership and year. CO₂ emissions for the PHEV “charging every day” and “UF as of today” scenarios are taken from Figure 7.4.

When comparing CO₂ emissions of ICEV with CO₂ emissions of PHEV, we can see that in the case of today’s utility factors PHEV company cars emit slightly more CO₂ per km than ICEV, whereas for other owners with lower annual mileages and higher utility factors PHEV emit around 40 % less than ICEV. This relates to the observation that CO₂ emissions of PHEV in fossil mode (CS mode) are on average 9 % higher than CO₂ emissions of equivalent petrol cars and 27 % higher than those of equivalent diesel cars. It is important to keep in mind that all PHEV in this figure are PHEV-petrol cars, whereas ICE are a mix of diesel and petrol cars. If PHEV cars were charged every day, CO₂ emissions would be significantly lower than those of equivalent ICE.

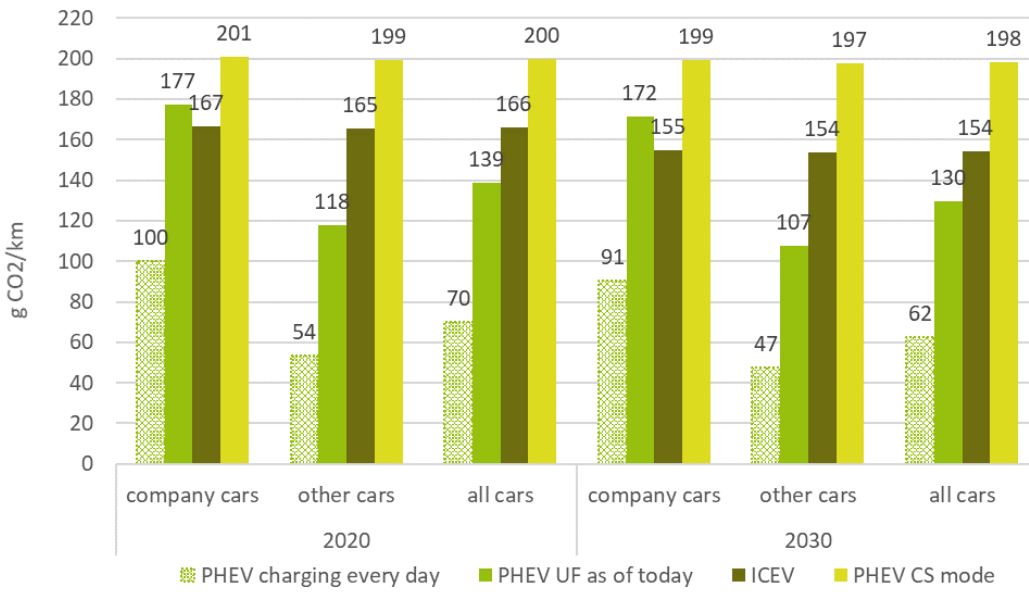

Figure 8.4: CO₂ tailpipe emissions per km for PHEV and ICE, 2020 and 2030. Source: own calculations.

The figure above shows CO₂ emissions per kilometre in vehicle stock depending on ownership and year. CO₂ emissions for the PHEV “charging every day” and “UF as of today” scenarios are taken from Figure 7.4.

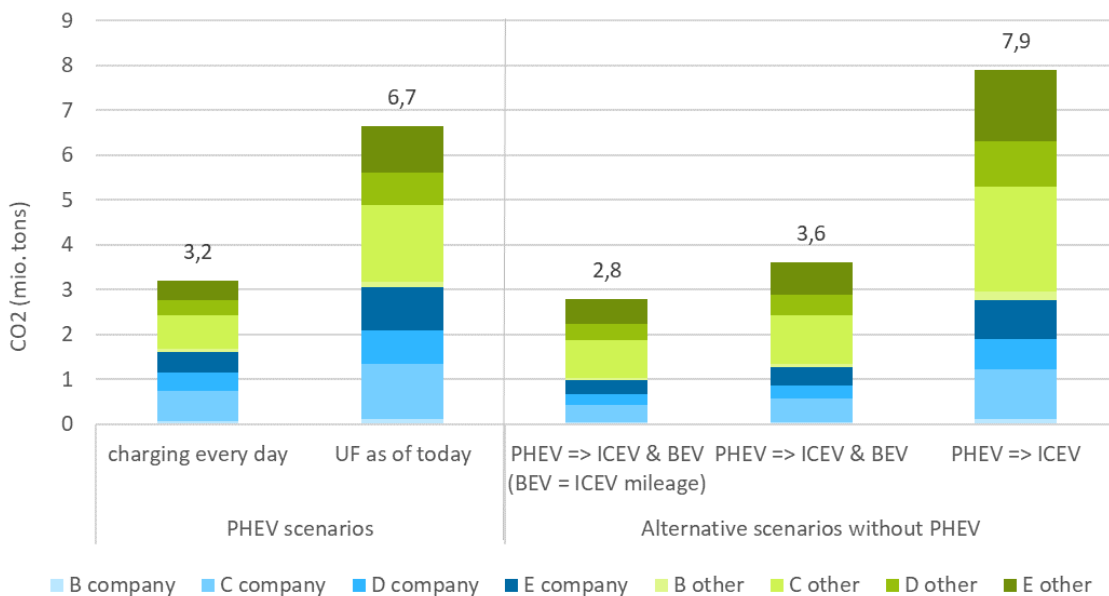

Figure 8.5: CO₂ tailpipe emissions for PHEV scenarios and alternative scenarios (2030)

We calculate total CO₂ emissions by combining CO₂ emissions per km with total mileages. We have seen in chapter 7 that CO₂ emissions of PHEV in 2030 vary between 3.2 mio. tons and 6.7 mio. tons depending on charging behaviour.

If no PHEV cars were sold but CO₂ standards were still met by substituting PHEV with a mix of battery-electric cars and ICEVs (scenario PHEV=> ICE&BEV), the share of battery-electric cars would need to be relatively high (65% in 2020 and 75% in 2030 as shown in Figure) and the ICEV share relatively low. This results in CO₂ emissions of the substituting vehicle stock as low as 2.8-3.6 mio. tons, depending on annual mileages of BEV and ICEV. The lower value of 2.8 mio. tons stems from the assumption that by 2030 ICEV and BEV will have the same annual mileages, whereas the underlying assumption for the higher value of 3.6 mio. tons assumes that annual mileages of BEV will stay significantly lower than those of ICE cars. We can see that CO₂ emissions in this scenario are similar as the best-case PHEV scenario where users charge their vehicles every day, but significantly lower than in the case of today's utility factors.

The scenario where all PHEVs are substituted by ICE cars is mainly a hypothetical scenario for analytical purposes, because in this scenario EU CO₂ standards are not met and therefore this scenario is not directly comparable to the other scenarios. We see that total CO₂ emissions in the PHEV scenario with today's utility factors are slightly lower than in the "PHEV=>ICE" scenario, indicating that CO₂ emissions could be slightly reduced by substituting ICEs with PHEV even if current average utility factors remain unchanged. As we have seen in Figure 8.4, PHEV company cars emit on average more CO₂ than equivalent ICE cars, whereas privately owned cars emit less CO₂ than equivalent ICE – this means that under today's use patterns PHEV used as company cars would increase emissions in 2030 compared to ICEV, while privately owned PHEV would imply a reduction.

8.4 Discussion

If current utility factors of PHEVs remain unchanged until 2030, a ban on plug-ins while at the same time meeting the CO₂ limits can reduce CO₂ emissions from passenger cars by 3 million tons in 2030. This shows that vehicles with a high gap between test-cycle (WLTP) and real-world CO₂ emissions undermine the effect of car CO₂ standards, because CO₂ standards only regulate test-cycle but not real-world emissions. On the contrary, additional promotion of such vehicles with a high gap between WLTP and real-world CO₂ emissions by national policies can lead to an increase in overall CO₂ emissions (if not at national level, at least at EU level). This is particularly valid for company cars since they currently show low empirical utility factors while being most heavily subsidized.

9 Approaches for Regulatory Measures

Main findings of this study are:

- Real world CO₂ emissions of PHEVs are drastically underestimated by the official WLTP test procedure. Climate protection instruments designed with the help of the values of the test procedure therefore have a high risk of failing to meet their targets. This applies in particular to the European CO₂ fleet target values.
- The behaviour of PHEV users (driving profile and charging behaviour) has a far greater influence on the CO₂ emissions than with all other drive systems.

Further findings are:

- Vehicle design offers important levers for reducing real world CO₂ emissions.
- In order to reduce uncertainties for consumers and policymakers, a higher transparency of measurement data and design parameters of PHEVs is desirable.

Approach	Policy Options
Reduce gap between WLTP and real-world	More realistic utility factor based on OBFCM. 3 Options: EU-wide UF, OEM-specific UF, Model-specific UF
	More realistic specific energy consumption, e.g. include auxiliaries, consider more operation modes, revise „post-test data correction“
Restrict incentives and subsidies to low-emission PHEVs	Purchase premiums
	Vehicle tax rebates
	Rebates in the tax deduction of company cars
	Allocation of labels for electric cars
Incentivize reasonable charging behaviour	Require dedicated CI
	Forbid fuel cards for PHEV
	Tie grants (e.g. part of purchase premium) to personal FCM data
	Reduce usage-independent subsidies (e.g. company car privilege for PHEV)
	Ensure operating cost advantage on electric drive as compared to fuel
Set requirements for Operation modes	Limit for fuel consumption in CS mode
	Mandatory pure e-mode
	Requirements for powertrain configuration (e.g. share of e-power, el. range)
	Requirements for software behaviour (e.g. default mode)
Increase transparency	Publish CoC data
	Make CD and CS mode consumption mandatory for energy efficiency labelling

Figure 9.1: Overview of possible regulatory approaches

Accordingly, we were able to identify four main starting points for possible regulatory intervention to ensure real CO₂ reductions by PHEVs, which are shown in Figure 9.1. In the following, possible options for action within these starting points are discussed.

9.1 Reduce gap between real world and WLTP

There is a gap between WLTP and real-world CO₂ emissions of PHEV mainly for two different reasons:

- The assumed share of electric driving for PHEVs in the WLTP, also called utility factor (UF), is not representative of PHEV use in the EU and particularly in Germany (see section 5.2).
- The specific electricity consumption in charge-depleting mode as well as the fuel consumption in charge-sustaining mode significantly exceeds type-approval values (see sections 5.1 and 5.4).

Realistic utility factors

The influence of the utility factor is by far most important based on the analysis in this study. Currently, utility factors for type-approval are derived from data on driving patterns of conventional ICE vehicles from two pre-2014 databases (Riemersma 2016). When the WLTP procedure was developed, it was agreed that the UF would be updated in the future based on a European PHEV customer study (to be undertaken) once a significant number of PHEV have been placed on the EU market.

Requirements for on-board fuel consumption meters (OBFCM) were introduced for light-duty vehicles with the 2019 CO₂ regulation (EC) 2019/631 with the primary purpose to monitor the gap between real world CO₂ emission and type-approval values for all new vehicles. Public consultation for the implementing act for OBFCM, which covers data transfer as well as annual publication requirements, has recently been finished. It is expected that this regulation will enter into force as from February 2021. The first year of available data would thus cover 2021 and be public towards the end of 2022.

We strongly recommend using data from OBFCMs in order to determine real world utility factors for the calculation of PHEV CO₂ emissions.

This would allow to close the gap between WLTP type-approval and real-world PHEV CO₂ emissions, without the aforementioned PHEV customer study being necessary. The OBFCM data should be collected over the air to make full fleet data collection easier and tampering harder. There are three possible levels of granularity on which the data could be aggregated for usage in the type-approval procedure. Note that for all of these options, the UF would have to be derived as a function of the vehicles' all-electric range.

1. EU-wide average over all new vehicle registrations.
2. OEM-specific average for all new registrations of one manufacturer
3. Model-specific average

The following table displays some advantages and drawbacks of the respective aggregation level.

Table 18: Advantages and disadvantages of different aggregation levels of OBFCM--based utility factors

	Pros	Cons
EU-wide average	<ul style="list-style-type: none"> • Easy to implement • Likely most acceptable for OEMs 	<ul style="list-style-type: none"> • Little individual incentive for OEMs to increase UF of their PHEV fleet by technical means or by encouraging their users to charge more often.
OEM-specific	<ul style="list-style-type: none"> • Incentivizes OEMs • to increase UF of their PHEV fleet by technical means and • to encourage their users to charge more often, e.g. by offering convenience packages including charging infrastructure setup, automatic wireless charging etc. 	<ul style="list-style-type: none"> • Differences in charging infrastructure availability or usage habits between regional markets could distort the results between OEMs
Model-specific	<ul style="list-style-type: none"> • Captures emission-relevant technical peculiarities of individual vehicle models • Could significantly enhance consumer information for vehicle choice. 	<ul style="list-style-type: none"> • Complexity of the method given the large number of models and the differences which can exist between various versions of one model • For small production numbers of specific models, the UF may be biased by the specific usage habits of their customers which might not be representative.

OEM-specific UFs seems to be the preferable option as it would create incentives for OEMs to both technically improve their vehicles and encourage beneficial charging behaviour among their customers, while being robust against statistical peculiarities that might arise with UFs for individual vehicle models. The OBFCM data should be updated annually and the derived UF should be used for type approvals for the following 12 months until new FCM data is available. The data should be fully public and accessible in order to ensure maximum transparency for the customers with regard to the fuel economy they can expect.

However, the transition from the current WLTP utility factors to real world utility factors could pose a major challenge for compliance of OEMs with a particularly large gap if the transition is done too abruptly. Therefore there could be a phase-in period for which the EU average utility factor would be used first, gradually being replaced by OEM specific utility factors.

Realistic energy consumption values

In order to close the gap between type-approval and real-world consumption, measures should be taken, in addition to adjusting the utility factor, to make the specific power consumption in the charge depletion mode and the fuel consumption in the charge sustaining mode more realistic. For this purpose, a revision of the WLTP should be worked towards in consultation with DG GROW, which should contain the following elements:

- **Introduce the use of auxiliaries on all PHEV CO₂ tests.** WLTP test currently does not include auxiliary use (e.g. AC, heating, sat-nav). This is especially an issue for determining the all-electric range (AER) of PHEVs as use of auxiliaries can decrease AER by ~35% (see section 5.3)
- **Clarify post-test data correction (KCO₂).** Post test data correction can artificially reduce CO₂ emissions. A so-called KCO₂ factor can be used to reduce CO₂ emissions if the state of charge on the battery increases during any of the WLTP tests.
- **Consider additional driving modes.** WLTP tests are currently conducted in 2 PHEV driving modes (charge depletion and charge sustaining). However, most PHEV additionally have a “sport mode” which is optimized for maximum power as well as a battery charging mode. For the sake of transparency for the users, energy consumption and CO₂ emissions should be also quantified for these modes. Moreover, it should be investigated how often these modes are applied in real-world driving. This would make it possible to consider these modes also for the standardized emission values.

9.2 Restrict incentives and subsidies to low-emission PHEVs

The measures mentioned above help to quantify the typical energy consumption and CO₂ emissions of individual PHEV models more reliably at type approval. In the medium timeframe, this can increase the reliability of various policy instruments that already use the type-approval values or could use them more extensively in the future:

- **Purchase premiums.** Currently, purchase premiums are granted for PHEVs regardless of their CO₂ emissions. Linking the purchase premium to CO₂ emissions would be a logical step in view of the objectives pursued. In addition, individual utility factors could also be used to grant (parts of) the purchase premium, see section 6.2. As all-electric range was shown to be a key factor for achievable electric mileage under real-world conditions, an electric range considerably above the current market average should be made a sine qua non for purchase premium eligibility of PHEVs.
- **Vehicle tax rebates.** - PHEVs receive a discount on vehicle tax if they have CO₂ emissions of less than 95 g/km after type approval. If the emissions were determined realistically, the motor vehicle tax would automatically increase for many currently registered PHEVs.
- **Rebates in the tax deduction of company cars.** - For PHEVs registered as company cars, the monthly amount to be taxed as a non-cash benefit is only half as high as for conventional vehicles. At the same time, current evaluations show that company cars often have a particularly low proportion of electric driving. Linking the tax privilege for company PHEVs to a realistic type-approval value could help to avoid false incentives. In addition, however, incentives for the actual electrical use of the vehicles must be provided, see section 6.2 below.

- **Allocation of labels for electric cars**, which are decisive for preferential treatment in road traffic. The label for an electric car is awarded if either the CO₂ emissions after type approval are at most 50 g/km or if the purely electrical range is at least 40 km.

However, the proposed approach to incentivizing PHEVs based on more real data is based on the development of an OBFCM-based utility factor, which is expected to take 2 to 3 years. Since the new cars to be registered in the next 3 years will be in use for about 12 years on average and thus have a significant impact on CO₂ emissions from the transport sector, the incentive scheme for PHEVs should be reconsidered in the short term. For example, the current incentive scheme, especially in the context of company car tax, is counterproductive with regard to achieving the climate protection targets for 2030. As shown above, around 50% of registered PHEVs are estimated to be company cars and company cars have additional emissions in real driving operation of around a factor of 3 compared to the figures in the WLTP. For climate protection reasons, it would therefore make sense to suspend or at least fundamentally adjust the current tax incentives for PHEVs. As soon as real data is available that can be officially used for an incentive, it could be included in a system of support for low-emission cars.

Generally, it must be taken into account with company cars that achieving a high proportion of electric driving is more demanding than with private vehicles due to the often high mileage. Assuming an annual mileage of 29,500 km, which is the average value in the sample considered for company PHEVs, and assuming 250 operating days of the vehicle per year, this results in a daily distance of about 120 km. This corresponds to about three times the electric range of current PHEVs; even with a full overnight charge, the maximum electric driving share would be about 30 %. Thus, from the point of view of climate protection, company car profiles for PHEVs are generally not a particularly promising application.

Particularly in the case of company cars, it is therefore necessary to take regulatory action to achieve high electric ranges. Currently, PHEV company cars are eligible for an increased tax privilege if they either have a minimum range of 40 km (2022: 60 km; 2025: 80 km) or type-approval CO₂ emissions of not more than 50 g/km. Since the latter is fulfilled by the vast majority of PHEV currently on the market, the first criterion practically does not play a major role.

In addition, a combined requirement for the availability of charging infrastructure both at home and at the employer's premises could also be considered in order to enable multiple daily recharging. This, in turn, could drive forward the necessary charging infrastructure development in the private and commercial sector as a whole and thus create the conditions for a faster market penetration of purely electric vehicles.

9.3 Incentivize reasonable charging behaviour

In addition to closing the emission gap between type-approval and real-world operation, national authorities should also seek to have the right policy measures in place that incentivise frequent charging of PHEV at individual level and thus help fully capturing the benefits from PHEVs.

The following approaches can be used to create meaningful incentives and reduce disincentives:

- Ensuring a significant individual energy cost advantage for electrical operation compared to combustion engine operation.
- Ensuring an available charging infrastructure where PHEVs are parked for long periods.
- Reduce incentives that merely encourage the purchase of PHEVs without considering their use, or link such incentives to actual vehicle use

Ensure energy cost advantage

In many cases, the energy costs for electric and internal combustion engine operation of PHEVs are currently so close together that there is no economic incentive for users to charge regularly. On the other hand, however, charging often causes additional effort because the choice of parking location is limited and the charging process must be started and stopped. This has a particularly strong impact on company cars, for which employers generally provide a fuel card and therefore users do not have to pay for the fuel themselves. The electricity, on the other hand, must be paid for at least when vehicles are charged at home.

Some of the measures in the German government's climate protection programme are aimed at reducing the price of electricity for the end user while increasing the price for fossil fuels. This could to some extent counteract the false incentives mentioned above, but mainly addresses charging of private PHEVs and not charging of company cars if fuel cards are provided. With regard to company cars, it is particularly important to examine how the practice of using fuel cards can be regulated so that users have to pay for the fuel they use (e.g. by not allowing fuelcards or by mileage-dependent taxation). Until a clear incentive for charging PHEV company cars is established, the current subsidies for PHEVs within company car taxation should not be granted.

Improve charging infrastructure

PHEVs are mainly charged at private or company charging points, as this means less effort for the user compared to the use of public infrastructure and charging is not an immediate necessity as with BEVs. The charging frequency of PHEVs can therefore be improved in principle by all measures that improve the availability of non-public charging infrastructure. In particular, the recently enacted amendment of the German Condominium Act (Wohnungseigentumsgesetz), which aims at a simpler installation of charging infrastructure in multi-party buildings, should be mentioned here. For more information on the challenges we face in promoting private charging infrastructure, see separate box.

Simplify and financially support the installation of home and workplace chargers in buildings

Costly grid connections for parking lots in buildings is currently one of the biggest barriers to faster EV adoption. The economic burden for the tenant - whether an individual or a company - can be very heavy as neither the building owner nor the other tenants are usually willing to contribute financially. In some situations, the first tenant to install a charger would have to pay for expensive grid work and even pay for the ducting or cabling of all the parking spaces in order to have his/her parking spot equipped. Separate ad-hoc installation every time a tenant wishes to install a charger is very expensive, lengthy, ineffective, cumbersome and costly for society.

Alternatively, the optimal solution for these buildings is for the parking or building owner to cable several parking spots at once when there is a first request for a charger or a building is undergoing a renovation. With pre-equipment, chargers can easily be installed once the tenant/employer wishes and he/she would only pay the price of the equipment and very light installation to connect to the pre-equipped cables.

The German national government could set up a funding programme to cable shared parking lots in buildings (combined with simultaneous efforts of building renovation). In the short term, it will be necessary to also answer the growing need of companies looking to provide EVs for their employers.

Link incentives and subsidies to charging behavior

Additionally, the data from the OBFCM process could be evaluated for individual vehicles in order to set individual incentives for PHEV users to achieve a high proportion of electric driving. Since the OBFCM data for monitoring by the Commission is only transmitted anonymously, the data would have to be read out for each vehicle individually during the main inspection (two years after new registration). Depending on the resulting share of electric driving, financial incentives could then take effect. For example, only part of the purchase premium for PHEVs could be paid out at the time of registration, and the remaining part could be paid out only after the general inspection, provided that a certain minimum electric component is reached.

The advantage of such a procedure would be that the results would be directly related to personal usage behavior. The disadvantage, on the other hand, would be a presumably relatively high level of bureaucracy. Furthermore, it is questionable to what extent the prospect of a possible future payment actually has an effect on the user behaviour. Psychological studies show that future payment flows are generally underestimated due to psychological mechanisms ("hyperbolic discount").

It would also be conceivable to link the company car tax advantage to the electric mileage. To do this, this would have to be recorded regularly at each main inspection (usually every 24 months) and verified for the tax office, which would also represent a considerable bureaucratic burden.

Another option is to make a proof of private and/or company charging infrastructure a prerequisite for purchase premiums for PHEVs. A corresponding proof could be issued by the employer or the installing electrician. The implementation would be relatively simple. The disadvantage is that it cannot be ensured that the proven charging possibility is used. An important prerequisite for this would be the economic advantage for the user through electric driving, see above.

Increasing the incentives for manufacturers to ensure a high proportion of electric driving in the PHEVs they sell in practice (see section 6.1) could also lead to more attractive packages of vehicles, charging infrastructure and their installation by vehicle manufacturers. This could also encourage further simplification of charging (e.g. through contactless charging technology).

9.4 Set requirements for Operation modes

The study shows that real-world CO₂ emissions of PHEVs can be significantly influenced by the operating mode selected by the user. The design of the vehicle (system performance, battery size) also plays an important role. In the following situations, current PHEVs can activate the internal combustion engine even if the battery actually still has enough energy left for further electric driving:

- A high instantaneous power is required from the driver, which cannot be provided by the electric motor alone (so-called "boosting"). This occurs not only in the "Sport" mode, but sometimes also in the standard mode if the power requirement is high enough.
- If the user has activated the "Sport" mode, the combustion engine is also activated as a precautionary measure in some cases in order to be able to provide additional power without delay.
- Even if the user has activated the electric mode ("E" mode) and the battery is charged, the internal combustion engine can still be activated under certain conditions, such as at high speeds and low outside temperatures.

In order to technically ensure a high proportion of electric driving and to keep emissions low even when the internal combustion engine is activated, the following regulatory approaches are suitable:

- Specifications for the physical design of PHEVs. Options would be:
 - Require a minimum power for the electric machine with respect to the available system power
 - Require a minimum power for the electric machine with respect to the vehicle mass (such that e-power will be sufficient for all expectable real-world driving patterns)
- Specifications for the software-side design of the operating modes. Options:
 - Do not allow engine operation while battery is still charged (i.e. boosting would then be prohibited). Alternatively, this could only apply below certain speeds e.g. to ensure electric operation in urban areas.
 - Forbid Sport Mode, which would mean to effectively limit system power.
 - Require that the combustion engine must not kick-in while the vehicle is in e-mode (given that the battery is sufficiently charged), regardless of ambient conditions or power demand.
- Introduce a minimum all-electric range to the PHEV definition which is not ruled out by other criteria like type-approval CO₂ values. This requirement could be differentiated per vehicle segment in order to reflect different average usage habits (small cars usually have lower mileage).
- Specific requirements on combustion engine operation (CS mode). E. g., eligibility for purchase premiums could be bound to certain maximum CO₂ emissions in CS mode. This way, the risk of extreme deviations in real-world emissions from type-approval could be reduced even if it should prove impossible to effectively capture real-world utility factors.
- In order to develop concrete instruments in this area, further insights into the practical frequency of use of the various operating modes would be helpful.

9.5 Increase transparency

The study has shown that type approval values on CO₂ emissions of PHEVs only reflect reality to a very limited extent. With the introduction of the WLTP, the specific energy consumption values of PHEVs in CD and CS mode have tended to approximate reality, but a significant gap remains to values derived under real conditions. However, the WLTP process tends to overestimate the share of electric driving even more than the old NEDC process for most vehicle models (with electric range over 40 km).

In order to enable an informed discussion on the environmental impacts of PHEVs and their potential as a climate protection technology, a much higher level of transparency is required. On the one hand, this concerns the handling of the measured values collected during type approval; in particular, the specific energy consumption should be published separately for the various sub-steps of the WLTP (charge depletion and charge sustaining mode). This information would not only support experts in the assessment of GHG reduction measures, but could also be valuable for future users as part of the official passenger car energy consumption labelling scheme in order to reliably estimate their expected energy costs.

An additional opportunity is offered by the collection of real consumption values of the PHEV new car fleet via OBFCM from 2021 and their transfer to the EU Commission. This data will enable an effective comparison of type-approval values with actual vehicle use. However, a transparent handling of the data is required in order to be able to adapt policy instruments in a targeted manner.

References

- ADAC (2020a): Ecotest – Test- und Bewertungskriterien (ab 2/2019).
https://www.adac.de/_mmm/pdf/Methodik_EcoTest_2020_338652.pdf
(24.09.2020).
- ADAC (2020b): Plug-in-Hybrid: Mogelpackung oder Umweltfreund?
<https://presse.adac.de/meldungen/adac-ev/technik/plug-in-hybrid-mogelpackung-oder-umweltfreund.html>. (24.09.2020).
- ADAC (n.d.): Autotest Mercedes E 300 e 9G-TRONIC.
- DAT, D. D. A. T. G. (2019): Guide on the fuel economy, CO₂-Emissions and power consumption. <https://www.dat.de/fileadmin/media/LeitfadenCO2/GuideCO2.pdf>.
(24.07.2020).
- EFahrer.com (2020): Elektroautos 2020. <https://efahrer.chip.de/elektroautos>.
- European Commission (1999): REGULATION (EEC) No 4064/89.
- Fisch und Fischl GmbH (2020): Spritmonitor.de. <https://www.spritmonitor.de/>.
- GoingElectric (2020): GoingElectric. <https://www.goingelectric.de/zulassungszahlen/>.
- GreenCarGuide (2020): Mercedes-Benz E Class E300e EQ Power SE. In: *GreenCar-Guide.co.uk*.
- ifeu (2016): „Aktualisierung „Daten- und Rechenmodell: Ener-gieverbrauch und Schadstoffemissionen des motorisierten Verkehrs in Deutschland 1960-2035“ (TREMOMOD) für die Emissionsberichterstattung 2016 (Berichtsperiode 1990-2014). Heidelberg.
- ifeu (2020): Aktualisierung der Modelle TREMOD/TREMOMOD-MM für die Emissionsberichterstattung 2020 (Berichtsperiode 1990-2018) – Berichtsteil „TREMOMOD“. Heidelberg.
- IHS Markit (2019): Light Vehicle Production Forecasts. <https://ihsmarkit.com/products/automotive-light-vehicle-production-forecasts.html>.
- Jolly, J. (2020): Hybrid carmakers accused of “con” over zero-emissions claims. In: *The Guardian*.
- KBA (2020a): Bestand und Neuzulassungen - Sonderauswertung der Jahresdaten für TREMOD.
- KBA (2020b): Kraftfahrt-Bundesamt - Monatliche Neuzulassungen - Top 50 der Modelle im August 2020. https://www.kba.de/DE/Statistik/Fahrzeuge/Neuzulassungen/MonatlicheNeuzulassungen/fz_n_MonatlicheNeuzulassungen_archiv/2020/202008_Glmonatlich/202008_n_top50.html?nn=2592390.
(24.09.2020).
- Keilhof, D. (2015): Ein methodischer Ansatz zur Erstellung von Hybrid- Betriebsstrategien für die simulative Ermittlung von Lastkollektiven. In: *Wissenschaftliche Reihe Fahrzeugtechnik Universität Stuttgart*.

- Kräck, J.; Jöhrens, J.; Helms, H. (2015): Ermittlung des realitätsnahen und nutzerspezifischen Energieverbrauchs aktueller Elektrofahrzeuge auf Basis individueller Fahrprofile und standardisierter Messdaten. In: *Elektrik/Elektronik in Hybrid- und Elektrofahrzeugen und elektrisches Energiemanagement VI*. Haus der Technik Fachbuch expert-Verlag, Renningen. S. 177–190.
- Kraftfahrtbundesamt (2020a): Fahrzeuge Jahresbilanz 2020. https://www.kba.de/DE/Statistik/Fahrzeuge/Bestand/Jahresbilanz/b_jahresbilanz_inhalt.html?nn=2601598.
- Kraftfahrtbundesamt (2020b): Fahrzeuge Bestand nach ausgewählten Merkmalen. https://www.kba.de/DE/Statistik/Produktkatalog/produkte/Fahrzeuge/fz27_b_uebersicht.html.
- Kraftfahrtbundesamt (2020c): KBA Glossar. <https://www.kba.de/SharedDocs/Glossareintraege/DE/S/Segment.html>.
- Mercedes Benz (2020): WLTP Verbrauchs- und Emissionswerte. <https://www.mercedes-benz.com/de/fahrzeuge/wltp/wltp-verbrauchs-und-emissionswerte/>.
- Mercedes-Benz (2020): Die neue E-Klasse Limousine mit Plug-in-Hybrid. <https://www.mercedes-benz.de/passengercars/mercedes-benz-cars/models/e-class/saloon-w213-fl/specifications.html>. (24.09.2020).
- Oeko Institut (2017): ePowered Fleets Hamburg–Elektromobilität in Flotten.
- Öko-Institut; Fraunhofer ISI; IREES (2020): Treibhausgasminderungswirkung des Klimaschutzprogramms 2030.
- Plötz, P.; Funke, S. Á.; Jochem, P. (2018): Empirical Fuel Consumption and CO2 Emissions of Plug-In Hybrid Electric Vehicles: Fuel Consumption of Plug-In Hybrid Electric Vehicles. In: *Journal of Industrial Ecology*. Vol. 22, No.4, S. 773–784.
- Plötz, P.; Moll, C.; Mock, P.; Bieker, G.; Li, Y.; Gasmi, J.; El-Deeb, A. (2020): Real-world usage of plug-in hybrid electric vehicles - Fuel consumption, electric driving, and CO2 emissions. Fraunhofer Institute for System and Innovation research ISI, International Council of Clean Transportation ICCT, Karlsruhe, Berlin, Washington.
- Reif, K. (2016): Grundlagen Fahrzeug- und Motorentechnik im Überblick. S. 92–105.
- Riemersma, I. (2016): Technical Report on the development of a Worldwide Harmonised Light duty vehicle Test Procedure (WLTP). <https://www.unece.org/fileadmin/DAM/trans/doc/2015/wp29grpe/GRPE-72-02-Rev.1.pdf> (03.02.2020).
- Riemersma, I.; Mock, P. (2017): Too low to be true? How to measure fuel consumption and CO2 emissions of plug-in hybrid vehicles, today and in the future.
- SAE (2010): Utility Factor Definitions for Plug-In Hybrid Electric Vehicles Using Travel Survey Data. https://www.sae.org/standards/content/j2841_201009/.
- Transport & Environment (2019): Electric surge - Carmakers' electric car plans across Europe 2019-2025. https://www.transportenvironment.org/sites/te/files/publications/2019_07_TE_electric_cars_report_final.pdf (24.03.2020).
- Transport & Environment (2020): Recharge EU - how many charging points will Europe and its member states need in the 2020s. Brüssel. <https://www.transportenvironment.org/sites/te/files/publications/01%202020%20Draft%20TE%20Infrastructure%20Report%20Final.pdf> (22.04.2020).
- TU Graz (2019): Update of emission factors for HBEFA Version 4.1. https://www.hbefa.net/e/documents/HBEFA41_Report_TUG_09092019.pdf.