
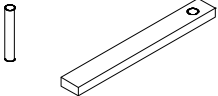

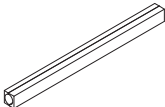



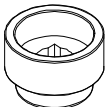



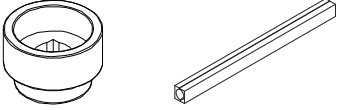
When ordering replacement Ultimate Inswing French Door parts specify type of unit, part number and description.

ILLUSTRATIONS (not to scale)		
<p>Active Panel</p> <p>Interior: (A), (C), (G), (H), (I), (J), (K)</p> <p>Exterior: (B), (D), (E), (F)</p>	<p>Inactive/Dummy</p> <p>Interior: (A), (E), (F), (G)</p> <p>Exterior: (B), (C), (D)</p>	
<p>Handle Assembly, Active Panel Mortise lock and Multi-point lock systems (Schlage "C" keyway) Includes: 1 - Interior lever (A) with 00142006 spindle, escutcheon plate and hardware 1 - Exterior lever (B) with escutcheon plate and hardware 1 - Thumb turn (C) with hardware 1 - Keyed cylinder (D) with housing and hardware 1 - Exterior escutcheon plate gasket (E) 1 - Exterior escutcheon plate (F) 1 - Two piece spindle (G) 2 - #10-32 x 2 1/8" Phillips ovalhead machine screws (H) 1 - Interior escutcheon plate (I) 1 - Thumb turn washer (J) 1 - Thumb turn push nut (K) 2 - Keys</p>	<p>Satin Taupe Antique Brass White Satin Chrome Oil Rubbed Bronze ORBZ PVD Brass PVD Satin Nickel PVD Dark Bronze Polished Chrome</p>	<p>10148114 10148116 10148119 10148112 10148111 10148109 10148160 10148110 10148169 10148117</p>
<p>Handle Assembly, Inactive/Dummy Includes: 1 - Interior lever (A) with 00142006 spindle, escutcheon plate and hardware 1 - Exterior lever (B) with escutcheon plate and hardware 1 - Exterior escutcheon plate gasket (C) 1 - Exterior escutcheon plate (D) 1 - Two piece spindle (E) 2 - #10-32 x 2 1/8" Phillips ovalhead machine screws (F) 1 - Interior escutcheon plate (G)</p>	<p>Satin Taupe Antique Brass White Satin Chrome Oil Rubbed Bronze ORBZ PVD Brass PVD Satin Nickel PVD Dark Bronze Polished Chrome</p>	<p>10148151 10148147 10148150 10148153 10148154 10148156 10148161 10148133 10148164 10148148</p>
<p>Thumb Turn (C) NOTE: For each thumb turn, order one thumb turn washer -00143045 (J) and one thumb turn push nut 00143010 (K).</p>	<p>Satin Taupe Antique Brass White Oil Rubbed Bronze Brass PVD Satin Nickel PVD Satin Chrome Dark Bronze Oil Rubbed Bronze PVD</p>	<p>00142061 00142055 00142058 00142062 00142054 00142063 00142064 10148426 10148428</p>

PARTS – TRADITIONAL HANDLE

ILLUSTRATION NOT TO SCALE	DESCRIPTION	LENGTH./COLOR	PART NO.
	Lug seals		00142046
	Actuator with Rol-Pin <i>9/25/00 – Present</i>		05570548
	#10-32 x 2 1/8" Phillips ovalhead machine screw	Satin Taupe Antique Brass White Satin Chrome Oil Rubbed Bronze ORBZ PVD Brass PVD Satin Nickel PVD Dark Bronze	11800616 00143038 00143036 10840031 10840032 11800160 11800615 11801020 11800654
	Spindle Kit (Ashland) <i>Includes:</i> 1 – 2 piece. spindle, 4 3/8" 2 – Set screws		18900392
	Spindle Kit (Truth) <i>For ORBZ handle sets produced after March 2009.</i> <i>Includes:</i> 1 – 2 piece. spindle, 4 3/8" 2 – Set screws	ORBZ	02100942
	Key Cylinder, Lock (Schlage "C" keyway) For service replacement only.	Brass Face Chrome Face	00142000 00142001
	Set Screw for Handle Assembly See Spindle kit		NA
	3/4" Handle Extension Requires 3/4" Spindle Extension	TP WH BS PVD AB ORBZ ORBZ PVD SC SN PVD PC DK BZ	10830048 10830054 10830050 10830052 10833038 10830012 10830036 10833037 10830056 10833039
	3/8" Handle Extension Requires 3/8" Spindle Extension	TP WH BS PVD AB ORBZ ORBZ PVD SC SN PVD PC DK BZ	10830049 N/A N/A N/A 10830039 10830011 N/A N/A N/A 10833040
	3/4" Spindle Extension 3/8" Spindle Extension	5 13/16" 5 1/16"	00142051 18900393

PARTS – TRADITIONAL HANDLE

ILLUSTRATION NOT TO SCALE	DESCRIPTION	LENGTH./COLOR	PART NO.
	<p>1 3/4" Swinging Handle Set Kit – Interior Shades</p> <p><i>Includes:</i></p> <p>1 – 3/4" extension handle 1 – Spindle, lever handle, 2 pc. assembly 1 – Installation instruction</p>	<p>TP WH BS PVD AB ORBZ ORBZ PVD SC SN PVD PC DK BZ</p>	<p>18900650 18900651 18900652 18900653 18900654 18900655 18900656 18900657 18900669 18900658</p>

When ordering replacement Ultimate Inswing French Door parts specify type of unit, part number and description.

ILLUSTRATIONS (not to scale)		
<p>Active Panel</p> <p>Exterior</p> <p>Interior</p>	<p>Inactive/Dummy</p> <p>Interior</p> <p>Exterior</p>	
<p>Handle Assembly, Active Panel Mortise lock and Multi-point lock systems (Schlage “C” keyway) Includes: 1 – Interior lever (A) with 10148414 spindle, escutcheon plate and hardware 1 – Exterior lever (B) with escutcheon plate and hardware 1 – Thumb turn (C) with hardware 1 – Keyed cylinder (D) with housing and hardware 1 – Exterior escutcheon plate gasket (E) 1 – Exterior escutcheon plate (F) 1 – Two piece spindle (G) 2 – M5 x 55mm Phillips ovalhead machine screws (H) 1 – Interior escutcheon plate (I) 1 – Thumb turn washer (J) 1 – Thumb turn push nut (K) 2 – Keys</p>	<p>TP ORBZ PVD SN PVD DK BZ</p>	<p>11102150 11102151 11102152 11102156</p>
<p>Handle Assembly, Inactive/Dummy Includes: 1 – Interior lever (A) with 00142006 spindle, escutcheon plate and hardware 1 – Exterior lever (B) with escutcheon plate and hardware 1 – Exterior escutcheon plate gasket (C) 1 – Exterior escutcheon plate (D) 1 – Two piece spindle (E) 2 – M5 x 55mm Phillips ovalhead machine screws (F) 1 – Interior escutcheon plate (G)</p>	<p>TP ORBZ PVD SN PVD DK BZ</p>	<p>11102153 11102154 11102155 11102157</p>
<p>Thumb Turn (C) NOTE: For each thumb turn, order one thumb turn washer –10148423(J) and one thumb turn push nut 10148424(K).</p>	<p>TP ORBZ PVD SN PVD DK BZ</p>	<p>10148425 10148428 10148427 10148426</p>

PARTS – CONTEMPORARY HANDLE


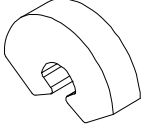

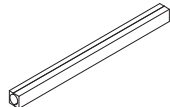


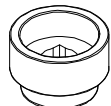

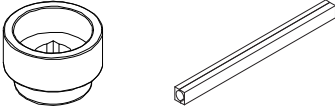
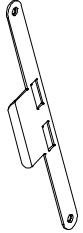
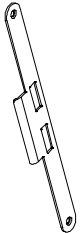
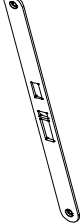
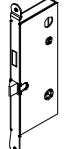
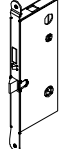
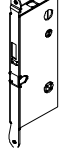
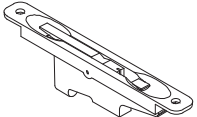
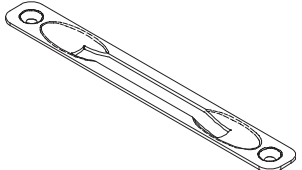
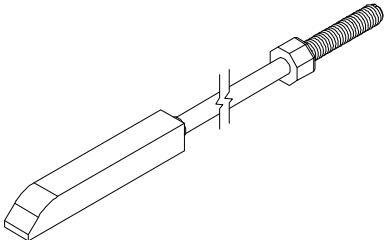
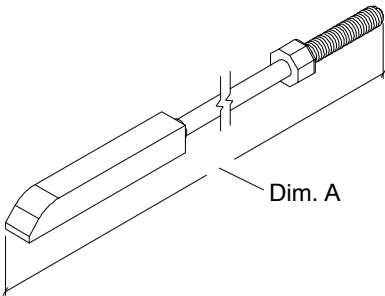
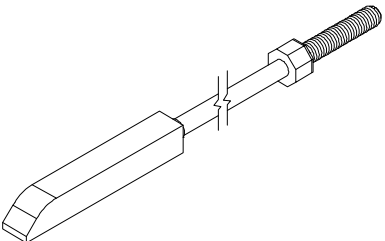
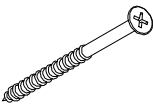
ILLUSTRATION NOT TO SCALE	DESCRIPTION	LENGTH./COLOR	PART NO.
	Gasket Post		10148404
	Gasket – Top Backplate		10148405
	M5 x 55mm Phillips ovalhead machine screw	TP ORBZ PVD SN PVD DK BZ	10148400 10148402 10148403 10148401
	Spindle Kit (HOPPE) <i>Includes:</i> 1 – 2 piece. spindle, 4 3/8" 2 – Set screws		10148414
	Key Cylinder, Lock (Schlage “C” keyway) For service replacement only.	Brass Face Chrome Face	10148418 10148417
	Set Screw for Handle Assembly See Spindle kit		NA
	3/4" Handle Extension Requires 3/4" Spindle Extension	TP ORBZ PVD SN PVD DK BZ	10148419 10148421 10148422 10148420
	3/4" Spindle Extension (HOPPE)		10148415
	1 3/4" Swinging Handle Set Kit – Interior Shades <i>Includes:</i> 1 – 3/4" extension handle 1 – Spindle, lever handle, 2 pc. assembly 1 – Installation instruction	TP ORBZ PVD SN PVD DK BZ	21448100 21448102 21448103 21448101

ILLUSTRATION NOT TO SCALE	DESCRIPTION	OPER./COLOR	PART NO.
	<p>Strike Plate, Jamb-Mortise Lock or Multi-Point Lock <i>This strike was used from 1999-2011 on the jamb only. (Amerock)</i> Includes: 1 - Jamb strike plate 2 - #8x1" Brass Phillips flathead wood screws*</p>	<p>Stainless Steel Antique Brass ORBZ PVD Brass PVD</p>	<p>05700300 05700301 05700302 10148177</p>
	<p>Strike Plate, Inactive Panel-Mortise Lock or Multi-Point Lock <i>This strike is used on the inactive panel (mortise lock or Multi-Point from 1999 - Present) and on the jamb from 2011 - Present (Amerock)</i> Includes: 1 - Jamb strike plate 2 - #8x1" Brass Phillips flathead wood screws*</p>	<p>Stainless Steel Antique Brass ORBZ PVD Brass PVD</p>	<p>05700303 05700304 05700305 10148178</p>
	<p>Cover Plate, Active Mortise Lock or Multi-Point Lock <i>5/10/99 - Present (Amerock)</i> Includes: 1 - Cover plate 2 - #8x1" Phillips flat head wood screws*</p>	<p>Stainless Steel Antique Brass ORBZ PVD Brass PVD</p>	<p>05700306 05700307 05700308 10148179</p>
	<p>Mortise Lock, Active Single Point (latch and dead bolt only) <i>1/17/00 - Present (Amerock)</i></p>		<p>05700129</p>
	<p>Mortise Lock, Active Multi-Point Lock (latch, dead bolt and head/foot shoot bolts) <i>5/10/99 - Present (Amerock)</i></p>		<p>05700130</p>
	<p>Mortise Lock, Inactive Panel Multi-Point Lock (head/foot shoot bolts) <i>5/10/99 - Present (Amerock)</i></p>		<p>05700131</p>
	<p>Head or Foot Flush Bolt - Inactive Panel</p>	<p>Black</p>	<p>11101780</p>
	<p>Cover Plate for Flush Bolt Includes: 1 - Cover plate 2 - #8 x 1" Screws</p>	<p>Aluminum</p>	<p>11860402</p>

* Stainless Steel - 11800645, Dark Bronze - 11800652, PVD Brass - 11800536

NOTE: Dark Bronze screws are used with Antique Brass and Oil Rubbed Bronze.

ILLUSTRATION <i>NOT TO SCALE</i>	DESCRIPTION	OPER./COL OR	PART NO.														
	<p>Inactive Panel Locking Rod Assembly, Top or Bottom Flush Bolt 5/10/99 – Present <i>Includes:</i> 1 – Locking rod with end bolt</p> <p>NOTE: For 8-0 ht order top locking rod 05700185.</p> <table border="0"> <tr> <td>Height</td> <td>Top Locking Rod Length</td> </tr> <tr> <td>CN 6-6R ht*</td> <td>11"</td> </tr> <tr> <td>CN 6-8 ht</td> <td>11"</td> </tr> <tr> <td>CN 7-0 ht</td> <td>11"</td> </tr> <tr> <td>CN 8-0 ht</td> <td>27"</td> </tr> </table> <table border="0"> <tr> <td>Height</td> <td>Bottom Locking Rod Length</td> </tr> <tr> <td>All heights</td> <td>11"</td> </tr> </table>	Height	Top Locking Rod Length	CN 6-6R ht*	11"	CN 6-8 ht	11"	CN 7-0 ht	11"	CN 8-0 ht	27"	Height	Bottom Locking Rod Length	All heights	11"	<p>Stainless Steel</p>	<p>05700180 05700180 05700180 05700185 05700180</p>
Height	Top Locking Rod Length																
CN 6-6R ht*	11"																
CN 6-8 ht	11"																
CN 7-0 ht	11"																
CN 8-0 ht	27"																
Height	Bottom Locking Rod Length																
All heights	11"																
	<p>Locking Rod Assembly, Top for Multi-Point</p> <p>3/02 – Present (Amerock) 8-0 Height see History 5/10/90 – Present (Amerock) 6-5, 6-8, & 7-0 Height Solid stainless steel rod with 1/4" – 20 threads</p> <p>NOTE: For special heights give dimension A.</p> <table border="0"> <tr> <td>Height</td> <td>Top Locking Rod Length</td> </tr> <tr> <td>CN 6-6R ht</td> <td>35 7/16"</td> </tr> <tr> <td>CN 6-8 ht</td> <td>37 15/16"</td> </tr> <tr> <td>CN 7-0 ht</td> <td>41 15/16"</td> </tr> <tr> <td>CN 8-0 ht</td> <td>51 7/16"</td> </tr> </table>	Height	Top Locking Rod Length	CN 6-6R ht	35 7/16"	CN 6-8 ht	37 15/16"	CN 7-0 ht	41 15/16"	CN 8-0 ht	51 7/16"	<p>Stainless Steel</p>	<p>05700174 05700176 05700177 05700179</p>				
Height	Top Locking Rod Length																
CN 6-6R ht	35 7/16"																
CN 6-8 ht	37 15/16"																
CN 7-0 ht	41 15/16"																
CN 8-0 ht	51 7/16"																
	<p>Locking Rod Assembly, Bottom for Multi-Point Lock</p> <p>5/10/99 – Present (Amerock) Solid stainless steel rod with 1/4" – 20 threads</p> <table border="0"> <tr> <td>Height</td> <td>Bottom Locking Rod Length</td> </tr> <tr> <td>CN 6-6R ht*</td> <td>34 9/32"</td> </tr> <tr> <td>CN 6-8 ht</td> <td>34 9/32"</td> </tr> <tr> <td>CN 7-0 ht</td> <td>34 9/32"</td> </tr> <tr> <td>CN 8-0 ht</td> <td>34 9/32"</td> </tr> </table>	Height	Bottom Locking Rod Length	CN 6-6R ht*	34 9/32"	CN 6-8 ht	34 9/32"	CN 7-0 ht	34 9/32"	CN 8-0 ht	34 9/32"	<p>Stainless Steel</p>	<p>05700170</p>				
Height	Bottom Locking Rod Length																
CN 6-6R ht*	34 9/32"																
CN 6-8 ht	34 9/32"																
CN 7-0 ht	34 9/32"																
CN 8-0 ht	34 9/32"																
	<p>Long Hinge Screw Package <i>Includes:</i> 4 – #10 X 2 1/2" Screws 1 – 5/32" Allen wrench</p> <p>NOTE: Order Dark Bronze screw package for Dark Bronze, Antique Brass and Oil Rubbed Bronze Hinges. Order Stainless Steel screw package for Silver Frost, Satin Chrome and Satin Nickel PVD Hinges .</p>	<p>TP GT DKBZ WH SS BS PVD</p>	<p>11800653 11800632 11800644 11800637 11800639 10148185</p>														

PARTS

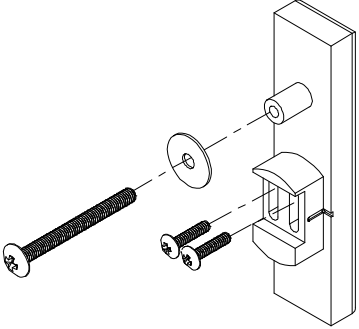
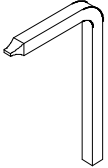
ILLUSTRATION NOT TO SCALE	DESCRIPTION	OPER./COL OR	PART NO.
	<p>Construction Lock Assembly For Marvin residential swinging and sliding doors with standard locks. <i>Includes:</i> 1 - Construction Lock Cover 1 - Construction Lock Hole Cover 1 - Washer 2 - #6-32 X 5/8" Phillips TH screws 1 - #10-32 X 2" Phillips TH screw</p>	Each 25/Box	18450200 18450198
	<p>Construction Handle</p>		05700133

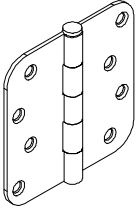
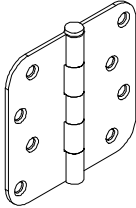
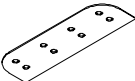
ILLUSTRATION NOT TO SCALE	DESCRIPTION	HINGE COLOR/PART NO.		SCREW COLOR/PART NO.	
	<p>4" Butt Hinge <i>Includes:</i> 1 - 4" hinge 7 - #9 x 1" Phillips flathead wood screws 1 - #10 x 2 1/2" Phillips flathead wood screw (frame)</p>	TP 02101133 BP 02101134 AB 02101135 WH 02101136 SC 02101137 ORBZ 02101138 SN 02101139 PC 02100483	TP 11868808 BP 11808355 DKBZ 11213832 WH 11808359 SS 11213828 DKBZ 11213832 SS 11213828 SS 11213828 TP 11800683 BP 11800679 DKBZ 11800680 WH 11800682 SS 11800684 DKBZ 11800680 SS 11800684 SS 11800684		
	<p>4" Butt Hinge NRP = Non Removable Pin <i>Includes:</i> 1 - 4" hinge 7 - #9 x 1" Phillips flathead wood screws 1 - #10 x 2 1/2" Phillips flathead wood screw (frame)</p>	BS 02101140 SN PVD 02100599 SS 11809005		#9x1" 11213824 #10x2 1/2" 11800679	
	<p>4" Butt Hinge Shim</p>	10500222			

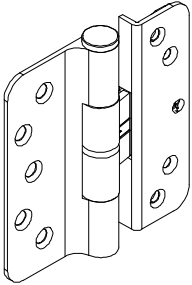
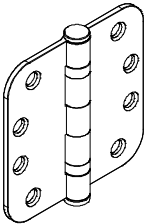
ILLUSTRATION NOT TO SCALE	DESCRIPTION	HINGE COLOR	LEFT PART NO.	RIGHT PART NO.
	<p>Hinge Kit, Adjustable Includes: 1 - Adjustable hinge 1 - #10x2 1/2" Phillips flathead wood screws (jamb) 5 - #10x3/4" Phillips flathead wood screws (jamb, stationary stile) 4 - #8x1 1/2" Phillips flathead wood screws (panel)</p> <p>NOTE: Hinge part number includes the color matched screws. If you need to order the screws separately, they are listed below.</p>	TP GT SF DKBZ AB WH SC ORBZ ORBZ PVD BS PVD SN PVD PC	02101216 02101213 02101218 02101217 02101210 02101214 02101212 02101219 02101211 02101215 02101220 02101234	02101227 02101224 02101229 02101228 02101221 02101225 02101223 02101230 02101222 02101226 02101231 02101235
<p>SCREW DESCRIPTION</p>	<p>SCREW COLOR/PART NO.</p>	<p>MATCHING HINGE COLOR</p>		
<p>#8x1 1/2" Phillips flathead wood screws (panel). Quantity of four needed per hinge.</p>	TP 11865177 GT 11865172 WH 11865173 DKBZ 02058013 BS PVD 11865176 SS 11865175	TP GT WH AB, ORBZ PVD, DKBZ, ORBZ BS PVD, SC, SF, SN PVD, PC		
<p>#10x 3/4" Phillips flathead wood screws (jamb) (stationary stile). Quantity of five needed per hinge.</p>	TP 11800674 GT 11800670 WH 11800671 DKBZ 11800669 BS PVD 11800673 CHROME 11800672	TP GT WH AB, ORBZ PVD, DKBZ, ORBZ BS PVD, SC, SF, SN PVD, PC		
<p>#10x2 1/2" Phillips flathead wood screws (jamb). Quantity of one needed per hinge.</p>	TP 11800683 GT 11800681 WH 11800682 DKBZ 11800680 BS PVD 11800679 SS 11800684	TP GT WH AB, ORBZ PVD, DKBZ, ORBZ BS PVD, SC, SF, SN PVD, PC		
	<p>Ball Bearing Hinge 4" x 4"</p>	BS SC BZ	02100470 02100471 02100472	

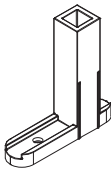
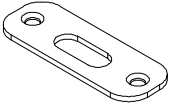
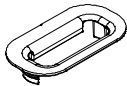
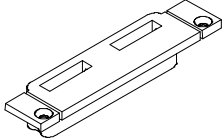
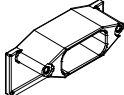
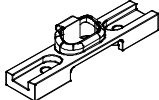
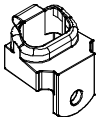

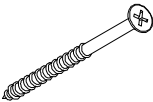
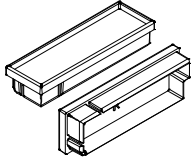
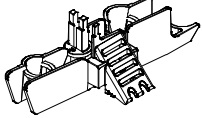

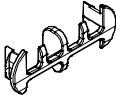
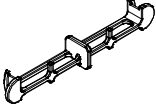



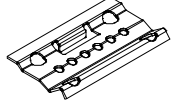
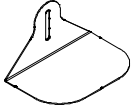
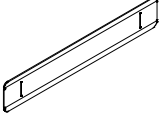
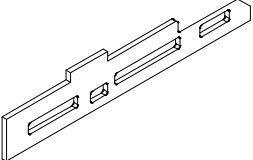
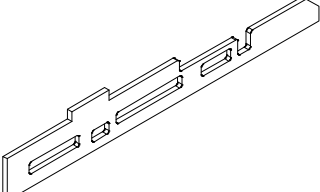





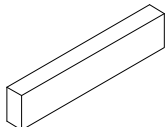
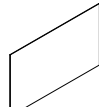
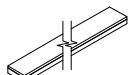
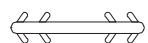
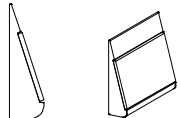
ILLUSTRATION NOT TO SCALE	DESCRIPTION	OPER./COLOR	PART NO.
	End Bolt Guide <i>Includes:</i> 1 – End Bolt guide 1 – #8x1 1/2" Phillips panhead wood screw (11865159)		10815186
	Strike Plate, Head Jamb <i>Includes:</i> 1 – Strike plate 2 – #8x1" Phillips flathead wood screws (head jamb) (11800645)	Stainless Steel	05700320
	Strike Plate, Sill <i>Includes:</i> 1 – Strike plate	BG BZ	11869839 11869840
	Lock Retainer	Zinc plated BK	11869831
	Shoot Bolt Retainer	Zinc plated BK	11869847
	Sill Bolt Stationary Inswing Panel <i>Includes:</i>	Zinc plated BK	11869834
	Sill Bolt Mull Post Stationary Clad Inswing Mull Post	Zinc plated BK	11869833
	Sill Bolt Mull Post Stationary Wood Inswing Mull Post	Zinc plated BK	11869830
	Installation Screw Package; Strike Plate(s) at head jamb, sill, or locking jamb #8 x 2 1/2" Flathead wood screw Package of 2 Package of 2 Package of 2	Stainless Steel Brass PVD Antique Brass	11882349 11882343 11882347

ILLUSTRATION NOT TO SCALE	DESCRIPTION	OPER./COLOR	PART NO.
 <p>RH Shown</p>	End Plug, Flat Casing	LH BG RH BG LH BZ RH BZ	11869852 11869850 11869853 11869851
	Pre 2014 Sill End Plug	LH BK RH BK	11869836 11869837
	Pre 2014 Sill End Plug Extension – 6 9/16"	BK	11869835
	Pre 2014 Sill Outlet Drain Cover	BK	15633100
	Pre 2014 Sill Drain Cover	BG BZ	15633101 15633102
	Head Jamb Spacer Tack; Stationary Panel		11860424
	Jamb Spacer Tack; Stationary Panel 3/4" Diameter Head (replaced 7/16" diameter head)		11860423
	Clad Astragal End Cap <i>(Clad Doors Only)</i>	LH BZ RH BZ	11869841 11869842
	Stationary Panel Bracket Wood and Clad Field Service		05700165
	Bracket, Jamb-Align		11841020
	Receiver, Jamb Align	LH BG	11841002

When ordering replacement weather strip specify quantity, part number, length and description.

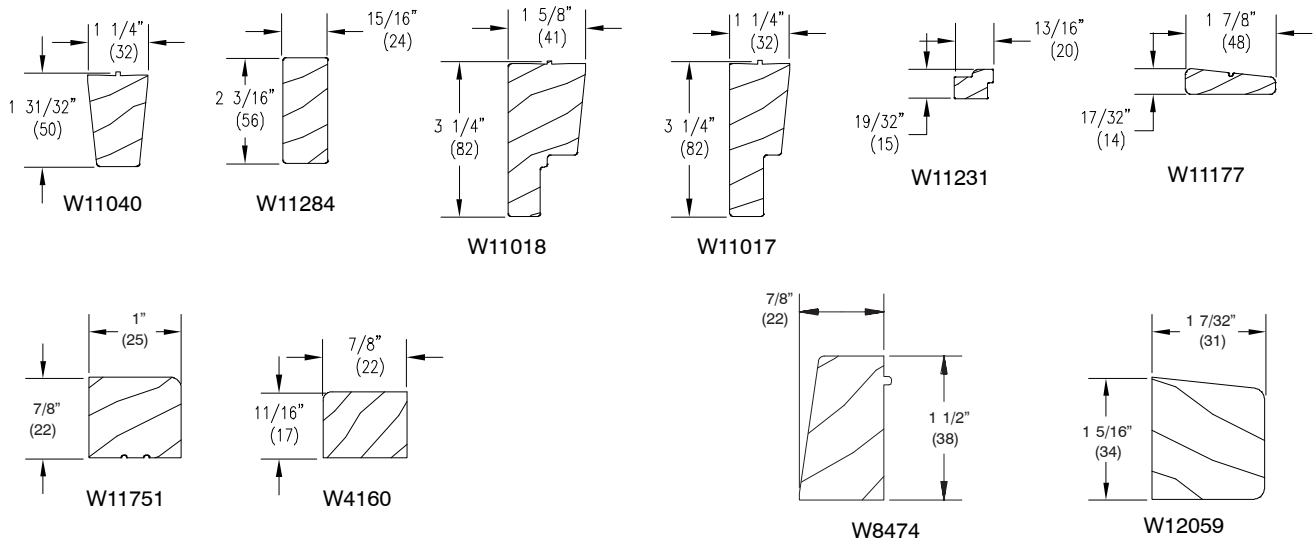
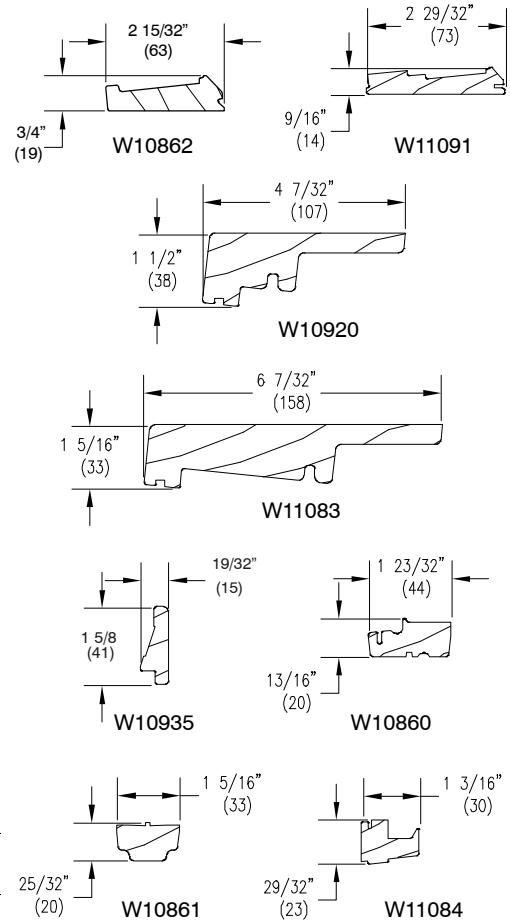
ILLUSTRATION NOT TO SCALE	DESCRIPTION	LENGTH	COLOR	PART NUMBER
	Offset Bulb Weather Strip, Mull Casing, Transom and Astragal V796	92 7/8" (2359) 92 7/8" (2359)	BG BK	15170082 15170083
	Inactive Panel Stile Center V780	92 15/32" (2349) 92 15/32" (2349) 150" (3810) 150" (3810)	BG BK BG BK	15174082 15174083 15174099 15174098
	Flex-Bulb Weather Strip V192	192" (4877) 192" (4877)	BG BK	15900118 15900117
	Head Jamb and Jamb Parting Stop Weather Strip V2244 <i>Usage: January 6, 2014 to present.</i>	46 1/2" (1207) 46 1/2" (1207) 83" (2096) 83" (2096) 123 11/16" (3142) 123 11/16" (3142) 164 7/8" (4188) 164 7/8" (4188)	BG BK BG BK BG BK BG BK	15192640 15192641 15192970 15192971 15192810 15192811 15192914 15192915
	Dust Block Adhesive backed 1 3/8" x 1/4" x 3/8"		GY	10500049
	Dust Block Adhesive backed 1 1/2" x 3/8" x 1/2"		BG BK	15600518 15600519
	Parting Stop Retainer Clip, Clad	6" (152)	Neutral	11199507
	Sill to Jamb Stop Gasket		BG BK	11866264 11866265

WEATHER STRIP AND VINYL

ILLUSTRATION <i>NOT TO SCALE</i>	DESCRIPTION	LENGTH	COLOR	PART NUMBER
	Pre 2014 Gasket, Sill to Jamb – 4 9/16" Adhesive backed <i>Includes</i> 1 – LH 1 – RH		GY	15600020
	Pre 2014 Gasket, Sill to Jamb – 6 9/16" Adhesive backed <i>Includes</i> 1 – LH 1 – RH		GY	15600021
	Pre 2014 Corner Gasket Adhesive backed		BK	15600023
	Gasket, Bottom Astragal Adhesive backed		BK	15600025
	Gasket, Bottom Mull Adhesive backed		BK – RH BK – LH	10500395 10500396
	Pre 2014 Gasket, Jamb Weather Strip 3/4" – Header Adhesive backed		BK	10500542
	Plug, Foam 1 1/2" x 1" Mull Post to Sill Adhesive backed		BK	10500507
	Pre 2014 Block, Foam 4" x 1/2" Parting Stop Adhesive backed NOTE: Order 3 per side.			10500318
	Butyl Tape 3" Width	Per Roll	BK	11406302
	Butyl Foam Tape 3/16" Width Adhesive backed	25 FT Roll	BK	11406232
	Connecting Barb V803 NOTE: Color may vary depending on current stock. Wood Door, Wood and Clad Transom only	Specify Length LF		15812999
	Sill Interior Filler Block V2077		BG BZ	11124200 11124201

	Wood	Clad
Head Jamb and Jamb Parting Stop	W10862	---
Head Jamb and Jamb Parting Stop Historic	W11091	---
Wood Cover Sill Mahogany – 4 9/16"	W10920	W10920
Wood Cover Sill Mahogany –6 9/16"	W11083	W11083
Sill Liner – Oak, Cherry or Mahogany	W10935	W10935
Mull Casing Base	W10860	---
Astragal Cover and Transom Mull Cover	W10861	---
Sill Filler (In-sash Transom)	W11084	W11084
Mull Casing	W11040	---
Mull Extender 6 9/16" Jamb	W11284	---
Mull Casing Swinging Screen 4 9/16" & 6 9/16" Jambs	W11018	---
Mull Casing Top Hung Sliding Screen, 4 9/16" & 6 9/16"	W11017	---
Top Rail Block	W11231	W11231
Spacer Block Clad Part Stop		W11177
Interior Glazing Bead Direct Glaze Transom June 24, 2013 – present	W11751	W11751
Interior Glazing Bead Direct Glaze Transom Pre-June 24, 2013	W4160	W4160
Exterior Part Stop – Direct Glaze Transom Pre-June 24, 2013	W8474	
Sill Nosing – Direct Glaze Transom	W12059	
Sill Nosing – Direct Glaze Transom – Pre-June 24, 2013	W8653	

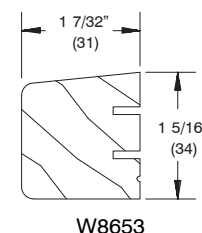
NOTE: Replacement wood parts are supplied with connecting barb (where applicable).



TO ORDER REPLACEMENT WOOD PARTS

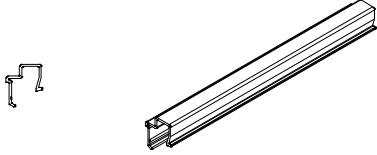
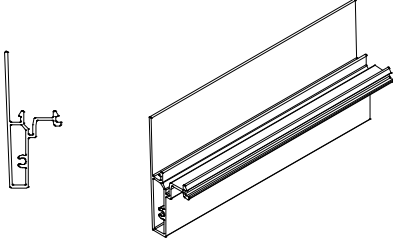
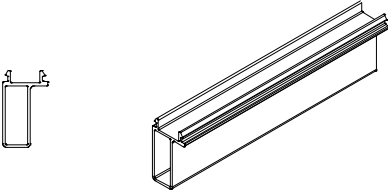
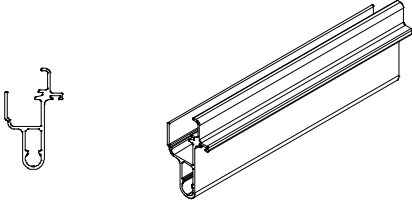
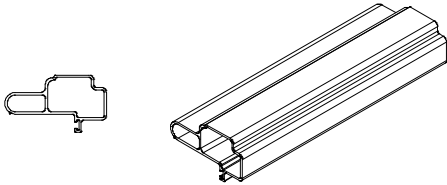
When ordering replacement wood parts specify:

1. profile number;
2. rough opening;
3. handing;
 - a. on jamb parting stop specify right or left jamb (viewed from exterior)
4. length;
5. finish.



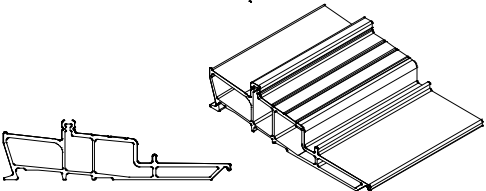
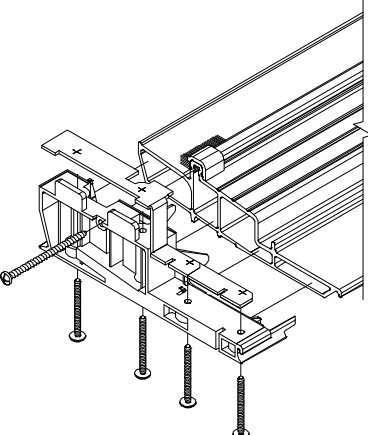
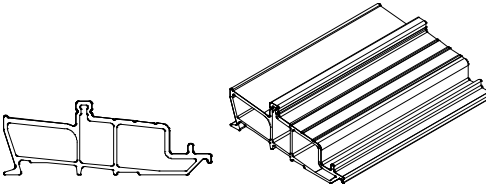
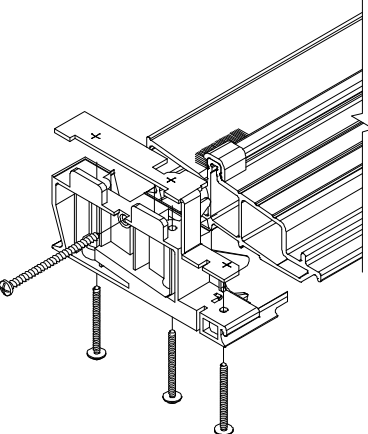
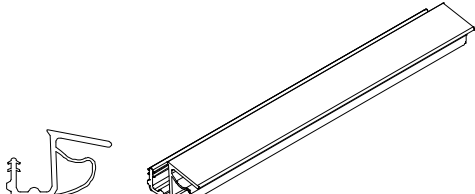
When ordering replacement aluminum parts specify:

- | | |
|----------------------------------|------------------------|
| 1. profile number; | 4. LH or RH operation; |
| 2. call number or rough opening; | 5. type of product; |
| 3. length; | 6. finish. |

ILLUSTRATION <i>NOT TO SCALE</i>	DESCRIPTION
	Jamb Adaptor Ultimate Swinging Screen A1958
	Mull Cap Swinging Screen Clad only A2049
	Mull Cap Top Hung Screen Clad only A2048
	Jamb Z-Bar Ultimate Swinging Screen A1964
	Header Z-Bar Ultimate Swinging Screen A1948

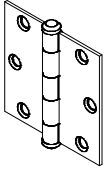
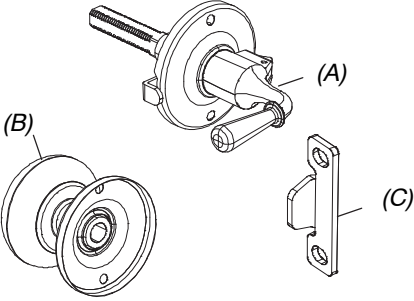
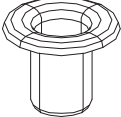
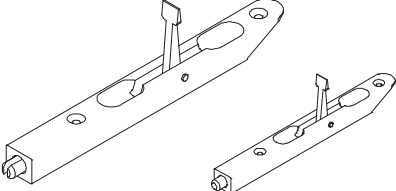

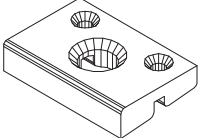
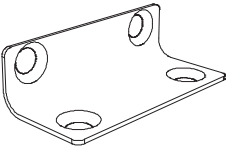
When ordering replacement vinyl or fiberglass parts specify:

- | | |
|----------------------------------|------------------------|
| 1. profile number; | 4. LH or RH operation; |
| 2. call number or rough opening; | 5. type of product; |
| 3. length; | 6. finish. |

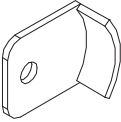
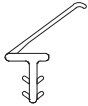

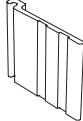
ILLUSTRATION <i>NOT TO SCALE</i>	DESCRIPTION
	<p>Pre 2014 Sill 6 9/16" Beige or Bronze F2051</p>
	<p>2014 Sill 6 9/16" Beige or Bronze F2051</p>
	<p>Pre 2014 Sill, 4 9/16" Beige or Bronze F2050</p>
	<p>2014 Sill, 4 9/16" Beige or Bronze F2050</p>
	<p>Door Sweep/Drip Beige or Black V2037</p>

WOOD ULTIMATE INSWING FRENCH DOOR COMBINATION DOOR PARTS 02/28/2011 TO PRESENT.

When ordering replacement combination parts specify quantity, part number and description.

ILLUSTRATION NOT TO SCALE	DESCRIPTION	COLOR	PART NO.
	Hinge, Solid Brass <i>Includes:</i> 1 - Butt hinge, 3" x 3" 6 - #8x3/4" Phillips flathead wood screws		02100547
	Handle Package, Solid Brass Ultimate Inswing French Door 1993 - Present Inswing French Door 5/98 - Present <i>Includes:</i> 1 - Interior locking handle assembly (A) with rose 1 - Exterior handle (B) with rose 1 - Strike (C) 05700033 4 - #5x5/8" Phillips ovalhead wood screws (handle) 2 - #8x5/8" panhead wood screws (strike)		11100301
	Thimble Head Bolt receiver	BS	02540664
	Head or Foot Bolt, Solid Brass <i>Includes:</i> 1 - Bolt assembly		00143068
	#6 x 1 1/2" Phillips Flat Head Screws For combination Head or Foot bolt		11806012
	6 9/16" Sill Strike Foot Bolt receiver - specify prep. for combination	BG	05700031
	Stationary Panel Bracket <i>Includes:</i> 1 - Stationary panel bracket 4 - #7x3/4" Phillips flathead wood screws		11841000

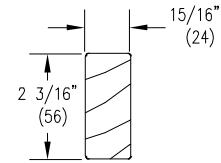
COMBINATION DOOR PARTS

ILLUSTRATION NOT TO SCALE	DESCRIPTION	OPER./CO LOR	PART NO.
	Keeper, Storm Insert Ultimate Inswing French Door 1993 – Present Inswing French Door 5/98 – Present <i>Includes:</i> 1 – SS keeper		00143062
	Drip Cap, Storm Insert Ultimate Inswing French Door 1993 – Present Inswing French Door 5/98 – Present V795 Specify Length	BG BK	15646068 15646069
	Leaf Spring, Screen Insert Ultimate Inswing French Door 1993 – Present Inswing French Door 5/98 – Present		11868835
	Finger Pull, Screen Insert Ultimate Inswing French Door 1993 – Present Inswing French Door 5/98 – Present V254	Clear	11860350

**ORDERING REPLACEMENT WOOD OR VINYL PARTS 02/28/2011 – PRESENT
 ULTIMATE INSWING FRENCH DOOR 02/28/2011 TO PRESENT**

WOOD PARTS

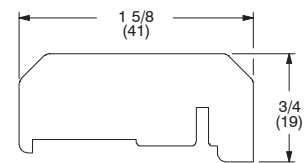
Description	Profile Number
Astragal	W7528
Mull Extender 6 9/16" door with Stationary panel and Combination	W11284



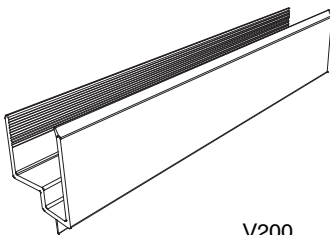
W11284

VINYL PARTS

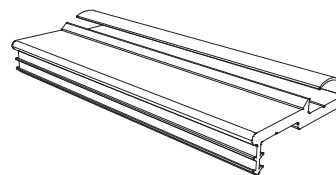
Description	Profile Number
Astragal Base/Weather Strip – Beige	V822
Bottom Rail Filler	V200



W7528



V200
 * Ultimate Doors from 5/98



V822

TO ORDER REPLACEMENT PARTS

When ordering replacement combination wood or vinyl parts specify:

1. profile number;
2. length;
3. handing;
 - a. on jamb filler specify right or left jamb (viewed from exterior)
4. finish.


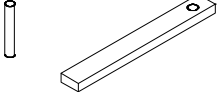

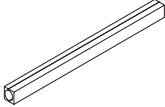



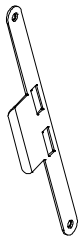
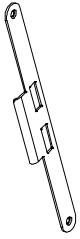

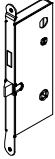
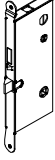
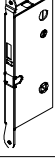
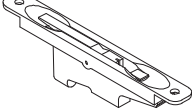
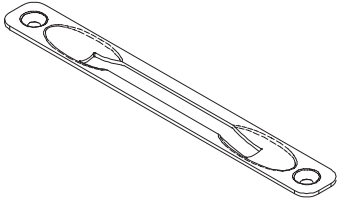
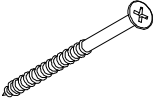
ILLUSTRATION NOT TO SCALE	DESCRIPTION	OPER./COLOR	PART NO.
	Lug seals		00142046
	Actuator with Rol-Pin <i>9/25/00 - Present</i>		05570548
	#10-32 x 2 1/8" Phillips ovalhead machine screw	Satin Taupe Antique Brass White Satin Chrome Oil Rubbed Bronze ORBZ PVD Brass PVD Satin Nickel PVD Dark Bronze	11800616 00143038 00143036 10840031 10840032 11800160 11800615 11801020 11800654
	Spindle Kit (Ashland) <i>Includes:</i> <i>1 - 2 pc. spindle, 4 3/8"</i> <i>2 - Set screws</i>		18900392
	Spindle Kit (Truth) <i>For ORBZ handle sets produced after March 2009.</i> <i>Includes:</i> <i>1 - 2 piece spindle, 4 3/8"</i> <i>2 - Set screws</i>	ORBZ	02100942
	Key Cylinder, Lock (Schlage "C" keyway) For service replacement only.	Brass Face Chrome Face	00142000 00142001
	Set Screw for Handle Assembly See Spindle kit		NA

ILLUSTRATION NOT TO SCALE	DESCRIPTION	OPER./COLOR	PART NO.
	<p>Strike Plate, Jamb-Mortise Lock or Multi-Point Lock 5/10/99 – Present (Amerock) Includes: 1 – Jamb strike plate 2 – #8x1" Brass Phillips flathead wood screws*</p>	<p>Stainless Steel Antique Brass ORBZ PVD Brass PVD</p>	<p>05700300 05700301 05700302 10148177</p>
	<p>Strike Plate, Inactive Panel-Mortise Lock or Multi-Point Lock 5/10/99 – Present (Amerock) Includes: 1 – Jamb strike plate 2 – #8x1" Brass Phillips flathead wood screws*</p>	<p>Stainless Steel Antique Brass ORBZ PVD Brass PVD</p>	<p>05700303 05700304 05700305 10148178</p>
	<p>Cover Plate, Active Mortise Lock or Multi-Point Lock 5/10/99 – Present (Amerock) Includes: 1 – Cover plate 2 – #8x1" Phillips flat head wood screws*</p>	<p>Stainless Steel Antique Brass ORBZ PVD Brass PVD</p>	<p>05700306 05700307 05700308 10148179</p>

* Stainless Steel – 11800645, Dark Bronze – 11800652, PVD Brass – 11800536

NOTE: Dark Bronze screws are used with Antique Brass and Oil Rubbed Bronze.

ILLUSTRATION NOT TO SCALE	DESCRIPTION	OPER./COL OR	PART NO.
	Mortise Lock, Active Single Point (latch and dead bolt only) <i>1/17/00 – Present (Amerock)</i>		05700129
	Mortise Lock, Active Multi-Point Lock (latch, dead bolt and head/foot shoot bolts) <i>5/10/99 – Present (Amerock)</i>		05700130
	Mortise Lock, Inactive Panel Multi-Point Lock (head/foot shoot bolts) <i>5/10/99 – Present (Amerock)</i>		05700131
	Head or Foot Flush Bolt – Inactive Panel	Black	11101780
	Cover Plate for Flush Bolt <i>Includes:</i> 1 – Cover plate 2 – #8 x 1" Screws	Aluminum	11860402
	Long Hinge Screw Package <i>Includes:</i> 4 – #10 X 2 1/2" Screws 1 – 5/32" Allen wrench <i>NOTE: Order Dark Bronze screw package for Dark Bronze, Antique Brass and Oil Rubbed Bronze Hinges. Order Stainless Steel screw package for Silver Frost, Satin Chrome and Satin Nickel PVD Hinges .</i>	TP GT DKBZ WH SS BS PVD	11800653 11800632 11800644 11800637 11800639 10148185

PARTS

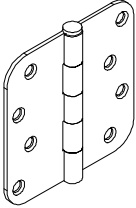
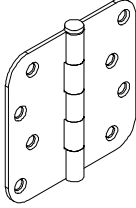
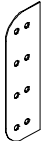
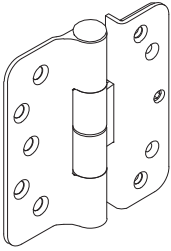
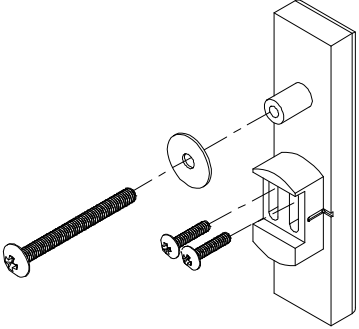
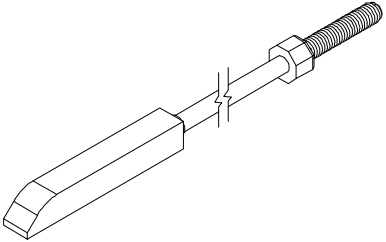
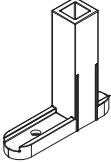
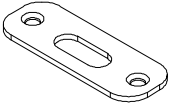
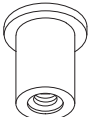
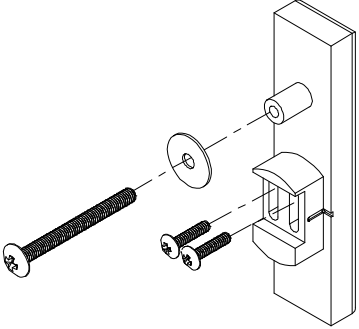
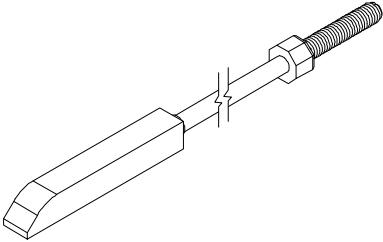
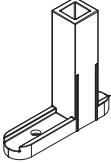
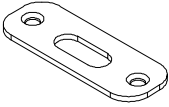

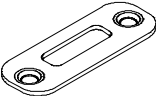
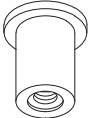
ILLUSTRATION NOT TO SCALE	DESCRIPTION	HINGE KIT COLOR/PART NO.	INDIVIDUAL SCREW COLOR/PART NO.																																										
	<p>4" Butt Hinge Kit Includes: 1 - 4" hinge 7 - #9 x 1" Phillips flathead wood screws 1 - #10 x 2 1/2" Phillips flathead wood screw (frame)</p>	<table border="0"> <tr><td>TP</td><td>02101133</td></tr> <tr><td>BP</td><td>02101134</td></tr> <tr><td>AB</td><td>02101135</td></tr> <tr><td>WH</td><td>02101136</td></tr> <tr><td>SC</td><td>02101137</td></tr> <tr><td>ORBZ</td><td>02101138</td></tr> <tr><td>SN</td><td>02101139</td></tr> </table>	TP	02101133	BP	02101134	AB	02101135	WH	02101136	SC	02101137	ORBZ	02101138	SN	02101139	<p style="text-align: center;"><u>1 inch</u></p> <table border="0"> <tr><td>TP</td><td>11868808</td></tr> <tr><td>BP</td><td>11808355</td></tr> <tr><td>DKBZ</td><td>11213832</td></tr> <tr><td>WH</td><td>11808359</td></tr> <tr><td>SS</td><td>11213828</td></tr> <tr><td>DKBZ</td><td>11213832</td></tr> <tr><td>SS</td><td>11213828</td></tr> </table> <p style="text-align: center;"><u>2 1/2 inch</u></p> <table border="0"> <tr><td>TP</td><td>11800683</td></tr> <tr><td>BSPVD</td><td>11800679</td></tr> <tr><td>DKBZ</td><td>11800680</td></tr> <tr><td>WH</td><td>11800682</td></tr> <tr><td>SS</td><td>11800684</td></tr> <tr><td>DKBZ</td><td>11800680</td></tr> <tr><td>SS</td><td>11800684</td></tr> </table>	TP	11868808	BP	11808355	DKBZ	11213832	WH	11808359	SS	11213828	DKBZ	11213832	SS	11213828	TP	11800683	BSPVD	11800679	DKBZ	11800680	WH	11800682	SS	11800684	DKBZ	11800680	SS	11800684
		TP	02101133																																										
BP	02101134																																												
AB	02101135																																												
WH	02101136																																												
SC	02101137																																												
ORBZ	02101138																																												
SN	02101139																																												
TP	11868808																																												
BP	11808355																																												
DKBZ	11213832																																												
WH	11808359																																												
SS	11213828																																												
DKBZ	11213832																																												
SS	11213828																																												
TP	11800683																																												
BSPVD	11800679																																												
DKBZ	11800680																																												
WH	11800682																																												
SS	11800684																																												
DKBZ	11800680																																												
SS	11800684																																												
	<p>4" Butt Hinge NRP = Non Removable Pin Includes: 1 - 4" hinge 7 - #9 x 1" Phillips flathead wood screws 1 - #10 x 2 1/2" Phillips flathead wood screw (frame)</p>	<table border="0"> <tr><td>NRP</td><td></td></tr> <tr><td>SBS</td><td>02101140</td></tr> </table>	NRP		SBS	02101140	<table border="0"> <tr><td>#9x1"</td><td>11213824</td></tr> <tr><td>#10x2 1/2"</td><td>11800679</td></tr> </table>	#9x1"	11213824	#10x2 1/2"	11800679																																		
NRP																																													
SBS	02101140																																												
#9x1"	11213824																																												
#10x2 1/2"	11800679																																												
	<p>4" Butt Hinge Shim</p>	<p style="text-align: center;">10500222</p>																																											

ILLUSTRATION NOT TO SCALE	DESCRIPTION			
	<p>Adjustable Hinge Kit Includes: 1 – Adjustable hinge 1 – #10x2 1/2" Phillips flathead wood screws (jamb) 5 – #10x1" Phillips flathead wood screws 4 – #8x1 1/2" Phillips flathead wood screws</p> <p>NOTE: Hinge part number includes the color matched screws. If you need to order the screws separately, they are listed below aligned with the corresponding hinge color.</p>			
SCREW DESCRIPTION	HINGE KIT COLOR/HANDING/PART NO.		INDIVIDUAL SCREW COLOR/PART NO.	
		LH	RH	
<p>#10x2 1/2" Phillips flathead wood screws (jamb). Quantity of one needed per hinge.</p>	TP GT SF DKBZ* DKBZ AB WH SC ORBZ ORBZ PVD BS PVD SN PVD	NA** NA** NA** NA** NA** NA** NA** NA** NA** NA** NA** NA** NA**	NA** NA** NA** NA** NA** NA** NA** NA** NA** NA** NA** NA** NA**	TP 11800683 GT 11800681 SS 11800684 DKBZ 11800680 DKBZ 11800680 DKBZ 11800680 WH 11800682 SS 11800684 DKBZ 11800680 DKBZ 11800680 BS PVD 11800679 SS 11800684
<p>#10x1" Phillips flathead wood screws. Quantity of five needed per hinge.</p>	TP GT SF DKBZ* DKBZ AB WH SC ORBZ ORBZ PVD BS PVD SN PVD	NA** NA** NA** NA** NA** NA** NA** NA** NA** NA** NA** NA** NA**	NA** NA** NA** NA** NA** NA** NA** NA** NA** NA** NA** NA** NA**	TP 05580145 GT 11800606 SS 11800605 DKBZ 02050526 DKBZ 02050526 DKBZ 02050526 WH 11800603 SS 11800605 DKBZ 02050526 DKBZ 02050526 BS PVD 11800600 SS 11800605
<p>#8x1 1/2" Phillips flathead wood screws. Quantity of four needed per hinge.</p>	TP GT SF DKBZ* DKBZ AB WH SC ORBZ ORBZ PVD BS PVD SN PVD	NA** NA** NA** NA** NA** NA** NA** NA** NA** NA** NA** NA** NA**	NA** NA** NA** NA** NA** NA** NA** NA** NA** NA** NA** NA** NA**	TP 11865177 GT 11865172 SS 11865175 DKBZ 02058013 DKBZ 02058013 DBZ 02058013 WH 11865173 SS 11865175 DKBZ 02058013 DKBZ 02058013 BS PVD 11865176 SS 11865175

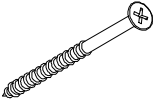
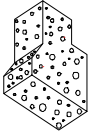
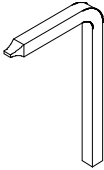
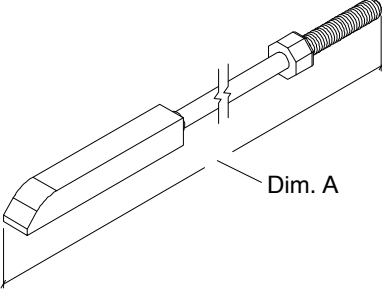
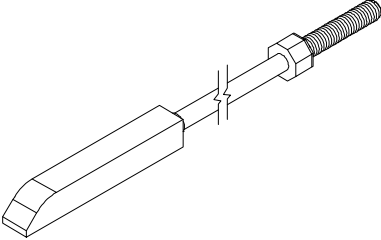
* Used prior to April, 2010
** Contact your Marvin representative.

ILLUSTRATION NOT TO SCALE	DESCRIPTION	OPER./COLOR	PART NO.														
	<p>Construction Lock Assembly For Marvin residential swinging and sliding doors with standard locks. <i>Includes:</i> 1 - Construction Lock Cover 1 - Construction Lock Hole Cover 1 - Washer 2 - #6-32 X 5/8" Phillips TH screws 1 - #10-32 X 2" Phillips TH screw</p>	<p>Each 25/Box</p>	<p>18450200 18450198</p>														
	<p>Inactive Panel Locking Rod Assembly, Top or Bottom Flush Bolt <i>5/10/99 - Present</i> <i>Includes:</i> 1 - Locking rod with end bolt NOTE: For 8-0 ht order top locking rod 05700185.</p> <table border="0"> <tr> <td>Height</td> <td>Top Locking Rod Length</td> </tr> <tr> <td>CN 6-6 ht*</td> <td>11"</td> </tr> <tr> <td>CN 6-8 ht</td> <td>11"</td> </tr> <tr> <td>CN 7-0 ht</td> <td>11"</td> </tr> <tr> <td>CN 8-0 ht</td> <td>27"</td> </tr> <tr> <td>Height</td> <td>Bottom Locking Rod Length</td> </tr> <tr> <td>All heights</td> <td>11"</td> </tr> </table>	Height	Top Locking Rod Length	CN 6-6 ht*	11"	CN 6-8 ht	11"	CN 7-0 ht	11"	CN 8-0 ht	27"	Height	Bottom Locking Rod Length	All heights	11"	<p>Stainless Steel</p>	<p>05700180 05700180 05700180 05700185 05700180</p>
Height	Top Locking Rod Length																
CN 6-6 ht*	11"																
CN 6-8 ht	11"																
CN 7-0 ht	11"																
CN 8-0 ht	27"																
Height	Bottom Locking Rod Length																
All heights	11"																
	<p>End Bolt Guide <i>Includes:</i> 1 - End Bolt guide 1 - #8x1 1/2" Phillips panhead wood screw (11865159)</p>		<p>10815199</p>														
	<p>Strike Plate, Head Jamb <i>Includes:</i> 1 - Strike plate 2 - #8x 1/2" Phillips flathead machine screws (sill)</p>	<p>Stainless Steel</p>	<p>05700320</p>														
	<p>Well-Nut Threaded Insert</p>	<p>Black</p>	<p>10830008</p>														

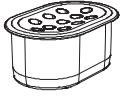


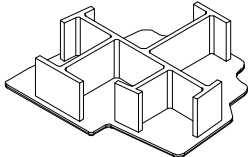
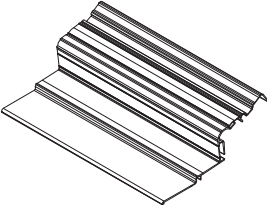
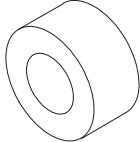

* Can be used for obsolete 6-5 height.

ILLUSTRATION NOT TO SCALE	DESCRIPTION	OPER./COLOR	PART NO.														
	<p>Construction Lock Assembly For Marvin residential swinging and sliding doors with standard locks. <i>Includes:</i> 1 - Construction Lock Cover 1 - Construction Lock Hole Cover 1 - Washer 2 - #6-32 X 5/8" Phillips TH screws 1 - #10-32 X 2" Phillips TH screw</p>	<p>Each 25/Box</p>	<p>18450200 18450198</p>														
	<p>Inactive Panel Locking Rod Assembly, Top or Bottom Flush Bolt <i>5/10/99 - Present</i> <i>Includes:</i> 1 - Locking rod with end bolt NOTE: For 8-0 ht order top locking rod 05700185.</p> <table border="0"> <tr> <td>Height</td> <td>Top Locking Rod Length</td> </tr> <tr> <td>CN 6-6 ht*</td> <td>11"</td> </tr> <tr> <td>CN 6-8 ht</td> <td>11"</td> </tr> <tr> <td>CN 7-0 ht</td> <td>11"</td> </tr> <tr> <td>CN 8-0 ht</td> <td>27"</td> </tr> <tr> <td>Height</td> <td>Bottom Locking Rod Length</td> </tr> <tr> <td>All heights</td> <td>11"</td> </tr> </table>	Height	Top Locking Rod Length	CN 6-6 ht*	11"	CN 6-8 ht	11"	CN 7-0 ht	11"	CN 8-0 ht	27"	Height	Bottom Locking Rod Length	All heights	11"	<p>Stainless Steel</p>	<p>05700180 05700180 05700180 05700185 05700180</p>
Height	Top Locking Rod Length																
CN 6-6 ht*	11"																
CN 6-8 ht	11"																
CN 7-0 ht	11"																
CN 8-0 ht	27"																
Height	Bottom Locking Rod Length																
All heights	11"																
	<p>End Bolt Guide <i>Includes:</i> 1 - End Bolt guide 1 - #8x1 1/2" Phillips panhead wood screw (11865159)</p>		<p>10815199</p>														
	<p>Strike Plate, Head Jamb <i>Includes:</i> 1 - Strike plate 2 - #8x 1/2" Phillips flathead machine screws (sill)</p>	<p>Stainless Steel</p>	<p>05700320</p>														
	<p>Fastener, Strike Plate, Sill #8x1/2" machine screws - 2 needed</p>	<p>Stainless Steel</p>	<p>11800847</p>														
	<p>Strike Plate, Sill <i>Includes:</i> 1 - Strike plate</p>	<p>Stainless Steel</p>	<p>05700082</p>														
	<p>Well-Nut Threaded Insert</p>	<p>Black</p>	<p>10830008</p>														

* Can be used for obsolete 6-5 height.

ILLUSTRATION NOT TO SCALE	DESCRIPTION	OPER./COLOR	PART NO.										
	<p>Installation Screw Package; Strike Plate(s) at head jamb, sill, or locking jamb</p> <p>#8 x 2 1/2" Flathead wood screw</p> <p>Package of 2 Package of 2 Package of 2</p>	<p>Stainless Steel Brass PVD Antique Brass</p>	<p>11882349 11882343 11882347</p>										
	<p>Sill Plug Mull Casing at Sill</p>		<p>10500260</p>										
	<p>Construction Handle</p>		<p>05700133</p>										
	<p>Locking Rod Assembly, Top for Multi-Point</p> <p><i>3/02 - Present (Amerock) 8-0 Height see History</i> <i>5/10/90 - Present (Amerock) 6-5, 6-8, & 7-0 Height</i> Solid stainless steel rod with 1/4" - 20 threads NOTE: For special heights give dimension A.</p> <table border="1"> <thead> <tr> <th>Height</th> <th>Top Locking Rod Length</th> </tr> </thead> <tbody> <tr> <td>CN 6-6 ht</td> <td>35 7/16"</td> </tr> <tr> <td>CN 6-8 ht</td> <td>37 15/16"</td> </tr> <tr> <td>CN 7-0 ht</td> <td>41 15/16"</td> </tr> <tr> <td>CN 8-0 ht</td> <td>51 7/16"</td> </tr> </tbody> </table>	Height	Top Locking Rod Length	CN 6-6 ht	35 7/16"	CN 6-8 ht	37 15/16"	CN 7-0 ht	41 15/16"	CN 8-0 ht	51 7/16"	<p>Stainless Steel</p>	<p>05700174 05700176 05700177 05700179</p>
Height	Top Locking Rod Length												
CN 6-6 ht	35 7/16"												
CN 6-8 ht	37 15/16"												
CN 7-0 ht	41 15/16"												
CN 8-0 ht	51 7/16"												
	<p>Locking Rod Assembly, Bottom for Multi-Point Lock</p> <p><i>5/10/99 - Present (Amerock)</i> Solid stainless steel rod with 1/4" - 20 threads</p> <table border="1"> <thead> <tr> <th>Height</th> <th>Bottom Locking Rod Length</th> </tr> </thead> <tbody> <tr> <td>CN 6-6 ht*</td> <td>34 9/32"</td> </tr> <tr> <td>CN 6-8 ht</td> <td>34 9/32"</td> </tr> <tr> <td>CN 7-0 ht</td> <td>34 9/32"</td> </tr> <tr> <td>CN 8-0 ht</td> <td>34 9/32"</td> </tr> </tbody> </table>	Height	Bottom Locking Rod Length	CN 6-6 ht*	34 9/32"	CN 6-8 ht	34 9/32"	CN 7-0 ht	34 9/32"	CN 8-0 ht	34 9/32"	<p>Stainless Steel</p>	<p>05700170</p>
Height	Bottom Locking Rod Length												
CN 6-6 ht*	34 9/32"												
CN 6-8 ht	34 9/32"												
CN 7-0 ht	34 9/32"												
CN 8-0 ht	34 9/32"												

* Can be used for obsolete 6-5 height.

ILLUSTRATION NOT TO SCALE	DESCRIPTION	SIZE/COLOR	PART NO.
	Drain Plug, Sill	BG BZ	10500253 10500249
	Drain Plug, Sill <i>Used before 5/98</i>	NA Oak Tone	Replace with 10500253
	Head Jamb Spacer Tack; Stationary Panel		11860424
	Jamb Spacer Tack; Stationary Panel 3/4" Diameter Head (replaced 7/16 diameter head)		11860423
	Clad Astragal End Plug <i>(Clad Doors Only)</i>	LH BG RH BG LH BZ RH BZ	10500255 10500254 10500267 10500266
	Threshold Protector 30" length	Each Pkg 20	11869675 11869676
	3/4" Handle Extension Requires 3/4" Spindle Extension	TP WH BS AB ORBZ ORBZ PVD SC SN PC DK BZ	10830048 10830054 10830050 10830052 10833038 10830012 10830036 10833037 10830056 10833039
	3/8" Handle Extension Requires 3/8" Spindle Extension	TP WH BS AB ORBZ ORBZ PVD SC SN PC DK BZ	10830049 N/A N/A N/A 10830039 10830011 N/A N/A N/A 10833040
	3/4" Spindle Extension 3/8" Spindle Extension	5 13/16" 5 1/16"	00142051 18900393

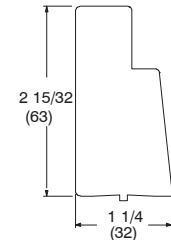
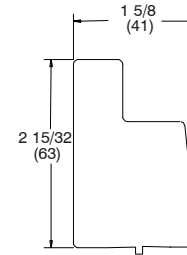
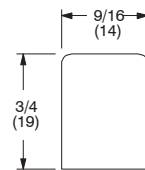
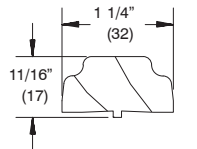
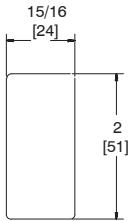
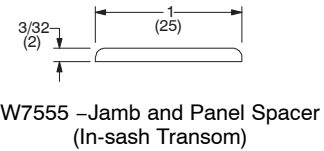
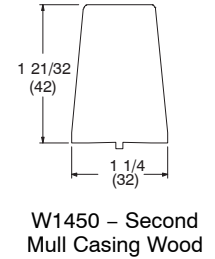
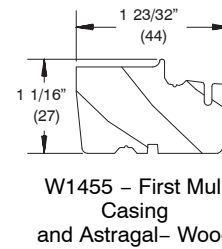
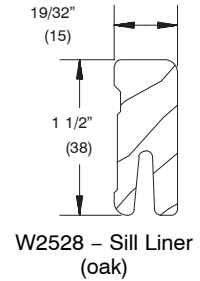
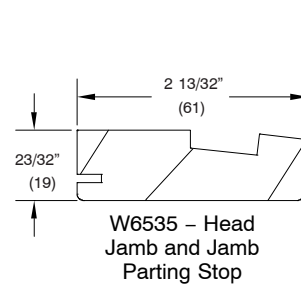
REPLACEMENT WOOD PARTS

Built around you.®

CURRENT REPLACEMENT WOOD PARTS

	Wood	Clad
Head Jamb and Jamb Parting Stop	W6535	---
Sill Liner (oak)	W2528	W2528
Sill Liner	W8661	W8661
First Mull Casing and Astragal	W1455	---
Second Mull Casing (4 9/16" Jamb)	W1450	---
Mull Extender 6 9/16" Door with stat. panel and comb.	W7033	---
Astragal Cover and Transom Mull Cover	W7554	---
Mull Filler (Spline)	W1080	W1080
Sliding Screen Mull Casing (4 9/16" Jamb)	W1452	---
Hinged Screen Mull Casing	W1075	---
Interior Cover (In-sash Transom)	W7527	W7527
Sill Filler (In-sash Transom)	W7526	W7526
Head Jamb Spacer Block (In-sash Transom)	W6064	W6064
Jamb and Panel Spacer (In-sash Transom)	W7555	W7555
Exterior Part Stop – Transom – Pre June 24, 2013	W8474	
Sill Nosing – Transom – Pre June 24, 2013	W8653	
Sill Nosing – Transom – June 24, 2013 – present	W12032	
Sill Nosing – Transom (with total R.O. continuous casing)	W12031	

NOTE: Replacement wood parts are supplied with connecting barb (where applicable).



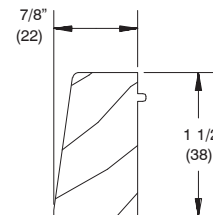
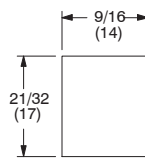
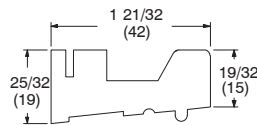
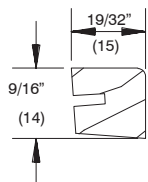
W7033 – Mull Extender 6 9/16" Door with Stationary Panel and Combination

W7554 – Astragal Cover and Transom Mull Cover – Wood

W1080 – Mull Filler (Spline)

W1075 – Hinged Screen Mull Casing

W1452 – Sliding Screen Mull Casing (4 9/16" Jamb) – Wood



W7527 – Interior Cover (In-sash Transom)

W7526 – Sill Filler (In-sash Transom)

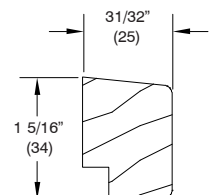
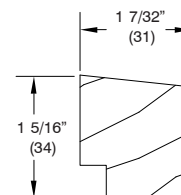
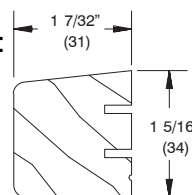
W6064 – Head Jamb Space Block (In-sash Transom)

W8474 – Exterior Part Stop

TO ORDER REPLACEMENT WOOD PARTS

When ordering replacement wood parts specify:

1. profile number;
2. rough opening;
3. handing;
 - a. on jamb parting stop specify right or left jamb (viewed from exterior)
4. length;
5. finish.



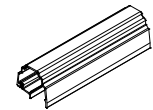
ORDERING REPLACEMENT VINYL, ALUMINUM OR FIBERGLASS PARTS FOR THE ULTIMATE INSWING FRENCH DOOR

Please reference the Aluminum Chapter (located online only) for select and standard color part numbers.

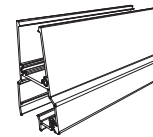
	Wood	Clad
Astragal Base	---	A771
Astragal Cladding	---	A772
Mullion Casing	---	A773
Mullion Casing Cover	---	A775
Mullion Casing Cover with Sliding Screen Stop	---	A776
Mull Cap Swinging Screen	---	A340
Head Jamb, Jamb Parting Stop	---	A836
Panel Drip (In-Sash Transom) – Beige or Black	V800	V800
Sliding Screen Guide Bar – Beige	V805	V805
Stationary Panel Sill Spacer – Beige or Black	V941	V941
Sliding Screen Astragal	A645	A645
Hydro-Optimizer – Beige or Bronze	A1251	A1251
Sliding Screen Track	A777	A777
Panel Drip – Beige or Black	V940	V940
Transom Mulling Clip (Wood)	A850/F2010	---
Ultrex Sill, 4 9/16" Jamb – Beige or Bronze	F256/F2010	F256/F2010
Ultrex Sill, 6 9/16" Jamb – Beige or Bronze	F257/F2011	F257/F2011



A771 – Astragal Base



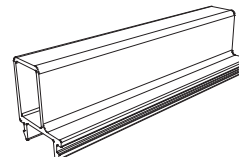
A772 – Astragal Cladding



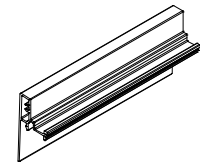
A773 – Mullion Casing,



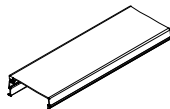
A775 – Mullion Casing Cover



A776 – Mullion Casing Cover with Sliding Screen Stop



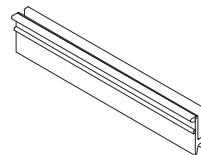
A340 – Mull Cap Swinging Screen



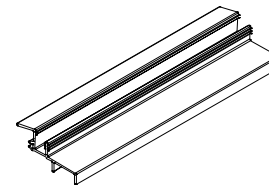
A836 – Head Jamb, Jamb Parting Stop



V800 – Panel Drip



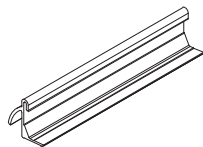
V805 – Sliding Screen Guide Bar



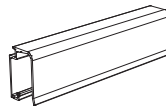
V941 – Stationary Panel Drip/Sill Spacer



A645 – Sliding Screen Astragal



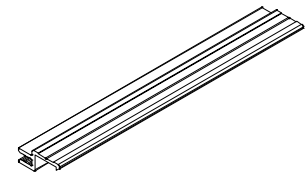
A1251 – Hydro-Optimizer



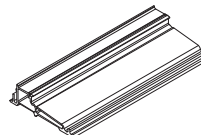
A777 – Sliding Screen Track



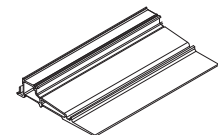
V940 – Panel Drip



A850 – Wood Transom Mulling Clip



F256/F2010 – Ultrex Sill, 4 9/16" Jamb



F257/F2011 – Ultrex Sill, 6 9/16" Jamb

TO ORDER REPLACEMENT PARTS

When ordering replacement parts specify:

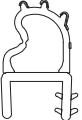
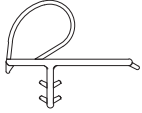

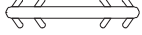

1. profile number;
2. rough opening;
3. length;
4. handing;
5. finish.

WEATHER STRIP

INSWING FRENCH DOOR WEATHER STRIP
ULTIMATE INSWING FRENCH DOOR 1993 – PRESENT
INSWING FRENCH DOOR 1998 – 2005

When ordering replacement weather strip specify:

1. quantity;
2. length;
3. part number;
4. description.

ILLUSTRATION <i>NOT TO SCALE</i>	DESCRIPTION	LENGTH	OPER./COLOR	PART NUMBER
	Flex-Bulb Weather Strip, Sill V794	87 9/16" 164 3/4" 164 3/4"	BG BG BK	15180276 15180798 15180799
	Offset Bulb Weather Strip, Parting Stop, Frame, Mull Casing, Transom and Astragal V796	41 1/4" 92 7/8" 92 7/8" 164 13/16"	BG BG BK BG	15171136 15170082 15170083 15172140
	Dust Block, Pile Jamb or Panel Adhesive backed 1" x 1/8" x 3/4"		GY	19061221
	Connecting Barb V803 NOTE: Color may vary depending on current stock. Wood Door and Wood and Clad Transom only	Specify Length		15812999
	Inactive Panel Stile Center V780	150" 150"	BG BK	15174099 15174098

ORDERING ENERGY PANELS FOR SINGLE GLAZED WOOD ULTIMATE INSWING FRENCH DOOR

If you are replacing an existing energy panel, determine the outside measurement of the existing energy panel. Find the sizes that correspond to the width and height indicated on the following chart. Energy panels are available for the single glazed Wood Ultimate Inswing French Doors. Aluminum surrounds are available in bronze, white, brown, pebble gray or evergreen.

When ordering energy panels specify:

1. size; If there is no existing EP from which to obtain the OM of the panel, determine the size of the EP by using the conversion chart below. The daylight opening is the measurement of the visible glass.
2. color of surround;
3. glass type;

Single Glazed Wood Ultimate Inswing Wood Inswing French Doors manufactured 5/98 – 2005 Daylight Opening to OM of EP				
Daylight Width + 1 3/8" = OM Width of EP Daylight Height + 1 3/8" = OM Height of EP				
WIDTH			HEIGHT	
SIZE	(ht.)	OM-WIDTH	SIZE	OM-HEIGHT
CN 1-6	(6-5 ht.)	12 7/8"	CN 6-5	64 1/4"
CN 2-6	(6-5 ht.)	19 15/32"		
CN 3-0	(6-5 ht.)	25 15/32"		
CN 1-6	(6-6 ht.)	12 7/8"	CN 6-6	65"
CN 2-6	(6-6 ht.)	20 5/32"		
CN 3-0	(6-6 ht.)	26 5/32"		
CN 1-6		12 7/8"	CN 6-8	67 1/2"
CN 2-0		14 31/32"	CN 7-0	71 1/2"
CN 2-6		20 31/32"	CN 8-0	81"
CN 2-8		22 31/32"		
CN 3-0		26 31/32"		
CN 3-6		32 31/32"		

ENERGY PANEL PARTS

Energy panels are attached with turn buttons. Turn button styles may vary depending on current stock. You will receive the most current style in the color of your choice.

When ordering energy panels parts specify:

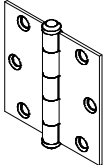
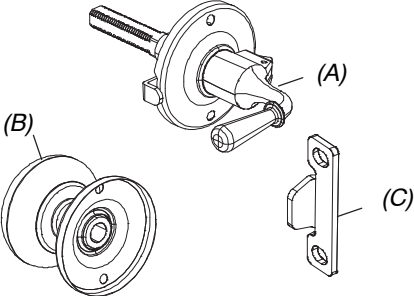
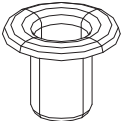
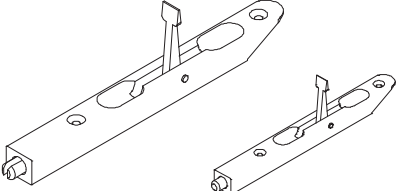

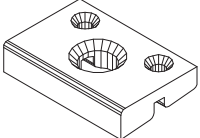
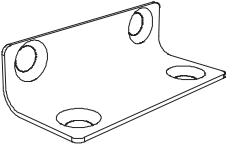
1. quantity;
2. description;
3. color;
4. part number.

ILLUSTRATION <i>NOT TO SCALE</i>	DESCRIPTION	COLOR	PART NUMBER	
	<p>Turn Button Packages of 50 include #8x3/4" SS full thread screws (11808340).</p> <p>If ordering by "each", screws must be ordered separately.</p>	SW CL PB BZ BN	<u>Each</u> 11869294 11869309 11869292 11869291 11869293	<u>Pkg of 50</u> 11869314 11869315 11869312 11869311 11869313

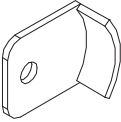
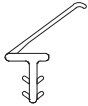

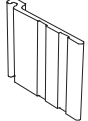
**WOOD ULTIMATE INSWING FRENCH DOOR COMBINATION DOOR PARTS 1993 – PRESENT
WOOD INSWING FRENCH DOOR 5/98 – 2005**

When ordering replacement combination parts specify:

1. part number;
2. quantity;
3. description.

ILLUSTRATION NOT TO SCALE	DESCRIPTION	OPER./CO LOR	PART NO.
	Hinge, Solid Brass <i>Includes:</i> 1 – Butt hinge, 3" x 3" 6 – #8x3/4" Phillips flathead wood screws		02100547
	Handle Package, Solid Brass Ultimate Inswing French Door 1993 – Present Inswing French Door 5/98 – Present <i>Includes:</i> 1 – Interior locking handle assembly (A) with rose 1 – Exterior handle (B) with rose 1 – Strike (C) 05700033 4 – #5x5/8" Phillips ovalhead wood screws (handle) 2 – #8x5/8" panhead wood screws (strike)		11100301
	Thimble Head Bolt receiver	BS	02540664
	Head or Foot Bolt, Solid Brass <i>Includes:</i> 1 – Bolt assembly		00143068
	#6 x 1 1/2" Phillips Flat Head Screws For combination Head or Foot Bolt		11806012
	6 9/16" Sill Strike Foot Bolt receiver – specify prep. for combination	BG	05700031
	Stationary Panel Bracket <i>Includes:</i> 1 – Stationary panel bracket 4 – #7x3/4" Phillips flathead wood screws		11841000

COMBINATION DOOR PARTS

ILLUSTRATION NOT TO SCALE	DESCRIPTION	OPER./CO LOR	PART NO.
	Keeper, Storm Insert Ultimate Inswing French Door 1993 – Present Inswing French Door 5/98 – Present <i>Includes:</i> 1 – SS keeper		00143062
	Drip Cap, Storm Insert Ultimate Inswing French Door 1993 – Present Inswing French Door 5/98 – Present V795 Specify Length	BG BK	15646068 15646069
	Leaf Spring, Screen Insert Ultimate Inswing French Door 1993 – Present Inswing French Door 5/98 – Present		11868835
	Finger Pull, Screen Insert Ultimate Inswing French Door 1993 – Present Inswing French Door 5/98 – Present V254	Clear	11860350

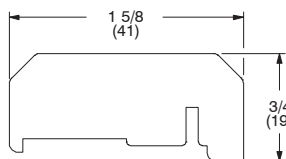
ORDERING REPLACEMENT WOOD OR VINYL PARTS FOR THE INSWING COMBINATION DOOR 1993 – PRESENT ULTIMATE INSWING FRENCH DOOR 5/98 – 2005

WOOD PARTS

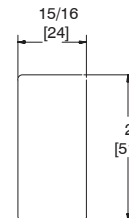
	Profile Number
Astragal	W7528
Mull Extender 6 9/16" door with Stat. panel and Comb.	W7033

VINYL PARTS

	Profile Number
Astragal Base/Weather Strip – Beige	V822
Bottom Rail Filler	V200

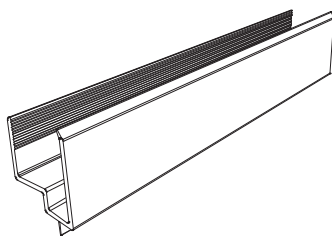


W7528 – Astragal

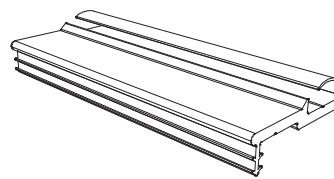


W7033 – Mull Extender
6 9/16" Door with Stationary
Panel and Combination*

* Ultimate Doors from 5/98.



V200 – Bottom Rail Filler
* Ultimate Doors from 5/98



V822 – Astragal Base/Weather Strip

TO ORDER REPLACEMENT PARTS

When ordering replacement combination wood or vinyl parts specify:

1. profile number;
2. length;
3. handing;
 - a. on jamb filler specify right or left jamb (viewed from exterior)
4. finish.

OBSOLETE – PARTS

When ordering replacement Inswing French Door parts specify:

1. type of unit, part number, description.

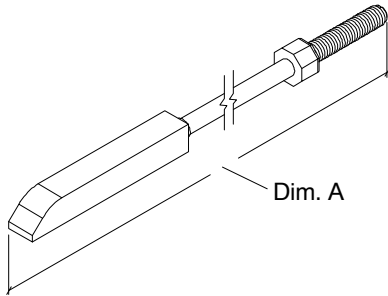
ILLUSTRATION <i>NOT TO SCALE</i>	DESCRIPTION				
	<p>Hinge, Adjustable USAGE: Pre-2012 <i>Includes:</i> 1 - Adjustable hinge 1 - #10x2 1/2" Phillips flathead wood screws (jamb) 5 - #10x1" Phillips flathead wood screws 4 - #8x1 1/2" Phillips flathead wood screws</p> <p>NOTE: Hinge part number includes the color matched screws. If you need to order the screws separately, they are listed below aligned with the corresponding hinge color.</p>				
SCREW DESCRIPTION	HINGE COLOR/PART NO.			SCREW COLOR/PART NO.	
		LH	RH		
#10x2 1/2" Phillips flathead wood screws (jamb). Quantity of one needed per hinge.	TP	NA**	NA**	TP	11800683
	GT	NA**	NA**	GT	11800681
	SF	NA**	NA**	SS	11800684
	DKBZ*	NA**	NA**	DKBZ	11800680
	DKBZ	NA**	NA**	DKBZ	11800680
	AB	NA**	NA**	DKBZ	11800680
	WH	NA**	NA**	WH	11800682
	SC	NA**	NA**	SS	11800684
	ORBZ	NA**	NA**	DKBZ	11800680
	ORBZ PVD	NA**	NA**	DKBZ	11800680
	BS PVD	NA**	NA**	BS PVD	11800679
	SN PVD	NA**	NA**	SS	11800684
#10x1" Phillips flathead wood screws. Quantity of 5 needed per hinge.	TP	NA**	NA**	TP	05580145
	GT	NA**	NA**	GT	11800606
	SF	NA**	NA**	SS	11800605
	DKBZ*	NA**	NA**	DKBZ	02050526
	DKBZ	NA**	NA**	DKBZ	02050526
	AB	NA**	NA**	DKBZ	02050526
	WH	NA**	NA**	WH	11800603
	SC	NA**	NA**	SS	11800605
	ORBZ	NA**	NA**	DKBZ	02050526
	ORBZ PVD	NA**	NA**	DKBZ	02050526
	BS PVD	NA**	NA**	BS PVD	11800600
	SN PVD	NA**	NA**	SS	11800605
#8x1 1/2" Phillips flathead wood screws (panel). Quantity of four needed per hinge.	TP	NA**	NA**	TP	11865177
	GT	NA**	NA**	GT	11865172
	SF	NA**	NA**	SS	11865175
	DKBZ*	NA**	NA**	DKBZ	02058013
	DKBZ	NA**	NA**	DKBZ	02058013
	AB	NA**	NA**	DKBZ	02058013
	WH	NA**	NA**	WH	11865173
	SC	NA**	NA**	SS	11865175
	ORBZ	NA**	NA**	DKBZ	02058013
	ORBZ PVD	NA**	NA**	DKBZ	02058013
	BS PVD	NA**	NA**	BS PVD	11865176
	SN PVD	NA**	NA**	SS	11865175

* Used prior to April, 2010

** Contact your Marvin representative.







OBSOLETE – PARTS

ILLUSTRATION NOT TO SCALE	DESCRIPTION	OPER./COLOR	PART NO.
	<p>Hinge, Adjustable <i>Includes:</i> 1 – Adjustable hinge 1 – #10x2 1/2" Phillips flathead wood screws (jamb) 4 – #10x1" Phillips flathead wood screws (jamb) or 5 – #10x1" Phillips flathead wood screws (stationary stile) 4 – #8x1 1/2" Phillips flathead wood screws (panel) 1 – 5/32" Allen wrench (adjustment)</p>	PC	<p>Right Hand 02101116</p>
			<p>Left Hand 02101115</p>
	<p>Left Hand Hinge Replacement Package 2000–2005 Right Hand Hinge Replacement Package 2000–2005 To update a door that utilized Phillips head adjustment screw style adjustable hinges. NOTE: Will not convert a butt hinge door to adjustable hinges. 6-5 and 6-8 door panels require 3 hinges per panel. 7-0 and 8-0 door panels require 4 hinges per panel.</p>	<p>3 Hinges or 4 Hinges Gold Tone Solid Brass Antique Brass Polished Chrome Brushed Chrome White</p>	<p>NA Use pre-2012 hinge <i>Note: The current adjustable hinge kit may also be used. If using the current hinge, all hinges on the panel must be changed.</i></p>
	<p>Hinge, Adjustable, Left Hand <i>Ultimate Inswing French Door 1993 – 1996</i></p>	Sun Gold Brushed Chrome	NA
	<p>Hinge, Adjustable, Right Hand <i>Ultimate Inswing French Door 1993 – 1996</i></p>	Sun Gold Brushed Chrome	NA
	<p>Hinge, Adjustable, Left Hand IFD and UIFD 1996–2005</p>	Satin Taupe Gold Tone Silver Frost Dark Bronze White Polished Chrome	NA Use hinge Pre-HD II on previous page.
	<p>Hinge, Adjustable, Right Hand IFD and UIFD 1996–2005</p>	Satin Taupe Gold Tone Silver Frost Dark Bronze White Polished Chrome	NA Use hinge Pre-HD II on previous page.

ILLUSTRATION NOT TO SCALE	DESCRIPTION																														
	<p>Inactive Panel Locking Rod, Top or Bottom For Head or Foot Bolt <i>IFD – std. UIFD – std. 1997* – 5/10/99</i> Solid stainless steel rod with 1/4" – 20 threads Includes: 1 – Locking rod (includes shoot bolt)</p> <table border="0"> <thead> <tr> <th>Height</th> <th>Top Locking Rod Length</th> <th></th> </tr> </thead> <tbody> <tr> <td>CN 6–5 ht</td> <td>9 11/16"</td> <td>Replace with PN 05700180</td> </tr> <tr> <td>CN 6–8 ht</td> <td>9 11/16"</td> <td>Replace with PN 05700180</td> </tr> <tr> <td>CN 7–0 ht</td> <td>9 11/16"</td> <td>Replace with PN 05700180</td> </tr> <tr> <td>CN 8–0 ht</td> <td>27 1/32"</td> <td>Replace with PN 05700185</td> </tr> </tbody> </table> <table border="0"> <thead> <tr> <th>Height</th> <th>Bottom Locking Rod Length</th> <th></th> </tr> </thead> <tbody> <tr> <td>CN 6–5 ht</td> <td>9 11/16"</td> <td>Replace with PN 05700180</td> </tr> <tr> <td>CN 6–8 ht</td> <td>9 11/16"</td> <td>Replace with PN 05700180</td> </tr> <tr> <td>CN 7–0 ht</td> <td>9 11/16"</td> <td>Replace with PN 05700180</td> </tr> <tr> <td>CN 8–0 ht</td> <td>9 11/16"</td> <td>Replace with PN 05700180</td> </tr> </tbody> </table>	Height	Top Locking Rod Length		CN 6–5 ht	9 11/16"	Replace with PN 05700180	CN 6–8 ht	9 11/16"	Replace with PN 05700180	CN 7–0 ht	9 11/16"	Replace with PN 05700180	CN 8–0 ht	27 1/32"	Replace with PN 05700185	Height	Bottom Locking Rod Length		CN 6–5 ht	9 11/16"	Replace with PN 05700180	CN 6–8 ht	9 11/16"	Replace with PN 05700180	CN 7–0 ht	9 11/16"	Replace with PN 05700180	CN 8–0 ht	9 11/16"	Replace with PN 05700180
	Height	Top Locking Rod Length																													
	CN 6–5 ht	9 11/16"	Replace with PN 05700180																												
	CN 6–8 ht	9 11/16"	Replace with PN 05700180																												
CN 7–0 ht	9 11/16"	Replace with PN 05700180																													
CN 8–0 ht	27 1/32"	Replace with PN 05700185																													
Height	Bottom Locking Rod Length																														
CN 6–5 ht	9 11/16"	Replace with PN 05700180																													
CN 6–8 ht	9 11/16"	Replace with PN 05700180																													
CN 7–0 ht	9 11/16"	Replace with PN 05700180																													
CN 8–0 ht	9 11/16"	Replace with PN 05700180																													
<p>Locking Rod, Top for Multi-Point <i>IFD – opt.* UIFD – std. 1997* – 5/10/99 (Trimco)</i> Solid stainless steel rod with 1/4" – 20 threads 1 – Locking rod (includes shoot bolt)</p> <table border="0"> <thead> <tr> <th>Height</th> <th>Top Locking Rod Length</th> <th></th> </tr> </thead> <tbody> <tr> <td>CN 6–5 ht</td> <td>35 3/4"</td> <td rowspan="4">These parts may be fabricated using PN 05700190</td> </tr> <tr> <td>CN 6–8 ht</td> <td>39 1/32"</td> </tr> <tr> <td>CN 7–0 ht</td> <td>43 1/32"</td> </tr> <tr> <td>CN 8–0 ht</td> <td>55 1/32"</td> </tr> </tbody> </table>	Height	Top Locking Rod Length		CN 6–5 ht	35 3/4"	These parts may be fabricated using PN 05700190	CN 6–8 ht	39 1/32"	CN 7–0 ht	43 1/32"	CN 8–0 ht	55 1/32"																			
Height	Top Locking Rod Length																														
CN 6–5 ht	35 3/4"	These parts may be fabricated using PN 05700190																													
CN 6–8 ht	39 1/32"																														
CN 7–0 ht	43 1/32"																														
CN 8–0 ht	55 1/32"																														
<p>Locking Rod, Bottom for Multi-Point Lock <i>IFD – opt.* UIFD – std. 1997* – 5/10/99 (Trimco)</i> Solid stainless steel rod with 1/4" – 20 threads 1 – Locking rod (includes shoot bolt)</p> <table border="0"> <thead> <tr> <th>Height</th> <th>Bottom Locking Rod Length</th> <th></th> </tr> </thead> <tbody> <tr> <td>CN 6–5 ht</td> <td>33 15/16"</td> <td>Replace with PN 05700190</td> </tr> <tr> <td>CN 6–8 ht</td> <td></td> <td></td> </tr> <tr> <td>CN 7–0 ht</td> <td></td> <td></td> </tr> <tr> <td>CN 8–0 ht</td> <td></td> <td></td> </tr> </tbody> </table>	Height	Bottom Locking Rod Length		CN 6–5 ht	33 15/16"	Replace with PN 05700190	CN 6–8 ht			CN 7–0 ht			CN 8–0 ht																		
Height	Bottom Locking Rod Length																														
CN 6–5 ht	33 15/16"	Replace with PN 05700190																													
CN 6–8 ht																															
CN 7–0 ht																															
CN 8–0 ht																															




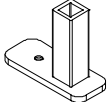
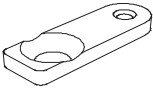
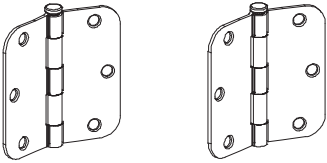
* See product history for details.

OBSOLETE – PARTS

ILLUSTRATION NOT TO SCALE	DESCRIPTION	OPER./COLOR	PART NO.
	End Bolt Locking Rod, Head/Foot Bolt and Multi-Point Lock <i>1997* – 5/10/99</i> With 1/4" – 20 threads	SS	10815189 (Check for availability)
	Strike Plate, Jamb Multi-Point Lock <i>IFD – opt.* UIFD – std.</i> <i>Used before 5/10/99 (Trimco)</i>		NA
	Strike Plate, Inactive Panel Multi-Point Lock <i>IFD – opt.* UIFD – std.</i> <i>Used before 5/10/99 (Trimco)</i>		NA
	Cover Plate, Active Multi-Point Lock <i>IFD – opt.* UIFD – std.</i> <i>Used before 5/10/99 (Trimco)</i>		NA
	Mortise Lock, Active Multi-Point Lock <i>IFD – opt.* UIFD – std.</i> <i>Used before 5/10/99 (Trimco)</i> 1/4" – 20 threads for locking rods		NA
	Mortise Lock, Inactive Multi-Point Lock <i>IFD – opt. UIFD – opt.</i> <i>Used before 5/10/99 (Trimco)</i> 1/4" – 20 threads for locking rods		NA

* See product history for details.

OBSOLETE – PARTS

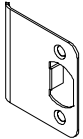
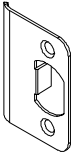
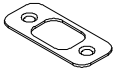


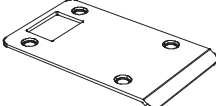
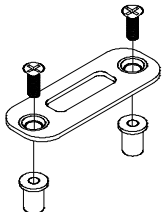
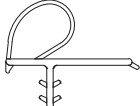
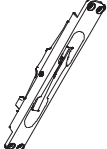
ILLUSTRATION NOT TO SCALE	DESCRIPTION	OPER./COLOR	PART NO.
	Sill Bolt Receptacle <i>Ultimate Inswing French Door 1993 – 1996</i> Wood Door only	BK	NA
	End Bolt <i>Ultimate Inswing French Door 1993 – 1997* With #10–24 threads</i>		NA
	Plug, End Bolt Guide <i>Ultimate Inswing French Door 1993 – 1997*</i>		NA
	End Bolt Guide <i>Active Panels – w/Multi-Point</i> <i>Inactive Panels All, 1997* – 1/17/00</i>		NA
	Backset Extension for Head or Foot Bolt <i>Ultimate Inswing French Door 1993 – 1997*</i> with #10–24 threads Includes: 1 – Backset extension 1 – #10–24x3/4" Phillips flathead machine screw		Check availability 16152010
	3 1/2" Hinge Pair <i>Inswing French Door 1985 – 5/98</i> <i>Inswing Terrace Door 1982 – 5/98</i>	Brass Plated Solid Brass SS	NA

OBSOLETE – PARTS

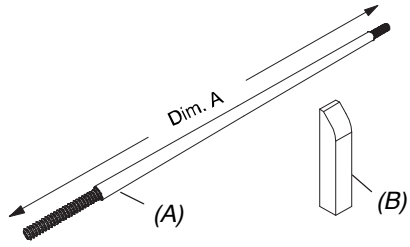
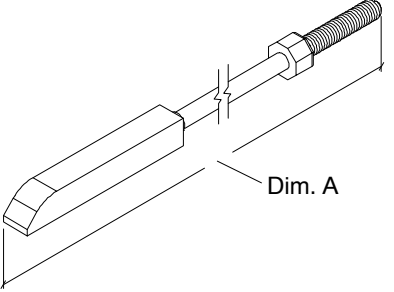
ILLUSTRATION NOT TO SCALE	DESCRIPTION	OPER./COLOR	PART NO.
	<p>Lever Set, Complete, Solid Brass <i>Used until 1/17/00</i> IFD – opt.* UIFD – n/a Schlage “C” Keyway Includes: 1 – Solid brass interior passage handle (A) 1 – Solid brass exterior passage handle (B) with spindle 1 – Passage latch assembly (C) with cover plates and 05700003 strike plate 1 – Deadbolt assembly (D) with cover plates and 05700002 strike plate 2 – Keys 1 – Installation screw package with Allan wrench and instructions</p>	<p>Solid Brass</p>	<p>Check for availability (10144000)</p>
	<p>Lever Set, Solid Brass <i>Used until 1/17/00</i> IFD – opt.* UIFD – n/a Includes: 1 – Solid brass interior passage handle (A) 1 – Solid brass exterior passage handle (B) with spindle 1 – Passage latch assembly (C) with cover plates and 05700003 strike plate 1 – Installation screw package with Allan wrench and instructions</p>	<p>Solid Brass</p>	<p>NA</p>
	<p>Lever Set, Dummy (with dummy deadbolt), Solid Brass <i>Used until 1/17/00</i> IFD – opt.* UIFD – n/a Includes: 1 – Solid brass dummy interior passage handle (A) with cover plate 1 – Solid brass dummy exterior passage handle (B) with spindle and cover plate 1 – Dummy deadbolt assembly (C) with cover plate 1 – Installation screw package with instructions</p>	<p>Solid Brass</p>	<p>NA</p>
	<p>Lever Set, Dummy, Solid Brass <i>Used until 1/17/00</i> IFD – opt.* UIFD – n/a Includes: 1 – Solid brass dummy interior passage handle (A) with cover plate 1 – Solid brass dummy exterior passage handle (B) with spindle and cover plate 1 – Installation screw package with instructions</p>	<p>Solid Brass</p>	<p>NA</p>

* to CN 7-0 height, N/A on taller doors.

OBSOLETE – PARTS

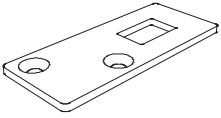
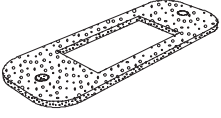
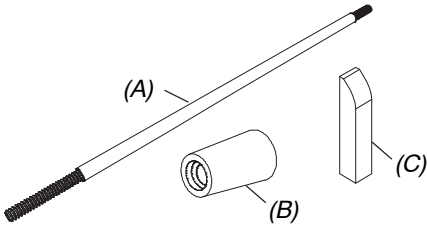
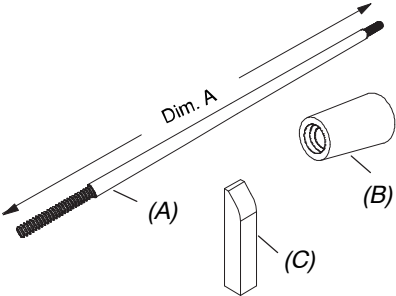



ILLUSTRATION NOT TO SCALE	DESCRIPTION	OPER./COLOR	PART NO.
	<p>Jamb Strike Plate, Lever Set <i>Used until 1/17/00</i> IFD – opt.* UIFD – n/a Includes: 1 – Strike plate 2 – #6x2" Phillips flathead wood screws</p>	Solid Brass Antique Brass Polished Chrome Brushed Chrome White	05700039 05700041 05700042 N/A N/A
	<p>Panel Strike Plate, Lever Set <i>Used until 1/17/00</i> IFD – opt.* UIFD – n/a Includes: 1 – Strike plate 2 – #6x2" Phillips flathead wood screws</p>	Solid Brass Antique Brass Polished Chrome Brushed Chrome White	05700034 (check for availability) N/A N/A N/A N/A
	<p>Receiver Plate, Deadbolt <i>Used until 1/17/00</i> IFD – opt.* UIFD – n/a</p>		N/A
	<p>Strike Plate, Lever Set, Solid Brass Inswing French Door 1985 – 5/98 Inswing Terrace Door 1982 – 5/98</p>		N/A
	<p>Strike Plate, Deadbolt, Solid Brass Inswing French Door 1985 – 5/98 Inswing Terrace Door 1982 – 5/98</p>		N/A
	<p>Strike Plate, Extended, Lever Set Inswing Terrace Door 1982 – 5/98 For door with interior jamb extension</p>	BS	N/A
	<p>Strike Plate, Sill Includes: 1 – Strike plate 2 – #8x 1/2" Phillips flathead machine screws (sill) 2 – Well-nut Threaded Insert (10830008)</p>	Stainless Steel	
	<p>Offset Bulb Weather Strip, Parting Stop, Frame, Mull Casing, Transom and Astragal – V796 1998 – March 2002</p>	189 11/16" BG	15173298
	<p>Inactive Panel Flush Bolt FD – std. UFD – std. Includes: 1 – Flush bolt 4 – #6 x 1 1/2" Phillips flathead wood screws</p>	Solid Brass Antique Brass Polished Chrome White	11101765 11101767 11101768 N/A

OBSOLETE – PARTS

ILLUSTRATION NOT TO SCALE	DESCRIPTION	OPER./COLOR	PART NO.																
	<p>Locking Rod, Top or Bottom for Head or Foot Bolt <i>Ultimate Inswing French Door 1993–1996</i> Hollow aluminum alloy rod with #10–24 threads</p> <table border="0"> <tr> <td>Height</td> <td>Top Locking Rod Length</td> </tr> <tr> <td>CN 6–5 ht</td> <td>9 11/16"</td> </tr> <tr> <td>CN 6–8 ht</td> <td>9 11/16"</td> </tr> <tr> <td>CN 8–0 ht</td> <td>25 11/16"</td> </tr> <tr> <td>Height</td> <td>Bottom Locking Rod Length</td> </tr> <tr> <td>CN 6–5 ht</td> <td>9 11/16"</td> </tr> <tr> <td>CN 6–8 ht</td> <td>9 11/16"</td> </tr> <tr> <td>CN 8–0 ht</td> <td>9 11/16"</td> </tr> </table>	Height	Top Locking Rod Length	CN 6–5 ht	9 11/16"	CN 6–8 ht	9 11/16"	CN 8–0 ht	25 11/16"	Height	Bottom Locking Rod Length	CN 6–5 ht	9 11/16"	CN 6–8 ht	9 11/16"	CN 8–0 ht	9 11/16"		NA
Height	Top Locking Rod Length																		
CN 6–5 ht	9 11/16"																		
CN 6–8 ht	9 11/16"																		
CN 8–0 ht	25 11/16"																		
Height	Bottom Locking Rod Length																		
CN 6–5 ht	9 11/16"																		
CN 6–8 ht	9 11/16"																		
CN 8–0 ht	9 11/16"																		
	<p>Locking Rod Assembly, Top for Multi-Point <i>FD – opt. UFD – std.</i> <i>5/10/99 – 3–02* (Amerock)</i> Solid stainless steel rod with 1/4" – 20 threads</p> <table border="0"> <tr> <td>Height</td> <td>Top Locking Rod Length</td> </tr> <tr> <td>CN 8–0 ht</td> <td>53 15/16"</td> </tr> </table>	Height	Top Locking Rod Length	CN 8–0 ht	53 15/16"		This part may be fabricated using PN 05700190												
Height	Top Locking Rod Length																		
CN 8–0 ht	53 15/16"																		


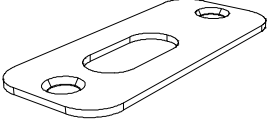
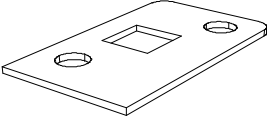
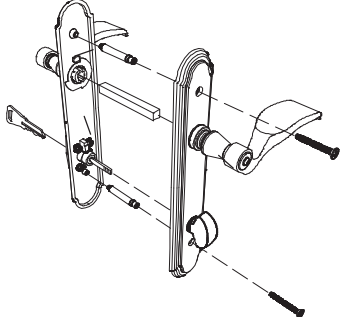
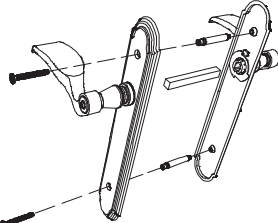
* See product history for details.

OBSOLETE – PARTS

ILLUSTRATION NOT TO SCALE	DESCRIPTION	OPER./COLOR	PART NO.								
	<p>Bolt Guide Plate, Stainless Steel <i>Ultimate Inswing French Door 1993–1997</i></p>	SS	NA								
	<p>Foam Gasket, Strike Plate <i>Ultimate Inswing French Door 1993–1996</i> 1" x 1/16" x 2 5/8" Wood Door only</p>	GY	NA								
	<p>Locking Rod, Bottom for Multi-Point <i>Ultimate Inswing French Door 1993 – 1997* (Trimco)</i> Hollow aluminum alloy rod with #10–24 threads</p> <table border="0"> <tr> <td>Height</td> <td>Bottom Locking Rod Length</td> </tr> <tr> <td>CN 6–5 ht or</td> <td>32 19/32"</td> </tr> <tr> <td>CN 6–8 ht or</td> <td></td> </tr> <tr> <td>CN 8–0 ht</td> <td></td> </tr> </table>	Height	Bottom Locking Rod Length	CN 6–5 ht or	32 19/32"	CN 6–8 ht or		CN 8–0 ht			NA
Height	Bottom Locking Rod Length										
CN 6–5 ht or	32 19/32"										
CN 6–8 ht or											
CN 8–0 ht											
	<p>Locking Rod, Top for Multi-Point <i>Ultimate Inswing French Door 1993–1997*</i> Hollow aluminum alloy rod with #10–24 threads.</p> <p>NOTE: For special heights give dimension A.</p> <table border="0"> <tr> <td>Height</td> <td>Top Locking Rod Length</td> </tr> <tr> <td>CN 6–5 ht</td> <td>34 13/32"</td> </tr> <tr> <td>CN 6–8 ht</td> <td>37 11/16"</td> </tr> <tr> <td>CN 8–0 ht</td> <td>53 11/16"</td> </tr> </table>	Height	Top Locking Rod Length	CN 6–5 ht	34 13/32"	CN 6–8 ht	37 11/16"	CN 8–0 ht	53 11/16"		NA
Height	Top Locking Rod Length										
CN 6–5 ht	34 13/32"										
CN 6–8 ht	37 11/16"										
CN 8–0 ht	53 11/16"										
	<p>Inactive Panel Flush Bolt <i>3/16" radius corners, replace with 11101767 (AB) or 11101768 (PC)</i></p>	<p>Brass Antique Brass Polished Chrome Brushed Chrome White</p>	NA								
	<p>Multi-Point Mortise Lock, Active <i>Ultimate Inswing French Door 1993–1997* (Trimco)</i> #10–24 threads for locking rods Replaced with lock, rods and end bolt used from 1997 – 5/10/99.</p>		NA								
	<p>Multi-Point Mortise Lock, Inactive <i>Ultimate Inswing French Door 1993–1997* (Trimco)</i> #10–24 threads for locking rods Replaced with lock, rods and end bolt used from 1997 – 5/10/99.</p>		NA								

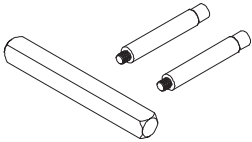
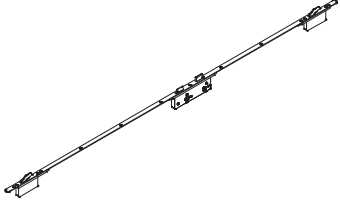
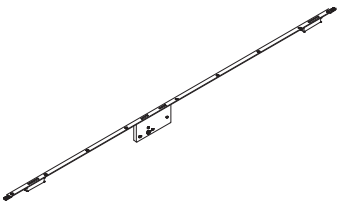
* See product history for details.

OBSOLETE – PARTS

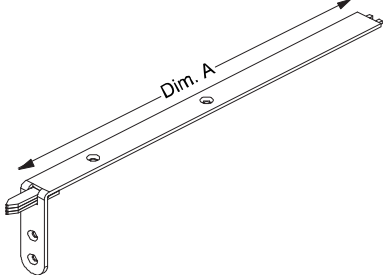
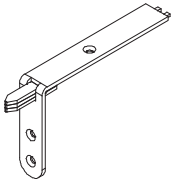
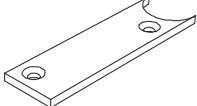
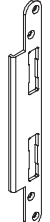
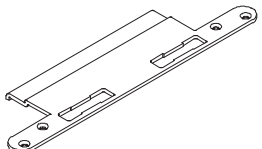
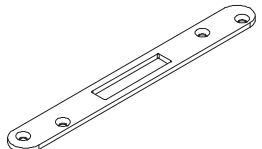
ILLUSTRATION NOT TO SCALE	DESCRIPTION	OPER./COLOR	PART NO.
	<p>End Bolt for Head/Foot Bolt <i>Inswing French Door before 5/98</i></p>		<p>NA</p>
	<p>Head or Foot bolt Strike Plate <i>Inswing French Door before 5/98</i></p>	<p>Solid Brass Polished Chrome Brushed Chrome</p>	<p>N/A N/A N/A</p>
	<p>Head or Foot bolt Guide Plate <i>Inswing French Door before 5/98</i></p>	<p>YZD</p>	<p>NA</p>
	<p>Multi-Point Handle, Active, Solid Brass (Essve) <i>Inswing French Door before 5/98</i> <i>Inswing Terrace Door 1990 – 5/98</i> (Weiser keyway)</p>	<p>Can use current handle by turning the current handle upside down.</p>	
	<p>Multi-Point Handle, Inactive, Solid Brass (Essve) <i>Inswing French Door before 5/98</i> <i>Inswing Terrace Door 1990 – 5/98</i></p>		

* See product history for details.

OBSOLETE – PARTS

ILLUSTRATION NOT TO SCALE	DESCRIPTION	OPER./COLOR	PART NO.
	<p>Spindle Package for Multi-Point Handle (Essve) <i>Inswing French Door before 5/98</i> <i>Inswing Terrace Door 1990 – 5/98</i></p>		NA
	<p>Active Multi-Point Hardware Assembly (Essve) <i>Inswing French Door before 5/98</i> <i>Inswing Terrace Door 1990 – 5/98</i></p>		NA
	<p>Inactive Multi-Point Hardware Assembly (Essve) <i>Inswing French Door before 5/98</i></p>		NA

OBSOLETE – PARTS

ILLUSTRATION NOT TO SCALE	DESCRIPTION	OPER./COLOR	PART NO.																
	<p>Multi-Point Top Corner Drive <i>Inswing French Door before 5/98</i> (Essve) For Inactive panel with multi-point <i>Includes:</i> 1 – Top corner drive Attached with #6x1/2" Phillips flathead wood screws</p> <table border="0"> <tr> <td>CN 6-8 ht.</td> <td>7 29/64"</td> <td>(189)</td> <td>N/A</td> </tr> <tr> <td>CN 7-0 ht.</td> <td>11 15/32"</td> <td>(291)</td> <td>N/A</td> </tr> <tr> <td>CN 8-0 ht.</td> <td>10 5/16"</td> <td>(262)</td> <td>NA</td> </tr> <tr> <td>CN 6-5 ht.</td> <td>3 3/4"</td> <td>(95)</td> <td>N/A</td> </tr> </table> <p>NOTE: For special heights give Dimension A.</p>	CN 6-8 ht.	7 29/64"	(189)	N/A	CN 7-0 ht.	11 15/32"	(291)	N/A	CN 8-0 ht.	10 5/16"	(262)	NA	CN 6-5 ht.	3 3/4"	(95)	N/A		
CN 6-8 ht.	7 29/64"	(189)	N/A																
CN 7-0 ht.	11 15/32"	(291)	N/A																
CN 8-0 ht.	10 5/16"	(262)	NA																
CN 6-5 ht.	3 3/4"	(95)	N/A																
	<p>Multi-Point Bottom Corner Drive <i>Inswing French Door before 5/98</i> (Essve) For Inactive panel with multi-point</p> <p>4 13/32" (112)</p>		NA																
	<p>Multi-Point Corner Drive Filler <i>Inswing French Door before 5/98</i> (Essve)</p>		NA																
	<p>Multi-Point Lock Jamb Strike, Center, Solid Brass (Essve) <i>Inswing French Door before 5/98</i> <i>Inswing Terrace Door 1990 – 5/98</i> <i>Includes:</i> 1 – Jamb strike 4 – #7 x 5/8" Phillips flathead wood screws</p>		NA																
	<p>Multi-Point Lock Jamb Strike, Center, Extended, Solid Brass (Essve) <i>Inswing French Door before 5/98</i> <i>Inswing Terrace Door 1990 – 5/98</i></p>		NA																
	<p>Multi-Point Lock Jamb Strike, Top or Bottom, Solid Brass (Essve) <i>Inswing French Door before 5/98</i> <i>Inswing Terrace Door 1990 – 5/98</i></p>		NA																

OBSOLETE – PARTS

ILLUSTRATION NOT TO SCALE	DESCRIPTION	OPER./COLOR	PART NO.
	Multi-Point Lock Strike, Inactive Panel, Head Jamb (Essve) <i>Inswing French Door before 5/98</i>		NA
	Multi-Point Lock Corner Drive Sill Receptacle, Solid Brass (Essve) <i>Inswing French Door before 5/98</i>		NA
	Sill Receptacle Gasket (Essve) <i>Inswing French Door before 5/98</i>		NA
	Astragal Strike Latch (Essve) <i>Inswing French Door before 5/98</i> Inactive panel with multi-point hardware <i>Includes:</i> 1 – Latch 2 – #7x5/8" Phillips flathead wood screws		NA
	Filler Foam, Weep/Drain <i>Ultimate Inswing French Door 1996–1998</i>		NA
	Foam Plug, Clad Part Stop <i>Ultimate Inswing French Door 1996–1998</i>		NA
	Lever Washers – Pre – 2000		NA
	Lever Spacers – Pre – 2000		NA
	Lever Shims – Pre – 2000		NA
	Dummy Lever Cams – Pre – 2000		NA
	Snap Rings – Pre – 2000		NA
	Spindle – Pre – 2000 <i>FD – opt.* UFD – std.</i> 4 3/16"		NA
	Stop clip with screws		00142016 (Check for availability)

OBSOLETE – PARTS

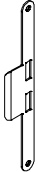
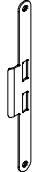
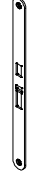
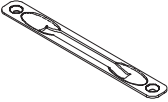
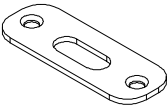
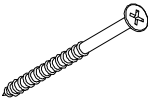
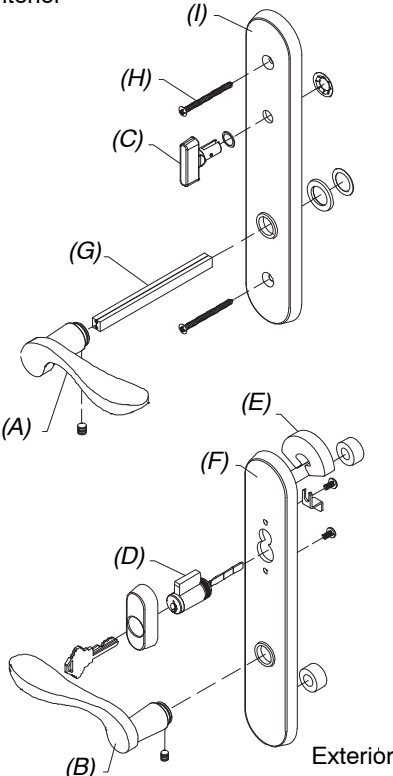
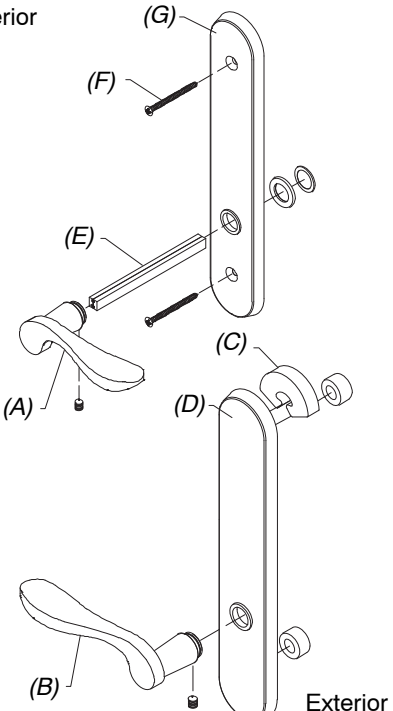

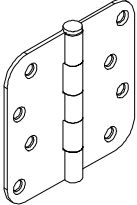
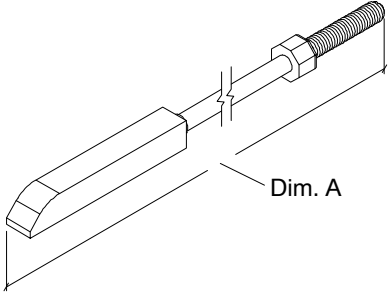
ILLUSTRATION NOT TO SCALE	DESCRIPTION	OPER./COLOR	PART NO.
	<p>Strike Plate, Jamb–Mortise Lock or Multi–Point Lock 5/10/99 – 5/03 (Amerock) Includes: 1 – Jamb strike plate 2 – #8x1" Brass Phillips flathead wood screws</p>	<p>Polished Chrome Brushed Chrome White</p>	<p>NA 05700121 N/A</p>
	<p>Strike Plate, Inactive Panel–Mortise Lock or Multi–Point Lock 5/10/99 – 5/03 (Amerock) Includes: 1 – Jamb strike plate 2 – #8x1" Brass Phillips flathead wood screws</p>	<p>Polished Chrome Brushed Chrome White</p>	<p>NA N/A N/A</p>
	<p>Cover Plate, Active Mortise Lock or Multi–Point Lock 5/10/99 – 5/03 (Amerock) Includes: 1 – Cover plate 2 – #8x1" Phillips flathead wood screws</p>	<p>Polished Chrome Brushed Chrome White</p>	<p>N/A 05700101 N/A</p>
	<p>Cover Plate for Flush Bolt Includes: 1 – Cover plate 2 – #9 x 1" Screws</p>	<p>Polished Chrome Brushed Chrome White Brass Antique Brass PVD Brass</p>	<p>N/A</p>
	<p>Strike Plate, Head Jamb Includes: 1 – Strike plate 2 – #8x1" Phillips flathead wood screws (head jamb)</p>	<p>Polished Chrome Brushed Chrome White</p>	<p>10148048 NA NA</p>
	<p>Strike Plate, Sill Includes: 1 – Strike plate 2 – #8x 1/2" Phillips flathead machine screws (sill) 2 – Well–nut #8 machine screw (sill) 10830008</p>	<p>Polished Chrome Brushed Chrome White</p>	<p>18900362 18900364 N/A</p>
	<p>Strike Plate, Head Jamb & Sill Includes: 2 – Strike plates 2 – #8x 1" Phillips flathead wood screws 2 – #8x 1 1/2" Phillips flathead machine screws</p>	<p>PVD</p>	<p>NA</p>

ILLUSTRATION NOT TO SCALE	DESCRIPTION	OPER./COLOR	PART NO.
	<p>Installation Screw Package; Strike Plate(s) at head jamb, sill, or locking jamb #8 x 2 1/2" Flathead wood screw Package of 4</p>	White	NA
<p>Interior</p>  <p>Exterior</p>	<p>Handle Assembly, Active Panel Mortise lock and Multi-point lock systems (Schlage "C" keyway) Includes: 1 - Interior lever (A) with 00142006 spindle, escutcheon plate and hardware 1 - Exterior lever (B) with escutcheon plate and hardware 1 - Thumb turn (C) with hardware 1 - Keyed cylinder (D) with housing and hardware 1 - Exterior escutcheon plate gasket (E) 1 - Exterior escutcheon plate (F) 1 - Two piece spindle (G) 2 - #10-32x2" Phillips ovalhead machine screws (H) 1 - Interior Escutcheon plate (I) 2 - Keys</p>	Polished Chrome Brushed Chrome	10148117 10148118
<p>Interior</p>  <p>Exterior</p>	<p>Handle Assembly, Inactive/Dummy Includes: 1 - Interior lever (A) with 00142006 spindle, escutcheon plate and hardware 1 - Exterior lever (B) with escutcheon plate and hardware 1 - Exterior escutcheon plate gasket (C) 1 - Exterior escutcheon plate (D) 1 - Two piece spindle (E) 2 - #10-32x2" Phillips ovalhead machine screws (F) 1 - Interior Escutcheon plate (G)</p>	Polished Chrome Brushed Chrome	10148148 10148149

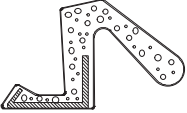
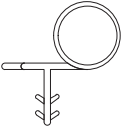
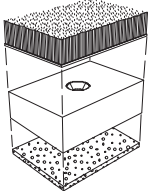

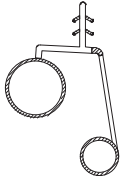
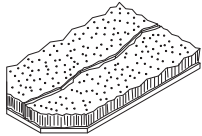
OBSOLETE – PARTS

ILLUSTRATION NOT TO SCALE	DESCRIPTION	OPER./COLOR	PART NO.				
	<p>#10-32x2" Phillips ovalhead machine screw</p>	<p>Polished Chrome</p>	<p>NA</p>				
	<p>4" Butt Hinge Includes: 1 - 4" hinge 7 - #10 x 1" Phillips flathead wood screws 1 - #10 x 2 1/2" Phillips flathead wood screw (frame)</p>	<p>Polished Chrome</p>	<p>02100483</p>				
	<p>Locking Rod Assembly, Top for Multi-Point</p> <p><i>3/02 - Present (Amerock) 8-0 Height see History</i> <i>5/10/90 - Present (Amerock) 6-5, 6-8, & 7-0 Height</i> Solid stainless steel rod with 1/4" - 20 threads NOTE: For special heights give dimension A.</p> <table border="0" data-bbox="673 989 998 1073"> <tr> <td>Height</td> <td>Top Locking Rod Length</td> </tr> <tr> <td>CN 6-5 ht</td> <td>34 11/16"</td> </tr> </table>	Height	Top Locking Rod Length	CN 6-5 ht	34 11/16"	<p>Stainless Steel</p>	<p>05700175</p>
Height	Top Locking Rod Length						
CN 6-5 ht	34 11/16"						

OBSOLETE WEATHER STRIP

INSWING FRENCH DOORS AND TERRACE DOOR WEATHER STRIP

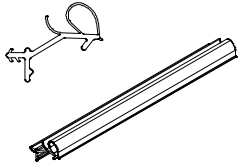
When ordering replacement weather strip specify quantity, part number, length and description.

ILLUSTRATION NOT TO SCALE	DESCRIPTION	LENGTH	PART NUMBER
	<p>Foam Weather Strip, Frame <i>Inswing French Doors 1985 to 5/98</i> <i>Inswing Terrace Door 1982 - 5/98</i> V650 Color: Beige</p>	<p>144"</p>	<p>02100972</p>
	<p>Bulb Weather Strip, Transom Bottom Rail <i>Inswing French Doors 1985 to 5/98</i> V192 Color: Beige</p>	<p>84" 95 3/4" 192"</p>	<p>N/A 15900075 15900118</p>
	<p>Sill Dust Block Assembly <i>Inswing French Doors 1985 to 5/98</i></p>		<p>NA</p>
	<p>Pile Weather Strip, Astragal <i>Inswing French Doors 1985 to 5/98</i> Adhesive backed MISC 835 1 1/2" x 3/16" x 3/4" Wood Door only</p>		<p>NA</p>
	<p>Hinged Dual Bulb Weather Strip, Operator Center Mull <i>Terrace Door 1986 - 5/98</i> V193 Color: Beige</p>	<p>78" 94" 98" 115"</p>	<p>NA NA NA 15623115</p>
	<p>Pile Weather Strip, Corner Seal <i>Inswing Terrace Door 1982 - 5/98</i> Adhesive backed Color: Gray 1 3/16" x 1/4" x 2"</p>		<p>11867804</p>

OBSOLETE WEATHER STRIP

ULTIMATE INSWING FRENCH DOOR WEATHER STRIP

When ordering replacement weather strip specify quantity, part number, length and description.

ILLUSTRATION <i>NOT TO SCALE</i>	DESCRIPTION	LENGTH	COLOR	PART NUMBER
	Horizontal Head Jamb and Head Jamb Parting Stop Weather Strip V1947	46 1/2" (1207)	BG	15192040
		46 1/2" (1207)	BK	15192041
		82 1/2" (2096)	BG	15192070
		82 1/2" (2096)	BK	15192071
		123 11/16" (3142)	BG	15192194
		123 11/16" (3142)	BK	15192195
		164 7/8" (4188)	BG	15192298
		164 7/8" (4188)	BK	15192299
	Vertical Jamb and Jamb Parting Stop Weather Strip V1947	77 15/16" (1980)	BG	15192368
		77 15/16" (1980)	BK	15192369
		81 15/16" (2081)	BG	15192370
		81 15/16" (2081)	BK	15192371
		91 7/16" (2322)	BG	15192380
		91 7/16" (2322)	BK	15192381

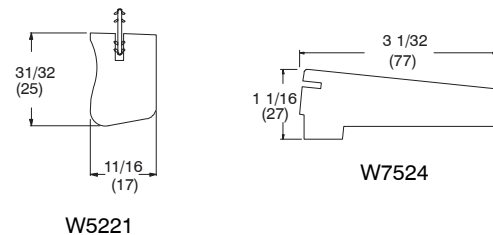
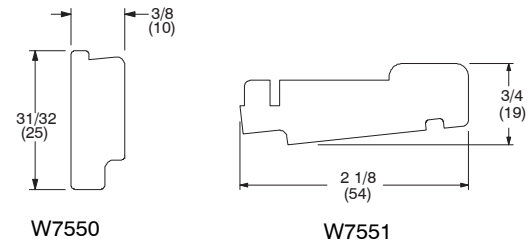
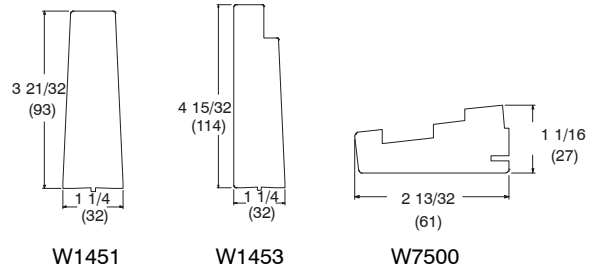
OBSOLETE REPLACEMENT WOOD PARTS

OBSOLETE REPLACEMENT WOOD PARTS

INSWING FRENCH DOOR (5/98 – 2005)

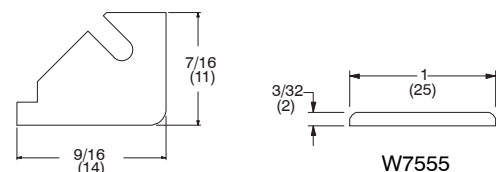
ULTIMATE INSWING FRENCH DOOR(1993 –PRESENT)

	Wood	Clad
Second Mull Casing (6 9/16" Jamb)	W1451	---
Sliding Screen Mull Casing (6 9/16" Jamb)	W1453	---
Head Jamb and Jamb Parting Stop (4 9/16" Jamb)	W7500	---
Sill Liner (oak)	W7550	W7550
Threshold (oak)	W7551	W7551
Screen Track Filler	W5221	---
Head Jamb and Jamb Parting Stop (6 9/16" Jamb)	W7524	---
Stationary Panel Cover	W7553	---
Head Jamb, Jamb and Panel Spacer	W7555	---



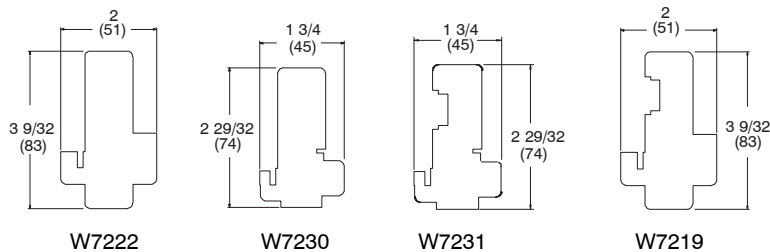
INSWING FRENCH (BEFORE 5/98)

	Wood	Clad
Astragal	W7222	W7230
Astragal (Multi-Point)	W7219	W7231
Operator First Mull Casing	W1092	---
Second Mull Casing	W1084	---
Stationary Head Jamb, Jamb and Astragal Filler	NA	---
Stationary Head Jamb and Jamb Spacer	NA	NA



INSWING TERRACE DOOR (BEFORE 5/98)

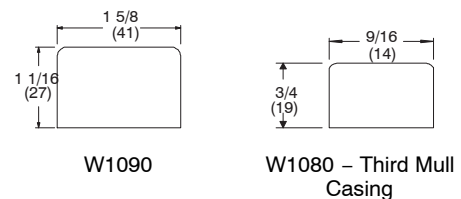
	Wood	Clad
Stationary Head Jamb and Stationary Jamb Filler	NA	NA
Stationary Head Jamb and Stationary Jamb Spacer	NA	NA
Operator First Mull Casing	W1092	---
Stationary First Mull Casing	W1090	---
Second Mull Casing	W1084	---
Third Mull Casing	W1080	---



TO ORDER REPLACEMENT WOOD PARTS

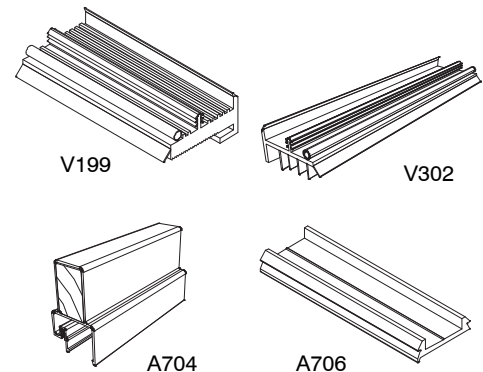
NOTE: All obsolete parts subject to availability.
When ordering replacement wood parts specify:

1. profile number;
2. call number or rough opening;
3. handing;
 - a. on jamb parting stop specify right or left jamb (viewed from exterior)
 - b. for operator first mull casing specify right or left hand (as viewed from the exterior)
 - c. for astragal specify hardware prep (if applicable)
4. length;
5. finish.
6. handing;



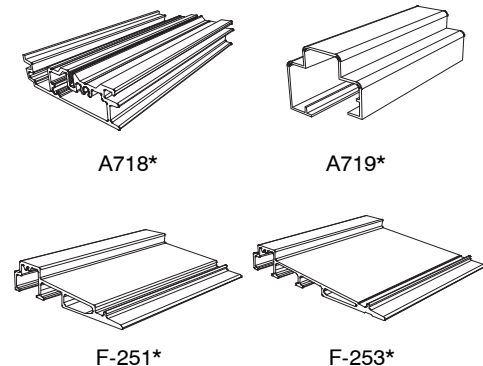
ORDERING REPLACEMENT VINYL, ALUMINUM OR FIBERGLASS PARTS FOR THE INSWING FRENCH DOOR
FRENCH INSWING (BEFORE 5/98)

	Wood	Clad
Stationary and Sidelite Leveling Block – Beige	V199	V199
Sweep – Beige	V302	V302
Operator Center Mull (with plug)	---	A704
Operator Center Mull Base	---	A706
2" Clad Frame Extension		A718*
Astragal Cladding		A719*
Ultrax Sill (4 9/16" Jamb) – Beige	F251*	F251*
Ultrax Sill (6 9/16" Jamb) – Beige	F253*	F253*

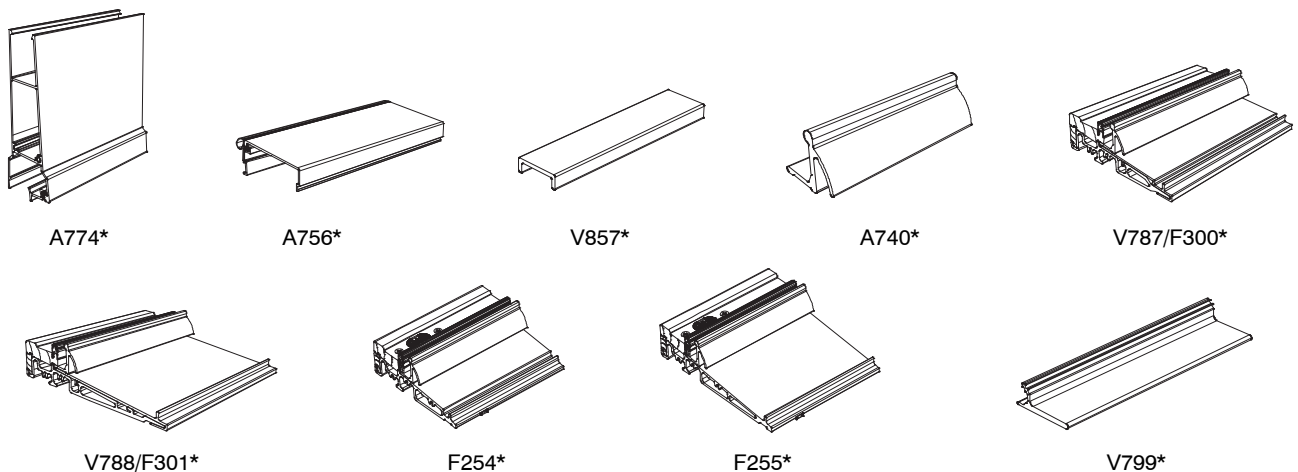


ULTIMATE INSWING FRENCH DOOR (1993 – 1998)

	Wood	Clad
Mullion Casing, 6 9/16" Jamb	---	A774*
Head Jamb, Jamb Parting Stop	---	A756*
Stationary Panel Sill Spacer	V857*	V857*
Hydro-Optimizer – Beige (replaced with A1251)	A740*	A740*
Panel Drip – Beige	F305*	F305*
Sill Cover and Ultrax Sill Core Assembly, 4 9/16" Jamb Beige (includes Hydro-Optimizer, threshold and sill liner)	V787/F300*	---
Sill Cover and Ultrax Sill Core Assembly 6 9/16" Jamb Beige (includes Hydro-Optimizer, threshold and sill liner)	V788/F301*	---
Ultrax Sill, 4 9/16" Jamb (includes Hydro-Optimizer, panel spacer tack, threshold, sill liner and weather strip)	---	F254*
Ultrax Sill, 6 9/16" Jamb (includes Hydro-Optimizer, panel spacer tack, threshold, sill liner and weather strip)	---	F255*
Stationary Panel Fastener	V799*	---
Screen Track	A641*	---



* No longer available (shaded).

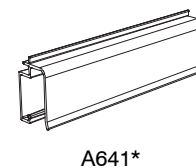


TO ORDER REPLACEMENT PARTS

NOTE: All obsolete parts subject to availability.

When ordering replacement parts specify:

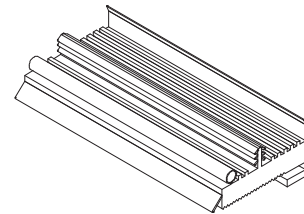
1. profile number;
2. size (call number or rough opening);
3. length;
4. handing;
5. finish.



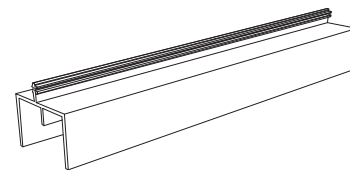
**OBSOLETE REPLACEMENT VINYL, ALUMINUM OR FIBERGLASS PARTS FOR
 THE INSWING TERRACE DOOR MANUFACTURED 1982 – 5/98
 INSWING TERRACE DOOR (1982 – 1998)**

	Clad	Wood
Stationary and Sidelite Leveling Block	V199	V199
Screen Channel (V253 no longer available in Brown)	---	V253 (PB)
	---	V310
Sweep	V302	V302
Operator Center Mull (with plug)	A704	---
Operator Center Mull and Screen Mull Base	A706	---
Operator Screen Mull (with plug)	A705*	---
Stationary Center Mull (with plug)	A707*	---
Stationary Center Mull Base	A708*	---
Sill Overlay	A702*	A702*
Ultrex Sill – Beige	F251*	F251*

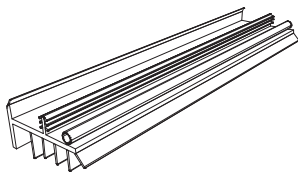
* No longer available (shaded).



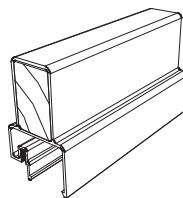
V199 – Stationary and Sidelite Leveling Block



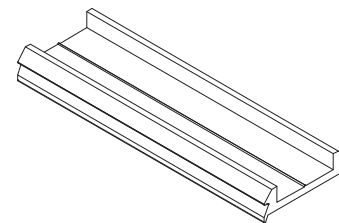
V253 – Screen Channel – (Brown* or Pebble Gray)
 V310 – Screen Channel – (White)



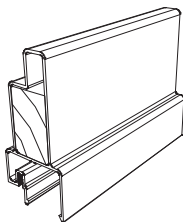
V302 – Sweep



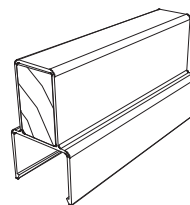
A704 – Operator Center Mull (with plug)



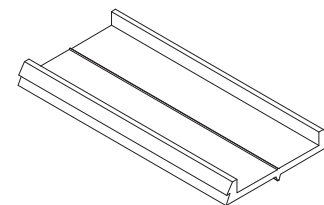
A706 – Operator Center Mull and Screen Mull Base



A705 – Operator Screen Mull (with plug)*



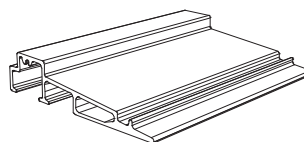
A707 – Stationary Center Mull (with plug)*



A708 – Stationary Center Mull Base*



A702 – Sill Overlay*



F251 – Ultrex Sill*

TO ORDER REPLACEMENT PARTS

NOTE: All obsolete parts subject to availability.

When ordering replacement parts specify:

1. profile number;
2. size (call number or rough opening);
3. length;
4. handing;
5. finish.

OBSOLETE PANEL REPLACEMENT

ORDERING REPLACEMENT PANELS FOR THE OBSOLETE WOOD AND CLAD INSWING FRENCH DOOR (MANUFACTURED BEFORE 5/98)

To order replacement panels specify:

1. size (call number or OM of panel);
2. active, inactive or stationary;
 - a. specify bore or no bore
3. handing;
4. glazing;
5. finish.
6. panel style

Note: Clad French Door started eased edge design March 4, 1996 and Wood French Door started eased edge design April 15, 1996.

CLAD AND WOOD FRENCH DOOR (PRE 1998)

CN	Panel OSM		Panel DLO	
	Width	Height	Width	Height
2068 / 4068	24"	80"	14 1/2"	67 1/8"
2668 / 5068	30"	80"	20 1/2"	67 1/8"
2868 / 5668	32"	80"	22 1/2"	67 1/8"
3068 / 6068	36"	80"	26 1/2"	67 1/8"
2665	27 5/8"	76 5/16"	18 1/2"	63 7/16"
3065	33 5/8"	76 5/16"	24 1/8"	63 7/16"
7/0 Height		84"		67 1/8"
8/0 Height		96"		80 7/8"

Units will have:

4 3/4" top rail and stile. Bottom rail height: 6/5 and 6/8 = 8 1/8"; 7/0 = 12 1/8"; and 8/0 = 10 3/8".
3 1/2" x 3 1/2" butt hinges. 6/5, 6/8, 7/0 heights will have 4 hinges. 8/0 height will have 5 hinges.



**Wood Inswing
Active Panel
Exterior View**



**Clad Inswing
Active Panel
Exterior View**

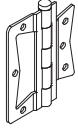
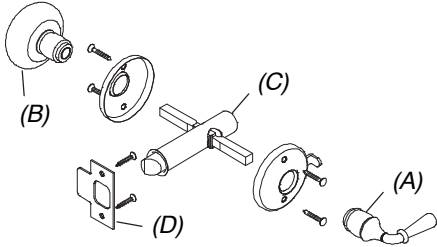
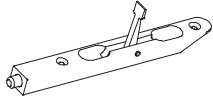
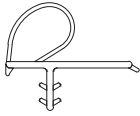
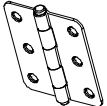
Active panels include: sweep and route for hinges.

Inactive panels include: sweep, route for hinges, astragal and head and foot bolts.

Stationary panels include: leveling block.

OBSOLETE COMBINATION DOOR PARTS**OBSOLETE WOOD INSWING FRENCH COMBINATION DOOR PARTS 1991 – 5/98**

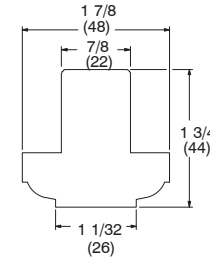
When ordering replacement combination parts specify quantity, part number and description.

ILLUSTRATION NOT TO SCALE	DESCRIPTION	OPER./CO LOR	PART NO.
	Surface Mount Hinge, Solid Brass		NA
	Handle Package, Solid Brass Inswing French Door 1991 – 1998 Inswing Terrace Door 1991 – 1998 <i>Includes:</i> 1 – Interior handle (A) with locking rose 1 – Exterior handle (B) with rose 1 – Latch bolt assembly (C) 1 – Strike (D) 4 – #6x3/4" Phillips ovalhead wood screws (handle) 2 – #4x3/4" Phillips ovalhead wood screws (strike)		02550630
	Headbolt, Solid Brass		NA Replace with 00143068
	Bulb Weather Strip, Bottom Rail Ultimate Inswing French Door 1993 – 98 V796 23 3/32" 29 3/32" 35 3/32" 41 3/32"	BG	15171120 15171126 15171130 15171136
	Hinge, Solid Brass		NA

**ORDERING REPLACEMENT WOOD, VINYL OR ALUMINUM PARTS FOR
THE WOOD INSWING AND FRENCH DOOR MANUFACTURED 1991 – 5/98
ULTIMATE INSWING FRENCH DOOR 1993 – 5/98**

WOOD PARTS

	Profile Number
Astragal	W7210
Jamb Filler – 6 9/16" jambs (with adhesive tape)	W7531*
Stationary Panel Spacer	W7530*
Operating Panel Spacer	W7529*
Stationary Panel Head Jamb Spacer	W6126*
Mull Filler	W6248*

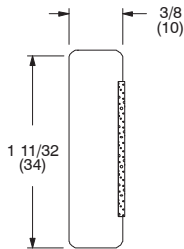


W7210 – Astragal

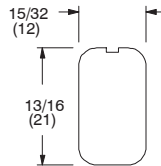
ALUMINUM PARTS

Wood Ultimate Inswing French Door Rectangular Panels	Profile Number
Drip Cap	A102*

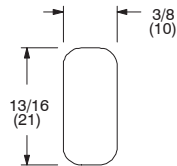
* No longer available (shaded).



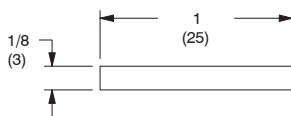
W7531 – Jamb Filler – 6 9/16" jambs (with adhesive tape)*



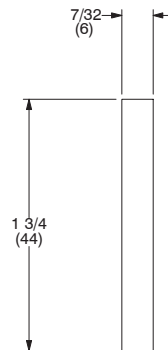
W7530 – Stationary Panel Spacer*



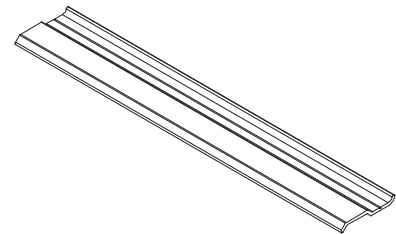
W7529 – Operating Panel Spacer*



W6126 – Stationary Panel Head Jamb Spacer*



W6248 – Mull Filler*



A102 – Drip Cap*

TO ORDER REPLACEMENT PARTS

When ordering replacement combination door wood, vinyl or aluminum parts specify:

1. profile number;
2. size (call number or rough opening);
3. length;
4. finish.

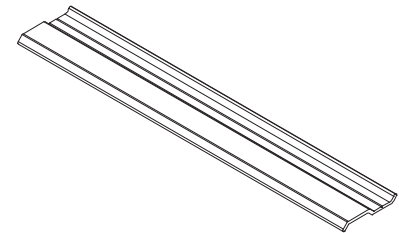
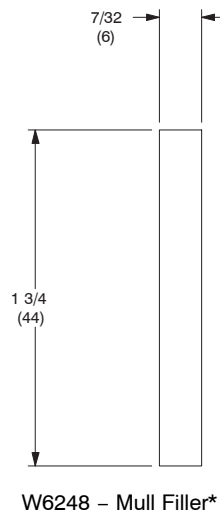
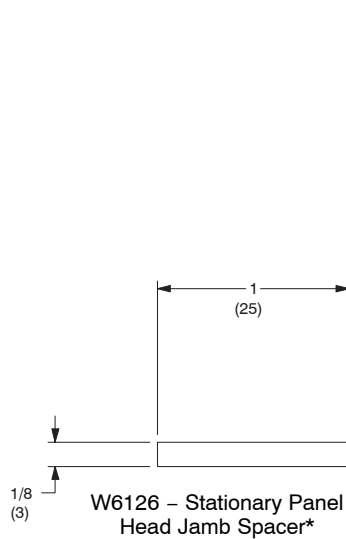
**ORDERING REPLACEMENT WOOD, VINYL OR ALUMINUM PARTS FOR
THE WOOD TERRACE COMBINATION DOOR MANUFACTURED 1982 – 5/98****WOOD PARTS**

	Profile Number
Stationary Panel Head Jamb Spacer	W6126*
Mull Filler	W6248*

ALUMINUM PARTS

	Profile Number
Drip Cap	A102*

* No longer available (shaded).



A102 - Drip Cap*

TO ORDER REPLACEMENT PARTS

When ordering replacement combination wood, vinyl or aluminum parts specify:

1. profile number;
2. size (call number or rough opening);
3. length;
4. finish.