

OWNER'S MANUAL

Painting, Staining, Care and Maintenance

MARVIN 

Table of Contents

Introduction	2
How to Use this Manual	2
Warranty	2
Windows	3
Window Part Identification	3
Window Styles	4
Ultimate Casement and Ultimate Awning	5
Ultimate Push Out Casement Ultimate Push Out Awning	6
Ultimate French Casement	7
Ultimate Push Out French Casement	7
Ultimate Venting Picture	7
Ultimate Glider	8
Wood Ultimate Double Hung	10
Ultimate Double Hung Magnum	11
Ultimate Double Hung Next Generation	12
Magnum Tilt-Turn	14
Magnum Hopper and Magnum Inswing Casement	14
Round Top, Polygon and Direct Glaze	14
Window Options	15
Modern Casement and Awning Crank-out	16
Modern Casement and Awning Push-out	17
Modern - Direct Glaze	18
Doors	19
Swinging Doors	21
Sliding Doors	23
Scenic Doors - Ultimate Lift and Slide Door	25
Scenic Doors - Clad Ultimate Multi-Slide Door	25
Scenic Doors - Ultimate Outswing Bi-Fold Door	26
Modern Doors - Multi-Slide Door	26
General Care and Maintenance	27
Glass Care Do's and Don'ts	28
Finishing or Painting Bare Interior Wood	28
Factory Applied Interior Finishes	29
Aluminum Clad Exterior Care	30
Caring for Hardware	30
Screens, Interior Shades and Energy Panels	32
Ultimate Sliding Screen - Doors	36
Lock Status Sensor	36
Contact Marvin	36
Glossary	37

Introduction

Thank you for your recent purchase of Marvin® windows and doors.

At Marvin, we build windows and doors the only way they should be built. One at a time. Made to order. No shortcuts. It's this philosophy of doing it the right way that makes us who we are at Marvin. From the moment we began back in 1912, in Warroad, Minnesota, right up through breakfast this morning. Our commitment to providing customers with unparalleled value and service doesn't stop after the purchase. We're proud to create windows and doors that are truly Built around you®.

How to Use this Manual

This manual provides an overview on how to care for and maintain your new Marvin windows and doors. For information on Signature Products or for questions on service or maintenance not covered in this manual, please contact your local Marvin dealer or visit our website at www.marvin.com.

Warranty

Marvin is committed to bringing you products of the highest quality and value. Our made-to-order manufacturing philosophy is one example of our commitment. Our warranty, another.

Please visit the warranty section of our website (www.marvin.com) for full warranty details on your product.



Windows

Window Part Identification

In the following pages you'll find operation and maintenance information on Marvin window products. Refer to the product illustrations for the names of your particular windows, and use the illustration below to help identify window components. Please refer to the Glossary Chapter for terms and their meanings.

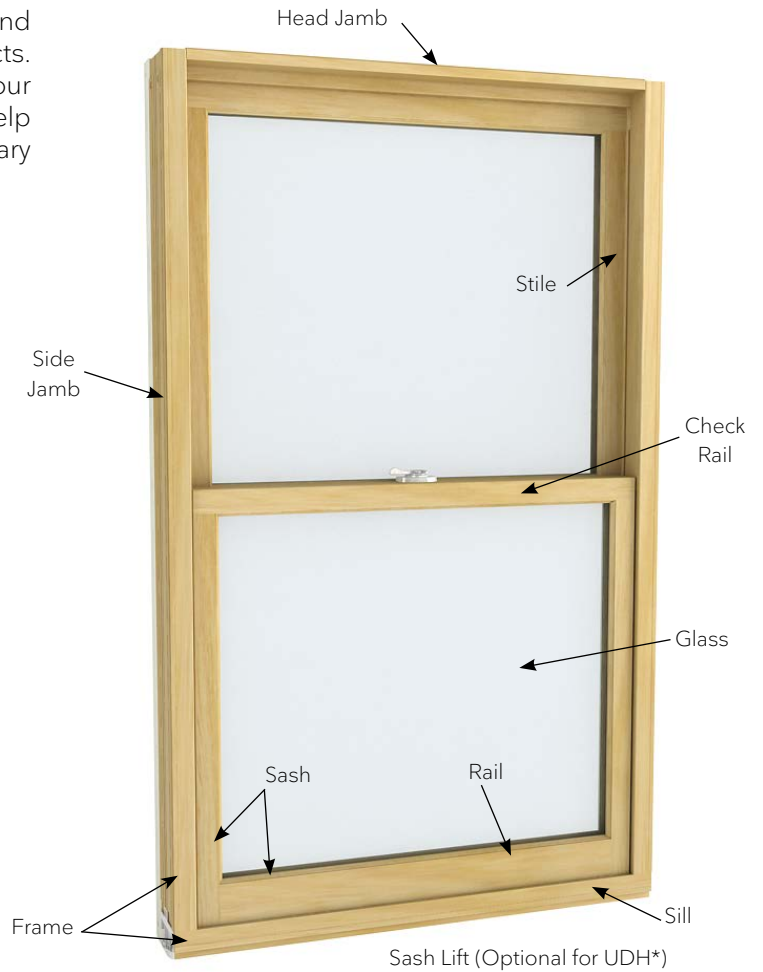

* Next Generation Ultimate Double Hung shown for illustrative purposes only.

Window Styles



Ultimate Casement



Ultimate Awning



Ultimate Push Out Casement



Ultimate Push Out Awning



Ultimate Double Hung Next Generation



Ultimate Glider



Ultimate Venting Picture



Magnum Tilt Turn



Magnum Hopper



Round Top/Polygon Direct Glaze



Ultimate French Casement



Ultimate Push Out French Casement

Ultimate Casement and Ultimate Awning

Operation and Maintenance

The powerful single-arm operator is the mechanism that you crank to open and close the Ultimate Casement and Ultimate Awning. To operate the window, first unlock it by pushing the lock handle 'up'. Crank the handle to open the window sash.



To lock the window, crank the window sash closed. Press down on the lock handle. The lock pulls the sash tightly against the weather strip and seals the window.

To keep your Casement or Awning operating smoothly, clean the window track occasionally with a dry brush. To help prevent the sash from sticking, apply a small amount of dry lubricant to the track (available at most home improvement stores) if necessary. Do not use oily lubricants.

Using the Wash-Mode Feature

The Ultimate Casement and Ultimate Replacement Casement feature a wash mode system which allows the entire window to be washed from inside the home.

NOTE: Wash mode available on Casement product with 20" widths and greater. Not available on Awning windows.

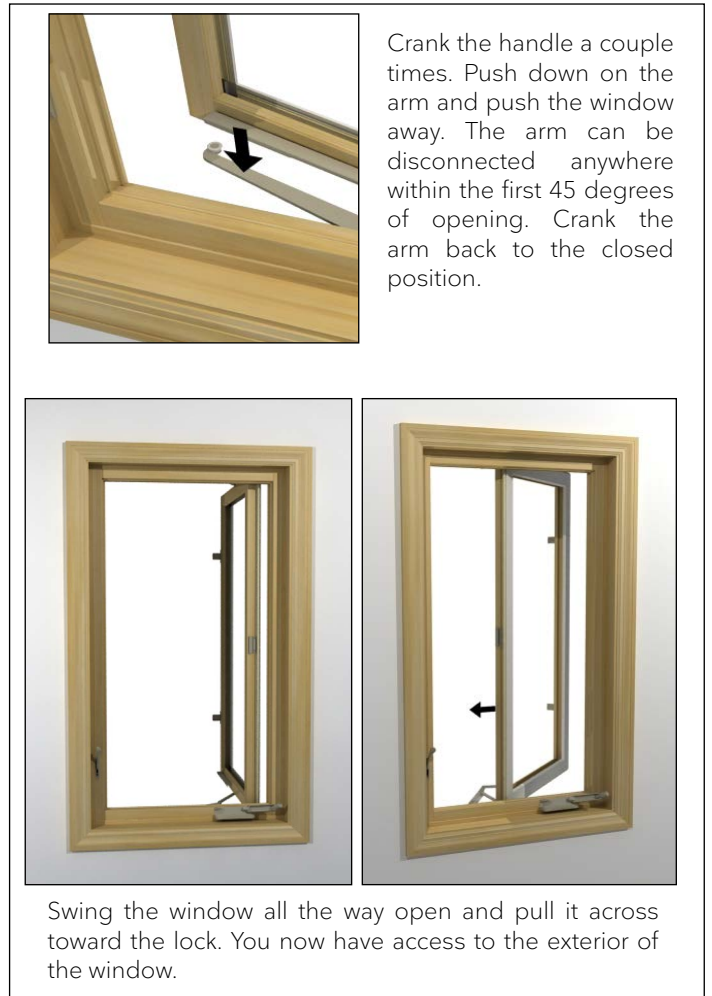

Ultimate Push Out Casement Ultimate Push Out Awning

Operation and Maintenance

Ultimate Push Out products offer a universal look and a more traditional alternative to crank out casements and awnings. To open, turn the lock handle horizontally and push the window sash open. To close, grab the handle and pull the sash to a closed position. Turn the handle downward to lock. The Push Out Casement features a friction limiter which holds the sash in place and allows the sash to lock open at multiple locations. To adjust the friction limiter, follow the [Marvin Ultimate Push Out Supplemental instructions](#) (part number 19970045) which can be found on www.marvin.com

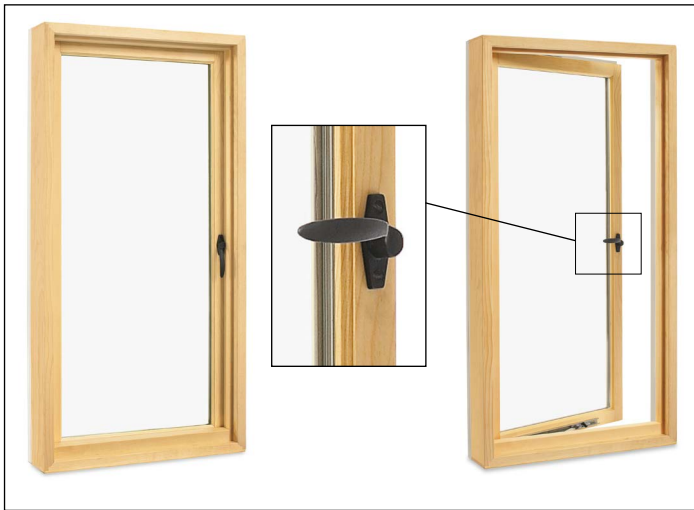

To operate the Ultimate Push Out Awning, rotate the lock handle vertically and push the window open. To close, grasp the handle and pull the window sash shut. Lock the window by rotating the lock handle horizontally.

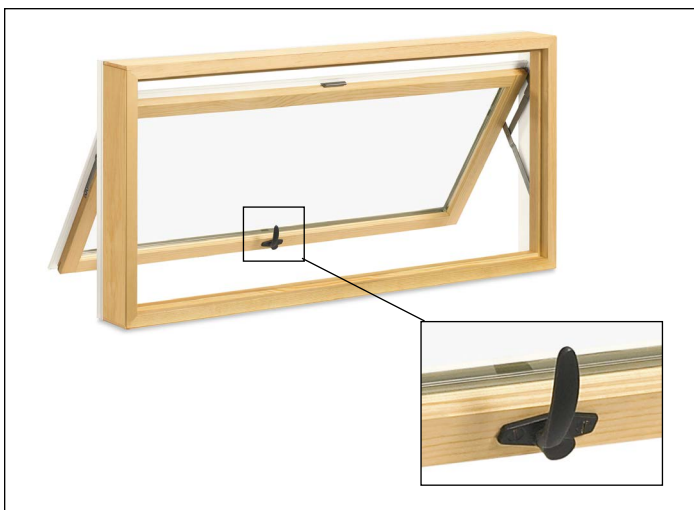

To keep your Ultimate Push Out Casement or Awning operating smoothly, clean the window track occasionally with a dry brush. To help prevent the sash from sticking, apply a small amount of dry lubricant to the track (available at most home improvement stores) if necessary. Do not use oily lubricants.

Wash-Mode Feature on the Push Out Casement

The Ultimate Push Out Casement features the revolutionary wash mode system which allows the entire window to be washed from inside the home.

Unlock and open the sash. Swing the window all the way open and pull it across toward the lock. You now have access to the exterior of the window.

Wash Mode on Ultimate Push Out Casement



To place sash in wash mode unlock and open the sash. Disconnect friction limiter arm from the sash and push it back under the hardware cover. Swing the window all the way open and pull it across toward the lock. You now have access to the exterior of the window.

Ultimate French Casement

Operation and Maintenance

The Ultimate French Casement features two sash with a roto mechanism attached to each sash. The sash lock, located on the sill, operates a locking mechanism that will lock primary sash to the frame on two sides while activating a slide locking mechanism that locks the secondary sash to the primary sash. To operate the Ultimate French Casement, first unlock it by turning the lock handle. Crank the primary sash handle to open the primary sash first, followed by the operation of the secondary sash handle.



To keep your Ultimate French Casement operating smoothly, clean the window track occasionally with a dry brush. To help prevent the sash from sticking, apply a small amount of dry lubricant to the track (available at most home improvement stores) if necessary. Do not use oily lubricants.



To watch a video on how to adjust the UFCA, log on to www.marvin.com and navigate to the video gallery. Or, scan the code above with your smart phone or similar device.

Ultimate Push Out French Casement

Operation and Maintenance

The Ultimate Push Out French Casement incorporates no roto mechanisms like the crank-out unit. Instead, it features a robust adjustable friction limiter device to hold the sash in place when opened, and locks the sash open at multiple points. The multi-point lock on the primary sash locks into the head, sill and into the stile of the secondary sash. The lock on the secondary sash activates bolts that go into the head jamb and sill. To operate the Push Out French Casement, pivot the handles horizontally and simply push the sash open. To adjust the friction limiter, follow the [Marvin Ultimate Push Out Supplemental instructions](#) (part number 19970045) which can be found on www.marvin.com. Follow the same maintenance information provided in the Ultimate French Casement section.



Ultimate Venting Picture

Operation and Maintenance

To operate the Ultimate Venting Picture, simply flip both handle assembly levers upwards. This action will allow brackets to pivot the sash outward while remaining centered. The exterior sash projection will be approximately 3/4" to 1" depending on the product's glass thickness. Reverse this action to close the sash.



The Ultimate Venting Picture requires very little maintenance. Clean the glass occasionally, and maintain the interior wood or exterior surfaces on the same schedule as your other windows.

Ultimate Glider

Operation and Maintenance

The Ultimate Glider features one handed operation. Grasp the handle to both unlock and open the sash. Push the sash closed and it will lock automatically. When the sash is closed completely, the tabs will make an audible “clicking” noise, indicating the locks are engaged.



Periodically clean the sash slide track located under the sash. Spray slide track lightly with furniture wax to prevent sticking. Be sure to wipe off any excess wax.

How to Remove the Glider Sash

Open the interior operator sash the fully open position. Depress the sash retainer bar latch and slide the retainer bar completely free of the sash. Grasp both sides of the sash, tilt the top inward and remove the sash. To install, reverse the above procedure.



Depress the sash retainer bar latch and slide the retainer bar away from the sash.



Tilt and remove the sash.



To watch a video on how to remove the Ultimate Glider sash, log on to www.marvin.com and navigate to the video gallery. Or, scan this code with your smart phone or similar device.

The Ultimate Glider features tabs to help in confirming whether or not your window has locked. If the window has been closed completely and you do not see the tab, the window is locked. In the illustration above, the tab is protruding from the stile which signifies the window is not locked. If your window has not been installed square in the opening, the tabs will indicate that lock adjustment is needed. See your local dealer for help with lock adjustment.

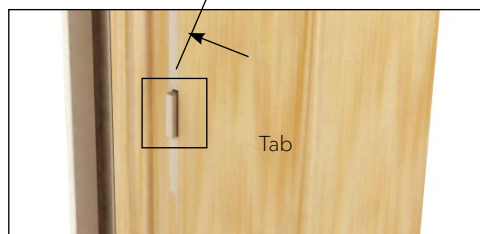

XX Configurations

After the interior operator sash has been removed, slide the interior sash retainer bar back across the head jamb to its closed position. Open the sash to the fully open position, depress the sash retainer bar latch and slide the sash retainer bar completely free of the sash. Grasp the sash on both sides, tilt the top inward and remove the sash. To install the sash reverse the above procedures.



Install the Screen (Clad)

Open the interior operator sash to the fully open position and insert the screen, with the screen guides towards the bottom, into the opening. Pull the screen up tight against the frame while pulling on the screen pins. Once the screen is tight against the frame let go of the pins.



NOTE: For XX units install the screen with the astragal first and slide it across the opening tight up against the side jamb.

[Detailed information](#) on installation, sash removal and screen removal can be found in the [installation section](#) of our website (www.marvin.com).

Wood Ultimate Double Hung

Operation and Maintenance

To operate the Wood Ultimate Double Hung window, unlock the sash lock by rotating the sash lock lever horizontally. Once unlocked, push the bottom window sash upwards to the desired position. To close, reverse the procedure.

Periodically clean the vinyl jamb liners where the sash slides. Keep them dirt and grease free by washing with a gentle dish detergent. Wipe jamb carriers dry before use.

How to Tilt the Wood Ultimate Double Hung Sash

NOTE: For instructions on how to safely tilt or remove your Wood Ultimate Double Hung Magnum sash, see your local dealer or distributor.

To tilt the bottom sash, unlock the sash and raise it about 4" (102 mm) up from the sill. With one hand, rotate the tilt lever (nestled in the sash lock base) until it stops and you've heard a click. Use the other hand to grasp the top of the sash and pull it in towards you until the top rail of the sash clears the frame. Release the sash tilt lever and use both hands to lower the sash to a horizontal position.



To tilt the top sash, lower the sash about halfway and use both hands to simultaneously pull in on the tilt latches located on the top rail of the sash. While holding in on the latches, pull the sash inwards until the top of the sash clears the frame. Release the tilt latches and ease the top of the sash down to a horizontal position.

NOTE: The top sash is not tiltable on a Single Hung window.

How to Remove the Wood Ultimate Double Hung Sash

Tilt the bottom sash as described in the previous section. When the sash is in a horizontal position, lift both sides of the sash upward 2"-3" (51-76 mm) raising pivot pins out of each clutch. Now rotate the sash until pivot pins clear the jambs and remove the bottom sash from the frame.



Ultimate Double Hung Magnum

Next, tilt the top sash using the same technique described in the previous section. When the sash is in a horizontal position, lift both sides upward 2"-3" (51-76 mm) raising pivot pins out of the clutch. Finally rotate the sash until the pivot pins clear the jambs and remove the top sash from the frame.

How to Replace the Wood Ultimate Double Hung Sash

Hold the sash exterior side up with the top rail facing towards you. Rotate and insert the sash so the sash pins clear the frame and place it so the lower sash pin is 2"-4" (51-76 mm) above the clutch. Rotate the sash to the horizontal position and lower it down until the pivot pins are fully seated into the clutches. Simultaneously pull in on both tilt latches and tilt the sash up into place. Release the tilt latches and operate the sash to ensure that the sash is operating smoothly. Replace the bottom sash following the same procedure, except fully engage the tilt lever prior to lifting the bottom sash into place.



Ultimate Double Hung Next Generation

Operation and Maintenance

Lock/Unlock

1. Slide sweep counterclockwise into the 135-degree position.
2. Both sashes can now be opened.
3. To lock the window, simply slide both sashes into the closed position. An audible “click” tells you the windows are locked.

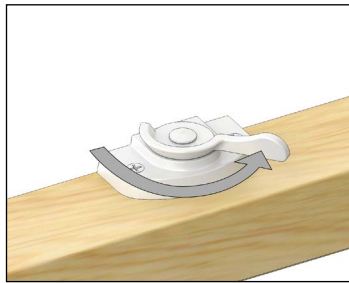

Bottom Sash Tilt & Wash

1. Slide the sweep counterclockwise into the 135-degree position and raise the bottom sash a few inches. Depress the button located on the top of the sweep, then continue to rotate the sweep to the 180-degree position. To tilt, gently pull the top of the sash from window jambs.
2. To install the sash, hold down the button while simultaneously pushing the sweep into the 180-degree position. Gently replace the sash into the frame and release the button and sweep. For instructions on how to safely tilt or remove sash from a Ultimate Double Hung Next Generation window with structural performance brackets, see your local Marvin dealer or distributor.

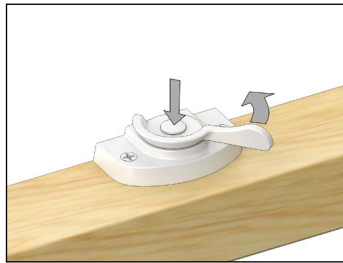

NOTE: On some windows that require specific performance needs, i.e., Storm Plus or sizes that require structural performance brackets the tilt and wash mode will be disabled. Tilting and removal requires additional steps. Refer to installation instructions or contact Marvin.

NOTE: The top sash is not tiltable on a Next Generation Single Hung window.

How to Remove the Ultimate Double Hung Next Generation Sash

Tilt the bottom sash as described in the previous section. When the sash is in a horizontal position, lift both sides of the sash upward 2"-3" (51-76 mm) raising pivot pins out of each clutch. Now rotate the sash until pivot pins clear the jambs and remove the bottom sash from the frame.



To tilt the top sash, lower it to a comfortable working position. Retract the tilt latches located on the top rail and gently pull the sash from the jambs. Note: If the top sash is in the closed/locked position and the bottom sash has been removed the top sash can be unlocked and lowered by retracting the top sash latches on the top check rail.



Magnum Tilt-Turn

Operation and Maintenance

Marvin Tilt-Turn windows offer a unique operating system that allows you to open the window in one of two ways. Turning the window handle from the downward “locked” position to a 90 degree angle (horizontal) lets the window swing open on the hinges. To open to a tilt position, close the window and turn the handle upright to a vertical position. Now the window will tilt on the hinges along the bottom of the unit.



WARNING

Failure to close the sash completely before rotating the handle could result in sash removal.



Closed position

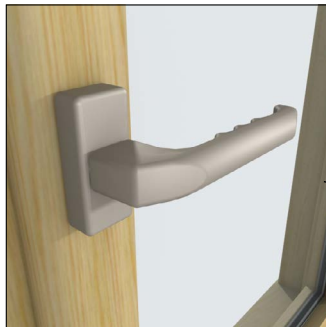
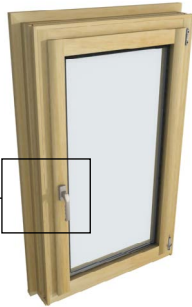

Swing-open position

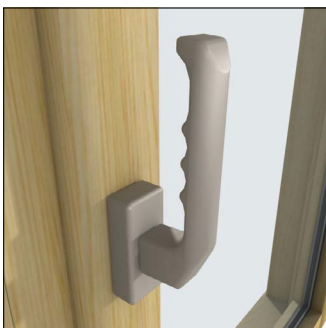
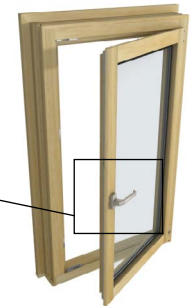

Tilt-open position



To watch a video on how to operate the Magnum Tilt-Turn, log on to www.marvin.com and navigate to the video gallery. Or, scan the code with your smart phone or similar device.



Occasionally use a silicone spray lubricant on the hinges and locking mechanism to keep the operation smooth. Be careful not to allow oil to come in contact with window surfaces. Occasionally clean the sill weep and drain channel area out with a vacuum. Interior and exterior finishes can be cared for in the same manner as any other Marvin window or door.

Magnum Hopper and Magnum Inswing Casement

The Magnum Hopper and Magnum Inswing each offer one half of the operation features of the Magnum Tilt-Turn. The Magnum Hopper tilts open at the top while the Magnum Inswing Casement swings open like a door. Follow the care recommendations in the Magnum Tilt-Turn section.



Magnum Hopper

Round Top, Polygon and Direct Glaze

Maintenance

Most Marvin Round Top and Polygon windows and all Direct Glaze windows are non-operational, meaning they do not open or close, so there are no maintenance requirements for hardware or weather stripping. Clean the glass occasionally, and maintain the interior wood or exterior surfaces on the same schedule as your other windows. For maintenance on operational units, refer to specific product sections.



Window Options

Casement Window Opening Control Device

Marvin offers a factory applied Window Opening Control Device for crank-out Ultimate Casement Products. See the Marvin website for [safety and operating information](#) for this optional feature



To watch a video on how to operate the Window Opening Control Device, log on to www.marvin.com and navigate to the video gallery. Or, scan this code with your smart phone or similar device.

Clad Ultimate Double Hung Next Generation Window Opening Control Device

Marvin offers a Window Opening Control Device for the Clad Ultimate Double Hung Next Generation. See the Marvin website for [safety and operating information](#) for this optional feature.



To watch a video on how to operate the Window Opening Control Device, log on to www.marvin.com and navigate to the video gallery. Or, scan this code with your smart phone or similar device.

Wood Ultimate Double Hung Window Opening Control Device

Marvin offers a Window Opening Control Device for the Wood Ultimate Double Hung. See the Marvin website for [safety and operating information](#) for this optional feature.



Ultimate Glider Window Opening Control Device

Marvin offers a Window Opening Control Device for the Ultimate Glider. See the Marvin website for [safety and operating information](#) for this optional feature



To watch a video on how to remove the Ultimate Glider sash, log on to www.marvin.com and navigate to the video gallery. Or, scan this code with your smart phone or similar device.

Modern Casement and Awning Crank-out

Operation and Maintenance

The powerful single-arm operator is the mechanism that you crank to open and close the Modern Casement and Awning. To operate the window, first unlock it by lifting the lock lever(s) 'up'. Unfold the handle and grip the swivel end to crank open the window sash.

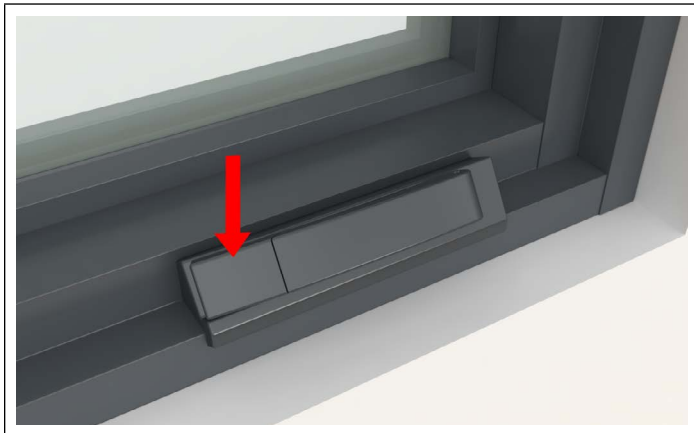
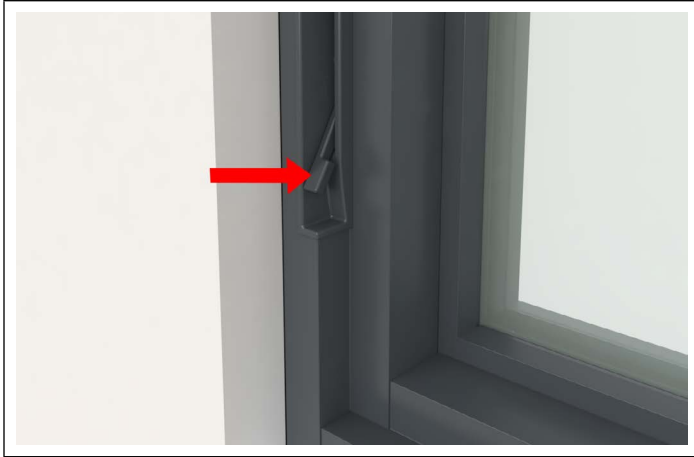

To lock the window, crank the window sash closed. Press down on the lock lever. The lock pulls the sash tightly against the weather strip and seals the window.

To keep your Casement or Awning operating smoothly, clean the window track occasionally with a dry brush. To help prevent the sash from sticking, apply a small amount of dry lubricant to the track (available at most home improvement stores) if necessary. Do not use oily lubricants.

Using the Wash-Mode Feature

The Modern Casement features a wash-mode system which allows the entire window to be washed from inside the home.

Unlock and open the window. Crank the handle a few times. Push down on the hinge arm (refer to image below) and push the window outward. The hinge arm can be disconnected anywhere within the first 45 degrees of opening. Crank the hinge arm back to the closed position using the folding handle.

Swing the window all the way open and pull the side nearest the jamb across the opening. You now have access to the exterior of the window for cleaning.

Wash mode available on Casement windows product with 20" widths and greater. Not available on Awning windows.

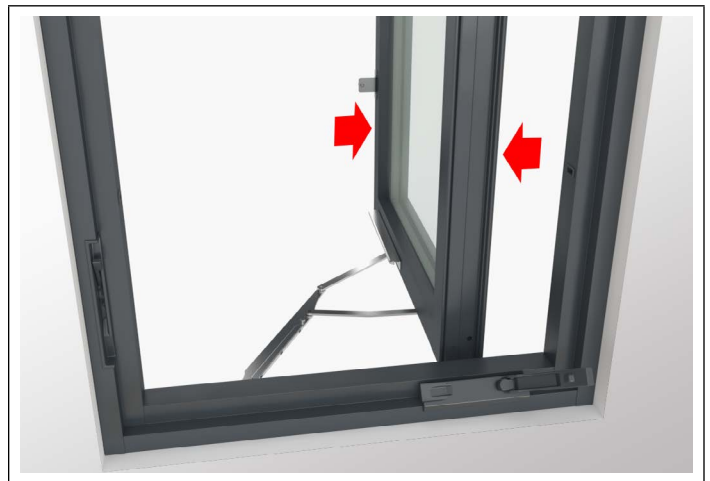
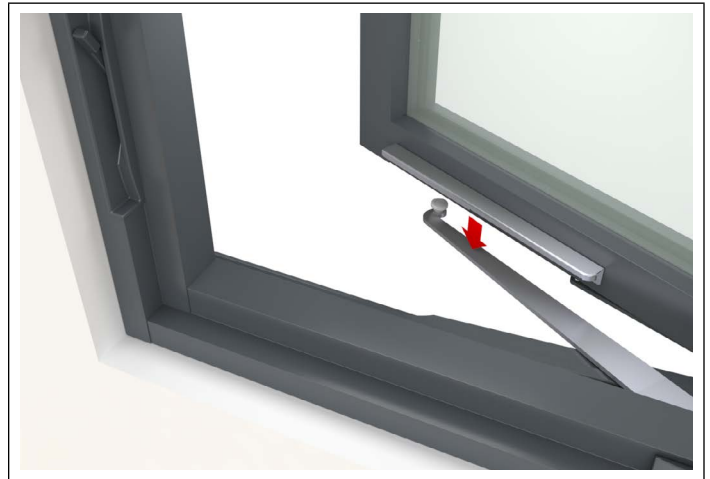

Modern Casement and Awning Push-out

Operation and Maintenance

The Modern Push-out products feature a concealed handle to open and close the window/s along with concealed sequential locking. The information contained provides operating and cleaning instructions.

To open, first unlock by lifting the lock lever(s) 'up' and then push the sash outward. To close, grip the handle and pull the sash to the closed position. Press down on the lock lever to seal the window. The Push-out windows include a limiter on the hinge arm which positions the sash at multiple opening points.

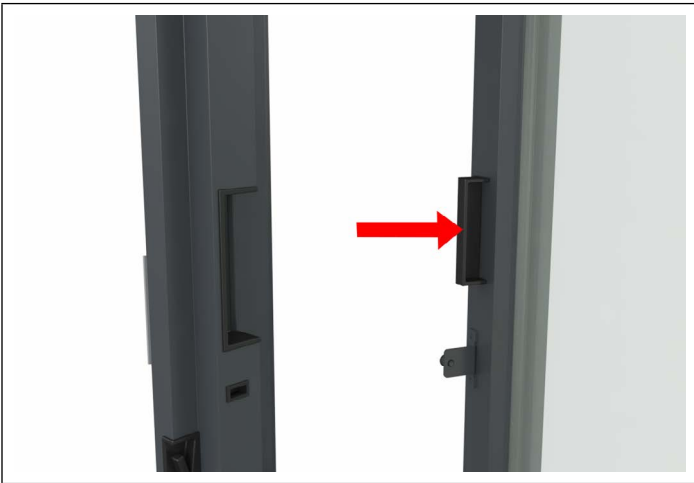
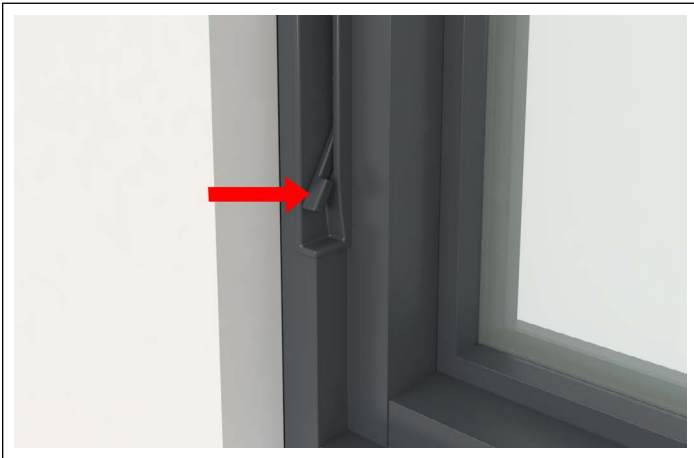

To keep your Modern Casement or Awning Push-out operating smoothly, clean the window track occasionally with a dry brush. To help prevent the sash from sticking, apply a small amount of dry lubricant to the track (available at most home improvement stores) if necessary. Do not use oily lubricants.

Using the Wash-Mode Feature

The Modern Casement Push-out features a wash-mode system which allows the entire window to be washed from inside the home.

To place the sash in wash-mode unlock and open the sash. Slide the clip to release the pin at the end of the hinge arm, closest to the sash at the end of the hinge arm, closest to the sash. Pull up on the hinge arm (refer to image below) and push the window outward. The hinge arm can be disconnected anywhere within the first 45 degrees of opening. Pull the hinge arm back to the closed position.

Swing the window fully open and pull the side nearest the jamb across the opening. You now have access to the exterior of the window for cleaning.

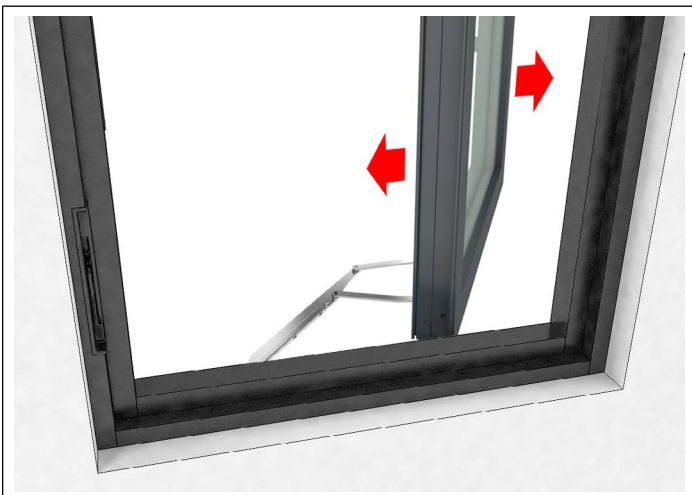
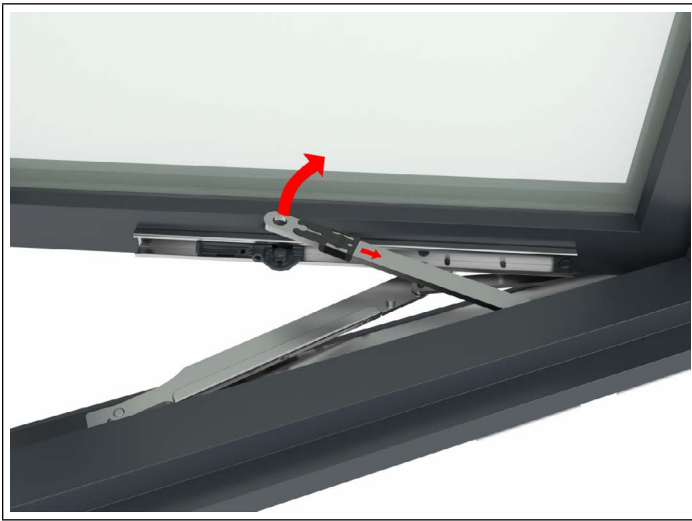

Modern - Direct Glaze

Maintenance

Marvin Modern Direct Glaze windows are fixed windows that do not operate. There are no hardware maintenance requirements. Clean the glass occasionally, and maintain the interior or exterior surfaces on the same schedule as your other windows.



Doors

Door Part Identification

In the following pages you'll find operation and maintenance information on Marvin door products. Refer to the product illustrations for the names of your particular doors, and use the illustration below to help identify door components. Please refer to the Glossary Chapter for terms and their meanings.



Door Styles



Ultimate Inswing French Door



Ultimate Outswing French Door



Ultimate Sliding French Door



Sliding Patio Door



Bi-fold Door



Ultimate Lift and Slide Door

How to Determine Handing of Swinging Doors

1. Stand on the side of the door swinging away from you with your back to the hinge of the door.
2. Reach out with your closest hand to the door handle
3. If your left hand is on the door handle and the door swings into the building, the operation of the door is Left Hand Inswing (LHI).
4. If your right hand is on the door handle and the door swings into the building, the operation of the door is Right Hand Inswing (RHI).
5. If your right hand is on the door handle and the door swings to the exterior of the building, the operation of the door is Right Hand Outswing (RHO).
6. If your left hand is on the door handle and the door swings to the exterior of the building, the operation of the door is Left Hand Outswing (LHO).
7. Use the same procedure to determine handing on the active panel of the XX doors standing with your back to the active panel hinge.

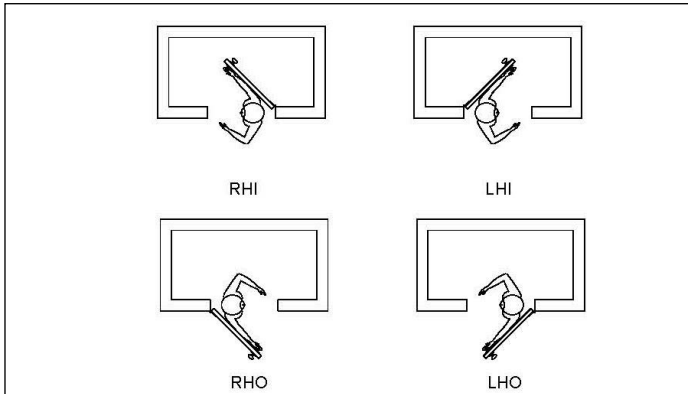

How to Determine Handing of Sliding Doors

To determine the handing of Sliding Doors, face the door from the exterior. If the panel travels toward the right, the door would be called out as a Right Hand (RH) active. If it moves toward the left it would be a Left Hand (LH) active. The stationary panel is designated with an "O". The active and inactive panels are designated with an "X".

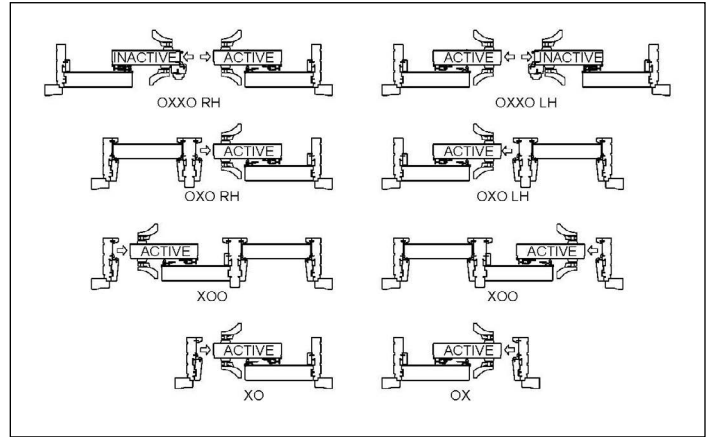

For operating configurations for the Ultimate Lift and Slide door, please refer to the [Marvin Architectural Detail Manual chapter](#) online or contact your local dealer.

Operation of Marvin Residential Doors

To determine the Stationary and Active/Inactive panels of Marvin residential doors, view the door from the exterior of the building.

Swinging Doors

Operation and Maintenance

To operate the door from the interior, grasp the active panel's handle lever and rotate it downwards. Pull the door panel towards you for an Inswing door, or push the door outwards for an Outswing door.



Doors require very little maintenance to keep them functioning efficiently. Most problems can be eliminated by keeping the sill clean, ensuring smooth door operation. Chemicals, solvents, paints, and other harsh substances should never come in contact with the sill. Remove any paint, grease or sealant with 50% isopropyl alcohol. Finished wood doors need to adjust to humidity levels in a home and may warp slightly as seasons change - allow one full year for your door to go through this process. Door handles can be wiped down with a damp cloth to remove fingerprints and smudges.

Marvin doors have a special weep drainage system incorporated into the sill design. Periodically check the sill to be sure the weep system is free from debris. To maintain sill appearance, wash only with mild soap and water solution.

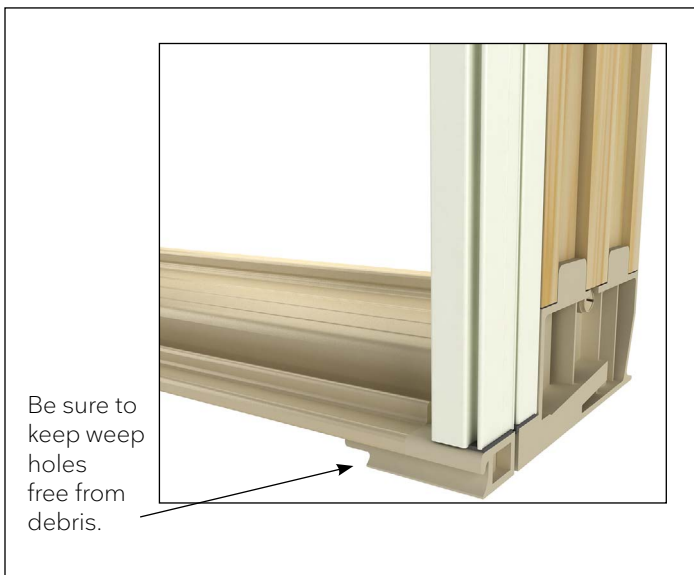

Handle Operation for the Multi-Point Lock

Always close and lock your passive panel first and the operating panel (with thumb turn) second. Marvin's multi-point hardware has locking bolts at the head and base of the door. Lifting the handle 45 degrees upward will set the head and foot bolts in place for a secure seal. A 90 degree turn of the key from the outside or the thumb turn on the inside will lock the deadbolt in the handle assembly. When the deadbolt is unlocked, downward pressure on the handle will release the bolts and latch, and the door will open. Engaging only the deadbolt will offer some security. However, to obtain full security and full performance against air and water infiltration, engage the head and foot bolt along with the dead bolt.



Lifting the handle upward will engage both the head bolt and foot bolt.

NOTE: An operating passive panel will have either manual head and foot bolts or multi-point hardware.



To watch a video on multi-point lock operation, log on to www.marvin.com and navigate to the video gallery. Or, scan the code to the left with your smart phone or similar device.

Adjustable Hinges

Some Swinging Doors are equipped with adjustable hinges which allow horizontal and vertical adjustment after the door has been permanently installed.

To adjust panel(s) horizontally away from the hinge jamb, open the panel slightly to access the hinges, turn horizontal adjustment screw counter-clockwise using a 5/32" (4mm) Allen wrench. To move the panel toward the hinge jamb, turn the Allen screw clockwise.

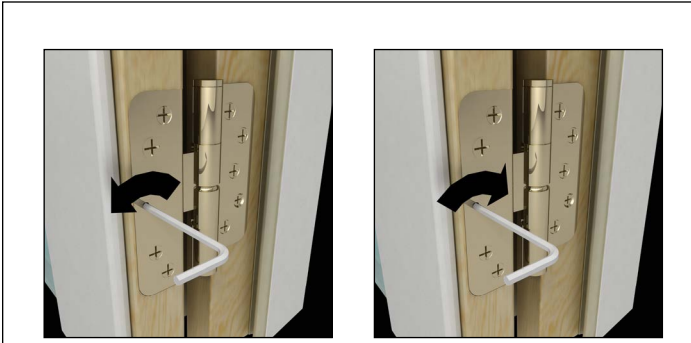

Adjusting the panel horizontally.

To raise the panel vertically, first adjust one hinge and remaining hinges equally by turning the vertical adjustment screw clockwise using a 5/32" (4mm) Allen wrench. To lower the panel, adjust all hinges equally by turning the screws counter-clockwise.



Adjusting the panel vertically.

Be sure to make horizontal adjustments first. Make any vertical adjustments **ONLY** after the horizontal adjustments are complete.

NOTE: When raising or lowering panel vertically, it will be necessary to loosen or tighten all vertical adjustment screws so the weight of the panel will not be on just one hinge. Compare alignment marks on each hinge to ensure even weight distribution of the panel.

Butt Hinge Adjustment

On doors equipped with butt hinges, there are 1/32" (1mm) shims behind each leaf on all hinges. Horizontal panel adjustment is possible by removing or redistributing these shims.

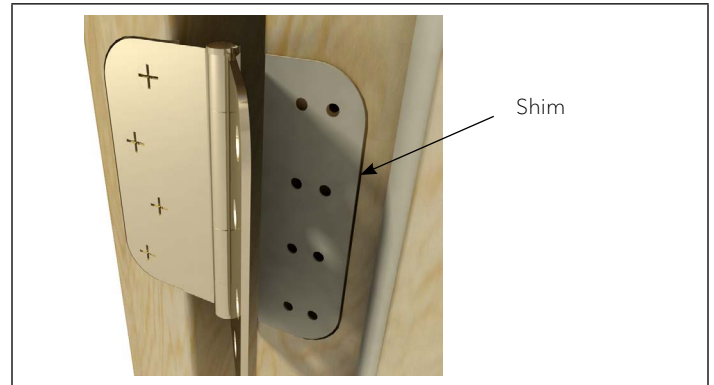

Sliding Doors

Operation and Maintenance

The Sliding Patio and Ultimate Sliding French Doors require very little maintenance to keep them functioning efficiently. Most problems can be eliminated by keeping the sill clean, ensuring smooth door operation. Chemicals, solvents, paints, and other harsh substances should never come in contact with the sill. Remove any paint, grease or sealant with 50% isopropyl alcohol. Finished wood doors need to adjust to humidity levels in a home and may warp slightly as seasons change - allow one full year for your door to go through this process. Door handles can be wiped down with a damp cloth to remove fingerprints and smudges.



Marvin Doors have a special weep drainage system incorporated into the sill design. Periodically check the sill to be sure the weep system is free from debris. To maintain sill appearance, wash only with mild soap and water solution.

Although it is very seldom that door rollers and/or locks require lubrication, occasionally use spray lubricant to keep operation smooth (rollers are visible underneath the operator panel).

Adjusting the Rollers

If the operating panel does not slide smoothly, you may need to adjust your door rollers from the inside. First, make sure your door is unlocked and remove the wood plugs located at the bottom of the panel. Then, push the operator panel almost to the side of the jamb. A narrow strip of daylight will be visible between the door panel and the jamb (see illustration). If the gap appears wider at the top of the panel than at the bottom, adjust the roller nearest the frame downward or the roller on the side toward the stationary panel upward until the panel is level and the daylight strip is evenly spaced from the top to bottom. Adjust rollers by turning a flathead screwdriver in the adjustment holes at the base of your operator panel. If the gap appears wider at the bottom,

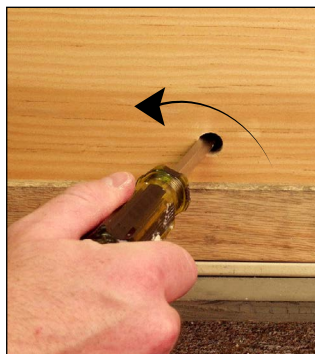

first adjust the roller closest to the frame upward or the roller near the stationary panel downward until the panel sits level on the track.

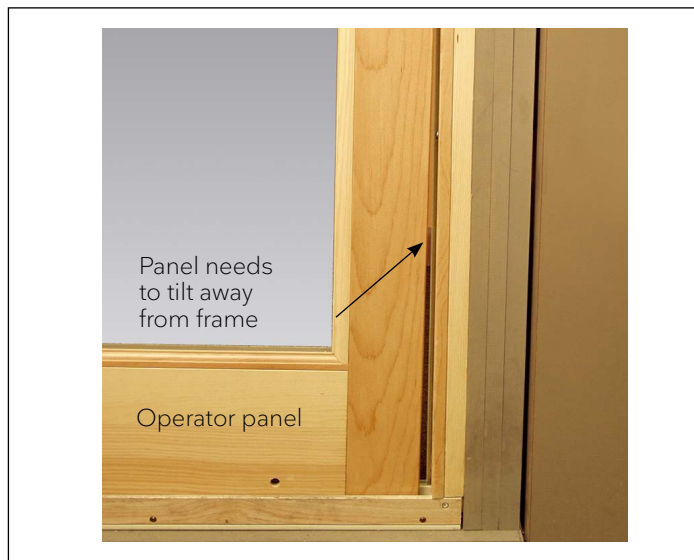

To watch a video on how to adjust the rollers, log on to www.marvin.com and navigate to the video gallery. Or, scan this code with your smart phone or similar device.

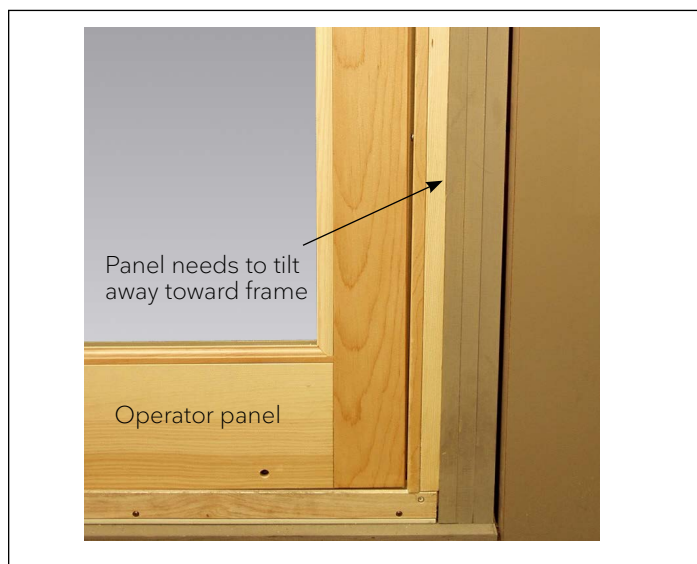

Adjusting the Keepers - Sliding Patio Door

If your Sliding Patio Door does not lock properly, some adjustment to the lock and keeper may be necessary. Before making any adjustments, inspect the vertical alignment of the keeper on the door frame to the latch hooks on the panel. Adjust the keeper by loosening the screws and sliding the keeper up or down as needed.

If necessary, the latch hooks can be adjusted to pull the panel tighter to the frame when locked. After the latch and strike are aligned vertically, adjust latch hooks by rotating adjustment screws above/below hooks with a standard screwdriver. Adjust one latch hook at a time, rotate adjustment screw to draw latch hook into the lock in small increments. Close the panel and check lever operation. Adjust the hook until slight resistance is felt and the panel is drawn snug against locking jamb. Repeat these adjustments for the remaining latch hook.

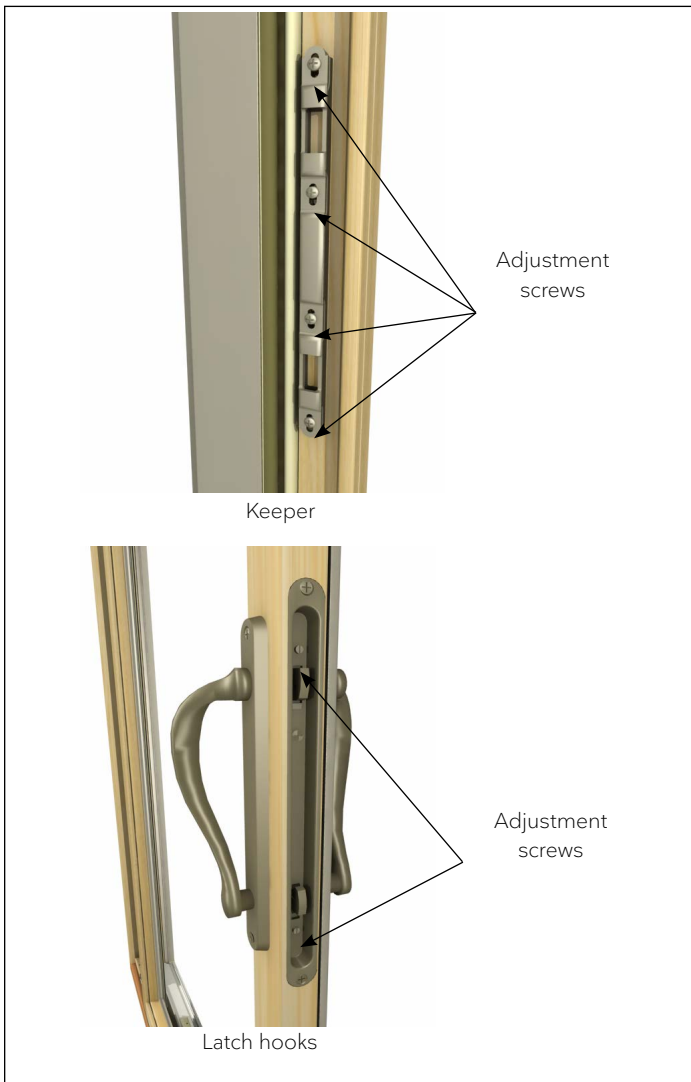

Adjusting the Keepers - Sliding French Door

If your Sliding French Door does not lock properly, close the panel slowly and check to see if the panel is hitting the keeper(s). If this is the case, loosen the two screws attaching the keeper to the jamb. Slide the keeper to the left or right as necessary and tighten screws. Make sure that the keeper is in a vertical position. Adjust one keeper at a time and check panel operation before moving on to the next.

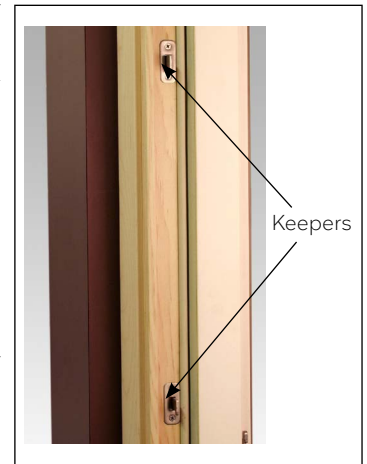

If the panel locks but does not seal tightly or will not lock at all, the center keeper depth needs to be adjusted.

NOTE: Ultimate Sliding French doors with multi-point locking hardware come standard with two point locking hardware. Three point locking hardware is optional. Keeper depth adjustment is only possible on the center keeper for Ultimate units or on the bottom keeper for standard units.

To adjust, remove the two screws attaching the keeper assembly to the locking jamb. Remove the cover plate, keeper and shims. At the factory, one shim is installed in front of the keeper and one is installed behind. If more locking force is desired, move the front shim to the back. Once shim adjustment is made, replace the cover plate and screws. Make certain that the keeper is kept in a vertical position. Check panel for proper operation and adjust as necessary.

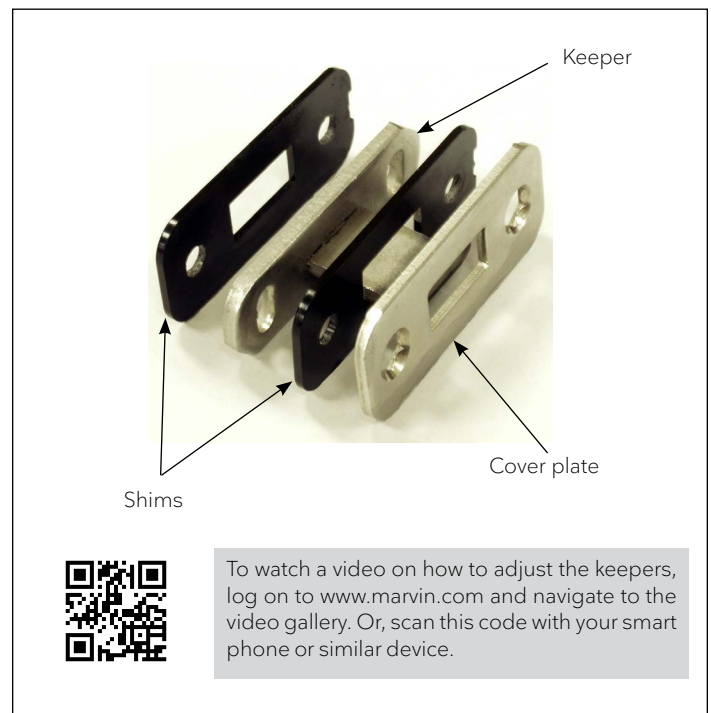

To watch a video on how to adjust the keepers, log on to www.marvin.com and navigate to the video gallery. Or, scan this code with your smart phone or similar device.

Scenic Doors - Ultimate Lift and Slide Door

Operation and Maintenance



The Ultimate Lift and Slide Door requires very little maintenance to keep it functioning efficiently. Most problems can be eliminated by keeping the sill clean, ensuring smooth door operation. Chemicals, solvents, paints, and other harsh substances should never come in contact with the sill. Remove any paint, grease or sealant with 50% isopropyl alcohol. Door handles can be wiped down with a damp cloth to remove fingerprints and smudges.

To lock the active panel onto the locking bolts, the panel has to be lowered to lock properly. On a bi-parting door, the secondary panel must be lowered first.

Scenic Doors - Clad Ultimate Multi-Slide Door

Operation and Maintenance



The Ultimate Multi-Slide Door requires very little maintenance to keep it functioning efficiently. Most problems can be eliminated by keeping the sill clean, ensuring smooth door operation. Chemicals, solvents, paints, and other harsh substances should never come in contact with the sill. Remove any paint, grease or sealant with 50% isopropyl alcohol, refer to the Ultrex cleaning instructions for further instructions. Door handles can be wiped down with a damp cloth to remove fingerprints and smudges.

Minimum requirement for the maintenance of hardware is as follows:

Rollers: Apply a light spray of lubricant. Lubricant reduces wear, improves smoothness and further protects against corrosion of the track and rollers.

Scenic Doors - Ultimate Outswing Bi-Fold Door

Operation and Maintenance

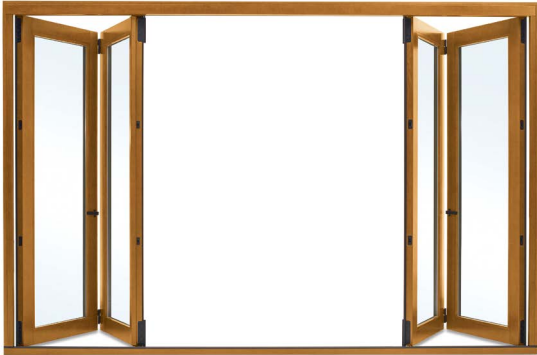

The Ultimate Outswing Bi-fold Doors require very little maintenance to keep them functioning efficiently. Most problems can be eliminated by keeping the sill clean, ensuring smooth door operation. Chemicals, solvents, paints, and other harsh substances should never come in contact with the sill. Remove any paint, grease or sealant with 50% isopropyl alcohol, refer to the Ultrex cleaning instructions for further instructions. Finished wood doors need to adjust to humidity levels in a home and may warp slightly as seasons change - allow one full year for your door to go through this process. Door handles can be wiped down with a damp cloth to remove fingerprints and smudges.

Minimum requirement for the maintenance of hardware is as follows:

Bearings: Apply a light spray of lubricant. Lubricant reduces wear, improves smoothness and further protects against corrosion of the track and bearings. Note that the stainless steel bearings also require periodical cleaning and lubrication that prevent corrosion.

Hangers, Pivots and Brackets: Wipe down with warm soapy water and a soft rag, rinse clean and dry all exposed surfaces well. Apply a light spray of lubricant. Remove excess with a dry cloth.

Hinges: Use warm soapy water on a soft rag. Wipe down the exposed surfaces. Follow with wiping with a clean damp rag. Maintain the original luster of the metal finish by application of a thin film of light machine oil or a corrosion preventing spray. Note that these materials may stain wood material and it's finish.

For operating configurations for the Ultimate Outswing Bi-Fold door, please refer to the [Marvin Architectural Detail Manual chapter](#) online or contact your local dealer.

Modern Doors - Multi-Slide Door

Operation and Maintenance



The Modern Multi-Slide Door requires very little maintenance to keep it functioning efficiently. Most problems can be eliminated by keeping the sill clean, ensuring smooth door operation. Chemicals, solvents, paints, and other harsh substances should never come in contact with the sill. Remove any paint, grease or sealant with 50% isopropyl alcohol, refer to the Ultrex cleaning instructions for further instructions. Door handles can be wiped down with a damp cloth to remove fingerprints and smudges.

Minimum requirement for the maintenance of hardware is as follows:

Rollers: Apply a light spray of lubricant. Lubricant reduces wear, improves smoothness and further protects against corrosion of the track and rollers.

General Care and Maintenance

Semi-Annual Inspection List

- ❑ Inspect weather strip for damage or loss of performance. Contact your local Marvin dealer for parts if your weather strip requires replacement.
- ❑ Inspect exposed hardware screws; tighten if needed.
- ❑ Inspect exterior sealant around the outer edges of the window or door frame. Trim any loose sealant and reseal any gaps with a good quality sealant.
- ❑ Examine the window or door's interior and exterior finish. Periodic cleaning and touch-up can extend the life of your finish.
- ❑ Clean sand, dirt or dust from door and window hinges, sills and tracks.
- ❑ When soiled, wash the exterior of your doors and windows with warm soapy water; rinse with clean water and dry.

NOTE: In harsh environments, such as near salt water, Marvin Windows and Doors recommends quarterly inspections and maintenance. Salt and other corrosive or abrasive substances must not be allowed to build up on exterior surfaces.

Salt Water Care

If you live near a sea coast (salt water), make sure salt and other corrosive or abrasive materials do not build up on the exterior surfaces. Clean the exterior with a mild detergent soap and water at least every three months and more frequently if necessary to prevent build up. Any scratches, chips or areas of abrasion to the exterior coating must be repaired immediately.

Condensation

During cold winters, there is a large temperature difference between the interior and exterior of your home. When the temperature drops outdoors, the glass on your windows tend to have a lower surface temperature than other surfaces in your home and is the first place that you'll notice condensation in your home. This is not due to any defect in your window or door, it's simply a sign of needing to reduce the humidity in your home.

If condensation is a chronic occurrence in your home, chances are that you have excessive humidity. If water is accumulating on glass, chances are it is accumulating on other harder to see surfaces such as wall and roof cavities. If left uncontrolled, excess moisture can have serious consequences, including:

- Mold or mildew
- Damp, ineffective insulation
- Warping
- Discolored or blistered paint
- Roof ice build-up
- Moisture inside walls and attic

Excessive interior humidity is more likely to occur in newer or recently remodeled homes with tight, energy efficient construction, causing a build up of moisture to the interior. Information on excessive humidity and how to reduce condensation on your windows can be found on the internet by searching for "window condensation".

Cleaning the Glass

The best method to clean the glass on your Marvin window or door is to first soak the glass surface with a clean water and soap solution to loosen dirt or debris; rinse clean. Next, wash your window or door with a mild glass cleaning solution and a non-abrasive applicator. Use a clean dry cloth to remove cleaning solution from the glass. Finally, wipe off any cleaning solution that made contact with the weather strip, sash or frame.

Do not use razor blades, knives or scrapers for cleaning glass surfaces.

For more information on cleaning the glass or for instructions on how to properly remove the labels from the glass, see the [Removing Labels from Glass](#) section of our website (www.marvin.com).

Glass Care Do's and Don'ts

Tempered Glass

Certain Marvin windows and doors use tempered glass for safety reasons. Tempered glass is heated, then cooled at an accelerated rate, adding strength and shatter resistance. You may notice some distortion - this is normal and due to the tempered glass fabrication process. The logo in the corner of each piece of tempered glass is required by code and safety regulation.

DO	DON'T
• Clean glass when dirt and residue appear	• Use scrapers of any size or type for cleaning glass
• Determine if coated glass surfaces are exposed*	• Allow dirt and residue to remain on glass for an extended period of time.
• Exercise special care when cleaning coated glass surfaces*	• Trap abrasive particles between the cleaning materials and the glass surface
• Start cleaning at the top of the building and continue to lower levels	• Allow water or cleaning residue to remain on the glass or adjacent materials
• Soak the glass surface with a clean water and soap solution to loosen dirt and debris	• Begin cleaning without rinsing excessive dirt and debris
• Use a mild, non-abrasive commercial window cleaning solution	• Use abrasive cleaning solutions or materials
• Wipe all cleaning solution from window gaskets, sealants and frames	• Allow metal parts of cleaning equipment to contact the glass
• Remove any labels on the glass immediately after product installation	• Clean glass in direct sunlight
	• Allow splashed materials to dry on the glass surface
* Such as an energy panel with hard coat Low E.	

Finishing or Painting Bare Interior Wood

If you have a brand new, bare wood Marvin window or door, you must finish it immediately to prevent possible damage to the wood. Make sure the bare interior surface is clean and dry. Remove any handling marks, debris, or effects of exposure to moisture by sanding lightly with fine sandpaper and wiping clean before applying your choice of finish. Marvin uses a rubber-like material between glass panes and wood sash frames to ensure a weather tight seal. Occasionally, an excess of this silicone sealant, called "squeeze-out", appears around the edge of the glass. You can safely but gently scrape off squeeze-out with a plastic putty knife without damaging the weather tightness of your door or window.

When applying a finish, it is imperative that you do not come in contact with weather strip, vinyl, plastic, metal or any other non-wood parts. Do not apply a finish to any surface which has an abrasive or sliding contact with another surface such as Double Hung and Single Hung Tilt Pacs; Clad Ultimate Double Next Generation, Magnum Double Hung and Single Hung Tilt Pacs, and Magnum Panning Systems. Solvents in paints, stains and varnishes will cause plastic or vinyl parts, in particular, to become brittle and require replacement.

Prior to staining it may be desirable to apply a wood conditioner to obtain a more even finish. Follow the manufacturer's recommended instructions.

Lock Status Sensor

If your window or door incorporates a wireless lock status sensor option, do not paint or caulk over the joint between the head jamb part stop and the frame. Wireless transmitters use a small battery that you will need to change at some time.

Staining

Apply stain according to the manufacturer's instructions. Apply as many coats of stain as necessary to achieve the desired color. After the stain is thoroughly dry, apply at least two coats of sealer (i.e. varnish or polyurethane).

Painting

Use only high quality primer and paint. To provide a good adhesion of paint, a compatible prime coat should be applied. Paint with sash or panels open (or removed) and do not close until thoroughly dry. Apply primer and paint according to the manufacturer's instructions.

Factory Applied Interior Finishes

(Painted, Stained, Clear Coat)

If your product came with one of Marvin's factory-applied interior finishes, avoid getting any cleaning solutions (such as glass cleaner) on the wood as they may discolor the finish. To clean marks off of the wood, use a soft cloth dampened with water. Rub gently to remove the mark. Once the mark has been removed, dry the area with a clean, soft, dry cloth. If the mark is still evident, add 3-5 drops of non-abrasive detergent to a pint of water and mix it well. Rub gently with a damp cloth to remove the mark. Rinse the detergent from the area then dry clean with a soft dry cloth.

If touch-up repair is needed for any scratches or minor dents, follow the instructions on our [website](#).

Exterior Wood and Cladding

The exteriors of Marvin windows and doors are made from either wood or extruded aluminum cladding. There are different ways to care for each - make sure you follow cleaning instructions closely to prevent any inadvertent damage to your exteriors.

Periodically inspect sealant around the exterior perimeter of the unit, remove any loose sealant and apply new sealant.

Finishing a Wood Exterior

A bare wood, brand new Marvin window or door must be painted immediately to prevent possible damage to the wood, even if the window or door is already primed. Primers function to maximize adhesion between the wood and the paint; they do not offer any protective qualities.

Make sure all bare wood window and door surfaces are clean and dry. Fill exterior nail holes with an exterior grade wood filler and sand smooth. Remove any handling marks, debris, or effects of exposure to moisture by sanding lightly with fine sandpaper and wipe clean before applying paint.

Before finishing, run a strip of masking tape along the edge of the glass, leaving a 1/16" (2 mm) gap between the tape and the wood. This will allow you to lap the finish coat onto the glass for a proper seal. To make sure you get good paint adhesion, high quality primer should be used. Apply one coat of primer and two coats of top quality paint. Follow the paint manufacturer's instructions. Use only a high quality oil base or latex paint. Paint windows with sash or panels opened (or removed) and do not close or reinstall until thoroughly dry.



Carefully follow paint instructions, and make sure you wear adequate hand and eye protection.

Windows and doors with a wood exterior should be inspected and repainted periodically. Any signs of blistering, peeling or cracking in the finish should be immediately repaired to protect the wood. Consult with a local paint store or house painting contractor for the best solution for your needs. If you notice any cracks, they should be filled prior to repainting with a high quality paintable sealant. Smaller cracks may be filled with an exterior grade wood filler.

NOTE: Marvin does not recommend the use of stain or clear coat finishes on exterior surfaces.

Attention

Paints, stains and varnishes contain solvents which, when coming in contact with plastics and vinyls used in weather stripping, cause these materials to lose their flexible qualities, making them brittle. Even momentary contact between the finish and the plastic will cause this to occur. Also, do not allow strong detergents, ammonia, solvents, chemicals or other harsh cleaning substances to come in contact with painted exterior surfaces as they can be damaged.

Aluminum Clad Exterior Care

Marvin clad products have a tough armor of extruded aluminum coated with a minimum of 70% Kynar[®], a fluoropolymer resin enhanced with ceramic pigmentation. This coating translates into a beautiful, low maintenance exterior that retains its original color for years to come.

Use a soft brush such as a long-handled car washing brush, with clear water to remove any bugs, grime, dirt or dust that may gather on the aluminum cladding. Before using any cleaners, test the solution on an inconspicuous area. A thorough clear water rinse should follow.

Mildew on Exterior Surfaces

Mildew thrives on warmth and moisture and will grow best under these conditions. It is so adaptable, however, that it can flourish to some degree under all climatic conditions. Mildew growth is usually brown or black in color and, for this reason, may be mistaken for dirt. The presence of mildew on your exterior can be confirmed by placing a drop of household bleach on the suspected mildew area. If small gas bubbles develop in the droplet of bleach and the area bleaches out, mildew does exist and should be removed.

Use this basic solution for controlling exterior mildew problems:

- 1/3 cup (79 ml) powder laundry detergent
- 2/3 cup (158 ml) trisodium phosphate (TSP)
- 1 quart (946 ml) household bleach
- 3 quarts (2839 ml) water

Apply solution with a soft bristle brush using medium pressure. Rinse well with clear water after cleaning.

Attention

Stronger concentration of cleaner can damage the coating surface or finish. Always wear protective eyewear and skin protection when using harsh cleaning products.

Caring for Hardware

General Guidelines

- Use a clean, soft, damp cloth to polish and remove finger prints and dirt from the window and door hardware.
- Do not use household cleaners, window cleaning solutions, abrasive cleansers, bleaches, solvents, polishes or other chemical compounds to clean your window or door hardware unless specifically recommended by the hardware's manufacturer. These products may remove protective coatings or scratch and remove finishes. Keys, rings or other sharp objects should be kept from striking the hardware.

Solid Brass Hardware Maintenance

NOTE: If your window's or door's solid, bright-brass lacquered hardware does not have a PVD finish, please follow the directions below to care and maintain your bright-brass hardware. These instructions do not apply to antique brass, chrome-plated or nickel-plated brass finishes, oil-rubbed bronze hardware or PVD hardware finishes.



Solid brass hardware is typically factory-finished with clear lacquer. The durability of lacquer depends on the specific manufacturer involved and the circumstances of wear and environment. Lacquers are affected by pollutants, temperature extremes, ultraviolet light, marine salt air or spray, paint fumes, and household cleaning solutions which contain bleaches, abrasive, or solvents. Ordinary wear from frequent handling is also a factor. The harsh salt air environment of beach-front properties is perhaps the most severe condition frequently encountered, where lacquers can fail in a matter of weeks.

It is **STRONGLY RECOMMENDED** that ANY BRASS HARDWARE USED OUTDOORS BE COATED WITH WAX - either a nonabrasive paste furniture wax or a nonabrasive automotive wax. This waxing should be done immediately when the hardware is installed, and maintained frequently thereafter.

For more information on the care and maintenance of solid brass hardware, see the [Caring for Window and Door Hardware](#) section of our website.

Oil Rubbed Bronze Hardware Maintenance

Your dark oil rubbed bronze finish is not coated with lacquer and is designed to age naturally over a period of time. How quickly this process occurs is both dependant upon usage and whether the product is used externally. The natural ageing process will allow the brass color of the underlying metal to show through along areas of wear.

To retain luster to the product, clean periodically once every 2 or 3 months with a soft cloth and apply a light coating of bee's wax to the product and buff up using a soft cloth. Alternatively you can leave the product to naturally age with elegance.

Do not use any abrasive or non abrasive cleaning materials or solvents when cleaning your oil rubbed bronze product or the Bronze color may be removed completely.

Hardware with a Physical Vapor Deposition (PVD) Finish

Your PVD finished product has undergone a state of the art process known as Physical Vapor Deposition. A layer of hard-wearing metals are deposited onto the solid brass substrate which means it has been given a tough finish to resist fading and discoloration by direct sunlight, humidity, and most other environmental factors, even in coastal areas.

To help retain the appearance of your PVD products for many years to come, a little periodic maintenance is required to remove any atmospheric deposits from the surface of the product.

- Once every two months clean the surface of the product thoroughly with a soft cloth moistened with light soapy water.
- To remove heavier deposits, a spot of non-abrasive kitchen cleaner may be used with a moistened cloth. Remove traces of water and cleaner and dry thoroughly with a soft cloth.
- When using any proprietary cleaner always follow the advice given by the manufacturers in handling cleaning materials.
- Do not use any abrasive cleaning materials or solvents when cleaning your PVD products.



Gallery Collection Hardware

Marvin Gallery Collection Hardware features designer handle sets from leading hardware manufacturers that compliment a wide variety of architectural and design styles. For care and maintenance recommendations, please consult the specific hardware manufacturer.

Bouvet® - www.bouvet.com

Rocky Mountain - www.rockymountainhardware.com

Ashley Norton® - www.AshleyNorton.com

Baldwin® - www.baldwinhardware.com

Lacquer Failure

The initial symptom of lacquer failure consists of tiny darkened spots on the brass. If tarnishing is allowed to continue, the brass will eventually acquire an overall greenish brown "antique" look which some people enjoy. To restore a bright brass appearance, the hardware must be stripped of any remaining lacquer, buffed to luster, then either relacquered, waxed or routinely polished.

Old lacquer can be stripped using very fine #0000 steel wool soaked in a light oil or soapy solution to reduce abrasion marks. Soaking the hardware in lacquer thinner might be necessary to loosen stubborn lacquer, but be certain the hardware contains no plastic parts, which the thinner will destroy. Then the brass can be polished either by hand with a soft cloth, or on a buffing machine, using brass polish or "wadding" compounds. Appropriate supplies can sometimes be obtained in kit form, such as Gillespie Refinishing Kit.

Do-it-yourself aerosol lacquers are seldom successful, and professional lacquers require very specialized equipment and facilities to be safely applied. The best lacquers are often two component "epoxy" type and are applied by opposite electrostatic charges on the metal and spray equipment. Special air cleaning, fume evacuation and explosion proof equipment is needed. A number of commercial plating or metal refinishing shops can be found in most large cities, and are apt to have the necessary equipment and experience to refinish your hardware. After re-lacquering, the hardware should be waxed just like new hardware.

Screens, Interior Shades and Energy Panels

Screen Maintenance

If you live in a cold climate, it is recommended that during the winter months, you remove any exterior screens to avoid snow and ice from collecting, causing the mesh to sag.

The most effective method of cleaning the screens on your windows and doors is to remove the screens, lay them on a flat clean area (such as a sidewalk), and spray off any dust or debris with water from your garden hose. Allow the screens to completely air dry before replacing in the window or door. Contact your Marvin dealer if you require assistance with screen replacement.

Attention

Marvin screens are designed to stand up to everyday use. However, these screens are not intended to act as a safety device. Every screen installed on Marvin products has a non-removable label affixed to it that states the following: "WARNING: Screen will not stop child from falling out window. Keep child away from open window."

NOTE: Certain size screens have a factory bow in the frame; this is to ensure a snug fit and is NOT a defect.

Window Screen Removal and Installation

Some screens utilize screen lifts located on the bottom of the screen. To remove the screen, simply pull up on the screen lift and pivot the screen toward you from the bottom and remove. Release tension and guide the screen from the window. To install, reverse the procedure.

Other screens utilize a plunger pin system. To remove the screen, grasp the plunger pins and pull inward until the pins clear the screen lip on the frame cladding. On the Clad Ultimate Double Hung, push the screen outward, grasp the screen frame and pull down slightly. Turn the screen sideways and bring it into the dwelling. To reinstall the screen, place the screen sideways through the window frame, turn to an upright position and place the top plunger pins against the screen lip at the head jamb. Pull the screen toward the interior, holding the plunger in the open position. Once flush against the frame, release the plunger to lock against the screen lip.

NOTE: For easier removal of the screen, Marvin recommends that you remove the operating sash on double hung units.

Wood Swinging Screen - Windows

For information on how to install or remove the Wood Swinging Screen, please refer to the Marvin Push Out Casement Wood Screen Installation Instruction (part number 19970098) on www.marvin.com.

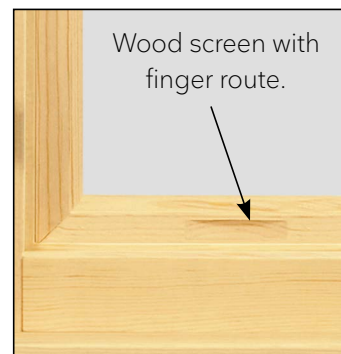

Screens for Modern Windows

The Modern Casement and Awning windows have two screen options.

For the Crank-out windows, a lift-in screen will be available. To insert the screen, place the bottom of the screen into the window first and then tip the top in. Activate the latches to keep the screen in place.

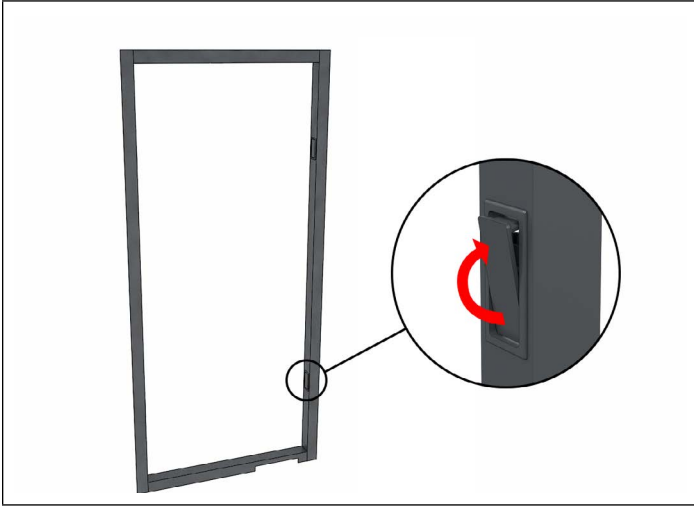

For the push-out windows, a swinging screen is available and is hinged on the frame of the unit. Activate the latches (as shown above). Then grip the screen frame to open the screen. To close, ensure the latches are open. Then swing the screen back into the window frame and close the latches.



Retractable Screen - Ultimate Double Hung Next Generation

To operate the Retractable Screen on the Next Generation Double Hung product, grasp the pull bar with one hand placed on both ends of the pull bar. With a downward motion, pull the screen down to the desired latch point, at the check rail or sill. Latches will bypass the check rail latch point when pulling the screen down.



To return the screen to the concealed position, retract the latches, by pulling inwards on the finger tabs, at both ends of the pull bar simultaneously. Lift the pull bar past the latch points at the sill or check rail. Latches must be fully retracted at the sill and check rail latch points when lifting the screen up. Gently assist the screen to the concealed position by pushing the pull bar upward to the top of the unit.

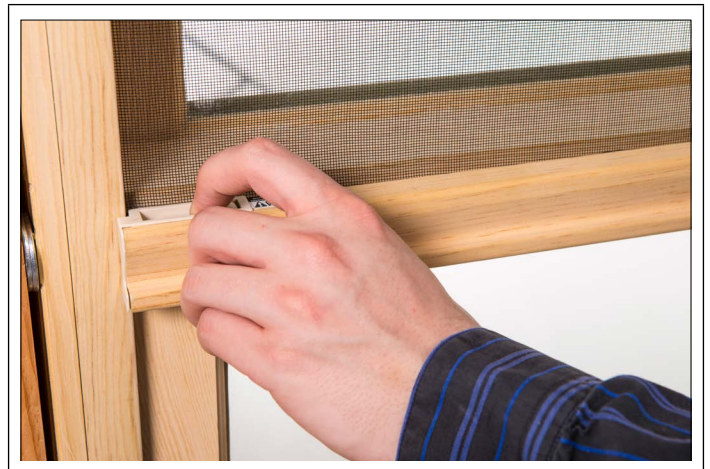

Retractable Screen - Ultimate Casement, Ultimate Awning

To operate the Retractable Screen on a Casement product, grasp the pull bar and slide the screen horizontally until the pull bar meets the opposite jamb. For an Ultimate Awning, the screen operates vertically from top to bottom. To close, slide the pull bar back to its original position.

For information on how to install or remove the Retractable Screen, please refer to the [Retractable Screen Installation and Service instruction](#) (part number 19970288) on www.marvin.com.



Interior Shade - Ultimate Casement, Direct Glaze, Double Hung, Sliding Door and Swinging Door

To operate the Interior Shade, grasp the pull bar with both hands and slide interior shade vertically on Ultimate Casement, Direct Glaze, Double Hung and Swinging Door. Grasp Sliding Door pull bar at handle height and move horizontally. To close, slide the pull bar back into its original position.

For information on care and cleaning of your Interior Shade please refer to the Marvin Interior Shade Care and Cleaning Instruction (part number 19915280).

For information on installing of your Interior Shade please refer to the Marvin Interior Shade Sliding Door installation Instruction (part number 19915668), Marvin Interior Shade Swinging Door installation instruction (part number 19915149), or the Marvin Interior Shade UCA/DG installation instruction (part number 19915147).

For any further information please refer to marvin.com.



Standard Swinging Screen - Doors

To remove the standard swinging screen door, first open the active screen panel and disconnect the autocloser. Remove the #6 x 1/2" (13mm) screw attaching the closer to the head jamb bracket. Then, remove the hinge pins from the active screen panel hinges, remove the panel from the hinges and store. On XX configurations, open the passive screen panel and remove the hinge pins in the same manner as the active.

Adjust the closing tension on your swinging screen door by loosening the two screws attaching the door bracket to the screen panel. Slide the bracket and closer left or right as needed and tighten the screws. Adjust the closing speed by tightening or loosening the adjusting screw located on the cylinder assembly.

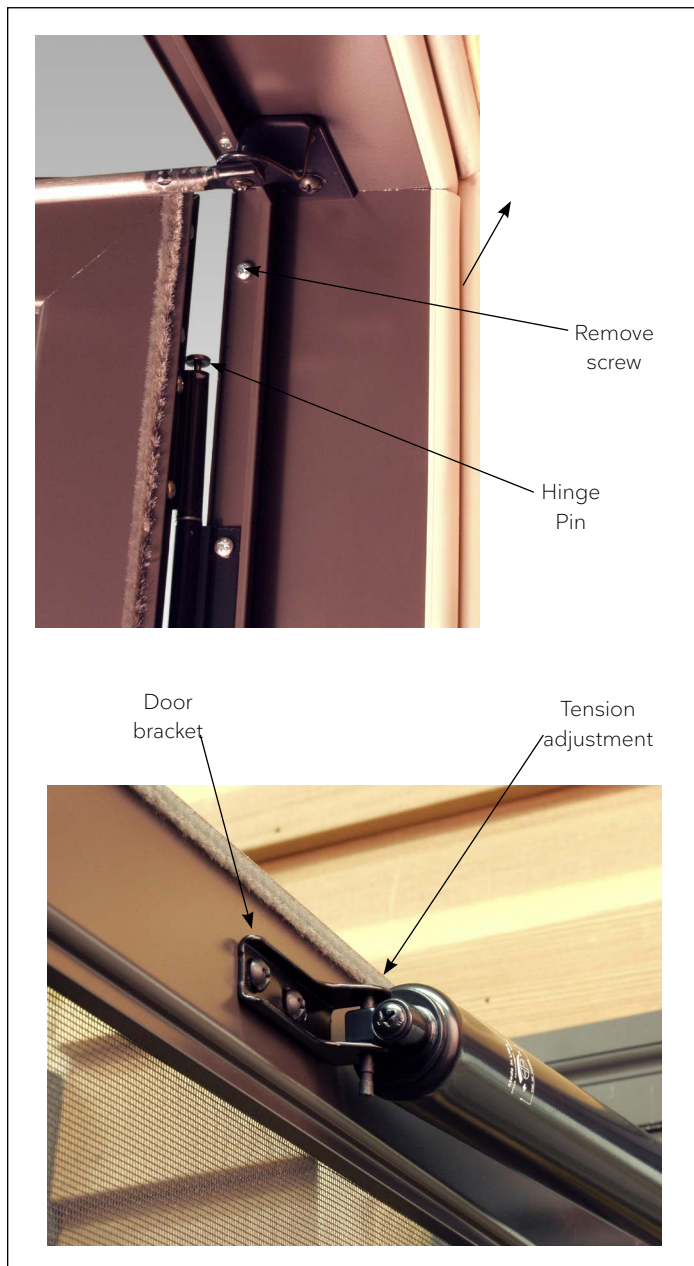

Ultimate Swinging Screen - Doors

The Ultimate Swinging Screen for Inswing Doors has a mesh screen option which can be removed and replaced by a storm insert. Directions on how to remove one and install the other can be found in the [installation instructions](#) (part number 19970256) or by visiting the [installation section](#) of the marvin website (www.marvin.com).



Standard Sliding Screen - Doors

To remove the Standard Sliding Screen panel, start at the bottom corner and pry the screen panel guide up with a putty knife. Pull the guide off the screen sill track and work your way to the other end. Once the sill end of the screen panel is completely released from the sill track, pivot the bottom of the screen out and push the panel toward the head jamb. This will release the screen panel rollers from the head jamb screen track. Remove the panel from the door.

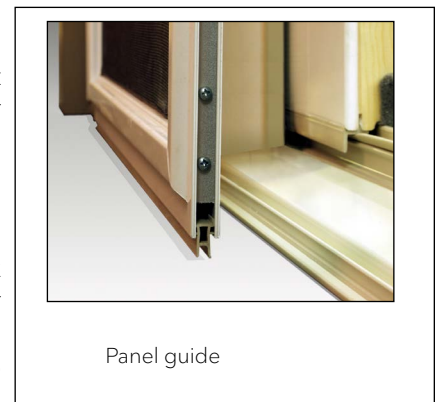

The screen can be adjusted from the interior by loosening or tightening the top roller screw nearest the locking jamb. Adjust the screen so that it is parallel to the locking jamb or casing. An even reveal should be achieved along the entire height of the jamb. If more adjustment is necessary, the other roller adjustment screw can be used but the screen panel will need to be removed for access.

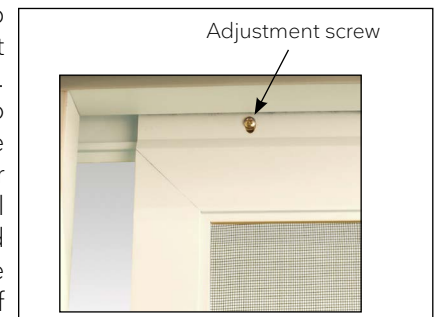

More information on how to install or remove the screen can be found in the [instructions](#) (part number 11701015) or by visiting the installation section of the marvin website www.marvin.com.



To watch a video on how to remove the standard sliding screen, log on to www.marvin.com and navigate to the video gallery. Or, scan this code with your smart phone or similar device.

Ultimate Sliding Screen - Doors

To remove the Ultimate Sliding Screen, simply remove the plugs from the screen track to reveal the access hole. Remove the screws attaching the screen to the roller bar and lift it off the guide.



Screen adjustment is possible by loosening or tightening the adjustment screw found in the roller bar assembly. Slide screen panel so that adjustment screw lines up with access hole. Turn the adjustment screw(s) counterclockwise or clockwise. An even reveal should be achieved along the entire height of the jamb. For detailed instructions on how to install the screen, see our [installation instructions](#) or go to our website www.marvin.com.



To watch a video on how to remove the Ultimate Sliding Screen, log on to www.marvin.com and navigate to the video gallery. Or, scan this code with your smart phone or similar device.

Wood Combination for Wood Inswing Door

A Wood Combination is a wood framed assembly containing an interchangeable storm panel and screen. This door is installed on the exterior of the Marvin Swinging French Door. For assembly and installation information see the [installation instructions](#) (part number 19970612) or visit www.marvin.com.

Energy Panels

Occasionally make sure that all fasteners on your energy panels are closed securely. Clean and maintain glass the same way as your other windows for regular interior and exterior care.

NOTE: Hard coat Low E energy panels require a cleaning solution of one part vinegar with ten parts water.

Lock Status Sensor

If you have any questions regarding our lock status sensor option, visit our website, www.marvin.com and search for “lock status sensor”.

Contact Marvin

If you are having a problem not explained in this manual, or if the solution seems inappropriate for your situation, contact your local Marvin dealer. If you are unsure who your local dealer is, visit our [website](#) and use the “Find a Dealer” locator tool in the upper right hand corner of the home page. While there, visit our [troubleshooting section](#) to find more information on your problem.

If you need help identifying the appropriate dealer or distributor, or if you feel the timeliness of the response was not adequate, please contact Marvin Windows and Doors to initiate the service request resolution. You may contact Marvin at 1-888-537-7828 or visit our website (www.marvin.com) and select “Contact Us”.

When contacting your Marvin dealer, please provide them with the “Customer Service Serial Number” etched on the corner of your Marvin window or door. Also if you know the approximate purchase date of your products, please provide that information as well.



Glossary

Below you will find a list of commonly used terms and their meanings as referred to by Marvin Windows and Doors.

ACTIVE PANEL - Primary operating door panel.

ALUMINUM SURROUND - The aluminum frame around a screen or energy panel.

ARGON GAS - A colorless and odorless gas used to fill the airspace between insulating Low E glass. The addition of argon greatly increases the insulating performance of the Low E glass.

ASTRAGAL - A moulding applied to one stile of a French Door, Sliding French Door or French Casemaster window unit which the other door panel or window sash strikes. Usually head and footbolt devices will be found on the astragal side.

ASSEMBLY - Single units mull together.

AUTHENTIC DIVIDED LITE (ADL) - Also known as True Divided Lite. Permanent stationary muntins and bars separate the glass in a window or door sash to give the sash two or more lites of glass.

AWNING - See "Ultimate Awning".

BALANCES - A block and tackle system used in the jamb liner of double hung or single hung units.

BAY WINDOWS - A series of windows installed in a "bay" which is two flanker units and a center sash; a "bay" may be an arc or a polygon; when a "bay" is or closely approaches an arc, the window is termed a "bow." See Bow Windows.

BOW WINDOWS - A series of adjoining window units, installed on a radius.

BRICK MOULD CASING (BMC) - An exterior moulding of window and door frames that abuts the exterior facing material of the structure. The casing serves as the boundary moulding for brick or other siding material and also helps to form a rabbet for screens and/or storm sash or a combination door.

CASEMENT - See "Ultimate Casement".

CHECK RAIL - Horizontal sash members that meet, as in double hung units. These could also be vertical check stiles, as in the glider or patio door

CLAD - Marvin clad products refer to wood window and door parts which are covered with an extruded permanent colored aluminum jacket on the exterior side of the frame and sash.

CLAD BRICK MOULD CASING (CBMC) - A clad extrusion designed to simulate brick mould casing for Marvin clad products.

CLAD INSERT DOUBLE HUNG (CINDH) - A specially designed, made-to-order sash and frame unit that is used to replace existing double hung sash and hardware in an existing frame - without disturbing existing interior trim or exterior casing. This product has many of the same features as the full frame Clad Ultimate Double Hung, including WDMA certification.

CLUTCH - The plastic and metal assembly on which the cam pivots of a double hung or single hung sash rest. The clutch is attached to the block and tackle system of the balance tubes which allow opening and closing of the sash. The clutches are color coded for easy identification of balance strength.

COMBINATION DOOR - A wood framed assembly containing an interchangeable storm panel and screen. The unit is installed on the exterior of the door, and is available for wood Inswing and Ultimate Inswing French doors.

COMBINATION WINDOW - A wood or clad wood frame storm sash with self-storing screen. Bottom glass panels such as those installed on a double hung unit operate by moving the plungers in and sliding the glass panel up to the desired position. Side

glass panels such as those installed on gliders slide to the left or right to the desired position. All inserts are removable from the inside.

COMMERCIAL DOOR - A door which specifically targets the non-residential market. This door comes standard with a 11 3/8" (289 mm) bottom rail and a 1/2" (13 mm) low profile sill allowing it to meet ADA codes.

COTTAGE WINDOW - A window with unequal sash, top and bottom.

DAYLIGHT OPENING (DLO) - The width and the height of the visible glass.

DESIGN PRESSURE - Is a rating system that is based on testing for structural performance under static air pressure. Water leakage, air leakage, operating force and forced entry must also comply to attain a DP rating.

DIRECT GLAZE - Refers to a window with no sash. The glass is glazed directly into the frame and is stationary.

DIVIDED LITES - See Authentic Divided Lites or Simulated Divided Lites.

DOUBLE HUNG - See "Ultimate Double Hung".

DOUBLE HUNG MAGNUM - See "Ultimate Double Hung Magnum".

EGRESS - Refers to an escape opening in a room designated as a sleeping area. Windows and doors must meet a minimum size requirement to qualify as an egress product.

ENERGY PANEL (EP) - Formerly called an RDG - removable double glazing, is a piece of glass annealed or tempered, and finished on the edges by a surround. EPs are applied to windows or doors and rest on the glazing stop. EPs offer the homeowner added energy efficiency.

ESCUTCHEON - A decorative door handle plate attached to the stile directly behind the handle(s). Generally square or rectangular shaped.

FLAT CASING - Flat, surfaced on four sides, pieces of pine of various widths and thicknesses for trimming door and window openings. The casing serves as the boundary moulding for siding material and also helps to form a rabbet for screens and/or storm sash or combination doors.

FOOTBOLT - A locking rod device installed vertically in the stile or astragal of a door or screen which when activated secures the panel or screen in a stationary position.

FRAME - The stationary portion of a window that encloses either the glass (direct glaze) or the sash (operating or stationary) and consists of the head jamb, sill and side jambs.

FRAME EXPANDER - A flat aluminum extrusion used in conjunction with the 90 degree frame expander to provide a flat casing appearance for clad units.

FRENCH DOOR - Marvin French Doors are available in either inswinging or outswinging rectangular or arch top style choices.

GLASS SIZE (GS) - The measurement of the actual glass, not the visible glass.

GLAZING - Installing glass into windows and doors.

1. **SINGLE GLASS** - Glazing with a single piece of glass.

2. **INSULATING GLASS** - two panes of glass separated by a spacer and hermetically sealed together with dead air space between the panes.

GLAZING BEAD - Strips of profiled wood or vinyl used to hold the glass in position in the sash. Wood glazing bead is attached to the rails and stiles of the sash using staples, small nails or vinyl barbs. A vinyl bead is held in place by extruded barbs positioned in the kerf. Aluminum caps may be used over the vinyl bead in some cases.

GBGs (Grilles Between the Glass) - Dividers placed between the panes of glass to simulate authentic divided lites.

HANDING - A term used to describe the right or left hand operation of a window or door.

HEADBOLT - A locking rod device installed vertically in the stile or astragal of a door or screen which when activated secures the door in a stationary position.

HEAD JAMB - The top frame member.

IG - Insulating glass (see Glazing)

INACTIVE PANEL - Secondary operating door panel.

INSWING FRENCH DOOR - See "Ultimate Inswing French Door".

INTERIOR CASING - The casing trim used on the interior perimeter of the window or door. Generally supplied by others except in the case of round top casing which is factory supplied.

JAMB EXTENSION - A jamb-like member, usually surfaced on four sides, which increases or extends the depth of the exterior or interior window or door frame; jamb extensions imply a larger depth than "wood jamb liners".

JAMB LINER (wood) - Thin strips of wood attached to the head jamb, side jambs and sill to accommodate various wall thicknesses. Common jamb depths are: 4 9/16" (116 mm), 4 13/16" (122 mm), 5 1/1" (129 mm) and 5 3/16" (132 mm).

KEYED CYLINDER LOCK - A lock providing an exterior entry and locking convenience.

LIFT AND SLIDE - See "Ultimate Lift and Slide".

LOW E GLASS - Low E stands for low emissivity. The lower the emissivity the higher the percentage of long wave radiation blocked thereby improving thermal performance. Low E glass is coated with a thin microscopic, virtually invisible, metal or metallic oxide layer. The primary function is to reduce the U-value by suppressing radiative heat flow. A secondary feature is the blocking of short wave radiation to impede heat gain. There are two basic "types of Low E glass. The first, vacuum or sputter coated Low E, is referred to as softcoat (See Low E II definition). The second is pyrolytic Low E, commonly referred to as hardcoat. (See pyrolytic definition.)

LOW E II (LoE²) - A high performance Low E glass, providing the best winter U value and warmest center glass. It offers significant improvement in reducing solar heat gain coefficient values providing customers one of the coolest summer glass temperatures of all Low E products. Additionally, ultraviolet light transmission is greatly reduced. The Low E II coated glass products are specifically designed for insulating glass units normally as a second surface coating. See Low E and pyrolytic definitions.

LOW PROFILE SILL - Also referred to as saddles, these sills have no more than a 1/2" (13 mm) rise. Low profile sills are required when a door opening must meet codes associated with the Americans with Disabilities Act.

MAGNUM HOPPER - A heavy duty window designed to tilt into the room for ventilation purposes.

MAGNUM INSWING CASEMENT - A non-tilting version of the Magnum Tilt-Turn.

MAGNUM TILT-TURN - A heavy duty window. The Magnum Tilt-Turn has hardware which allows the sash to either be tilted into the room for ventilation or swing into the room for egress or cleaning.

MULTI-LOCK HARDWARE - An adjustable lock system used on the French Casemaster to ensure a tight seal of the sash frame components. It also provides a secure locking system.

MULTI-POINT LOCKING SYSTEM - A line of standard or optional multiple point locking mechanisms installed on the operative

panel(s)/ sash of various Marvin products to enhance security and performance.

NAILING FIN - A factory installed vinyl strip that is inserted into a kerf in the frame of clad units. Nailing fin installation is the standard method used for installing clad units.

NON-KEYED CYLINDER - A handle without a keyed cylinder. The door cannot be locked from the exterior.

ONE-WIDE (1W)- The current term used to describe one frame with single or multiple sash or panels.

OPERATOR - An operating sash, panel or unit.

OUTSWING FRENCH DOOR - See "Ultimate Outswing French Door".

OX, XO and XX- The letters OX or XO identify the operation of window or door units as viewed from the exterior. The letter O stands for stationary while the letter X stands for operating.

PANEL - Either the stationary or operator wood frame with glass used on Marvin door products.

PART STOP - A strip of wood with weather stripping attached which prevents air and water infiltration. Part stops are commonly found at the head jamb of a double hung unit.

PASSIVE PANEL - See "Inactive Panel".

POLYGON - A high level term used to describe triangles, trapezoids, pentagons, hexagons and octagons.

PRIME - The first coat of paint in an application that consists of two or more coats; also refers to the paint used for such an initial coat - primer.

PYROLITIC LOW E GLASS (HARDCOAT) - Pyrolytic Low-E is designed to be used either in non-insulating applications such as energy panels that have exposed surfaces or for insulating glass applications. In some northern climatic situations where an application or customer requires increased solar heat gain, over Low E II performance, this is a desirable option. This increased solar heat gain which is desirable in winter may increase summer energy costs if the home is air conditioned. The pyrolytic coating is typically applied to the second surface, but can be applied to the third surface to provide increased solar heat gain.

R VALUE - The resistance a material has to heat flow. Higher numbers indicate greater insulating capabilities.

RADIUS - The length of an imaginary line from the center point of a circle to the arc or circumference of a circle.

RAILS - The cross or horizontal members of the framework of a sash, door or other panel assembly."

RETRO - Retro sizing refers to units which are sized for replacement purposes.

ROTO-GEAR - A term used to describe the steel drive worm, gears and crank device used for opening Awnings and Casements."

ROUGH OPENING - The opening in the wall where a window or door unit is to be installed. Openings are larger than the size of the unit to allow room for insulation and to shim the unit square.

ROUND TOP - Generally a semicircle window which is mulled to the top of another window or door, thus forming the round top appearance. There are full round tops, separated round tops, ellipticals, transoms, inverted corners, ovals and Gothic heads, etc. Round tops can be used separately or combined with other units to create a seemingly endless selection.

SASH - The operating and/or stationary portion of the window unit that is separate from the frame. The sash consists of stiles, rails and sometimes check rails.

SASH LOCK - A locking device which holds a window shut, such as a lock at the check rails of a double hung unit. Larger units utilize two locks.

SASH WIDTH - Horizontal measurement across the face of a sash.

SCREENS (full and half) - A close-mesh woven screen material of metal or fiberglass attached to an aluminum or wood surround. Screens inhibit entry of insects, yet permit light, air and vision. Most Marvin window and door products utilize full screens. Half-screens are available for single hung units.

SEQUENTIAL LOCKING SYSTEM - An exclusive Marvin design used on Casements for locking the sash to the frame. The action is sequential where the lower lock activates first moving the sash to the weather strip; the top then engages to snug the sash to the frame.

SIDE JAMB - Side or vertical frame members.

SIDELITE - A stationary glass panel muller to or installed next to a door.

SILL - The horizontal member forming the bottom of a window or exterior door frame; the lowest member of the frame of a structure, resting on the foundation and supporting the frame.

SIMULATED DIVIDED LITE (SDL) - Muntins permanently adhered to the interior and exterior of the glass.

SINGLE HUNG - A window very similar to a double hung window, except that the top sash is stationary or non-operable.

SLIDING FRENCH DOOR - See "Ultimate Sliding French Door".

SLIDING PATIO DOOR - A sliding door which features 3" stiles and rails.

SPACER - Used to separate the two pieces of glass in an insulating glass panel.

STATIONARY - A non-operating sash, panel or unit.

STILES - The upright or vertical perimeter pieces of a sash, panel or screen.

STORM SASH - A wood framed assembly containing non-removable glass. The storm sash is removed during the summer and replaced with a wood framed screen.

SUBSILL - The supplemental member used under most awning and casement units as an additional sill with the primary purpose being to hold multiple units together at the sill.

SURROUND - An attractive, protective trim which is secured to an energy panel by an adhesive or vinyl barb to give the glass panel a safe finished edge. Also the aluminum framework for most standard screens.

TEMPERED GLASS - Float glass panels heated and then cooled rapidly in a controlled environment. This process makes the glass several times stronger than regular glass. It also makes it safer because when broken it yields small pebble-like fragments.

THREE-WIDE (3W) - Current term referring to any product or unit when three frames (i.e. separate jambs) are muller together as a multiple unit.

TILT PAC - A specially designed made-to-order package which includes everything needed to replace double hung sash and hardware in an existing frame without changing the frame. This product has the same tilt feature as the Marvin Ultimate Double Hung.

TRANSOM - A window above a window or door. Transoms can be either stationary or operating.

TWO-WIDE (2W) - Current term referring to any product or unit when two frames (i.e. separate jambs) are muller together as a multiple unit.

ULTIMATE AWNING - A horizontally hinged window system consisting of a frame, sash weather strip, locks, hinges and an operating crank device on operating units. Push Out models are optionally available.

ULTIMATE CASEMENT - A vertically hinged window system consisting of a frame, sash weather strip, locks, hinges and an

operating crank device on operating units. Push Out models are optionally available.

ULTIMATE DOUBLE HUNG - Ultimate Double Hung windows have two movable sash which operate vertically. Sash are held in an open position with the use of coil spring block and tackle balancing devices.

ULTIMATE DOUBLE HUNG MAGNUM - Larger size Double Hung windows. Ultimate Double Hung Magnum windows have two movable sash which operate vertically. Sash are held in an open position with the use of coil spring block and tackle balancing devices.

ULTIMATE GLIDER - Horizontal operating window which can have one sash fixed while the other glides open and shut horizontally (OX or XO) or both sash can operate horizontally (XX).

ULTIMATE INSWING FRENCH DOOR - A french door with panels that swing to the inside. One, two, three and four panel units available as stationary or operating.

ULTIMATE LIFT AND SLIDE DOOR - A large sliding door available in Pocket or Stacked configurations. The Pocket panels slide into the wall while the Stacked panels slide and stack within the door frame.

ULTIMATE OUTSWING FRENCH DOOR - A french door with panels that swing to the outside. One, two, three, or four panel units available as stationary or operating.

ULTIMATE SLIDING FRENCH DOOR - A sliding door utilizing french door style panels with extra-wide stiles and tall bottom rails.

ULTIMATE VENTING PICTURE - An expansive picture window designed to open evenly on all sides, allowing for passive air exchange.

ULTREX[®] - A pultruded composite material made of polyester resin and glass fibers. This superior material is now being used in many Marvin products.

UNIT - One single product such as a one wide Casement.

VENTING OPENING - The total opening created when a door or window is completely open.

VENTING PICTURE - See "Ultimate Venting Picture".

WEATHER STRIP - A strip of resilient material designed to seal the sash and frame members in order to reduce air and water infiltration.

WOOD INSERT DOUBLE HUNG (WINDH) - A specially designed made-to-order sash and frame unit that is used to replace existing double hung sash and hardware in an existing frame - without disturbing existing interior trim or exterior casing. This product has many of the same features as the full frame Wood Ultimate Double Hung, including WDMA certification.

XO or XX - See OX entry.

Marvin
Warroad, MN 56763
1-800-346-5128
In Canada, call
1-800-263-6161
www.marvin.com

MARVIN® 

©2019 Marvin Lumber and Cedar Co., LLC. All rights reserved.
®Registered trademark of Marvin Lumber and Cedar Co., LLC
Printed in the U.S.A.
Specifications subject to change without notice. Part #19970893