

SPITFIRE AUDIO

MASSE

EXCLUSIVE TO SPITFIRE SYMPHONY ORCHESTRA
USER MANUAL

CONGRATULATIONS

Thank you for purchasing Spitfire Symphonic Orchestra including this, the ultra exclusive 'Masse' package. We hope that this product delivers on its key design brief, to offer instant satisfaction, inspiration and ultra-fast productivity to pro-level, no-nonsense composers. Whilst we're confident these instruments will simply plug in and play, please come back to this user manual to find out how to unlock further features and gems. Masse for many will be the entry point into symphonic orchestration. However once you really want to roll your sleeves up and get detailed with individual instrument groups or orchestral "choirs" be sure to check out their individual user manuals for insight into the instruments and how best to use them and orchestrate with them.

Quick Specs

- 72504 Samples (48k recorded at 96k)
- 102.8 GB uncompressed WAV
- 71.7 GB disk space required
- **143.4 GB disk space required during install**
- NKS Ready
- Compatible with Native Instruments hardware
- Free Kontakt Player Included
- New intuitive GUI with inline help
- Essential microphones (CTA)
- Deep sampled:
 - Multiple Instruments
 - Multiple Articulations
 - Multiple dynamics
 - Multiple round robins
 - Release Triggers

Table Of Contents

PRECAUTIONS	2
WELCOME	3
DOWNLOADING & INSTALLING	4
REGISTERING WITH KONTAKT PLAYER	5
FOLDER STRUCTURE	6
A QUICK LOOK	7
THE 'GENERAL OVERVIEW' PANEL	8
THE EXPERT VIEW	9
THE OSTINATUM	13
APPENDIX A - RECOMMENDED TECH SPECS	14
APPENDIX B - KONTAKT vs KONTAKT PLAYER	14
APPENDIX C I - ARTICULATION LIST	15
APPENDIX D - MIC & MIX ACRONYMS	15
APPENDIX E - FAQs & TROUBLESHOOTING	16

PRECAUTIONS

If you've never used a Spitfire instrument before there are two very basic principles to grasp. Once you've got these, you'll be up and running and ready to go. By all means read on, but the first two rules are:

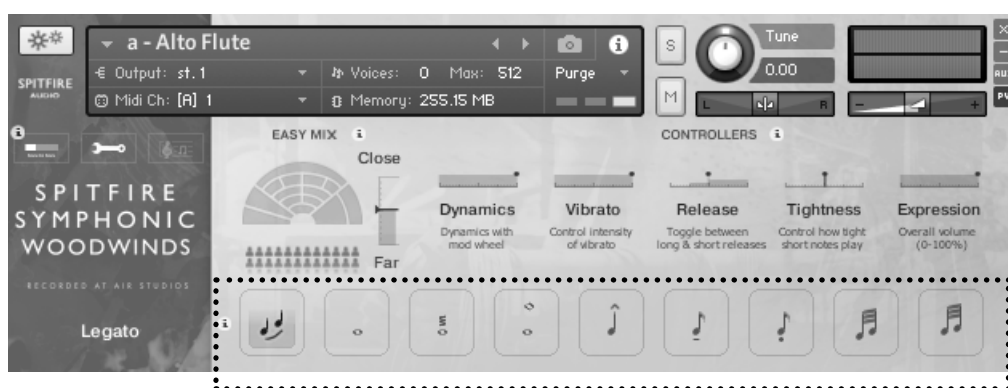

TOP TIP: The little 'i's on your GUI are 'inline' help. Click on these to find out stuff.

1.) Use these switches to change the articulations... they also correspond to keyswitches on the very bottom of your keyboard.

2.) On long notes make sure you always use your Modwheel

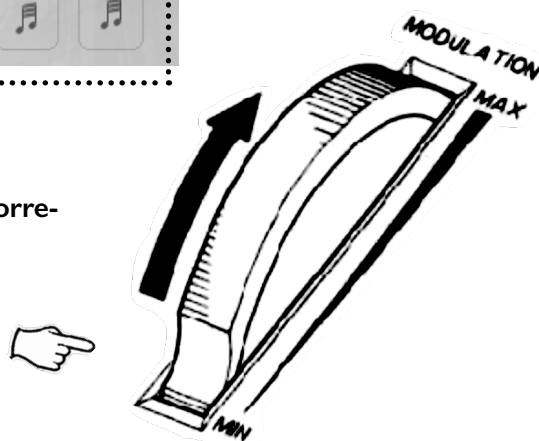

WELCOME

We're proud to present a set of super-exclusive ready-built orchestral patches for composers working at the frontline needing to hit that deadline. Designed by composers for composers, and featuring all three choirs of our symphonic orchestral project (brass, woods, strings), these patches have been carefully re-orchestrated, re-mixed and re-baked into a series of awe-inspiring, straight out-of-the-box mega-tools which are only available as part of the Spitfire Symphony Orchestra collection. Some of the ensembles within contain forces of over 300 players, designed for no-nonsense composers looking to get the job done.

A meticulously designed mega-epic instant orchestra created from re-orchestrating the best of our Symphonic Symphony Orchestra. A truly exclusive toolset only available to owners of SSO, this is designed for pros working at their limits needing a super car to get them across the finish line. Arranged and orchestrated by our award-winning composer team as no-nonsense single patches (ie. for two-handed use) with multiple and transformative dynamics controlled via CC#1 (modulation wheel) with particular studious attention to their responsiveness and playability. The ultimate writing tool for composers who don't hang around, don't take any prisoners, and don't get fazed by impossible scheduling demands. This will get the job done.

BACKGROUND

By unifying our previously modular orchestral range and combining the three choirs - brass, woods, strings - into a single entity we've allowed for some very special treats. We have taken the last half year re-orchestrating, re-sequencing, and re-baking this amazing world class content into a super epic instant orchestral project. Not simply a matter of whacking some instruments together into a multi and auto sampling, this project has been forensically programmed by our award winning team of composers and engineers. Masse is a curated selection of commonly used combinations of choirs, to oft requested cocktails of instruments through to some highly experimental approaches in patch creation. We have been using these presets and patches in anger for months, tweaking their feel, their responsiveness, their bite, so you can plug-in play and create impressive orchestral mayhem effortlessly, whether you're in your studio, or in a taxi on the way to the airport!

FEATURES

An orchestra of over 100 unique players layered to give up to 300+ musicians in a single patch.

Recorded to tape via sublime signal path at Air Studios, London
Meticulously implemented for ultimate playability and responsiveness

X presets

Multi Mic C(lose), T(ree), A(mbient)

Multiple Round Robins

Multi and "transformative" dynamics via CC#1 / Modwheel

Free Kontakt Player provided

NKS Ready for use with Native Instruments Hardware

Onboard bespoke lush reverb

Exclusive and only available to owners of SSO.

ARTICULATIONS

The articulations or playing styles are split into four instrument groups or 'orchestral choirs'.

TUTTI

The whole band carefully orchestrated and mixed. These are the biggest of the Masse selection. Instant enormous blockbuster symphonic orchestra straight out of your fingers.

BRASS

Carefully curated brass blends based on our 10 years experience in using these samples and knowing which combinations directors and producers like best.

WOODS

Again a meticulously arranged set of woodwind blends to help you unlock the riddle of these unsung heroes of blockbuster scoring.

STRINGS

Whilst SSO contains Symphonic Strings Ensembles (ie one string band across the keyboard). Masse is a more esoteric and instantly inspiring set of carefully orchestrated strings. By combining different playing styles to give you a beautiful set of strings writing pads, instant out of the box demo tools, and even some new ideas for you to consider.

DOWNLOADING & INSTALLING

Thank you for buying Masse. If you are a total newbie to this kind of thing you can get up to speed here:

<http://www.spitfireaudio.com/info/basics/>

First though, grab our 'Library Manager' app from this link: this app will enable you to download the library

<http://www.spitfireaudio.com/info/library-manager/>

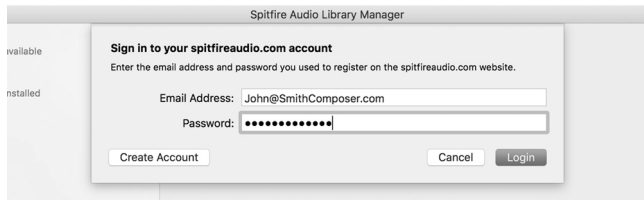

When you launch the app you will be prompted to login using the same details you use at our site. Then you'll see your available downloads:

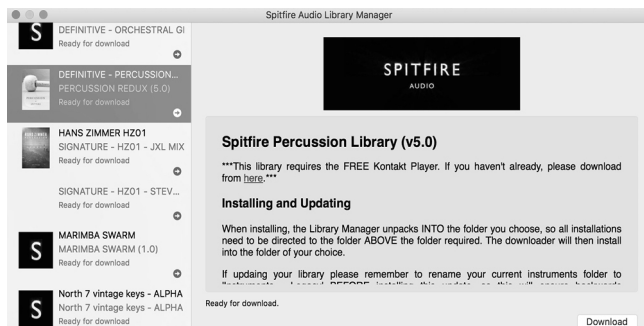

Once you have selected what you wish to download on the left pane, and clicked the 'download' button you will have the option to select a location.

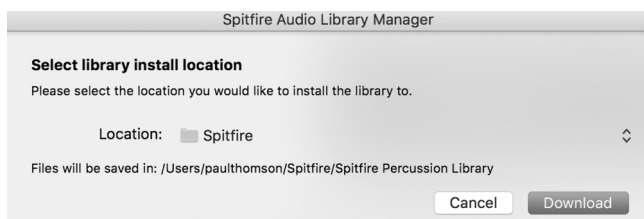

A default location will be generated but you'll most likely want to change this. Here's how! Click on the two little vertical arrowheads to the right of the default location. You will be presented with the following options, and you'll want to click 'CHOOSE'.

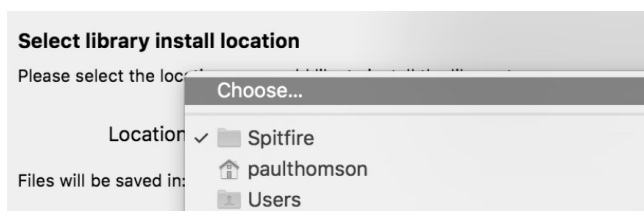

Once you've selected the location you can proceed with the download. **NOTE THAT THE DOWNLOADER WILL CREATE A SUB FOLDER FOR YOUR LIBRARY IN THE LOCATION SELECTED.** This is important: if you have a multi part library, or an update, it means that the Library Manager app will look **INSIDE** the selected location for your library folder. If its not there, it will create a new library folder. So, if you mistakenly select the actual 'SSW library' folder itself, when adding content or doing an update, instead of the location (one folder level up) that **CONTAINS** this library folder, you'll end up with a nested mess!!

TOP TIP: You will need approx **TWICE** the amount of hard drive space as the library uses (see the product page on our site for this info) to download: this is because the zip files are all downloaded, and then unzipped. This process takes a while so don't panic if it looks like its frozen!

TOP TIP 2: If you get in a total mess you can reset the download of either the whole library or just the latest update from the 'Library' menu of the app. This is limited to a couple of downloads as bandwidth is expensive! Please only do this if you actually need to.

You'll see an option also to Change Install Location, if you selected the wrong one, at any time you can hit the PAUSE button to pause the download, then select CHANGE INSTALL LOCATION and the app will move all the downloaded files to the new location. Once it has finished - you'll be prompted if you want to proceed, THEN you can hit the RESUME button to continue the download in the new location.

REGISTERING WITH KONTAKT PLAYER

If you've never used one of our libraries before and you don't own a copy of Native Instruments Kontakt, you'll need to download the free "Kontakt Player" here:

<https://www.native-instruments.com/en/products/komplete/samplers/kontakt-5/downloads/>

If you'd like to find out more about the differences between Kontakt and Kontakt Player (we know, very confusing!) go to *Appendix A*.

If you'd also like to know what we recommend as an optimal set up please go to *Appendix B*.

1. Install Kontakt Player (skip this step if you already have it)
2. Open the player (or Kontakt 5 full version if you have that) and click 'add library' in the library browser window:

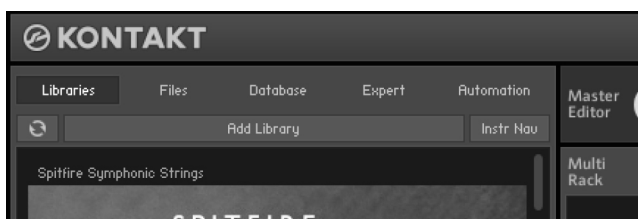

3. Navigate to and select the library folder, for example: the 'Spitfire xxx library' folder that contains your library's instruments and samples folders, and also contains the 'nicnt' file

4. Now, you have added the library to Kontakt, and you will be prompted to enter your serial number.

5. Enter the serial number in this format:

xxxxx-xxxxx-xxxxx-xxxxx-xxxxx

...It can be found in your 'ready to download' email.

6. Your library is authorised. If the library does not add to the libraries pane, or disappears when you re-open Kontakt, see *Appendix E - Troubleshooting and common problems*

If you have never used Kontakt before we wholeheartedly recommend that you familiarise yourself with the basics of patch (or instrument) loading, multi management, outputting and midi routing detailed in the Kontakt user-manual and native instruments website:

<https://www.native-instruments.com/en/products/komplete/samplers/kontakt-5/downloads/>

If you are an established Kontakt user please make sure you absolutely have the latest version of it downloaded via the NI service centre or the NATIVE ACCESS apps. Our libraries are

frequently updated and often simply won't work on any previous versions. We cannot describe the multitude of painful symptoms you will experience if you don't do this!

NKS - USE WITH NI HARDWARE

For more information about NKS and integration with Native Instruments hardware controllers and keyboards please check-out their online instructions:

<https://www.native-instruments.com/en/products/komplete/samplers/kontakt-5/downloads/>

FOLDER STRUCTURE



If you click the 'instruments' bar to expand it you will see that you have a 'basic' startup palette for each instrument section, plus the Ensemble. These are your basic patches which contain a selection of curated 'work-horse' articulations. Within this are five further folders. At the bottom is an 'Advanced' folder that has more folders which contain more curated articulation sets, the different legato options and patches with advanced editing possibilities.

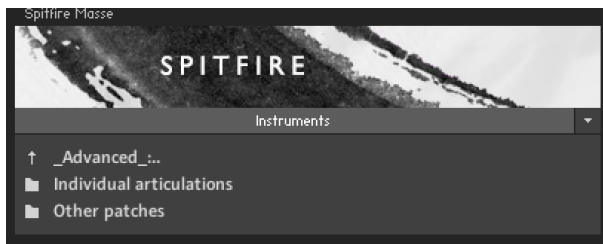

If you click the 'Advanced' folder to expand it you will see that your instruments fall into 5 categories. You can double click the folder name to open that folder. Double click it again to go back up a level in the folder structure.

Extended Techniques - contains 'core' and 'decorative' techniques for each section and can be viewed as the next stage in detail up from the 'basic' startup patches.

Individual Articulations - each separate articulation in its own patch.

Legato Techniques - these monophonic patches rely on you playing the notes 'joined up' so it can fill in the joins for you for super realism. Especially popular with single solo top lines.

Other Patches - Have another three sub-folders:

Economic - A pre-curated smaller selection of articulations which won't break your RAM bank.

Light - Stripped back articulations that reduce the stresses on your CPU.

Time Machine - These patches contain all of the short articulations fully loaded into RAM so that you are able to vary the length of the short notes via CC.

OPENING YOUR FIRST INSTRUMENT.

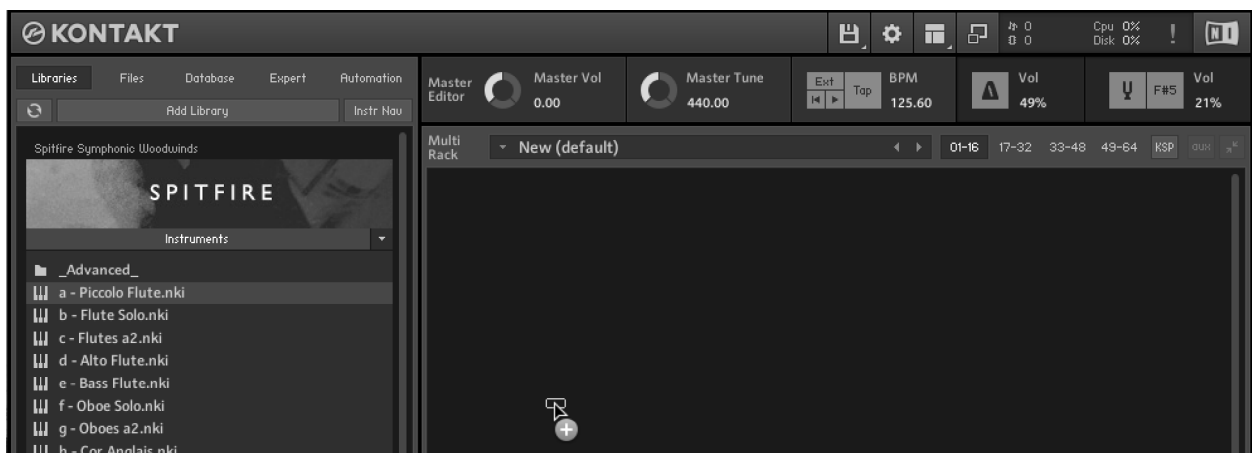

Simply double click an 'nki' file (this is Native Instruments' file extension for a Kontakt instrument) to load, or indeed drag the instrument from the left pane into the right pane.

If you can't hear anything double check first that the midi channel you are transmitting on with your keyboard is the same as the one in the Kontakt Instrument!

A QUICK LOOK

SWITCHING VIEWS



This large orchestra was recorded via priceless ribbon and valve mics via Neve Montserrat pre amps, the largest 88R Neve console in the world and onto pristine 2" tape before being converted with the top-of-their-class Prism AD converters at 96k. The orchestra is presented in carefully orchestrated sections, sometimes in unison across the entire orchestral range sometimes in high low and middle sections. Alongside many 'work horse' long and short articulations are expertly prepared legato patches; a menu of effects and a huge selection of string runs. There are four mic positions (close, tree, outriggers & ambient) to load and mix to suit the type of music you're writing and the scale you want to achieve. Spitfire also provides a popular "ostinatum" designer that allows you to instantly create exciting, tense or action packed rhythmic passages.

When you first load up a Spitfire Orchestral preset you'll be greeted with this GUI. This is one of 3 pages that you can switch between using the **panel switcher**...

ASSIGNING CONTROLS IN KONTAKT

All GUI controls can be assigned a unique controller number so you can automate or adjust via an external controller (vital when playing in virtual Orchestral parts). To un-assign, assign or just to see what CC number is assigned to any control **RIGHT** or **CTRL CLICK**.

You can then alter the controller parameters in the "Automation pane" want your mod wheel to go all the way from top to bottom but the control to have restricted bandwidth change default of 0-127 to 20-100 say. Or if you want the controller to make the GUI control in the reverse direction change from default 0-127 to 127-0.



Click on these to switch views or pages:

1. **General Overview** (the view shown above)
2. **Expert View**
3. **Ostinatum**.

All of which are discussed in more detail over the next few chapters...

THE 'GENERAL OVERVIEW' PANEL

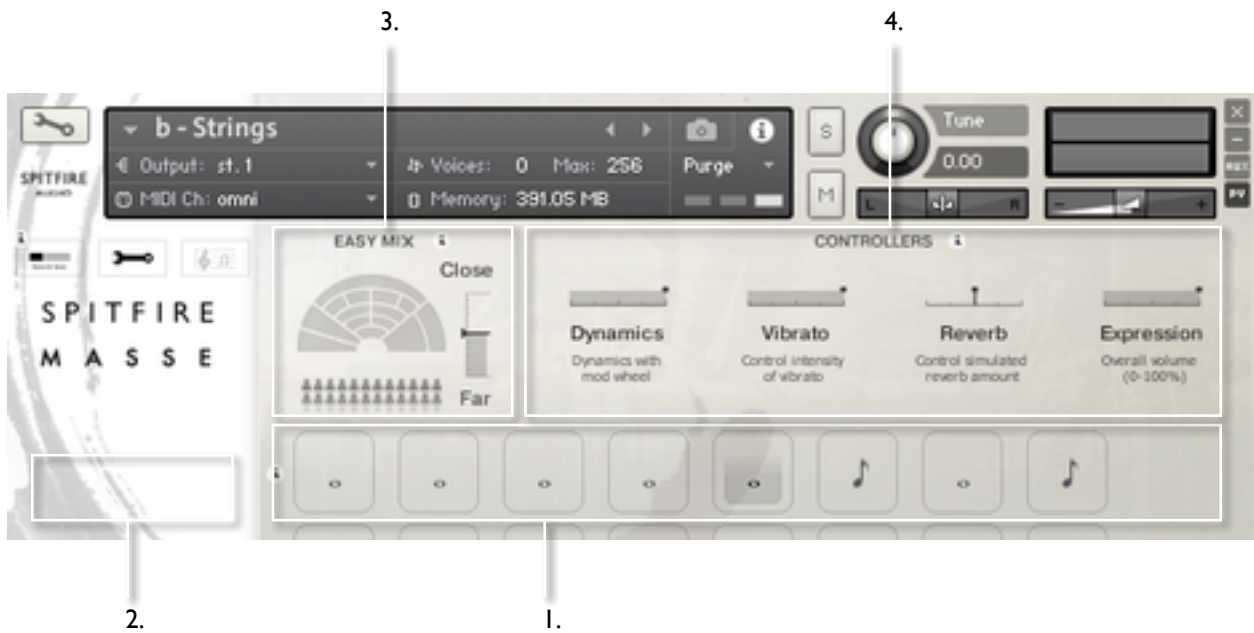

1. ARTICULATION SWITCHER

The notes denote key articulations, display the current articulation playing and act as switches between them (alongside their associated keyswitches at the bottom of your keyboard).

If what you're playing stutters, or feels delayed or cuts out make sure everything is loaded, as some of these articulations are very deep sampled.

LOAD STATUS:

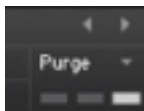

Make sure Kontakt displays the instrument load status as pictured. If the left hand bar is illuminated and red it's in a queue and hasn't started loading yet, if the middle bar is lit and yellow the instrument is still loading up. If you try to play before it's loaded it may not be nice!

ARTICULATIONS - Click on these notes to select the different articulations, whatever articulation is live is displayed in the yellow sidebar on the left. You can also select different articulations by hitting key switches, you can do this whilst you're playing so if you want to say switch from a "long" articulation to a short, hit the key whilst you're playing your last long and the next note will be a short. For details of articulations recorded go to Appendix A.

POWER TIP: *SHIFT > CLICK* to select and play multiple articulations!

2. SIDE BAR

Tells you what articulation you're playing.

3. EASY MIX

The orchestra was recorded with several different mic perspectives. Move this slider up or down to change the perceivable distance from the band. NB: the first time you use this it will need to load in the samples, so give it a moment!

4. EXPRESSIVE CONTROLLERS

Dynamics - probably the most important controller you have. This crossfades between the different dynamic layers recorded.

Vibrato - where appropriate this crossfades from no (or senza) to lots (molto) vibrato.

Release - allows you to change the amounts of release trigger you and your listener hears.

Tightness - the start of a note is often not the start of the 'sound' of the instrument. This cuts further into the note to make it tighter. But does detract from realism. Worth tightening up when playing in, then loosening and putting a negative delay into your DAW to compensate for ultimate reality!

Expression - ostensibly instrument trim (CC11), so this adjusts the volume within the instrument volume (CC7) great when used in conjunction with expression.

THE EXPERT VIEW

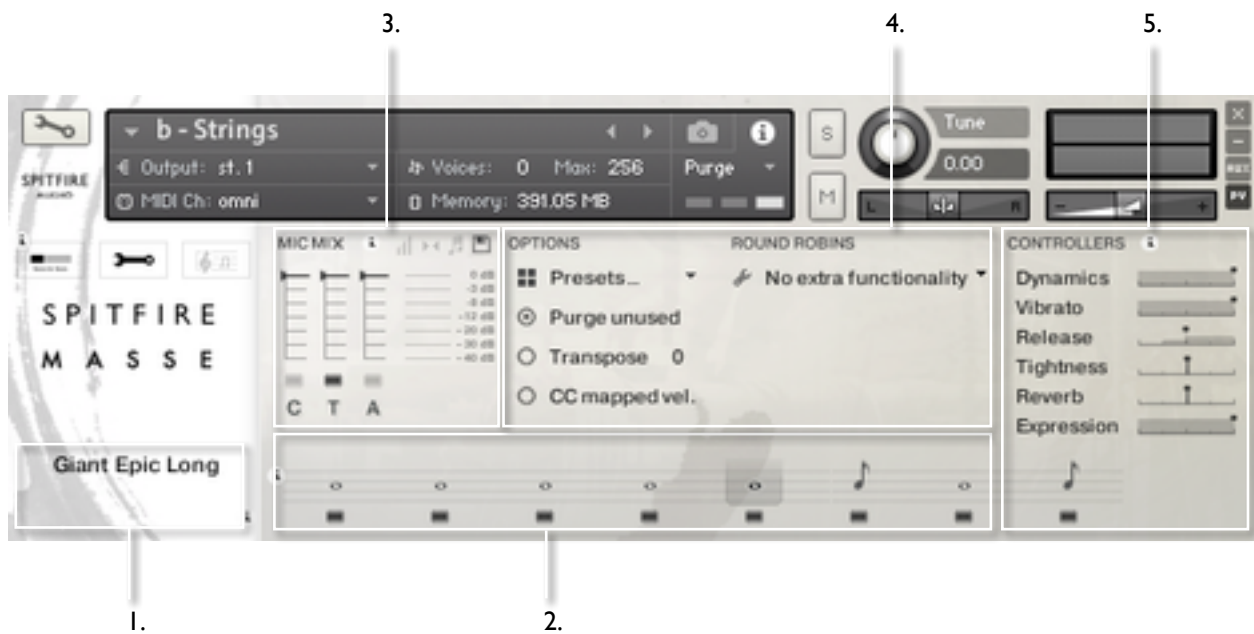

I. SIDE BAR

On the 'General Overview' page this simply displays the articulation being played. In the 'Expert View' there are some additional functions:



I a. THE COG - a. The Cog - Awesome tool for fine tuning & tweaking your presets.

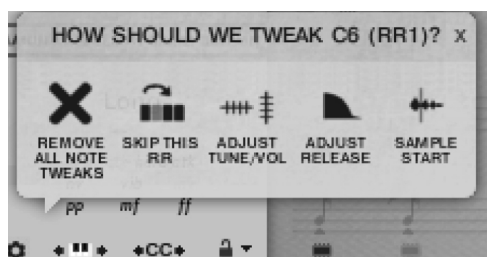

- **HOW SHOULD WE TWEAK?** - Then your last note played will be displayed, if this is correct get tweaking.
- **SKIP THIS RR** - Will simply make it always jump along to the next round robin in the cycle.
- **ADJUST TUNE/ VOL** - Will adjust the tuning and or volume of the last played note.
- **ADJUST RELEASE** - This will alter the level of the release trigger (which will effect the perceived decay of that note).
- **SAMPLE START** - If it feels loose adjust to the right, tight adjust to the left (NB this is only available in full "cog" patches).
- **REMOVE ALL NOTE TWEAKS** - This removes all custom changes you have made with the Cog.

I b. "KEYBOARD SHIMMIER" - This shifts your bank of keyswitches left or right to suit your needs, preference or performance. Simply click on the icon and drag your cursor left or right and you'll see the pink bank of keyswitches follow! Whenever you stop, those will be the new keyswitches.

I c. "KEYSWITCH TO CC SELECTOR" - Use this to assign a CC controller to act as articulation/ keyswitcher. Click on "CC" and you'll be prompted to move the controller you wish to use in order for the instrument to "learn" how you'd like to select articulations.

d. "ARTICULATION LOCKER" - We all like to select articulations and use our templates in different ways. Many composers like to have a single articulation loaded to each instance of an instrument for example. So it's worth locking off the articulation switching once you've selected one so you don't have sounds disappearing from slaves way off in your machine rooms!

Unlocked Artic' - Is the standard setting, select articulations via the front panel or associated keyswitch.

Locked Artic' - This locks your articulation so it doesn't change either via front panel or keyswitch.

Locked Keyswitch - This locks your articulation via keyswitch but you're free to switch via the front panel.

Locked to UACC - This is a new standard being developed by Spitfire and detailed in appendix E. The default controller channel is #32 but this can be changed by right/ CTRL clicking on the padlock.

Locked to UACC KS - The functionality of UACC with the flexibility of a keyswitch. When activated, a single keyswitch is available. Pressing this key at varying velocities (according to UACC standards) changes articulation.

Shared Keyswitches - In larger libraries, this setting allows you to spread keyswitches across multiple palettes of articulations.

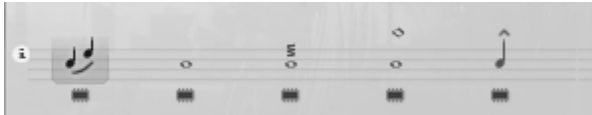

specify a triggering time-range in milliseconds. (See right hand menu above). For example, you could specify that ‘fast legato’ should be activated if the time between playing each interval is between 0 and 250ms (pictured above). Fully configurable to suit the user’s playing style and needs and can be deactivated by unchecking ‘Enabled’ (or if not in the artic switching screen, simply holding ALT/MENU and clicking the articulation icon on the stanza).

2. ARTICULATION SWITCHER

This works the same as it does in the ‘General Overview’ panel, with the addition of ‘load chips’ beneath each articulations. These load them in and out of memory as you wish... Remember before playing an articulation you’ve loaded in make sure it’s fully loaded!

LOAD STATUS

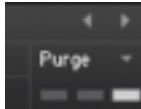

LAYERING ARTICULATIONS - To layer sounds within the articulation set simply ‘SHIFT’ click on your next articulation. Rather than introducing a multitude of more confusing ‘layered articulation’ options, the front panel shows (and edits) only the most recently layered articulation.

TRIGGERING - For triggering options CTRL or COMMAND click on the articulation icon:

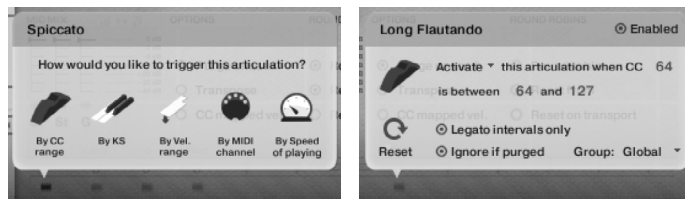

“By CC Range” - This will allow you to use a single controller channel to switch between artics. This allows you to fine tune on your MIDI event list, or to use a midi controller fader or indeed button with a single range assigned to select your desired artic. Our default setting is guided by our UACC protocol.

“By KS” - The default setting. BML is scripted so it won’t switch mid note but wait ‘til the next note-on event before switching. This means you’re able to play the key switch say whilst playing a long note and have it switch to a staccato on your next note.

“By Velocity Range” - This is great for designing intelligent staccato patches that say become staccatissimo when you hit the keyboard really hard. A second menu will open up giving you options for this function.

“By MIDI Channel” - Ingeniously turns your single instance of BML into a multi timbral instrument. MIDI channel lets the instrument change articulation based on the incoming MIDI channel. To use, pop the instrument Midi Ch. to ‘Omni’ mode in Kontakt. The single instance can now be configured to play based on the incoming MIDI channel. For example. Set staccatos to channel 1, longs to channel 2, legato to channel 3.

“By Speed Of Playing” - A revolutionary new function that allows you to switch articulations based on the playing speed of your performance. When selected, it provides options to

When an articulation has a ‘trigger’ assigned to it, it shows a little short-cut icon above to let you know that it has been customised.

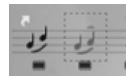

Holding down ALT/MENU (PC/MAC) and clicking an articulation with this short-cut above it will toggle the trigger between enabled and disabled.

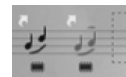

It’s a handy way to quickly turn off legato speed/velocity switching if the user doesn’t want it.

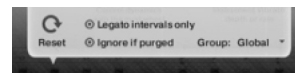

TRIGGER PANEL - Reset will clear the trigger for this articulation, allowing you to set it to a different type or disable it permanently. Legato intervals will only activate this trigger if the notes played are legato intervals. Ignore if purged means that this trigger will only occur if the articulation is not purged.

Group allows you to group together triggers. When set, the trigger only occurs when an articulation in the same group is currently active. For example, use this if you wanted to set up speed triggers on legato articulations, but don’t want them to trigger if you have staccatos/marc/shorts selected.

OTHER WAYS TO SWITCH ARTICULATIONS

Alongside switching your articulations manually by hand, via keyswitch or via the advanced methods mentioned above you may also want to try a new system we’ve dubbed UACC (universal articulation controller channel). Whereby each and every possible style of articulation has been given a unique CC data number. Simply use CC#32 and the table found in Appendix E to see how this can work for you.

POWER TIP: Whilst there are many ways to switch between articulations, many pros still prefer to have a different articulation in a single instance per track on their DAW. This enables them to assign different reverb levels and bake helpful stems that can be used in conjunction with live instruments (to work like this it’s best to load up artics from the individual articulations sub folder).

3. MICROPHONE MIXER

Giving you greater control over the blends of microphone positions for your work.

Use the chips beneath the faders to load & unload different microphones and the faders above to tweak the balance of them. Turning a fader all the way down will also unload the mics, conversely turning the fader back up will reload. Left click on the faders to assign CC controllers so you can mix these live for fantastic shifts in the spacial nature of the samples. Right / Ctrl click on the mic letters to change Kontakt channel/output assignment.

On the top right of the mixer controller section are some deeper mixing options.

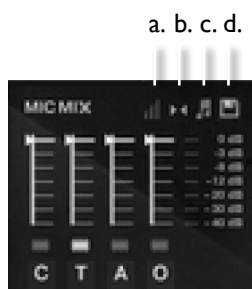

3a VELOCITY RESPONSE

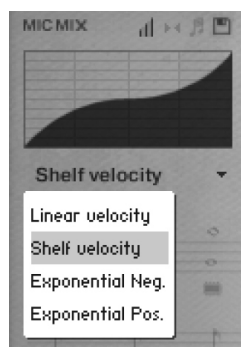

Pick from 4 different velocity curves to suit your controller.

3b CLOSE PAN MIC COLLAPSER

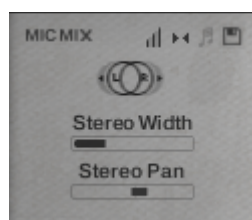

The close mics are a stereo mix and this collapser allows you to refine how the stereo image is handled. All our musicians are recorded in-situ, ie. where they would be seated on a standard scoring session, giving you a fantastic spectral spread when putting all the elements together, which helps define the detail. This panning tool helps you to manage and tweak this to your own tastes/ needs.

STEREO WIDTH - Allows you to control how far the stereo image reaches. All the way to the right would be like having your

two pan pots panned hard. All the way to the left would be like having both pots centre,

STEREO PAN - Then allows you to control where in the pan field the centre of this image is placed.

3c MIC MIX TO ARTICULATION LINKER

The small notation symbol locks the microphone mix or tweak you've made to the articulation selected. This means if you want to boost any perceived inconsistencies in volume between say pizzicato and col legno you can. Or indeed if you want to roll off some of the hall ambience for a short versus the long articulations this is how to fine tune.

3d MIXER PRESETS

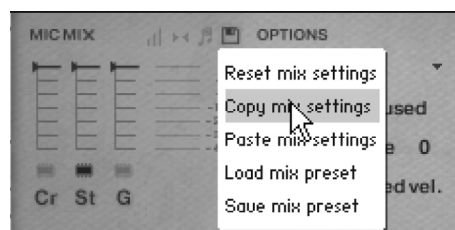

A new way to transfer mixer settings between patches, or save and load presets to disk.

AUTOMATING MIXER FADERS - Each mixer fader has a dedicated #CC. To change this to suit your MIDI controller or surface, simply right click (on PC) or command click (on Mac) on the fader itself to "learn" the new controller.

ROUTING MIC MIXES - To route each mic mixer channel to unique Kontakt channels simply click on the Mic acronym. Great for putting your ambient mics in the surround for example. Also good for tracklaying individual mics for your engineer to control in your final mix sessions.

4. GENERAL CONTROLS

OPTIONS

PRESETS - This allows you to load predetermined sets of articulations affectionately called articulation sets (see General Overview Panel) quickly and easily to optimise your system quickly for essential articulations or to start building templates using empty “shells”.

PURGE UNUSED - This control keeps unloading any samples you are not using to keep your memory usage as low as possible.

TRANPOSE - Toggle this on and tweak the number to the right to transpose your instrument. Note this is not the same as tuning, the instrument will actually offset the samples to the selected pitch. A great way to “track up” BML and make it sound bigger!

CC MAPPED VEL(OCITY) - Click this to control note velocity with the Dynamics slider. If a user has customised the dynamics slider, that same customised CC will control velocity now.

ROUND ROBINS & LEGATO

NO EXTRA FUNCTIONALITY(NEIGHBOURING ZONES)- Next to this lies a pop-down menu with some amazing new functions:

- **“No extra Functionality”** - Is the standard default where round robins are used as they were intended.
- **“Neighbouring Zones”** - pulls from neighbouring zones, so for an ‘8RR’ instrument, you effectively cycle through up to 24 different sounding notes when pressing a key. It’s still just playing the one RR at a time, though giving you more of them. In legato mode this also alternates between 3 legato intervals to give a fake round robin.
- **“2x Round Robin With Skip”** - plays two RR simultaneously, so you get a thicker sound, it’s the equivalent of plopping two notes on top of each other in your DAW (and it drops the overall volume ~6db so that the levels remain the same but it just sounds thicker). NB THIS IS NOT AVAILABLE TO LEGATO TRANSITIONS. This plays the pairs and moves ahead by 2 RR. In this mode RR is effectively halved. eg, if you press a note it would play RR1/RR2 then RR3/RR4 ,etc.
- **“Layer 2x Round Robins With No Skip”** - As above but this plays a pair but doesn’t move ahead by 2 so that RR isn’t halved. So if you press a note it would play RR1/RR2, then RR2/RR3, then RR3/RR4.

ROUND ROBINS - This refers to the number of round robins (multiple recordings of the same notes that cycle around as you repeatedly play a note) your instrument uses, the number can be dragged up and down (1-8) to save you memory.

RESET FROM F0 - This enables you to control the round robin cycle (so it sounds identical every time you play) toggle on & play the key selected (default F0) to reset.

RESET ON TRANSPORT - As above but resets every time you press play! Genius!

SHORT ARTICULATIONS RT - This new option allows you to toggle whether staccato/tenuto/marcato notes have a release trigger that plays on release. This lets you tighten up staccatos or end marcato/tenutos earlier than they were recorded.

5. EXPRESSION CONTROLS

We curated some of these for the general controls view, here is the full complement, dial these cc’s into your midi controller for an infinite choice of emotional and human responses.

DYNAMICS - CC#1 This slider displays and controls which dynamic layer is live. Also controlled via the modulation wheel.

VIBRATO - CC#21 This mixes between vibrato and non, or senza vibrato.

SPEED - CC#16 Controls legato interval speed. Great to use when playing the lines into your DAW for more responsive less laggy control. Dial back on playback for greater realism.

INTENSITY - CC#15 This is a great way to vary and humanise the legato articulations. Dial it all the way up for a more pronounced emotional start to each note, dial it back for a more transparent transition.

RELEASE - CC#17 Dialled in all the way, this helps blur the transitions when using long articulations in slow passages in a natural and musical way. Dial back for more focus and detail..

TIGHTNESS - CC#18 We proudly cut our samples from the true beginning of the note, as the bow engages the string and the rosin begins to weave its magic. The net effect of this is laggy and sometimes very small inconsistencies in timing. Which we love! It Sounds real! But it’s not to everyone’s taste. This ingenious device allows you to tighten and loosen to your heart’s content. An excellent use of this is to dial it all the way to the right in order to play your part in. Once you’re happy, adjust to taste and put a negative delay in the track header of your DAW which is the same amount as the Tightness setting.

EXPRESSION - CC#11 Displays the overall instrument volume (0-100%). Remember you can also trim your instrument volume with CC#7.

THE OSTINATUM

Best used with short articulations, this ever evolving device can offer instant chaotic inspiration or be used to create scientifically designed rhythms, ostinati and arpeggiated sequences as well as shimmering tremolando effects.

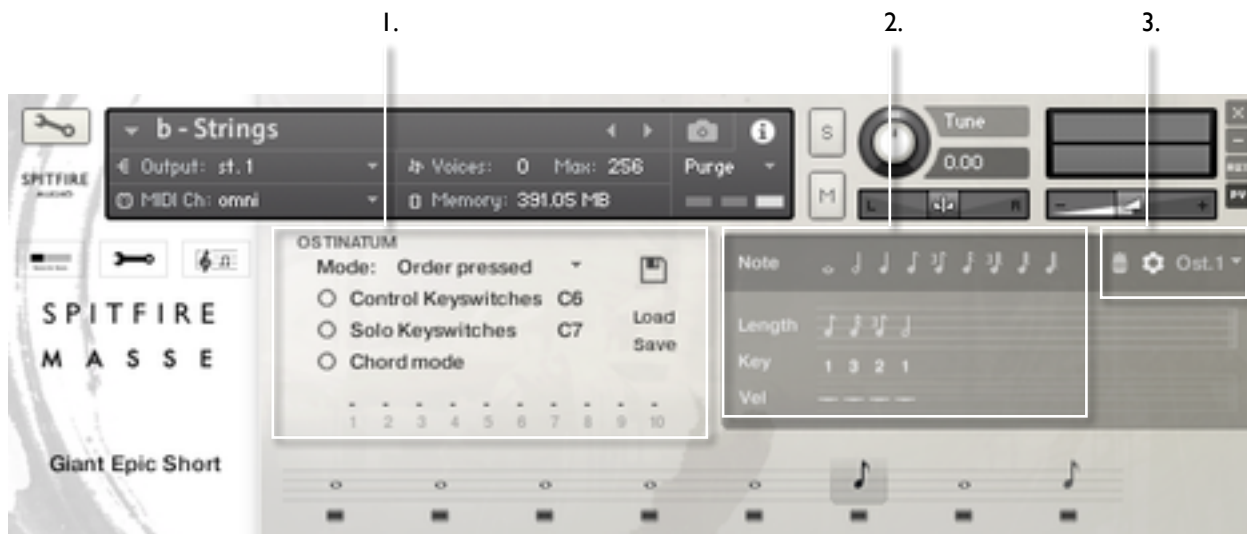

1. SETTINGS

MODE - Selects how the Ostinatum will interpret your playing. Ostinatum will sequence a maximum of 10 notes (one for each of your fingers). It needs to arrange them into a note order "1-10" and this determines how it does that.

OFF - The default position Ostinatum remains dormant.

ORDER PRESSED - This will organise the notes in the order you pressed them.

ASCENDING - From bottom to top.

DESCENDING - From top to bottom.

CONTROL KEYSWITCHES - Allows you to set up a section of the keyboard that controls the state of the ostinatum. These keyswitch let you turn it off, or set the Mode.

SOLO KEYSWITCHES - Allows you to dedicate a section of the keyboard to keyswitches that solo each ostinatum track. The first keyswitch turns all tracks on, the following keyswitches solo each individual track.

CHORD MODE - This ignores any note order and simply plays everything polyphonically, great for measured trem style effects.

2. RHYTHM COMPUTER

NOTE MENU - Click these to place a note into the computer at the length you desire. Click the trash can to delete, or choose a preset from the drop down on the right. The cog allows you further fine tuning and configuration tools.

LENGTH - This displays the note lengths in sequence that you have selected from the Note Menu. Drag down here to create rest versions of the note length.

KEY - Under each note you can then select which key (displayed in real time in the Transport) this note is attached to. Scroll up and down to select.

LEVEL - Adjust these bars up and down to adjust the velocity levels of each notes, this will bring your rhythm sequence to life and provide you with all sorts of surprising syncopated accents.

LOAD/ SAVE - Allows you to store your previously made Ostinati.

3. PATTERN SELECTOR

With the Ostinatum machine, there's a dropdown on the rhythm computer allowing you to switch between (and create) up to 8 different patterns.

By default these layer on top of each other, but you can also configure them to be solo using either the Ostinatum track options:



Or using the 'solo keyswitch' option. With Solo Keyswitch, 9 new (customisable) keyswitches are added to the keyboard:



The very first one unmutes all tracks so that they play together. The next eight solo each individual track respectively. When you press them, everything but that keyswitch's track is muted.

The second image shows how you could programme crazy 16ths on track 1, lazy halves on track 2, and then keyswitch between them in your DAW.

APPENDIX A - RECOMMENDED TECH SPECS

IF YOU PLAN TO USE THIS LIBRARY WITH THE FULL VERSION OF KONTAKT PLEASE MAKE SURE YOU HAVE THE LATEST VERSION OF KONTAKT 5 INSTALLED.

RECOMMENDED SPEC:

The better your computer, the better the performance of any Spitfire module. But not to worry if you're not spec'd up to the hilt. All programs are provided with a set of parameters that enable you to dial back the CPU demands of any given patch. But moving forward, we're confident this module will keep your computer busy for many years to come! We recommend a combination of high processor speeds, a good chunk of memory and a devoted 7200rpm eSata, USB2 or 3, or Thunderbolt audio drive. The more memory you have, the less demand placed on your drive, and having a totally devoted drive gives you the chance to load less into memory and reduce load times. The higher the speed of your CPU, the more capable your computer will be to deal with some of the amazing, but complicated scripts we've written.

PCs:

We recommend Windows 7 or later (latest Service Pack, 32/64 Bit), Intel Core Duo or AMD Athlon 64 X2, 4 GB RAM (8 GB recommended).

MACs:

We recommend Mac OS X 10.10 or later (latest update), Intel Core 2 Duo, 4 GB RAM (8 GB recommended).

DRIVES:

USB2 or USB3, Thunderbolt, or eSata, 7200rpm. Ask your dealer for drives that are suitable for "AV use". If you can afford an SSD drive, this will massively increase the power of your system. Instead of 7-9ms seek time, the usual seek time is <0.1ms. These are fast enough to run a patch 'Purged' of all its samples, and they can load on the fly as you play the notes. You can also reduce your sampler's "pre-load" buffer tenfold meaning you'll be able to load enormous orchestral palettes into a single machine.

HOST:

The Kontakt 5 platform should work comfortably on most commonly found platforms and DAWs. As always make sure you're as up-to-date as you can afford! If your main DAW is not a newish machine, or has a limited spec, and you're planning on building or adding Spitfire to an already large orchestral palette, you could consider running your library independently of your DAW, either on your host computer (e.g. via Re-Wire) or on a slave device (e.g. via Midi or MOL). This will assist your loading times, and will allow your DAW to do what it does best, sort out all your note ons and note offs! We heartily endorse Plogue Bidule (<http://www.plogue.com>) as a virtual rack/ routing system.

APPENDIX B - KONTAKT vs KONTAKT PLAYER

Kontakt Player is a free version of the Kontakt sample playback engine available to download:

<https://www.native-instruments.com/en/products/komplete/samplers/kontakt-5/downloads/>

It works with libraries that the developer has paid a license fee for. Essentially, you've bought this playback engine along with your library.

The Kontakt player gives you full access to all the sounds and all the editable parameters on the front panel. Also, unlike non-Player libraries, these libraries will also have a banner that appears on the Kontakt Libraries pane.

If you want to go deeper into editing you'll need a full version. As you will already own the free Kontakt player and have bought one of our 'player' libraries you will be eligible for a discount upgrade to Kontakt via the NI website. See here for more details:

<https://www.native-instruments.com/en/products/komplete/samplers/kontakt-5/pricing/crossgrade-offer/>

If the library you want to use is NOT a 'Player' library (the majority of our libraries) then you need to buy the full retail version of Kontakt.

Then you can also load 'non-Player' libraries like some of our other ranges, Spitfire LABS, Harp, Piano, Harpsichord, Solo Strings etc. Please note that non-Player library instruments will not appear on the Kontakt libraries pane and so can't be added as a library as Player libraries need to be. Instead, these libraries will simply need to be loaded via the Kontakt files browser or alternatively you can add the library as a favourite to the Kontakt Quick Load window.

APPENDIX C I - ARTICULATION LIST

A - TUTTI:

- a - Tutti - Beast Long
- a - Tutti - Beast Short
- a - Tutti - Brass String Choir Long
- a - Tutti - Brass String Choir Short
- a - Tutti - Long
- a - Tutti - Low Brass String Stab
- a - Tutti - Low Wood String Stab
- a - Tutti - Nutcracker
- a - Tutti - Staccato
- a - Tutti - Woods String 1 Long
- a - Tutti - Woods String 1 Short
- a - Tutti - Woods String 2 Long
- a - Tutti - Woods String 2 Short

B - STRINGS:

- b - Strings - Cool Strings 1
- b - Strings - Cool Strings 2
- b - Strings - Cool Strings 3
- b - Strings - Cool Strings 4
- b - Strings - Giant Epic Long
- b - Strings - Giant Epic Short
- b - Strings - Ligeti Strings
- b - Strings - Mondo Plucks

- b - Strings - Slow Cool Strings 1
- b - Strings - Slow Cool Strings 2
- b - Strings - Slow Cool Strings 3
- b - Strings - Slow Cool Strings 4
- b - Strings - Slow Strings 1
- b - Strings - Slow Strings 2
- b - Strings - Super Slow Strings 1
- b - Strings - Super Slow Strings 2

C - BRASS:

- c - Brass - Beast Long
- c - Brass - Beast Short
- c - Brass - Choir Long
- c - Brass - Choir Short
- c - Brass - Power Long
- c - Brass - Slow Choir Long
- c - Brass - Slow Super Choir Long
- c - Brass - Super Choir Long
- c - Brass - Super Choir Short

D - WOODWINDS:

- d - Woodwinds - Beast Long
- d - Woodwinds - Beast Short
- d - Woodwinds - Chorus Long

- d - Woodwinds - Chorus Short
- d - Woodwinds - Light Short
- d - Woodwinds - Orchestrator Long
- d - Woodwinds - Orchestrator Short
- d - Woodwinds - Slow Chorus Long
- d - Woodwinds - Slow Orchestrator Long

MICS & MIXES

MICS

- Close
- Tree
- Ambient

APPENDIX D - MIC & MIX ACRONYMS

STANDARD ARRAY:

(which matches all core SSO products)

C - Close mics, a selection of valve mics placed for optimum focus close to the instruments. This mic control is great to add in for added definition and at times a bit of “rounding of sound”, in isolation it can be a way of achieving a more intimate or pop-music style sound.

T - Tree. This refers to the “Decca” tree of three mics placed above the conductors podium. In the case of Sable; 3 priceless vintage Neumann M50s. These are placed to give the ultimate sound of the band, the hall and are the default mic position that loads in with each patch.

A - Ambient. A set of condenser mics placed high up in the gallery away from the band. This mic position gives a massive amount of stereo spread and room sound over the band. Great mixed in with the other mics but also ideal fed to your Ls & Rs speaker sends for true surround information.

APPENDIX E - FAQs & TROUBLESHOOTING

Q: HOW DO I AUTHORISE A KONTAKT PLAYER LIBRARY ON A MACHINE NOT CONNECTED TO THE INTERNET?

You have to use the Native Instruments Service Centre. There is an offline system. Copy it over to the offline machine, add the library as usual, then run Service Centre - it will generate a file that they can copy back to the online machine. Its explained as you do it.

Q: HOW DO I DOWNLOAD AND AUTHORISE A KONTAKT FULL LIBRARY ONTO MY MAIN RIG IF IT ISN'T CONNECTED TO THE INTERNET?

Simply use our download manager on a computer that IS connected, transfer over either over your LAN or via a shuttle drive. No further authorisation is required.

Q: THE LIBRARY KEEPS DISAPPEARING FROM MY KONTAKT 'LIBRARIES' PANE OR I CAN'T ADD THE LIBRARY - IT FAILS EACH TIME I TRY?

This is a known Kontakt bug. Please contact our support team to obtain a small file which should enable you to workaround the problem.

Q: "NO LIBRARY FOUND" ERROR MESSAGE

If you are getting the error message "No Library Found" in Kontakt when trying to add a new library, it's because the product you have purchased isn't a "Player" library (also see appendix B) You will therefore need to load the files manually into Kontakt to load them. This can be done via the 'Files' browser, top left hand side of Kontakt, or by simply dragging the instrument files over the Kontakt window to load them.

Q: WHAT IS THE DIFFERENCE BETWEEN KONTAKT AND KONTAKT PLAYER?

See appendix B

Q: HOW CAN I REDOWNLOAD A PRODUCT?

With the continuous improvements to our Library Manager app, we have incorporated the ability to reset your own downloads, be it the entire library or the most recent update!

This can easily be done via your Library Manager app. To reset both your entire library download or the latest update;

Open up the Library Manager app and log in with your account email and password.

- Select the download you wish to re-download
- In the toolbar under Library > Reset Download > Entire Download/Latest Update
- This will reset your whole download/your latest update

You can repeat this process for any of the libraries you own.

Note that there is a limit to how many times you can reset your downloads in a certain time frame. If you do exceed your reset limit please get in touch.

Q: DIFFICULTIES IN DOWNLOADING / INSTALLING

Customers may find that they have some difficulties in the downloading process. If you find that you are having some trouble, please check the list below for possible causes.

- The formatting of your drive, if it is FAT32 this will cause errors, because there is a maximum file size with this format of 4GB and our download files will exceed this limit. To solve this problem, reformat your drive to a more modern format, or use a different drive. We recommend NTFS on PC and Mac OS Extended (journalled) on Mac.

- Free space on your hard drive, please allow at least double the space for the respective library. This is because your library is downloaded compressed, then uncompressed into a separate location, then the original is deleted. So briefly during install, there are two copies of the library on disk. To solve this problem use a drive with more space (the size you'll need during install is listed on the website page of the product you bought).

Other issues;

- Library Manager freezes in the "Extracting" stage for hours. This may be because our libraries are often very large files, and this is the stage where the compressed files are extracted and placed in their final locations on the hard drive. There could be hundreds of GB of content to unpack, so it really can take hours. If you're unsure whether it has crashed or is simply extracting files, visit the installation folder you chose when you started the install. If everything is working normally you'll see various files appearing in the folder (or one of its sub-folders).

- If you see a "Download interrupted" message may be caused by a change in IP, usually the case with people using a VPN, or people who for some reason started a download in one country and tried to resume it in another. In this case, please submit a support ticket and we can unblock you.

- If your download gets stuck and is continually cycling and not resuming, please get in touch with us, giving us as much detail as possible about your set up. It would be helpful if you can tell us: Your operating system, where you are downloading from (your country, and also whether you're at home or work), your ISP, and whether there are any proxy servers or firewalls between your computer and the internet.

Q: I'VE LOST MY INSTRUMENT FILES.

In some cases, instrument files may get lost when transferring libraries from one place to another, or if an update has gone wrong. If this happens, the best way forward is to re-download the library in question. It will ensure you will get all of the content you are missing

Q: I HAVE FAST INTERNET, WHY IS MY DOWNLOAD SLOW?

We have no direct influence on your actual download speeds, our libraries are hosted on Amazon S3 servers which are normally very quick but it may well be that at certain times of the day when traffic is particularly busy, your ISP may throttle your connection speeds.

We would advise you to leave your download running overnight as speeds should ramp up at less busy times. Our Library Manager downloader aims to use as much of the available bandwidth as possible to give you the quickest possible speeds, and may take several minutes to reach its peak.

Q: CAN I INSTALL ON MORE THAN ONE COMPUTER?

With our products you have two licenses. This means that you are allowed to download and install on two computers you own, say your main rig and your mobile rig. The best way to get your library on both of your machines is to copy it from one to another via an external HDD. It saves you from having to re-download the whole library again!

Q: CAN I TRY BEFORE I BUY?

No - it is not currently possible to demo our products.

If you go to our YOUTUBE CHANNEL you'll see many many walkthroughs containing detailed info about all our products -- you can hear them being played in real time with no smoke and mirrors!

Q: MY LIBRARIES ARE NOT SHOWING UP IN MY LIBRARY MANAGER

A handful of customers may find that when they log into their Library Manager, some of their previous purchased products do not show up in the 'Installed' section or in the 'Download Ready' section either. It may be that you have purchased these under another email address. Checking other possible email addresses for your previous purchases may help to find these missing products. If this is not the case, and these missing products were purchased a few years ago, please create a support ticket telling us your account email address, and any serial numbers you may have to go with these missing products. Our support team can also merge one or more accounts together if you'd like to consolidate all your purchases in one place.

The more information, the quicker we can get you back up and running!

Q: HOW DO I UPDATE MY PRODUCTS?

The main premise of downloading our products is that our library manager downloads into the folder you choose, so it is always good to choose the folder above where you want the download to go. The best file path for our products is something very simple, a long file path will cause errors as there is a character limit on how far the library manager to read. We advise a file path of something along the lines of:

Samples Drive > Spitfire Audio - always point the downloader to the folder 'Spitfire Audio' (or the folder above) for all downloads and updates.

When it comes to downloading / updating - if you have a folder called 'Spitfire Audio' always point the library manager to the folder Spitfire Audio - never go into this folder and choose the actual library in question.

Q: HOW DO I REDOWNLOAD THE LATEST UPDATE?

With the continuous improvements to our Library Manager app, we have incorporated the ability to reset your own downloads. This can easily be done via your Library Manager app.

Open up the Library Manager app and log in with your account email and password.

- Select the download you wish to re-download
- In the toolbar under Library > Reset Download > Latest Update
- This will reset your latest update

You can repeat this process for any other updates you wish.

If you do not see the option to reset your download in your Library Manager App, we would advise to download the latest version of the library manager from [HERE](#).

Q: I'VE BEEN WAITING AGES FOR MY DOWNLOAD LINKS...???

We run all our orders through a fraud checking process. The automatic fraud check takes 20 minutes (but can take up to an hour during a very busy period, eg. Black Friday), but if your order gets caught at this stage, we run a manual order check, and this can delay the processing of your order for up to 24 hours (though this would be a rare and exceptional case).

You should however receive an order confirmation email IMMEDIATELY upon placing your order. This confirms that your order has successfully been logged in our system and that your payment was successfully taken. Please check your junk folders before contacting our support. The message will come from do_not_reply@spitfireaudio.com if you'd like to add us to your whitelist.

Q: 'SAMPLES MISSING' ERROR MESSAGES

In some cases, samples files may get lost when transferring libraries from one place to another, or if an update has gone wrong. You may also get this error in some cases if you installed your library on a drive with just under the minimum necessary amount of space to install the library (remembering that you need **DOUBLE** the size of the final library to install successfully - see above). If this happens, the best way forward is to re-download the library in question. It will ensure you will get all of the content you are missing. For more information on how to re-download a product, please see the question above.

Q: CAN I DOWNLOAD ON A PC, THEN TRANSFER TO A MAC OR VICE VERSA?

All of our libraries are compatible on both PC and Mac computers (as they run inside Kontakt). You can download all of our libraries on either PC or Mac and they will work if you need to transfer them across to the other operating system. We advise to do this via copying which every library you want to move across to an external HDD, and then copying it to your other machine.

Q: HOW DO I DL PRODUCTS ON MAC OSX 10.6.8?

Our Library Manager only supports Mac OSX 10.7 and upwards. If you do not have a system with 10.7 upwards installed, or do not wish to update your system there is a way of creating an external boot drive that will work with our Library Manager app. Alternatively, you can download the library to any other Mac or PC that is compatible with the Library Manager and then simply copy everything over to your own machine. We suggest doing this via an External Hard drive.

Q: NON PLAYER INSTRUMENT OPENING IN 'DEMO' MODE?

If you are seeing the 'demo' button and your patches are timing out, it means you are trying to run a non-player library in the Kontakt Player software. You need to upgrade your Player to the full version of Kontakt. We try very hard to ensure at all stages of our website that everyone understands which libraries need full Kontakt and which need the Player only. Essentially our Player libraries don't need the full Kontakt because we have paid the license fee on our customers' behalf -- this is more financially viable on our higher priced libraries. If you have any of our Player libraries you can qualify for a discount on the full version of Kontakt see [HERE](#) for more information.

HOW TO BATCH RESAVE A LIBRARY

There are two main reasons to batch resave: Firstly it greatly speeds up the loading of patches once you have batch resaved them. Secondly, it can help you find missing samples and relink them to the patches so that you don't need to search every time you load a patch. Bear in mind that it can sometimes take a few attempts to batch resave, and if Kontakt crashes the first time you try, you could go into the instruments folder and batch resave a bit at a time -- go by sub folders for example, just to lessen the load on Kontakt.

Q: I WANT TO BUY A COLLECTION, BUT I ALREADY OWN 1 OR MORE OF THE PRODS IN IT

Our cart will intelligently deduct the proportional cost of any products you already own from the total price when you get to the checkout.

Q: I'VE LOST MY SERIAL NUMBER FOR PRODUCT ACTIVATION

Emails get misplaced and you might find that you are out of luck when you need to find a past serial number. The best place to find all of your serial numbers would be to log into your Native Instruments account [HERE](#), and traverse to the My Products, Serials, And Downloads section. Under there you will find all of your serial numbers, including your Spitfire Audio serial numbers. If you find that the serial number you are looking for is not there, please contact us with all of the relevant information.

Q: I HAVE FOUND A BUG

In some cases we can't squash them all and bugs shamefully make their way through. If you think you have found a bug, please contact us with all the relevant information;

- A description of the bug you have found
- A screencast (video) of the bug happening, or an audio example
- The exact patch name (or patches) in question and also the library giving us as much detail as possible will help us get to the bottom of the issue.

Q: WHAT IS THE NCW COMPRESSED FORMAT?

This is Native Instrument's new lossless compressed sample format -- we have managed to reduce the sample data pool by around 55% and this also shows a benefit in streaming for you, along with reduced hard disk space required.

Q: WHAT IS YOUR REFUNDS / RETURNS POLICY?

If you have NOT completed the download / installation process, then we CAN refund / return your product, please contact support with your account email address and order number so we can handle this quickly. If you HAVE completed the installation process (even if you've not yet registered your serial number), please see our EULA in regards to why we do not accept refunds and returns. We can refund hard drive orders up until the point when the drive is dispatched from our office. This is usually 2-4 days after you order.

Q: I'VE FORGOTTEN MY PASSWORD?

If you have forgotten your password, please see this link, and click 'Forgotten Password'. If at some point in the past you asked us to merge two or more accounts but have since forgotten, you MAY find that the forgotten password isn't working for the email address you asked us to merge FROM. In this case, please contact support with your name, and any email addresses you think we might know about, and we'll work out what has happened.

Q: VEP - CONTROLS / GUI HAS DISAPPEARED!?

You need to 'connect' the instance of VEP to your sequencer, and send it some MIDI - then the controls will reappear. Unless the instance of VEP is 'booted up' by actually connecting it, Kontakt will not complete the setup of the instrument which includes drawing the GUI.

© SPITFIRE AUDIO HOLDINGS LTD
MMXVI