

Mathematics in everyday life

A study of beliefs and actions

Reidar Mosvold



Department of Mathematics
University of Bergen
2005

Preface

This study is a Dr. philos (doctor philosophiae) study. The study was financed and supported by Telemarkforskning Notodden (Telemark Educational Research) through Norges Forskningsråd (The Research Council of Norway).

The study has not been done in isolation. There are several people that have helped me in different ways. First and foremost, I am immensely grateful to Otto B. Bekken for his advice and support during recent years. He has assisted me in taking my first steps into the research community in mathematics education, and without him there would not be a thesis like this.

I will also express my deepest gratitude to all the teachers who let me observe their teaching for several weeks, and for letting me learn more about their beliefs and teaching strategies while connecting mathematics to everyday life situations. It has been rewarding to meet so many of you experienced teachers. You are supposed to be anonymous here, so I am not allowed to display your names, but I thank you very much for having been so nice, and for having collaborated with me in such a great way.

I am grateful to Telemarkforskning – Notodden, for giving me this scholarship, and for letting me work where it suited me best. Special thanks go to Gard Brekke, who has been in charge of this project. My work with this thesis has been a pleasant journey, and I am now looking forward to spend some time working with the colleagues in Notodden.

I would also like to thank Marjorie Lorvik for reading my thesis and helping me improve the English language.

In the first part of my study I was situated in Kristiansand, and had the privilege of participating in one course in research methodology with Maria Luiza Cestari and another course with Barbara Jaworski. I feel lucky to have been given the opportunity to discuss my own research project in the initial phase with them. This was very helpful for me.

At the beginning of my project I spent an inspiring week in Bognor Regis, in the southern part of England. I want to give special thanks to Afzal Ahmed and his colleagues for their hospitality during that visit, and for giving me so many ideas for my project. I look back on the days in Bognor Regis with great pleasure, as a perfect early inspiration for my work.

I also spent some wonderful days in the Netherlands together with Otto. B. Bekken and Maria Luiza Cestari. There I got the opportunity to meet some of the most important Dutch researchers in the field. Thanks go to Jan van Maanen for great hospitality in our visit to Groningen and Utrecht, and to Barbara van Amerom for inviting us to the celebration dinner after we witnessed her dissertation defence, and to Jan de Lange and his colleagues at the Freudenthal Institute for giving us some interesting days learning more about their research and projects.

In the Spring of 2003 I was lucky to spend a month at UCLA and the Lesson Lab in California. Thanks are due to Jim Stigler and Ron Gallimore for opening the doors at Lesson Lab to make the study of videos from the TIMSS 1999 Video Study possible, and to Angel Chui and Rossella Santagata for assisting with all practical issues.

I would also like to thank Ted Gamelin and his colleagues at the mathematics department at UCLA for giving me some inspirational weeks there. Thanks are due to Carolina DeHart, for letting me participate in her lessons for teacher students, and to the people of the LuciMath group for all the information about this interesting project, and to Phil Curtis for letting me use his office while I was in Los Angeles. I remember the days of work in that office where I had the best possible view of the beautiful UCLA campus, with great pleasure.

I am immensely grateful for having been given the opportunity to meet and get to know some of the most prominent researchers in the field on these visits, and on conferences that I have attended.

Last but not least, I also express my deepest gratitude to my parents, for always having encouraged me and supported me in every possible way. I would also like to thank my wife, Kristine. Before I started working with my PhD we did not even know each other. Now we are happily married. The last years have therefore been a wonderful journey for me in many ways. Thank you for supporting me in my work and thank you for being the wonderful person that you are! Thanks also to my parents in-law for letting me use their house as an office for about a year.

Notodden, August 2004

Reidar Mosvold

Revised preface

During this process there have been many revisions to the original document, and it is difficult to list them all. The most significant revisions, however, have been the changes and additions made to chapters 6, 10 and 11. A chapter 1.6 has been added, and there have been additions and changes to chapter 2 as well as chapters 7, 8 and 9. Here I would like to thank the committee at the University of Bergen, who reviewed the thesis and gave me many constructive comments.

I would also like to thank my colleague Åse Streitlien for reading through my thesis and giving me several useful comments and suggestions for my final revision.

Many things have happened since last August. The main event is of course that I have become a father! So, I would like to dedicate this thesis to our beautiful daughter Julie and my wife Kristine. I love you both!

Sandnes, August 2005

Reidar Mosvold

Notes

In the beginning there are some general notes that should be made concerning some of the conventions used in this thesis. On several pages in this thesis some small text boxes have been placed among the text. The aim has been mainly to emphasise certain parts of the content, or to highlight a quote from one of the teachers, and we believe this could assist in making the text easier to read and navigate through.

Some places in the text, like in chapters 1.6 and 2.1, some text boxes have been included with quotes from Wikipedia, the free encyclopedia on the internet (cf. <http://en.wikipedia.org>). These quotes are not to be regarded as part of the theoretical background for the thesis, but they are rather to be considered as examples of how some of the concepts discussed in this thesis have been defined in more common circles (as opposed to the research literature in mathematics education).

The data material from the study of Norwegian teachers (cf. chapters 8 and 9) was originally in Norwegian. The parts from the transcripts, field notes or questionnaire results that have been quoted here are translated to English by the researcher. The entire data material will appear in a book that can be purchased from Telemark Educational Research (see <http://www.tfn.no>). This book will be in Norwegian, and it will contain summaries of the theory, methodology, findings and discussions, so that it can serve as a complete (although slightly summarized) presentation of the study in Norwegian as well as a presentation of the complete data material.

The thesis has been written using Open Office (<http://openoffice.org>), and all the illustrations, charts and tables have been made with the different components of this office suite. Some of the illustrations of textbook tasks as well as the problem from the illustrated science magazine (cf. chapter 8.10.3) have been scanned and re-drawn in the drawing program in Open Office to get a better appearance in the printed version of the thesis.

Table of contents

1 Introduction.....	1
1.1 Reasons for the study.....	1
1.2 Aims of the study	2
1.3 Brief research overview.....	4
1.4 Research questions.....	5
1.5 Hypothesis.....	6
1.6 Mathematics in everyday life.....	6
1.7 Summary of the thesis.....	11
2 Theory.....	15
2.1 Teacher beliefs.....	15
2.2 Philosophical considerations.....	19
2.2.1 Discovery or invention?.....	21
2.3 Theories of learning.....	23
2.4 Situated learning.....	24
2.4.1 Development of concepts.....	25
2.4.2 Legitimate peripheral participation.....	27
2.4.3 Two approaches to teaching.....	28
2.4.4 Apprenticeship	30
2.5 Historical reform movements.....	31
2.5.1 Kerschensteiner’s ‘Arbeitsschule’.....	32
2.6 Contemporary approaches.....	33
2.6.1 The US tradition.....	33
2.6.1.1 The NCTM Standards.....	33
2.6.1.2 High/Scope schools.....	34
2.6.1.3 UCSMP – Everyday Mathematics Curriculum.....	35
2.6.2 The British tradition.....	37
2.6.2.1 The Cockroft report.....	37
2.6.2.2 LAMP – The Low Attainers in Mathematics Project.....	38
2.6.2.3 RAMP - Raising Achievement in Mathematics Project.....	40
2.6.3 The Dutch tradition.....	43
2.6.3.1 Realistic Mathematics Education.....	45
2.6.4 Germany: ‘mathe 2000’	47
2.6.5 The Japanese tradition.....	50
2.6.6 The Nordic tradition.....	51

2.6.6.1 Gudrun Malmer.....	51
2.6.6.2 Speech based learning.....	52
2.6.6.3 Everyday mathematics in Sweden.....	54
2.7 Everyday mathematics revisited.....	56
2.8 Transfer of knowledge?.....	60
2.9 Towards a theoretical base.....	63
3 Real-life Connections: international perspectives.....	67
3.1 The TIMSS video studies.....	67
3.2 Defining the concepts.....	68
3.3 The Dutch lessons.....	70
3.3.1 Real-life connections.....	70
3.3.2 Content and sources.....	71
3.3.3 Methods of organisation.....	72
3.3.4 Comparative comments.....	72
3.4 The Japanese lessons.....	74
3.4.1 Real-life connections.....	74
3.4.2 Content and sources.....	75
3.4.3 Methods of organisation.....	76
3.4.4 Comparative comments.....	77
3.5 The Hong Kong lessons.....	78
3.5.1 Real-life connections.....	78
3.5.2 Content and sources.....	79
3.5.3 Methods of organisation.....	79
3.5.4 Comparative comments.....	81
3.6 Summarising.....	81
4 Norwegian curriculum development.....	83
4.1 The national curriculum of 1922/1925.....	83
4.2 The national curriculum of 1939.....	84
4.3 The national curriculum of 1974.....	85
4.4 The national curriculum of 1987.....	86
4.5 The national curriculum of L97	87
4.5.1 The preliminary work of L97.....	88
4.5.2 The concept of ‘mathematics in everyday life’	89
4.6 Upper secondary frameworks.....	93
4.7 Evaluating L 97 and the connection with real life.....	94
4.8 Curriculum reform and classroom change.....	98

5 Textbooks.....	99
5.1 The books.....	99
5.2 Real-life connections in the books.....	100
5.2.1 Lower secondary textbooks	100
5.2.2 Upper secondary textbooks.....	102
5.3 Textbook problems.....	103
5.3.1 ‘Realistic’ problems in lower secondary school.....	103
5.3.1.1 Realistic contexts.....	103
5.3.1.2 Artificial contexts.....	106
5.3.1.3 Other problems with real-life connections.....	107
5.3.1.4 Comments.....	109
5.3.2 ‘Realistic’ problems in upper secondary school.....	109
5.3.2.1 Realistic contexts.....	109
5.3.2.2 Artificial contexts.....	110
5.3.2.3 Comments.....	113
5.4 Comparison of the textbooks.....	113
6 More on our research approach.....	117
6.1 Research paradigm.....	117
6.1.1 Ethnography.....	119
6.1.2 Case study.....	120
6.2 The different parts of the study.....	122
6.2.1 Classroom studies.....	122
6.2.1.1 Planning meeting.....	123
6.2.1.2 Questionnaire.....	124
6.2.1.3 Observations.....	125
6.2.1.4 Interviews.....	128
6.2.1.5 Practical considerations and experiences.....	129
6.2.2 The TIMSS 1999 Video Study.....	130
6.2.3 Textbook analysis.....	130
6.3 Triangulation.....	131
6.4 Selection of informants.....	132
6.4.1 Teachers.....	132
6.4.2 Videos.....	133
6.4.3 Textbooks.....	134
6.5 Analysis of data.....	134
6.5.1 Classroom study.....	135

6.5.1.1 Questionnaire.....	135
6.5.1.2 Observations – first phase of analysis.....	135
6.5.1.3 Observations – second phase of analysis.....	139
6.5.1.4 Interviews.....	140
6.5.2 Video study.....	141
6.5.3 Textbooks.....	141
7 Questionnaire results.....	143
7.1 The questionnaire.....	143
7.2 The Likert-scale questions.....	143
7.2.1 Real-life connections.....	144
7.2.2 Projects and group work.....	145
7.2.3 Pupils formulate problems.....	146
7.2.4 Traditional ways of teaching.....	147
7.2.5 Re-invention.....	147
7.2.6 Use of other sources.....	148
7.2.7 Usefulness and understanding – two problematic issues.....	149
7.3 The comment-on questions.....	150
7.3.1 Reconstruction.....	150
7.3.2 Connections with other subjects.....	151
7.3.3 Problem solving.....	152
7.3.4 Content of tasks.....	152
7.4 The list questions.....	153
7.5 Comparison of teachers.....	154
7.6 Categorisation.....	157
7.7 Final comments.....	158
8 Three teachers: Their beliefs and actions.....	159
8.1 Curriculum expectations.....	159
8.2 Setting the scene.....	160
8.3 Two phases.....	160
8.4 Models of analysis.....	160
8.5 Brief comparison.....	161
8.6 Karin’s beliefs.....	165
8.6.1 Practice theories.....	165
8.6.2 Content and sources.....	166
8.6.3 Activities and organisation.....	167
8.7 Ann’s beliefs.....	168

8.7.1 Practice theories.....	168
8.7.2 Content and sources.....	169
8.7.3 Activities and organisation.....	169
8.8 Harry's beliefs.....	170
8.8.1 Practice theories.....	171
8.8.2 Content and sources.....	172
8.8.3 Activities and organisation.....	173
8.9 Into the classrooms.....	174
8.10 Harry's teaching.....	175
8.10.1 Fibonacci numbers.....	175
8.10.2 Pythagoras' theorem.....	176
8.10.3 Science magazine.....	178
8.10.4 Bicycle assignment.....	179
8.11 Ann's teaching.....	181
8.11.1 Construction of 60 degrees.....	181
8.11.2 Area of figures.....	182
8.11.3 Size of an angle.....	183
8.11.4 Blackboard teaching.....	184
8.12 Mathematics day.....	185
8.13 Karin's teaching.....	187
8.13.1 Lazy mathematicians.....	187
8.13.2 Grandma's buttons.....	189
8.13.3 If I go shopping.....	190
8.13.4 Textbook teaches.....	191
8.13.5 How many have you slept with?.....	191
9 Five high-school teachers: Beliefs and actions.....	193
9.1 Curriculum expectations.....	193
9.2 Questionnaire results.....	194
9.3 Models of analysis.....	198
9.4 Jane's beliefs.....	198
9.4.1 Practice theories.....	199
9.4.2 Content and sources.....	199
9.4.3 Activities and organisation.....	200
9.5 George's beliefs.....	201
9.5.1 Practice theories.....	201
9.5.2 Content and sources.....	202

9.5.3 Activities and organisation.....	203
9.6 Owen’s beliefs.....	203
9.6.1 Practice theories.....	204
9.6.2 Content and sources.....	204
9.6.3 Activities and organisation.....	204
9.7 Ingrid’s beliefs.....	205
9.7.1 Practice theories.....	205
9.7.2 Content and sources.....	206
9.7.3 Activities and organisation.....	206
9.8 Thomas’ beliefs.....	206
9.8.1 Practice theories.....	206
9.8.2 Content and sources.....	207
9.8.3 Activities and organisation.....	207
9.9 Into the classrooms.....	208
9.10 Jane’s teaching.....	209
9.10.1 Mathematics in the kitchen.....	209
9.10.2 Is anyone here aunt or uncle?.....	209
9.10.3 Techno sticks and angles.....	209
9.10.4 I am going to build a garage.....	210
9.10.5 Pythagoras.....	210
9.11 George’s teaching.....	210
9.11.1 Trigonometry and Christmas cookies.....	210
9.12 Owen’s teaching.....	211
9.12.1 Areas.....	211
9.13 The teaching of Thomas and Ingrid.....	212
9.13.1 Cooperative groups.....	212
10 Discussions and answers.....	213
10.1 Activities and organisation.....	213
10.1.1 Cooperative learning.....	213
10.1.2 Re-invention.....	215
10.1.3 Projects.....	218
10.1.4 Repetitions and hard work.....	220
10.2 Content and sources.....	221
10.2.1 Textbooks.....	221
10.2.2 Curriculum.....	224
10.2.3 Other sources.....	226

10.3 Practice theories.....	228
10.3.1 Teaching and learning.....	228
10.3.2 Vocational relevance.....	229
10.3.3 Connections with everyday life.....	231
10.4 Answering the research questions.....	235
10.4.1 Are the pupils encouraged to bring their experiences into class?.....	235
10.4.2 Do the teachers use examples from the media?.....	235
10.4.3 Are the pupils involved in a process of reconstruction or re-invention?.....	236
10.4.4 What sources other than the textbook are used?.....	236
10.4.5 Do they use projects and more open tasks?	237
10.4.6 How do they structure the class, trying to achieve these goals?.....	237
10.4.7 Answering the main questions.....	237
11 Conclusions.....	241
11.1 Practice theories.....	242
11.2 Contents and sources.....	245
11.3 Activities and organisation.....	247
11.4 Implications of teacher beliefs.....	249
11.5 Curriculum - textbooks – teaching.....	252
11.6 Definition of concepts.....	253
11.7 How problems can be made realistic.....	254
11.8 Lessons learned.....	256
11.9 The road ahead.....	257
12 Literature.....	261
13 Appendix 1: Everyday mathematics in L97.....	273
14 Appendix 2: Questionnaire.....	279
15 Appendix 3: Illustration index	285
16 Appendix 4: Table index.....	287

1 Introduction

1.1 *Reasons for the study*

As much as I would like for this study to have been initiated by my own brilliant ideas, claiming so would be wrong. After having finished my Master of Science thesis, in which I discussed the use of history in teaching according to the so-called genetic principle, I was already determined to go for a doctorate. I only had vague ideas about what the focus of such a study could be until my supervisor one day suggested 'everyday mathematics'. Having thought about that for a while, many pieces of a puzzle I hardly knew existed seemed to fit into a beautiful picture. I could only wish it was a picture that originated in my own mind, but it is not.

In my MS thesis I indicated a theory of genesis that not only concerned incorporating the history of mathematical ideas, methods and concepts, but was more a way of defining the learning of mathematics as a process of genesis, or development. This process could be historically grounded, in what we might call historical genesis (or a historical genetic method), but we could also use concepts like logical genesis, psychological genesis, contextual genesis or situated genesis of mathematical concepts and ideas to describe the idea. The genetic principle is not a new idea, and it is believed by many to originate in the work of Francis Bacon (1561-1626), or even earlier. Bacon's 'natural method' implied a teaching practice that starts with situations from everyday life:

When Bacon's method is to be applied in teaching, everyday problems, the so-called specific cases, should be the outset, only later should mathematics be made abstract and theoretical. Complete theorems should not be the starting point; instead such theorems should be worked out along the way (Bekken & Mosvold, 2003b, p. 86).

Reviewing my own work, I realised that genesis principles (often called a 'genetic approach') could be applied as a framework for theories of learning with connections to real life also. When I discovered this, my entire work suddenly appeared to fall into place like the pieces of a marvellous puzzle. Since I cannot regard the image of this puzzle as my work only, I will from now on use the pronoun 'we' instead of 'I'.

A genesis perspective could be fruitful when studying almost any issue in mathematics education. In this study we were particularly interested in ways of connecting mathematics with real or everyday life. We wanted to focus on the development of these ideas in history and within the individual.

Starting with an interest in connecting mathematics with real life, or what we could now place within a paradigm of contextual genesis, we also decided to focus on teachers and their teaching (particularly on experienced teachers). The idea of studying experienced teachers could be linked with a famous statement that occurred in one of Niels Henrik Abel's notebooks, and this could also serve as an introduction to our study:

It appears to me that if one wants to make progress in mathematics one should study the masters and not the pupils (Bekken & Mosvold, 2003b, p. 3).

This statement was initially made in a different connection than this, but we believe that it is also important to study 'master teachers' if one wants to make progress in teaching. This is why we in our study chose to focus on experienced teachers particularly. Behind that choice was an underlying assumption that many teachers have years of experience in teaching mathematics, and many of these teachers have some wonderful teaching ideas. Unfortunately the experience and knowledge of a

teacher all too often dies with the teacher, and his ideas do not benefit others. We believe that there should be more studies of master teachers in order to collect some of their successful ideas and methods. These ideas should be incorporated in a common body of knowledge about the teaching of mathematics.

1.2 Aims of the study

The focus of interest in this study is both connected with content and methods of work. The content is closely connected with ideas of our national curriculum (which will be further discussed in chapter 4). We wish to make a critical evaluation of the content of the curriculum, when it comes to the issues of interest in this study, and we wish to make comparisons with the national development in other countries.

There have been national curricula in Norway since 1890, and before that there were local frameworks ever since the first school law was passed around 1739. Laws about schools have been passed, and specific plans have been made in order to make sure these laws were followed in the schools. The ideas about schools and teaching have changed over the years. We have studied a few aspects of our present curriculum, and this will serve as a basis for our research questions and plans.

Norway implemented a new national curriculum for the grades 1-10 in 1997. The general introductory part also concerned upper secondary education (in Norway called 'videregående skole'). This curriculum has been called L97 for short. Because it is still relatively new, we have not educated a single child throughout elementary school according to L97. Its effects can therefore hardly be fully measured yet, and the pupils who start their upper secondary education have all gone through almost half of their elementary school years with the old curriculum. Long-term effects of the principles and ideas of L97 can therefore hardly be measured at this time. Only a small number of the teachers in the Norwegian elementary school today have gone through a teacher education that followed this new curriculum, and all of them have their experience from schools and teachers that followed older curricula. However, in spite of all this one should expect the teaching in elementary and upper secondary school to follow the lines of L97 now (at least to some extent).

We want to find out how the principles of L97 are implemented in classrooms.

L97 was inspired by the Cockroft report (Cockroft, 1982), the NCTM standards (NCTM, 1989) and recent research in mathematics education. The aims and guidelines for our contemporary national curriculum appear as well considered, and the curriculum itself has an impressive appearance. In our

classroom studies we wanted to find out how the principles of L97 have been implemented in the classrooms. A hypothesis suggests that most teachers teach the way they have been taught themselves. Experience shows that there is quite a long way from a well-formed set of principles to actual changes in classrooms. Another issue is that every curriculum is subject to the teacher's interpretation. Because of this we do not expect everything to be as the curriculum intends. But we do believe that many teachers have good ideas about teaching and learning, and it is some of these good ideas that we have aimed to discover. Together with the teachers we have then reflected upon how things can be done better.

The teaching of mathematics in Norwegian schools is, or at least should be, directed by the national curriculum. In any study of certain aspects of school and teaching, L97 is therefore a natural place to start. We will look at a few important phrases here:

The syllabus seeks to create close links between school mathematics and mathematics in the outside world. Day-to-day experience, play and experiment help to build up its concepts and terminology (RMERC, 1999, p. 165)

Everyday life situations should thereby form a basis for the teaching of mathematics. ‘Mathematics in everyday life’ was added as a new topic throughout all ten years of compulsory education.

Learners construct their own mathematical concepts. In that connection it is important to emphasise discussion and reflection. The starting point should be a meaningful situation, and tasks and problems should be realistic in order to motivate pupils (RMERC, 1999, p. 167).

These two points: the active construction of knowledge by the pupils and the connection with school mathematics and everyday life, has been the main focus of this study. L97 presents this as follows:

The mathematics teaching must at all levels provide pupils with opportunities to:

- carry out practical work and gain concrete experience;
- investigate and explore connections, discover patterns and solve problems;
- talk about mathematics, write about their work, and formulate results and solutions;
- exercise skills, knowledge and procedures;
- reason, give reasons, and draw conclusions;
- work co-operatively on assignments and problems (RMERC, 1999, pp. 167-168).

The first area of the syllabus, mathematics in everyday life, establishes the subject in a social and cultural context and is especially oriented towards users. The further areas of the syllabus are based on main areas of mathematics (RMERC, 1999, p. 168).

Main stages	Main areas				
Lower secondary stage	Mathematics in everyday life	Numbers and algebra	Geometry	Handling data	Intermediate graphs and functions
Intermediate stage	Mathematics in everyday life	Numbers	Geometry	Handling data	
Primary stage	Mathematics in everyday life	Numbers	Space and shape		

Table 1 Main areas in L97

As we can see from the table above, ‘mathematics in everyday’ life has become a main area of mathematics in Norwegian schools, and this should imply an increased emphasis on real-life connections.

Although a connection with everyday life has been mentioned in previous curricula also, there has been a shift of focus. The idea that the pupils should learn to use mathematics in practical situations from everyday life has been present earlier, but in L97 the situations from real life were supposed to be the starting point rather than the goal. Instead of mathematics being a training field for real life the situations from real life are supposed to be starting points. When the pupils are working with these problems they should reach a better understanding of the mathematical theories. This is an

Situations from real life are supposed to be a starting point.

important shift of focus, and in our study we wanted to investigate how teachers have understood and implemented these ideas in their teaching.

The ideas of the curriculum on these points were examined in this study. The curriculum content was also examined, and we aimed at finding out how the textbooks meet the curricular demands, as well as how the teachers think and act. We have observed how these ideas were carried out in actual classrooms and then tried to gather some thoughts and ideas on how it can be done better.

Connections with real life are not new in curricula, and they are not specific for the Norwegian tradition only. New Zealand researcher Andrew J.C. Begg states:

In mathematics education the three most common aims of our programs are summed up as:
Personal – to help students solve the everyday problems of adult life;
Vocational – to give a foundation upon which a range of specialised skills can be built;
Humanistic – to show mathematics as part of our cultural heritage (Begg, 1984, p. 40).

Our project has built on research from other countries, and we wish to contribute to this research. In research on mathematics education, mathematics is often viewed as a social construct which is established through practices of discourse (Lerman, 2000). This is opposed to a view of mathematics as a collection of truths that are supposed to be presented to the pupils in appropriate portions.

1.3 Brief research overview

The work consisted of a theoretical study of international research, a study of videos from the TIMSS 1999 Video Study of seven countries, a study of textbooks, a study of curriculum papers, and a classroom study of Norwegian teachers, their beliefs and actions concerning these issues.

In the theoretical study we investigated research done in this area, to uncover some of the ideas of researchers in the past and the present. We focused on research before and after the Cockcroft Report in Britain, NCTM (National Council of Teachers of Mathematics) and the development in curriculum Standards in the US, research from the Freudenthal Institute in the Netherlands, the theories of the American reform pedagogy, the theories of situated learning and the Nordic research. Through examining all these theories and research projects, we have tried to form a theoretical framework for our own study.

The contemporary national curriculum, L97, was of course the most important to us, but we have also studied previous curricula in Norway, from the first one in 1739 up till the present. We have tried to find out if the thoughts mentioned above are new ones, or if they have been part of the educational system in earlier years. This analysis served as a background for our studies. The curriculum presents one set of ideas on how to connect mathematics with real life, and the textbooks might represent different interpretations of these ideas. Teachers often use the textbooks as their primary source rather than the curriculum, and we have therefore studied how the textbooks deal with the issue.

The main part of our study was a qualitative research study, containing interviews with teachers, a questionnaire survey, and observations of classroom practice. This was supported by investigations of textbooks and curriculum papers, analysis of videos from the TIMSS 1999 Video Study, and a review of theory. The qualitative data were intended to help us discover connections between the

teachers' educational background and their beliefs about the subject, teaching and learning on the one hand, and about classroom practice and methods of work on the other hand.

1.4 Research questions

A main part of any research project is to define a research problem, and to form some reasonable research questions. This was an important process in the beginning of this study, and it became natural to have strong connections with the curriculum. The national curriculum is, or should be, the working document of Norwegian teachers. We have been especially interested in how they think about and carry out ideas concerning the connection with everyday life.

- 1) What are the teachers' beliefs about connecting school mathematics and everyday life?
- 2) What ideas are carried out in their teaching practice?

It was of particular interest for us to identify the views of the teachers, when connections with everyday life were concerned, and to see how these views and ideas affected their teaching. A reasonable set of questions might be:

- Are the pupils encouraged to bring their experiences into class?
- Are the pupils involved in a process of reconstruction or re-invention?
- What sources other than the textbook do teachers use?
- Do the teachers use examples from the media?
- Do they encourage projects and open tasks?
- How do they structure the class, in trying to achieve these goals?

To these questions we have added a few sub-questions that could assist when attempting to answer the two main questions and to learn more about the strategies and methods they use to connect with everyday life:

Being aware of the fact that it is hard to answer these questions when it comes to all aspects of the mathematics curriculum, it is probably wise to focus on one or two areas of interest. The strategies for implementing these ideas in the teaching of algebra might differ from the strategies used when teaching probability, for instance. We chose to focus on the activities and issues of organisation rather than the particular mathematical topics being taught by the teachers at the time of our classroom observations.

The two main research questions might be revised slightly: How can teachers organise their teaching in order to promote activities where the pupils are actively involved in the construction of mathematical knowledge, and how can these activities be connected with real life? The sub-questions could easily be adopted for these questions also. From the sub-questions, we already see that pupil activity is naturally incorporated into these ideas. It is therefore fair to say that activity is a central concept, although it is an indirect and underlying concept more than a direct one.

Important questions that are connected with the questions above, at least on a meta-level, are:

- How do we cope with the transformation of knowledge from specific, real-life situations to the general?
- How does the knowledge transform from specific to general?
- How does the knowledge transform in/apply to other context situations?

These are more general questions that we might not be able to answer, at least not in this study, but they will follow us throughout the work.

1.5 Hypothesis

Based on intuition and the initial research questions, we can present a hypothesis that in many senses is straightforward, and that has obvious limitations, but that anyhow is a hypothesis that can be a starting point for the analysis of our research.

The population of teachers can be divided into three groups when it comes to their attitudes and beliefs about real-life connections. Teachers have multiple sets of beliefs and ideas and therefore cannot easily be placed within a simplified category. We present the hypothesis that teachers of mathematics have any of these attitudes towards real-life connections:

- Positive
- Negotiating (in-between)
- Negative

We believe that the teachers in our study can also be placed within one of these groups or categories. Placing teachers in such categories, no matter how interesting that might be, will only be of limited value. We will not narrow down our study to such a description and categorisation. Instead we have tried to gather information about the actions of teachers in each of these categories when it comes to real-life connections, and we have also tried to discover some of the thinking that lies behind their choices. A main goal for our study is therefore to generate new theory, so that we can replace this initial model with a more appropriate one. Such knowledge can teach us valuable lessons about connecting mathematics with real life, at least this is what we believe.

Our interest was therefore not only to analyse what the teachers thought about these matters and place them within these three categories, but to use this as a point of departure in order to generate new theory. We not only wanted to study what beliefs they had, but also to study what they actually did to achieve a connection with everyday life, or what instructional practices they chose. It was our intention to study the teaching strategies a teacher might choose to fulfil the aims of the curriculum when it comes to connecting mathematics with everyday life; the content and materials they used and the methods of organising the class.

1.6 Mathematics in everyday life

This thesis is based on the Norwegian curriculum (L97) because this was the current curriculum at the time of our study. The national curriculum is the main working document for Norwegian teachers, and the connection with mathematics and everyday life has been the key focus here.

Naturally our definitions of concepts will be based on L97, but unfortunately the curriculum neither gives a thorough definition, nor a discussion of the concepts in relation to other similar concepts.

Several concepts and terms are used when discussing this and similar issues in international research. We are going to address the following:

- (mathematics in) everyday life
- real-life (connections)
- realistic (mathematics education)
- (mathematics in) daily life
- everyday mathematics

In Norwegian we have a term called “hverdagsmatematikk”, which could be directly translated into “everyday mathematics”. When teachers discuss the curriculum and its presentation of mathematics in everyday life, they often comment on this term, “everyday mathematics”. The problem is that “hverdagsmatematikk” is often understood to be limited only to what pupils encounter in their everyday lives, and some teachers claim that this would result in a limited content in the mathematics curriculum. The Norwegian curriculum does not use the term “everyday mathematics”, and the area called “mathematics in everyday life” has a different meaning. For this reason, and to avoid being connected with the curriculum called Everyday Mathematics, we have chosen not to use the term “everyday mathematics” as our main term. International research literature has, however, focused on everyday mathematics a lot, and we will therefore use this term when referring to the literature (see especially chapters 2.6.6.3 and 2.7).

The adjective “everyday” has three definitions (Collins Concise Dictionary & Thesaurus):

- 1) commonplace or usual
- 2) happening every day
- 3) suitable for or used on ordinary days

“Daily”, on the other hand, is defined as:

- 1) occurring every day or every weekday
- 2) of or relating to a single day or to one day at a time: her home help comes in on a daily basis; exercise has become part of our daily lives

“Daily” can also be used as an adverb, meaning every day.

Daily life and everyday life both might identify something that occurs every day, something regular. Everyday life could also be interpreted as something that is commonplace, usual or well-known (to the pupils), and not necessarily something that occurs every day. Everyday life could also identify something that is suitable for, or used on, ordinary days, and herein is a connection to the complex and somewhat dangerous term of usefulness. We suggest that daily life could therefore be a more limited term than everyday life. In this thesis, we mainly use the term everyday life. Another important, and related, term, is “real life/world”.

The word “real” has several meanings:

- 1) existing or occurring in the physical world
- 2) actual: the real agenda

- 3) important or serious: the real challenge
- 4) rightly so called: a real friend
- 5) genuine: the council has no real authority
- 6) (of food or drink) made in a traditional way to ensure the best flavour
- 7) Maths involving or containing real numbers alone
- 8) relating to immovable property such as land or buildings: real estate
- 9) Econ. (of prices or incomes) considered in terms of purchasing power rather than nominal currency value
- 10) the real thing the genuine article, not a substitute or imitation

REAL LIFE

“The phrase real life is generally used to mean life outside of an environment that is generally seen as contrived or fantastical, such as a movie or MMORPG.

It is also sometimes used synonymously with real world to mean one’s existence after he or she is done with schooling and is no longer supported by parents.”

http://en.wikipedia.org/wiki/Real_life

From these definitions, we are more interested in the “real” in real life and real world, as in definition 1 above. We could say that real life and real world simply refer to the physical world. Real-life connections would thereby imply linking mathematical issues with something that exists or occurs in the physical world. Real-life connections do thereby not necessarily refer to something that is commonplace or well-known to the pupils, but rather something that occurs in the physical world. If we, on the other hand, choose to define real-life connections as referring to something that occurs in the pupils’ physical world (and would therefore be commonplace to them),

then real-life connections and mathematics in everyday life have the same meaning. To be more in consistence with the definitions from the TIMSS 1999 Video Study as well as the ideas of the Norwegian curriculum, L97, we have chosen to distinguish between the terms real world and real life. When we use the term “real world” we simply refer to the physical world if nothing else is explained. Real life, however, in this thesis refers to the physical world outside the classroom.

As we will see further discussed in chapter 4, mathematics in everyday life (as it is presented in the Norwegian curriculum L97) is an area that establishes the subject in a social and cultural context and is especially oriented towards users (the pupils). L97 implies that mathematics in everyday life is not just referring to issues that are well-known or commonplace to pupils, but also to other issues that exist or occur in the physical world.

This thesis is not limited to a study of Norwegian teachers, but also has an international approach, through the study of videos from the TIMSS 1999 Video Study. In the TIMSS video study the concept “real-life connections” was used. This was defined as a problem (or non-problem) situation that is connected to a situation in real life. Real life referred to something the pupils might encounter outside the classroom (cf. chapter 3.2). If a distinction between the world outside the classroom and the classroom world is the intention, then one might argue that the outside world and the physical world, as discussed above, are not necessarily the same. We have chosen to define the term “real world” as referring to the physical world in general, whereas “real life” refers to the (physical) world outside the classroom. We should be aware that there could be a difference in meanings, as far as the term “real life” is concerned. Others might define it as identical to our definition of real world, and might not make a distinction between the two. The phrase “outside the classroom” is used in the definition from the TIMSS 1999 Video Study, and the Norwegian curriculum also makes a distinction between the school world and the outside world. This implies that our notion of the pupils’ real life mainly refers to their life outside of school, or what we call the “outside world”.

We do not thereby wish to claim that what happens in school or inside the classroom is not part of the pupils everyday life, but for the sake of clarity we have chosen such a definition in this thesis. When we occasionally use the term “outside world”, it is in reference to the curriculum’s clear distinction between school mathematics and the outside world.

“Realism”, as in realistic, is also an important word in this discussion. It is defined in dictionaries as:

- 1) awareness or acceptance of things as they are, as opposed to the abstract or ideal
- 2) a style in art or literature that attempts to show the world as it really is
- 3) the theory that physical objects continue to exist whether they are perceived or not

Realistic therefore also refers to the physical world, like the word real does. The word realistic is used in the Norwegian curriculum, but when used in mathematics education, it is often in connection with the Dutch tradition called Realistic Mathematics Education (RME). We should be aware that the Dutch meaning of the word realistic has a distinct meaning that would sometimes differ from other definitions of the term. In Dutch the verb “zich realiseren” means “to imagine”, so the term realistic in RME refers more to an intention of offering the pupils problems that they can imagine, which are meaningful to them, than it refers to realness or authenticity. The connection with the real world is also important in RME, but problem contexts are not restricted to situations from real world (cf. van den Heuvel-Panhuizen, 2003, pp. 9-10). In this thesis, the word realistic is mostly referring to authenticity, but it is also often used in the respect that mathematical problems should be realistic in order to be meaningful for the pupils (cf. RMERC 1999, p. 167).

Wistedt (1990; 1992 and 1993), in her studies of “vardagsmatematik” (which could be translated into everyday mathematics), made a definition of everyday mathematics where she distinguished between:

- 1) mathematics that we attain in our daily lives, and
- 2) mathematics that we need in our daily lives.

The Norwegian curriculum certainly intends a teaching where the pupils learn a mathematics that they can use in their daily lives, but it also aims at drawing upon the knowledge that pupils have attained from real life (outside of school). When L97 also implies that the teacher should start with a situation or problem from real or everyday life and let the pupils take part in the reconstruction of some mathematical concepts through a struggle with this problem, it is not limited to either of these points. When the phrase “mathematics in everyday life” is used in this thesis, it almost exclusively refers to the topic in the Norwegian curriculum with this same name. The term “everyday life”, when used alone, is considered similar to the term “real life”, as discussed above, and we have often chosen to use the phrase ‘real-life connections’ rather than ‘connections with mathematics and everyday life’ or similar. This choice is mainly a matter of convenience. Our interpretation of mathematics in everyday life (as a concept rather than a curriculum topic) is derived from the descriptions given in L97. In short, mathematics in everyday life refers to a connection with something that occurs in the real or physical world. It also refers to something that is known to the pupils. In this thesis we are more concerned with how teachers can and do make a connection with mathematics and everyday life, and thereby how they address this specific area of the curriculum. While everyday mathematics, at least according to the definition of Wistedt, has a main focus on mathematics, the concept of mathematics in everyday life has a main focus on the connection with real or everyday life.

We should also note that some people make a distinction between everyday problems and more traditional word problems (as found in mathematics textbooks), in that everyday problems are open-ended, include multiple methods and often imply using other sources (cf. Moschkovich & Brenner, 2002). If we generalise from this definition, we might say that everyday mathematics itself is more open-ended.

The last term - everyday mathematics - is also the name of an alternative curriculum in the US, which we discuss in chapter 2.6.1.3. Everyday Mathematics (the curriculum) and “everyday mathematics” (the phrase) are not necessarily the same. The Everyday Mathematics curriculum has a focus on what mathematics is needed by most people, and how teachers can teach “useful” mathematics. We have deliberately avoided the term useful in this thesis, because this would raise another discussion that we do not want to get stuck in. (What is useful for young people, and who decides what is useful, etc.) We do, however, take usefulness into the account when discussing the motivational aspect concerning transfer of learning in chapter 2.8.

Wistedt’s definition, as presented above, is interesting, and it includes the concept of usefulness. Because the Norwegian phrase that could be translated into “everyday mathematics” is often used in different (and confusing) ways, we have chosen to omit the term in this thesis. Everyday mathematics, as defined by Wistedt, implies a mathematics that is attained in everyday life. L97 aims at incorporating the knowledge that pupils bring with them, knowledge they have attained in everyday life, but we have chosen refer to this as connecting mathematics with real or everyday life instead of using the term everyday mathematics. Another interpretation of everyday mathematics, again according to Wistedt, is mathematics that is needed in everyday life. L97, as well as most

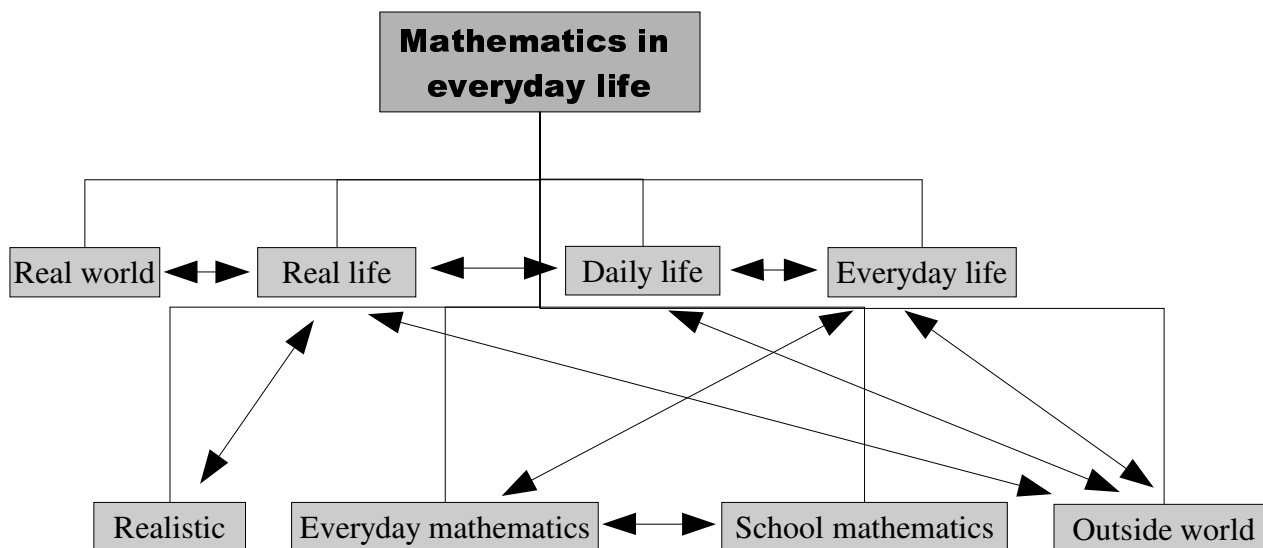

Illustration 1 Many concepts are involved in the discussion

other curriculum papers we have examined, presents intentions of mathematics as being useful in everyday life, but the discussion of usefulness is beyond the scope of this thesis.

To conclude, our attempt at clarifying the different terms can be described in the following way:

- “mathematics in everyday life” refers to the curriculum area with this same name, and to the connection with mathematics and everyday life
- “real life” refers to the physical world outside the classroom

- “real world” refers to the physical world (as such)
- “everyday life” mainly refers to the same as real life, and we thereby do not distinguish between ‘real-life connections’ and ‘connections between mathematics and everyday life’ or similar
- “daily life” refers to something that occurs on a more regular basis, but is mainly omitted in this thesis
- “everyday mathematics” both refers to a curriculum, but also to a distinction between mathematics that is attained in everyday life and mathematics that is needed in everyday life.

1.7 Summary of the thesis

The main theme of this thesis is mathematics in everyday life. This topic was incorporated into the present curriculum for compulsory education in Norway (grades 1-10), L97, and it was presented as one of the main areas. We have studied how practising teachers make connections with everyday life in their teaching, and their thoughts and ideas on the subject. Our study was a case study of teachers’ beliefs and actions, and it included analysis of curriculum papers, textbooks, and videos from the TIMSS 1999 Video Study as well as an analysis of questionnaires, interviews and classroom observations of eight Norwegian teachers.

Eight teachers have been studied from four different schools. The teachers have been given new names in our study, and the schools have been called school 1, school 2, school 3 and school 4. Schools 1 and 2 were upper secondary schools. We studied one teacher in school 1 (Jane) and four teachers in school 2 (George, Owen, Thomas and Ingrid). Schools 3 and 4, which were visited last, were both lower secondary schools. We studied two teachers in school 3 (Ann and Karin) and one teacher in school 4 (Harry). All were experienced teachers.

We used ethnographic methods in our case study, where the focus of interest was the teachers’ beliefs and practices. All mathematics teachers at the four schools were asked to answer a questionnaire about real-life connections. 20 teachers responded (77% of all the mathematics teachers). The eight teachers were interviewed and their teaching practices observed for about 4 weeks. These three methods of data collection were chosen so as to obtain the most complete records of the teachers’ beliefs and actions in the time available.

In chapter 2 the theoretical foundations of the study are presented and discussed. Here, constructivism, social constructivism, social learning theories, situated learning and transfer of learning are important concepts. The thesis also aims at being connected with international research. An important aspect of the thesis is therefore a study of videos from the TIMSS 1999 Video Study (cf. Hiebert et al., 2003). This part of our study was conducted in May 2003 while the author was in residence at UCLA and at Lesson Lab as a member of the TIMSS 1999 Video Study of Mathematics in seven countries. Videos from Japan, Hong Kong and the Netherlands were studied to investigate how teachers in these countries connected with real life in their teaching. This study of videos is presented in chapter 3 and it aims to give our own study an international perspective.

The Norwegian national curriculum, L97 (RMERC, 1999), implies a strong connection of mathematics and everyday life. This is supposed to be applied in all 10 years of compulsory education, and it is also emphasised (although not as strongly) in the plans for upper secondary education. Chapter 4 is a presentation and discussion of the curriculum ideas concerning mathematics in everyday life. We also present how these ideas were present in previous curricula in Norway.

The curriculum is (supposed to be) the working document for teachers, but research shows that textbooks are the main documents or sources of material for the teachers (cf. Alseth et al., 2003). Chapter 5 is a study of the textbooks that were used by the eight teachers in this study. We have focused on how these textbooks deal with real-life connections, and especially in the chapters on geometry (lower secondary school) and trigonometry (upper secondary school), since these were the topics most of the teachers were presenting at the time of the classroom observations.

Chapter 6 gives a further presentation and discussion of the methods and methodological considerations of our study. The different phases of the study are discussed, and the practical considerations and experiences also. A coding scheme from the TIMSS 1999 Video Study was adopted and further adapted to our study, and, in a second phase of analysis, a list of categories and themes were generated and used in the analysis and discussion of findings.

The findings of our study constitute an important part of this thesis, and chapters 7-9 give a presentation of these. The questionnaire results are presented in chapter 7, with the main focus on the Likert scale questions. They represent some main ideas from the curriculum, and the teachers' replies to these questions give strong indications of their beliefs about real-life connections. 35% of the teachers replied that they, often or very often, emphasise real-life connections in their teaching of mathematics, and so there was a positive tendency. The classroom observations and the interviews were meant to uncover if these professed beliefs corresponded with the teaching practices of the teachers.

Chapter 8 is a presentation of the findings from the study of three teachers in lower secondary school (Ann, Karin and Harry). They were quite different teachers, although all three were experienced and considered to be successful teachers. Harry was positive towards real-life connections, and he had many ideas that he carried out in his lessons. Ann was also positive towards the idea of connecting with everyday life, but she experienced practical difficulties in her everyday teaching, which made it difficult for her to carry it out. Karin was opposed to the idea of connecting mathematics with everyday life and she considered herself to be a traditional teacher. Her main idea was that mathematics was to exercise the pupils' brains, and the textbook was a main source for this purpose, although she did not feel completely dependent on it.

In chapter 9 we present the findings from the pilot study of five teachers from upper secondary school (Jane, George, Owen, Thomas and Ingrid). They teach pupils who have just finished lower secondary school. They follow a different curriculum, but the connections with everyday life are also represented in this. Jane taught mathematics at a vocational school, and she focused a lot on connecting with everyday or vocational life. Her approach was different from Harry's, but she also had many ideas that she carried out in her teaching. George was positive towards real-life connections, but he had questions about the very concept of everyday life. He believed that school mathematics was a part of everyday life for the pupils, and their everyday life could also be that they wanted to qualify for studies at technical universities etc. Owen seemed to be positive towards real-life connections in the questionnaire, but he turned out to be negative. He was a traditional teacher, and he almost exclusively followed the textbook. Thomas and Ingrid were teaching a class together, and this class was organised in cooperative groups. Neither Thomas nor Ingrid had a significant focus on real-life connections.

We have observed teachers with significantly different beliefs and practices. Some were opposed to a connection with everyday life, some were not. Our study has given several examples of how real-life connections can be implemented in classrooms, and it has provided important elements in the discussion of how mathematics should and could be taught. Chapter 10 presents a more thorough discussion of the findings as well as answers to the research questions, while chapter 11 presents the conclusions of the present study and the implications for teaching. This chapter also presents a discussion of the connection between curriculum intentions and the implementation of these

intentions in the textbooks and finally in actual teaching practice. A discussion of how problems can be made realistic is also presented, as well as comments about the lessons learned (according to research methods etc.) and the road ahead, with suggestions for how to change teachers' beliefs and teaching practice.

There are many approaches to teaching. Our study has aimed at giving concrete examples of how teaching can be organised in order to connect mathematics with everyday life and thereby follow the suggestions of L97.

2 Theory

Our study is closely connected with two themes from the Norwegian national curriculum (L97), and since these issues provide the basis for our research questions, we will briefly repeat them here:

The syllabus seeks to create close links between school mathematics and mathematics in the outside world. Day-to-day experience, play and experiment help to build up its concepts and terminology (RMERC, 1999, p. 165)

And the second:

Learners construct their own mathematical concepts. In that connection it is important to emphasise discussion and reflection. The starting point should be a meaningful situation, and tasks and problems should be realistic in order to motivate pupils (RMERC, 1999, p. 167).

Traditional school education may remove people from real life (cf. Fasheh, 1991), and L97 aims at changing this. Mathematics in school is therefore supposed to be connected with the outside world, and the pupils should construct their own mathematical concepts. We believe that these ideas are not separated, but closely connected, at least in the teaching situation. It is also indicated in the last quote that the starting point should be a meaningful situation. This will often be a situation from everyday life, a realistic situation or what could be called an experientially real situation. The Norwegian syllabus therefore connects these issues.

This theoretical part has two main perspectives: teacher beliefs and learning theories. Our study has a focus on *teacher beliefs*, and it has a focus on the teachers' beliefs *about* something particular. This 'something particular' is the connection with mathematics and everyday life. We therefore present and discuss learning theories and approaches that are somewhat connected with this. As a bridge between the two main points of focus is a more philosophical discussion of the different 'worlds' involved.

Our aim is to investigate teachers' beliefs and actions concerning these issues, and in this theoretical part we will start by discussing teacher beliefs. Educational research has addressed the issue of beliefs for several decades (cf. Furinghetti & Pehkonen, 2002).

2.1 *Teacher beliefs*

Beliefs and knowledge about mathematics and the teaching of mathematics are arguably important, and in our study we aim mainly to uncover some of the teachers' beliefs about certain aspects of the teaching of mathematics. Research has shown that teachers, at least at the beginning of their careers, shape their beliefs to a considerable extent from the experiences of those who taught them (cf. Andrews & Hatch, 2000; Feiman-Nemser & Buchmann, 1986; Calderhead & Robson, 1991; Harel, 1994).

There are many different variations of the concepts 'belief' and 'belief systems' in the literature (cf. Furinghetti & Pehkonen, 2002; McLeod & McLeod, 2002), but in many studies the differences between beliefs and knowledge are emphasised.

Scheffler (1965) presented a definition, where he said that X knows Q if and only if:

- i. X believes Q

- ii. X has the right to be sure of Q

- iii. Q

The third criterion, about the very existence of Q, is a tricky one. The very essence of constructivism is that we can never know reality as such, but we rather construct models that are trustworthy. Following a constructivist perspective, criteria ii and iii can be restated as follows (Wilson & Cooney, 2002, p. 130):

iiR (revised). X has reasonable evidence to support Q.

One might say that beliefs are the filters through which experiences are interpreted (Pajares, 1992), or that beliefs are dispositions to act in certain ways, as proposed by Scheffler:

A belief is a cluster of dispositions to do various things under various associated circumstances. The things done include responses and actions of many sorts and are not restricted to verbal affirmations. None of these dispositions is strictly necessary, or sufficient, for the belief in question; what is required is that a sufficient number of these clustered dispositions be present. Thus verbal dispositions, in particular, occupy no privileged position vis-à-vis belief (Scheffler, 1965, p. 85).

<p>BELIEF</p> <p>“Belief is assent to a proposition.</p> <p>Belief in the psychological sense, is a representational mental state that takes the form of a propositional attitude. In the religious sense, ‘belief’ refers to a part of a wider spiritual or moral foundation, generally called faith.</p> <p>Belief is considered propositional in that it is an assertion, claim or expectation about reality that is presumed to be either true or false (even if this cannot be practically determined, such as a belief in the existence of a particular deity).”</p> <p>http://en.wikipedia.org/wiki/Belief</p>
--

This definition provides difficulties for modern research, since, according to Scheffler, a variety of evidence has to be present in order to determine one’s beliefs. What then when a teacher claims to have a problem solving view on mathematics, but in the classroom he only emphasises procedural knowledge? The researcher would then probably claim that there exists an inconsistency between the teachers’ belief and his or her practice.

We might also say that each individual possesses a certain system of beliefs, and the individual continuously tries to maintain the equilibrium of their belief systems (Andrews & Hatch, 2000). According to Op’t Eynde et al. (1999), beliefs are, epistemologically speaking, first and foremost individual constructs, while knowledge is a social construct. We might therefore say that beliefs are people’s subjective knowledge, and they include affective factors. It should be taken into consideration that people are not always conscious of their beliefs. Individuals may also hide their beliefs when they do not seem to fit someone’s expectations. We therefore want to make a

distinction between deep beliefs and surface beliefs. These could again be viewed as extremes in a wide spectrum of beliefs (Furinghetti & Pehkonen, 2002).

Another definition was given by Goldin (2002), who claimed that beliefs are:

(...) internal representations to which the holder attributes truth, validity, or applicability, usually stable and highly cognitive, may be highly structured (p. 61).

Goldin later specified his definition of beliefs to be:

(...) multiply-encoded cognitive/affective configurations, usually including (but not limited to) propositional encoding, to which the holder attributes some kind of *truth value* (Goldin, 2002, p. 64; original italics).

Another attempt of defining beliefs, which supports Goldin's definitions, is to simply define beliefs as purely cognitive statements to which the holder attributes truth or applicability (Hannula et al., 2004). Hannula thereby wished to exclude the emotional aspect from beliefs, and he claimed instead that each belief may be *associated* with an emotion (Hannula, 2004, p. 50):

If this distinction between a belief and the associated emotion were made, it would clarify much of the confusion around the concept "belief". For example, two students may share a cognitive belief that problem solving is not always straightforward, but this belief might be associated with enjoyment for one and with anxiety for the other.

A consensus on one single definition of the term 'belief' is probably neither possible nor desirable, but we should be aware of the several types of definitions, as they might be useful in order to understand the different aspects of beliefs (cf. McLeod & McLeod, 2002).

The view on teacher beliefs has changed during the years. In the 1970s there was a shift from a process-product paradigm, where the emphasis was on the teacher's behaviour, towards a focus on the teacher's thinking and decision-making processes. This led to an interest in the belief systems and conceptions that were underlying the teacher's thoughts and decisions (Thompson, 1992, p. 129).

Research on teacher beliefs has shown that there is a link between the teachers' beliefs about mathematics and their teaching practices (Wilson & Cooney, 2002). Studies like Thompson (1992) suggest that a teacher's beliefs about the nature of mathematics influence the future teaching practices of the teacher (cf. Szydlik, Szydlik & Benson, 2003, p. 253). If a teacher regards mathematics as a collection of rules that are supposed to be memorised and applied, this would influence his teaching, and as a result he will teach in a prescriptive manner (Thompson, 1984).

On the other hand, a teacher who holds a problem solving view of mathematics is more likely to employ activities that allow students to construct mathematical ideas for themselves (Szydlik, Szydlik & Benson, 2003, p. 254).

Recent curriculum reforms indicate such a view of mathematics more than the earlier ones. When faced with curriculum reforms, practising teachers often have to meet the challenges of these new reforms by themselves. Their teaching practice is a result of decisions they make based on interpretations of the curriculum rhetoric and experiences and beliefs they carry into the classroom (Sztajn, 2003, pp. 53-54).

Change in teaching on a national basis would not only have to do with a change of curriculum and textbooks, but it would also be connected with a change or modification of teachers' beliefs about mathematics, about teaching and learning mathematics, etc. Experiences with innovative curriculum materials might challenge the teachers' beliefs directly. Most teachers rely upon one or a few textbooks to guide their classroom instruction, and they need guidance in order to change their teaching practice (Lloyd, 2002, p. 157).

Ernest (1988, p.1) distinguished between three elements that influence the teaching of mathematics:

- 1) The teacher's mental contents or schemas, particularly the system of beliefs concerning mathematics and its teaching and learning;

- 2) The social context of the teaching situation, particularly the constraints and opportunities it provides; and
- 3) The teacher's level of thought processes and reflection.

Such a model can be further developed into a model of distinct views on how mathematics should be taught, like that of Kuhs and Ball (1986, p. 2):

- Learner-focused: mathematics teaching that focuses on the learner's personal construction of mathematical knowledge;
- Content-focused with an emphasis on conceptual understanding: mathematics teaching that is driven by the content itself but emphasizes conceptual understanding;
- Content-focused with an emphasis on performance: mathematics teaching that emphasizes student performance and mastery of mathematical rules and procedures; and
- Classroom-focused: mathematics teaching based on knowledge about effective classrooms.

Thompson (1992) continues the work of Ernest (1988) when she explains how research indicates that a teacher's approaches to mathematics teaching have strong connections with his or her systems of beliefs. It should therefore be of great importance to identify the teacher's view of mathematics as a subject. Several models have been elaborated to describe these different possible views. Ernest (1988, p. 10) made a distinction between (1) the problem-solving view, (2) the Platonist view, and (3) the instrumentalist view. Others, like Lerman (1983), have made distinctions between an absolutist and a fallibilist view on mathematics. Skemp (1978), who based his work on Mellin-Olsen's, made a distinction between 'instrumental' mathematics and 'relational' mathematics (Thompson, 1992, p. 133). In the Californian 'Math wars', we could distinguish between three similar extremes: the concepts people, the skills people, and the real life applications people (Wilson, 2003, p. 149).

Research on teacher beliefs could be carried out using questionnaires, observations, interviews, etc., but one should be cautious:

Inconsistencies between professed beliefs and instructional practice, such as those reported by McGalliard (1983), alert us to an important methodological consideration. Any serious attempt to characterize a teacher's conception of the discipline he or she teaches should not be limited to an analysis of the teacher's professed views. It should also include an examination of the instructional setting, the practices characteristic of that teacher, and the relationship between the teacher's professed views and actual practice (Thompson, 1992, p. 134).

These inconsistencies might also be related to the significant discrepancy between knowledge and belief. Research has shown that although the teachers' knowledge of curriculum changes has improved, the actual teaching has not changed much (Alseth et al., 2003). The reason for this might be that it is possible for knowledge to change while beliefs do not, and what we call knowledge could be connected with what Thompson (1992) called professed views. Research has also shown that pre-existing beliefs about teaching, learning and subject matter can be resistant to change (cf. Szydlik, Szydlik & Benson, 2003; Lerman, 1987; Brown, Cooney & Jones, 1990; Pajares, 1992; Foss & Kleinsasser, 1996).

All these issues imply that educational change is a complex matter, and that we should be aware of the possible differences between professed beliefs and the beliefs that are acted out in teaching. This possible inconsistency between professed beliefs and instructional practice is a reason why we have chosen a research design with several sources of data. We wanted to learn not only about the beliefs of the teachers, but also about their teaching practices. If beliefs alone could give a complete image of teaching, no researcher would need to study teaching practice. We wanted not only to study what

the teachers said in the interviews or questionnaires (professed beliefs), but also to observe the actual teaching practices of these teachers (instructional practice). We believe that such a knowledge of the teaching practice and beliefs of other teachers is of importance to the development of one's own teaching.

All this taken into account, we study beliefs (and practice) of teachers because we believe, and evidence has shown (Andrews & Hatch, 2000), that teachers' beliefs about the nature of mathematics do influence both what is taught and how it is taught. This is discussed by Wilson & Cooney, 2002, p. 144:

However, regardless of whether one calls teacher thinking beliefs, knowledge, conceptions, cognitions, views, or orientations, with all the subtlety these terms imply, or how they are assessed, e.g., by questionnaires (or other written means), interviews, or observations, the evidence is clear that teacher thinking influences what happens in the classrooms, what teachers communicate to students, and what students ultimately learn.

In our study of teacher beliefs and their influence on teaching we wish to shed light on important processes in the teaching of mathematics. Research has shown that teachers' beliefs can change when they are provided with opportunities to consider and challenge these beliefs (Wilson & Cooney, 2002, p. 134).

Research has shown that the relationship between beliefs and practice is probably a dialectic rather than a simple cause-and-effect relationship (cf. Thompson, 1992), and would therefore be interesting for future studies to seek to elucidate the dialectic between teachers' beliefs and practice, rather than trying to determine whether and how changes in beliefs result in changes in practice. Thompson also suggests that it is not useful to distinguish between teachers' knowledge and beliefs. It seems more helpful to focus on the teachers' conceptions instead of simply teachers' beliefs (cf. Thompson, 1992, pp. 140-141). She also suggests that we must find ways to help teachers examine their beliefs and practices, rather than only present ourselves as someone who possesses all the answers.

We should not take lightly the task of helping teachers change their practices and conceptions. Attempts to increase teachers' knowledge by demonstrating and presenting information about pedagogical techniques have not produced the desired results. (...) We should regard change as a long-term process resulting from the teacher testing alternatives in the classroom, reflecting on their relative merits vis-à-vis the teacher's goals, and making a commitment to one or more alternatives (Thompson, 1992, p. 143).

Our study is not simply a study of teacher beliefs as such, but rather a study of teacher beliefs about connecting mathematics with real or everyday life, and we aim at uncovering issues that might be helpful for teachers in order to change teaching practice. Before we present and discuss theories and research related to this particular issue, we have to make a more philosophical discussion.

2.2 Philosophical considerations

When discussing the connection with mathematics and everyday life, the outside world, the physical world (or whatever we like to call it), there is a more basic discussion that we should have in mind. This discussion, which is important in order to understand the entire issue that we discuss, is about the very nature of what we might call 'the mathematical world' and 'the physical world'. If we do not include such a discussion, everything we say about the connections between mathematics and everyday life maybe will make little sense.

We have already seen in the introductory discussion of concepts that our study deals with conceptions of reality and what is ‘real’ to different people. In order to understand these issues further, we might present a theory of three different ‘worlds’:

The world that we know most directly is the world of our conscious perceptions, yet it is the world that we know least about in any kind of precise scientific terms. (...) There are two other worlds that we are also cognisant of - less directly than the world of our perceptions - but which we now know quite a lot about. One of these worlds is the world we call the physical world. (...) There is also one other world, though many find difficulty in accepting its actual existence: it is the Platonic world of mathematical forms (Penrose, 1994, p. 412).

The physical world and the mathematical world are most interesting to this discussion. Instead of making a new definition of these worlds, we refer to Smith, who has a problem-solving approach to this as opposed to Penrose’s more Platonic approach:

The physical world is our familiar world of objects and events, directly accessible to our eyes, ears, and other senses. We all have a language for finding our way around the physical world, and for making statements about it. This everyday language is often called *natural*, not because other kinds of language are unnatural, but because it is the language we all grow up speaking, provided we have the opportunity to hear it spoken by family and friends during our childhood.

I use the word “world” metaphorically to talk about mathematics because it is a completely different domain of experience from the physical world. (...) Mathematics can be considered a world because it has a landscape that can be explored, where discoveries can be made and useful resources extracted. It can arouse all kinds of familiar emotions. But it is not part of the familiar physical world, and it requires different kinds of maps, different concepts, and a different language. The world of mathematics doesn’t arise from the physical world (I argue) - except to the extent that it has its roots in the human brain, and it can’t be made part of the physical world. The two worlds are always at arm’s length from each other, no matter how hard we try to bring them together or take for granted their interrelatedness.

The language used to talk about the world of mathematics is not the same as the language we use for talking about the physical world. But problems arise because the language of mathematics often looks and sounds the same as natural language (Smith, 2000, p. 1).

This understanding of ‘the physical world’ has close relations to our definition of ‘real world’ (see chapter 1.6). Penrose also takes up the discussion about the meaning of these different worlds:

What right do we have to say that the Platonic world is actually a ‘world’, that can ‘exist’ in the same kind of sense in which the other two worlds exist? It may well seem to the reader to be just a rag-bag of abstract concepts that mathematicians have come up with from time to time. Yet its existence rests on the profound, timeless, and universal nature of these concepts, and on the fact that their laws are independent of those who discover them. This rag-bag - if indeed that is what it is - was not of our creation. The natural numbers were there before there were human beings, or indeed any other creature here on earth, and they will remain after all life has perished (Penrose, 1994, p. 413).

The relationship between these worlds is of importance to us here, and Penrose presents three ‘mysteries’ concerning the relationships between these worlds:

There is the mystery of why such precise and profoundly mathematical laws play such an important role in the behaviour of the physical world. Somehow the very world of physical reality seems almost mysteriously to emerge out of the Platonic world of mathematics. (...) Then there is the second mystery of how it is that perceiving beings can arise from out of the physical world. How is it that subtly

organized material objects can mysteriously conjure up mental entities from out of its material substance? (...) Finally, there is the mystery of how it is that mentality is able seemingly to 'create' mathematical concepts out of some kind of mental model. These apparently vague, unreliable, and often inappropriate mental tools, with which our mental world seems to come equipped, appear nevertheless mysteriously able (...) to conjure up abstract mathematical forms, and thereby enable our minds to gain entry, by understanding, into the Platonic mathematical realm (Penrose, 1994, pp. 413-414).

Where Penrose talks about 'mysteries', Smith talks about a 'glass wall' between the world of mathematics and the physical world:

Finally, the glass wall is a barrier that separates the physical world and its natural language from the world of mathematics. The barrier exists only in our mind - but it can be impenetrable nonetheless. We encounter the wall whenever we try to understand mathematics through the physical world and its language. We get behind the wall whenever we venture *with understanding* into the world of mathematics (Smith, 2000, p. 2).

Smith claims that major problems can arise when mathematics is approached as if it were part of natural language. This indicates that the connection with mathematics and everyday life is far from trivial, and that it can actually be problematic.

He explains further that mathematics is not an ordinary language that can be studied by linguists, and it does not translate directly into any natural language. If we call mathematics a language, we use the word "language" metaphorically (Smith, 2000, p. 2). Music is a similar language to mathematics, and:

Everyday language is of limited help in getting into the heart of music or mathematics, and can arouse confusion and frustration (Smith, 2000, p. 2).

This means that only a small part of mathematics can be put into everyday language. This coincides with what some of the teachers in the pilot said, that mathematics in everyday life is important, but mathematics is so much more than that...

To define what mathematics is, is not an easy task. It might refer to what people do (mathematicians but also most normal people) or what people know. Smith claims that many people do mathematical activities without being aware that they do so - they do without knowing - (like in the study of Brazilian street children, cf. Nunes, Schliemann & Carraher, 1993), and many of us recite mathematical knowledge that we never put to use - we know without doing (cf. Smith, 2000, pp. 7-9).

2.2.1 Discovery or invention?

When discussing what mathematics is, we often encounter a discussion of whether mathematical knowledge was discovered or invented. People like Penrose, with a more Platonic view, would probably say that mathematics is discovered, whereas social constructivists and others would argue that mathematical knowledge is a construction of humans or rather the construction of people in a society. The understanding of what mathematics is and how mathematics came into being also has an influence of the way we think about teaching and learning of mathematics.

One would think that language is something that is discovered by every child (or taught to every child). Yet studies of the rapidly efficient manner in which language skill and knowledge develop in children has led many researchers to assert that language is invented (or reinvented) by children rather than discovered by them or revealed to them. And no less psychologist than Jean Piaget has asserted that children have to invent or reinvent mathematics in order to learn it (Smith, 2000, p. 15).

When curricula and theories deal with understanding of mathematics, they often include issues of relating mathematical knowledge to everyday life, the physical world or some other instances. There are, however, issues that should be brought into discussion here:

When I use the phrase “understanding mathematics,” I don’t mean relating mathematical knowledge and procedures to the “real world”. A few practical calculations can be made without any understanding of the underlying mathematics, just as a car can be driven without any understanding of the underlying mechanics (Smith, 2000, p. 123).

Smith also discusses what it means to learn mathematics, and he claims that everyone can learn it. He does not thereby mean that everyone can or should learn all of mathematics, or even to learn everything in a particular curriculum:

The emphasis on use over understanding is explicit in “practical” curricula supposed to reflect the “needs” of the majority of students in their everyday lives rather than serve a “tiny minority” who might want to obtain advanced qualifications. The patronizing dichotomy between an essentially nonmathematical mass and a small but elite minority is false and dangerous. The idea that the majority would be best served by a bundle of skills rather than by a deeper mathematical understanding would have the ultimate effect of closing off the world of mathematical understanding to most people, even those who might want to enter the many professions that employ technological or statistical procedures (Smith, 2000, p. 124).

He also refers to the constructivist stance (which we will return to in chapter 2.3):

The constructivist stance is that mathematical understanding is not something that can be explained to children, nor is it a property of objects or other aspects of the physical world. Instead, children must “reinvent” mathematics, in situations analogous to those in which relevant aspects of mathematics were invented or discovered in the first place. They must construct mathematics for themselves, using the same mental tools and attitudes they employ to construct understanding of the language they hear around them (Smith, 2000, p. 128).

This does not mean that children should be left on their own, but it means that they can and must invent mathematics for themselves, if provided with the opportunities for the relevant experiences and reflections.

The connection between mathematics and everyday life, which is evidently more complex than one might initially believe, has often been dealt with through the use of word problems. These word problems are often mathematical problems wrapped up in an everyday language:

It is widely believed that mathematics can be made more meaningful, and mathematics instruction more effective, if mathematical procedures and problems are wrapped in the form of everyday language. (...) But there are doubts whether many “word problems” - embedding (or hiding) mathematical applications in “stories” - do much to improve mathematical comprehension. Such problems need to be carefully designed and used in ways that encourage children to develop relevant computational techniques. Otherwise, children easily but unwittingly subvert teachers’ aims by showing the same originality and inventiveness they demonstrate in purely mathematical situations (Smith, 2000, p. 133).

What often happens, is that pupils find shortcuts, they search for key words, etc., to solve word problems.

Children may appear to gain mastery but in fact find practical shortcuts and signposts that eventually constitute obstacles to future progress. They usually prefer their own invented procedures to formal procedures that they don't understand (Smith, 2000, p. 133).

These are issues one should have in mind when discussing textbook problems (cf. chapter 5) in general and word problems in particular.

2.3 Theories of learning

A number of studies (cf. Dougherty, 1990; Grant, 1984; Marks, 1987; Thompson, 1984) have shown that beliefs that teachers have about mathematics and its teaching influence their teaching practice. Our study has a focus on the teachers' beliefs and practices as far as the connection of mathematics with everyday life is concerned, and there are several issues concerning learning theories that are important in this aspect.

When discussing learning and different views of learning, it is important to have in mind which theory of reality we are building upon. Our conception of the physical world also accounts for our conception of learning. To put it simply, we can view reality in a subjective or an objective way. The objective tradition presents the world as consisting mainly of things or objects, which we can observe in their true nature. This process of observation is completely independent of the person observing, and the theory belongs to what we might call absolutism or empiricist philosophy. Behaviourism builds on such an objective view. Behaviourists, or learning theorists, were interested in behaviour, in activities that could be observed objectively and measured in a reliable way. This psychological tradition claims that learning is a process that takes place in the individual learner, who, being exposed to an external stimulus, reacts (responds) to this stimulus. The idea of stimulus-response is central to the behaviourist theory of learning (cf. Gardner, 2000, p. 63).

Thoughts on what directs human behaviour (DNA, environmental influence or the individual itself) influence our choice of psychological tradition. Various theories of human behaviour have been developed: psychoanalysis, cognitive psychology, constructivism, social psychology, etc.

Our view of learning has a strong influence on our teaching. When we discuss how the teaching of mathematics is connected to the pupils' reality, we have already accepted a basic idea that learning is something that occurs in an interaction between the pupil and the world he or she lives in. We have thus entered the paradigm of social constructivism and socio-cultural theories, but this does not necessarily imply that we believe knowledge is *only* a social construct.

According to the constructivist paradigm, any kind of learning implies a construction of new knowledge in the individual. In some sense this construction takes place within a social context, but the processes of construction must also be rooted in the individual person for the notion of learning by the individual to provide meaning. Although textbooks might have a seemingly simple definition, constructivism is a wide concept. It might be defined as a view that emphasises the active role of the learning in the process of building understanding (cf. Woolfolk, 2001, p. 329), but constructivism actually includes several theories about how people construct meaning. Broadly speaking, we can distinguish between two different poles. On the one hand, constructivism is a philosophical discipline about bodies of knowledge, and on the other hand it is a set of views about how individuals learn (Phillips, 2000, pp. 6-7).

There seems to be widespread current agreement that learning takes place when the pupil actively constructs his or her knowledge. The construction of knowledge is seldom a construction of genuinely new knowledge. It is normally more of a reconstruction of knowledge that is already known to the general public, but new to the individual. Whether this construction occurs in a social environment or is solely an individual process can be disputed. We call the former a social constructivist view, and the latter a radical constructivist view. A radical constructivist view, as presented by Glasersfeld (1991) will often enter the philosophical realm, and this view builds strongly on the works of Piaget. Other researchers emphasise the idea of mathematics being a social construction, and we thus enter the area of social constructivism (cf. Ernest, 1994; 1998). To make a definite distinction is hard. We believe that the surrounding environment and people are important in the construction process, and a process of construction normally takes place in a social context. An emphasis on the context will soon lead to a discussion about the transfer of learning between contexts (cf. Kilpatrick, 1992).

The ideas of social constructivism can be divided in two. First, there is a tradition starting with a radical constructivist position, or a Piagetian theory of mind, and then adding social aspects of classroom interaction to it. Second, there is a theory of social constructivism that could be based on a Vygotskian or social theory of mind (Ernest, 1994).

Even reading and learning from a book can in some sense be viewed as a social context, since it includes a simulated discussion with the writer(s). We can also emphasise the individual as a constructor of knowledge. A social consensus does not necessarily imply that an individual has learned something. Piaget was a constructivist, and he focused on the individual's learning. Many would call him a radical constructivist. But although he was advocating the constructivist phases of the individual, he was also aware of the social aspects, and that learning also occurred in a social context. Psychological theories, like other scientific theories, have to focus more on some aspects than others. This does not mean that the less emphasised issues are forgotten or even rejected. In constructivism one might focus on the individual, or learning as a social process. Classroom learning is in many ways a social process, but there also has to be an element of individual construction in this social process.

A term like 'holistic' might also be used to describe learning, and this can be viewed in connection with descriptions of multiple intelligences as presented in the popular sciences. Gardner (2000, etc.) is arguably the most important contributor to the theories of multiple intelligences. His theories discuss and describe the complexities of human intelligence, and a teacher has to be aware of this complexity in order to meet the pupils on their individual level. More recent theories of pedagogy present concepts as contextual or situated learning, learning in context, etc. A main idea here is that learning takes place in a specific context, and a main problem is how we are going to transfer knowledge to other contexts. In our research we discuss how teachers connect school mathematics and everyday life. This implies a discussion of teacher beliefs and their connection with teacher actions. When discussing the connection between school mathematics and everyday life, we also implicitly discuss transfer of learning between different contexts.

2.4 Situated learning

The teaching of mathematics has been criticised for its formal and artificial appearance, where much attention has been paid to the drilling of certain calculation methods, algebra and the mechanical use of formulas.

An alternative to this formal appearance is to work with problems in a meaningful context (cf. RMERC, 1999), and to connect mathematics with everyday life. The theories of context-based

teaching are significant, and in mathematics education theories of context-based learning are often referred to as situated learning. A key point for such theories is that the context of learning, being organised in school, to a strong degree must be similar to the context in which the knowledge is applied outside school.

Situated learning is based on the idea that all cognition in general, and learning in particular, is situated. We can perceive learning as a function of activity, context and culture, an idea which is often in contrast with the experience we have from school. In school, knowledge has often been presented without context, as something abstract. Situated learning is thereby a general theory for the acquisition of knowledge, a gradual process where the context is everyday life activities. We find these ideas also in what has been called 'legitimate peripheral participation', which is a more contemporary label for the ideas of situated learning. According to this theory, learning is compared to an apprenticeship. The unschooled novice joins a community, moving his way from the peripheral parts of the community towards the centre. Here, the community is an image of the knowledge and its contexts (cf. Lave & Wenger, 1991).

Situated learning should include an authentic context, cooperation and social interaction. These are some of the main principles. Social interaction may be understood as a critical component. The idea is simply that thought and action are placed within a certain context, i.e. they are dependent on locus and time. We will take a closer look at the concept of situated learning and its development when presenting some of the most important research done in the field.

2.4.1 Development of concepts

The studies of the social anthropologist Jean Lave and her colleagues have been important in the development of the theories of situated learning. We sometimes use 'learning in context' or other labels to describe these ideas.

Lave aimed at connecting theories of cognitive philosophy with cognitive anthropology, the culture being what connects these in the first place. Socialisation is a central concept describing the relations between society and the individual (Lave, 1988, p. 7).

Functional theory represents an opposite extreme to the ideas of Lave and others about learning in context.

(...) functional theory treats processes of socialisation (including learning in school) as passive, and culture as a pool of information transmitted from one generation to the next, accurately, with verisimilitude, a position that has created difficulties for cognitive psychology as well as anthropology (Lave, 1988, p. 8).

Such a functional theory also includes theories of learning:

(...) children can be taught general cognitive skills (...) if these "skills" are disembedded from the routine contexts of their use. Extraction of knowledge from the particulars of experience, of activity from its context, is the condition for making knowledge available for general application in all situations (Lave, 1988, p. 8).

Traditional teaching, in the form of lectures, is a typical example of this, as the pupils are being separated from the common and everyday context, with which they are familiar. Here we enter the discussion of transfer of learning. The basic idea is that knowledge achieved in a context free environment can be transmitted to any other situation. Underlying such a conception is also an idea about a common equality between cultures (Lave, 1988, p. 10).

Such theories have been strongly criticised. One might argue, as Bartlett did in the introduction to Lave (1988), that generalisations about people's thoughts based on laboratory experiments are contradictions of terms (Lave, 1988, p. 11):

For if experimental situations are sufficiently similar to each other, and consistently different from the situations whose cognitive activities they attempt to model, then the validity of generalisations of experimental results must surely be questioned.

Bartlett further suggested that observations of everyday life activities within a context should form a base for the design of experiments. Others have argued against theorising about cognition like that, based on the analysis of activities within a context. In order to connect a theory of cognition with a theory of culture, we will therefore have to specify which theories we are talking about. These theories are, according to Lave, no longer compatible. Lave proposed an approach where the focus is on everyday activities in culturally organised settings. By everyday life activities, Lave simply means the activities people perform daily, weekly, monthly, or in other similar cycles. We may call this a 'social-practice theory', and it will lead to different answers to questions on cognitive activity than a functionalist theory will (Lave, 1988, p. 11 onwards).

There have been several studies on informal mathematics in western cultures. Some of these studies have focused on the kind of mathematics that adults use outside school. We have just taken a brief look into a study like that (Lave, 1988). In another study smaller children and their elementary arithmetic skills were the objects of investigation.

Both lines of investigation have demonstrated that it is one thing to learn formal mathematics in school and quite another to solve mathematics problems intertwined in everyday activities (Nunes, Schliemann & Carraher, 1993, p. 3).

Any form of thinking or cognition in everyday life situations is dependent on several components, as Lave commented on. She claimed that every activity in mathematics is formed according to different situations or contexts. AMP – Adult Math Project – was a project where adults' use of arithmetic in everyday life situations was studied. Some of the main questions in this project were how arithmetic unfolded in action in everyday settings, and if there were differences in arithmetic procedures between situations in school scenarios and everyday life scenarios. The AMP project investigated how adults used arithmetic in different settings.

The research focused on adults in situations not customarily considered part of the academic hinterland, for no one took cooking and shopping to be school subjects or considered them relevant to educational credentials or professional success (Lave, 1988, p. 3).

Based on years of research on arithmetic as cognitive practice in everyday life situations, some conclusions have been drawn, and the following could be presented as the 'main conclusion':

The same people differ in their arithmetic activities in different settings in ways that challenge theoretical boundaries between activity and its settings, between cognitive, bodily, and social forms of activity, between information and value, between problems and solutions (Lave, 1988, p. 3).

This research originates from a common conception that the knowledge presented to you in school automatically can be transferred to other situations. Conventional theory, like transfer theory, assumes that arithmetic is learned in school in the same normative fashion that it is taught, and that the pupils carry with them this knowledge and apply it in any situation that calls for it. These

assumptions are not supported by the results of Lave's study, and she claimed that this is not to be expected if one thinks of arithmetic practice as constructed within a certain context. This forms the philosophical background for the study.

Arithmetic practice in everyday life is of interest beyond its immediate scope and value to practitioners because of these relations between theory, practice and the attribution to subjects' practice of a common set of principles (Lave, 1988, p. 6).

2.4.2 Legitimate peripheral participation

'Legitimate peripheral participation' is a process which is characteristic of learning viewed as situated activity. This concept implies that learning is an activity where a 'beginner' participates in a community of practitioners, and that:

(...) the mastery of knowledge and skills requires newcomers to move toward full participation in the sociocultural practices of a community (Lave & Wenger, 1991, p. 29).

Learning is then viewed as the process of becoming a full member or participant of a certain socio-cultural practice, similar to a model of apprenticeship that we discuss in chapter 2.4.4.

Lave and her colleagues initially experienced the need to distinguish between the historical forms of apprenticeship and their own metaphorical view of the subject. This led to the conception of learning as 'situated learning'. In order to clarify the concept of 'situatedness', and to integrate the idea that learning is an integral aspect of social practice, they presented the concept of legitimate peripheral participation. They characterised learning as legitimate peripheral participation in communities of practice (Lave & Wenger, 1991, p. 31).

In the concept of situated activity we were developing, however, the situatedness of activity appeared to be anything but a simple empirical attribute of everyday activity or a corrective to conventional pessimism about informal, experience-based learning (Lave & Wenger, 1991, p. 33).

According to this new perspective every activity is situated. Learning would have to be viewed as a situated or social activity in itself. Now they would interpret the notion of situated learning as a transitory concept, or as:

(...) a bridge, between a view according to which cognitive processes (and thus learning) are primary and a view according to which social practice is the primary, generative phenomenon, and learning is one of its characteristics (Lave & Wenger, 1991, p. 34).

Learning is therefore not only situated in practice, but it is an integral part of social practice in everyday life. The conception of legitimate peripheral participation fits into this model in the following way:

Legitimate peripheral participation is proposed as a descriptor of engagement in social practice that entails learning as an integral constituent (Lave & Wenger, 1991, p. 35).

This concept is to be understood more as an analytical viewpoint or a way of understanding learning than a pedagogical strategy or method of teaching. While analytical concepts and viewpoints might be interesting and useful for researchers, teaching practices will often be of more interest to teachers and teacher educators. Situated learning and legitimate peripheral participation are concepts that

might help us understand teaching and learning, but in classrooms where these kinds of learning situations can be found, interesting approaches that touch upon the ideas of connecting school mathematics with everyday life should be found.

2.4.3 Two approaches to teaching

Boaler (1997) described teaching strategies at two different schools. The focus was on learning in context. One school had a traditional approach, and mathematical theories were presented in an abstract way, without much reference to their contexts. The other school had a progressive approach, and mathematics was taught in a more open way. Projects and activities were situated in a reasonable context. The two schools were called 'Amber Hill' and 'Phoenix Park'. We have analysed Boaler's work to see if the study of these two extremes could give us more knowledge about the ideas of situated learning or learning in context.

The first school in Boaler's study, Amber Hill, was a more traditional school. The teaching was traditional and often strictly textbook based. In most lessons the pupils would be seated in pairs, but they still worked independently. A typical approach was that the teacher described what the pupils should do and explained questions and rules on the blackboard. When this presentation was finished, the pupils were told to start working on textbook tasks. Whenever they encountered difficulties, the teacher would come along and help them (Boaler, 1997, p.13).

The pupils worked devotedly in class, and they were well behaved and calm. Most of them were highly motivated for learning mathematics, and they really wanted to perform well in what they believed to be a very important subject. The mathematics teachers provided a friendly atmosphere, and their contact with the pupils was good (Boaler, 1997, p. 12 onwards).

At Phoenix Park, on the other hand, they had a far more progressive philosophy, and this was especially noticeable in the teaching of mathematics. The pupils normally worked with projects of an open character, and they had a large degree of freedom. Boaler summed it all up in these points:

- the teachers had implicit rather than explicit control over students;
- the teachers arranged the context in which students explored work;
- students had wide powers over the selection and structure of their work and movements around the school;
- there was reduced emphasis upon the transmission of knowledge; and
- the criteria for evaluating students were multiple and diffuse (Boaler, 1997, p. 17).

Each year the mathematics course consisted of four or five main themes, with ideas for projects and exploratory work. Each topic contained distinct goals. The mathematics department at the school had a relaxed attitude towards the national curriculum as well as the evaluation of the work. The pupils at Phoenix Park would normally learn mathematics by using open-ended questions. In year 11 the preparations for the final exam began. During this period the projects were abandoned, and the pupils were placed in three different groups according to their needs.

The pupils were then presented with different kinds of tasks where they had to apply the theories to more practical problems, and they were also given standardised tests, to investigate what Lave called situated learning. We could say that this was done to uncover the pupils' structural conception of the subject matter. In this connection, Boaler had an interesting discussion on real-life connections:

Of course, the ways in which students react to applied tasks in school can never be used to predict the ways in which they will react to real-life mathematical situations. However, I believe that the degree of

realism provided by applied tasks, combined with the artificiality of the school setting, provides important insight into the different factors that influence a student's use of mathematical knowledge (Boaler, 1997, p. 64).

The differences between the pupils in these two schools were then discussed, and this discussion was based on the test results, the experiences and thoughts of the pupils, different kinds of knowledge the pupils had acquired, etc.

The pupils at Phoenix Park developed an understanding of mathematics which enabled them to make use of the theories in a quite different manner than was the case with the Amber Hill pupils. This came to show particularly when they were faced with more applied problems. The fact that the Phoenix Park pupils performed equally well, or slightly better, in traditional tests, was perhaps more surprising. Boaler concluded that the pupils at these two schools had developed different kinds of mathematical knowledge. The pupils at Phoenix Park proved to be more flexible and able to adapt the mathematical theories to different situations, and they seemed to have a better understanding of the methods and theories. The Amber Hill pupils, on the other hand, had developed knowledge of mathematical theories, rules and algorithms, but they appeared to have difficulties recalling these later. A reason for this could be that they had not really understood the methods thoroughly, but mainly memorised the methods and algorithms presented by the teachers. These methods were then applied to problems (Boaler, 1997, p. 81).

An important distinction between the character of the knowledge that the pupils at these two schools developed is connected with their ability to apply school mathematics to situations outside school:

At Amber Hill, the students reported that they did not make use of their school-learned mathematical methods, because they could not see any connections between the mathematics of the classroom and the mathematics they met in their everyday lives. At Phoenix Park, the students did not regard the mathematics they learned in school as inherently different from the mathematics of the 'real world' (Boaler, 1997, p. 93).

The Amber Hill pupils experienced little connection between school mathematics and everyday life. They would thereby often reject school mathematics and come up with their own methods in everyday life situations. The pupils seemed to believe that the mathematics they learned in school belonged to a completely different world than the one they lived in (Boaler, 1997, p. 95).

Boaler summed it all up by saying that the Amber Hill pupils had problems with new or applied problems. They believed that memory was the most important factor for success in mathematics, not cognition. The opposite was the case for the Phoenix Park pupils. When these pupils described how they used mathematics, they emphasised their ability to think independently and adapt the methods to new situations (Boaler, 1997, p. 143 onwards).

Even though Boaler would not claim that the Phoenix Park approach gave a perfect learning environment, it was quite clear that she was strongly critical towards the traditional way of teaching. She also concluded that the results of her study would not suggest a move towards the model of teaching that was presented at Amber Hill. She stated that the most important result of the study was not to indicate that the differences between the school concerned good or bad teaching, but rather to point at the possibilities of open and closed approaches to teaching, and the development of different kinds of knowledge (Boaler, 1997, pp. 146-152).

Over the years since Boaler's study the situation in Britain has changed. The present teaching philosophy would be more in favour of drill-like preparations for the final exam. Boaler found it provoking that there no longer seems to be room for teachers who want to try out new approaches in

British schools. The board at Phoenix Park returned to a more textbook based teaching in order to adjust to the governmental initiatives.

Schools in England and Wales now have to teach the same curriculum and most of them have adopted the same traditional pedagogy and practice, because they believe that this is what is required by the National Curriculum and the examination system. Phoenix Park's open, project-based approach has been eliminated and there is a real possibility that the students who left the school in 1995 as active mathematical thinkers will soon be replaced by students of mathematics who are submissive and rule-bound and who see no use for the methods, facts, rules and procedures they learn in their school mathematics lessons (Boaler, 1997, p. 152).

In the US, the skill-drill movement also has a strong foundation. There have, however, been attempts made to incorporate other approaches. The Everyday Mathematics curriculum is one example (see chapter 2.6.1.3). In Norway, there is a continual discussion among the different fractions, and there are people who would like to move away from the approach of our current curriculum and back to a more traditional skill-drill approach.

2.4.4 Apprenticeship

The idea of learning certain skills from a master in a master-disciple relationship is not new. It has been a main educational idea from the beginning of time. The different disciplines of knowledge have been passed on from generation to generation. Jesus selected 12 disciples to pass on his words, and the master-disciple relationship can be found in most cultures around the world. Socrates used the same approach and so did his followers. Plato and Aristotle developed it a bit further and founded their own academies, but the idea was the same. A more skilled master tutored his disciples, who eventually became masters themselves. Only later did the idea appear that learning should take place in a large class, listening to some kind of lecture. The ideas of apprenticeship are still alive in handicraft, industrial production, etc.

Pedagogical thinking has also been influenced by the ideas, and apprenticeship is viewed as an educational process:

Apprenticeship as an institution, irrespective of its workplace context, is also an educational process and like formal education has been assumed to rest on a transmission model of learning. However, unlike formal education, the institution of apprenticeship is also assumed to be underpinned by the dual assumptions of learning by doing and a master as the role model, rather than any model of curriculum or formal instruction (Guile & Young, 1999, p. 111).

Guile & Young (1999) tried to link learning at work with learning in the classroom in an ambitious and important effort towards a new theory of learning. The aspect of transfer of learning is also discussed:

As we shall suggest in this chapter, apprenticeship offers a way of conceptualizing learning that does not separate it from the production of knowledge or tie it to particular contexts. It can therefore be the basis of a more general theory of learning that might link learning at work and learning in classrooms, rather than see them only as distinct contexts with distinct outcomes (Guile & Young, 1999, p. 112).

Even though some people would argue against it, there seems to be an agreement that most of the knowledge we possess is not innate. We need to learn.

Small children, and sometimes adults, learn through trial and error, often guided by imitation of those more proficient. Children learn to walk and adults learn bicycle riding in this manner (Dreyfus & Dreyfus, 1986, p. 19).

There is a development from rule-guided ‘knowing-that’ to experience-based know-how. Dreyfus & Dreyfus (1986) believe that the individual passes through at least five stages, as his or her skills improve. These five stages of skill acquisition would often serve as a model of how learning develops in an apprenticeship (see also Flyvbjerg, 1991):

- 1) Novice
- 2) Advanced beginner
- 3) Competent
- 4) Proficient
- 5) Expert

2.5 Historical reform movements

The tradition of activity pedagogy spans from Rousseau, through Pestalozzi and Fröbel, towards the representatives of the last century: Montessori (cf. Montessori, 1964), Decroly, Kerschensteiner (cf. Sunnanå, 1960), Claparède, Karl Groos and Dewey (cf. Dewey, 1990; Vaage, 2000, etc.). Common for all these is the idea that teaching or rather learning in school should be based on the children’s spontaneous interests. All of these pedagogues had ideas and theories about the psychology of the child, and they made important contributions to general pedagogy.

With Piaget we get the first detailed description of the characteristic intelligence structures of the child in its different developmental stages. According to Piaget, the child actively constructs its own knowledge through a process of accommodation and adaptation. He believed that intelligence is active and creative by nature. An important concept here is the concept of operative knowledge. This kind of knowledge differs from the knowledge that appears in empirical learning theories, and it is constructed by the child when confronted with concrete problems. It is important for a teacher to understand that children do not learn concepts verbally, but through action. Based on this, the child should be given the opportunity to learn through experimentation and manipulation with concrete materials. After the age of 11, the child has reached a level where it is able to test a hypothesis internally. Piaget calls this the stage of formal operations. The child is now able to perform mental actions (cf. Hundeide, 1985).

Piaget’s conception of operative knowledge can be translated to personal knowledge. Herein lies an implication for schools. According to the theories of Piaget, schools should teach a kind of knowledge that emanates from the children’s own experiences and interests. It is therefore a paradox that so many pupils seem to be bored at school. According to the theories of active construction, a teacher who wants to promote personal knowledge in the pupils should give them time and freedom to work with problems based on their own knowledge, reformulate the problem, discuss it with their classmates and teachers, make hypotheses and try them out, etc. At a higher level they can write essays and interpretations of the problems (Hundeide, 1985, pp. 39-40).

In Montessori pedagogy, which has been one of the most important alternative school systems at the pre-school and elementary level, a main idea is that of apprenticeship. Montessori pedagogy also presents a holistic view of learning. The subjects are integrated in the teaching just as they are in real life (cf. Montessori, 1964).

Criticism has also been levelled against the Montessori method. Montessori has been compared with Dewey. They had much in common, but Dewey went a lot further to build on a pedagogical theory (Lillard, 1976, p. 30).

Dewey influenced what we call reform pedagogy in the US, a child-centred pedagogy that had strong elements of activity. His name is in particular connected to the concept of ‘learning by doing’ or activity-learning, the first being a concept that sometimes has been reformulated ‘learning by Dewey’, reflecting the importance of his name in these theories. Many of Dewey’s theories concern activity learning, that children learn through their activities, and that the aim was for the teacher to direct this activity (cf. Dewey, 1990). He also believed that learning is closely connected with the social environment. The main task of the teacher will therefore be to arrange things so that the child gets the opportunity to stimulate and develop its abilities and talents. This is in strong contrast to a classic deductive method of teaching. All teaching should, according to Dewey, be based on the everyday life of the child. This should be the case, not only for mathematics or other isolated subjects. He also believed that one should be cautious about distinguishing the subjects from each other too early. We recognise such thoughts from certain schools with a more project-based approach. The idea of connecting teaching with the child’s everyday life will also be important where the development of curricula and decisions about the content of the school subjects are concerned (cf. Vaage, 2000).

2.5.1 Kerschensteiner’s ‘Arbeitsschule’

The ideas of the ‘Arbeitsschule’, as initially developed by Kerschensteiner, strongly influenced the Norwegian curriculum of 1939, N39. Georg Kerschensteiner (1854-1932) was one of the main contributors to activity pedagogy in Germany, and he might be regarded as the founder of the German ‘Arbeitsschule’. He was a mathematician, and had studied under Felix Klein in Munich. He did not find any suitable methods of teaching mathematics in the didactic textbooks, and he therefore invented a new approach, where he tried to let the intricate results of mathematics emerge from the learning material. Through doing this, he wanted to satisfy the curiosity among the pupils and let them present the problems. This method of work was not written up in any didactic textbook, but it was the starting point for all methods in this school system (Sunnanå, 1960, p. 78).

When he studied the works of Dewey and Huxley, Kerschensteiner found that the mathematical explorations and mathematical thinking of these two could become the foundational idea in the ‘Arbeitsschule’. When working together with pupils in biology, he found himself being both student and teacher. He was able to try out the ideas of his ‘Arbeitsschule’, and he found that the study of living nature suited him better than abstract research and thinking. Mathematics became a means to reach pedagogical aims (Sunnanå, 1960, p. 79).

The ideas of the ‘Arbeitsschule’ gained importance in Norwegian schools with the national curriculum of 1939, where the principles were introduced. A central issue of the ‘Arbeitsschule’ was that the teaching should be practical, and the pupils should be trained to become workers. An implication of this was that abstract knowledge became less important than practical work. This is one of the aspects that differentiate these ideas from most of the other ideas of activity pedagogy.

In the French tradition, Célestin Freinet and Ovide Decroly have been important contributors to the tradition of activity pedagogy. Freinet pedagogy contains ideas of pedagogy of work, cooperative learning, enquiry-based learning, the natural method (inductive approach) and the children’s interest in learning. Freinet’s concept of work differs somewhat from Kerschensteiner’s, as he believed work to be the process of spontaneous re-organisation of life in school and society.

2.6 Contemporary approaches

The ideas of active construction and the connection with pupils' everyday life, what we might call situated learning, learning in context, etc., have provided a basis for several new schools and educational experiments. We will look into some of these schools and educational ideas now, to investigate how these ideas have been carried out already.

2.6.1 The US tradition

In the US school system, the progressive ideas of Dewey and his peers were substituted with the behaviourist ideas of Thorndike and his colleagues. Assessment and standardised tests have been important characteristics of US education for some decades, and high scores on these standardised tests have become of vital importance for pupils climbing the different levels of US schools. The National Council for Teachers of Mathematics has become an important contributing agent in the debate on curriculum reforms in the US, and the NCTM Standards movement has also gained much influence on the most recent Norwegian curricula.

2.6.1.1 The NCTM Standards

The National Council for Teachers of Mathematics published the first standards for school mathematics in 1989. The Standards function as an intended curriculum. Mathematical understanding is emphasised, and the pupils should frequently use mathematics to solve problems in the world surrounding them. Knowing mathematics is doing mathematics, according to these standards, and the active participation of the pupils is underlined (NCTM, 1989, p. 7).

One of the central goals of the Standards is problem solving, and word problems make up an important part of this goal. The Standards call for an inclusion of word problems that (a) have a variety of structures, (b) reflect everyday situations, and (c) will develop children's strategies for problem solving (NCTM, 1989, p. 20). Some believe that word problems created by the pupils could serve as a means for reaching this central goal of the NCTM Standards, and that this would also be potentially interesting for the pupils (Bebout, 1993, p. 219).

Mathematical knowledge is important for understanding the physical world. The need to understand and be able to use mathematics in everyday life has never been greater than now, and it will continue to increase. These ideas are connected with the idea of mathematical literacy:

Mathematical literacy is vital to every individual's meaningful and productive life. The mathematical abilities needed for everyday life and for effective citizenship have changed dramatically over the last decade and are no longer provided by a computation-based general mathematics program (NCTM, 1989, p. 130).

When summing up the changes in content, the following is stated (NCTM, 1989, p. 126):

Algebra:	the use of real-world problems to motivate and apply theory
Geometry:	real-world applications and modelling
Trigonometry:	realistic applications and modelling
Functions:	functions that are constructed as models of real-world problems

These points are taken from a context, but we still see a clear connection to the realistic, real-world problems and applications in all topics. And these are points that have received even increased attention in the new curriculum standards.

We live in a time of extraordinary and accelerating change. New knowledge, tools, and ways of doing and communicating mathematics continue to emerge and evolve. Calculators, too expensive for common use in the early eighties, now are not only commonplace and inexpensive but vastly more powerful. Quantitative information available to limited numbers of people a few years ago is now widely disseminated through popular media outlets. The need to understand and be able to use mathematics in everyday life and in the workplace has never been greater and will continue to increase. Four categories are distinguished: Mathematics for life, Mathematics as a part of cultural heritage, Mathematics for the workplace and Mathematics for the scientific and technical community...In this changing world, those who understand and can do mathematics will have significantly enhanced opportunities and options for shaping their futures. Mathematical competence opens doors to productive futures. A lack of mathematical competence keeps those doors closed (NCTM, 2000, pp. 4-5).

It is vital for the pupils to learn and understand mathematics, and the pupils need to actively build the new knowledge upon their previous knowledge. This is presented as one of the main principles of the NCTM Standards, and it leads us to the Dutch RME tradition, well known for the ideas of reinvention and realistic mathematics (see chapter 2.6.3).

2.6.1.2 High/Scope schools

High/Scope is a US school that is based on Howard Gardner's theories of multiple intelligences (cf. Gardner, 2000, etc.). They are concerned with the idea of active learning, as the introduction of their educational program shows:

The cornerstone of the High/Scope approach to early elementary education is the belief that active learning is fundamental to the full development of human potential and that active learning occurs most effectively in settings that provide developmentally appropriate learning opportunities (High/Scope, 2002a).

They have developed curricula for pre-school, elementary school and adult education. In these curricula, we discover ideas of connecting learning with the experiences and interests of the pupils. These ideas are similar to some of the thoughts we found in the Montessori pedagogy, and in the theories of Dewey and reform pedagogy, and they implicate a positive attitude towards the interests and knowledge of the child.

By promoting the curriculum's instructional goals while simultaneously supporting the children's personal interests, ideas, and abilities, teachers encourage students to become enthusiastic participants in the active learning process (High/Scope, 2002a).

Active learning is viewed as a process of constructing knowledge, and the High/Scope curriculum offers what they call a set of 'key experiences', or learning objectives in areas such as language, mathematics, science, movement and music. In these key experiences, a teacher-student interaction is involved. This is an important part of the High/Scope idea.

The teacher-student interaction involved in these High/Scope learning experiences - teachers helping students achieve developmentally sequenced learning objectives while also encouraging them to set many of their own goals - distinguishes High/Scope's curriculum from others (High/Scope, 2002a).

Active learning is considered a social experience, and the approach involves many opportunities for the pupils to engage in social processes with friends, families and the community. Cooperative learning activities within and outside the classrooms are also provided.

The philosophy of the High/Scope curriculum is based not only on Gardner's theories of multiple intelligences, but also on developmental psychology:

The foundation of the High/Scope elementary approach is shaped by the developmental psychologies of Froebel, Dewey, Piaget, emergent literacy researchers, and others, and by the cognitive-developmental school of western philosophy (High/Scope, 2002b).

When it comes to the distinct plan for mathematics, we encounter ideas about the connections with everyday life. These connections are involved in a process where the child is actively constructing knowledge:

High/Scope's constructivist approach regards mathematics as primarily involving a set of relations that hold between abstract objects. In this view, the "abstraction" of relations is not transmitted simply by direct instruction but by the child's construction of such relationships through the process of thinking in mathematical terms and of creating solutions for problems encountered in daily life (High/Scope, 2002c).

Small-group math workshops of 50-60 minutes per day and individual plan-do-review activities are the main ingredients of the mathematical activities.

The math workshop consists of three or four small-group math activities and occasional large-group sessions. In the small groups, children work with manipulatives or computers on problem-solving tasks set out and introduced by the teacher before the workshop begins. The small-group activities occur simultaneously and children rotate from one group to another either within the hour or over several days (High/Scope, 2002c).

The plan-do-review activities may relate to the concepts and materials introduced in the workshops, but more typically, they are projects generated from the pupils' interests.

In summary, the school builds on a constructivist viewpoint, where the active involvement of the pupils is in focus, as well as extensive use of manipulatives, problem solving and communication of mathematical information (High/Scope, 2002c).

2.6.1.3 UCSMP – Everyday Mathematics Curriculum

Many would argue that it should always be a goal for research in mathematics education to improve school mathematics. This has to do with teaching issues, learning issues, curriculum development, improvement of textbooks, resources, etc. The University of Chicago School Mathematics Project (UCSMP) is a long-term research project with the aim of improving school mathematics in grades K-12 (Kindergarten through 12th grade). It started in 1983, and in 1985 they began developing the Everyday Mathematics curriculum. This not only includes a curriculum as such, but an entire mathematics programme, including textbooks, teacher manuals, resource books, etc. Up till now, programmes for grades K-6 have been completed, field tested and published.

The Everyday Mathematics curriculum is a rich programme, which contains many elements, organised in a holistic way. Some main questions were raised in the research that led to the curriculum, which is now in use in many schools in the US, and these are presented in the preface of all teacher manuals:

- What mathematics is needed by most people?
- What are the actual capabilities of young children, and to what extent have those capabilities been recognized and built upon in the usual school mathematics experience?

- What resources and support do most teachers have in typical schools?
- How can the teaching of “useful” mathematics be made a practical goal for most teachers of children aged 5 to 12?

This research, and reports from large-scale international studies, led to a number of principles for developing the Everyday Mathematics curriculum:

- From their own experience, students develop an understanding of mathematics and acquire knowledge and skills. Teachers and other adults are a very important part of that experience.
- Students begin school with knowledge and intuition on which they are ready to build.
- Excellent instruction is very important. It should provide rich contexts and accommodate a variety of skills and learning styles.
- Practical routines should be included to help build the arithmetic skills and quick responses that are so essential.
- The curriculum should be practical and manageable and should include suggestions and procedures that take into account the working lives of teachers.

This curriculum should be both rigorous and balanced, building conceptual understanding while still maintaining mastery of basic skills. It aims at exploring not only basic arithmetic, but the full mathematical spectrum, and perhaps even more important: it should be based not only on what adults know, but also on how children learn, what they are interested in, and it should prepare them for the future. In this way, they want to build a curriculum that prepares the pupils for employment in the 21st century.

Even though the title of the curriculum would indicate that it has a main (and perhaps only) focus on real-life connections, this is not the case. It is a rich programme that incorporates several ideas, teaching principles and theories. We see this quite clearly when we look at some key features of the curriculum programme:

- Problem solving for everyday situations
- Automaticity with basic number facts, arithmetic skills, and algebra
- Practice through games
- Ongoing review
- Sharing ideas through discussion
- Cooperative learning
- Projects
- Daily routines
- Links between past experiences and explorations of new concepts
- Informal assessment
- Home and school partnership

These are only key words, and they display an incorporation of an impressive number of theoretical links from the research field of mathematics education. We focus mainly on what the Everyday Mathematics programme tells us about the connection to everyday life, or real-life, which are the terms mostly used in this programme.

Research and teachers' experiences have shown that students who are unable to solve a problem in a purely symbolic form often have little trouble when it is presented in an everyday context. As children get older, these contexts can go well beyond everyday experiences and provide the basis for constructing more advanced knowledge, not only in mathematics, but also in the natural and social sciences (p. xi).

They also draw upon ideas of other researchers (cf. Nunes, Schliemann & Carraher, 1993; Burkhardt, 1981, etc.). In a booklet about the Everyday Mathematics programme this is also presented as a fundamental principle for teachers:

Children need to draw on their own real-world experiences in problem-solving situations. In addition, they must be challenged to use their emerging mathematics knowledge to solve real-life problems (p.3)

2.6.2 The British tradition

An important factor in the development of mathematics education in Britain was the Cockcroft report, which also gained influence on the current Norwegian curriculum. Based on this report, Afzal Ahmed and other researchers connected to the Mathematics Centre in Chichester have organised several important research projects concerning the learning of mathematics. Two of the largest and most important projects were called LAMP (The Low Attainers in Mathematics Project) and RAMP (Raising Achievement in Mathematics Project). Both projects were directed towards the development of mathematics curricula. The Chichester researchers have also produced a series of interesting booklets with ideas, teaching sequences, etc., with the aim of improving the teaching of mathematics in school. We will discuss both in the following, but we start off with a discussion of the Cockcroft Report, which preceded both LAMP and RAMP.

2.6.2.1 The Cockcroft report

Already in the introductory part of this important British report, mathematics is presented as an important subject:

Few subjects in the school curriculum are as important to the future of the nation as mathematics (Cockcroft, 1982, p. iii).

Most people regard it as an essential subject, together with the mother tongue, and that it would be difficult to live a normal life in the twentieth century (at least in the western world) without making use of any mathematics.

The usefulness of mathematics is perceived in different ways. For many it is seen in terms of the arithmetic skills which are needed for use at home or in the office or workshop; some see mathematics as the basis of scientific development and modern technology; some emphasise the increasing use of mathematical techniques as a management tool in commerce and industry (Cockcroft, 1982, p. 1).

And further:

A second important reason for teaching mathematics must be its importance and usefulness in many other fields. It is fundamental to the study of the physical sciences and of engineering of all kinds. It is increasingly being used in medicine and the biological sciences, in geography and economics, in business and management studies. It is essential to the operations of industry and commerce in both office and workshop (Cockcroft, 1982, p. 2).

The report provides quite a thorough discussion of the usefulness of mathematics, and how much mathematics one actually needs to know in adult life. Contrary to what one might believe, this can be summed up briefly as follows:

In the preceding chapters we have shown that, in broad terms, it is possible to sum up much of the mathematical requirement for adult life as ‘a feeling for number’ and much of the mathematical need for employment as ‘a feeling for measurement’ (Cockroft, 1982, p. 66).

These rather limited aspects represent what adults actually need of mathematical knowledge in everyday life. Practical use is not the only parameter by which to judge mathematical activity in school. This is an important view, shared by many teachers. Mathematical puzzles, games and problem solving activities are also important aspects of the subject. Nevertheless, everyday use of mathematics is important, and mathematics should be presented as a subject both to apply and to enjoy (Cockroft, 1982, p. 67).

Practical tasks and pupil activities are also highlighted, and it is underlined that these ideas are certainly not new, as we will see in the outline of the historical development of Norwegian curricula in chapter 4. All children need to experience practical work related to the activities of everyday life. Pupils cannot be expected to have the ability to make use of mathematics in everyday life situations, unless they have had the opportunity to experience these situations for themselves in school (Cockroft, 1982, pp. 83-87).

When the children first come to school, mathematics is about applications. When they apply the mathematical knowledge to practical situations, they build an ownership and a sense of independence towards mathematics. The pupils therefore work with exploring and investigating mathematics, but this depends on the teacher:

The extent to which children are enabled to work in this way will depend a great deal on the teacher’s own awareness of the ways in which mathematics can be used in the classroom and in everyday life (Cockroft, 1982, p. 94).

The teacher’s awareness is important, and in our study the main aim is to explore the beliefs of the teachers, how clearly they are aware of these ideas, and how the ideas are applied.

2.6.2.2 LAMP – The Low Attainers in Mathematics Project

Why can children handle money situations in town on Saturday and fail to do the ‘sums’ in school on Monday?

This is one of many questions introducing the LAMP report, which is one of several post-Cockroft studies in England. Afzal Ahmed, who was member of the Cockroft Committee, was the director of the study, which resulted in a report called *Better mathematics* (Ahmed, 1987). Already in the introduction to the report, they introduced the issue that many pupils have problems with seeing the connection between mathematics and other subjects, or between mathematics and everyday life. This is often the case, even when the pupils succeed in mathematics (Ahmed, 1987, p. 4).

It might be interesting to learn what teachers and pupils believe mathematics is. Many conceive mathematics as a finished set of rules and methods, used to solve certain kinds of problems. The report follows up on this discussion:

Mathematics seems to be understood by most people to be a body of established knowledge and procedures - facts and rules. This describes the forms in which we observe mathematics in calculations, proofs and standard methods. However, most mathematicians would see this as a very narrow view of their subject. It denies the value of mathematics as an activity in which to engage. Decision making, experimenting, hypothesising, generalising, modelling, communicating, interpreting, proving, symbolising and pattern finding are all integral parts of that activity. Without engaging in processes such as these, no mathematician would have been able to create the procedures and systems mentioned above in the first place (Ahmed, 1987, p. 13).

Teachers commonly teach mathematics as it is presented in the textbook, and they teach the mathematics they expect the pupils to be faced with at the final exam. This can easily influence the conception of the subject of mathematics itself, and important aspects of the subject might be lost.

Teachers often experience that pupils do not understand certain topics, even though they have been presented to them several times earlier. Pupils often lack the motivation and inspiration to work on mathematics problems. The 'step-by-step' method does not always work the way it was supposed to. The report claims that pupils need good and challenging problems to work with, so they can experience and (re-)discover mathematics for themselves. A comparison between junk food and junk mathematics is made in the report, where junk mathematics is oversimplified mathematics, unrelated to real life.

This can appear in class when the pupils are taught rules and notations without getting any understanding of why and how these rules and notations have developed.

JUNK MATHEMATICS

It looks well structured and appears logical, but is dull and lacks substance.

Pupils are unable to retain or apply it in new contexts.

It offers no real life situations but invents and contrives them.

DANGER: HEALTH WARNING

Junk mathematics can seriously damage your pupils.

(Ahmed, 1987, p. 15)

To teach the subject in this way is to obscure the main reasons why people have enjoyed making and using mathematics, and to deny pupils the experience of actually doing mathematics themselves (Ahmed, 1987, p. 15).

The children must find their own methods and strategies, and it should be avoided that the teacher presents a set of fixed methods and rules for the children to learn. The discussion results in a general statement:

Mathematics is effectively learned only by experimenting, questioning, reflecting, discovering, inventing and discussing. Thus, for children, mathematics should be a kind of learning which requires a minimum of factual knowledge and a great deal of experience in dealing with situations using particular kinds of thinking skills (Ahmed, 1987, p. 16).

The report presents two caricatures of classroom situations. The first, called the 'classical', has a high focus on getting the right answer. The teacher is in possession of all the answers, and the pupils want to be told how to approach different kinds of problems in order to get these answers. In a situation like this the pupils often dislike mathematics, try to avoid it, and their ability to think creatively and independently seems to be missing, or only exists in small proportions. In the other classroom, the pupils are highly motivated. They find or elaborate suitable problems themselves, and the mathematical activity itself is a source of motivation. The pupils are creative and use their knowledge and experience in an active approach to mathematics. The teacher is almost invisible in this classroom (Ahmed, 1987, p. 17).

In the years after the Cockroft report, the principle of investigation gained greater influence with mathematics teachers. This trend has now turned. Teachers experience explorative work as yet another topic to cover in their teaching, and they ask questions like “How much time am I supposed to spend doing investigations?” (Ahmed, 1987, p. 20).

One might believe that the pupils succeed if the mathematics they meet in class can be related to their everyday life. A more nuanced view is presented in the report:

For mathematical activity to be meaningful, it needs to be personally fulfilling. This could either be because of its perceived relevance or because of its intrinsic fascination to the pupil/mathematician (Ahmed, 1987, p. 23).

The knowledge and strategies the pupils attain must not be isolated, but they have to be applicable to other subjects in and outside school.

2.6.2.3 RAMP - Raising Achievement in Mathematics Project

The findings of LAMP, which was aimed at low attainers, turned out to be useful for a much wider group of pupils. The Raising Achievement in Mathematics Project lasted from 1986 to 1989, and Ahmed was again Project Director. RAMP was a research and development project that built upon the ideas of LAMP, but now it was not only aimed at low attainers. The idea was to raise achievement among all pupils. One of the goals of the project was the following:

(...) enabling pupils to apply their knowledge and skills in mathematics in other school subjects and to life in general (Ahmed, 1991, p. 3).

Research in mathematics education normally wishes to improve teaching, or even the pupils' achievements in mathematics. This was also the case for RAMP.

The main concern of the teachers involved with the Project has been to raise their pupils' achievement in mathematics. The mathematical requirements of daily life and the industrial and commercial world have also been prominent in the teachers' minds (Ahmed, 1991, p. 6).

A point is made at the way mathematics was described in the guiding principles of the National Curriculum Council:

Mathematics provides a way of viewing and making sense of the world. It is used to analyse and communicate information and ideas and to tackle a range of practical tasks and real-life problems (Ahmed, 1991, p. 6).

An important point about learning mathematics and its complexities is underlined:

(...) if pupils could learn just by being trained to perform certain mathematical manipulations, we would not be in the position we are in concerning standards in mathematics. Similarly, acknowledging pupils' abilities only by measuring the number of facts they can remember does not necessarily indicate that they can apply mathematics to situations in life, commerce and industry (Ahmed, 1991, p. 7).

This can be viewed as a criticism of the ideals of behaviourism and the skill-drill-school. It also presents a view of the pupil and learning where memory is not necessarily the most important

criterion for learning mathematics. On the other hand understanding is emphasised, as well as the pupils' ability to apply their knowledge of mathematics to other areas in life.

RAMP is also based on the Cockroft report, and they refer to an important statement:

We believe it should be a fundamental principle that no topic should be included unless it can be developed sufficiently for it to be applied in ways which the pupils can understand (Cockroft, 1982, p. 133).

Then a list of criteria to evaluate the pupils' improvement is presented:

- examination results (where applicable);
- test and assignment marks;
- attitude to mathematics i.e. showing enjoyment, perseverance, motivation, confidence and interest;
- willingness to take responsibility for organising their own work in mathematics both within and outside school;
- ability to work co-operatively, discuss and write about mathematics;
- using practical equipment and technological devices;
- ability to apply their knowledge and skills in mathematics to other subjects and life in general;
- a willingness and interest to study mathematics beyond the age of 16 (Ahmed, 1991, p. 9).

The aim of the project is to improve the pupils' mathematical skills on all levels. This cannot be done easily, and there are numerous ways of accomplishing this.

In our experience the best starting point is for teachers to examine their own perceptions and practices in order to assess the current situation and determine an agenda for action which is appropriate and effective for their situation (Ahmed, 1991, p. 19).

This implies a continuous process of development, which is important for the teacher as a professional.

These changes do not involve a sudden introduction of new schemes, syllabuses, resources, organisational structures or an adoption of a particular teaching style. However, they require honest in-depth analysis and trials by teachers in order to evolve effective strategies which are applicable to a variety of situations (Ahmed, 1991, p. 19).

After this basic discussion, the results of the project are presented as guiding principles for the teachers (see Ahmed, 1991, pp. 19-21). The importance of these points is underlined.

We are in no doubt that if teachers were to work on these strategies, it would considerably enhance both pupils' involvement and achievement in mathematics (Ahmed, 1991, p. 21).

As these points seem to constitute a more specific and short version of the results and conclusions of RAMP, we will present them all here. They are concrete points or ideas about how to include the pupils' everyday life experiences, and how to activate the pupils:

- a) Involve pupils in simple starting-points, then try asking how they might vary these or what questions they could think up to answer next. Collect together pupils' suggestions for

- variations or questions, perhaps on the board or a large sheet of paper and try inviting them to follow up a suggestion of their choice.
- b) Ask pupils to keep a record of questions or other ideas they have not attempted. Encourage them to choose one of those questions to work at on appropriate occasions.
 - c) Put up examples of pupils' own questions on display. Invite groups to look at and perhaps work on other groups' questions.
 - d) Turn round some of the questions pupils ask you so that they can be involved in answering them.
 - e) Do not always give pupils things which work, invite them to try some which do not and say why they do not.
 - f) Give pupils some tasks with few spoken or written instructions and encourage them to make and develop their own interpretations.
 - g) Encourage pupils to find methods for themselves. Try to involve pupils in comparing the methods to agree on the most efficient.
 - h) Involve pupils in situations in which you encourage them to stipulate their own rules, to agree on equivalences etc.
 - i) Think of ways in which pupils can be involved in processes such as searching for patterns, making and testing conjectures.
 - j) Before teaching generalisations, see if you can think of ways of involving pupils in generalising for themselves.
 - k) When you want pupils to practise skills, think whether it would be possible for such practice to emerge through pupils' own enquiries.
 - l) Think how you might "twist" tasks and questions described in textbooks or worksheets to involve pupils in making more of their own decisions and noticing things for themselves.
 - m) When pupils are working from a textbook or worksheet and say "We are stuck", try asking them what they think the question or explanation means.
 - n) Try giving pupils a particular page of a text or a worksheet and asking them to consider what they think it means and what the questions are asking people to do.
 - o) Avoid your own explanations dominating pupils' mathematics. Think of questions you could ask to encourage pupils to extend their own lines of thinking.
 - p) Keep reminding pupils of the importance of asking themselves "Is this sensible?", "Can I check this for myself?" Think how decisions relating to the "correctness" of a piece of mathematics could develop within the activity itself.
 - q) Show pupils examples of mistakes. Ask them to sort out what the mistakes are and to think how they might have arisen.
 - r) Consider how you might incorporate the terms and notations which you want pupils to learn, so that meaning can be readily ascribed to them and that they can be seen as helpful and necessary.
 - s) Always allow pupils openings for continuing work.
 - t) When you want to make a point about something, consider whether you can use what a pupil has done to help make the point so that it does not appear as simply your idea.
 - u) Avoid asking pupils simply to "write it down". How might they be encouraged to feel a need to write?
 - v) Encourage pupils to reflect on what structures they themselves used to sort out some problem, and to see if this is applicable to other situations.
 - w) Encourage pupils to look for connections between old and new situations, ideas and skills and to ask themselves whether something they did previously might be of use.
 - x) When a pupil comes up with something which appears initially to be off the track, try to stop yourself from immediately implying that that is the case. What about the possibility of it being kept as a "further idea" for later? (Ahmed, 1991, pp. 19-21).

This extensive list of teaching ideas involves most aspects we are discussing in our study, and these ideas can be found in many curriculum frameworks around the world. We also recognise several

points that are in common with ideas presented in the Norwegian L97. A main focus here is that the teacher should structure the teaching based on the pupils. He or she should encourage them to actively seek meaning and structure in mathematics. In this way, the pupils will get the feeling that they have created, or at least recreated, the theory themselves. This increases the possibility of them remembering the ideas better. We discover distinct parallels to the theories of Hans Freudenthal here.

2.6.3 The Dutch tradition

The Dutch tradition of mathematics education is closely linked to the works of Hans Freudenthal. A main idea of Freudenthal was to teach mathematics as an activity. The pupils should learn systematising, and they should focus on the activity of systematising rather than the end result.

What humans have to learn is not mathematics as a closed system, but rather as an activity, the process of mathematizing reality and if possible even that of mathematizing mathematics (Freudenthal, 1968, p. 7).

Freudenthal was also interested in everyday life in this respect, and he argued that a major aim was to teach mathematics for it to be useful. We will also see that he adopted the principles of genesis, in what he called ‘reinvention’ of mathematics. The pupil, through his or her own activities, should reinvent the mathematical theories and principles, with guidance from the teacher. The idea of reinvention is not a new one, and it is not solely a Dutch construct. The theory that has been advocated in the more general theories of constructivism also:

The constructivist stance is that mathematical understanding is not something that can be explained to children, nor is it a property of objects or other aspects of the physical world. Instead, children must “reinvent” mathematics, in situations analogous to those in which relevant aspects of mathematics were invented or discovered in the first place. They must construct mathematics for themselves, using the same mental tools and attitudes they employ to construct understanding of the language they hear around them (Smith, 2002, p. 128).

The idea has been much used among Dutch researchers, and by Freudenthal in particular. He discussed mathematics according to common sense, and he believed that mathematics in some sense is a structuring of what we can apprehend with our consciousness. Lots of things happen on the way though, which contribute to the fact that pupils do not understand it like this any more.

Indeed, as pointed out earlier, mathematics, unlike any other science, arises at an early stage of development in the then “common sense reality” and its language in the common language of everyday life. Why does it not continue in this way? (Freudenthal, 1991, p. 18).

As we have already mentioned, Freudenthal described learning in mathematics as reinvention. In this respect he mentioned the genetic principle, which he believed to be a label for the same ideas.

History teaches us how mathematics was invented. I asked the question of whether the learner should repeat the learning process of mankind. Of course not. Throughout the ages history has, as it were, corrected itself, by avoiding blind alleys, by cutting short numerous circuitous paths, by rearranging the road-system itself. We know nearly nothing about how thinking develops in individuals, but we can learn a great deal from the development of mankind. Children should repeat the learning process of mankind, not as it factually took place but rather as it would have done if people of the past had known a bit more of what we know now (Freudenthal, 1991, p. 48).

This process was considered by Freudenthal a difficult one, making great demands on the teacher. The pupil's freedom of choice will be limited in the process, because he is going to (re-)create something that is new to him, but well known to the teacher. Freudenthal further described mathematics as mathematizing:

Mathematics has arisen and arises through mathematizing. This phenomenological fact is didactically accounted for by the principle of guided reinvention. Mathematizing is mathematizing something -- something non-mathematical or something not yet mathematical enough, which needs more, better, more refined, more perspicuous mathematizing. Mathematizing is mathematizing reality, pieces of reality (Freudenthal, 1991, p. 66-67).

Reality was not a simple thing according to Freudenthal. There exist as many realities or everyday contexts as there are people. Nevertheless we can say that:

(...) as soon as mathematizing is didactically translated into reinventing, the reality to be mathematized is that of the learner, the reality into which the learner has been guided, and mathematizing is the learner's own activity (Freudenthal, 1991, p. 67).

Reality is not as simple as theory, and in a process of mathematizing from reality we have to make some choices and simplifications. Therefore Freudenthal believed that the pupils' mathematizing or reinvention did not necessarily have to take place in the reality of today, but rather in an idealised primordial reality (Freudenthal, 1991, p. 67).

Freudenthal presented examples of different kinds of quasi problems of this kind: "a ship is loaded with 26 sheep and 10 goats. How old is the captain?" He showed how children 'solve' these kinds of problems using certain algorithms. He also showed that with minor adjustments to the problems, they no longer fit to the children's algorithms, and they therefore conclude that they do not know enough. It was in this context he mentioned the so-called cognitive conflicts:

Magic sometimes works and sometimes does not. Or do the fresh examples provoke what is called a cognitive conflict? "Cognitive conflict" is an adult contraption. Cognitive conflicts have first to be experienced as conflicting realities. If there are no bonds with reality, then conflicting realities cannot provoke cognitive conflicts (Freudenthal, 1991, p. 73).

The researchers at the Freudenthal Institute in Utrecht, Holland, continue this tradition. An important project for the institute is what they call 'Realistic Mathematics Education' (RME). On their homepage, they describe the project like this:

Study situations can represent many problems that the students experience as meaningful and these form the key resources for learning; the accompanying mathematics arises by the process of mathematization. Starting with context-linked solutions, the students gradually develop mathematical tools and understanding at a more formal level. Models that emerge from the students' activities, supported by classroom interaction, lead to higher levels of mathematical thinking (<http://www.fi.ruu.nl/en/>)

The term 'realistic' is important in RME, and we have to be aware of the distinctions in the Dutch way of understanding this:

In Dutch, the verb 'zich realiseren' means 'to imagine'. In other words, the term 'realistic' refers more to the intention that students should be offered problem situations which they can *imagine* (see Van den Brink, 1973; Wijdeveld, 1980) than that it refers to the 'realness' or authenticity of problems. However, the latter doesn't mean that the connection to real life is not important. It only implies that

the contexts are not necessarily restricted to real-world situations. The fantasy world of fairy tales and even the formal world of mathematics can be very suitable contexts for problems, as long as they are 'real' in the students' minds (van den Heuvel-Panhuizen, 2003, pp. 9-10).

2.6.3.1 Realistic Mathematics Education

Realistic Mathematics Education (RME) is the main educational theory of The Freudenthal Institute. It is based upon the theories of Freudenthal himself, but RME has also been revised over the years.

The theory is linked to Freudenthal's notion of curriculum theory, which he claimed not to be a fixed set of theories, but a by-product of the practical enterprise of curriculum development (van Amerom, 2002, p. 52). Freudenthal focused on the usefulness of mathematics in school.

If mathematics education is intended for the majority of students, its main objective should be developing a mathematical attitude towards problems in the learner's every-day life. This can be achieved when mathematics is taught as an activity, a human activity, instead of transmitting mathematics as a pre-determined system constructed by others (van Amerom, 2002, p. 52).

One of Freudenthal's main expressions was the notion of 'mathematizing', which describes the process of organising the subject matter, normally taken from a practical, real-life situation. This includes activity, which has been an important part of learning theory in RME. When teaching mathematics, the emphasis should be on the activity itself and its effect. This process of mathematization represents the very manner in which the student reinvents or re-creates the mathematical theories. The concept of mathematization has later been extended by Treffers (1987), van Reeuwijk (1995) and others. Treffers made a distinction between horizontal and vertical mathematization, and this had been adopted by other researchers within the field:

Horizontal mathematization concerns the conversion from a contextual problem into a mathematical one, whereas vertical mathematization refers to the act of taking mathematical matter to a higher level (van Amerom, 2002, p. 53).

The base for this (horizontal) mathematization should be real life. But the main object of the theory is activity, as van Amerom sums up:

(...) from Freudenthal's perspective mathematics must above all be seen as a human activity, a process which at the same time has to result in mathematics as its product (van Amerom, 2002, p. 53).

Gravemeijer & Doorman (1999) elaborate further on the concept that mathematizing may involve both everyday-life subject matter and mathematizing mathematical subject matter, in the terms of horizontal and vertical mathematization. They explain these concepts like this:

Horizontal mathematization refers to the process of describing a context problem in mathematical terms - to be able to solve it with mathematical means. Vertical mathematization refers to mathematizing one's own mathematical activity (Gravemeijer & Doorman, 1999, p. 117).

When both these components are included, they call it progressive mathematization. Mathematizing was the core mathematical activity for Freudenthal, and he viewed this activity by the pupils as a way of reinventing mathematics (Gravemeijer & Doorman, 1999, p. 116).

The idea of re-construction or re-invention is central to the Dutch tradition, and van der Kooij gives a good description of it:

In the realistic view, the development of a concept begins with an intuitive exploration by the students, guided by the teacher and the instructional materials, with enough room for students to develop and use their own informal strategies to attack problems. From there on, the learning trajectory leads, via structuring-, abstracting and generalizing activities, to the formalization of the concept (van der Kooij, 2001, p. 237).

Contextual problems, which could be both real world problems and realistic problems, serve as a starting point for this development of a concept. They also provide a source of applications. Of course, these ideas are not new. The principle of guided reinvention is one of the main principles of Freudenthal's theory and we let van Amerom quote Freudenthal's own definition of this principle:

Urging that ideas are taught genetically does not mean that they should be presented in the order in which they arose, not even with all the deadlocks closed and all the detours cut out. What the blind invented and discovered, the sighted afterwards can tell how it should have been discovered if there had been teachers who had known what we know now. (...) It is not the historical footprints of the inventor we should follow but an improved and better guided course of history (van Amerom, 2002, p. 36).

We see, especially from this last definition, that guided re-invention has close relationships with a genetic approach, especially according to the notions of Toeplitz (1963) and Edwards (1977). The main idea is that pupils should be given the opportunity to experience the development of a mathematical theory or concept in a way similar to how it originally developed (van Amerom, 2002, p. 53). When this principle is used in teaching, the history of mathematics can be used as a source of inspiration, or as an indicator of possible learning obstacles (epistemological obstacles). Freudenthal explained that a genetic approach does not imply teaching the concepts in the order in which they arose. We also find these thoughts in the works of Felix Klein, one of the 'founders' of the genetic principle in mathematics education:

In fact, mathematics has grown like a tree, which does not start at its tiniest rootlets and grow merely upward, but rather sends its roots deeper and deeper at the same time and rate that its branches and leaves are spreading upwards. Just so (...) mathematics began its development from a certain standpoint corresponding to normal human understanding, and has progressed, from that point, according to the demands of science itself and of the then prevailing interests, now in the one direction toward new knowledge, now in the other through the study of fundamental principles (Klein, 1945, p. 15).

Teaching should rather follow an improved and better-guided course of history, like an 'ideal' version of the history. These thoughts were shared by Toeplitz:

When applying the indirect genetic method, there is no need to teach history. The application of this method does not necessarily have anything to do with history, and Toeplitz was not interested in history as such. What mattered to him, and to others who make use of this method, was the very genesis of the concepts. The teacher should follow the genetic path, in much the same way as mankind has gradually progressed from basic to more complex patterns in the course of history (Mosvold, 2002, p. 13).

Van Amerom sums it all up and says that history can be found helpful to design a hypothetical learning trajectory and use parts of it as a guideline for teaching (van Amerom, 2002, p. 37). These ideas are also implemented in the work of Streefland (1991). He shows how teaching should be arranged in order to do justice to the historical learning process.

It does not mean that the student must literally retrace the historical learning process but, rather, that he proceeds according to its spirit. The point, in other words, is to outline the path taken by learning by rationally reconstructing the historical learning process. This can prevent starting the learning process at too high a level of abstraction and, at the same time, can help implement a gradual progression in mathematization according to an historical example (Streefland, 1991, p. 19).

When the teacher is guiding the pupils through a process of reinventing the mathematical concepts and ideas, as in RME, context problems are of great importance. Gravemeijer & Doorman (1999) states that context problems are the basis for progressive mathematization in RME, and that:

The instructional designer tries to construe a set of context problems that can lead to a series of processes of horizontal and vertical mathematization that together result in the reinvention of the mathematics that one is aiming for (Gravemeijer & Doorman, 1999, p. 117).

Context problems are defined in RME as problem situations that are experientially real to the pupil. A glorious aim for the teaching of mathematics according to these principles can be stated as follows:

If the students experience the process of reinventing mathematics as expanding common sense, then they will experience no dichotomy between everyday life experience and mathematics. Both will be part of the same reality (Gravemeijer & Doorman, 1999, p. 127).

These are closely related to some main ideas in the Norwegian curriculum L97:

Learners construct their own mathematical concepts. In that connection it is important to emphasise discussion and reflection. The starting point should be a meaningful situation, and tasks and problems should be realistic in order to motivate the pupils (RMERC, 1999, p. 167).

2.6.4 Germany: ‘mathe 2000’

In 1985, the German state of Nordrhein-Westfalen adopted a new syllabus for mathematics at the primary level. This syllabus provided the background for the project called ‘mathe 2000’, and it marked a turning point in German mathematics education for several reasons:

- The list of objectives contains also the so-called general objectives “mathematizing”, “exploring”, “reasoning” and “communicating” which reflect basic components of doing mathematics at all levels
- The complementarity of the structural and the applied aspect of mathematics is stated explicitly and its consequences for teaching are described in some detail
- The principle of learning by discovery is explicitly prescribed as the basic principle of teaching and learning.

The project was founded in 1987, at the University of Dortmund, under the chairs of Gerhard N. Müller and Erich Ch. Wittmann, in order to support teachers in putting this syllabus into practice. The project was influenced by the works of John Dewey, Johannes Kühnel, Jean Piaget and Hans Freudenthal.

Postmodern philosophy rediscovered the meaningful context as an indispensable aspect of all human activity, including mathematical activity (Wittmann, 2001, p. 540).

Wittmann suggested using capital letters to describe MATHEMATICS as mathematical work in the broad sense. He then included mathematics in science, engineering, economics, industry, commerce, craft, art, education, daily life, etc.

The consequences for the teaching and learning of mathematics at the university should be clear: In teaching mathematics to non-specialists the professional context of the addressees has to be taken fundamentally and systematically into account. The context of mathematical specialists is appropriate for the training of specialists, not for the training of non-specialists (Wittmann, 2001, p. 540).

The professional context to consider was the teaching of mathematics at primary level.

In the 1985 syllabus in Nordrhein-Westfalen, mathematical processes were emphasised, and the principle of learning by discovery was presented as the basic principle of teaching and learning. The phases of the learning process were described in the syllabus like this (Wittmann, 2001, p. 541):

- 1) starting from challenging situations; stimulate children to observe, to ask questions, to guess;
- 2) exposing a problem or a complex of problems for investigation; encouraging individual approaches; offering help for individual solutions;
- 3) relating new results to known facts in a diversity of ways; presenting results in a more and more concise way; assisting memory storage; stimulating individual practice of skills;
- 4) talking about the value of new knowledge and about the process of acquiring it; suggesting the transfer to new, analogous situations.

The formation of this curriculum was much influenced by similar developments in the Netherlands in particular. An important element was introduced:

However, as experience shows, it is not enough just to describe new ways of teaching in general terms. The natural way to stimulate and to support the necessary change within the school system is to restructure teacher education according to the organisation/activity model. Only teachers with first hand experiences in mathematical activity can be expected to apply active methods in their own teaching as something natural and not as something imposed from the outside. Therefore all efforts in pre-service and in-service teacher education have to be concentrated on reviving student teachers' and teachers' mathematical activity (Wittmann, 2001, p. 542).

Although university courses in mathematics often contain a combination of lectures and practice, in Germany as well as in Norway, Wittmann claimed that the practice sessions tend to be merely a practice of theories and methods introduced in the preceding lecture.

So more or less students' individual work and work in groups tend to be subordinated to the lecture. Frequently, work in groups degenerates into a continuation of the lecture: The graduate student responsible for the group just presents the correct solutions of the tasks and exercises (Wittmann, 2001, p. 543).

Wittmann felt that there was an inconsistency in the methods he used in his own mathematics courses and the methods he recommended in his courses in mathematics education. He then came up with an idea, called the O-script/A-script method:

The basic idea, the Alpha and Omega, of this method is very simple: Just take Johannes Kühnel literally in teacher education and replace 'guidance and receptivity' by 'Organisation and Activity', that is, use both the lecture and the group work for organizing student activities (Wittmann, 2001, p. 543).

There is an important distinction between what is called the A-script and the O-script here:

An essential ingredient of this new teaching/learning format is a clear distinction between the text written down by the lecturer on the blackboard or the overhead projector and the text elaborated by the individual student. As the lecturer's main task is to organize students' learning her or his text is called the 'O-script'. It is not a closed text, but it contains many fragments, leaves gaps, and often gives only hints. Therefore it is a torso to be worked on. As the elaborated text expresses the student's individual activity it is called the 'personal A-script' (Wittmann, 2001, p. 543).

When thinking about how lectures could be organised in order to contain more student activity, Wittmann was inspired by Giovanni Prodi, who claimed that the teaching should be more focused on problems than theories. A theory should be formed only when it is necessary to distinguish a certain class of problems, and David Gale, who claimed that the main goal of all science is first to observe, then to explain. As a result of this, Wittmann's courses were divided into two parts. First the pupils were introduced to a list of carefully selected generic problems to work on, while the second part consisted of more ordinary lectures to present the theoretical framework (Wittmann, 2001).

Selter brought up the discussion of mathematics as an activity and context problems:

Starting from Freudenthal's claim that humans should learn mathematics as an activity, the core principle of Realistic Mathematics Education is that 'formal' mathematical knowledge can be derived from children's thinking. Thus, the pupils should contribute to the teaching/learning process as much as and wherever it is possible. All learning strands should begin with the informal, context-bound methods of children, from which models, schemes, shortcuts, and symbolizations are developed. Good context problems are crucially important here because they provide the seed for models that have to be close to children's context-related methods as well as to formal operations (Selter, 1998, p. 2).

Selter distinguished between the two components of progressive mathematization like this:

Vertical mathematisation, in which reorganizations and operations within the mathematical system occur, and horizontal mathematisation, where mathematical tools are used to organize and solve problems in real-life situations (Selter, 1998, p. 2).

The horizontal component deals with solving real-life problems, and this is elaborated further on in the following:

Real-life problems are an important source of understanding which gradually bridge the gap between informal and formal mathematics. In this sense the vertical component can also be described as mathematizing mathematics. Alternatively, the horizontal component should also always be present (mathematizing reality) in order to keep the bonds to reality. The chosen context need not necessarily be real-life, but can, for example, also be fairytales as long as (1) they make sense to children and as (2) they encourage processes of mathematizing that are (potentially) relevant to reality (Selter, 1998, p. 4).

The German scholars quoted above therefore appear to have a similar understanding of the word 'realistic' and real-life connections as in the Dutch tradition. The main focus is on whether the contexts are meaningful to the pupils, and it is not crucial if they are from real life or not.

2.6.5 The Japanese tradition

In the TIMSS Video Studies, Japan stood out as a remarkable country, where the teaching and learning of mathematics was concerned. The pupils were high achieving, the teachers often reflected on their activities, and they were well trained in the teaching processes. The lessons were extremely well organised. Already a few years before the TIMSS, results of another study were presented, comparing classrooms in China, Taiwan, Japan and the US (Stevenson & Stigler, 1992). In this study also, the Asians were praised, and the Japanese system seemed to be on top.

Another country's way of teaching and organising education could probably never be successfully copied, because education, learning and teaching are strongly cultural processes, and there is probably no universal method of teaching that will always provide the best results. However, we believe that it is not only possible but also extremely valuable to look at other cultures' way of teaching in order to enhance the teaching and education in one's own country. With this in mind, we will take a closer look at the Japanese approach, as presented by Stevenson & Stigler (1992), and also in the TIMSS Video Studies.

First it should be mentioned that Japan, like Norway, has a national curriculum, which is a very detailed one, describing what should be taught, how many hours should be spent on each topic, etc. There are only a few different textbook series that dominate the Japanese market, and all of them have to fit the intentions of the curriculum. The textbooks are quite similar to each other, and they differ mainly in their superficial features, such as how the problems are presented and the order in which the concepts are presented. Japanese textbooks are also quite thin. They contain few illustrations, and they depend on the teachers to assist the pupils (Stevenson & Stigler, 1992, pp. 138-140).

The attitude towards the teaching profession is also quite different in the Asian countries. A western idea is that good teaching skills are more or less innate. A good teacher is born, not made. When a student leaves the college of teacher education, he is regarded a fully trained teacher. In the Asian countries, and also in Japan, the real teacher education takes place in the schools, after the teacher has left teacher education. Teacher education is much like an apprenticeship in Japan, and the teachers receive a large amount of in-service experience. The system is focused on passing on accumulated wisdom of teaching practice to the next generation of teachers. During the first year, the teachers are guided and observed by master teachers, and there is a continual requirement for a teacher to perfect his teaching skills in interaction with other teachers (Stevenson & Stigler, 1992, pp. 159-160). This approach to the development of teaching practice is also supported by other researchers:

Our argument, we believe, is in concurrence with that made by Stigler and Hiebert (1999), who after reviewing the TIMSS video study that compared hundreds of lessons across the U.S., Germany and Japan, suggested that the Japanese lesson study (*jogyou kenkyuu*) could serve as a possible model for teachers' professional development. Their line of thinking is simply that to improve student learning we must improve teaching practice, and nowhere can the improvement of teaching take place better than in the classroom, where teachers, pupils, and the objects of learning meet face to face (Pong & Morris, 2002, p. 14).

According to the TIMSS 1999 Video Study, the classrooms in Japan (Grade 8) contained less real-life connections than any of the other six countries of study. Supposedly then, the Japanese teachers were less likely to include references to and connections with everyday life, and more likely to include purely mathematical problems. Stevenson & Stigler (1992) presents a slightly different result, claiming that in fifth Grade, more than 80% of the Japanese lessons contained a written or oral real-world problem, whereas less than 20% did so in the US (Stevenson & Stigler, 1992, p. 180). Now, this study was carried out in one Japanese city only (and one city of about the same size

in the US, China and Taiwan), and the TIMSS 1999 Video Study was of eighth Grade classrooms rather than fifth Grade. In both studies, it appeared to be a normal approach for Japanese teachers to focus on only a few problems for each lesson.

The classes worked to a considerable extent with a problem-solving approach, and the pupils would often be involved in reconstructing the mathematical theories, providing and discussing their own solution methods, etc. The Japanese teachers were also much more likely to use concrete materials in their teaching than the US teachers, and what seemed perhaps most remarkable was how the Japanese teachers used mistakes effectively. Japanese teachers would seldom tell a pupil that he had produced a wrong answer, but rather let the pupils agree on which solution method was more correct. The pupils would actively discuss and decide which methods to use and which answers were correct. The teachers would also give pupils the time they needed to figure it out, without spoiling the learning opportunity by presenting an answer the pupils could easily figure out themselves.

2.6.6 The Nordic tradition

2.6.6.1 Gudrun Malmer

Gudrun Malmer is the grand old lady in Nordic mathematics education. She was awarded an honorary doctorate by the University of Gothenburg, and she has experience from school, as a teacher, special teacher, principal, lecturer at a college of teacher education, etc. She has also written several books, and she is still an active participant in the research community, as a lecturer at conferences, etc.

One of her main interests is to educate the pupils to think mathematically, to make them understand what they are doing when doing mathematics in class. She also wants them to see how this relates to the mathematics they meet outside school.

In my active years of work I was often out on visits in classes. On one such instance I was in an 8th grade class. A pupil was working on an example where the task was to calculate the interest for an entire year on a loan of 65 700 SEK with an interest rate of 12,25%. After some button pushing the pupil got the answer 804 825 SEK.

I wondered about this and asked carefully if it wouldn't have been better to pay off the entire loan, which was no more than 65 700 SEK. "How come?" the pupil said and continued to look for the answer at the back of the book. He was happy to find it and put in a decimal sign so that the answer was 8 048, 25 SEK. He looked at me triumphantly and said "The numbers were at least right!"

I thought a little chat was a good idea. It turned out that he lived in a house and he was pretty sure that they had a loan on the property. He didn't know how much of course. When I wondered how it would have been if the bank had claimed an amount of interest that was more than a hundred times as large as what was right, he actually reacted. Certainly there was a difference between real life and school mathematics! (Malmer, 2002, p. 10)

This example shows that many pupils experience a difference, sometimes even a rather large difference, between school mathematics and the mathematics of real life. An important task for the teacher is therefore to stimulate the pupils to work in a way that makes this difference as small as possible.

It is not easy to change practised routines and modes of work, but I believe that it is absolutely necessary to change the teaching of mathematics towards less calculating – more thinking, fewer

exercises for the hand and more for the head if we think about the conventional number of algorithm exercises, that they can be replaced by effective mental calculations/estimations combined with the use of pocket calculators (Malmer, 2002, p. 11).

Malmer believes that school mathematics to a too large extent has been formalised. The pupils are somewhat programmed to do calculations in a certain way, and the mathematics they meet is mostly about:

(...) writing numbers in empty boxes and turning pages in the book. It is also a good thing to get as far as possible. Then you are clever and possibly get a gold star (Malmer, 2002, p. 11).

School mathematics is often motivated with external stimuli. And by doing this, mathematics is removed from the original context, where it was supposed to serve a purpose. She believes that we have to spend more time in school on oral mathematics and what she calls 'action-mathematics'. The pupils need time to think and talk about mathematics.

You have to start with and actualise the experiences of the children and put the things you see and do into words. In this way you invest in the "raw material" that has to be present if the pupil is to have the skills to create basic mathematical concepts (Malmer, 2002, p. 11).

When it comes to difficulties in learning mathematics, we often see that adults make use of mathematics in several everyday situations, without any problems, but as soon as they are confronted with anything looking like school mathematics, they experience great difficulties coping with it. Malmer takes up this discussion, and she concludes:

I draw the conclusion that what the grown ups have learned from life, from everyday life, in spite of school, they have direct access to, while everything that reminds them of school mathematics would easily promote anxiety and a lack of self confidence when they think of all the failures in the past. In that tragic way many people can become totally blocked (Malmer, 2002, p. 14).

2.6.6.2 Speech based learning

When discussing context-based teaching, the method of speech-based learning (LTG – 'Læring på Talemålets Grunn') is often mentioned. This method is especially familiar from language teaching in school.

In short, the teacher writes what the pupils say in the class discussions on the blackboard or similar, and the children learn to read through the text they have created themselves. The text is thoroughly worked with, and they work with letters and sentences and see how the grammatical forms change. The pupils write down the words they have chosen, sort and archive their own materials. In this way the close connection between speech and text is being made early on (Imsen, 1998, p. 200).

Malmer writes about mathematics as a language and presents the concept of MTG (speech based mathematics) as a parallel method of work.

If children are to get any meaning out of words they read, they must naturally recognise them and know what they mean. In similar ways children must be able to interpret the mathematical symbols and experience that these have a real content. This implies that one must also collect material from the children's own real life, in order to let it be a starting point for simple computing activities (Malmer, 1999, p. 63).

These ideas were put to the test in the GUMA-project (the GULvik-school in Malmö). In this project, directed by Malmer, the teachers participating adapted the method of LTG from reading to mathematics teaching in the first three years of primary school. She presents the following process chain:

THOUGHT ACTION LANGUAGE SYMBOLS

A closer description of these points says:

- At the first stage we use the experiences of the children. But since these are quite variable, and sometimes even totally inadequate, the teaching must be formed in a way where the children can make new experiences
- At the second stage we take advantage of the creativity of the children by starting with real life as much as possible. But in the process of abstraction it is necessary to use both pictures and working material of different kinds. The children's own drawings and working material are important forms of expressing their thought process.
- The third stage contains the verbal communication and is used in order to describe the real life that the pupils have already adapted. A poor and limited vocabulary often prevents the comprehension of the necessary basic concepts, which are essential in order to use mathematics as a tool for solving the problems of everyday life later in life.
- The fourth stage – the concentrated language of mathematical symbols – should only be presented when the concepts have become deeply ingrained (Malmer, 1989, pp. 27-28)

Behind such a teaching method (which strongly resembles a process of mathematization, as described in the Dutch tradition) lies the idea that children normally come to school without knowing how to read or write, but they know how to talk. Then it will be difficult to learn mathematics in the classical sense. Instead the teachers will then try and create learning situations based on what the pupils are capable of, in speaking and thinking. Learning situations are created, where the pupils can experience and detect mathematical relations and concepts through action and words. Later they create the language and symbols necessary. This process is described as speech-based mathematics teaching (MTG).

The aim of this project was that the children should be stimulated to use their own experience in the process of constructing mathematical concepts. The project was carried through according to plan, and the experiences were mainly positive. In spite of this, Malmer does not believe in this as a kind of universal method that always works in a classroom situation. But the teachers should have as their goal to liberate the inner capacities and strengths of the pupils, to strengthen their confidence and make them feel pleasure and responsibility in the activities at school (Malmer, 1989, p. 31).

The focus in our project is everyday mathematics and the activities conducted by the teacher. These points become clearly visible in Malmer's MTG-method. The 'thought-phase' is also called the experience-phase, and here one should provide the pupils with the opportunity to draw upon their own experiences when learning new concepts. The next phase called 'action' is also called the working phase. The focus here is on the activities of the children. In this connection Malmer points to the learning model of Maria Montessori (Malmer, 1989, p. 34).

Malmer believes that we should provide plenty of opportunities for pupils to explore and work on practical tasks, not only in the lower grades, but throughout the entire compulsory education. By doing this, the children would build a knowledge of their own, which could more easily be combined and used in new situations (Malmer, 1989, p. 34 onwards).

2.6.6.3 Everyday mathematics in Sweden

In 1993, a project about everyday life knowledge and school mathematics was completed in Sweden. This was a project where teachers tried to connect school mathematics with the everyday life experiences of the pupils. Wistedt (1990) presents some of the research questions in the preface:

- how pupils in middle school uses their competence in practical mathematics in school; how they interpret the textbook problems and develop their own thoughts on the mathematical content and what influence a connection with known problem contexts and everyday life situations has in this connection,
- how teachers are able to encounter and actualise content from everyday mathematical activities in their teaching; how they interpret and transform the pupils' everyday knowledge and what mathematical possibilities they see in these,
- what generative value, pedagogically and subject-theoretically speaking, that exists in the content that is developing in the relation between teachers and pupils; what does it mean, for instance, for the pupils' long term understanding of mathematical concepts and operations that the teaching draws upon their experiences, and what possibilities and risks lie within such a way of working?

Wistedt points to a debate which had been going on in Sweden in the years prior to 1990. This debate was influenced by the Cockroft report, and it focused on what was wrong with the teaching of mathematics in elementary school. Suggestions for change moved towards an approach where the teaching of mathematics should be more connected with everyday life.

School mathematics, they say, should become connected to the children's everyday life experiences, and collect material from the environment that surrounds the pupils (Wistedt, 1990, p. 2).

Words like 'everyday life' and 'reality' have become even more common in the pedagogical debate, and in the curricula of several countries. There does not seem to be an equally strong agreement about what knowledge of everyday life is, or what this term might cover. Partly, it describes the kind of knowledge children and grown ups attain in their daily activities, but it also contains the competence needed to cope with the challenges of everyday life activities and work. The report by Wistedt deals with the kind of everyday knowledge that is attained in everyday life (Wistedt, 1990, p. 3).

The idea that the teaching of mathematics should be realistic and meaningful certainly is not a new one. These ideas have been present in curricula and discussions for centuries. Even though we got a new chapter in the Norwegian national curriculum in 1997 called 'mathematics in everyday life', the ideas of connecting mathematics with everyday life have been present in more or less every curriculum we have had in our country. The labels might differ, but the ideas have been there all along. Wistedt shows how these ideas have been debated in Sweden earlier.

Wistedt goes through the theoretical background in the field, and she points to the widespread impression that school mathematics and the mathematics in everyday life belong to two separate worlds. Some researchers believe that references to everyday activities are likely to provoke several inferences and presuppositions from the children. As a result, she suggests that perhaps it is the ability to see school mathematics as something different from the mathematics of everyday life that makes it possible for pupils to generalise their knowledge (Wistedt, 1990, p. 16).

Based on the theories of Piaget, we would say that learning school mathematics is dependent on the continual development of knowledge in everyday life, i.e. school mathematics must be assimilable to provide meaning for the pupil. Niedderer (1987) explains such a view further:

Our aim is not to replace students' theories (related to everyday-life thinking) by the scientific theory but to arrive at a conscious knowledge of both and to learn scientific concepts by learning the differences between their own everyday-life thinking and scientific thinking (quoted in Wistedt, 1990, p. 19).

There seemed to be a common attempt to make mathematics more concrete and realistic for the pupils in Sweden at the time, and Wistedt therefore believes that there should be a good chance of finding teaching sequences where the pupils are given the possibility to develop their own personal mathematical thinking. In a later report, Wistedt sums up the project we have gone into above:

Results from the project "Everyday life knowledge and school mathematics" implies that a connection with a well known content does not automatically help the pupils to comprehend mathematics. It actually seems that there is an increased risk of the pupils missing the mathematical ideas in the problem if the content is well known ... They need, in short, to be able to make a distinction between everyday and mathematical interpretations of a problem (Wistedt, 1993, p. 3).

She therefore believes that the teaching, which is connected with everyday life, should serve as a context to help the pupils. Wistedt concludes that teaching does not always work like this. Too often, such an approach becomes more of a hurdle for the pupil, yet another task to deal with, namely to understand what the teacher is aiming at. Connecting the teaching with the pupils' everyday life does not always work magic when it comes to their understanding of mathematics. Teachers often understand that such a connection might be valuable, but they are not always able to identify what they should connect to from the experiences of the children (Wistedt, 1993, p. 4).

A more recent Swedish study was carried out by Palm (2002), and this study focused on realistic problems and tasks. A main notion of Palm's is 'authenticity', and he concludes:

The results of the study show that authenticity, *even under the restrictive constraints of normal classroom resources*, can affect students' tendencies to effectively use their real world knowledge in the solutions to word problems (Palm, 2002b, p. 31).

These results are consistent, he claims, with results of other studies in other countries. A main reason for the unrealistic solutions that appeared in the answers of the pupils was their beliefs about school mathematics in general and the solving of word problem in particular:

These beliefs do not include requirement that school mathematics and real life outside school must be consistent. On the contrary, they do include the ideas that all tasks have a solution, that the solution is attainable for the students, and that the answer is a single number (Palm, 2002b, p. 33).

Palm calls for a clear definition of concepts, and he also deals with the possible difference between 'problem' and 'task', as he claims that they are sometimes considered equivalent, but that 'problem' is sometimes restricted to non-routine tasks.

However, when used together with the term 'realistic', 'real life' and 'real world', the possible difference in meaning between these two concepts has rarely been an issue (Palm, 2001, p. 21).

2.7 *Everyday mathematics revisited*

This thesis has a main focus on mathematics in everyday life, as defined in chapter 1.6, but the international research literature often refers to the term ‘everyday mathematics’. This chapter will focus on some of this literature.

Many recent curriculum reforms emphasise understanding rather than memorizing mathematical concepts and theories, and they present several ways in which pupils can develop this understanding. Some believe that they should learn to understand mathematics by applying it to realistic word problems, while others believe they should apply mathematics to real world problems outside the classroom (Cooper & Harries, 2002, p. 1).

Connecting school mathematics with everyday life is not a new idea, and we have already seen that the issue is connected with main theories within the field of mathematics education in particular and with theories of pedagogy in general. From a Nordic perspective, mechanical learning of mathematics was criticised by Swedish researchers in pedagogy already in the last part of the 19th century. In 1868 a Swedish journal of pedagogy published an article by A.T. Bergius, who wrote that the organisation of textbooks was poor because they supported routine learning of several similar tasks with little connection to the pupils’ everyday life. The following year, E.G. Björling wrote an article containing similar thoughts, and he presented the aims of mathematics as being to develop the intellectual faculties and to prepare for the practical demands of life in a modern society (Prytz, 2003, pp. 43-48).

Four criteria for good teaching of mathematics could be extracted from the Swedish journal of Pedagogy (*Pedagogisk Tidskrift*) in 1867-1880. The fourth of these points was:

Connect with practical problems in the pupils’ present or future everyday life, which will stimulate the pupils’ learning (Prytz, 2003, p. 48).

We have seen a Nordic approach to the concept of everyday mathematics, through the work of Swedish researcher Wistedt, and these issues have been widely discussed in international research also. Moschkovich (2002) presents two recommendations for classroom practices from the frameworks and research in mathematics education:

To close the gap between learning mathematics in and out of school by engaging students in real-world mathematics.

To make mathematics classrooms reflect the practices of mathematicians.

Moschkovich uses the terms everyday and academic practices to explain these two recommendations:

Both academic and school mathematics can be considered everyday practices – the first, for mathematicians, and the second, for teachers and students, in that these are everyday activities for these participants (Brenner & Moschkovich, 2002, pp. 1-2).

She defines academic mathematics as the practice of mathematicians, school mathematics as the practice of pupils and teachers in school, everyday mathematics as the mathematical practice that adults or children engage in other than school or academic mathematics, and workplace mathematics as a subset of everyday practice (Brenner & Moschkovich, 2002, p. 2).

She elaborates on the reasons for including everyday practice in the mathematics classroom:

Applied problems are supposed to be motivational and engaging for students. They are meant to provide students with a purpose and context for using, learning, and doing mathematics. Students are expected to relate to these problems more easily than they do to “pure” mathematics problems. Everyday or “real world” problems are also meant to provide students with experience solving open-ended problems and problems with multiple solutions (Brenner & Moschkovich, 2002, p. 3).

This use of the term ‘real world’ is different from the term ‘realistic’, as used by RME and researchers at the Freudenthal Institute (cf. chapter 2.6.3). It is interesting to note here the way Moschkovich relates everyday or real world problems to open-ended problems and problems with multiple solutions. This indicates that the structure of everyday problems (or real world problems as she also calls them) is different from the more traditional problems found in mathematics textbooks.

Although schools aim to prepare students for some combination of everyday, workplace, and academic mathematical practices, traditional school mathematics has provided access mostly to school mathematics. Textbook word problems do not parallel the structure of everyday problems, which are open-ended, can be solved in multiple ways, and require multiple resources, including tools and other people (Brenner & Moschkovich, 2002, p. 7).

It seems that she regards it as a definition of everyday problems, that they are open-ended and can be solved in multiple ways. Such a definition would imply certain differences between school mathematics and everyday (or academic) mathematics also:

A crucial distinction between traditional school mathematics and either everyday or academic practices is that students work on problems for which there are already known answers or solution methods (i.e., students are not usually proving new theorems or discovering new solution methods), and these solution methods are usually known by the teacher (Brenner & Moschkovich, 2002, p. 8).

This is an issue that will affect the use of connections with everyday life in classrooms, in that it will often become somewhat artificial. We might say that the pupils often work with ‘as-if problems’ in school, which are problems concerning real life that the pupils are going to solve as if the problems were real. For instance they might be trying to find the cost of sending a letter when there does not really exist any letter that is ever going to be sent (Sterner, 1999, p. 75). Also, the connections with everyday life in school are often bound to the mathematical content.

School mathematics problems have been traditionally determined by the methods in which students were to be trained. Textbooks reflect this relationship in their presentation of content (Brenner & Moschkovich, 2002, p. 8).

This leads us into an important discussion of connections with real or everyday life. Are we supposed to learn mathematics for applications in everyday life, or is mathematics supposed to be extracted from situations in real life? It might be so that one is first to learn mathematics, and then apply this in everyday life, or one could be supposed to start from a sociocultural perspective (everyday life) and then develop basic skills of mathematics through that. Following the first suggestion, everyday life becomes a kind of practical training field, in the other mathematical knowledge originates from a situation where the pupil is allowed to play around in everyday life. Both suggestions place mathematics in the focus of interest and not everyday life (Nilsson, 2003).

Because of this, the real-life contexts of textbook problems often become more like wrappings of certain mathematical theories, and these wrappings sometimes have an artificial appearance. Moschkovich also speaks of a synthesis between the two models of everyday and academic mathematics for the classroom, where a possible strategy would be:

For example, students could work on applied problems, paralleling everyday mathematical practice, and engage in mathematical arguments about these problems, paralleling the sorts of arguments academic mathematicians might make. Applied problems, everyday contexts, and an everyday approach to mathematics problems can provide reasons for using mathematical tools and representations and can serve as a starting point for further and more formal mathematical activity (Brenner & Moschkovich, 2002, p. 9).

And the goals for changing the mathematics classrooms might be twofold:

On the one hand, by expanding what is considered mathematical to include everyday activities and validating the mathematical aspects of what students already know how to do, classroom teachers can connect students' practices to the practices of mathematicians. On the other hand, teachers can connect mathematicians' practices to students' classroom activities by encouraging them to find or pose problems about mathematical objects, make generalizations across situations, and construct mathematical arguments (Brenner & Moschkovich, 2002, p. 9).

Arcavi provides a discussion and examination of three concepts to consider in the process of creating a bridge between everyday mathematical practice and school mathematics. The concepts are: everydayness, mathematization, and context familiarity.

When it comes to everydayness, it might be useful to consider two important questions: What is everyday? Do we all mean the same thing when we use the term? Bishop (1988) pointed out six basic activities, which we might consider universal: counting, locating, measuring, designing, playing, and explaining. But everyday mathematics might also consist of several different activities, depending on the question "Everyday for whom?" (Arcavi, 2002, p. 13).

Wistedt presented a definition of everyday mathematics where she distinguished between the mathematics we need in our everyday lives and the mathematics we attain from our everyday lives. Arcavi follows Moschkovich (cf. Brenner & Moschkovich, 2002) in a distinction between everyday and academic mathematics, and he aims at challenging what we consider to be the content of everyday mathematics experiences, and he draws the conclusion:

By closely observing student activities, experiences, interests, and daily endeavors, one may be able to capture situations whose everydayness makes them potentially powerful departure points for establishing bridges to academic mathematics. Such bridging between the everyday and the academic may then consist of integrating the genuine, meaningful, and engaging origin of the problem (children's experiences) with guidance for developing and using mathematical tools (possibly ad hoc at the beginning) to help students make deeper sense of the problems (as in the second and the third situations above). The bridges also provide ways to return to the everyday situations with more powerful knowledge about handling and approaching them (Arcavi, 2002, p. 16).

George, one of the teachers that we interviewed in our study, said that school mathematics had been connected with everyday life for decades, through word problems, and we have seen that the benefits of using word problems to connect with everyday life are not necessarily evident (cf. chapter 2.2.1). Arcavi takes up this discussion:

A glance at the history of mathematics education may lead some advocates of word problems to claim that everyday and academic mathematics were integrated into classroom practices long ago. However, in many cases, those word problems were merely artificial disguises or excuses for applying a certain mathematical technique (Arcavi, 2002, pp. 20-21).

In this connection Arcavi quotes Freudenthal, who characterised this as antididactic inversion, and he builds on this quote when he introduces mathematization:

Rather than departing from the concrete problem and investigating it by mathematical means, the mathematics comes first, while the concrete problems come later as an application. Today many would agree that the student should also learn mathematizing unmathematical (or insufficiently mathematical) matters, that is, to learn how to organize it into a structure that is accessible to mathematical refinements. Grasping spatial gestalts as figures is mathematizing space (Freudenthal, 1973, pp. 132-133).

Arcavi then explains the distinction between horizontal and vertical mathematization, which was introduced by Treffers (1987) as an extension of Freudenthal's idea of mathematizing. Horizontal mathematization is when a problem is moved from its context toward some form of mathematics, while vertical mathematization is when the pupils' constructions and productions are formalised, moving them toward generalities of content and method, and Arcavi states:

Clearly, vertical mathematization is the ideal goal of mathematics education; however, it should be preceded by horizontal mathematization, both as a springboard from situations to their mathematical models and also – and no less important – as a way to legitimize and make explicit students' ad hoc strategies (Arcavi, 2002, p. 21).

He also believes that mathematization is a powerful idea in order to bridge the gap between everyday and academic mathematics. We can see this process, he says, in the Dutch curriculum, where the contextual starting point is coupled with students' informal approaches, and on the other hand, the goal is to reach a more generalised idea on the basis of the context (Arcavi, 2002, p. 22).

While mathematization represents a one-way path from the everyday to the academic, Arcavi proposes another idea to be important, namely the notion of contextualisation, which might be considered going the other way round.

Contextualization runs in an opposite direction to mathematization but nonetheless complements it: In order to make sense of a problem presented in academic dress, one can remember, imagine, or even fabricate a context for that problem in such a way that the particular features for that context provide a scaffolding for and expand one's understanding of the mathematics involved (Arcavi, 2002, p. 22).

Arcavi believes that mathematization and contextualisation are important complementary practices in order to bridge the everyday and the academic in mathematics. A familiar context does not always make life easier though, and he shows an example of how a mathematical idea can sometimes be easier to understand in a decontextualised environment than in a familiar context (Arcavi, 2002, p. 25).

He also brings up the question of how much artificiality is necessarily introduced in the process of creating out-of-school contexts, and he suggests:

Perhaps the artificiality should not necessarily be judged according to how far away from the real world (or everyday experience) the situation may be, but rather on how authentic and meaningful it is for students and how much genuine mathematics may emerge from it (Arcavi, 2002, p. 26).

He thereby introduces a use of the connections with the real world or everyday experiences that resembles the Dutch use of the word 'realistic'. In the epilogue, he says:

I have attempted to point to some of the important issues that should be considered and explored if we are to work toward integrating everyday and academic mathematics. Examination of these issues would shed some light on the many facets we need to take into account: curriculum materials, teachers' views of the everyday and the academic, classroom atmosphere, and students' views of different mathematical practices (Arcavi, 2002, p. 27).

Marta Civil extends the distinction between everyday and academic mathematics and makes a distinction between three different kinds of mathematics, explaining the difference between them, and their implementations in the classroom. The first is school mathematics, as traditionally seen, working mostly on textbook tasks in individual work, where the focus is mostly on getting the correct answer. The second kind is called “Mathematicians’ mathematics in the school context”, and involves characteristics of a classroom environment where children do mathematics as mathematicians do it (Civil, 2002, pp. 42-43):

- The students and the teacher engage in mathematical discussions.
- Communication and negotiation of meanings are prominent features of the mathematical activity.
- The students collaborate in small groups on challenging mathematical tasks and are encouraged to develop and share their own strategies.
- The students are responsible for decisions concerning validity and justification.
- The teacher encourages the students to be persistent in the mathematical task.

The third kind of mathematics, everyday mathematics, is characterised through common features about the learning of mathematics outside of school:

Such learning (a) occurs mainly by apprenticeship; (b) involves work on contextualized problems; (c) gives control to the person working on the task (i.e., the problem solver has a certain degree of control over tasks and strategies); and (d) often involves mathematics that is hidden – that is not the center of attention and may actually be abandoned in the solution process. These four characteristics guide our work in the classroom. Our work is not so much about bringing everyday tasks to the classroom as about trying to recreate a learning environment that reflects these four characteristics of learning outside of school (Civil, 2002, p. 43).

She challenges the idea that everybody is doing mathematics, consciously or not, and she also elaborates on features of everyday mathematics that should/could be incorporated into the classroom, but also questions this incorporation.

How far can we push everyday mathematical activities? Once we start mathematizing everyday situations, we may be losing what made them appealing in the first place, but we hope that we are advancing the students’ learning of generalization and abstraction in mathematics. In our work, we take some of these everyday activities as starting points and explore their mathematical potential from a mathematician’s point of view, within the constraints of school mathematics (Civil, 2002, p. 44).

There are many important aspects of these theories, and there is often a discussion about different contexts for learning. The school world is different from the outside world (cf. Maier, 1991; Bradal, 1997, etc.). One might therefore suggest that problems concerning the transfer of learning between these two worlds could create a boundary or ‘glass wall’ between them (cf. Smith, 2002).

2.8 Transfer of knowledge?

The literature review we have made in this chapter represents a vast area of theory and research in mathematics education, pedagogy, psychology and other related fields. We have seen that there are different views on connecting mathematics with everyday life, real life or whatever it is called. The pros and cons are discussed, and researchers have focused on different aspects. A problem that continues to appear is the problem of transfer of knowledge.

Learning in context will not ensure that students learn to transfer between contexts or to the 'real world'. This does not mean that contexts cannot facilitate learning, a model context for an individual can. It does suggest however that consideration of the individual nature of students' learning should precede decisions about the nature and variety of contexts used as well as the direction and freedom of tasks in allowing students to bring their own 'context' to a task (Boaler, 1993, p. 346).

Ernest brings the discussion further, and he makes a distinction between particular and tacit knowledge:

Research on the transfer of learning suggests that particular and tacit knowledge do not transfer well from the context of acquisition, whereas general and explicit knowledge are more susceptible to transfer. Needless to say, fully social knowledge cannot be transferred to another context, unless the group moves context (if such a thing is possible) or unless the knowledge is transformed into something personal which is later recontextualized (Ernest, 1998, p. 227).

Evans (1999) presents five views on transfer: 'traditional' views, constructivism, the 'strong form' of situated cognition, structuralist views, and post-structuralism (Evans, 1999, p. 24). The traditional approaches he describes include use of behavioural learning objectives, 'basic skills' approaches and 'utilitarian' views. According to these ideas, it is possible to describe mathematical thinking in abstract terms, with no reference to context, and therefore it is believed that transfer of learning, e.g. from the classroom to situations in everyday life, should be fairly unproblematic. Evans discusses this and points to the fact that studies (cf. Boaler, 1998) show that a lot of teaching has disappointing results when it comes to transfer of knowledge. What Evans calls the strong form of situated cognition is based on Lave (1988), and claims a disjunction between doing mathematics problems in school and numerate problems in everyday life. These are different contexts and they are characterised by different structuring resources, and therefore transfer of learning from school contexts to outside ones is quite hopeless (Evans, 1999, p. 26).

Some believe that it is impossible to transfer knowledge from one specific situation to the general, and others would claim that we see daily examples of this in practice. The idea of transfer of knowledge clearly comes up when vocational training is discussed, and research shows that nurses, bank employees, pilots and others use contextual anchors of their profession when solving mathematical problems. In situations where the context was removed and the problems became abstract and formal, most of them were not able to solve the problems at all. A mathematics programme where situated abstraction instead of full abstraction would be the aim was therefore suggested. The Dutch TWIN project for vocational training of engineers expresses similar opinions.

Mathematical competencies for the workplace (and therefore for vocational education) should be described in terms of the ability of students to describe and solve occupational problems with the use of appropriate mathematical methods. These methods should in the first place be described in general terms of higher order skills, and then specified in more basic, technical skills (van der Kooij, 2001, p. 239).

When commenting on the Dutch TWIN project, van der Kooij gives some interesting findings about the problem of transfer of knowledge.

One of the important claims in RME is that mathematical concepts should first be explored in a number of different contexts and, after that, generalized and formalized into the world of (abstract) mathematics. But it was found in the TWIN project that this full abstraction is at least one step too far for students in vocational education. Because of the way in which mathematical methods are used in occupational practice, this full abstraction is not necessary either (...) Therefore, transfer of procedures to comparable situations is more important than generalization and abstraction into the

abstract world of mathematics. Most of the time, this transfer is not complete in that every context gives rise to its own modifications of the method (van der Kooij, 2001, p. 240).

If this transfer to full abstraction is a step too far for pupils of vocational education, it is perhaps so also in grades 1-10. This is an element to bring into the discussion. An important finding of the TWIN project is that it makes sense for educators of mathematics to consider two different ways of using algebra:

Firstly is the way of the mathematician, who handles numbers and relationships between sets of numbers as if numbers are actual objects. In that world, standard routines and algorithms make sense and have value in themselves. In the real world of applications to (physical) entities, algebra is used by practitioners in a mixture of context-bound strategies and rules from the discipline of mathematics. Secondly, for vocational practice, it seems much more important to strengthen the abilities of students to use these situated strategies in a flexible way than to force them into the very strict rules of standard algorithmic skills of 'pure' algebra (van der Kooij, 2001, pp. 240-241).

Because most pupils were found to be weak in algebra, the TWIN project introduced graphing calculators to help them survive the algebraic manipulations. In the end, van der Kooij concludes:

A mathematics program (connected to or even integrated in vocational courses) that tries to (a) make students flexible in the use of different strategies, including the use of technology, instead of making them use one (formal) technique; and (b) to use the real-world contexts of their field of interest (engineering) to learn mathematical concepts and to develop a mathematical attitude, can indeed be useful for the preparation of future workers, ready to function in an ever changing world of work (van der Kooij, 2001, p. 242).

A problem or challenge for contemporary education, at least in Norway, is that all pupils are not going to become mathematicians, and not everyone is going to become an engineer. Since the subject of mathematics in contemporary education is supposed to serve as a base both for pupils who decide to continue with vocational training and pupils who are going to continue studying mathematics or other more or less related subjects at universities, there are several aspects to take into consideration. The question or problem of transfer comes into the discussion when connection with real life is mentioned, and we should not ignore it.

How could we then conclude? Evans (1999) believes that there is a distinction between doing mathematics problems in school and numerate problems in everyday life, but he does not believe that there is a total disjunction. He states that when people seem to transfer ideas from one context to another under all kinds of conditions, they do not always transfer what teachers want them to transfer.

For anything like transfer to occur, a 'translation', a making of meaning, across discourses would have to be accomplished through careful attention to the relating of signifiers and signifieds, representations and other linguistic devices that are used in each discourse, so as to find those crucial ones that function differently – as well as those that function in the same way – in each. This translation is not straightforward, but it often will be possible (Evans, 1999, p. 40).

What then about everyday mathematics, or a connection with school mathematics and real life? There are different opinions on the relevance of everyday mathematics in school. Two main researchers in the field put it like this:

Is everyday mathematics really relevant to mathematics education? Yes, but not as directly as many have thought. The idea that we can improve mathematics education by transporting everyday activities

directly to the classroom is simplistic. A buying-and-selling situation set up in a classroom is a stage on which a new drama unfolds, certainly one based on daily commercial transactions, but one that, as Burke (1945/1962) might have expressed it, has redefined the acts, settings, agents, tools, and purposes (Carraher & Schliemann, 2002, p. 151).

It is important to note that when Carraher & Schliemann (2002) discuss the relevance of everyday mathematics, this is not the same as mathematics in everyday life (as we find it presented in L97) or what we might call real-life connections (see chapter 1.6 for a clarification of concepts). A key idea in L97 is that situations from everyday life should be used as a starting point for a construction (or reinvention) of the mathematical theories, but school mathematics contains more than everyday mathematics.

Everyday life is often implemented in school mathematics because it is supposed to be motivational. Another idea is that it should be introduced so that the pupils become prepared to meet the demands of life. In other words, it should be useful. And useful things are normally believed to be motivational. If connections with everyday life, often in word problems, are not really motivational to the pupils, they are often claimed to be artificial and then again of little use. A question that often pops up is: When are we ever going to use this? Carraher & Schliemann (2002) suggest that we should not be so hung up on the idea of realism, because it can be discussed whether realistic problems are motivational or even useful. The understanding of the word 'realistic' in the Dutch tradition also implies that it has to do with more than pure realism, and this is also an understanding that has been adopted in Germany (cf. Selter, 1998). In the Netherlands a 'realistic' problem is defined as a problem that is meaningful to the pupils – the word 'zich realiseren' means to imagine (cf. van den Heuvel-Panhuizen, 2003) – and they therefore do not only refer to problems with a context from real life. We cannot be certain that realistic problems are transferable either.

The outstanding virtue of out-of-school situations lies not in their realism but rather in their meaningfulness. Mathematics can and must engage students in situations that are both realistic and unrealistic from the student's point of view. But meaningfulness would seem to merit consistent prominence in the pedagogical repertoire (Carraher & Schliemann, 2002, p. 151).

When usefulness and meaningfulness in mathematics are discussed, we must also take into account that all parts of mathematics were not supposed to be useful in the first place. Mathematics often involves game-like activities that do not have to be meaningful in other ways than being amusing to work with, the amusement itself being meaningful. Then again, we have seen several examples in the history of mathematics of theories that originally were regarded as thoroughly abstract and in total lack of practical use, and then later these theories were used in completely new ways in which they became useful. The aspect of usefulness thus should not be exaggerated, and we should not limit ourselves to teaching mathematics that is of direct use in a child's everyday life activities. Education is also a matter of passing on knowledge that society has gained through the ages, and it should also lay a foundation for further development in the future.

2.9 Towards a theoretical base

We have now presented some of the ideas and frameworks of our study, and we have presented some theoretical foundations from the field. We have seen how researchers within the field of mathematics education have responded to the issue of constructing mathematical knowledge based on real-life examples, and we have discussed the issue of connecting mathematics in school with experiences from everyday life. Now it is time to approach a theoretical base, or a theoretical point of departure, on which our own study can rely.

Constructivist perspectives on learning incorporate three important assumptions (Anthony, 1996, p. 349):

- learning is a process of knowledge construction, not of knowledge recording or absorption;
- learning is knowledge-dependent; people use current knowledge to construct new knowledge;
- the learner is aware of the processes of cognition and can control and regulate them; this self-awareness, or metacognition significantly influences the course of learning.

These perspectives include the many types of constructivism that we have discussed in this theoretical part.

One perspective of constructivism emphasises the connection between knowledge and learning contexts. Teaching must create opportunities for ‘authentic activities’ in the classroom, and this kind of contextual knowledge leads to the ability to use this knowledge in new situations. This also includes the use of word problems:

Constructivists contend that working through mathematics word problems in collaboration with peers, and representing problems in a variety of forms (...), help to contextualize knowledge and to promote deeper levels of information processing (...) Activities become more meaningful to students because they offer personal challenges, give students a sense of control over tasks, and create an intrinsic purpose for learning (Muthukrishna & Borkowski, 1996, p. 73).

Context problems, which include problems connected with real life or everyday life, have an important role in the teaching of mathematics. We do not believe that they should be presented as applications to an already given mathematical theory, but they should rather serve as a qualitative introduction to a certain mathematical concept. This idea is found in the British tradition with the results of the LAMP and RAMP reports, in the German tradition of the ‘mathe2000’ movement, in the Japanese classrooms in the TIMSS Video Studies, and we also found it in the Dutch tradition following Hans Freudenthal.

We would like to bring attention to the RME definition of context problems, which are problems where the problem situation is experientially real to the student (Gravemeijer & Doorman, 1999). Such a definition implies a link to reality that goes beyond real life situations, and within this conception we might say that a problem or a problem context does not always have to be from real life, but it has to include elements of reality for the pupils. In this way a problem can be experientially real although it is not a real-life problem in a traditional sense.

Freudenthal (1971) said that presenting the children with the solution to a problem that they could have figured out for themselves is a crime, and we also believe that the pupils should be given the opportunity to discover or reinvent things for themselves. This is based on a belief that the learning of mathematics is characterised by cognitive growth rather than a process of stacking together pieces of knowledge. Mathematics should be an activity for the pupils, not only for the teacher, and the pupils should get the opportunity to organise and mathematize for themselves. All this is in agreement with the ideas of Freudenthal and the Dutch tradition of Realistic Mathematics Education.

In this phase of reinvention, which actually is a process of construction, the pupils have to figure things out individually, and in that way acquire a private knowledge for which they are responsible themselves. This process of reinvention will often depart from a context problem that is carefully chosen by the teacher. When working with such a particular problem, the pupils will develop some informal solution strategies. These are highly context-bound, and as we have seen in researches on situated learning and transfer of knowledge, the knowledge that pupils have gathered from a specific

context like this is not easily or automatically transferred to other contexts. Such an organisation and formalisation can be reached by leading the pupils through a process of horizontal and vertical mathematization, which we have seen defined by Treffers (1987) and Gravemeijer & Doorman (1999) earlier.

The teacher could benefit from asking himself how the mathematical theories could have been invented, and then lead the pupils through these processes, letting them reinvent things for themselves rather than just listening to the teachers' presentation of his own reinventions. When designing a learning sequence like this, the teacher might also look at the history of mathematics as a source of inspiration. The historical development gives a picture of mathematics as an active process of development, and it can also provide indications about the process and the order in which the different concepts and issues appeared. Thereby a connection of mathematics with everyday life could also be linked to the history of mathematics, following the ideas of genesis principles. Another reason for looking at history is for the teacher to obtain knowledge of so-called epistemological obstacles, and to use this knowledge in the teaching, in order to let the pupils face such obstacles and overcome them (cf. Mosvold, 2001).

When looking at the history of the genetic approach in mathematics education, we realise that the idea of starting with specific problems (that could be from everyday life) and going through a process of formalisation and abstraction has its origin in the natural method of Francis Bacon (cf. Mosvold, 2001). This is not to say that a process of reinvention should always be connected with the history of mathematics, but there are many examples where this is possible (cf. Bekken & Mosvold, 2003a). The pupils' final or formalised understanding of mathematics should always be rooted in their understanding of these initial, experientially real, everyday-life phenomena. This implies that true understanding of mathematics would always involve an aspect where the pupils are able to apply the theories in different settings from real or everyday life.

There is strong agreement that the starting point in a learning sequence should be a context problem, a rich or challenging problem (there are many labels), and that the pupils are supposed to work actively with this problem. Through this work, they should be able to construct or re-invent the mathematical theories rather than being presented with the theory and then practise applying it. This is also an idea that is strongly supported in the Norwegian curriculum, and it should be integrated in Norwegian classrooms. In this study we hope to learn more about how this could be carried out, what sources, methods and organisational considerations the teachers would use in order to do this. We will then see what the practising teachers think about these issues, but we will also observe how they do or do not implement these ideas in their classrooms.

3 Real-life Connections: international perspectives

A qualitative study of some Norwegian teachers, however interesting that is for us in relation to L97, will only become more interesting when placed in an international context. We studied data from the TIMSS 1999 Video Study to find some of the international trends exemplified in teaching.

3.1 The TIMSS video studies

In *The Learning Gap* (Stevenson & Stigler, 1992), the results of a large study of classrooms in Japan, China, Taiwan and the US were discussed. The main idea was to study teachers and teaching in different countries in order to obtain ideas to improve teaching. In 1995 another large international study was conducted. The TIMSS student assessment compared the pupils' knowledge and skills in mathematics and science in different countries. This study was followed by a video study, which was the first time video technology was used to investigate and compare classroom teaching in different countries (Hiebert et al., 2003, p. 9).

As a supplement to the next TIMSS, the TIMSS 1999, another video study was conducted, now on a much larger scale than before. This study recorded more than 600 lessons from 8th grade classrooms in seven countries: Australia, the Czech Republic, Hong Kong SAR, Japan, the Netherlands, Switzerland and the United States. In 1995 as well as in 1999, Japan and Hong Kong were among the highest achieving countries in the student assessment part of TIMSS. When we call them high achieving in the following, this is what we mean. In this chapter we focus almost exclusively on the TIMSS 1999 Video Study.

When it came to how the mathematical problems were presented and worked on, the coding team explored several aspects, including (Hiebert et al., 2003, pp. 83-84):

- **The context in which problems were presented and solved:** Whether the problems were connected with real-life situations, whether representations were used to present the information, whether physical materials were used, and whether the problems were applications (i.e., embedded in verbal or graphic situations).
- **Specific features of how problems were worked on during the lesson:** Whether a solution to the problem was stated publicly, whether alternative solution methods were presented, whether students had a choice in the solution method they used, and whether teachers summarized the important points after problems were solved.
- **The kind of mathematical processes that were used to solve problems:** What kinds of process were made visible for students during the lesson and what kinds were used by students when working on their own.

The issue of real-life situations was addressed as follows (Hiebert et al., 2003, p. 84):

The appropriate relationship of mathematics to real life has been discussed for a long time (Davis and Hersh, 1981; Stanic and Kilpatrick, 1988). Some psychologists and mathematics educators have argued that emphasizing the connections between mathematics and real-life situations can distract students from the important ideas and relationships within mathematics (Brownell, 1935; Prawat, 1991). Others have claimed some significant benefits of presenting mathematical problems in the context of real-life situations, including that such problems connect better with students' intuitions about mathematics, they are useful for showing the relevance of mathematics, and they are more interesting for students (Burkhardt, 1981; Lesh and Lamon, 1992; Streefland, 1991).

When comparing the average percentage of problems that were set up using real-life connections, there were some interesting differences. In the Netherlands, 42 percent of the lessons were set up using real-life connections, whereas 40 percent used mathematical language and symbols only. This was a special result in the study, where the other six countries differed between 9 and 27 percent for real-life connections. It is also interesting to observe that only 9 percent of the lessons in Japan, and 15 percent of the lessons in Hong Kong were coded as having real-life connections.

In all the countries, if teachers made real-life connections, they did so at the initial presentation of the problem rather than only while solving the problem. A small percentage of eighth-grade mathematics lessons were taught by teachers who introduced a real-life connection to help solve the problem if such a connection had not been made while presenting the problem (Hiebert et al., 2003, p. 85).

They also discovered a higher percentage of applications in the Japanese classrooms (74%), than in the Netherlands (51%) and Hong Kong (40%). These applications might or might not be presented in real-life settings (Hiebert et al., 2003, p. 91).

Another interesting issue to point out is connected with the mathematical processes. In Japanese classrooms 54% of the problems were classified as having to do with ‘making connections’. In Hong Kong this was only the case in 13% of the lessons, and 24% in the Netherlands (Hiebert et al., 2003, p. 99, figure 5.8). Hong Kong had a high percentage of ‘using procedures’. That means involving problems that were typically solved by applying a procedure or a set of procedures. In Japan this was the case in only 41% of the problems, and in the Netherlands 57% (Hiebert et al., 2003, pp. 98-99).

Although there appear to be some strong tendencies in these countries, concluding whether the use of real-life connections had any particularly effect on the learning by studying these percentages alone would be a simplification. The findings that will be presented in the following show how difficult it is to draw conclusions based on quantitative results alone.

3.2 Defining the concepts

Before discussing real-life connections it would be appropriate to explain what lies within the concept of ‘real life’ (see also chapter 1.6). In research in mathematics education we come across a variety of concepts like everyday life, daily life, real life, real world, realistic as well as contextual, situated and other concepts that are directly or indirectly related (cf. Boaler, 1997; Brenner & Moschkovich, 2002; Lave & Wenger, 1991; Wistedt, 1992). An appropriate question might be: “What do you mean by real life?” Since this chapter is based on the TIMSS 1999 Video Study, it is natural to take a closer look at the definitions of concepts referred to in this study.

What do you mean with real life?

All the lessons in the Video Study were coded, and the coding team made a distinction between real life connections/applications in problem-situations and non-problem situations. Two categories were hereby defined: real-life connections or applications in problems, and real-life connections in non-problem situations. The category of real life connections/applications – non-problem (RLNP) was defined as follows:

The teacher and/or the students explicitly connect or apply mathematical content to real life/the real world/experiences beyond the classroom. For example, connecting the content to books, games, science fiction, etc. This code can occur only during Non-Problem (NP) segments.

As we can see here, they compare real life to real world or experiences beyond the classroom. This is a quite vague description, but it was clarified somewhat with examples on how these connections could be made.

The by far more frequently occurring of the two was called real life connections, and they appeared in actual problems in class. A distinction was made between situations where the real life connection appeared in the problem statement or set-up, or where the real life connection was brought up during the discussion or work with the problems. The definition of these kinds of real life connections, called RLC, was:

Code whether the problem is connected to a situation in real life. Real life situations are those that students might encounter outside of the mathematics classroom. These might be actual situations that students could experience or imagine experiencing in their daily life, or game situations in which students might have participated.

Real life is then whatever situation a student might encounter outside of the mathematics classroom, actual situations or imagined situations that the pupils might experience, including game situations.

This coding has been integrated in our classroom studies, as a first level of analysis, addressing the first two of a series of questions: are there any connections to real life? Are these connections related to a problem or not?

We have adopted and expanded the coding scheme of the TIMSS 1999 Video Study, and we apply this expanded scheme for our analysis of videos here. The first two categories are placed in what we will now call level 1, which simply distinguish between connections made in problem or non-problem settings. Level 2 will go further into the kind of connections, whether they are textbook tasks, pupil initiatives etc. The third and final level of analysis will focus on how these connections are carried out, or methods of work.

<p>Level 1:</p> <ul style="list-style-type: none"> - RLC (Real life connections in problem situations) - RLNP (Real life connections in non-problem situations) 	<p>Level 3:</p> <ul style="list-style-type: none"> - GW (Group work) - IW (Individual work) - TAWC (Teacher addresses whole class) - P (Projects) - R/GR (Reinvention/guided reinvention) - OA (Other activities)
<p>Level 2:</p> <ul style="list-style-type: none"> - TT (Textbook tasks) - OT (Open tasks) - TELX (Teacher's everyday life examples) - PI (Pupils' initiatives) - OS (Other sources, like books, games, science fiction, etc.) 	

Table 2 Levels of real-life connections

This coding scheme was used when the episodes below were selected, and it also represents an initial idea in the analysis. The three levels represent important headlines, namely:

- 1) Real-life connections

- 2) Content and sources
- 3) Methods of organisation

When discussing the data from the TIMSS 1999 Video Study, we will use the headlines above to organise the results. Instead of talking about the different teachers in every subchapter, we have chosen one lesson to illustrate each of the main issues of the headlines. In that way, a lesson that is presented under the headline of contents and sources will for instance contain relevant examples on how other sources could be used, but it might also include elements that could fit under other headlines or levels in the coding scheme.

3.3 The Dutch lessons

The Dutch lessons had a high percentage of real-life connections in the TIMSS 1999 Video Study, much more than any of the other participating countries. The lessons would often include a large number of problems connected with real life. We have analysed some of these lessons, and we will now present findings from three of these videos, to learn more about how these teachers used the real-life connections.

3.3.1 Real-life connections

The teachers were very focused on the textbook.

The Dutch lessons contained many real-life connections, and most of the textbook problems seemed to have a connection with real life. An example of a lesson where the pupils worked with a problem connected with real life was M-NL-050 (the lesson code in the database at Lesson Lab), where they focused on exponential growth. The main problem concerned the growth of duckweed:

- T: Uhm... A piece of five centimeters by five centimeters of duckweed in the pond, it's really annoying duckweed. It doubles. But the owner of the pond doesn't have the time to clean it. He takes...
- S: Sick?
- T: No, he takes three months of vacation. Now, the question is... the pond, with an area of four and a half square metres. Will it be completely covered in three months or not?
- S: Yes.
- S: ()
- T: Shh. This is the spot that has duckweed at this moment. It doubles each week, no, and the pond is in total four and a half square metres, and the time that he's gone on vacation is three months. So the question now is whether the pond has grown over or not.

The pupils were then asked to use their calculators. After the pupils had worked with the problem for a while, the teacher asked them what they had come up with:

- T: Who says it's full after three months?

- S: No idea why, but it's full.
- T: Uhm, who doesn't?
- S: ()
- T: And, uhm, who says "I don't know"?
- S: Ha ha.
- T: Uhm, so there are six. I have six unknown, no one for not full, and, uhm, so there are twenty-five for full. Uhm, Paul, how did you come up with full? What did you try, what did you do?
- S: I don't know.

The teacher then tried to figure out how the pupils had thought and what they had calculated. They eventually came up with a formula for calculating the growth during the twelve weeks. At the end of the twelfth week, they found out, it was two to the twelfth. Then they had to convert square metres into square centimetres. After having discussed this with the class, the teacher summed it all up:

- T: Uhm, so you must make sure that, in the end, you are comparing. So, or the answer that you came up with... that'll be twenty-five thousand times four, so that is somewhere close to a hundred thousand, and so it's full. This is something that will be explained in Biology. In economics, well, then you will get the following: that the doubling of bacteria, then you get something like this ().

This problem is indubitably connected with real life, and it seemed to be a problem the pupils were motivated to work with.

3.3.2 Content and sources

From the videos, a pattern emerged when it came to content and sources of the teaching. In most of the lessons we looked at, the teacher reviewed problems from the textbook together with the class. In many lessons the pupils had already worked on the problems before, and they were asked questions related to the solutions of the problems. When working on problems, they mainly worked individually, but they could also be seated in groups. What struck us was that the teachers were very focused on the textbook, and a majority of the problems from the textbook had real life settings. Most of the real life connections could be coded RLC, TT, TAWC (according to our extended coding scheme), i.e. real life connections in problems, textbook tasks presented by the teacher addressing the whole class. This was the case in most of the lessons we viewed.

An example of this was found in lesson M-NL-021, where the teacher went through problems like this in the entire lesson:

Teacher: Now another possibility with percentages. I have an item in the store. At present it costs three hundred and ninety-eight guilders. Next week, that same item will cost only three hundred twenty guilders. By what percentage has that item been reduced in price, Grietje?

Student: Um, seventy-eight guilders was subtracted.

- T: Seventy-eight guilders was subtracted, yes.
- S: Eight, uhm divide it by the old amount times one hundred.
- T: So – yes. By which – by which number?
- S: Three hundred and ninety-eight and then times one hundred.
- T: By three hundred and ninety-eight and then times one hundred. And that gives you the solution.

The teacher quoted the problem from the book and asked a pupil to present the solution. We got the impression that the pupils had already worked with these problems. Some of the problems were larger and more complex, containing figures and tables. Many of the problems in this lesson were collected from statistical material, like one of the problems about the wine import to the Netherlands in 1985, introducing a picture diagram, bar diagram and line diagram. Other problems focused on temperatures, the number of umbrellas sold on a rainy celebration day, coffee consumption, etc.

3.3.3 Methods of organisation

One of the other lessons we viewed, M-NL-031, was an example of how a lesson could be organised in a different manner than the traditional one. In this lesson the class was working with probability. The teacher divided the class into different groups. One of the groups was asked to flip coins and write down the results, another group was to throw dice and yet another group was to look out the window and write down the number of men and women that passed. The groups worked for five minutes on each task and then moved to the next station. The pupils used these data to calculate the chance (the fraction and the percentage).

This class worked on problems connected with real life in a different way than in the previous examples. They did not solve textbook tasks only, and they worked with other sources that provided a set of data that the pupils gathered themselves. They also worked in groups, and during their work they encountered several real life applications in non-problem settings.

From the statistical analysis of the Video Study, as well as from reading about Realistic Mathematics Education from the Freudenthal Institute, we get the impression that real-life connections are important in Dutch schools. This impression has been supported from our sample of videos. The RME tradition strongly supports the idea of guided reinvention. An integral amount of student activity was included in the work with real-life connected problems or realistic problems as they are often called in this tradition. This was not so evident in the videos we have seen. Here it seemed to be more teacher talk in connection with a review of textbook problems than a process of guided reinvention of mathematical concepts. In many of the Dutch lessons we have analysed, the teaching was rather traditional – with real-life connected textbook problems, and not so much of what we would believe teaching in RME-classrooms should be like.

The teaching was rather traditional.

3.3.4 Comparative comments

From our selection of Dutch lessons we got the impression that the textbook was an important source or tool. This impression was supported from a study of the public release videos also. The

researchers commented that more than 75% of the Dutch mathematics lessons relied on the textbook. The following comments represent issues that came up from a study of the four Dutch public release videos.

At the beginning of the first lesson, we saw how the teacher discussed some problems from the homework. On average, 12 homework problems were reviewed in each Dutch lesson. These problems were also from the textbook. The teacher then introduced a new topic with a video presentation. This video brought the material to life and showed some applications and real-life scenarios that were connected with the topic of the current problems. The use of videos was rare in the Netherlands, and only two percent of the lessons used videos. Then the teacher presented a list of 32 problems that the pupils were to solve privately, and they were to be finished as part of their homework. 15 of these problems contained a real-life connection.

Our impression was that the pupils worked individually with textbook tasks a lot. The analysis of Hiebert et al. (2003) showed that, in the Dutch lessons, 44% of the time was spent on public activities, 55% on private. Individual work accounted for 90% of private work time per lesson in the Netherlands. Public discussions were not common, and the lessons would often contain a large percentage of review. The teacher said that he showed the video because he wanted to show them what they could do in real life with this kind of subject.

In the second Dutch lesson, much of the time was also spent with individual work. What differed in this lesson was that the teacher stated the goal at the beginning of the lesson, and that the problem involved a proof. Both were uncommon in the Netherlands. A large percentage of the problems the pupils solved individually in a lesson (74%) would involve repeating procedures. In this lesson four of 26 assigned problems contained a real-life connection. These problems were presented like this:

Annelotte's house has a square garden that is 14 x 14 metres. There are plants in three corners of the garden. One corner is tiled. The square in the center is for rabbits. How many square metres is the whole garden? How many square metres have been tiled? What is the surface area of the area for the rabbits? Annelotte has enclosed the rabbits' square with wire mesh. How many metres of wire mesh did she use?

The two last lessons in the public review collection were from Dalton Schools. 'Dalton' is a pedagogical concept developed between 1920 and 1950 by US educator Helen Parkhurst (cf. Parkhurst, 1922; 1926) and involves ideas of liberty in commitment, autonomy and responsibility, and cooperation. In Dalton Schools, the pupils use a study calendar, and they work with tasks from this calendar at their own pace. An important part of the cooperation process is to explain problems for each other. Explaining problems to another student is viewed as a learning opportunity for both pupils. It stimulates the conceptualisation of mathematical principles for all pupils involved in the discussion. There was a large number of problems assigned in the calendar, and many of them had real-life connections, like these:

A roll of wallpaper is 50 cm wide. You always cut a roll in strips that are 15 cm longer than the height of the room. How much excess do you cut (in square cm)?

What is the surface area of a strip of wallpaper for a room that is 240 cm in height?

The surface area of a strip of wallpaper for a room that is h cm high can be calculated in various ways. Which equations below are correct?

- A. Surface= $750+50h$;
- B. Surface= $50x(15+h)$;
- C. Surface= $800h$;
- D. Surface= $50+15h$.

Calculate with the correct equations the surface area of a strip for a room that is 265 cm in height.

The teacher also believed that the pupils would learn more if they had to explain a problem to others. The teacher said:

Every lesson I will publicly discuss a problem or section of theory at least once, but I want the students to discover and experience the math as much as possible on their own without me doing it for them, so I limit the explaining to as little as possible.

In the Dalton schools, the teachers stressed the pupils' responsibility for their own learning. This was common in the Dutch classrooms in general. Examples of problems set in a real-life context from the last lesson are:

A farmer has a piece of land that is 40m by 70m. He enlarges the size of his land on three sides with strips that are x metres wide. The farmer wants to put barbed wire around all but a 70m stretch of his field. Show as short an equation as possible for the length of the barbed wire (in metres). How many metres of barbed wire does the farmer need if $x=20$? If the farmer needs 204 metres of barbed wire, how big is x ? Make an equation for the area of the field with brackets and without brackets (in square metres).

All in all, the impression we got from the Dutch videos we have presented was confirmed from the study of the public release videos. The comments from the researchers that were following these videos also seemed to support our findings. A more general impression was that textbooks were important in Dutch classrooms. The pupils would work with a large number of problems from the textbook, and many of these would be presented in a real-life context. 90% of the private time was spent on individual work in the lessons.

3.4 The Japanese lessons

What was most striking about the Japanese lessons was their structure. As we learned already from *The Learning Gap* (Stevenson & Stigler, 1992), mathematics lessons in Japan would often follow exactly the same pattern in corresponding lessons all over the country. We saw examples of this with different schools and different teachers where some lessons were almost exactly the same. A Japanese lesson would often focus on one problem only, and this would often be a rich problem and a 'making connections' problem.

3.4.1 Real-life connections

Although the Japanese lessons often would contain rich problems, or 'making connections' problems, there would not be so many real-life connections. We focused on some of the lessons that did contain real-life connections, which were thereby only representative of about one out of ten Japanese lessons. We wanted to learn more about how the teachers made these connections with real life, and when such connections were actually made. We discovered that the real-life connections were mainly single comments and they would often appear in the introduction to a problem.

All along there was a dialogue with the class.

In one of the lessons (M-JP-034) that we analysed the pupils were working with similarity. This teacher gave several examples from real life, and he asked the pupils to give examples also. Some of the

examples he came with were: the desks in the classroom, negatives of a film, fluorescent light and different sizes of batteries. All along there was a dialogue with the class. Real-life connections were mostly used in the introduction of a new topic. As we could see in some of the Japanese lessons, the teacher would often start off with one or a couple of real life examples and gradually move towards the mathematical concepts. The aim was to use the real-life situations as motivational examples rather than to solve real life problems.

3.4.2 Content and sources

Lesson M-JP-035 was an excellent example of how teachers use concrete materials in their teaching, and how they include objects from real life to illustrate important ideas. The class was working with congruence and similarity, and the pupils had been given a homework assignment for this lesson:

T: Okay. Ah...then up to now ... up to the previous lesson we were learning about congruent geometric figures, ... but today we'll study something different. As I was saying in the last class ... I said we'll think about geometric figures with the same shape but different sizes, and I was asking you to bring such objects to the class if you find any at home.

Not all the pupils brought things, but some brought angle rulers, protractors and erasers, and one brought origami paper. The teacher had brought a bag of things, and she used them to introduce the topic:

T: Okay. Then, next I'm going to talk ... all right? What similarity means is that the figure whose size is expanded or reduced is similar to the original figure. Then, well a few minutes ago I introduced the objects you have brought to the class. I, too, have brought something. What I have brought is ... some of you may have this bottle at home. Do you know what this is? Yasumoto, do you know?

S: ()

T: What? You don't know what kind of bottle this is? Taka-kun do you know?

S: A liquor bottle.

T: A liquor bottle. A ha ha ... that's right. It's a whisky bottle. Whisky ... a whisky is a liquor which ... we all like. Cause we even call it Ui-suki (we like).

S: A ha ha.

T: A ha ha. Did you get it? Then, ... about these whisky bottles ... look at these. They have the same shape don't they. They do, but have different sizes. Well, I have borrowed more bottles from a bottle collector. This.

S: A ha ha.

T: This.

S: A ha ha.

- T: See ... then I wondered if there were more different sizes so I went to a liquor store yesterday. And, they did have one which contains one point five liters of ... one point five liters of whisky, but it was too expensive so I didn't buy it. As you can see, these whisky bottles ... have the same shape ... but they come in various sizes. All of these bottles are called similar figures.

There were some real-life connections when the teacher discussed some of the items the pupils had brought, and she went on to present some things she had brought herself. In that way we also got some examples from the teacher's everyday life. She had brought a couple of squid airplanes, with different sizes, and she had brought a toy dog. She showed how to draw this dog in a larger scale, using rubber bands. Then she went into more specific mathematics, asking the pupils to draw geometrical figures like quadrilaterals and triangles in larger scales. At the end of the lesson, she led the pupils into discovering that the angles were equal in these expanded figures, and that they were therefore similar. She also introduced a symbol for similarity.

3.4.3 Methods of organisation

Many Japanese lessons would contain a real-life connection as a comment in the introduction to a problem only, like in M-JP-022. The organisation of this lesson was interesting. The teacher started off with a short introduction to the concept 'centre of gravity'. Here he commented on the importance of the centre of gravity in sports, like baseball or soccer. This comment was marked as a RLNP-situation in the Video Study. Then he showed how to find the centre of gravity in a book, balancing a textbook on a pencil. All along he discussed with the pupils, and he let them discuss and decide where the centre of gravity was, leading them into ever more precise mathematical formulations.

He then challenged them to find the centre of gravity in a triangle, and this became the main focus for the entire lesson. First the object was simply to find the centre of gravity by balancing a paper triangle on a pencil. Then, as the teacher stated, it was time to look at this more mathematically:

- T: Okay this time open your notebooks. Uh let's try drawing one triangle.

(pupils draw in their notebooks)

- T: Okay. If it were a cardboard you can actually tell saying it's generally around here where it is using a pencil and suchlike. Okay it's written in your notebooks. It's written on the blackboard. You can't exactly cut them out right? You can't exactly cut them out. And without cutting them out ... I want you to look for like just now where the balancing point is, ... that's today's lecture. Using this cardboard from just now ... in many ways. I will give you just one hint. It'll be difficult to say at once here, so on what kind of a line does it lie? ... On what kind of a line does the point lie? Please think about that.

First they found the centre of gravity by testing on a cardboard. The next challenge was to find this centre (mathematically) without cutting out the triangles. The pupils got time to think and discuss, and they played around with pencil and triangle. After a few minutes the teacher formed groups of six, and the pupils discussed further in those groups. The teacher walked around and commented on the work. He asked them to draw lines or points on the cardboard and try it out to see if it balanced. Some pupils discovered that their solutions were wrong. At one point the teacher interrupted the work by presenting to the class one false solution that a pupil tried:

- T: Okay. It's okay. Just for a second, sorry Shinohara. Shinohara just tried with the bisectors of angles right? The bisectors of angles. And ... when you try it like this
- S: ()
- T: unfortunately it doesn't balance. Um ... at the bisector of the angle please look up front for a second those of you facing the back. Group one girls, look ... look for a second. Let's see ... if you go like this at the bisector of an angle, Shinohara.
- S: Yes?
- T: Look over here. If you are asked whether it balances?
- S: Um
- T: Uh huh. This side ended up little ... heavy right? It ended up heavy. That's why even if you go like this it doesn't balance. So the areas are the same ... unless the areas are the same ... it's no good, is it?

The pupils continued testing their theories on the cardboards. From time to time, the teacher interrupted by showing some of the pupils' solutions on the blackboard. The pupils got plenty of time to think and try things out, and the teacher mainly used the pupils' ideas and answers in a reconstruction of the theory. Eventually they reached a proof, and the teacher summed it all up in a proposition. In the end he reviewed the essence of the lesson again.

A similar approach could be seen in many lessons. The pupils got enough time to work with one problem at a time, and were given the opportunity to reinvent the theory. Sometimes the pupils also presented their solutions and methods on the blackboards, and the class discussed which method was preferable. The mathematical content of a lesson would often be purely mathematical, as this lesson was, except for the tiny comment on the centre of gravity in sports. But even though purely mathematical, the content was meaningful to the pupils, and we believe this was because they often got the opportunity to rediscover the methods and theories. They also got the opportunity to discuss their choices of methods and solutions. There was a lot of pupil activity, even though much of the teaching was arranged with the teacher discussing with the whole class.

The teacher mainly used the pupils' ideas in a reconstruction of the theory.

3.4.4 Comparative comments

The situation in Japan was quite different from that in the Netherlands. We have already seen that only a few problems with real-life connections occurred in Japanese classrooms, and a basic teaching style was whole-class instruction. These impressions were also supported from the public release videos. From the comments of the researchers, we learned that an important teaching method for a Japanese teacher was to stroll among the pupils' desks to check their progress while they were working. This method had been given a specific name in Japanese. Many teachers would stroll around among the pupils and make notes about what solutions they had found and in what order the ideas and solutions of the pupils could be presented. This often led to a productive whole-class interaction.

In almost half of the Japanese classrooms, multiple methods would be presented. 75% of the lessons contained a goal-statement. 34% of the class time was spent in private interaction and in these cases the pupils mainly worked individually. While the Dutch classroom often contained many problems to solve, the Japanese classrooms on average contained three problems per lesson. 74% of the problems were applications, but only 9% of the problems per lesson contained real-life connections.

In the second public release lesson from Japan they worked with two problems, where one of them contained a real-life connection. For both these problems, multiple solutions were presented and discussed, something which was quite common. This lesson also included use of computers, and this was not common in Japan.

The third Japanese public release lesson also contained two problems, and in this lesson the teacher also used physical materials, as we saw examples of in our sample of lessons discussed above. On average, physical materials were used in 35% of the problems in the Japanese lessons. One problem was open-ended, and it was solved by the pupils using a variety of methods.

In the fourth and final Japanese lesson from the public release collection, we observed something uncommon, namely that the teacher went over the homework for this day. One of the problems, which was about how many pieces of cake one could buy with a certain amount of money, had a real-life context. The other problems they solved in this lesson were connected with real life in a similar way. After giving the pupils time to think about the problem on their own, the teacher presented several possible solution methods. This occurred in 17% of the problems in Japanese lessons on average.

3.5 The Hong Kong lessons

Like the Japanese lessons, the Hong Kong lessons also contained a low percentage of real-life connections, according to the TIMSS 1999 Video Study (Hiebert et al., 2003, p. 85). We have analysed some lessons that did contain such connections and observed how the teachers carried them out.

3.5.1 Real-life connections

The first example is from M-HK-019, and the teacher here gave an example connected to real life in the introduction to a new chapter:

T: Okay, you will find there are two supermarkets – the last supermarket in Hong Kong, okay? Okay, one is Park N Shop and the other is Wellcome, okay? I think all of you should know. You know these two supermarkets, okay? And then – now, and you should know that in these few month, okay? This two supermarket, okay, want to attract more customer. Do you agree? Therefore, they reduce the price of th- of the- of the- uh, uh, of the products. Okay? And they want to attract more customers. Do you agree? Okay, and then- now, here- there is a person called Peter, okay? He come into this two supermarket and he want to buy a Coca Cola, okay? And then now, yes, I give you the price of the two shop. The different price of the two shop. For Park N Shop, okay? For the price of Cola, okay? Okay? It show the price- the price is what? One point nine dollars per- uh, for one can, okay? For one can. One point nine dollars for one can. And for the Wellcome shop. For the Wellcome, okay? It showed for the price of the Cola, okay? Uh, twelve dollars, okay, for six can.

The pupils were then asked what price was the cheapest. This was used to introduce the concept of rate. Another example was a man that walked four kilometres in two hours. This lesson involved quite a lot of teacher talk and not so much time was spent with pupil activities as was the case in the

Japanese lessons. There were several other real life examples in the lesson, and all of them were concerning ratio between two quantities. Most of the time the teacher was explaining in a lecture style, but sometimes the pupils were drawn into the discussion.

3.5.2 Content and sources

In this example from Hong Kong lesson M-HK-080, we could observe a class working with proportions, and we got examples of a teacher who made use of several other sources than the textbook in his teaching. The young teacher gave quite a lot of examples and connections to real life, some in a problem setting, but most in non-problem settings. He started off with an open question, which had some similarity to so-called ‘Fermi problems’ (cf. Törefors, 1998):

T: I have discovered one thing...

S: A dinosaur’s footprint.

T: In ancient times – yes, a dinosaur’s footprint. Yes, it really is this one – this one. I want to give you a question now. The footprint is this size. I want to ask you to guess how tall the dinosaur is. I help you – the only thing I can help you is measuring the length of this.

He then guided them into a discussion about how to guess a dinosaur’s size by knowing the length of its footprint only. He followed up by asking how this would have been if it were a human footprint, and he showed how this was connected with proportions. This was an open problem or question, the answers were hard to validate, and the pupils were challenged to make the most out of the limited information given.

The teacher had also brought a couple of maps, and he asked two pupils to find the scale. They then discussed distances on the map compared to distances in reality, etc. All the time, the pupils got some tasks, things to calculate and figure out. He handed out some brochures about housing projects, and the pupils were asked to figure out some issues connected with the map contained in them. After working for a while with two-dimensional expansions, he introduced some Russian dolls, and thereby presented them with the concept of three-dimensional expansion. For the entire lesson, the pupil activities were connected with some real world items like maps, dolls or pictures of dinosaur footprints. They were both RLC and RLNP, but they were exclusively everyday life examples given by the teacher, and were presented by the teacher addressing the whole class.

The pupil activities were connected with real world items like maps, dolls or dinosaur footprints.

3.5.3 Methods of organisation

In the next lesson ,M-HK-020, there were some examples of how Hong Kong teachers might organise their lessons. In many ways, this was like some of the Japanese lessons. For the entire lesson, the pupils worked within one problem setting, with many different examples, with the aim of approaching a mathematical theory concerning equations with two unknowns. The teacher wanted the pupils to discover this for themselves, and he started off giving an example:

T: Okay. Ask you a question. Birds... have how many legs?

S: Four.

3 Real-life Connections: international perspectives

S: Two.

T: How many?

S: Two.

T: Two. Birds have two legs.

(...)

T: Legs. Okay. Birds have two legs, how about rabbit?

S: Four.

T: Four

Then he asked the pupils: “If there are two birds, how many legs in total?” He asked if there were one bird and one rabbit, how many legs, and then two birds and two rabbits. Then it evolved:

T: Something harder. How about this? One bird plus one- two rabbits?

S: Ten.

T: How many legs?

S: Ten legs.

T: Ten legs. Okay. It’s coming. What if I don’t tell you how many birds or rabbits, but tell you that...

S: How many legs.

T: There are a total of twenty-eight legs- twenty eight legs. Well, there aren’t enough hints. I need to tell you also there are how many...

S: Heads.

T: Heads. How about that? Nine heads.

The pupils solved this and other similar examples, using their own methods (normally some kind of trial and error). When the examples got too difficult, the need for a stronger method of equations arose. The pupils got the idea of setting it up with equations, using X for birds and Y for rabbits. The teacher gave them time to struggle with these equations, and he did not give them the solution at once. One issue, and we do not know whether it was planned or not, was that he did not reach the point of it all before the lesson ended. He made the following remark in the end:

T: Okay. Next time, we’ll continue to talk about what methods we can use to find it - find X and Y. Okay. Is there a systematic method. We systematically found two formulae. Is there a

systemic way to find X and Y. Next time, we'll talk about it. But everyone is very sharp, flipping through your book asking "Sir, is this the method, sir, is this the method". You should be right. The book has many methods.

This was also an example of how such methods of working can be quite time-consuming, and of the importance of planning a lesson in detail.

3.5.4 Comparative comments

The first public release lesson from Hong Kong started off with a few minutes of review before presenting new material. About three quarters of the lessons in Hong Kong started off with reviewing material already studied, and 24% of the time was spent on review. In this lesson we got an example of problems that were coded 'using procedures', which was quite normal. 84% of the problems per lesson presented in Hong Kong were of this kind. This lesson was also similar to the average Hong Kong lesson when it came to how much time was spent on individual work and how much on public interaction. 75% was devoted to public interaction and 20% to individual work. A large amount of public interaction seemed to be common in both Hong Kong and Japan, whereas the situation in the Dutch classroom was closer to 50-50 on this matter. All of the problems in this lesson involved practice of solution strategies already learned, which was also quite common in Hong Kong. 81% of private work time was devoted to repeating procedures.

In the next lesson, two pupils were picked out to present their solutions to homework problems on the blackboard. Reviewing previously assigned homework problems was rare in Hong Kong, like in Japan, and only one minute per lesson would be devoted to such activities on average. The pupils were given some problems to solve during the lesson, and they worked individually with these. As much as 95% of private interaction time in class was spent on individual work rather than working in groups or pairs. After having worked with these problems for some minutes, they were asked to put their solutions on the blackboard. All problems in this lesson were set up using mathematical language and symbols only, as was the case with 83% of the problems presented in Hong Kong lessons.

The two last lessons from the public release videos also involved a lot of time for public interaction interrupted by periods of individual work. Most problems were purely mathematical with an emphasis on practising procedures. Little time was spent on problems with a real-life connection, and the examples we have seen above were therefore probably special cases.

3.6 Summarising

We have now brought to attention some episodes and points from nine lessons from the TIMSS 1999 Video Study. We have also presented some comparative remarks from a study of the public release videos from three countries. Our initial question was how these teachers actually connect mathematics with real life.

There was a pattern in the Dutch classrooms that the teachers would spend much time reviewing textbook problems. The first Dutch lesson, M-NL-021, was a typical example of this. Most of the real-life connections were real-life connections in problem situations, where the problems were textbook tasks and the teacher was addressing the whole class. The one exception was when the teacher made a remark concerning one of the problems.

The idea of guided reinvention, which has been emphasised in the Dutch tradition of Realistic Mathematics Education (RME), was not so visible in the lessons we studied, neither was the idea of

mathematization. In the public release lessons most of the time was spent on individual work with textbook tasks, and the issues of mathematization and guided reinvention were not visible there either. One of the lessons, M-NL-031, contained a more extensive activity where the pupils worked in groups, but although being based on a more open task, it did not seem to represent the ideas mentioned above. In the last lesson we analysed from the Dutch classrooms, M-NL-050, the main focus was on a problem connected with real life. The problem concerned the growth of duckweed, and it seemed to be a textbook task presented by the teacher addressing the whole class. This problem was discussed and worked on for the main part of the lesson, and here we could observe elements of reinvention.

The idea of guided reinvention was not so visible.

In the Japanese lessons, there were not so many real-life connections, but the teachers would often use a structure similar to the approach in Realistic Mathematics Education. In the lessons where they were engaged with centre of gravity, this was clearly demonstrated. The teacher made the problem real and meaningful to the pupils in the introduction, and the pupils were then guided through a process of reinventing the theory. In the lesson with liquor bottles, we observed quite a lot of connections to real life, some of them being through things the pupils had brought, or other pupil initiatives, and some where real-life connections were made by the teacher presenting her everyday life examples. The teacher would normally address the whole class. Some Japanese teachers applied a method of work that was strongly related to the ideas of RME, and although this appeared to be exceptions, the teachers would sometimes make explicit real-life connections in their lessons.

In Hong Kong, the main emphasis was on procedures, but the teachers would in some cases give several real-life connections in their classes. Some of the RLC-problems were the teacher's everyday life examples, and some were textbook problems. The main method of work was that the teacher lectured or discussed with the class, but on some occasions the pupils were given the opportunity to work individually with problems. From the public release lessons we learned that the normal approach was a large proportion of public interaction, and a smaller proportion of private interaction where the pupils would work individually most of the time. The RLNP-situations were mainly comments and references to the problems discussed. On one occasion, the teacher included a pupil and his daily life in a problem, presenting the problem of finding out the walking speed of this pupil on his way to school. Another Hong Kong lesson, M-HK-020, was interesting because it resembled many Japanese lessons. For the entire lesson the class worked on one problem or within one context only. The problem they worked on concerned rabbits and birds, and the number of their heads and legs. In this lesson the pupils were guided through a process of reinvention of early algebra, but unfortunately the lesson ended before they had reached any conclusions. Nevertheless, we could discover clear links to the ideas of RME in this class. An interesting observation was that even though this was a method of work that seemed to be somewhat more normal in Japan, we could find examples of it in Hong Kong and the Netherlands also. In the last lesson, M-HK-080, the teacher gave many examples from his everyday life, and he had also brought some physical objects like maps and figures to make it more real to the pupils. The teacher addressed the whole class in a discussion style, and on some occasions pupils were picked out to do some activities in front of the class.

4 Norwegian curriculum development

Since the middle of the 18th century we have had some sort of national plan for schools in Norway. In the current curriculum for grades 1-10, called L97, mathematics in everyday life has become a subject of its own, side by side with numbers, geometry, algebra, etc. This reflects a view that claims the importance of connecting school mathematics with the children's daily life experiences (cf. RMERC, 1999, p. 165).

Our research focuses on teachers' beliefs, ideas and strategies for how this particular theme of the curriculum can be implemented. How do the teachers actually connect school mathematics with the pupils' everyday lives? And what are their thoughts and ideas on the role of this theme?

For Norwegian teachers and textbook authors, L97 presents the guidelines for teaching the various subjects. The idea of connecting school mathematics with everyday life has become an explicit theme in L97, but the issue of connecting mathematics

Connecting with daily life is not a new idea.

with daily, practical, real or everyday life (many names have been used) is no new idea. It has more or less been present from the beginning of the Norwegian curriculum development in 1739, when the first school laws were passed, till now.

The first time mathematics was mentioned as a school subject in Norway was in the reading plans of 1604. The topics to be taught were: the four arts of calculating, fractions, equations with one unknown, and introductory geometry (Frøyland, 1965, p. 3).

In 1739 the first school law was passed in Norway, or Denmark-Norway, as it was then. This law stated that all children, even the poorest, should be taught the ideas of the Christian faith, as well as "the three R's": reading, writing and reckoning, since these were all useful and necessary subjects to master. Although the first modern national curriculum only came in 1922, there were several smaller local directives for the schools before that. One such directive was a plan for schools in Kristiania (now Oslo), which came in 1877. This plan stated explicitly that mathematical tasks should never contain larger numbers than those required in daily life, and the tasks should be taken from real life.

In 1890 the Norwegian department published a plan for the district schools, in order to assist the regional school boards to organise the teaching. This was the first national curriculum in Norway. In the cities, the schools developed their own teaching plans, mostly inspired by the plans for the schools in Kristiania (Dokka, 1988, p. 99).

4.1 The national curriculum of 1922/1925

The syllabus from 1890 was adopted in most district schools, and remained the authoritative plan rather than a guiding plan until the early 1920s. A new national curriculum appeared in 1922, with a plan for the country schools, and in 1925 a plan for the city schools. This was a far more developed curriculum than that from 1890, and it marked a development towards a more modern national curriculum. The compulsory school in Norway included seven grades at that time. A system with ten years of compulsory education came with our latest curriculum reform in 1997. It was emphasised already in 1922 that the knowledge of mathematics (mostly arithmetic) should be useful for practical life. In all school years, the pupils should work with tasks dealing with ideas that they were familiar with (KUD, 1922, p. 22). The syllabus was divided into three parts, of which the second contained the plans for each subject. There the aims of the subject were presented, along

with plans for each school year and ideas for the teacher. The main aim for mathematics was expressed as follows:

The children should learn to solve the kind of tasks that will be of use to them in life, correctly, quickly and in a practical way, and they should present the solution in writing in a correct and proper way (KUD, 1925, p. 21).

The syllabus here has a practical view of the subject, closely connected with everyday life. When we look into the plans for each school year, this is not quite so apparent. Exercises and skill drills are given more emphasis here (KUD, 1925, pp. 21-22).

Exercises and skills are given more emphasis.

Most examples of how mathematics could be connected with daily life were about money and personal finance. Buying, selling and the exchange of money were considered to be good topics. Measuring and weighing were also important.

Whole-class teaching was supposed to be the main method of working for the teacher, and the skilled pupils were to be given the opportunity to solve more difficult problems. The blackboard was an important piece of equipment, and already from the first years, the teacher was supposed to introduce issues and objects that were familiar to the pupils. Buttons, coins, sticks, pebbles, etc., were to be used in the learning of numbers. The pupils were also to practise using the abacus. It was important to practise simple calculations, and the curriculum stated that the pupils should solve many simple tasks of the same kind to really learn addition, subtraction, multiplication and division.

The textbook was important already in 1922, and the curriculum clearly stated that the teacher should follow the course of the textbook in his teaching. When necessary, he should introduce additional tasks from other textbooks, or he should create tasks himself. These tasks should concern issues that the pupils would know about from their local community or what they had been taught in school (KUD, 1922, p. 30).

4.2 The national curriculum of 1939

The national curriculum of 1939, N39, is still viewed by many as the best national curriculum Norway ever had. The preliminary work on N39 lasted for about a decade, and the curriculum was used in Norwegian schools for about thirty years. The plan for each subject was supported by research and followed by a book containing further elaboration of the ideas and discussions connecting the chosen ideas, strategies and teaching methods with research results. The curriculum developers conducted their own research, but they also discussed results from international research.

In the previous curriculum, mathematics was grouped as one of the first three subjects, after Christian knowledge and Norwegian language. In N39, mathematics seemed to be somewhat devalued, and it was regarded as a skills subject only, along with writing, drawing, singing, handicraft, gymnastics and housekeeping. 'Refinement subjects' like Norwegian language, Christian knowledge, natural sciences, history and geography were placed first.

Further emphasis was put on the connections with everyday life.

One of the main ideas in all school subjects was to train the pupils for independent work, so they could become active participants in society. A major goal or idea was that the pupils should seek and find the necessary resources on their

own. The ideas of the German 'Arbeitsschule', and of John Dewey and the reform pedagogy were implemented.

The above-mentioned aim for mathematics in the 1925 curriculum was copied, but further emphasis was put on the connections with everyday life. The idea was to build upon the pupils' skills in areas that were useful in daily life. Practical tasks were emphasised and elaborated upon:

The subject matter should – especially for the younger pupils – be gathered from areas that the children are interested in by nature, and that they know from games and work at home, in school and otherwise. Later one must also gather material from areas that the pupils gain knowledge of in the school training, by reading books and magazines, or that they in other ways have gathered necessary knowledge about.

With time the area of content is increased and one includes decent tasks from the most important areas of society: from vocational life material from handicraft and industry, commerce and shipping, farming and woodwork, fishing etc. is included, and the things mostly needed for each age and level is specially emphasised. Likewise, material from other important areas of life in society is included, material concerning social issues of various kinds: population issues (population numbers, birth rate, disease, mortality etc.), work and unemployment, issues from accounting (assessment of taxes, budget of local councils etc.), filling out of diverse forms from everyday life, tasks in reading simpler tables from public statistics (for instance almanac tables) etc. (KUD, 1965, p. 140).

Teachers were supposed to provide tasks in accordance with local variations in the different schools, and the curriculum stated that the pupils should do a lot of independent work. Tasks that provided action, like filling out forms and lists from daily life, were emphasised in particular (KUD, 1965, pp. 137-142).

Ribsskog & Aall (1936), who were the main contributors behind the plan for mathematics, showed a genuine interest in the 'Arbeitsschule'. They were critical towards the 'skills schools', and they argued that the teachers were too bound by the final exams. In the preparatory work on the plans for mathematics, Ribsskog built on and discussed ideas from pedagogues of the past. Adam Riese (1492-1559), Chr. Pescheck (1676), Johann Pestalozzi (1746-1827), Wilhelm Harnisch (1787-1864) were some of the most important. Pescheck aimed at creating easy mathematical problems that were supposed to meet the demands of everyday life. Pestalozzi, in his attempt to train and educate the pupils, seemed to make more complex problems that were less suitable for children. These problems did not have so much to do with daily life (Ribsskog, 1935, p. 16). So as to develop a curriculum that corresponded with the skills and interests of the pupils, Ribsskog found it important to know about what the pupils at each stage were capable of, to know the subject itself (especially its difficulties), and to know what mathematics the pupils would need after their schooling was over. A subchapter even had the title: 'Teaching of mathematics must correspond with the demands of life', and Ribsskog claimed that the teaching first should take into account the abilities of the pupils, and then it should consider the demands of everyday life (Ribsskog, 1935, p. 117). The national curriculum of 1939 was in many ways a modern curriculum, and it contained many of the thoughts and ideas that we find in our present L97. These ideas are still discussed in present day research, as is done here in chapter 2.

The discussion of curriculum development (Ribsskog & Aall, 1936, p. 5) was almost prophetic, and they concluded that the changes that had been made in modern curricula, to a large extent, had not been improvements.

4.3 The national curriculum of 1974

After World War II, the development of new curricula continued, and in the 1960s and early 1970s there were a couple of temporary frameworks. It was during these years that the idea of a 9-year

compulsory school was first tested out in Norway. The temporary 1971 curriculum (M71) was strongly influenced by the New Math reform, that originated in the US, and M71 actually consisted of two parallel curriculum documents. One was built on set theory and presented the ideas of New Math, and was strongly criticised (cf. Gjone, 1983). Although it contained phrases directing the aims of the curriculum towards practical tasks and applications of the theory, it focused much more on content matter, and aimed at learning or skills drilling of mathematical terminology.

Connections to everyday life were minimal.

The principles of the 'Arbeitsschule' disappeared in 1971, and connections with everyday life were minimal, being almost exclusively limited to measurements. This curriculum was strongly criticised, and when the final version appeared in 1974 (M74), the

principles of the 'Arbeitsschule' returned and most of the set theory and mathematical logic had been removed.

M74 redirected the focus of attention to the connection with everyday life, which was clearly stated as one of the goals for the subject of mathematics:

The aim of the teaching of mathematics is to exercise the pupils in the application of mathematics to problems from daily life and other subjects (KUD, 1974, p. 132).

The aim of the school system was to educate pupils who were able to solve problems that often occurred in daily life, society and vocations. Still a large amount of the mathematics that was connected with daily life had to do with money.

4.4 The national curriculum of 1987

Even our penultimate curriculum appeared in a temporary edition. It was presented a few years before the final curriculum, in 1985 (M85). It was given the label 'temporary' because the Government first wanted to have a report on the curriculum development. When this report was finished, a new national curriculum was presented in 1987, and it was named M87 for short.

'Modern' ideas of constructivism and activity pedagogy were present in this curriculum also, as we can see in the following passage:

The school shall stimulate the pupils' need for activity and give them opportunities to use their own experience in the task of learning. The teacher must try to build on this experience, allowing the pupils to formulate their own questions and look for the answers, as well as pose problems that generate a desire for further knowledge and release the energy required to seek this knowledge (MER, 1990, p. 55) [The quote is from the official English translation of M87, which was published in 1990].

The connections between mathematics and daily life, and life in society and vocations, were also strongly present in this curriculum. In the plan for mathematics, these ideas were stated already in the introductory section:

Mathematics is a necessary tool within technology and science and other areas of life in society. Knowledge of mathematics is also part of our culture. Mathematics can be used to convey precise information, and such information presupposes that the recipient has some understanding and knowledge of the subject.

We need mathematical knowledge and skills in order to solve many everyday tasks, and to take care of personal interests and duties. For this reason, all pupils in the compulsory school receive instruction in mathematics (MER, 1990, p. 210).

These aspects were also mentioned in the objectives of the subject:

The teaching of mathematics is intended to

- teach the pupils about fundamental topics and methods in mathematics, in accordance with their abilities
- develop the pupils' knowledge and skills, to enable them to regard mathematics as a useful tool for solving problems in everyday life and at work
- train the pupils' ability to think logically and to work systematically and accurately
- make the pupils capable of working through and evaluating data for themselves, to enable them to make responsible decisions
- preserve and develop the pupils' imagination and pleasure in creativity
- stimulate the pupils to help and respect each other, and to co-operate in solving problems

(MER, 1990, p. 210)

If we look into the different topics of school mathematics, according to M87, we find the connection with daily life and practical tasks throughout. When we move into our present curriculum, L97, we should have in mind that the presumably new topic of 'mathematics in everyday life' is not at all new, and it was never even intended to be a distinct, additional topic, at least not in the same way as other areas of mathematics.

We find the connection with everyday life and practical tasks all over.

4.5 The national curriculum of L97

According to this present Norwegian curriculum, the pupils are supposed to be trained to become independent participants in society. This aspect has been visible also in earlier curricula, and it shows how the interplay between the school subjects and the daily life of the pupils is important. The immediate environment of the pupils is supposed to provide the basis for teaching and learning, as we see already in the general introduction to L97:

Education must therefore be tied to the pupil's own observations and experiences. The ability to take action, to seek new experiences and to interpret them, must depart from the conceptual world with which pupils enter school. This includes both experiences gained from the community, their local dialect, and the common impulses gained from the mass media. Teaching must be planned with careful consideration for the interaction between concrete tasks, factual knowledge, and conceptual understanding. Not the least, it must be conducted so that the pupils gradually acquire a practical record of experiences that knowledge and skills are something they share in shaping (RMERC, 1999, p. 35) [The quote is from the official English translation of L97, which was published in 1999].

The chapter concerning mathematics provides a thorough description of how this subject is connected to many aspects of life, and how mathematics is important in order for the pupils to understand and participate in the life of our society:

Man has from the earliest times wanted to explore the world around him, in order to sort, systematise and categorise his observations, experiences and impressions in attempts to solve the riddles of existence and explain natural relationships. The development of mathematics springs from the human

urge to explore, measure and grasp. The knowledge and skills which are necessary tools for these purposes develop through mathematical activities

The work with mathematics in the compulsory school is intended to arouse interest and convey insight, and to be useful and satisfying to all pupils, in their study of the discipline, their work with other subjects, and life in general

The syllabus seeks to create close links between school mathematics and mathematics in the outside world. Day-to-day experiences, play and experiments help to build up its concepts and terminology (RMERC, 1999, p. 165).

Underlining this important connection, the first area of the syllabus is called ‘mathematics in everyday life’. At first sight it might look as if ‘mathematics in everyday life’ is a distinct topic. Reading the text more carefully, we understand that this is supposed to be more of a superordinate topic or aim of the entire subject of mathematics to establish the subject in a social and cultural context (RMERC, 1999, p. 168). ‘Mathematics in everyday life’ is therefore to be understood more as an attempt to emphasise this aspect in school mathematics, rather than adding yet another topic to the mathematics syllabus.

We will look more closely into the notion of ‘mathematics in everyday life’, as presented in L97, but first we will conclude the presentation of curriculum development in Norway by pointing out three main sources for the mathematics plans in L97. When L97 (the mathematical framework) was formed, a group of scholars were put together. We have called this the ‘Venheim group’ after its chairman. When developing the mathematics frameworks for L97, the Venheim group studied international research and development work for inspiration and reference. The Cockcroft report and the NCTM Standards of 1989 were important, and so were the ideas of Realistic Mathematics Education from the Dutch tradition (cf. chapter 2).

4.5.1 The preliminary work of L97

Many factors affect teaching and learning. The syllabus, which is supposed to be the working document of the teachers, discusses aims, content, assessment and methods of work, but the local conditions and the conditions in the different regions and schools are also of vital importance. Politics, finance, jurisdiction and culture also influence these issues. Goodlad et al. (1979) described several levels or faces of a curriculum:

- The ideas of the curriculum
- The written curriculum
- The interpreted curriculum
- The implemented curriculum
- The experienced curriculum

This set of levels can be presented under different labels, but the idea is the same. L97 is a detailed curriculum, which describes what the pupils should learn and work on in the different subjects. The parents can go into the curriculum to see if their children have received the teaching that is prescribed for them. Intentions and practice are not always the same, and even though the ideas of the curriculum have been presented in the syllabus, the teachers often interpret them in different ways. The teachers might choose different strategies of teaching in order to reach the goals of the curriculum. The curriculum that the pupils experience in the classroom can therefore be different

from what was intended in the first place, and we can study the different aspects of this development per se. In this section we discuss the first two levels of this curriculum development, and in chapters 8 and 9 we study the interpretations and beliefs of the teachers. We will also see how they carry out their ideas in class. Since the main focus of our research is on the teachers, we will not go into the last level to any great extent.

4.5.2 The concept of ‘mathematics in everyday life’

As we have seen already, mathematics in daily life, real-life connections in mathematics, realistic mathematics, or mathematics in everyday life, as it is called in L97, is a concept with many possible definitions. When we use one of the phrases, e.g. ‘mathematics in everyday life’, it is not necessarily apparent what we mean by that (see the discussion in chapter 1.6). Realistic mathematics is a concept used by and connected with the Dutch tradition, building on the ideas and theories of Hans Freudenthal (cf. Freudenthal, 1968; 1971; 1973; 1978; 1991; etc.). The TIMSS 1999 Video Study addressed what they called real life connections in problem and non-problem settings. When using these concepts out of context, however, confusion might arise. This study focuses on the ideas of our Norwegian curriculum, and it is therefore natural for us to use this as a basis for our understanding of the phrase ‘mathematics in everyday life’.

In the current curriculum for compulsory education in Norway, as we have just seen, mathematics in everyday life is presented as one of five main areas in mathematics, and one of three, which appear throughout all three main stages of the 10-year compulsory school. These areas are somewhat different in character:

Mathematics in everyday life is presented as one of five main areas in mathematics.

The first area of the syllabus, mathematics in everyday life, establishes the subject in a social and cultural context and is especially oriented towards users. The further areas of the syllabus are based on main areas of mathematics (RMERC, 1999, p. 168).

Mathematics in everyday life is not an area of mathematics itself, but more of a superordinate topic that is supposed to show the pupils how mathematics can be placed and used in a social and cultural context. Before we discuss more closely how it is described in L97, we will quote the general aims for the subject of mathematics:

- for pupils to develop a positive attitude to mathematics, experience the subject as meaningful, and build up confidence as to their own potential in the subject
- for mathematics to become a tool which pupils will find useful at school, in their leisure activities, and in their working and social lives
- for pupils to be stimulated to use their imaginations, personal resources and knowledge to find methods of solution and alternatives through exploratory and problem-solving activities and conscious choices of resources
- for pupils to develop skills in reading, formulating and communicating issues and ideas in which it is natural to use the language and symbols of mathematics
- for pupils to develop insight into fundamental mathematical concepts and methods, and to develop an ability to see relations and structures and to understand and use logical chains of reasoning and draw conclusions
- for pupils to develop insight into the history of mathematics and into its role in culture and science (RMERC, 1999, p. 170)

Words like ‘meaningful’ and ‘useful’ are used, and the syllabus makes a distinction between school, leisure time, working life and social life. Mathematics is supposed to be useful in all these areas. Exploration and problem solving are also mentioned, and activity is a main concept. We get the impression that the curriculum developers want the pupils to develop skills in and insights into the subject of mathematics that they will be able to use in different contexts, and their understanding of this knowledge in mathematics should go far beyond mere factual knowledge. These aims are general, they have an idealistic appearance, and they are probably not achieved fully by so many pupils.

Mathematics in everyday life is clearly a special topic or area of mathematics in the Norwegian school system, as it is specified in the different stages. A more detailed overview of the contents of L97, as far as connections with everyday life are concerned, can be found in appendix 1. Beginning in years 1-4, this is the way the pupils should meet the area of mathematics in everyday life:

Pupils should become acquainted with fundamental mathematical concepts which relate directly to their everyday experience. They should experience and become familiar with the use of mathematics at home, at school and in the local community. They should learn to cooperate in describing and resolving situations and problems, talk about and explain their thinking, and develop confidence in their own abilities (RMERC, 1999, p. 170).

Mathematics should therefore be connected directly with the pupils’ everyday experience. Mathematics is not only a school subject, but it contains information that the pupils can use at home and in the local community also. The pupils should have the opportunity to:

- try to make and observe rules for play and games, and arrange and count
- experience sorting objects according to such properties as size, shape, weight and colour, and handle a wide variety of objects as a basis for discovering and using words for differences and similarities
- gain experience with simple measuring, reading and interpreting numbers and scales and with expressions for time (RMERC, 1999, p. 171)

At the intermediate stage, mathematics in everyday life is described with focus on use in the home and in society. A process of reinvention can be detected, and calculators and computers are introduced.

Pupils should experience mathematics as a useful tool also in other subjects and in everyday life and be able to use it in connection with conditions at home and in society. They should develop their own concepts of different quantities and units, estimate and calculate with them and with money and time, and become familiar with the use of appropriate aids, especially calculators and computers (RMERC, 1999, p. 174).

More concrete examples of how this can be done are found in the description of the topic in year 6:

- make calculations related to everyday life, for instance concerning food and nutrition, travel, timetables, telephoning and postage
- go more deeply into quantities and units, and especially the calculation of time. Learn about measurement in some other cultures
- gain experience with units of money, rates of exchange, and conversion between Norwegian and foreign currencies
- use mathematics to describe natural phenomena, for instance light and shade, day and night, seasons, and the solar system (RMERC, 1999, pp. 175-176)

Our main focus is on the lower secondary stage, and we will study more closely how L97 describes mathematics in everyday life for these pupils. For years 8-10, we read that:

Pupils should learn to use their mathematical knowledge as a tool for tackling assignments and problems in everyday life and in society. When dealing with a relevant theme or problem area, pupils will be able to collect and analyse information using the language of mathematics, to develop results using methods and tools they have mastered, and try out their approaches on the matter in question. Pupils should know about the use of IT and learn to judge which aids are most appropriate in the given situation (RMERC, 1999, p. 178).

It is not necessarily evident for a teacher how the pupils could learn to use their mathematical knowledge in other contexts than the school context. Researchers have described this transfer of knowledge as rather troublesome, and we look more closely at how this is supposed to be done in the three years of lower secondary education:

Grade 8

Mathematics in everyday life

Pupils should have the opportunity to

- continue working with quantities and units
- register and formulate problems and tasks related to their local environment and community, their work and leisure, and gain experience in choosing and using appropriate approaches and aids and in evaluating solutions
- be acquainted with the main principles of spreadsheets and usually experience their use in computers
- study questions relating to personal finance and patterns of consumption. Gain some experience of drawing up simple budgets, keeping accounts, and judging prices and discounts and various methods of payment
- practise calculating in foreign currencies (RMERC, 1999, p. 179)

We can see that issues from economics in general and personal finance in particular are put forward as areas of focus. Budgets, accounts and judging prices are mentioned, and the pupils should get to know about different methods of payment. The teaching of mathematics is also to be connected with the local environment and community of the pupils. This implies an implementation of sources other than the textbook. The pupils are actively to register and formulate problems, in reality to use their mathematical skills in situations they might encounter in their community. A specific issue is also that they are to practise calculating in foreign currencies. Pupils should also get experience with using spreadsheets and computers in mathematics.

Grade 9

Mathematics in everyday life

Pupils should have the opportunity to

- work with the most commonly used simple and compound units
- register, formulate and work on problems and assignments relating to social life, such as employment, health and nutrition, population trends and election methods
- work on questions and tasks relating to economics, e.g. wages, taxes, social security and insurance

- experience simple calculations relating to trade in goods, using such terms as costs, revenues, price, value added tax, loss and profit
- use mathematics to describe and process some more complex situations and small projects (RMERC, 1999, p. 180)

The same main topics are touched upon here as in grade 8, but more practical examples are mentioned. We are continually moving towards more specialised issues, and there is a development in the level on which the concepts and ideas are approached. With units, for instance, there is a clear development. In grade 8 the pupils are to continue working with the units they have learned in the earlier years, and in grade 10 they are to evaluate measuring instruments, etc. They should also work with several issues that are connected with society that could easily be connected with social science classes.

Grade 10

Mathematics in everyday life

Pupils should have the opportunity to

- evaluate the uses of measuring instruments and assess uncertainties of measurement
- apply mathematics to questions and problems arising in the management of the nature and natural resources, for instance pollution, consumption, energy supplies and use, and traffic and communications
- work with factors relating to savings and loans, simple and compound interest, and the terms and conditions for the repayment of loans, for instance using spreadsheets and other aids
- work on complex problems and assignments in realistic contexts, for instance in projects (RMERC, 1999, pp. 181-182)

In grade 10 we also discover an emphasis on projects as a method of work, and the pupils should solve complex problems in realistic contexts. Some teachers would argue that realistic problems are often complex.

L97 presents a rather concrete list of issues to work with.

In earlier Norwegian curricula, a list was often presented of content that the pupils should know. In L97, more general aims are presented of what the pupils should be able to do, and a list of concepts that the pupils should work with and gain experience with. There seems to be an underlying idea that in order to learn, certain skills, activity and work have to be involved. L97 presents a fairly concrete list of issues to work with, in order to connect mathematics with everyday life (cf. chapters 8.1 and 9.1). The pupils must experience these things for themselves, through some kind of activity. All this should imply a different way of working with mathematics in school than the more traditional presentation of theory followed by individual work on textbook tasks. This is also implied in L97 in the chapter called ‘approaches to the study of mathematics’:

Learners construct their own mathematical concepts. In that connection it is important to emphasise discussion and reflection. The starting point should be a meaningful situation, and tasks and problems should be realistic in order to motivate pupils (RMERC, 1999, p. 167).

Here we discover close connections to constructivism, and also to the ideas of Freudenthal, concerning reinvention, meaningful situations and realistic problems.

There is a clear emphasis in L97 on the connection of mathematics with everyday life. It is quite specific when it comes to what the pupils should work with, and it develops this specification through the years in lower secondary school also. It will be interesting to see how the teachers understand this, and how they interpret these ideas, which are described in the paragraphs labelled ‘why’ and ‘what’, into ‘how’ and ‘how much’. This is where it will be especially interesting to go into actual classes and see what methods and activities the teachers choose for the pupils to work with these issues. This practical knowledge, or a source of ideas where other teachers’ activities and approaches are incorporated, will probably be of interest to teachers.

Whenever a new curriculum is introduced, a period of time follows when the ideas of the curriculum are introduced to the pupils and become part of the classroom practice. This process might have a different speed and effect in different schools, and there is always a possible preservation factor, which makes sure some things remain the same, or at least that revolutions happen in a slow mode.

4.6 Upper secondary frameworks

How is the topic of mathematics in everyday life addressed in the frameworks for upper secondary school? In 1994, the Norwegian government passed a law stating that every Norwegian had the right to receive three years of upper secondary education. This law was part of a process to reform upper secondary education in Norway, called Reform-94. A result of this reform was that the general introduction to the national curriculum L97 applied to both the first 10 compulsory years of school and the upper secondary school. In addition, all subjects were given their own plans for upper secondary education. These plans were revised in 2000. We will take a closer look at the plan for mathematics, and especially the first year of mathematics at upper secondary school.

The connection of mathematics and everyday life is found here also, even though the emphasis does not appear to be so strong. In the introduction, mathematics is presented as part of our cultural heritage. ‘We all use mathematics’, is the opening statement. Not only the usefulness of mathematics is emphasised, though, but also a coexistence of theory and application is stated as necessary.

A coexistence of theory and application is necessary.

A course does not necessarily become more “useful” because it contains more applied topics. Nor are pupils necessarily more enthusiastic because mathematics is more closely related to their everyday lives. A certain amount of theory is needed to give applications of maths the weight and power to surprise that make them useful and interesting. At the same time, even the most theoretical mathematics course must have some links with the outside world to be meaningful and inspiring (MER, 2000).

Practical calculation techniques are skills that must be practised, because they are the methods any mathematician must know by heart. The inclusion of both understanding and techniques is suggested, because they are both dependent on each other. Aspects of real-life connections and reconstruction are also mentioned:

When mathematics is used to solve real-life problems, the pupils must be involved in the whole process, from the original problem to formulating it in mathematical terms, solving the mathematical problem and interpreting the answer in real-life terms (MER, 2000).

These ideas are supposed to be an integral part of the teaching of mathematics in upper secondary school. In the advanced courses the focus is mainly on mathematical knowledge, practising various types of problem-solving strategies, and mathematical methods. The real-life connection in particular comes up where problem solving is concerned. The syllabus states that the pupils should be able to translate real-life problems into mathematical forms, solve them and interpret the results.

In the first year of upper secondary school, all pupils have to study mathematics. The subject consists of a common module that they all have to take, and two more specialised modules that they choose from. In the common module, the connection with everyday life is strongly emphasised.

This subject is common to all branches of study, and is supposed to strengthen the pupils' basic knowledge of and skills in mathematics, especially in respect to their needs in everyday life, life in society and vocational life. (...) The subject matter should as much as possible be connected with practical problem formulations in vocational life and everyday life, but the pupils should also get to experience the joy of exploring mathematical connections and patterns without having direct practical applications (KUF, 1999).

In the course that every first year pupil in upper secondary school has to go through, there is an emphasis on the ability to translate a problem from real life into mathematical forms, as we have already seen in the goals for the more specialised courses. There are several other points with a direct connection between mathematics and everyday life in the goals for the first year pupils' mathematics course in upper secondary school. In conclusion we might therefore say that the connection between school mathematics and everyday life is strongly emphasised, not only in the curriculum for the compulsory school, but also in upper secondary school. At least the frameworks aim at such a connection.

4.7 Evaluating L 97 and the connection with real life

We have now studied the curriculum and what the authorities want the Norwegian school to be like in general, and we have discussed particularly how teachers are supposed to teach mathematics in connection with everyday life. L97 represents what we might call an intended curriculum, which again more or less represents the ideal curriculum of the authorities. When teachers read the syllabus, they interpret and create their own individual understanding of it. Together with other experiences and the knowledge of the teachers, it creates part of their beliefs about the teaching of mathematics. The pupils experience the curriculum in a way that is dependent on all these ideas, intentions and interpretations. These different layers, as we might call them, are not always the same, and they do not always represent the same ideas. The intended curriculum is not always equal to what the teachers comprehend, and this again is not always the same as what the pupils experience in class. We might say, in a more everyday language, that the teachers do not always practise what they preach.

In 2003 an evaluation study of the mathematics framework of L97 was published. This study aimed at evaluating how the curriculum was implemented. We will look more closely at the results of this study, particularly when it comes to the topic of mathematics in everyday life, as this directly touches the field of interest in our study.

In the introductory part of the evaluation study, the authors indicate that the ideas of presenting mathematics in other ways than what we might call traditional teaching are not new:

Robert Recorde, who wrote English textbooks in the 1500s, was concerned with the limitations of learning by heart, and he pointed out the importance of using a language that the pupils could

understand (Howson 1995). A.C. Clairaut, who wrote the book *Eléments de Géométrie* in 1741, believed it was wrong to learn geometry by first addressing the theorems, and then working on tasks (...) Clairaut pointed at a better method, namely to start with a problem, and through working with this, the pupils could build up an understanding of the theory (Alseth et al., 2003, p. 46).

Clairaut's suggestion represents an idea that has been emphasised greatly in the last few decades, and thus is often regarded a modern idea, namely to start with a problem and elaborate the theory from the work on that problem. This approach fits the ideas of RME well, and we find similarities with the ideas of guided re-invention. It also represents a shift of focus where real-life connections are concerned. When connections with real life have been presented in earlier curricula, the idea has often been that of applying already learned mathematical theories in problems with a real-life context. Here we do exactly the opposite, and start with a problem (that might be connected with real life) and build up an understanding of theory through our work with that problem. These ideas are not new, but there has been a shift of focus during the last few decades at least:

One of the major changes that have occurred in the last 30 years to 1995 was that examples and tasks became more related to connections with everyday life (Alseth et al., 2003, p. 46).

In L97 there is an increased emphasis on this connection, and mathematics in everyday life has become one of the three ongoing main subjects throughout all 10 years of compulsory school. A practical use of mathematics should therefore become a main point rather than a secondary point, like application of a learned mathematical content (Alseth et al., 2003, p. 48). There has been a shift of focus from the decades before L97, and this is the main change. Practical use of mathematics has been present in most the previous curricula, but now the idea is to start with a practical problem and end up with theory rather than the other way round.

Before	Now
Maths > Real life	Real life > Maths

In the last decade, this radical point of view seems to have gained a lot of influence in Norwegian schools. This point of view supports the notion of mathematics in everyday life the most. The idea that knowledge is situated in a context implies the importance of employing this context in order to teach specific subjects. It also raises the difficult question about transfer of learning from one context to another, which we have discussed in chapter 2.8 (Alseth et al., 2003, p. 79).

The teachers' manual is supposed to be a tool for the teacher in order to incorporate the ideas of the curriculum in a proper way. This manual describes several ideas and methods of work. Practical tasks, as they are called, have been included in Norwegian curricula almost since the beginning. L97 mentions practical work as a method in teaching, and it is presented as follows:

On the other hand there are a number of teaching examples where the pupils' everyday lives are included in the teaching in a genuine way. This will for instance be the case for activities where the pupils are going to play shopkeepers, explore and create art, gather data from the community that will then be edited and presented, etc. (Alseth et al., 2003, p. 88).

Further, they present as a focal point:

- that mathematics is a practical subject deeply rooted in life outside of school. This clearly comes to the fore in teaching examples from the teacher manual, where practical elements are used in two different ways. First, the manual suggests using concrete materials and practical examples to learn a

specific mathematical content. This can be described as mathematics with a “practical” wrapping. Second, it gives examples of genuine practical situations where mathematics may be used to enlighten or revise the situations (Alseth et al., 2003, p. 91).

In many textbooks they often use examples from everyday life as a wrapping.

It seems as if the first, using practical situations or elements as a wrapping for mathematical theories, is the more common. In many textbooks they often use examples from everyday life as a wrapping. The practical situations thus become much less

important than the mathematical content.

The idea of connecting the activities with the pupils’ everyday life is present in both the plan for in-service teacher education and the teachers’ manual.

Both the plan for in-service teacher education and the teacher manual are strongly coloured by a humanist view, with emphasis on the single pupil’s learning and exploration as a method of work, in order to detect qualities of mathematical concepts and structures. In addition, there are important elements of a radical view through the emphasis on communication and co-operation, and that the teaching should be based on activities from the pupils’ current or future everyday life (Alseth et al., 2003, p. 91).

There are several ways of presenting this connection with everyday life:

Relevance mainly becomes evident in two ways, either by smaller tasks and examples being connected to the pupils’ everyday lives, or by more extensive activities that were collected from or imitate everyday activities. In the textbooks, “everyday life” is first and foremost present in the first idea, as the problem context (Alseth et al., 2003, p. 98).

At the lower secondary level mathematical topics were often introduced by the teacher, who used a more or less appropriate practical situation as a wrapping. The ongoing focus was more on mathematical concepts than on the practical situation though (Alseth et al., 2003, p. 99).

In addition to such smaller problems, the pupils worked with more extensive activities. This took place as problem solving assignments, skill games (e.g. with cards or dice), character games (as shop-keeping) or by making or decorating something (wall plates, origami, baking) (...). At the lower secondary level such extensive activities were mainly directed towards learning of a specific mathematical content, and they were not so much attached to practical issues (Alseth et al., 2003, p. 100).

L97 indicates some major changes in the way mathematics can and should be taught in school. This is strongly opposed to the more traditional way of teaching. Although the teachers have the proper knowledge about the elements and ideas of the new curriculum, they still seem to teach in the way they have always done.

The teaching normally still takes place by the teacher starting the class with an introduction where homework assignments are reviewed and new content is presented. This presentation normally ends up in an explanation of how a certain kind of problems is to be solved. After this, the pupils work individually on solving such tasks from their textbooks. Sometimes the pupils work on more extensive activities (Alseth et al., 2003, p. 117).

There is an evident disagreement between what the teachers believe and stress in interviews, and what they actually do in the classroom. We discover another disagreement between knowledge and teaching practice where mathematics in everyday life is concerned.

In the mathematical training, most teachers on all levels stressed that mathematics should be practical (...) At the same time, the interviews revealed that at least three of five teachers put more emphasis on automation of skills than the independent development of methods by the pupils (Alseth et al., 2003, p. 147).

And:

It seems as if the teachers have gained good insight in the mathematics framework through the reform (...) The teachers are also very satisfied with the syllabus, even if it is seldom used in the daily teaching activities. In the teaching, four points are quite poorly implemented though. The main method of work in the mathematics classroom is still that the teacher lectures or is in a dialogue with the entire class, plus working with textbooks. In both these methods of work, practical elements mainly serve as a wrapping for a specific mathematical content, rather than that pupils learn something about a practical situation by the use of mathematics (Alseth et al., 2003, p. 196).

An exception was when the more extensive activities were sometimes used in the teaching.

The third main method of work observed, was connected to more extensive activities. This method had created a quite different impression than the two others. Even though the quality of the activities varied, this method of work was mainly marked by a close connection with practical situations, explorations and good communication and co-operation among the pupils (Alseth et al., 2003, p. 196).

There is therefore evidence from this study that teachers still teach in the traditional way. They lecture and present new content in a deductive way, using textbook tasks for the pupils to practise the theories. One exception is where more extensive activities are concerned. These may be project-like sequences, activities including games, storypath, etc. When these activities are used, practical situations are implemented. These activities are different from the regular teaching activities though, and it seems as if they are more of an exception than the rule.

In the conclusion, a connection with the current framework and international research is made.

The mathematics framework in L97 emphasises the following themes: practical use of mathematics, concept development, exploration and communication. This is in accordance with international research development in mathematics education. These points have been implemented in the teaching only to a low degree (...) It seems as if a considerably larger and more continuous raise of competence than the three-day in-service courses that were given in connection with the reform is necessary. So even if the teachers know about and appreciate these new points, the teaching has to a large extent remained so-called "traditional" (Alseth et al., 2003, p. 197).

Alseth et al. (2003) found a discrepancy between the teachers' beliefs and their actions. A change in the teachers' knowledge (and beliefs) had limited effects on their teaching, and a different kind of knowledge is probably needed if the result is to be changed teaching. The study called for a more extensive in-service education of teachers than the three-day courses that were used when the new curriculum was introduced. Studies like this call for further elaboration of activities for the teachers to use in their classroom teaching:

Since the textbooks are marked by short, closed problems, there is still a major need for developing good activities that the teachers can use in their teaching (Alseth et al., 2003, p. 118).

One possible approach is for researchers or scholars to sit down and create new activities and suggestions regarding methods and situations for teachers to use. Another is to draw upon the knowledge that already exists among practising teachers. We have seen how there is a disconnection

between teacher beliefs and teacher actions concerning everyday mathematics in Norwegian schools. In our own study we have observed some real classes so as to understand what the teachers actually do when they try and connect school mathematics with everyday life. We have also investigated some of the activities and approaches that teachers use when aiming at this connection in their teaching.

4.8 Curriculum reform and classroom change

Politicians often tend to believe that curriculum reforms lead to a change in teaching in the classrooms. Research suggests that this process is not always as automatic as one might hope.

According to Ernest (1991), when reform documents arrive in classrooms, interpretations hamper changes in teachers' practices. Interpretations of reform documents are problematic because readers interpret the ideas promoted in the documents according to their personal perspectives and ideological positions (Sztajn, 2003, p. 55).

We have already seen from the evaluation study of L97 (Alseth et al., 2003) that although the teachers' knowledge about the incentives and ideas in the new curriculum was good, the teaching practice still remained traditional. This is even more striking when we regard the fact that the theories of activity pedagogy, where problem solving is suggested as the main learning strategy and pupil activity is strongly emphasised, have been put forward in all four major curriculum frameworks in Norway from 1939 (N39, M74, M87 and L97). The ideas are not new. Yet in spite of this, the traditional way of teaching, where the teacher lectures the whole class, as was suggested in N22/25, still seems to be the main strategy for learning in Norwegian schools (cf. Olsen & Wølner, 2003, p. 16). Much emphasis is put on developing schools and curricula, but classrooms and teaching tend to be resistant to change. One might ask if school reforms seem more sensible to researchers and politicians than to the practising teachers (Hansen & Simonsen, 1996, pp. 91-92).

The teaching practice was still traditional.

Beliefs and knowledge are not always the same, and the evaluation study of Alseth et al. (2003) could indicate that it is not only enough to increase knowledge in order to change teaching practices. Then we can ask: Why is this so? The answer may lie in the role of teachers' beliefs. Do the teachers really believe in the proposed changes made by the politicians and their curriculum developers? Our study has a focus on the teachers' beliefs about the issue of connecting mathematics with everyday life rather than their factual knowledge about the curriculum intentions. We studied the teachers' professed beliefs, as well as their classroom practice.

5 Textbooks

Norwegian textbooks are normally written by experienced teachers. Textbooks are generally most important tools for teachers, and many teachers use the textbooks more than they use the curriculum when planning their teaching of mathematics (cf. Copes, 2003; Alseth et al., 2003). We have therefore studied the textbooks and how they interpret the curriculum intentions and particularly the ideas of connecting mathematics with everyday life. The textbooks that were used in our study of Norwegian teachers were emphasised, and we will discuss how these textbooks present the connection of mathematics with everyday life.

When textbooks make connections with real life, it is mainly by presenting word problems with a realistic context.

It is widely believed that mathematics can be made more meaningful, and mathematics instruction more effective, if mathematical procedures and problems are wrapped in the form of everyday language. There is a concern that children should feel comfortable with using simple numbers and simple numerical operations in “authentic” natural language situations.

But there are doubts whether many “word problems” - embedding (or hiding) mathematical applications in “stories” - do much to improve mathematical comprehension (Smith, 2002, p. 133).

There is currently a discussion about ‘realistic’ word problems (cf. Palm, 2002) and whether the everyday imagery in such problems makes it easier for the pupils or not (cf. Wood, 1988; Backhouse, Haggarty, Pirie & Stratton, 1992). It is often said that some word problems are merely artificial disguises for mathematical theory (see Arcavi’s discussion of word problems in chapter 2.7).

This chapter does not aim for a conclusion to this discussion, but our focus is rather on how textbooks deal with the ideas presented in the Norwegian curriculum as ‘mathematics in everyday life’. We have focused on the textbooks used by the teachers in our study, so that we could take up a discussion of the relationships between curriculum intentions, textbooks and teachers’ beliefs and practices.

WORD PROBLEM

“In mathematics education, a word problem is a mathematical question written without relying heavily on mathematics notation.

The idea is to present mathematics to the students in a less abstract way and to give the students a sense of ‘usefulness’ of mathematics. Word problems are supposed to be interesting problems that can motivate students to learn mathematics.”

http://en.wikipedia.org/wiki/Word_problem

5.1 The books

Grunntall (Bakke & Bakke, 1998) was the textbook used by both Ann and Karin, and the textbooks for grades 8 and 9 are quite similar. Ann taught 9th grade, so we analysed the main textbook for that grade, and the teacher manual for 8th grade, which Karin taught. We focused on how they are organised and how they address the issue of mathematics in everyday life.

Another textbook is called *Matematikk 8-10* (Breiteig et al., 1998a). This is actually a revised version of a Swedish textbook, *Möte med matte*, rewritten and adjusted to the current Norwegian frameworks. It presents itself as a textbook that takes L97 seriously, lets the pupils create, use and understand mathematics, connects mathematics and everyday life, provides good opportunities for differentiation, builds on the pupils current knowledge and suggests computer technology and projects. These statements are presented on the back cover of the textbooks, and give us high hopes.

The Norwegian textbook writer was strongly involved in the development of our current curriculum, and everything therefore implies that this textbook could live up to the ideas of L97. The writer should at least have every opportunity to understand the ideas and aims of the curriculum properly. We have analysed *Matematikk 9*, the textbook for 9th grade, and we focused on both the main textbook (Breiteig et al., 1998a) and the exercise book (Breiteig et al., 1998b). This was the textbook Harry used in his classes.

We also analysed several books in the *Sinus*-series ('sinus' is Norwegian for sine), which is one of the main textbooks for upper secondary school. There is one common textbook for the more theoretically based upper secondary school courses (Oldervoll et al., 2001), and one book for each of the vocational specialisations. We have focused on the textbooks for the pupils who have chosen to specialise in hotel and nutrition (Oldervoll et al., 2000a), and those who have chosen the more artistic specialisation (Oldervoll et al., 2000b). The reason for choosing them was that we observed classes from these courses in school 1, the first of the four schools in our study. For comparison, we also studied the previous version of *Sinus* (Oldervoll et al., 1997), to get an idea about the effect of the new curriculum for upper secondary school on the textbooks.

5.2 Real-life connections in the books

The textbooks were analysed on both a quantitative and a qualitative level. We counted the problems with connections to real or everyday life, and we also analysed several problems with real-life connections more in-depth, in order to see how the different textbooks make such connections. When counting the problems with such connections, we used a rather open definition of everyday life connections. All problems or tasks that used words or phrases that in some way referred to a situation in the outside world were counted.

Since most of the teachers in our main study taught geometry at the time of the classroom observations, we have chosen to focus on the geometry chapters of these textbooks in particular, as well as the chapters dealing specifically with mathematics in everyday life or mathematics in society.

Based on our study of the curriculum frameworks, we expected that the textbooks for lower secondary school would emphasise real-life connections to a somewhat greater extent than the textbooks for upper secondary school. We counted problems with connections to real or everyday life in each textbook to investigate this.

In the following subchapters, we will go into some examples of these real-life connections and discuss the problem contexts, whether they are authentic, realistic, part of the pupils' everyday life, etc.

5.2.1 Lower secondary textbooks

Grunntall has a traditional appearance, but several teachers at school 3, including Karin, said that they liked it. They said that it was built up in such a way that the pupils (especially the smarter ones) could read and get an understanding on their own. We discover a traditional structure, where it presents some theory followed by a number of tasks, starting with simple tasks and moving on with some more difficult word problems towards the end. It is in these word problems that real-life connections occur. The problems are 'realistic', but many are what we might call faked real-world problems though. In the introduction, they establish a connection with everyday life:

Many problems are what we might call faked real-world problems.

In our everyday life, we have to use a lot of mathematics, and it is important to know the subject and check calculations that affect us, so that we do not get tricked. Mathematics is necessary to be able to take the right decisions, when it comes to both financial and other issues (Bakke & Bakke, 1998, p. 3).

The textbook thus claims to focus on real-life connections. Both the textbooks for 8th and 10th grade have chapters called ‘mathematics in everyday life’, but the textbook for 9th grade for some reason does not. Two chapters are specifically devoted to the issues though, one called ‘numbers in many situations’ and one called ‘we calculate with money’. We analysed these two chapters as well as the geometry chapter, which was the chapter taught by most teachers.

Each main chapter has several subchapters with topics that are connected. Each subchapter is introduced with some text, some with figures or examples, and several tasks. At the end of each main chapter, there is a set of additional tasks. In the geometry chapter there are 143 tasks altogether. Thirty-one tasks include connections to real or everyday life, which is more than 20%.

Matematikk 9 has a chapter on geometry, one chapter that is called ‘Mathematics in society’ and another chapter that is called “What’s happening? – Practical mathematics”. These three chapters will have the focus of our attention, since they are more related to our study in different ways. There are also chapters on more traditional mathematical issues like numbers, algebra, probability and functions. The chapters in the book are divided into subchapters with certain topics. A subchapter is often introduced with some comments including some statistical information. The pupils are then presented with a set of problems to work on. These problems are often interrelated, and they are connected with the information given in the introduction to the subchapter.

In the geometry chapter, there are 149 tasks altogether, when the examples are not included. Of these, 31 have some sort of connections with real life. These connections might be artificial sometimes, but all references to real life have been counted. 118 tasks are purely mathematical with no connections or links to real-life situations whatsoever. About 20% of the geometry tasks thus include real-life connections. These are of course only numbers, and it will often be more interesting to analyse the content of some examples of tasks, but these numbers nevertheless give us an indication of how much the writers have emphasised the issue.

A main idea of the textbook is that the pupils learn through solving problems. Only four examples are given in the geometry chapter, and one of these has a real-life connection. Each subchapter, or each topic, is normally presented with a few introductory comments, and then several problems are presented. The problems and routine tasks presented are often connected, and the pupils are given the opportunity to discover mathematical content through the tasks. Each chapter starts with an explanation or introduction to the new content, which is introduced through tasks. After this section a test is given, where the pupils can check if they have understood the content. Then two subchapters follow where the content is introduced in a new and different way, and where it is further elaborated on. At the end of each main chapter, the main content of the chapter is summarised.

A main idea is that the pupils learn through working with problems.

An interesting observation here is that this textbook does not contain a larger percentage of tasks with a real-life connection in the geometry chapter than *Grunntall*. Actually the percentage is slightly lower. When *Grunntall* seemed to have a more traditional appearance to us, this might have to do with the layout, the images used, and the formulations of the tasks.

We have also studied the exercise book for the pupils in 9th grade (Breiteig et al., 1998b), i.e. the book that Harry’s pupils would use. There are many word problems in the book, and some have realistic contexts. The geometry chapter had a total of 108 tasks, 26 of which had references to real life. In other words, about 24% of the tasks were connected with

About 40% of the tasks have a real-life connection.

real life, which is a bit more than in the main textbook. When problems had a shopping context, prices were realistic and the contexts of the problems generally had an authentic appearance. Comments and explanations were often given in between the problems and tasks. In one chapter we found an interesting comment:

When we have found the answer to a practical exercise, we should make a habit of asking ourselves if the answer or the result was reasonable. An unreasonable answer implies that we have done something wrong, and we have to find the error (Breiteig et al., 1998b, p. 13).

This book also has a chapter on mathematics in everyday life, only it has been called ‘Mathematics in society’. As in *Grunntall*, this chapter involves issues connected with shopping, percentages, prices, discounts, salaries, and other issues that are often connected with personal finance.

5.2.2 Upper secondary textbooks

The previous version of the *Sinus* textbook (Oldervoll et al., 1997) will be our starting point here. Of the 44 tasks in the problem section after the geometry chapter, 42 are purely mathematical with no connection to real life. One is a pyramid problem, where you are to use the shade from the pyramid and the shade from a stick to find the height of the pyramid. The other is about Kari, who is going to build a cottage. First, she has made an exact model of the cottage, and then she is going to find out several measurements on the real cottage that she is going to build from the model she has already made. The pyramid problem is adopted in the new textbooks. We will not analyse many problems from the old textbook, and we conclude that only two tasks in the geometry chapter (less than 5%) had real-life connections.

Pupils in Norwegian upper secondary schools, those who are not following certain vocational courses, use a common textbook in mathematics. In addition to the geometry chapter we focus on the trigonometry chapter, which is related and which was taught while we were visiting school 2.

Each main chapter in this book is divided into subchapters, which contain a presentation of certain theories, sometimes including historical comments. There are some examples in each subchapter, and from a total of 14 examples in the geometry chapter, six include connections with real life. At the end of the chapter there is a summary, followed by a section of tasks. There are 92 tasks in the geometry chapter, and 25 of them have connections to real or everyday life (27 %).

The textbooks for the vocational courses are quite similar in structure and layout. At the end of the textbook for hotel and nutrition, after all the main chapters, there is a section with additional tasks. The tasks are presented according to the order of the main chapters, and each subchapter includes tasks of three different levels or categories. There are many word problems in this collection, but also some purely mathematical tasks. Several word problems are about hotels, restaurants or similar. From a total of 58 tasks in the problem section, 23 include real-life connections and 35 are purely mathematical (about 40% of the tasks have a real-life connection). In the textbook for drawing, shape and colour, there are more tasks that have to do with arts and handicrafts, and we also find examples of similar tasks with slightly different contexts from the textbook for hotel and nutrition. A large number of the tasks in the textbook for drawing, shape and colour include images and drawings of artistic patterns which are unique for this textbook. In the problem section of this book, 23 out of 56 tasks include real-life connections, which is quite a lot (41%), at least compared with the textbooks from lower secondary school. They involve quite realistic tasks and problems concerning curtains, table cloths, different kinds of artistic patterns, quilting, etc. In the textbook for hotel and nutrition the tasks that are supposed to be connected with real life for these pupils seem

somewhat more artificial and less realistic. They often include purely geometrical sketches with a sentence or two in the beginning, stating that this has to do with a hotel or the parking lot of a hotel.

5.3 Textbook problems

It is interesting to observe that the textbooks for upper secondary school contain a larger percentage of problems with connections to real or everyday life, and that the books for the vocational courses outnumber all the other books where real-life connections are concerned. The textbooks for lower secondary school had quite similar percentages of problems with real-life connections in the geometry chapters, even though our initial impression was that one (*Grunntall*) was more traditional. We have studied some examples of problems from each of the textbooks, to see how they make real-life connections in textbook problems.

5.3.1 'Realistic' problems in lower secondary school

5.3.1.1 Realistic contexts

Many textbook problems are presented as word problems with realistic contexts. Sometimes these contexts are artificial, sometimes not.

An example of a problem with a realistic context is from *Grunntall*, chapter 4:

'Trollstigen' is a road that twists up a very steep hillside. The steepest part has a slope of 8.3%. How far must a car drive for each metre it is going up? (Bakke & Bakke, 1998, p. 130).

This is an interesting task on a relation that most people have seen on traffic signs. Many seem to have difficulties understanding how steep a hill is when the increase is 8%, and this kind of task will show how it can be calculated. There are many other interesting tasks in this chapter, which has subchapters dealing with the mathematics of postal codes or zip codes, telephone numbers, book numbers and other examples where numbers are used as codes, etc.

The chapter called 'Mathematics in society' in *Matematikk 9* (Breiteig et al., 1998a) could have been called 'Percentages', because this is what it is mainly about. It is almost exclusively a chapter on different contexts in which percentages can be used. The chapter is connected with life in our Norwegian society, containing topics like young people and traffic, what influence TV, commercials, friends and other factors have on young people's decisions, buying and selling, income and taxes, issues about population, politics and elections, etc. Many of these topics could easily have been taught in a social science classroom. One subchapter concerns income and prices, and it brings up the relationship between the increase in prices and the increase in wages. It starts off with some quotes (Breiteig et al., 1998a, p. 115):

- My income is almost the double what it was 10 years ago, Stine says.
- My income is almost three times as much as when I started here, Solveig says.

- a How many percents has Stine's income increased in 10 years?
- b How many percent, approximately, has Solveig's income increased since she started.

A mathematical problem context does not always have to be part of the pupils' present everyday life.

Here is an example of a realistic problem concerning income and increase of income, and it includes percentages without mentioning how much the income actually was. There is also a table from which to estimate the taxes based on the income, and this is a copy of a table that everyone can get from the official tax office. The problem contexts are realistic, and they include issues that one could encounter in our society, but they are hardly part of the everyday life of most pupils at this age. Some of them might have small part-time jobs, but for most of the 9th grade pupils the issue of taxes and income are not connected with their present everyday life. The contexts are connected with their future everyday life though, which is also an important element of education. We should be aware that even when an issue might be connected with life in society, it could be of little or no interest to the pupils, simply because it is not part of their present everyday life. The question of "everyday life – for whom?" should be kept in mind. We do not want to suggest, however, that a mathematical problem context always has to be part of the pupils' present everyday life. This would limit the subject matter. The syllabus presents mathematics as a tool that should become useful for the pupils in school, in their leisure activities, and in their working and social lives. But the curriculum states that the pupils should become acquainted with mathematical concepts that are directly related to their everyday experiences also (RMERC, 1999, p. 170).

The chapter on mathematics in society could in many ways be seen as a direct response to the demands from the curriculum that the pupils should have the opportunity to work with questions and tasks relating to money. Taxes, wages, buying and selling, etc., are mentioned explicitly in the aims of the curriculum (RMERC, 1999, p. 180).

One of the problems is about an issue that should concern many pupils, namely waking up in time for the school bus (Breiteig et al., 1998a, p. 268):

Peter is going to take the bus at 07.52 AM. He oversleeps and wakes up at a quarter past nine.

- a) How many minutes is it since the bus passed?
 b) How long is it till the next bus leaves at 11.08 AM?
 c) How late will Peter be if he takes this bus?

Most pupils have experienced missing a bus and arriving late for school, and the textbook presents multiple tasks involving calculations of time. Some tasks directly challenge the difficulties that arise when the unit is 60 rather than 100. One such task includes a train table. According to the train timetable a certain train leaves at 12.15. A girl called Ida comes to the station at 11.58, and she believes she has 57 minutes till the train leaves. The question is: what mistake has Ida made when calculating how much time is left till the train leaves? (Breiteig et al., 1998a, p. 265).

In the additional tasks for the chapter on mathematics in everyday life, in the teachers' manual of *Grunntall* (Bakke & Bakke), there are many problems concerning shopping. Some are just simple additions of prices, some involve calculating the exchange, while other tasks involve calculating with percentages when an item is on sale. The problems are given a context, to connect them with everyday life. An example of such a task is the following:

Stine has seen an advertisement in the newspaper that CDs are being sold for 149 kroner in the neighbouring town. Usually, Stine has to pay 169 kroner for a CD. She is going to buy three CDs. Will it pay off to travel to the neighbouring town, when the trip costs 25 kroner each way?

This is a rather typical task that has to do with shopping. What pays off? All the necessary information is given, and it all has to do with Stine, who is going to buy CDs. She has seen the advertisement in the newspaper. Thus the task has been given a particular context, and it is a realistic context in many ways. The prices are close to what CD prices are in Norway, and it is also a meaningful context as most pupils listen to music and buy CDs. Probably they often think more about what music they want than where to get it at a lower price, but this is clearly a context that would qualify as a real-life connection. The not so realistic part, which is normally the case with textbook tasks, is that all the prices have already been collected and compared. In real life the pupils usually have to find this information for themselves. The pupils could have been given a similar task, where they had to check out different prices from their local CD suppliers, calculate all the costs and discuss what would be the cheapest. Such a task might have been even more realistic, and the pupils could get involved in checking things out, making assumptions, doing calculations, etc. In this task, one would easily be led into doing simplifications and abstractions. The piece of useful information could be limited to: 149 versus 169, 3 CDs, and an additional cost of 25 kroner times two. The pupils have to do some simple calculations once they have picked out the necessary information. The context really does not play such an important role, but is more of a wrapping.

The subchapter that deals with Pythagoras' theorem in the main textbook of *Matematikk 9* (Breiteig et al., 1998a) starts with presenting an image of how a rope with equally distributed knots can be used to create a right angle, and it is claimed that this method was used by ancient Egyptian workers. Then an task is given where the pupils get the opportunity to discover the theorem by themselves. Many of the tasks concerning Pythagoras' theorem are purely mathematical. Some offer a real-life context though, and we are introduced to

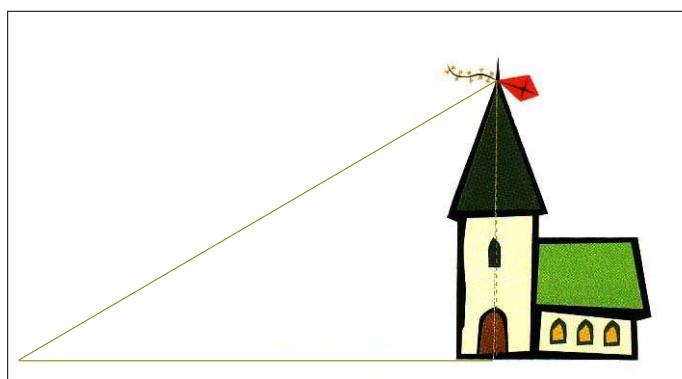

Illustration 2 Breiteig et al. (1998a)

different contexts where the mathematical theories can be used. In many textbooks Pythagoras' theorem is applied in tasks involving a ladder placed against a wall, but in this book we get a nice example where a kite is stuck on a church tower. The most obvious problem would of course be how to get the kite down without breaking it, but the example shows how you can find the height of the church tower if you know the length of the line attached to the kite and the distance from the church tower to where you stand holding the line. This example includes a situation that might occur in the pupils' real life, but the calculations done are purely mathematical and do not involve elements that draw upon real-life experiences. It is assumed that we know the length of the line, which we might or might not know, and it is assumed that we know the distance from where we are standing to the church tower, or actually the distance to the centre of the church tower if the theory is to be properly applied. Perhaps the task should involve some thoughts on how this distance could be found and the problems this might involve. Sterner (1999) states that we often work with 'as-if-problems' in school. These problems suggest how we could find the height of the church tower for instance, as if we were going to do that, but we are not actually going to find the height of the church tower in reality. Perhaps we should sometimes try out things like this to see what kind of practical problems and issues that could come up, or perhaps we should at least discuss these issues.

This leads us to a discussion on problems where the ‘realistic’ context becomes more of an artificial wrapping than a true real-life connection.

5.3.1.2 Artificial contexts

Some problems are presented with an everyday life context that, although realistic in some sense, we would say are more artificial than realistic. We find an example of such a problem in *Grunntall*, problem number 6.37 (Bakke & Bakke, 1998, p. 180). This task tells us about the Vold family and their rectangular shaped garden. They want to divide the garden in two parts by planting a hedge diagonally. If the garden is 35 metres long and 22 metres wide, how long is the hedge? They have even included a drawing of the family working in the garden. Concerning the realism, a question might be: where do you ever see anyone plant a hedge diagonally in a rectangular shaped garden (except in a mathematics text book)? And what would be the point of the task, except to get more practice in the use of Pythagoras’ theorem?

The following task is another problem on the same issue. Beate has got a make-up box. The box is 10 cm long and 6 cm wide. Her mascara pen, which is 12 cm long, is too long to fit in the box. How long should it be to fit? This problem is more realistic, but it would have been better to include the depth of the box in the discussion also, because this is actually quite important, if you do not assume that the mascara pen has to lie on the bottom of the box. This task could raise an interesting discussion in class. (If the box had been more than 2.82 cm deep, the mascara pen would actually fit into an empty box.)

In the exercise book of *Matematikk 9* (Breiteig et al., 1998b) we found a problem that was somewhat similar to the task above, which had to do with finding the maximum length of a stick that fits into a certain box. Here there is a question included on what length of stick could fit if it was placed at the bottom of the box (diagonally we would suppose), and if it lay with one end in a bottom corner and one end in the diagonal top corner of the box. This is the element we missed in *Grunntall*. There are several ways of placing a stick, a pen or a similar object in a small box, and when this issue is not taken into consideration it becomes tempting to assume that the problem context is a wrapping for practising Pythagoras rather than a realistic context. We believe that a problem could become more realistic if we make use of the context, but a quite similar problem could easily become artificial.

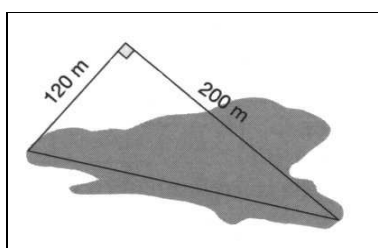

Illustration 3 Pythagoras on a lake, from Breiteig et al., 1998b, p. 84.

Pythagoras is one of the main themes in the geometry chapters, and there are some tasks with rather artificial contexts. Another task from Breiteig et al. (1998b), number 4.18, also indicates the use of Pythagoras theorem. In this task two children are starting out from the same point. One of them starts walking straight north, and the other starts walking towards east. When the first child has walked 800 metres, the distance between them is 1600 metres. The question now is how far the other child has walked. The pupils are probably supposed to discover that their routes and the distance between them form a right-angled triangle, and then use Pythagoras to solve the problem. This is an example of how one might use mathematics in situations from everyday life. One might of course ask how they

measured the distance between them. And when one of them knew the distance she had walked, how come the other did not? Perhaps it would have been more realistic if both had walked for a certain time, measured the distance they had walked and then calculate the distance between them, but this problem looks more like a ‘real’ textbook problem than a real-life connection. One might at least argue that the pupils should discuss these issues. If they only solve it as a purely mathematical task, using Pythagoras, it will become more of an artificial wrapping than a true real-life connection.

In another task from the chapter on geometry (see figure above), the following problem context is presented:

To be able to measure the length of the lake, Ida has measured distances as shown in this figure. How long is the lake?

This is another example of a task where the context has a realistic nature. There is a lake, and Ida wants to find the length of the lake. It would have been interesting to know how Ida measured the two lengths given in the figure. For a pupil, it could be hard to understand why she could not measure the length of the lake when she could measure the two other distances in the figure. If this is not discussed, the problem would easily become an exercise in using Pythagoras more than being a true real-life problem.

When we visited Karin's class, they were working on algebra. Most of the algebra tasks are exercises in adding, subtracting and multiplying sets of numbers and unknowns, but there are a few word problems that we will take a look at. In one of these tasks they use apples instead of letters. It goes like this:

Randi ate 3 apples a day.

- a) How many apples did Randi eat in 4 days?
- b) How many apples did Randi eat in 7 days?
- c) How many apples did Randi eat in 10 days?
- d) Make a formula that tells how many apples Randi ate.

Since it is presented in the algebra chapter, the aim of this task is to come up with a formula and then point out, or let the pupils discover, that all such problems can be solved in similar ways. The other task was quite similar, only a bit more complex, but with a slightly different context. One might argue that the context is important for the problem here, but the goal is clearly to generalise and make a formula, and we believe that the context here is more artificial than realistic.

5.3.1.3 Other problems with real-life connections

In the teachers' manual for *Grunntall* a group of tasks is presented as problem solving tasks. Several of these problems are presented in real-life contexts. Here also, we get the idea that the contexts often serve more as a wrapping. The real-life connection does not appear to be all that important, other than to give the problem a motivating context that the pupils can recognise and relate to. An example of such a problem is:

Raymond and Robert have collected in total 27 bottles after a soccer game. Raymond has collected 5 bottles more than Robert. How many bottles did Robert collect?

Raymond is always the lucky one, is he not? Perhaps the textbook writers used the characters from the popular American TV soap of Ray Romano, but still, many boys have probably collected empty returnable bottles after an event. The situation should therefore be familiar to the pupils. It is odd, however, that they know that Raymond has collected 5 more bottles than Robert, but not how many bottles each has collected. The problem is therefore regarded as artificial, and the context itself appears to be more of a wrapping. The aim is probably for the pupils to abstract and come up with an equation similar to this: $(x + 5) + x = 27$ (or maybe two equations: $y + x = 27$ and $y = x + 5$), and get the answer that Raymond collected 16 bottles and Robert 11. There are probably other ways of

solving the problem also. If the teacher takes the solution methods of the pupils seriously, and lets the class discuss which method to use and why (something like the Japanese approach discussed in chapter 3.4.3), then such a problem could become really interesting. Quite often though, such problems tend to become exercises in using a certain procedure. In fact, all these additional tasks present similar problems in somewhat different contexts. Some more examples:

Tommy has 3 more tennis balls than footballs. How many footballs does he have, when he has 11 balls altogether?

Tina and Mari have 15 kroner altogether. How many does Tina have when she has 3 more than Mari?

Peter is 2 years younger than his brother. How old is Peter when their total age is 30 years?

All these problems are similar once you have done the abstraction. One person has a larger amount of something than the other, they have a certain amount altogether, and the task is to figure out how much one of them has? All these problems can be solved in a similar way, and it is tempting to draw the conclusion that the aim is to let the pupils learn to use one particular procedure to solve such problems. This can be done in different ways, and it becomes an interesting sequence, but the teacher could spoil it by telling the pupils what procedure he wants them to use and not let them discover this for themselves (cf. Freudenthal, 1971). The pupils might come up with other methods of solving the problems, and it would be interesting if the teacher let the pupils use these and discuss them in class (like in the Japanese example in chapter 3.4.3).

We often present word problems where the mathematical problem is hidden.

What often seems to be the case with word problems is that there is a mathematical problem we want the pupils to solve, and then we present a word problem where this problem is hidden within a certain context. The pupils have to find the proper numbers, and then they have to figure out what method we want them to use in order to get the right answer.

Some of the problems have an everyday life context, but they are not problems that the pupils would normally meet in their everyday lives. Sometimes an artificial problem is derived from a realistic context. We found an example of this in the collection of C-level tasks for the chapter on mathematics in everyday life:

When Pia had tidied up her room, she went to the second-hand store to sell some books that she didn't want any more. She sold seventy comic books and twenty-five children's books. For 60% of the books she got 5 kroner for each book, for the rest she got 7 kroner for each. She got 1 krone a piece for half of the comic books, and for the rest she got 50 øre a book (1 krone equals 100 øre).

For the money she got, she bought other comic books costing 2.50 kroner a piece.

How many comic books did she buy?

Many children have probably bought second-hand comic books, so the context presented should be familiar. Some pupils would probably think: why could she not just count how many comic books she has bought? The idea is no doubt that the pupils should practise using certain mathematical procedures to solve a problem, and although the context is from an everyday life situation, the pupils have probably never encountered this particular problem in everyday life. Therefore we believe that the context is more of a wrapping. The aim of the task is to let the pupils do the abstractions and solve the problem using mathematical methods.

A few tasks were of a different kind, and in fact they were really more suggestions for activities than ordinary textbook problems. One of these tasks concerned the golden rectangle:

- 4.81 Measure the length and width of some pictures. Calculate the relation between them and decide whether the picture is a golden rectangle (Breiteig et al., 1998b, p. 99).

This is a more open task, although the goal is explicitly stated and the method implied. Now the pupils have to measure real objects rather than geometrical sketches in a textbook. We believe there should be more such tasks, which would actually be more like mini-projects than textbook tasks. Most textbooks present more formalised tasks though, where the pupils can practise certain algorithms and find the correct answer in the the key at the back of the book.

5.3.1.4 Comments

We have seen some examples of word problems in lower secondary textbooks, and we have criticised many of them. We argue that including a text that says: ‘Ida wants to find the length of the lake’ is often more of an artificial wrapping for a purely mathematical problem than a real-life context. The text indicates that there is a real-life connection, but if it becomes just another exercise in applying a certain algorithm the context might be considered to be an artificial wrapping. This kind of problem could also be called an ‘as-if-problem’, representing an exercise where the pupils are to find an answer as if they were really going to solve the practical task that was indicated. Some would argue that these small sentences really make a difference, and that they make the mathematical problems more real, more motivational and easier to understand for the pupils. Others might argue that the opposite is the case. The curriculum clearly presents ideas about connecting mathematics with real life, and with the pupils’ everyday life. We will not try and solve the problems and controversies of word problems here, but only pose some questions and present some of the issues for debate. Our main focus is on what the teachers actually think and do, and how they use such problems in their teaching, more than deciding whether the use of word problems is a good way of connecting with real life. Contexts in word problems might refer to real or everyday life, and we then argue that they are (in a way) real-life connections. When discussing ‘mathematics in everyday life’, however, or the issue of making connections with mathematics and everyday life, we need to include a discussion of the teachers’ strategies and how they organise the activities where these word problems are used. Therefore the problems that have been counted as having a real-life connection in this chapter only need to include words that refer to something in real life. When discussing further if these problems are realistic, we have included a discussion of how these problems might be encountered by pupils, or how teachers might use them. There certainly are some issues to discuss about this, and our purpose in this chapter is to introduce you to some of them.

5.3.2 ‘Realistic’ problems in upper secondary school

5.3.2.1 Realistic contexts

One of the tasks with a real-life connection in the main *Sinus* book introduces a water bed:

Exercise 4.50

A water bed has the internal measurements

180 cm x 220 cm x 20 cm

How much does the water in this bed weigh? (Oldervoll et al., 2001, p. 144)

Most of the tasks on volume and weight include references to some items from real life, and a water bed is a good example. Many tasks present some measures and then ask the pupils to calculate the volume or the area. Few tasks include questions that could raise a discussion about the real-life situation mentioned, and thus make this situation even more realistic to the pupils. In this task one might discuss the fact that the water in a water bed is contained in a mattress, and the amount of water could be adjusted. This would influence the firmness of the bed, and it would also influence the weight. Such discussions, which do not need to include any mathematical considerations, could help making the contexts of the tasks more realistic to the pupils. Otherwise the contexts easily become artificial wrappings of textbook problems.

Another example with a real-life connection deals with the steepness of a road. A picture of a traffic sign is presented. This tells us that the road has a steepness of 7% for the next three kilometres. The aim of the example is to find the angle of the road. This could be done by doing calculations involving tangent. At the end of the chapter there is a section with 56 tasks. Only one of these tasks contains a real-life connection. This is also about steepness of roads, and it presents some interesting questions:

Exercise 5.55

a) Is it possible for a hill to have a steepness of 100%?

What would the angle of steepness be in that case?

b) Could a hill have a steepness of more than 100%?

How large would the angle of steepness be then? (Oldervoll et al., 2001, p. 169)

This problem should challenge the pupils' conceptions of steepness and result in an interesting discussion. It should also encourage a discussion with links to the everyday knowledge of the pupils.

In the textbook for hotel and nutrition in the vocational courses (Oldervoll et al., 2000a) we are introduced to a problem concerning a hotel. The problem context is that 'Hotel Cæsar' is going to decorate the rooms ('Hotel Cæsar' has been one of the most popular Norwegian TV soaps for some years). A rectangle which measures 468 cm by 335 cm is presented as the sketch of one of the rooms. Question a) concerns how many metres of skirting board is needed. Question b) concerns putting down floor covering. This comes in rolls that are 1.20 m wide. How many metres of floor covering would be needed to cover the floor in one room? This is a realistic problem (in that it refers to a situation from real life), although the sketch for the room is artificial, and it could imply an interesting discussion of issues that would come up if this were really going to be done. In many ways this is a typical 'as-if-problem'.

5.3.2.2 Artificial contexts

We do not intend to make a clear distinction between what we call 'as-if-problems' and problems with artificial contexts. The context of a problem could be truly realistic, but if the context is not drawn upon in any way we would often call it an artificial context. Another way of putting it is to describe the context as an artificial wrapping for a truly mathematical problem. We will look at one of the examples in Oldervoll et al., 1997 (the old version of the *Sinus* textbook), p. 115. It presents an image of a table (see the illustration), and we are told that Kari is going to make such a table. The

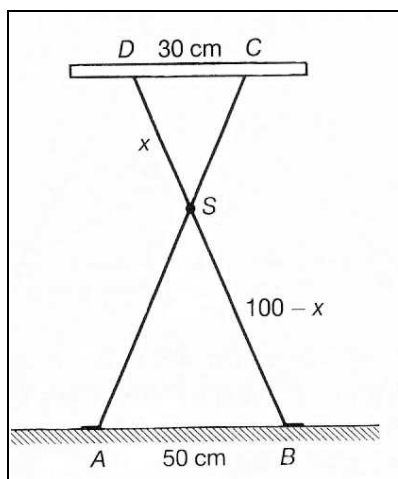

Illustration 4 This is the table Kari is going to make.

question is how far from C she must place the connection point S, given the information in the image. A question concerning the importance of the connection with real life here could easily be raised. The textbook does not draw upon real life until the answer is given, and the solution method is presented in purely geometrical terms.

The new textbook has adopted the table task from illustration 4 as one of the examples, only changing the length of the legs from 100 to 70 centimetres. We will take a look at one of the tasks from the geometry chapter, a pizza-problem:

Exercise 4.61

A pizza has a radius of 15 centimetres. Hege takes a piece that has an angle of 40° .

- How large a proportion of the pizza does Hege take?
- What is the area of this piece? (Oldervoll et al., 2001, p. 145)

The real-life connection in this task is apparent. There is a pizza and Hege is taking a piece of it. Most pupils are familiar with such a context. The task tacitly assumes that the pizza looks like a geometrical circle, and we get a strong feeling that the motive for the task is to let the pupils practise proportions in circles rather than discussing pizzas. The pizza situation looks like a wrapping for a mathematical content that is to be practised. Most people, when eating a pizza, would not know the radius of the pizza, and they would not consider how large a piece was – in degrees. This task does not draw upon the real-life situation that is presented, and the information given, although it is realistic, is rather artificial. There should be other ways to create a problem with a real-life connection on this topic.

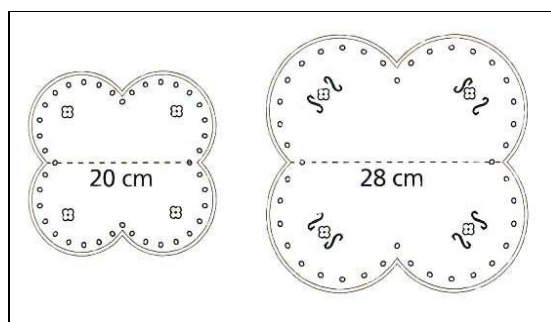

Illustration 5 The image of these table mats is from Oldervoll et al., 2000a, p. 143.

In the textbooks for the vocational courses we found many examples of similar problems where the contexts had been slightly changed in order to be relevant for different vocations. The geometry chapter in the textbook for hotel and nutrition (Oldervoll et al., 2000a) starts off with a subchapter on units of measurement, after some introductory comments on geometry as land surveying, and some historical comments about the Greek geometers and the Egyptian pyramids. In the following chapter, on geometrical figures with equal forms, they introduce some table mats that are supposedly found in a restaurant called ‘Ravenously hungry’ (literal translation from Norwegian). These mats are 20 centimetres wide, and their shape is shown in illustration 5. The band along the edge is 89 centimetres. Hannah is going to make 12 new table mats, but these mats are supposed to be 28 centimetres wide. The question now is how much band she needs for the edges of these 12 table mats. The exact same example was also given in the textbook for drawing, shape and colour, only in a slightly different context. In the textbook for the line of health and social issues, the example was presented with the exact same images, the exact same numbers, but now they were table mats in a kindergarten instead of a restaurant.

In another example, presented in the subchapter on scales, the restaurant ‘Ravenously hungry’ was going to make a new table with a somewhat peculiar shape. A woman called ‘Mette Munner’ (in English ‘Munner’ would be ‘Mouths’) made a drawing of the table to a scale of 1:40 (see illustration 6). The task now was to find the true size of the table. In the textbook for health and social issues, the same example was presented, but here the context was a kindergarten purchasing a new sandbox.

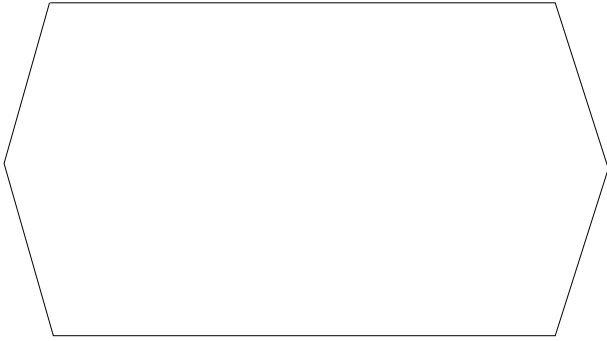

Illustration 6 This is a table or a sandbox

The scale was now 1:50 instead of 1:40, but otherwise the example was very much the same. In the textbook for drawing, shape and colour the example was still the same, only now it was a boy who was going to make a patchwork quilt. The same drawing and the same points were presented, but now the drawing had a scale of 1:4.

Pythagoras’ theorem is an important part of the geometry chapter, and we have already seen examples of problems that include Pythagoras’ theorem from other textbooks. The following

represents an example of how this could be used in real life. In the textbook for hotel and nutrition, they present an example where an old picture frame in a bar is examined. The picture frame has a rectangular shape, and the sides are 21.2 centimetres and 34.4 centimetres. The diagonal measures 41 centimetres.

The question now is if the frame is wry or crooked. Using Pythagoras’ theorem, we find that the diagonal should have been 40.4 instead of the measured 41 centimetres, and thus the frame is slightly crooked. In the textbook for drawing, shape and colour, the exact same example is presented, only now it is about Ann who is going to draw a rectangle without compass or ruler. After she has finished her drawing, she is going to find out if the rectangle is crooked or not. The measurements are the same, and the result is of course exactly the same, only this time the context was slightly different. This problem does represent a possible

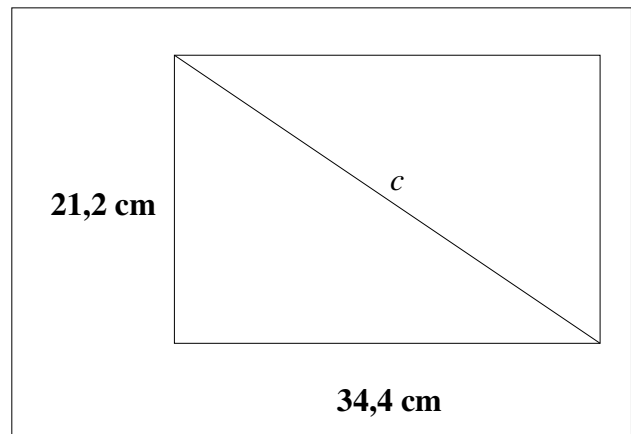

Illustration 7 Crooked frame

way of using Pythagoras’ theorem in real life, but the image does not look like a real picture frame. If the frame really looked like that, with straight edges, it would have been easier to use a right-angled ruler or some item with a right angle to see if the angles were 90 degrees. One could even have used a protractor on a frame like that. Measuring the sides of a real frame might not always be an easy task if the edges of the frame are not straight, and small measuring errors could easily influence the result. The measured numbers will always be approximations, so this is not an exact method anyway. Perhaps the pupils could have discussed other possible methods for deciding if the angles of a frame were right, and then try them out? Anyway, this is a rather typical textbook question where the mathematical methods one is supposed to practise are more important than the real-life context.

5.3.2.3 Comments

These are only some examples from the textbooks, but it was our impression that this approach of using the same examples in a slightly different context was an approach that textbook writers would often use. Such an approach probably has economic reasons, and it sure makes it easier for the textbook writers. The textbook writers make textbooks for several different vocational courses, and they have limited budgets. Our question is whether these small context changes really make all the difference. Often only a few words are different, changing a problem from a restaurant to a kindergarten problem. Is it really so that these artificial changes of contexts make it more understandable for the pupils? We do not intend to answer this question here and now, but we want to raise the question, to indicate that we are somewhat critical, and that we do believe this is an important aspect to bring into the discussion. If it were really so that it was enough to pose a problem in a slightly different wording in order to provide meaning and a sense of reality to different groups of pupils, this would be important to textbook writers and producers, and also to teachers. This would also imply that the main issue of importance would be to choose the proper context for a problem. That is a nice idea, and it would be a neat way of introducing a mathematical problem in different ways, or of presenting different applications of a mathematical theory, but would this really be to connect mathematics with real life? We argue that the way a problem is used (in the classroom context), i.e. the teaching method, is more important than the wordings.

Is it really so that artificial changes of contexts make it more understandable?

5.4 Comparison of the textbooks

Textbooks often follow a pattern of introducing first an example and then some tasks to practise the theory. This is the case for textbooks in several countries. One of the most significant changes from the mid-60s till the mid-90s was that examples and tasks became more strongly related to real-life (cf. Alseth et al., 2003, p. 45).

We have now analysed two different series of textbooks for lower secondary school and one textbook for upper secondary school. For the latter, we have focused on the main textbook, both the old and the new one, and we have analysed the textbooks for different courses in vocational education. These textbooks were used by the teachers we observed, and we will look more closely into how they used the textbook and other sources in chapters 8 and 9.

The two textbooks for lower secondary school have a different appearance. *Grunntall* is more traditional in some senses, with less use of colours, fewer realistic images and more drawings, more standardised tasks, etc. On the other hand, *Matematikk 9* is more progressive and modern, using more realistic images and pictures, more word problems and a more appealing layout. Our first impression was that *Matematikk 9* had more material connected with real life, and that *Grunntall* was a more traditional textbook in most senses. When looking more closely at the textbooks, we discovered that the two books actually included the same amount of tasks with real-life connections, at least in the geometry chapter, which we focused on. In both textbooks about 20% of tasks had real-life connections. We have looked more closely at some of the tasks, and we have seen examples where the real-life connections have been artificial in both textbooks. We have also seen some really good tasks in both books, but we do not wish to conclude whether one book is better than the other.

The evaluation study of L97 (Alseth et al., 2003) conducted a study of textbooks, to see how they implemented the ideas of L97. They explored how the use of everyday life experiences, practical situations and realistic problems had or had not been increased. It is interesting to note that even

though there has been an increased focus on mathematics in everyday life in our present curriculum, there is no particular change of context to support this in the mathematics textbooks. In the evaluation study, the researchers analysed several textbooks from M87 and L97 at three different levels, as we can see from the table below:

Grade:	Findings per book:
Grade 1, M87	1.2
Grade 2, L97	4.5
Grade 4, M87	4.0
Grade 5, L97	6.6
Grade 8, M87	7.2
Grade 9, L97	6.8

Table 3 Realistic problems in textbooks

The right column illustrates the number of findings within the category ‘Experiences from everyday life, practical situations, realistic problems’ in the geometry chapters of 4-6 books for each grade. We have added the number of findings together and divided by the number of books that were studied for each grade (cf. Alseth et al., 2003, pp. 52-53). The main conclusion was that they could not see any main tendency towards an increase in everyday life experiences in the L97 textbooks, in comparison with the M87-books (Alseth et al., 2003, p. 58).

Sinus is one of the main textbooks for Norwegian upper secondary school, and we have analysed several textbooks from that series. The old main textbook had far fewer tasks with real-life connections than the new ones, at least in the geometry chapter, which might have to do with a change of emphasis in the curriculum for the upper secondary school between 1994 and 2000. We have seen that the percentage of real-life connections in problems from the geometry chapter was quite high in the new textbook, whereas the trigonometry chapter only contained one problem with a real-life connection. The textbooks for the vocational courses included a high percentage (about 40%) of tasks with real-life connections in the geometry chapter. This percentage was higher than the textbooks for lower secondary school, and also than the main textbook, which had 27% of real-life connections in the geometry chapter. This might come as a surprise to us, considering our initial idea that they focused less on real-life connections in upper secondary school. We have now seen that this is not the case in the textbooks.

Many of the problems are ‘as-if-problems’.

In the textbooks for the vocational courses there were quite a large proportion of tasks with real-life connections, but we have seen that many of these tasks were quite similar with only a minor change in the wording between the books for the

different courses. These issues bring us into a discussion of whether a small and artificial change of context is enough to connect a problem with real-life, and whether these changes of contexts are enough to make a difference in meaning for different groups of pupils. Many of the problems are what we might call ‘as-if-problems’, i.e. where we are asked to find a solution to a problem, as if we really were going to solve it or perform a certain task. We believe that many, if not most, textbook problems could be categorised as such ‘as-if-problems’, and we have only seen a few tasks that involve suggestions of real actions or activities that include mathematical considerations. This artificial appearance of textbook problems is a matter that should be taken into account by teachers, as there might be a danger that an uncritical use of such problems might promote a feeling that school mathematics is removed from real life (cf. Sterner, 1999, p. 75).

We have seen how some textbooks address the connection of mathematics with real life. We know that many teachers rely a lot on the textbooks in their teaching (cf. Alseth et al., 2003, p. 146), and we should therefore pay attention to how the textbooks address the issue.

When the teachers present new content, they mostly do this with a rather vague connection to life outside of school. The aim of this teaching is generally that the pupils are to acquire certain skills, but these are seldom embedded in a need that the pupils have experienced. Systematisation and automation are important procedures in mathematics. For this kind of knowledge to become useful tools, it is important to connect certain technical connections between the different skills and these out of school skills and relations. It does not seem as if this has been appropriately carried out, in spite of L97's emphasis on this aspect. Working with the textbooks has only magnified this unfortunate trend. In them, the problems are likely to jump from one concrete situation to another, and it is obvious that the practical issues in these situations play a peripheral part. Using mathematical competence in real situations is still a considerable challenge for mathematical training (Alseth et al., 2003, p. 117).

There are reasons to believe that the textbooks can be problematic, in that they present the topics and problems in the way described above. Unfortunately, the production of textbooks in mathematics is not only dependent on the ideas and wishes of the textbook writers or the demands of the curriculum developers, but it is also to a large extent dependent on the decisions of the publishers who first and foremost want to sell a lot of books. In that way it is also an economic issue.

6 More on our research approach

The study described in this thesis is a case study. The case can be defined as the way teachers connect mathematics with everyday life, and the set of sources being studied have included: curriculum papers, textbooks, videos of teachers from different countries, observations of eight Norwegian teachers, interviews with the same teachers and a questionnaire survey of these eight teachers and their colleagues. Another possible interpretation could be to see the study as a case study of three teachers in lower secondary school, preceded by a pilot study of five teachers in upper secondary school, and supplemented by a study of videos from the TIMSS 1999 Video Study, investigation of Norwegian curriculum development and textbooks. According to our definition, the case is being understood as a ‘bounded system’ (cf. Creswell, 1998) – namely the issue of connecting mathematics with real or everyday life – which has been presented as a main aim in the Norwegian curriculum called L97. The second interpretation represents an understanding of the case as an individual (case), or for this study: multiple cases.

The study belongs mainly within a constructivist paradigm (or even social constructivist), as learning is being understood as an individual actively constructing knowledge (in an interaction with his or her social environment or context). One might also claim that the study belongs within a qualitative research paradigm, if the focus on understanding individuals and individual cases (and other aspects of qualitative research) can be regarded a research paradigm. Important aspects of a naturalistic paradigm includes considering multiple points of view of events, connecting theory verification and theory generation and studying cognitive activity in natural settings without intervention (Moschkovich & Brenner, 2000), and this coincides with main aspects of our study also (see chapter 6.1 below for further discussions about the research paradigm of this study).

The main focus of our research is the connection of school mathematics with everyday life, and how the teachers apply the curriculum intentions. A main aim of the study is to learn more about the beliefs and actions of experienced teachers. Many teachers have wonderful ideas that they implement in their classrooms, but all too often these ideas stay within the classrooms, and all too often the ideas a teacher has gathered and developed throughout his vocational life die with him. We believe it is important for the development of the teaching profession to take the experiences of practising teachers seriously, and to let their ideas become part of a common store of knowledge from which all teachers can benefit. This study attempts to contribute to such a store of knowledge by answering the research questions indicated in chapter 1.4.

Although our study can be understood as a case study of a bounded system (the connection of mathematics with everyday life) or a multiple case study, there are other aspects that need discussion. When discussing research paradigm, ethnography and case studies in the following chapters, we follow the first definition above and regard our study as a case study, and the case under scrutiny is how teachers connect mathematics with everyday life. The study includes investigation and analysis of multiple sources. The methodological considerations behind our textbook analysis and the analysis of videos from the TIMSS 1999 Video Study, are significantly different from the classroom studies of Norwegian teachers, but they are all part of the total picture.

6.1 Research paradigm

When it comes to research, and in this case educational research, there are several choices to be made. We have to decide what research methods and strategies to use, and where and how to use them in order to obtain the answers and results we are aiming at. It is important to decide whether

the research is going to be quantitative or qualitative, given of course that we already have an idea of what the object of the study is. Quantitative research can provide interesting descriptions of the situation in school, and quantitative data have traditionally been regarded as more viable, in that they can more easily be generalised (to the larger population). Quantitative research has strong connections with positivism, and it has been regarded the most scientific way of doing research within a positivist paradigm (Denzin & Lincoln, 1998). During the last few decades there has been a growing tendency towards qualitative research in mathematics education world wide. It is difficult to define qualitative research, as it is a complex field. An initial, generic definition could be given:

Qualitative research is multimethod in focus, involving an interpretive, naturalistic approach to its subject matter. This means that qualitative researchers study things in their natural settings, attempting to make sense of, or interpret, phenomena in terms of the meanings people bring to them. Qualitative research involves the studied use and collection of a variety of empirical materials – case study, personal experience, introspective, life story, interview, observational, historical, interactional, and visual texts – that describe routine and problematic moments and meanings in individuals’ lives (Denzin & Lincoln, 1998, p. 3).

Choosing a qualitative research approach is not a guarantee for success though, and it is far from the only choice to be made when it comes to methodology. There are several methods within the field of qualitative research, all of which have advantages and disadvantages.

As with all forms of research, qualitative research has its limitations. One of the questions most often asked is, ‘Will different observers get the same results?’ We all know that there is always more than one valid view in any social situation. People might agree on the facts of the situation but not on what they mean (Anderson & Arsenault, 1998, p. 133).

<p>QUALITATIVE RESEARCH</p> <p>“In social science, qualitative research is an umbrella term used to describe various non-quantitative research methods or approaches. For many, if not most researchers (especially in psychology), qualitative methods are simply exploratory methods used chiefly to generate hypotheses for quantitative testing. Other researchers, though, consider qualitative research a superior alternative to quantitative research.”</p> <p>http://en.wikipedia.org/wiki/Qualitative_research</p>

Qualitative studies are often studies of unique instances, and the issue of repeatability is problematic. For many qualitative studies (like this one), different observers would probably not get the same results, and the same researcher might not even get the same results if he approached the same teachers in a similar study at a later stage (because teachers change, and so does the classroom context). Results of qualitative studies cannot be judged in the same way as results from more large-scale quantitative studies, and the focus of these two kinds of studies are (normally) quite different. Unlike quantitative studies, which normally include a large set of data and informants, qualitative studies make use of multiple sources and triangulation to approach the data. The idea is that triangulation is an alternative to validation rather than a strategy of validation (see chapter 6.3 for further discussions about triangulation in

this study).

Researchers at the Freudenthal Institute have developed so-called ‘developmental research’. The aim is to make records to enable ‘traceability’, so that anyone can retrace the process. This is a central idea in qualitative research:

The internal validity of qualitative research (...) comes from keeping meticulous records of all sources of information used, using detailed transcripts, and taking field notes of all communications and reflective thinking activities during the research process (Anderson & Arsenault, 1998, p. 134).

Our research coincides with a naturalistic paradigm, in that the main aim is not to aspire to perfect objectivity, but rather to have a controlled and acknowledged subjectivity (Moschkovich & Brenner, 2000, p. 462). The study is also interpretive, in that it aims at learning the special views of the informants (in our case the teachers), the local meanings (cf. Stake, 1998).

6.1.1 Ethnography

Placing ones work within a certain paradigm or under a specific label is no easy task, and perhaps it is not even necessary in all cases. Taking the philosophy behind different methods and paradigms into account, getting to know the ideas and work of other people within the field is an appropriate and useful task.

The definition of ethnography has been subject to controversy. Some refer to ethnography as a philosophical paradigm, while others refer to it as a method to use as and when appropriate. A broad definition can be presented as follows:

We see the term [ethnography] as referring primarily to a particular method or set of methods. In its most characteristic form it involves the ethnographer participating, overtly or covertly, in people's daily lives for an extended period of time, watching what happens, listening to what is said, asking questions – in fact, collecting whatever data are available to throw light on the issues that are in focus of the research (Hammersley & Atkinson, 1995, p. 1).

Another way of defining ethnography is to see it in practical terms, saying that ethnography refers to forms of social research that have some of the following features:

- a strong emphasis on exploring the nature of particular social phenomena, rather than setting out to test hypotheses about them
- a tendency to work primarily with “unstructured” data, that is, data that have not been coded at the point of data collection in terms of a closed set of analytic categories
- investigation of a small number of cases, perhaps just one case, in detail
- analysis of data that involves explicit interpretation of the meanings and functions of human actions, the product of which mainly takes the form of verbal descriptions and explanations, with quantification and statistical analysis playing a subordinate role at most (Atkinson & Hammersley, 1998, pp. 110-111).

Following these rather broad definitions, our present study can be defined as an ethnographic study, or rather an ethnographic case study. We participated in the daily lives of a couple of classes in schools for an extended period of time. During these periods of time, we observed the teaching, listened to what was said, and asked questions in interviews, discussions and questionnaires.

Ethnography as a term might be understood in different ways, and one might distinguish between three kinds of ethnography:

- 1) *Integrative ethnography*: following the anthropological tradition, this constructs units of collective belonging for individuals.
- 2) *Narrative ethnography*: by contrast, this offers readers a first-person narrative of events for each different field.
- 3) *Combinative ethnography*: by working simultaneously in different fields, this brings together a casebook that can be used to identify the different forms of action in which people may engage, along with the possible combinations between them (Baszanger & Dodier, 2004, p. 10).

The rise of ethnography is due greatly to the controversy between quantitative and qualitative studies, or between what is called positivism and naturalism in philosophy. One of the main ideas of

naturalism, and also of ethnographic research is that the social world should be studied in its natural state, undisturbed by the researcher (Hammersley & Atkinson, 1995, p. 6). None of these labels are sufficient, however, to form an adequate framework.

All social research is founded on the human capacity for participant observation. We act in the social world and yet are able to reflect upon ourselves and our actions as objects in that world (Hammersley & Atkinson, 1995, p. 21).

There is often a discrepancy between the actions people profess and the actions that are observed. Triangulation, or the use of multiple sources of data, is a well known technique for establishing credibility in ethnographic studies (cf. Moschkovich & Brenner, 2000).

6.1.2 Case study

In general, case studies are the preferred strategy when “how” or “why” questions are being posed, when the investigator has little control over events, and when the focus is on a contemporary phenomenon within some real-life context (Yin, 1994, p. 1).

Such an explanation fits our study well, since our focus is on how teachers connect mathematics with everyday life, their reasons for doing so, and we study this phenomenon within a real-life context, being the teachers’ classrooms, which we have little control over.

Defining what a case study is might be even more difficult than defining ethnography. The use of the term in this study follows an explanation like this:

Whereas some consider ‘the case’ an object of study (Stake, 1995) and others consider it a methodology (e.g., Merriam, 1988), a case study is an exploration of a ‘bounded system’ or a case (or multiple cases) over time through detailed, in-depth data collection involving multiple sources of information rich in context (Creswell, 1998, p. 61).

A more technical definition was given by Yin (1994, p. 13):

- 1) A case study is an empirical inquiry that
 - investigates a contemporary phenomenon within its real-life context, especially when
 - the boundaries between phenomenon and context are not clearly evident(...)

- 2) The case study inquiry
 - copes with the technically distinctive situation in which there will be many more variables of interest than data points, and as one result
 - relies on multiple sources of evidence, with data needing to converge in a triangulation fashion, and as another result
 - benefits from the prior development of theoretical propositions to guide data collection and analysis.

A case study has a focus on individuals and local situations. The idea is that valuable things can be learned from the study of unique instances.

With even less interest in one particular case, researchers may study a number of cases jointly in order to inquire into the phenomenon, population, or general condition. (...) They are chosen because it is believed that understanding them will lead to better understanding, perhaps better theorizing, about a still larger collection of cases (Stake, 1994, p. 237).

The structure of case studies has often been described as:

- the problem
- the context
- the issues
- the “lessons learned”

Several issues distinguish our study as a case study:

- Identification of the ‘case’ for the study, the teacher and his beliefs and actions concerning the connections with mathematics and everyday life
- The cases are ‘bounded systems’, bounded by time (one month of data collection) and place (a teacher and his class)
- Use of extensive, multiple sources of information in data collection to provide the detailed in-depth picture of the teachers’ beliefs and actions.
- Considerable time spent on describing the context or setting for the case, situating the case within an environment (cf. Creswell, 1998, pp. 36-37).

Since our study also might be considered a study of multiple cases, a common design of multiple case studies have been chosen for the presentation of findings:

When multiple cases are chosen, a typical format is to first provide a detailed description of each case and themes within the case, called a within-case analysis, followed by a thematic analysis across the cases, called a cross-case analysis, as well as assertions or an interpretation of the meaning of the case (Creswell, 1998, p. 63).

Analysing a case study, much like ethnographic studies, consists of making a detailed description of the case(s) and its settings. We have also followed Stake’s (1995) suggestion of four additional stages of data analysis.

- Categorical aggregation
- Direct interpretation
- Establishing patterns
- Development of naturalistic generalisations

In the first of these stages, categories were distinguished and used in the further (direct) interpretation of the data. From these analytical steps patterns were established. These three steps were integral parts in the process leading to the development of generalisations and new theory.

Of course, the “case” also can be some event or entity that is less well defined than a single individual. Case studies have been done about decisions, about programs, about the implementation process, and about organizational change (Yin, 1994, p. 22).

According to this definition, it seems straightforward to call our study a case study, and we define the case as ‘the connection of mathematics with everyday life’. This refers to an intention of the curriculum (L97), and our study aims at investigating the intentions (of the curriculum), the interpretations (teachers’ beliefs) and the implementations (in textbooks as well as teaching practice) of this case.

All studies are unique, and in the following we will discuss the uniqueness of methods and methodology in this particular study.

6.2 The different parts of the study

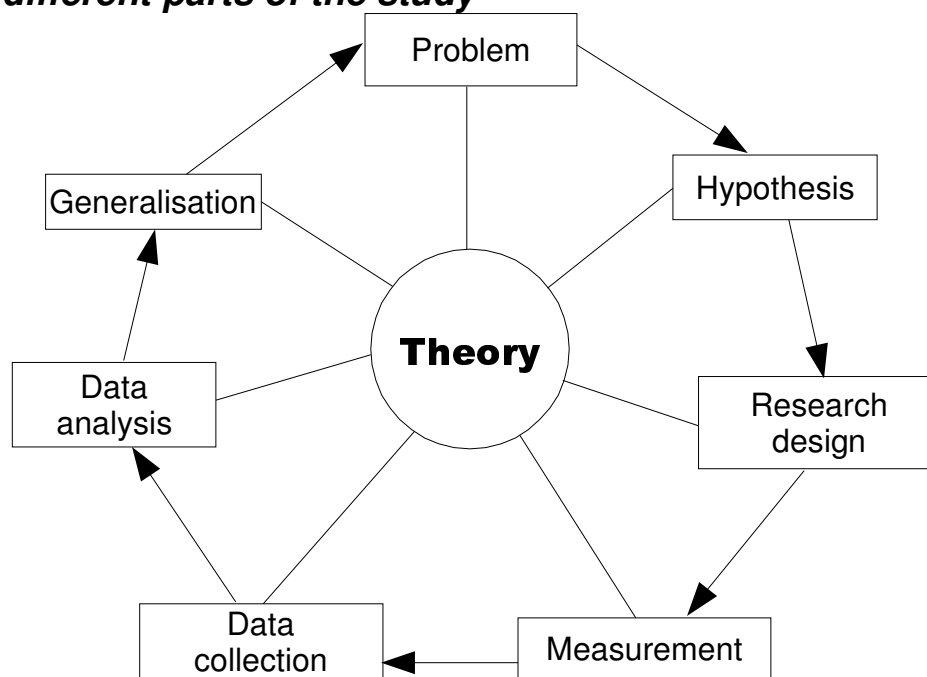

Illustration 8 The research cycle

This (case) study has included analysis of several sources of data, ranging from investigation of Norwegian curriculum development, textbooks, videos from the TIMSS 1999 Video Study, as well as study of some experienced teachers. The three main parts that we discuss in this chapter are: the classroom studies of Norwegian teachers, the study of videos from TIMSS 1999 Video Study and the textbook analysis. The Norwegian curriculum development has been regarded as part (or rather an extension) of the theoretical foundation for the study, and will therefore not be discussed here. The connection between the different parts of the field research and the theory is important, however, which can be illustrated in illustration 8.

6.2.1 Classroom studies

We had contact with several teachers and classes, and we used multiple methods of data collection. The study has a social context, which is important to know in order to understand the results. This context includes people and locations as well as the theoretical and organisational framework.

The classroom studies can be divided into two periods. The first period was a pilot study of five teachers in two upper secondary schools. In the pilot study, we visited classes in the first year of

upper secondary education. These pupils were 16-17 years of age. The second part was a study of three teachers in lower secondary education, with pupils aged 13-14.

When it comes to mathematics and the pupils' understanding and motivation for mathematics, there seems to be a critical point between primary and secondary education. This could also be called a crux. We wished to investigate how the teachers think and teach on both sides of this crux.

There are three phases in the process of classroom observation that according to Hopkins (2002) are essential. This three-phase model was adopted in our research project:

Step 1 Planning meeting. We had a meeting with the teachers, where we discussed the aims and details of the classroom observations.

Step 2 Classroom observations. Collecting data, which contained audio-recordings, various kinds of field-notes, collection of handouts, etc. The teachers answered a questionnaire and handed it in during this period. The results of these were not analysed before the classroom observations were finished, and then formed a basis for the interviews.

Step 3 Feedback discussions/Teacher interviews. Here we went deeper into the issues touched upon in the questionnaire, and we let the teachers elaborate more on their beliefs concerning these matters. We also asked them to share their ideas on how things could be done in different, and perhaps also better, ways.

This is of course a simplified overview. Before the planning meeting there were several meetings. First we had an introductory meeting with teachers and/or representatives from the potential schools. Then we had meetings with the teachers we had decided to collaborate with, in order to plan the scheduling of the study.

6.2.1.1 Planning meeting

Prior to the observation period we arranged a planning meeting with all the mathematics teachers at the school. At this meeting we introduced ourselves and gave a brief description of our research project, so that all the teachers should have an idea of what we were trying to investigate. We hoped that this would prepare them, and encourage them to start thinking about their own teaching, and make it easier to have fruitful discussions with them during the observation period.

There were three planning meetings altogether, one each for schools 1 and 2, and one meeting with representatives from schools 3 and 4. The planning meeting for school 1 was with Jane and another teacher, who we were also supposed to follow more closely. In this meeting a brief introduction to the study and the aims were given and discussed, and the more practical issues like the time for the observation period was planned.

The planning meeting for school 2 actually consisted of two meetings. First we had a more informal meeting with two representatives from the school, where the study was presented. Some time later there was a meeting with all the mathematics teachers from the school, as well as a couple of people in the administration, where the study, the plans and our aims were presented. The teachers were given the opportunity to pose questions and a folder were handed out to the teachers.

For the second phase of our classroom studies, we had one planning meeting for schools 3 and 4 combined. This meeting included representatives from both schools (the principals and one teacher from each school, namely Harry and Ann), and the organisation of the meeting was quite similar to that from school 2.

In the planning meetings there were several things to discuss. Hopkins (1993, p. 75) presents a list that was incorporated in our study (at least to a certain degree):

- The role of the observer in the classroom,
- The confidentiality of discussions,
- Date/time and place of observation,
- Date/time and place of review,
- Which classes and lessons are to be observed,
- Methods of observation to be used

In all planning meetings, folders were handed out to all the mathematics teachers, with a description of the research project and the aims and ideas behind it, a short description of the researcher, including his e-mail address and phone number. This was done in order to make it easier for the teachers to get in touch if they had any ideas, thoughts or questions. All these meetings took place a couple of weeks before the periods of observations started.

6.2.1.2 Questionnaire

One of the methods used in the classroom studies was letting the teachers answer a questionnaire. The questionnaire is an important part of traditional survey research, and it is often used in quantitative research. The most important part of a questionnaire is, of course, the questions, and there are several issues to consider in the formulation of these questions:

The questionnaire must translate the research objectives into specific questions; answers to such questions will provide the data for hypothesis testing. The question must also motivate the respondent to provide the information being sought. The major considerations involved in formulating questions are their content, structure, format, and sequence (Frankfort-Nachmias & Nachmias, 1996, p. 250).

We decided to let all the mathematics teachers at the four schools answer the questionnaire, which introduced a minor quantitative element into the study. Initially the idea was to hand out the questionnaire at the planning meetings, before the observation period. Some time before the planning meetings we decided to do this during the first weeks of the observation period instead. Doing so, the teachers were given a chance to get to know the researcher first. The intention was that this should improve the chances of having the teachers take this more seriously and actually put some focus on answering the questionnaire.

There are several possible question formats in questionnaires:

- Likert scales
- Comment on questions
- List questions
- Rank order questions
- Fill-in-the-blank
- Multiple choice

We decided to use *Likert scales* in combination with a few *comment-on questions* and some *list questions* in the questionnaire. The reason for using different types of questions was that they would

provoke different kinds of answers, and we wanted to get answers of a widest possible range. This questionnaire was regarded as a useful supplement to the other observations and to the interviews with the teachers. The research methods were closely connected in a process of triangulation, in order to obtain the most complete data material.

There are some possible pitfalls in the construction of questionnaires, and it is important for the questions to be worded so that the respondents understand it, as well as for the questions not to be leading (indicating that the researcher expects a certain answer) (Frankfort-Nachmias & Nachmias, 1996). In order to avoid leading questions or badly posed questions, the questionnaire was tested out and discussed with a couple of fellow doctoral students. The questionnaire was also discussed with some experienced scholars, including Dr. Otto B. Bekken. (The entire questionnaire is displayed in the appendix p. 279.)

6.2.1.3 Observations

Observations are important in educational research. The observations can be regarded as direct observations, as described in the following:

Less formally, direct observations might be made throughout a field visit, including those occasions during which other evidence, such as that from interviews, is being collected (Yin, 1994, p. 87).

The observations of the actual teaching in the classroom was reported in the field notes, whereas the other observations, that were not particularly related to the lessons, were recorded in the research diary. When observing teachers in the classroom, the researcher was as passive and non-visible as possible. This implied sitting at the back, or sometimes the side, of the classroom. The researcher made an effort not to interfere in the teaching, and he only talked to the pupils or teachers on rare occasions during the lessons. In the observation of the teachers outside the classroom, which was not really a major part of the study, the researcher had the role of a participant-observer more than a passive observer.

In our study some important questions concerning the observational aspects have to be posed (Hopkins, 1993, pp. 91-92):

- What is the purpose of the observation?
- What is the focus of the observation?
- What teacher/student behaviours are important to observe?
- What data-gathering methods will best serve the purpose?
- How will the data be used?

When observing classrooms, it is important to choose the data gathering method that best fits the purpose. There are numerous ways of collecting data, all of which have their advantages and disadvantages. Our main interest in the classroom observation was the teacher. We wanted to observe what he or she actually did when it came to our fields of interest. In order to obtain the proper data material to analyse, we chose to use audio tape recording in one of the weeks. In addition we used extensive field notes made by the observer throughout the entire period.

Three to four weeks were spent at each school for classroom observations. One of the last two weeks involved more extensive, in-depth observations. The lessons in this week were audio recorded with a mini-disk recorder in addition to the field notes. The other weeks the teachers were also observed. The researcher had discussions with the teachers and their colleagues between the

lessons and participated in the school environment. The reason for using audio recordings for one week only was mainly to avoid being totally drowned in data (which would make the process of analysis harder).

Audio tape recording is a popular research method in educational research, but as with all methods, it has its advantages and disadvantages, as Hopkins, 1993, p. 106 points out:

Advantages	Disadvantages
<ul style="list-style-type: none"> • Very successfully monitors all conversations within range of the recorder • Provides ample material with great ease • Versatility - can be transported or left with a group • Records personality developments • Can trace development of a group's activities • Can support classroom assessment 	<ul style="list-style-type: none"> • Nothing visual - does not record silent activities • Transcription largely prohibitive because of expense and time involved • Masses of material may provide little relevant information • Can disturb pupils because of its novelty; can be inhibiting • Continuity can be disturbed by the practical problems of operating

Table 4 Audio recordings

One might ask why we did not use videos in our study instead of audio recordings. This is a relevant question, and there are many benefits of using videos that you do not get when just recording the sound. Capturing classroom interaction with video clearly provides the researcher with new and interesting possibilities:

The possibility of capturing aspects of the audible and visual elements of *in situ* human conduct as it arises within its natural habitats provides researchers with unprecedented access to social actions and activities (Heath, 2004, p. 279).

Although adding a visual element to the data of the classroom observations might have been beneficial, we decided not to use videos to capture the teachers' actions. Videos would have given our study a new dimension, but we believed that the benefits would not be enough to justify all the difficulties and complications that the use of videos would include. Placing a video camera in the classroom would be more disturbing for the teachers as well as for the pupils, and a passive observer with a hidden mini-disk recorder would have a less disturbing influence on the teaching and learning processes. Using a video camera would imply more work, when it comes to getting permissions from all the parents, the possibility of having to rearrange the classroom because some of the pupils were not allowed to be captured on video tape, etc. On the other hand the resulting data material would, no doubt, have been easier to analyse, simply because it includes the visual element. When using audio recordings only, there is always a risk of missing some information. Issues that cannot be captured on audio tape, and that have not been written down in the field notes, will get lost. There is also the possibility of the observer not being able to 'see' everything that happens in a classroom, and some of these issues could have been discovered in the analysis of videos. Since, however, this study only had one researcher in the classrooms to do the observations, making video recordings could imply that the researcher spent so much time and energy on the technical issues that he missed some things that he would have observed if not using videos. After all considerations

of the advantages and disadvantages of the different possibilities for recording video and/or audio, there was made a decision to use audio recordings only. The audio recordings in addition to extensive field-notes would, we believed, be sufficient to this study.

As we were not interested in analysing the communicational interaction between teacher and pupils in its entirety we could allow ourselves to limit the transcriptions. We wanted to use the transcriptions as a tool in the process of recalling and analysing the activities of the teachers. Through the field notes, the interviews and the audio recordings we aimed to make a fairly accurate description of what the teachers really did in relation to our research questions.

We also wanted to use some of the situations from the classrooms as examples of how it is possible to connect mathematics with everyday life in a practical application of the curriculum ideas. Practical examples can never be anything else than examples of a theory. In our study we wished to put the theories in concrete terms, and we hoped that this could be useful for practising teachers. Therefore our aim was also to collect ideas and good teaching strategies when observing the classrooms.

We were most interested in how the teacher tried to create links between the school mathematics and everyday life and how they managed to stimulate pupil activity. There are several ways of doing this, and we have tried to predict some possible strategies:

- Use the pupils' own experiences to form tasks and problems
- Let the pupils take an active part in the process of formulating problems
- Use open questions and project based teaching
- Use problems which encourage the pupils to explore mathematically
- Use other problems than the ones from the textbook
- Challenge the pupils to consider the relevance of their answers

We did not want to interfere much in the teachers' planning of the classes or in the teaching per se.

We did not want to interfere much in the teaching.

A possibility would of course be to design certain activities for the teacher to try out in class, which would have made it an exploratory research project. Doing this would have shown how these activities worked out in this particular class, but the

circumstances of such activities would easily become rather artificial. There might have been a danger of the teacher feeling a bit oppressed. One of the main ideas of our study was to collect strategies and ideas from successful and innovative teachers. Many teachers do brilliant things in their classrooms. By observing some of these classrooms for a fairly long period of time, letting the teacher play the active part, we hoped to discover some of these ideas and strategies. The intention was for the teachers to feel important, and for them to be the actual providers of material for the research. We did not want it to be the case of a more knowledgeable researcher coming from outside to show them how to do their jobs better.

The teachers were the key informants, and the researcher's interaction with the pupils was minimal. It was the teachers' views, opinions and beliefs, as well as their actions and teaching strategies that were in focus.

By taking the part of the passive observer in the classroom, it was the intention that the teachers would relax and excel in their teaching. The observations were meant to provide a basis for fruitful discussions and interviews in order to gather the most information possible about the teachers' ideas and practice theories.

6.2.1.4 Interviews

Interviews are one of the most (if not the most) common research methods in general, and for case studies in particular, and they can provide a rich source of information. Unfortunately there are also some dangers and pitfalls connected to interviews. Interviews being such a common activity is one of the possible disadvantages. There is always a danger of them becoming ordinary conversations without any desirable results. Only few people really do them well. It is also important to realise that interviews are not neutral tools for collecting data, but active interactions between two people, or more (Fontana & Frey, 2000, p. 646). From a communicational point of view there is a possibility that the interviewee does not give his actual opinions and ideas, but rather gives what he believes that he is expected to answer. We will not go into this or similar discussions here, as this is not the main focus of our research, but rather point out some of the advantages of interviews. These are also some of the reasons why we have chosen to use them in our research:

People are more easily engaged in an interview than in completing a questionnaire. Thus, there are fewer problems with people failing to respond. Second, the interviewer can clarify questions and probe the answers of the respondent, providing more complete information than would be available in written form (Anderson & Arsenault, 1998, p. 190).

Especially the second point was of importance to us. We wanted to use interviews as a complementary source of information to the questionnaire. By doing this in addition to classroom observations we hoped to get a more complete picture of what the teachers do and believe when it comes to the teaching of mathematics with real-life connections. We hoped that the interviews could help clarifying the thoughts and ideas of the teachers.

There are different kinds of interviews and interviewing techniques, but we believed that the so-called 'key informant interview' was best suited for our purpose:

The researcher is not interested in a statistical analysis of a large number of responses, but wants to probe the views of a small number of elite individuals. A key informant interview is one directed at a respondent who has a particular experience or knowledge about the subject being discussed (Anderson & Arsenault, 1998, p. 191).

This was our idea also, and it fits the superordinate ideas of qualitative research. The role of the teacher as a key informant and not just a test-bunny is important.

Our interviews had an open-ended nature, which is common for case studies:

Most commonly, case study interviews are of an open-ended nature, in which you can ask respondents for the facts of a matter as well as for the respondents' opinions about events. In some situations, you may even ask the respondent to propose his or her own insights into certain occurrences and may use such propositions as the basis for further inquiry (Yin, 1994, p. 84).

The teachers in our study were actively involved in the latter manner, and this is a reason why they can rightfully be called key informants rather than mere respondents. Although having an open-ended nature, the interviews in our study could best be described as focused interviews (cf. Yin, 1994). They often assumed a conversational manner, but they were still following a certain set of questions that had been prepared in advance. This set of questions had been written down and discussed with a group of fellow doctoral students and a professor of mathematics education at Agder University College (HiA) before the interviews took place. This was done in order to ensure that the questions were given the best possible wording, to discuss how the questions could be posed in order to prevent that they became leading questions, etc.

Open-ended interviews, although being common in case studies, have been criticised and discussed:

On the other hand, emotionalists suggest that unstructured, open-ended interviewing can and does elicit “authentic accounts of subjective experience.” While, as Silverman points out, this approach is “seductive,” a significant problem lies in the question of whether these “authentic records” are actually, instead, the repetition of familiar cultural tales. Finally, radical social constructionists suggest that no knowledge about a reality that is “out there” in the social world can be obtained from the interview, because the interview is obviously and exclusively an interaction between the interviewer and the interview subject in which both participants create and construct narrative versions of the social world (Miller & Glassner, 2004, p. 125).

The problem, as referring to the continuation of the above quoted discussion, is that the “truths” that appear in interviews are context specific and invented. These are important issues to have in mind when conducting interviews in qualitative research, and these are some of the reasons why case studies normally include a triangulation of multiple sources (see chapter 6.3).

6.2.1.5 Practical considerations and experiences

What is planned and what is actually carried out are not always the same, and this turned out to be true for our study also. A pilot study was not initially planned since the methods that were going to be used were quite familiar from smaller studies that had been conducted by the researcher in the past. It was therefore assumed that a pilot study was not needed. However, in the first phase of the study, practical and technical problems occurred. Because of issues related to school administration and the time of year (just before Christmas finals) the study in school 2 was limited to three weeks only. It also turned out that all classes at the same level had similar lessons at the same hours in this school, and it was therefore difficult to visit as many mathematics lessons as we had wished.

The equipment for the audio-recordings broke down during our visit at the first school, and it remained unusable for most of our visit to the second school also. An important part of our intended data material was thus lost. Everything was carried out as planned though, except that there were fewer audio recordings from the lessons. Because of all these issues, the first phase, where teachers in two upper secondary schools were studied, was therefore more and more considered to be a pilot where all the equipment and methods were tested out. The results of this pilot phase were taken into account in the main study nevertheless, because these kinds of experiences are also important to document in a research project, and the data material will be analysed as if it were merely part 1 of a larger study. The two parts of our study were never meant to be equal in all senses of the word after all, but when it has ended up being referred to as a pilot study, this was really not the intention.

The aim of our project was to study teachers’ beliefs and actions, and to see how the teachers dealt with the curriculum intentions concerning mathematics in everyday life. It was therefore natural to focus on the teachers in schools 3 and 4 the most, since the teachers in upper secondary school (schools 1 and 2 were upper secondary schools) follow a different curriculum than years 1-10. Schools 1 and 2 were selected to investigate the teachers’ beliefs and actions concerning the same issues among teachers at the upper secondary level (teachers who followed a somewhat different curriculum).

The analysis of some of the data material from the TIMSS 1999 Video Study has been included to give our case study an international perspective. Studying teachers from other countries gives us ideas and insights that might help us discover new aspects of the teaching in our own culture. This was one of the main ideas behind the TIMSS Video Study, and it is an idea we share completely. It was our intention that a study of the teaching at upper secondary level would help us discover new and important things about the teaching of mathematics in grades 8-10. Altogether the ‘pilot’ (the study of schools 1 and 2), the main study (schools 3 and 4) and the lessons from the TIMSS 1999

Video Study were meant to provide a more complete description of how teachers actually connect school mathematics with everyday life, real life, daily life or what we would like to call it. In the study of Norwegian teachers we have also investigated how the teachers' beliefs resulted in teachers' actions and whether or not they coincided.

6.2.2 The TIMSS 1999 Video Study

The main part of this study has a focus on Norwegian teachers. In order to get an international perspective of the issues discussed, a study of videos from the TIMSS 1999 Video Study was included. This particular study was done while the author was in residence at Lesson Lab in Santa Monica, CA, as member of the TIMSS 1999 Video Study of Mathematics in seven countries.

This part of the study differs greatly from the case studies of Norwegian teachers, in that we only studied videos of teachers from different countries, rather than following particular teachers in their classrooms. We did not have any direct contact with the teachers in this part of the study, and we therefore did not have the opportunity to interview any of the teachers or let them answer the questionnaire. More than 600 lessons in seven countries were videotaped in the TIMSS 1999 Video Study (see chapter 3.1 for more details), and none of the teachers were videotaped twice. Our sample of videos therefore contains one video of each teacher, which makes it different from the case studies of Norwegian teachers, where we followed each teacher for about a month.

Our analysis of data from the TIMSS 1999 Video Study is meant to provide an international perspective to this thesis, and the analysis of videos are backed up by findings from the more general report from this study (cf. Hiebert et al., 2003).

When we refer to and analyse the data from the TIMSS 1999 Video Study, we use the term 'real-life connections' rather than 'everyday life connections' or 'the connection of mathematics with everyday life', as we often do in the rest of the thesis. The reason is that this was the term that was used by the coding team in the TIMSS 1999 Video Study.

6.2.3 Textbook analysis

Our analysis of textbooks is not to be seen as a complete analysis of these books, but rather an analysis of how they deal with the issue of mathematics in everyday life, or the connections with mathematics and real or everyday life. It is therefore not an analysis of textbooks as such, but an analysis of some textbook tasks presented in the books. We focused only on the books that were used by the teachers in the study of three teachers and the pilot study, and we analysed tasks from the topics that were taught while we were observing the particular teachers.

The aim of this analysis of textbooks was to investigate how the curriculum intentions were implied in the textbooks. The textbook is one of the main resources for Norwegian teachers of mathematics, and indications are that textbooks influence the teaching to an even stronger degree than the curriculum (cf. Alseth et al., 2003).

When discussing textbook tasks, it is important to notice our definitions concerning the terms. Exercises presented in textbooks are generally called 'tasks', without any judgement of them being problems or routine tasks. When such a distinction is used, we might even distinguish between problems and tasks, implying that 'task' in this connection is a routine task. We follow Kantowski's definitions of problem and routine tasks:

A task is said to be a problem if its solution requires that an individual combines previously known data in a way that is new to him. If he can immediately recognise the means that are needed to complete the task, it is a standard or routine task for him (Kantowski, 1980, p. 195).

Sometimes we also use the phrase ‘exercise’, which is also used by L97, and we use this term in a broader sense than ‘task’. When using the term ‘exercise’, we are not only referring to tasks that appear in textbooks, and we do not make any distinctions as to whether the exercise involves a problem or a routine task.

6.3 Triangulation

In qualitative as well as in quantitative research, the results and findings are affected by the nature of the methods with which the data were collected. If the findings are strongly affected by the methods used, they could be called *artefacts*, or products of the data analysis method.

To minimize the degree of specificity of certain methods to particular bodies of knowledge, a researcher can use two or more methods of data collection to test hypotheses and measure variables; this is the essence of triangulation (Frankfort-Nachmias & Nachmias, 1996, p. 206).

There are various procedures when it comes to reducing the likelihood of misinterpretations in qualitative studies. As indicated by Frankfort-Nachmias & Nachmias (1996) above, triangulation is considered a way of using multiple sources to clarify meaning and to verify repeatability. It is, however, acknowledged that no observations or interpretations are perfectly repeatable, and triangulation thereby serves to clarify meaning by identifying different ways the phenomenon is being seen (Stake, 1994; Stake, 1998).

Triangulation might refer to three different types: (1) using multiple sources, (2) from multiple methods, (3) with more than one researcher involved (cf. Denzin, 1978; Hativa, 1998). Our study makes use of the first two types, as it contains different kinds of sources from different kinds of methods. The sources that were subject to triangulation were mainly transcripts, field notes and questionnaire results.

The possible benefits of using multiple sources are many:

The use of multiple sources of evidence in case studies allows an investigator to address a broader range of historical, attitudinal, and behavioral issues. However, the most important advantage presented by using multiple sources of evidence is the development of *converging lines of inquiry* (...) Thus any finding or conclusion in a case study is likely to be much more convincing and accurate if it is based on several different sources of information, following a corroboratory mode (Yin, 1994, p. 92).

The aim is thus for the multiple sources of evidence to contribute to the results in a convergent manner (like illustration 9 below), although it is also possible for these sources of evidence to result in non-convergent results.

Different kinds of transcripts were analysed in the study. From the classroom studies, transcripts of interviews and observations were generated. Both types of transcripts were created from audio recordings done with a mini-disk recorder. The transcription was performed by the researcher, and the recordings were transcribed word by word, without any comments or indications as to what happened except for the words spoken. The transcripts were analysed together with the field notes, which also contained comments about issues that could not be distinguished from an audio tape (like descriptions of what the teacher did).

In the study of videos from TIMSS 1999 Video Study, transcripts from the selected lessons were analysed. The videos were transcribed by other members of the TIMSS 1999 Video Study.

In the study of Norwegian teachers, field notes were taken by the researcher in all lessons that were observed. These field notes contain references to what happened, what the teacher did and said (as much as was possible to write down), and also references to problems and tasks, as well as more personal comments by the researcher. In addition to these field notes, a research diary was kept, with comments and observations that were gathered from situations that were not recorded in the classroom observations or the interviews.

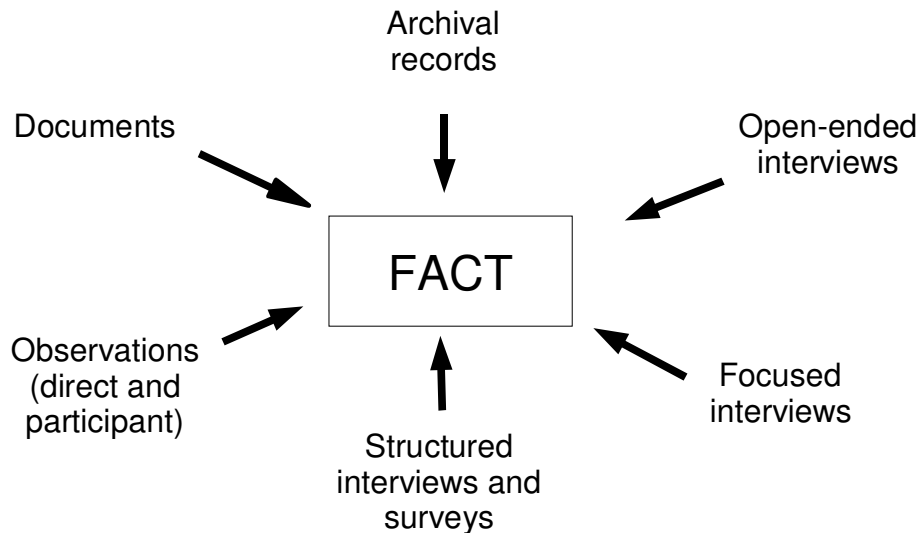

Illustration 9 Convergence of multiple sources of evidence (cf. Yin, 1994, p. 93).

The third main data source in our study was the questionnaire results. The questionnaire was handed out to the eight teachers in our study (five in the pilot and three in the main study) as well as to the other mathematics teachers in their schools. A total of twenty teachers replied to the questionnaire.

Another important source for this study was the Norwegian curriculum (L97), but the chapter on curriculum development in Norway has been regarded as part (or extension) of the theoretical foundations for the thesis.

When it comes to triangulation of methods, we can distinguish between observations, interviews, questionnaires, video study and textbook analysis in this study.

6.4 Selection of informants

Informants are regarded as the main providers of source/data material, and there were different kinds of informants in our study. The main informants were the teachers (in the pilot study and the study of three teachers), but we might also regard videos from the TIMSS 1999 Video Study and the textbooks analysed in connection with the study of Norwegian teachers as informants.

6.4.1 Teachers

We chose four different schools and eight teachers from these schools for our multiple case-study. Our aim was not to be able to generalise our findings to the whole population of Norwegian teachers. We believed instead that observing some experienced teachers would give us some important and interesting answers to our questions. A study including observations and asking

questions in interviews and questionnaires could also provide some new thoughts and insights. The ideas of connecting mathematics and everyday life, as stated above, are present in our national curriculum for years 1-10, and they are also present in the curriculum for upper secondary education. Building on this observation we thought it might be interesting to choose two lower secondary schools (years 8-10) and two upper secondary schools. The schools and teachers were picked out in a process of collaboration between the researcher, the supervisors and the school administration. Some teachers at two different upper secondary schools were suggested by Dr. Otto B. Bekken, whom he knew to be experienced and skilled teachers of mathematics. Dr. Gard Brekke picked out two other interesting schools (lower secondary level). In collaboration with the principals of these schools, and with the teachers themselves, we selected three teachers from these lower secondary schools.

School 1, as we have chosen to call it, was a vocational upper secondary school. There were only four mathematics teachers at this school. We started off by getting in touch with two teachers at this school, but for practical reasons that emerged later, we chose to focus on one of these, a female teacher called Jane.

School 2 was a more theoretically based upper secondary school, with nine mathematics teachers. We contacted two teachers at this school. One of them turned out to have little teaching time this year, and we therefore ended up with only one of these (Thomas). Thomas worked in collaboration with another teacher in a double-sized class, and we also included this teacher in our study (Ingrid). In addition, we found two more experienced teachers to study in cooperation with the school administration (George and Owen). Together they provided an interesting and diverse group of mathematics teachers at this level.

Schools 3 and 4 were both lower secondary schools, teaching pupils in grades 8-10. We initially made contact and arrangements with one teacher at each school. At school 3 we ended up with two teachers to study (Karin and Ann), based on suggestions from the school administration and the teachers themselves. At school 4 we chose to study one teacher only (Harry).

We visited the first two schools in the last part of the autumn term of 2002. Schools 3 and 4 were visited in the spring term of 2003. Although we planned to make both phases of our study equal, the first ended up being a kind of pilot, in the sense that we had to make some adjustments based on experiences from that phase. In spite of this, the findings from these two phases have been treated equally, but the data material from schools 3 and 4 was more extensive, due to the changes that were made.

6.4.2 Videos

In the preparation for this part, we used the coding from the Video Study to identify the videos with real-life connections. In the TIMSS 1999 Video Study, the teachers from the Netherlands had most real-life connections, whereas the teachers in Japan and Hong Kong made the least such connections. Because these three countries were extreme cases in the TIMSS 1999 Video Study, we decided to focus on the videos from these three countries. In the process of selecting videos, we looked through most of the videos that were marked as having real-life connections in these countries, and we chose the most interesting ones for further analysis. More than 30 videos from the database at Lesson Lab were studied more closely, and about 20 of these were found to be interesting enough to collect transcripts from. Finally, nine videos were chosen for further analysis, and these are the videos referred to in this thesis. A video was considered 'interesting' if the situations that had been marked as real-life connections by the coding team were considerable, meaning that they were more than single comments referring to some real-life connected issues. Some of the videos contained examples of real-life connections that were rather similar. We decided

to chose videos with different kinds of examples so that the nine videos we ended up with would have a wide spectrum of real-life connections, and we wanted these examples to be interesting rather than mere superficial comments.

A qualitative study of all the videos is of course an impossible task for a small research project like this. We have therefore selected a small sample of lessons to focus on in this chapter. Our choice of videos was not based on random sample, and we will not argue that they give a ‘general’ description of the teaching in the respective countries. An important question that we wished to answer was: How do the teachers actually connect their mathematics teaching with real life? The data in our study were meant to be qualitative examples of this.

After having studied this selection of videos from Japan, Hong Kong and the Netherlands, we also studied the public release videos from these three countries, four videos from each country. These videos were meant to serve as a reference group, and the study of them was mainly included for comparative reasons. We also studied the comments from the national research administrators, the researchers and the teachers on the public release videos, to ensure that our analysis not only ended up being subjective opinions. This was done to obtain indications of whether the issues that had come up in our selection of videos were merely special cases, or whether they were also valid for other classrooms in the respective countries.

6.4.3 Textbooks

The informants in our study were not selected randomly, and instead of selecting all, or a random sample of, Norwegian textbooks in mathematics, we decided to focus on the textbooks that were used by the teachers in our study. We also decided to focus our analysis on the chapters being taught in the period that the classroom observations were conducted.

Harry used a textbook called *Matematikk 9*, and we studied both the main textbook and the exercise book. Karin and Ann used a textbook called *Grunntall*, and we studied the books for 8th and 9th grade, which were the particular books used by Karin and Ann. We also studied several books from the *Sinus* series, which is one of the main textbooks for upper secondary school in Norway. (See chapter 5.1 for more about the textbooks.)

6.5 Analysis of data

Being a case study, the analysis of results from our study was aiming to generalise to theory rather than to a population (cf. Yin, 1994). The aim was not for the results to tell anything about what is the case for all teachers, or all Norwegian teachers, but rather to generate new theory from these results. An important aspect in this respect was to ensure a proper analysis of the diverse body of data collected in the study.

The data material contained extensive field notes, transcripts of interviews and classroom observations, and questionnaires. In addition we had the notes and data from the research biography, which gave a complementary picture of the research process. These different kinds of data could not be treated in the same way, and the analysis therefore had to be different.

When analysing the data material, we distinguished between the questionnaire, the lessons and the interviews. The questionnaire was analysed mostly based on the results of the Likert scale questions. The comment-on and list questions were mainly commented on in connection with other data sources. The questionnaire was analysed, and will be presented, using more quantitative-like

methods. The questions from the questionnaire provided a basis for the formation of subcategories for the analysis of the lessons.

6.5.1 Classroom study

The sources from the classroom studies were questionnaires, classroom observations and interviews, and the analysis of them will be presented in this order. When it comes to the analysis of classroom observations, we distinguish between the pilot and the study of the three teachers, since the data from these two phases were analysed in different ways.

6.5.1.1 Questionnaire

In each school, the questionnaires were handed out to the mathematics teachers in the second or third week of the observation period. They were collected during the final week of classroom observations. This was done because we did not want the observations to be affected by the knowledge of what the teacher(s) had answered in the questionnaire. Such a knowledge could possibly influence the observations, in that the researcher could be looking for particular issues according to the questionnaire results. Only at the very end of the observation period, just before the interviews, were the questionnaires analysed. The replies from the questionnaire would then contribute as a basis for the interview questions. The questionnaire results were then subject to more detailed analysis a while after the data collection period.

In the beginning of the analysis, the answers were written down in separate files for each school. Then the results from all four schools were gathered in one file. The answers to the Likert scale questions were counted and presented in charts. The answers to the comment questions and the list questions were studied and categorised. The resulting list of categories were eventually used as a basis for the analysis of data from the classroom observations and the interviews.

6.5.1.2 Observations – first phase of analysis

The analysis of the classroom observations actually happened in two phases. After being given the opportunity to revise the thesis, the data material was given a new analysis. In order to give the most correct presentation of the study, we present how both phases of analysis were organised. Initially the data were analysed using an adjusted coding scheme from the TIMSS 1999 Video Study, that we have presented in the following table (see table 5, p. 69):

<p>Level 1:</p> <ul style="list-style-type: none"> - RLC (Real life connections in problem situations) - RLNP (Real life connections in non-problem situations) 	<p>Level 3:</p> <ul style="list-style-type: none"> - GW (Group work) - IW (Individual work) - TAWC (Teacher addresses whole class) - P (Projects) - R/GR (Reinvention/guided reinvention) - OA (Other activities)
<p>Level 2:</p> <ul style="list-style-type: none"> - TT (Textbook tasks) - OT (Open tasks) - TELX (Teacher's everyday life examples) - PI (Pupils' initiatives) - OS (Other sources, like books, games, science fiction, etc.) 	

Table 5 Levels of analysis

Level 1 distinguishes between the connections made to real life in problems and non-problem situations. Level 2 distinguishes between the different kinds of problems and tasks worked on, i.e. more on the content level, and gives us ideas on what sources the teachers use. The last level tells us more about the organisation of the class and ways of teaching. The different levels of coding points, at least levels 2 and 3, display different aspects that the teacher has to take into account when planning a lesson. Coding points from all three levels were often used to describe the same situation. All of the situations we focus on are either RLC or RLNP, but almost all teaching situations of course include elements from the level 2 and level 3 categories. These are not necessarily real life connections though, and we will not focus on them. The three levels from this scheme are also used to organise and distinguish the findings, in relation to both beliefs and actions.

The coding scheme presented above consists of several categories, which need to be defined and commented on. Some of them might seem straightforward and the meaning of them apparent, but we have chosen to elaborate to some extent on this anyway, to avoid misunderstandings.

Real life connections (in problems)

This category is directly borrowed from the TIMSS 1999 Video Study, and it is used as a general description of the situation analysed. We use the same definition as was done in the Video Study (TIMSS-R Video Math Coding Manual):

Code whether the problem is connected to a situation in real life. Real life situations are those that students might encounter outside of the mathematics classroom. These might be actual situations that students could experience or imagine experiencing in their daily life, or game situations in which students might have participated.

As we see, this is a rather vague and open-ended definition, containing all kinds of situations the pupils might encounter outside of the mathematics classroom. This definition is in our analysis tightly connected to the categories in level 2 and 3, which give a further explanation of the meaning of this concept.

It might seem as if we believe that real life is only what is going on outside of school, but this is not the case. As one of the teachers in our study said, the school day is certainly an important part of the pupils' everyday life, and this statement contains an important element of the discussion. In this

context however, we define real life (and also everyday life, daily life, etc.) as situations that pupils could experience or imagine experiencing in their daily life, outside of the mathematics classroom. This is also in line with what the Norwegian curriculum says about the need to create close links between school mathematics and mathematics in the outside world (RMERC, 1999, p. 165).

Real life connections – non-problems

This is the second of the two main coding categories, concerning real life connections in the TIMSS 1999 Video Study, and it describes situations or connections that appear outside problem situations (TIMSS-R Video Math Coding Manual):

The teacher and/or the students explicitly connect or apply mathematical content to real life/the real world/experiences beyond the classroom. For example, connecting the content to books, games, science fiction, etc. This code can occur only during Non-Problem (NP) segments.

Here also the connections are to real life or real world experiences that appear or might appear beyond the classroom, but this time they only appear in non-problem segments of the lesson.

These first categories both belong in level 1. The following categories belong to levels 2 and 3, and they concern sources and methods the teacher might use.

Textbook tasks

This category is used to describe situations where the pupils work with problems and routine tasks from a textbook, or where the teacher refers to such problems. How this working session or sequence is carried out and how the class is organised will be further explained in the level 3 categories. This category will normally be limited to the RLC code, since a situation where a class works with textbook tasks in a non-problem situation is more or less to be regarded a contradiction of terms.

Open tasks

When the pupils work with open tasks, the solution method is normally not defined. Open tasks can be used with real-life connections, and these situations are limited to the RLC coding. Such a task or problem might involve several equally correct answers. These would normally be non-textbook tasks, but that would not necessarily be the rule.

Teachers' everyday life examples

This category includes situations where the teacher gives examples from his or her everyday life, i.e. the examples are not taken from a textbook. It might, however, include situations or items collected by the teacher or from the teacher's daily life experiences. This category could include both problem- and non-problem situations.

Pupils' initiative

In some situations the pupils formulate questions, and they come with comments or ideas from their daily life experiences that are used by the teacher in class. These situations are often of an 'accidental' kind. They are not always easy to plan, but they might result in successful teaching sequences. They might be RLC or RLNP.

Other sources

These include situations where the teachers use other sources in the mathematics classroom, for problem or non-problem situations. This can occur when the teacher uses situations from the media, etc. Most often these would be real life connections from the teacher's real world, but they might also come from a pupil initiative. Normally this category will be an additional category to the two above.

Group work

The level three categories are all about the organisation of the class, and group work is a popular way of organising the pupils. Begg (1984) suggests that a group approach is the real-life approach to problem solving situations (cf. Begg, 1984, p. 41). Some teachers use cooperative groups in a more structured manner, and in some cases the group work could be more of an unstructured way of working among the pupils. This will be commented on in the analysis where this category is used.

Individual work

A more traditional way of working in mathematics classrooms is individual work with solving problems. The most probable appearance of this category could therefore be RLC, TT, IW.

Teacher addresses the whole class

Quite often the teacher would stand by the blackboard, or somewhere else in the classroom, and talk to the whole class. There might be a discussion with the class, a question-answer sequence or more of a lecture. This may also occur in the review of problems, as we could observe in many of the Dutch lessons from the TIMSS 1999 Video Study, where an often occurring coding might be RLC, TT, TAWC.

Projects

Several books and papers have been written about using projects in teaching, and this is also an issue emphasised by our present national curriculum L97. Although 'project' is normally regarded as a distinguished didactic method, containing a specific list of activities, we will use this category in a more open way, including all kinds of large or small projects. Projects are not the same as group-work, and this is an important distinction that is also displayed in L97.

Reinvention/Guided reinvention

This is a phrase much used by the Freudenthal Institute, and it has a specific meaning within the Dutch tradition of Realistic Mathematics Education. We use this category to code situations where the pupils get the opportunity to reconstruct the ideas, methods or concepts within a mathematical theory, and where they are allowed to discuss and elaborate on their own methods of solution. They do not need to follow the exact definition of the Freudenthal tradition to fit into this category. In situations where such a categorisation might be used, the emphasis would normally be on presenting a rich context where the pupils get the opportunity to discover rather than being taught a procedure.

Other activities

Sometimes we encounter situations where our list of categories does not give a sensible or complete description of the situation, and this category is to cover such situations. Our wish is to discover practical examples of other such activities to use in teaching situations.

6.5.1.3 Observations – second phase of analysis

The analysis described above was the initial analysis, and it describes the way the videos and the data from the studies of Norwegian teachers were analysed. In a second phase of analysis, the analysis process was revised and refined. This analysis was carried out according to the four points suggested by Stake (1995), as referred to in chapter 6.1.2:

- Categorical aggregation
- Direct interpretation
- Establishing patterns
- Development of naturalistic generalisations

In this stage, we started with an analysis of the questionnaire results. This analysis was used as basis for the aggregation of categories (first point above). The result was a list of ten categories, that were divided in three main themes (see chapter 7.6):

Activities and organisation

- Cooperative learning
- Reinvention
- Projects
- Repetitions and hard work

Content and sources

- Textbooks
- Curriculum
- Other sources

Practice theories

- Teaching and learning
- Vocational relevance
- Connections with everyday life

These categories were then used in a new analysis of the data, and the themes were used as headings in the presentation of the results. A profile table was created according to the themes and categories above, and profiles for each teacher (the three teachers in the main study) were created. The findings were then analysed according to the profile tables, and then all profiles were gathered together in one table and analysed according to the categories. An example of the profile tables can be seen below. This is an excerpt of the first part of Harry's profile table:

	Beliefs	Instructional practice
Activities and organisation		
Cooperative learning	<p><i>Questionnaire:</i></p> <ul style="list-style-type: none"> - Pupils mostly work in pairs (or three and three) <p><i>Interviews:</i></p> <ul style="list-style-type: none"> - Don't focus much on whether the pupils are working in groups or individually, but he puts much focus on getting a good "mathematical discourse" with the pupils 	<p><i>Field notes:</i></p> <ul style="list-style-type: none"> - When working with the bicycle assignment, the pupils worked in groups or pairs, as they chose, but this was not very structured from the teacher's side (13.05)
Reinvention	<p><i>Questionnaire:</i></p> <ul style="list-style-type: none"> - Very often active reconstruction of math. theories. - Comment 1: it can often be a problem for pupils to uncover the initial problem 	<p><i>Field notes:</i></p> <ul style="list-style-type: none"> - Reinventing Pythagoras theorem. Cut out figures from piece of paper, rearrange them, describe what they have done and what they got (22.04)

Table 6 From Harry's profile table

The findings from the classroom observations are presented as 'stories'. A common approach in writing case studies is to give an extensive description – a description that the readers could have given, if they had been present – of the context and issues (cf. Stake, 1995). The sources for these stories were the field notes as well as the transcripts, when they were present.

6.5.1.4 Interviews

The interviews were also analysed on a content level, mainly according to level 2 and level 3. There is always a question of whether an interview reflects the actual opinions or beliefs of the person interviewed or if he or she gives answers that are in some way not entirely true. This may be due to an attempt to please the interviewer in some way, consciously or unconsciously, and it might be a kind of cover when the beliefs lie somewhere outside the frameworks intentions. It might also simply be due to lack of self-insight in some way. In our analysis we therefore do not analyse the interviews solely as interviews in isolation, but look upon them as part of the whole picture. The interviews are therefore to be seen as an important part of our data corpus, and we hope to reach a more complete understanding through a process of triangulation of data. Analysis of the interviews gives us a deeper understanding of what we learned from the questionnaires, and together with the classroom observations they give us a more thorough understanding of the teachers' beliefs and, perhaps even more important, the correlation between the teachers' beliefs and the choices they make in the classroom. Altogether the analysis of these three different kinds of sources hopefully gives us a more complete picture, and we make comparisons between what the teachers say and what they actually do.

6.5.2 Video study

The data analysed from the TIMSS 1999 Video Study was significantly different from the data recorded in the study of three teachers and the pilot study. A main difference was that the videos had already been recorded long before our study started, and the videos had already been analysed by a coding team. This coding team had, among other things, coded the videos according to the number of real-life connections in problem and non-problem settings in each lesson. When our study of videos started, we could easily pick lessons with the highest number of real-life connections. We then spent quite some time searching through the videos, focusing particularly on the events that had been coded as real-life connections. There were also ready made transcripts from all the videos that we could study.

In our analysis, the categorisation from the coding team of real-life connections in problem settings (RLC) and real-life connections in non-problem settings (RLNP) was taken as point of departure. Two more levels of categories were added, and this list of categories was eventually used as a basis for the interpretation of data from our pilot study and (in the first phase of analysis) the data from the study of three teachers.

The situations that had been coded as RLC or RLNP were further analysed and coded according to our extended coding scheme. Some of the situations that were initially coded as real-life connections were evaluated as of little importance (e.g. if they were only comments with one word referring to some issue or situation from real life), and some new situations were coded as having real-life connections. The aim of this coding was not to make a quantitative analysis, which was the case in the official report of the TIMSS 1999 Video Study (cf. Hiebert et al., 2003), but rather to assist a qualitative analysis of the data. In the coding scheme categories and themes were created, which helped sorting and analysing the data. This scheme was used and adjusted in the analysis of the study of Norwegian teachers, and eventually the categories and themes that appeared here provided a basis for generalisations and theory generation.

6.5.3 Textbooks

The analysis of textbooks were meant to complement the other data material, and eventually be used to describe and discuss the relationship between curriculum intentions, textbooks and teachers' beliefs and practices. Only the textbooks used by the teachers in the pilot and main study were selected for analysis. We further selected the chapters that were taught at the time of the classroom observations, as well as the chapters that particularly dealt with mathematics in everyday life, mathematics in society (as some textbooks called it) or similar.

In the first phase of analysis, all the tasks in the books were studied, and the tasks with connections to everyday life were counted. In this counting process, a very open and inclusive definition of real-life connections (or connections with everyday life) was used. We did not make any judgements as to whether a task had a so-called "fake real-life connection" (which could be defined as a problem with a context that appears to be from real life, but is really not) or not. All tasks presenting a problem context that somehow referred to a situation from life in society (mainly outside the classroom) were counted as real-life connections. Typically, a problem of the following kind would NOT be counted as a real-life connection:

$$\text{Solve the equation: } 2(x-2)(3x+4) - 1 = 5$$

A problem of the following kind, on the other hand, WOULD be counted as a real-life connection:

‘Trollstigen’ is a road that twists up a very steep hillside. The steepest part has a slope of 8,3%. How far must a car drive for each metre it is going up?

This task refers to a context from real life (a road up a steep hillside - ‘Trollstigen’), and is therefore counted as a real-life connection. In general, every word problem that were in some way relating to or referring to situations or issues from life in society, the physical world, etc. would be counted as real-life connections.

Some of the tasks that were counted as real-life connections were chosen for further analysis. This selection was based on whether the tasks were good examples, bad examples, or whether they were providing illustrative examples of certain aspects. The evaluation of tasks as good or bad was done with reference to the intentions of the curriculum.

7 Questionnaire results

Before we go into the results there are some necessary remarks to make. This is a small-scale survey, and we do not claim that the results are generalisable for the entire population of Norwegian mathematics teachers. In some cases, however, we could compare our data with the larger L97 evaluation done by Alseth et al. (2003) and find very similar results.

7.1 The questionnaire

As a part of our case study we made a small-scale survey among all the mathematics teachers at the four schools that were chosen, in order to discover whether our teachers differed much from their colleagues. Altogether, twenty teachers answered the questionnaire. In school 3 all the teachers of mathematics handed in the questionnaire, in school 1 three out of four teachers did and in school 2 nine out of eleven teachers answered it. In school 4 three teachers declined to hand in the questionnaire. The twenty teachers who chose to answer the questionnaire were not picked out in a process of random sample. We have a sample of twenty teachers, which constitutes 77% of the mathematics teachers at these four schools.

7.2 The Likert-scale questions

The questionnaire consisted in different parts, starting with a set of 12 Likert-scale questions. The questionnaire also contained four comment-on questions and three list-questions. Some of these answers will be commented on when discussing the beliefs and actions of the individual teachers. The entire questionnaire can be found in Appendix 2. We will look at the results of the 12 Likert-scale questions in the questionnaire now, but first we present the questions:

Mark what you think is most appropriate.

1. I emphasise the connection between mathematics and the pupils' everyday life.

Very often	Often	Sometimes	Seldom	Very seldom
<input type="checkbox"/>	<input type="checkbox"/>	<input type="checkbox"/>	<input type="checkbox"/>	<input type="checkbox"/>

2. I use projects when I teach mathematics.

3. The pupils are actively involved in the formulation of problems from their own everyday life.

4. I use other sources than the textbook.

5. The pupils solve many textbook tasks.

6. The pupils work in groups.

7. First I teach theory, then the pupils practise solving tasks.

8. The pupils are actively involved in the (re-)construction of the mathematical theories.

9. The pupils find the mathematics they learn in school useful.

10. The pupils work with problems that help them understand mathematics.

11. The pupils work with open tasks.

12. Situations from the media are often used as a background for problems the pupils work with.

These were the first questions in the questionnaire. When the results of the questionnaire are commented on below, we do not always follow the same order.

7.2.1 Real-life connections

The main focus in this study was to find out how the teachers connected school mathematics with everyday life, something the curriculum clearly tells them to do, or whether they did this at all. When the teachers were asked if they emphasise the connection of mathematics with everyday life, they replied as follows in the diagram (the numbers in these diagrams are not percentages but actual numbers of responses).

35% replied that they often or very often emphasise real-life connections.

For 13 of the 20 teachers in our survey, i.e. more than half of the total number of teachers of mathematics in these four schools, this was something they emphasised only sometimes. Seven teachers, or 35% of the teachers, replied that they often or very often emphasise real-life connections in their teaching. The tendency here is clearly positive, although most of the teachers answered 'sometimes'. We will discuss this in connection with the other sources of data later. It is interesting to see that Jane, a teacher at an upper secondary vocational school, was the only teacher who emphasised this connection very often. Two teachers in compulsory school replied that they often emphasised it, and six teachers, including all five teachers in school 3, stated that they only sometimes emphasised the connection of school mathematics with the pupils' everyday life.

Alseth et al. (2003) found in a large evaluation study of the recent curriculum reform that the Norwegian teachers had increased their knowledge about the curriculum. There was, however, a discrepancy between their knowledge and their actions. Alseth et al.'s conclusion was that the

teachers still teach the traditional way, although their knowledge of the curriculum is good. It is important to remember that our teachers and schools were selected according to other criteria than random sample, and our aim is to generalise to theory rather than to population (cf. Yin, 1994). We wanted to study experienced and successful teachers rather than average teachers. Even among this group of teachers the idea of connecting mathematics with everyday life was not so strong. We did expect the teachers to be somewhat more positive towards connecting mathematics with everyday or real life (since this is one of the main aims of the curriculum).

In a following question in the questionnaire the teachers were asked to list three possible

strategies to make mathematics more meaningful and exciting for the pupils. In that connection nine teachers mentioned the use of everyday life or real-life connections, or strategies that implied this, although they might have used other words. Three teachers also listed practical examples or real-life connections as strategies to use when the aim was pupil understanding.

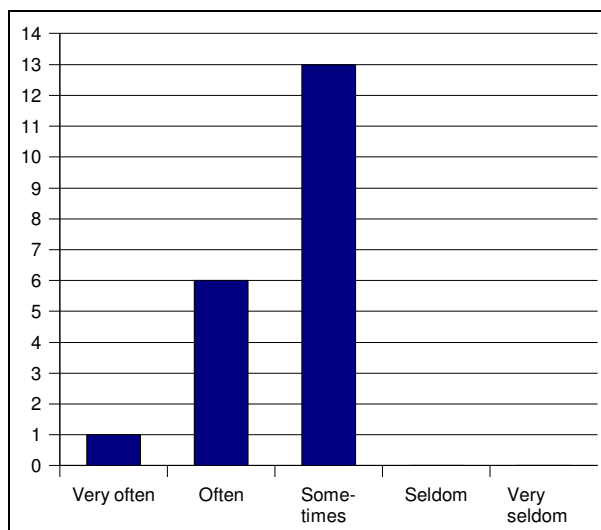

Illustration 10 Emphasise real-life connections

7.2.2 Projects and group work

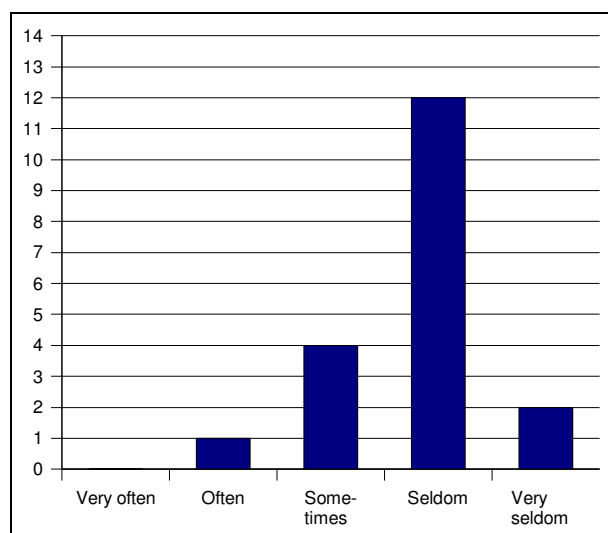

Illustration 11 Projects

Several 'new' issues were emphasised in L97, and the teachers were now supposed to change from traditional teaching, with lectures and practising textbook tasks, to more exploratory methods of work. Projects were supposed to be used to a fair extent. We asked the teachers to say how much they used projects in their teaching of mathematics.

Here we discover a different and more negative tendency. 70% of all the mathematics teachers in the four schools we visited, seldom or very seldom used projects in their teaching of mathematics. Only Harry used them often, and he was (also in the views of his colleagues) an outstanding and special teacher. This result might of course be connected with the teachers' conception of projects. Some of the teachers think of projects as

those large-scale projects that take place once or twice a year, where several subjects are involved and a strict methodology is to be followed. Such projects are not intended to be used all the time, and the curriculum does not limit the notion to including only such larger projects. Harry arranged many mini-projects in his class, but other teachers expressed another understanding of projects. L97 mentions both larger projects and small projects.

Social learning theories have gained increased influence in the last few decades. The issue of group work has been a discussion point among teachers, and we asked our teachers to comment on the statement ‘the pupils work in groups’:

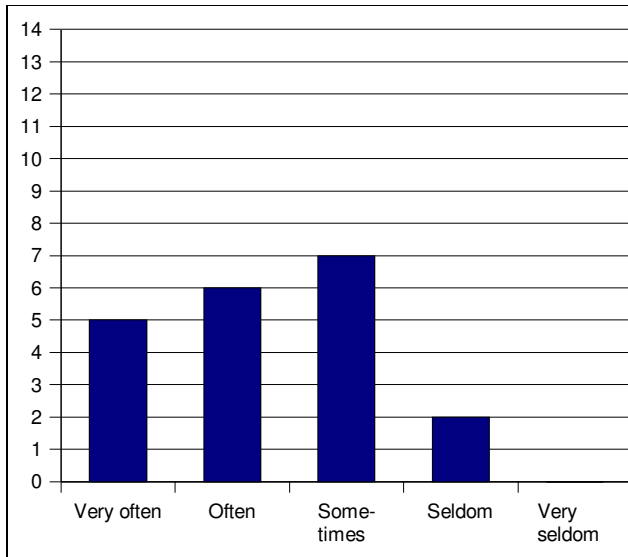

Illustration 12 Group work, all schools

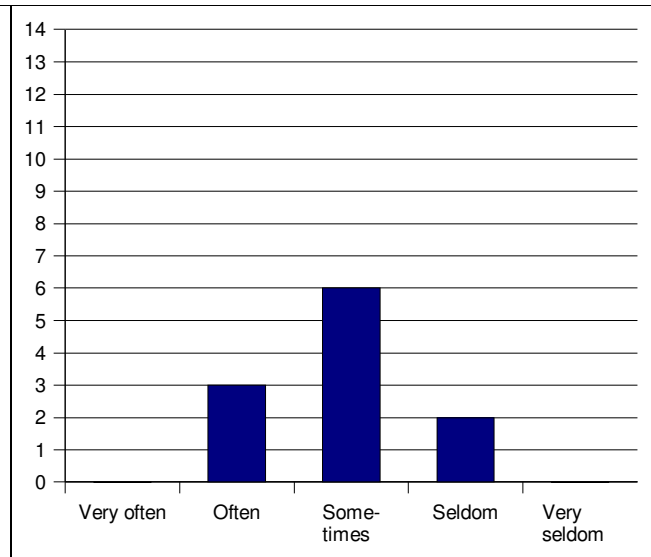

Illustration 13 Group work, schools 1, 3 and 4

There is a clear tendency towards organising the class in groups among the teachers in our schools. We need to take into consideration that one of our four schools, school 2, had nine teachers of mathematics that answered this questionnaire. This particular school also focused a lot on cooperative groups. The results from the other three schools look quite different, as we can see in the figure above. The results from school 2 had a strong influence on the total, but in schools 1, 3 and 4 the teachers are more placed around the middle. Most of them only sometimes organised their classes in groups.

7.2.3 Pupils formulate problems

The curriculum presents several ways of connecting mathematics with everyday life, and one suggestion is to let the pupils register and formulate problems. The teachers were asked if they let the pupils formulate problems from their own everyday life. This is one way of incorporating the ideas and experiences of the pupils into the mathematics classroom, and the pupils are thus encouraged to take an active part in the learning experience.

This was also something our teachers did not emphasise a lot. Most of them, in fact as many as 70%, used this approach seldom or very seldom. Only one teacher claimed to let the pupils often formulate problems.

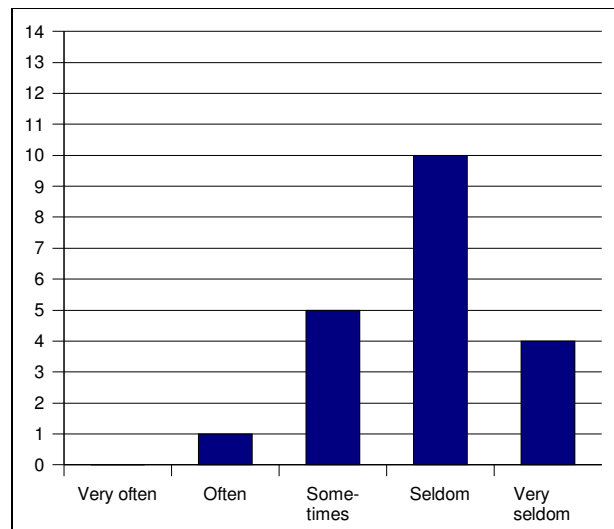

Illustration 14 Pupils formulate problems

7.2.4 Traditional ways of teaching

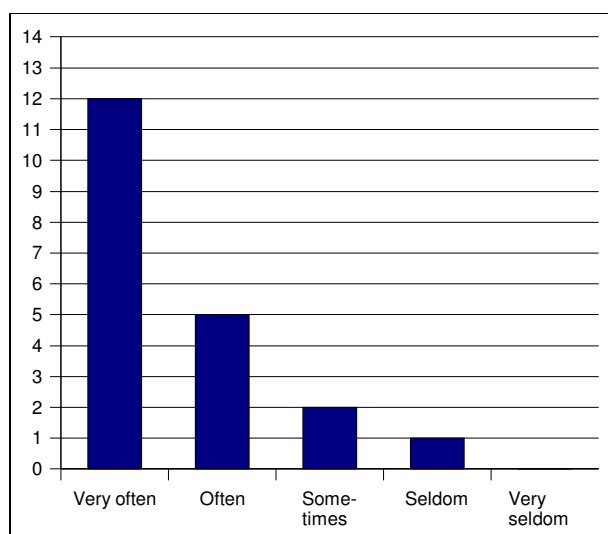

Illustration 15 Solving many textbook tasks

A traditional approach towards teaching mathematics consists of lecturing and letting the pupils practise solving textbook tasks. Alseth et al. (2003) concluded that this was still the normal way of teaching.

Our survey supported this strongly, at least when it comes to letting the pupils solve many textbook tasks. 85% of the teachers claimed they did this often or very often. One might argue that it is important to solve textbook tasks, and that this does not necessarily imply a traditional way of teaching. L97 clearly implies other and different methods of work. Harry was again an exception. He replied that his pupils seldom solved many tasks from the textbook. When introducing a new topic or learning sequence, his pupils would seldom start off solving textbooks tasks. He

mainly used the textbook as a source for the pupils to continue practising at home.

It is common to use textbooks tasks a lot in the teaching of mathematics, also among the teachers in our study. A traditional way of teaching mathematics includes solving many textbook tasks. The traditional scheme is that the teacher first presents the theory and then lets the pupils practise solving tasks (preferably textbook task). We asked the teachers to comment on this.

A majority of the teachers, in fact more than 50% of the teachers in our survey, often used this traditional approach. 75% of the teachers often or very often started off teaching theory, and then let the pupils solve related problems. Harry was one of a few exceptions, and he stated explicitly that he seldom started off with the focus on solving tasks.

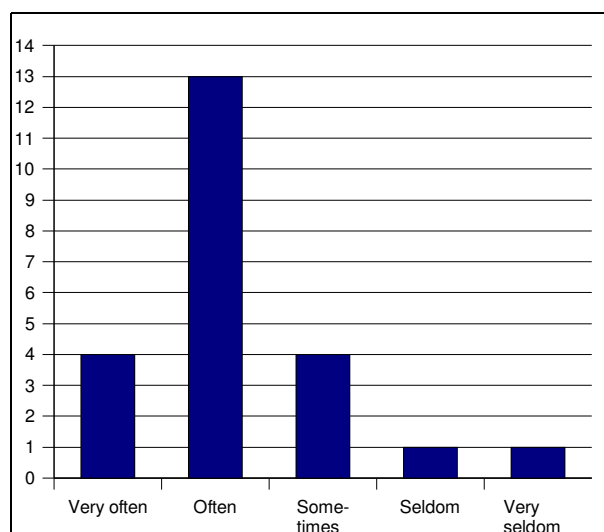

Illustration 16 First lecture, then solve textbook tasks

7.2.5 Re-invention

The next statement we asked the teachers to comment on was this: 'The pupils are actively involved in (re-) inventing mathematical theories'. This is an important idea in L97, and it is strongly connected with the Dutch tradition of Realistic Mathematics Education. The answers to this question were positive, but also quite varied.

45% of the teachers claimed that they often or very often used reinvention in their teaching. Harry answered that this was very often the case, Ann said often, and Karin said that this was sometimes the case for her.

In a following comment-on question, the teachers were asked to comment on the statement that when mathematics is used to solve problems from real life, the pupils must be allowed to take part

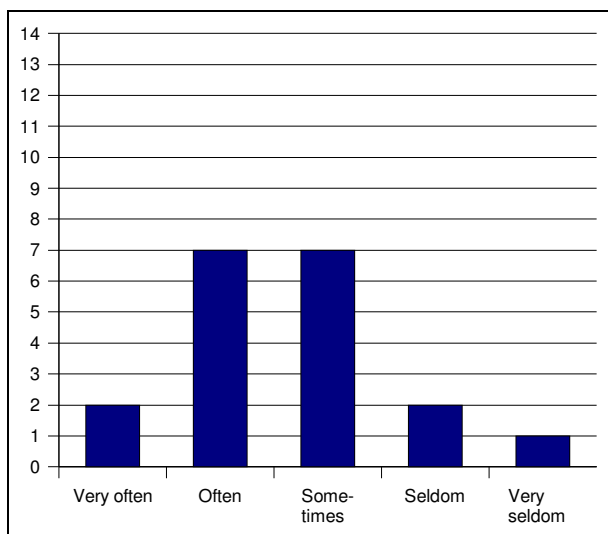

Illustration 17 Re-invention

in the entire process – describing the initial problem, the mathematical formulation of it, solving the mathematical formulation, and the interpretation of the solution in the practical situation. This statement is connected with concepts of re-invention, which the teachers were positive towards. Ten teachers replied that this would often be difficult because of pressure of time. It would be time-consuming, and they were therefore forced to just present the answer to the pupils without letting them take part in the entire process. We therefore assume that many teachers believe this to be a good way of teaching, but in practice it will often be a question of time. In chapters 8 and 9 we discuss how teachers actually carry this out in the classroom, and obtain some further information on what they mean by this.

7.2.6 Use of other sources

Another interesting question was on the use of other sources than the textbook. The evaluation study of Alseth et al. (2003) implied that the teachers were dependent on the textbooks. The teachers' replies to the question of how much they made use of other sources than the textbook reported that 13 of 20 teachers sometimes use other sources.

Very often	Often	Sometimes	Seldom	Very seldom
2	1	13	3	1

Table 7 Frequency table, other sources

No main tendency to the positive or negative side could be distinguished here.

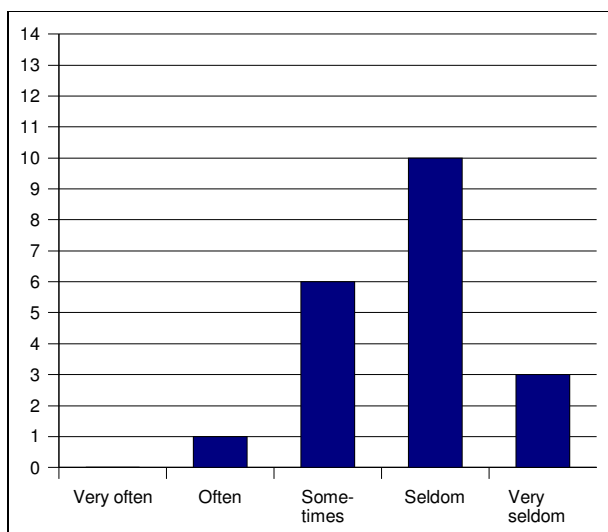

Illustration 18 Situations from the media

This makes sense when we compare this result with the question of how much they emphasised solving textbook tasks. There is an agreement among the teachers in our study that the pupils solve many textbook tasks, and other sources are only used occasionally in the teaching of mathematics.

L97 suggests using different sources to connect the teaching with everyday life, the local community, politics, etc. Our teachers only sometimes use other sources than the textbook. One of the suggestions from L97 is to use situations from the media. Our teachers made this reply:

Situations from the media were rarely used by our teachers. 65% of the teachers in the four schools claimed they used situations from the media seldom or very seldom. This is consistent with the other answers they gave.

The use of open tasks, problems where the solution method is not apparent, problems with more than one answer, or with only estimated answers, etc., is suggested in L97. Since realistic or real-life problems are normally like this and not like the tasks we find in most textbooks, this could also be a way of introducing examples from everyday life.

65% of the teachers used open tasks sometimes. ‘Sometimes’ might of course be a vague answer, and we do not know exactly what all these teachers mean when they use the term ‘open tasks’. There is a tendency of not using them, as 25% claimed to use open tasks seldom or very seldom, but this is one of the answers that remains more open in our survey.

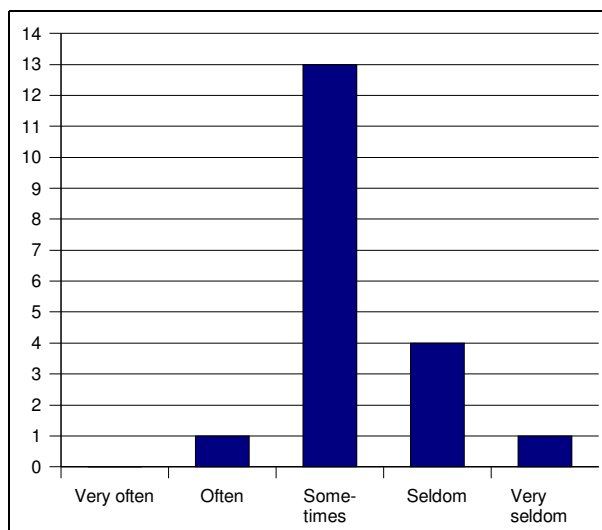

Illustration 19 Open tasks

7.2.7 Usefulness and understanding – two problematic issues

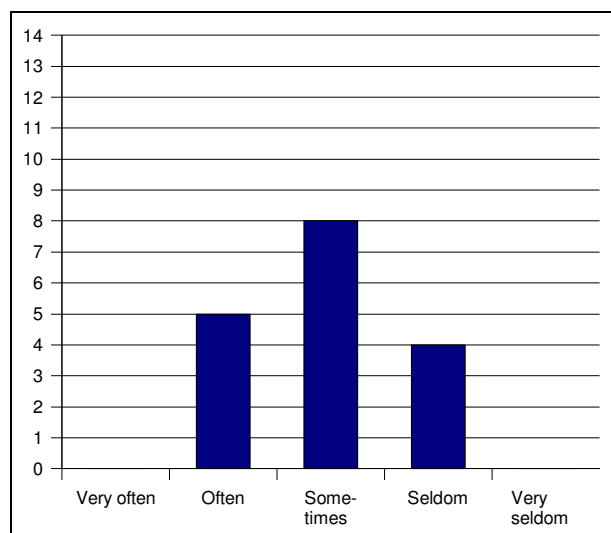

Illustration 20 Pupils find mathematics useful

Questions 9 and 10 in the questionnaire were troublesome for some of the teachers to answer, and this might have to do with the formulation of these questions. The teachers were asked to comment on the statement: ‘the pupils find the mathematics they learn in school useful’. This was hard to answer, and the teachers could not possibly know exactly what the pupils find useful or not. ‘Useful’ was another difficult word. Some teachers did not answer this question, and some wrote down comments about it. We chose nevertheless to keep this question although it was difficult to answer, because we hoped that it could tell us something useful.

The teachers believe that the pupils would sometimes find school mathematics useful, and five teachers believe that it is often useful. In

upper secondary schools in Norway the pupils have a choice of different courses in mathematics. MX is aimed at the pupils who will continue studying mathematics or engineering, while MY is more related to the social sciences. One of the teachers in school 2 said that there would be a difference between the pupils who had chosen MX and those who had chosen MY, as to how useful they would find school mathematics, but we do not have any results for this in our study.

This finding does not tell us all that much about how useful school mathematics is to the pupils, only that the teachers believe that it sometimes could be, but it also tells us that the very notion of usefulness is troublesome. What does it mean for a mathematical topic to be useful? We struggled with this for a while, and we eventually decided to avoid this notion in our work and rather focus on the connections with real life.

In question 10 the teachers were asked to comment on the statement: ‘the pupils work with problems that help them understand mathematics’. This also turned out to be a difficult question.

L97 clearly emphasise understanding, but the concept seems to be troublesome nevertheless. The teachers gave these answers:

50% of the teachers believe that the pupils often or very often work with problems that help them understand mathematics. At the same time, few teachers encourage the pupils to formulate problems from their own everyday life, they do not focus so much on projects, the pupils mostly solve textbook tasks, situations from the media are seldom used and open tasks are not much used either. Yet the teachers still believe that the pupils work with tasks that help them understand mathematics, and it is therefore tempting to draw the conclusion that they believe a more traditional way of teaching leads to understanding.

The teachers were asked to list three issues that are important for a teacher to focus on when the aim is for the pupils to understand mathematics. We hoped that this would give some concrete ideas about what teachers actually did, or at least claimed to do in this respect. These were some of the issues teachers emphasised:

- the importance of repetitions (4 teachers claimed this), and understanding takes time
- making mathematical themes concrete (4 teachers)
- use of practical, realistic or everyday life examples (3 teachers)
- starting with what is already known (4 teachers)
- using good examples and posing good questions (4 teachers) and for the teacher to have access to a source of good examples of this type

This should give us some ideas about what the teachers believed could be done in order to enhance understanding. These beliefs represent some of the important aspects of both cognitive and social learning theories.

7.3 The comment-on questions

The Likert-scale questions were followed by four comment-on questions. Each question presented a quote from some earlier Norwegian curriculum paper, and the teachers were asked to comment on these quotes. The theme of all these quotes was the connection of mathematics with everyday life.

7.3.1 Reconstruction

The theme of the first quote was reconstruction, that the pupils should be actively involved in the entire process when solving problems from real life.

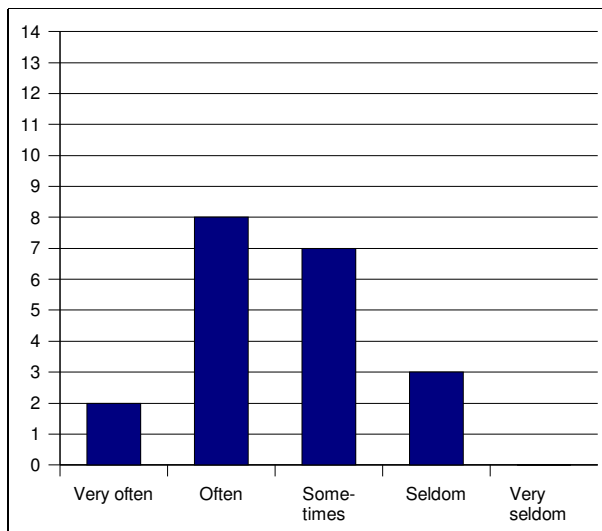

Illustration 21 Problems help pupils understand mathematics

“When mathematics is used to solve problems from real life, the pupils must participate in the entire process – the initial problem, the mathematical formulation of it, the solving of the mathematical formulation, and the interpretation of the answer in the practical situation.”

Five of the teachers had comments that supported this quote, ten expressed some kind of support, and four teachers had comments that displayed disagreement with the quote. A large amount of the teachers (eight) pointed at the lack of time as one issue that makes it difficult to carry out the intentions described in the quote. One teacher had the following comment, to illustrate this:

Unfortunately, we don't have enough time. Finished solutions are presented all too often. Several pupils don't do much in the lessons, and they don't manage to cover the “initial work” as well as solving the exercises. The final exam is about solving exercises, and we thereby often choose the easy way out.

Another teacher had an equally strong statement:

This is mainly the case for projects. We simply haven't got the time to do this for each topic. There are problem areas that the pupils don't know at all, where they are going to learn to use mathematics in order to solve problems that are pointed out to them.

Of the five teachers that supported the quote in their comments, three teachers had comments like “Supported ideally”, “Sounds reasonable” and “I guess this makes sense”. The last two comments in this category showed a deeper support for the ideas displayed in the quote. The first comment was by Jane:

Mathematics is not just about getting the right answer, results, but the process is equally important; for the pupils to discover mathematics, that they solve themselves, gives pupils that are interested and acquire understanding and practical use from the subject.

Karin made the second comment:

In order to be able to make a mathematical formulation of a problem, a considerable amount of knowledge and understanding in advance is needed. So my understanding is that I, as a teacher in lower secondary school, am going to try and prepare the pupils for the process described above.

7.3.2 Connections with other subjects

The second quote was presented as follows:

“When it can be done, the teacher must connect teaching of mathematics with the other teaching [subjects].”

An important observation here is that most of the teachers in upper secondary school commented that this was not so much the case for them. Connecting mathematics with other subjects, according to these teachers, was mainly important for lower secondary and elementary school. One teacher said:

This could of course be favourable, but we shouldn't be afraid of letting mathematics “live its own life”. If we believe it has an effect on learning, we should do it, but I don't like real-life exercises that are artificially constructed.

The teachers in lower secondary school were more positive towards this quote. Mathematics in everyday life and statistics were put forward as topics where connections to other subjects were possible. Others, like Harry, expressed different opinions:

I understand “teaching” as “teacher in activity”. There is little benefit in connecting “teachers in activity”... If the mathematical activities are good, they don’t need to be connected with other subjects.

7.3.3 Problem solving

The third quote was addressing the issue of solving problems from life outside of school:

“The children should learn to solve the kind of problems [tasks] that they normally encounter in life [outside of school], confidently, quickly and in a practical way, and present the solution in writing, using a correct and proper organisation.”

Seven teachers expressed support for this quote, three teachers were negative and the others had comments like this:

I totally agree, but that is far from the only thing they should be able to solve.

Several teachers, especially the ones in upper secondary school, stated that mathematics should also be something more than this.

This must be an important part of mathematics teaching. On the other hand, it is also necessary to practise basic skills more isolated. We must also not forget the value of learning mathematics for its own sake, without always trying to connect it with practical situations.

Another upper secondary teacher had similar ideas:

An important aspect that is suitable for children. The aspect of use is overemphasised. It underestimates people’s joy of solving mathematical problems, systematising, the beauty. Compare with English which is supposed to learn tourists to order a room. Shakespeare is also part of life.

7.3.4 Content of tasks

And the fourth quote:

“The content of exercises should – especially for beginners [younger pupils] – first and foremost be from areas that the children have a natural interest for in their lives and outside of the home environment.

Later, the subject matter must also be from areas that the pupils know from reading books and magazines, or that they in other ways have collected the necessary knowledge about.”

Six teachers agreed to this, two teachers (both from upper secondary school) disagreed, and the other teachers had some positive and some negative thoughts concerning the issues raised. Here also, some of the teachers in upper secondary school reacted to the use of the word “children” in the quote. In their comments, they said that they do not teach children in upper secondary school. The same two teachers said that the first sentence was good enough (at least for children), but the second sentence was unclear to them. One teacher (also in upper secondary school) said that this contradicted the demands of the curriculum:

The way I see it, this is contradictory to the demand that is presented in the national curriculum papers with specific goals for each subject. We cannot combine a state where the pupils themselves shape the subject, when the content (at least for upper secondary school) is already given. With the time pressure that we experience in upper secondary school, I don't regard this to be very realistic.

7.4 The list questions

In the first list question, the teachers were asked to list three issues that they find important to focus on for a mathematics teacher, when the aim is for the pupils to learn to understand mathematics. This question resulted in a large list of suggestions for important aspects:

Categories	Frequency
Most popular	
- practical or concrete/well known examples	6
- interest/motivation/enthusiasm	4
- understanding of (basic) concepts	3
- practice/repetitions	3
- time (understanding needs time)	3
- understand problem statements	2
- differentiate	2
- render plain	2
- reconstruction	2
- positive learning environment	2
- mathematical discussions (among pupils)	2
- tasks that challenge to go deeper	2
- focus on the pupils	2

Table 8 Understanding mathematics

The second list question was about making mathematics more meaningful. The teachers provided several suggestions here also:

Categories	Frequency
Most popular	
- everyday life examples/connections	7
- variation	3
- adjust level	2
- practice/repetitions	2
- hard work	2
- usefulness	2
- promote understanding	2

Table 9 Making mathematics more meaningful

In the last list question, the teachers were asked to list three elements that were important to succeed as a mathematics teacher.

Categories	Frequency
- formal competence	9
- enthusiasm (about mathematics)	6
- clear explanations (heuristic method)	5
- create confidence/good learning environment	5
- understand pupils' concepts and problems	4
- sense of humour	3
- good contact with pupils	3
- be structured/systematic	2
- be just	2
- encourage and inspire	1
- general interest in society and work	1
- interest in the individual pupil	1
- patience	1
- skills in practical pedagogy	1
- proper progression	1
- inspire	1
- source of interesting problems	1
- something has to be learned by heart	1
- individual help	1
- variation	1
- creativity	1

Table 10 To succeed as a mathematics teacher

7.5 Comparison of teachers

Before we make a comparison of the teachers and their replies to the questionnaire, we need to get a better overview of the questionnaire results, especially the replies to the Likert-scale questions. We therefore present a frequency table of the answers to these questions:

Questions	Very often	Often	Sometimes	Seldom	Very seldom
1. I emphasise the connection between mathematics and the pupils' everyday life.	1	6	13	0	0
2. I use projects when I teach mathematics.	0	1	4	12	2
3. The pupils are actively involved in the formulation of problems from their own everyday life.	0	1	5	10	4
4. I use other sources than the textbook.	2	1	13	3	1
5. The pupils solve many textbook tasks.	12	5	2	1	0
6. The pupils work in groups.	5	6	7	2	0
7. First I teach theory, then the pupils practise solving tasks.	4	11	4	1	1
8. The pupils are actively involved in the (re-)construction of the mathematical theories.	2	7	7	2	1
9. The pupils find the mathematics they learn in school useful.	0	5	8	4	0
10. The pupils work with problems that help them understand mathematics.	2	8	7	3	0
11. The pupils work with open tasks.	0	1	13	4	1
12. Situations from the media are often used as a background for problems the pupils work with.	0	1	6	10	3

Table 11 Frequency table of questionnaire results

Teachers are all different, but they might have some beliefs in common. In the introduction we presented as a hypothesis that the teachers would fit into three different groups as far as real-life connections are concerned. We defined a positive group, a negotiating group and a negative group. The answers to the Likert-scale questions were analysed in order to find out what groups the eight main teachers in our study belong to. First we categorised the answers that were given. If a teacher replied 'very often' or 'often' to a question, we marked it with + (positive), if he or she replied 'sometimes' we marked it with \pm (negotiating) and if they replied 'seldom' or 'very seldom' we marked it – (negative).

7 Questionnaire results

Teachers:	Questions:											
	1	2	3	4	5	6	7	8	9	10	11	12
Harry	+	+	±	+	-	+	-	+	+	+	+	+
Ann	±	-	-	±	+	±	±	+	±	-	-	-
Karin	±	-	-	±	+	±	+	±	-	-	-	-
Jane	+	-	-	+	±	-	+	±	±	±	±	±
George	+	-	+	+	+	+	+			+	±	-
Owen	+	-	-	±	+	±	+	+	+	+	-	-
Thomas	±	±	-	±	+	+	±	+		+	±	-
Ingrid	±	-	-	±	+	+	+	+	±		±	-

Table 12 The teachers' replies

Table 12 displays the replies of our teachers to the Likert-scale questions in the questionnaire. We then made some assumptions as to what answers would fit the curriculum ideas more or less. Questions 1-4, 6 and 8-12 all represent ideas expressed in L97. If a teacher replied that he often or very often would connect mathematics with everyday life (question 1), he would be placed in the positive group for this question. Questions 5 and 7 represent traditional ways of teaching, and teachers who replied that they often or very often teach theory first and then let the pupils practise solving tasks (question 7) were placed in the negative group on this question. A teacher that belongs to the positive group would therefore be expected to give positive replies (i.e. 'often' or 'very often') to all questions except 5 and 7. Here the 'positive' teacher would give a negative reply (i.e. 'seldom' or 'very seldom'). The opposite would be the case with the teachers in the negative group. The teachers in the negotiating group would be expected to answer 'sometimes' to all questions. If a teacher replied 'very often' or 'often' to all questions except 5 or 7, and these questions were marked with 'seldom' or 'very seldom', he would fit the positive group perfectly, and he would be given the number 0 in the positive column in table 13. The table displays the number of replies that differed from the expected or 'ideal' answers. The table is intended to show how well a teacher fits each of the possible groups.

	+	±	-
Harry	1	11	12
Ann	12	7	6
Karin	12	8	4
Jane	10	5	8
George	5	9	6
Owen	8	10	6
Thomas	8	6	8
Ingrid	9	7	6

Table 13 Group of extremes

This is of course a simplified model, but it will give us an idea of which group the teachers belong to. The lowest number of each teacher would therefore indicate which group he or she belongs to. Note that the signs +, ± and - now refer to the three groups of teachers in this table, and they therefore do not mean the same as in table 12.

Harry obviously belongs to the positive group, since he only had one answer that was different from what a 'positive' teacher is supposed to answer. There is more uncertainty with teachers like Ann, George and Ingrid. Karin and Owen seem to belong to the negative group, while Jane and Thomas

would belong to the negotiating group. Ann and Ingrid are somewhere between the negative and the negotiating group. They both had seven answers that did not fit into the expected answers of the negotiating group, and six questions did not fit the negative group perfectly. We would therefore say that they probably belong to either the negotiating or the negative group, according to our model. George gave five answers that did not fit the positive group. This implies that he could belong to this group, but he was also only six answers short of fitting the negative group. According to our analysis he would therefore fit either the positive or the negative group, but it is hard to tell which.

7.6 *Categorisation*

A distinction of three such groups can simplify a complex picture a lot, but in some cases (like with this study) the simplification can go too far. To learn more about the beliefs and actions of the teachers – beyond a mere labelling of positives and negatives – there had to be a different focus. A model of extremes, as described above, might seem like a good idea when trying to categorise teachers, but when the aim is to learn about beliefs and practices in order to find ways of promoting a change in teaching, a simplified model like this turned out to be less helpful. A different focus had to be chosen, and the questionnaire results contained a number of issues that teachers focus on, which have been used in order to generate a list of categories for use in the further analysis and discussion of data. From the questionnaire results the following list of categories was identified:

- Cooperative learning
- Reinvention
- Vocational relevance
- Connections with everyday life
- Projects
- Teaching and learning
- Textbooks (tasks, teaching)
- Curriculum
- Other sources
- Repetitions and hard work

This list represents some of the issues that the teachers emphasised in the questionnaire. We have identified three main themes from this list: activities and organisation, content and sources, and practice theories. By focusing on more concrete issues like these, we hoped to identify issues that could answer our initial research questions and contribute to the reaching of our aims in a better way than a categorisation of teachers into a simplified model that we have indicated so far. The sorted list looks like this:

Activities and organisation

- Cooperative learning
- Reinvention
- Projects
- Repetitions and hard work

Content and sources

- Textbooks
- Curriculum
- Other sources

Practice theories

- Teaching and learning
- Vocational relevance
- Connections with everyday life

Our initial hypothesis – that teachers can be divided in groups of positive, negative and between – turned out to be far too limited, and will therefore be used to a less extensive degree than initially planned. During the analysis it occurred to us that these simplified labels did not provide us with much interesting information, and they did not help in generating new theory. The adjusted model, or list of categories, presented above was used as a new working hypothesis.

7.7 Final comments

More than half of the teachers in the four schools we visited sometimes emphasised the connection between school mathematics and everyday life (35% emphasised it often or very often). Projects were seldom used, and they seem to have different definitions of ‘projects’. They did not let the pupils take part in the problem formulation and thereby take the pupils’ experiences into consideration in the classroom. Most of the teachers used the textbook a lot, and they only sometimes used other sources than the book. This view was supported when they were confronted with some of L97’s suggestions for other sources. These results are consistent with the results of the evaluation study of Alseth et al. (2003). Their study suggested that the teachers had a good knowledge of the curriculum, but this knowledge was not incorporated in their classroom teaching to any great extent. Most of the teachers were teaching in a traditional way, using lectures and practice of textbook tasks, and the curriculum did not have much practical effect on their everyday teaching. We also get this impression from the teachers in our study.

Many teachers claimed they let the pupils take an active part in the re-invention of mathematical theories, but time is an obstacle when these ideas are to be implemented. We do not know if the teachers had the same understanding of ‘re-invention’, and if this understanding would fit the ideas of the curriculum.

Our study was not intended to be an evaluation study, but rather a study of how the teachers implement the ideas of connecting school mathematics with everyday life. This was something the teachers only emphasised to some degree, even though our teachers were picked out with the purpose of studying teachers who actually would be expected to emphasise these ideas. The results from our survey are consistent with the findings of the national evaluation study mentioned above, so there is reason to believe that our teachers were not that special after all.

8 Three teachers: Their beliefs and actions

“Of course, there is no educator without a teaching philosophy, or should I say, without two teaching philosophies, an explicit philosophy he professes, and an implicit one he acts out.”

Hans Freudenthal (1971)

This study is based on teaching ideas from L97, and there is therefore a main focus on grades 1-10. We will now present some teachers at lower secondary level, or grades 8-10. The aim has been to study their beliefs, in particular where the connection of mathematics with everyday life is concerned, and how they put their ideas into action.

8.1 Curriculum expectations

The national curriculum is the guiding document for all Norwegian teachers, and it is natural to study teachers' beliefs and actions in connection with the ideas and intentions of the curriculum. We discussed in chapter 2.1 that there is a difference between beliefs and knowledge. Alseth et al. (2003) concluded that the teachers' knowledge about the curriculum had increased, but the teaching still remained traditional. When we have chosen to study both the teachers' beliefs and their actions, it is with the intention of uncovering any possible discrepancy between the two, finding the relationship between beliefs and actions, as well as presenting some teaching ideas from experienced teachers.

We have already discussed how the Norwegian curriculum presents the connection of mathematics with everyday life (see chapter 4), and we have remarked that it contains a fairly concrete list of ideas that the teachers should work on (cf. RMERC, 1999):

- register and formulate problems
- use spreadsheets
- include questions on (personal) finances
- calculate with foreign currencies
- buy and sell items
- work with units and measurements
- describe and work with complex situations
- use small projects
- use complex problems in realistic contexts (projects)
- apply mathematics to issues concerning:
 - our natural surroundings
 - use of resources

- environment and pollution
- energy use
- traffic
- communication

These are areas in which L97 expects the teachers to carry out the connection of school mathematics with everyday life. The curriculum is the working document for Norwegian teachers, and it would therefore be reasonable to expect to see some of these ideas implemented in the classrooms.

8.2 *Setting the scene*

Classrooms are venues for teaching and learning activities, and these activities are the main focus of many educational studies. A method for learning more about teaching is to observe teaching in the natural environment, which is the classroom. One thing is to watch or participate in a lesson, another is to read about it. When reading the manuscript of a theatre play, there is always a presentation of the scene and the characters involved first. The readers cannot watch any actual ‘scenes’ from the classroom situations in this study. We will therefore introduce the characters and settings, so that it is possible to understand and envisage what we have observed, and what we are discussing.

Four different schools have been visited in this study. Two of these schools, school 1 and school 2, were upper secondary schools in a city in southern Norway. The other two were lower secondary schools in the eastern part of Norway, and they have been called school 3 and school 4.

8.3 *Two phases*

In chapter 6 we explained that our study had two parts, and that the first part eventually ended up serving as a pilot. Methodologically speaking it did serve as a pilot, since it was used to test out and refine our methods and design. The results of this first phase are, however, treated as an equal part of the study. They are presented not only for comparative reasons, but also to see how these results fit the demands of the upper secondary curriculum. The main focus is to study how teachers connect mathematics with everyday life in their teaching, according to the requirements of the national curriculum. The study of teachers in upper secondary school was meant to give us knowledge about how teachers at that level thought, and how they approached the same issues. We would also like to address the hypothesis that mathematics is less connected with everyday life in upper secondary school than in compulsory school. This part of the study was, chronologically speaking, carried out before the main phase. In the presentation of results we start with the study of three teachers in lower secondary school as a main phase and then present the results from the study of teachers in upper secondary school.

8.4 *Models of analysis*

This chapter focuses on the study of three teachers in lower secondary school. We initially presented a model of extremes to describe the teachers. This model was a simplification, and it did not give us a particularly distinguished or complete image of these teachers and their beliefs. It was therefore abandoned, and the further analysis of data lead to a more distinguished list of categories to focus

on. In order to give a correct presentation of the study, it would be wrong to pretend that the model was never there, and we therefore include it here. The model made a distinction between teachers who:

- focus a lot on the idea (Positive)
- support the idea, but do not implement it (Negotiating)
- do not fancy the idea, and do not emphasise it (Negative)

‘It’ in this occasion is the idea of connecting school mathematics with everyday life. When observing classrooms and analysing data, we discovered that life is (of course) not that simple, and no teacher can be placed in a single category that explains all the aspects of his or her beliefs and teaching practices. These are three natural categories to consider, however, at least philosophically speaking. In reality most teachers somehow fit into all these categories, as they focus on both skills and concepts, and also on real life applications, at least to some extent, but in order to answer our initial research questions and approach the goals of our research, a different ‘model’ needed to be introduced.

In chapter 7.5 we discovered that Harry fits the ‘positive’ group almost perfectly, and Karin fits the ‘negative’ group well. Ann turned out to be somewhere in between the negotiating and the negative group. Such labels might simplify a complex picture, but the information they provide are of limited value. A more distinguished list of categories and themes were therefore generated and presented in chapter 7.6, and this list will be used in the presentation of data in the following. The main themes: activities and organisation, content and sources, and practice theories, will be used to organise the data and findings.

8.5 Brief comparison

We start off with a short presentation and discussion of the teachers’ replies to the 12 first questions in the questionnaire (the Likert scale questions).

1) I emphasise the connection between mathematics and the pupils’ everyday life.

Very often	Often	Sometimes	Seldom	Very seldom
	Harry	Ann, Karin		

The answers to this question are not sufficient to make any conclusions about the teachers beliefs about connecting mathematics with everyday life, but it gives us an idea. Harry claimed to emphasise the connection a lot, whereas Ann and Karin only sometimes emphasised a connection to the pupils’ everyday lives in their teaching of mathematics. The interviews and classroom observations will tell us more about these first impressions.

2) I use projects when I teach mathematics.

Very often	Often	Sometimes	Seldom	Very seldom
	Harry		Ann	Karin

Projects are emphasised in L97, and this is supposed to be one of the working methods that could provide the opportunity to incorporate the pupils' everyday life experiences. The results here are therefore as expected. Karin very seldom used projects, she claimed, whereas Harry used them often. In the following we discover that Harry mostly talked about small projects, while Ann thought more about large-scale projects involving more school subjects.

3) The pupils are actively involved in the formulation of problems from their own everyday life.

Very often	Often	Sometimes	Seldom	Very seldom
		Harry	Ann	Karin

These teachers evidently did not let their pupils formulate problems from their own everyday life a lot, but the distribution of answers fits well into our initial model of extremes, Harry being the one doing this more and Karin seldom.

4) I use other sources than the textbook.

Very often	Often	Sometimes	Seldom	Very seldom
Harry		Ann, Karin		

'Sometimes' is a vague answer, and it does not always mean the same. We will therefore have to look a bit closer into how Ann and Karin used other sources. Harry undoubtedly made use of other sources very often, which was also the main impression from the classroom.

5) The pupils solve many textbook tasks.

Very often	Often	Sometimes	Seldom	Very seldom
Ann	Karin		Harry	

In this question we discover that the order is mixed. Harry stated that he did not focus so much on solving textbook tasks, as we can also see from his response to question 7 below. He rather used the textbook as a source of tasks for the pupils to work on at home. Both Ann and Karin emphasised this though, which we could expect if they were to fit our model. What might be surprising is that Ann claimed to focus on solving textbook tasks more often than Karin, but this might of course be due to other than factual differences.

6) The pupils work in groups.

Very often	Often	Sometimes	Seldom	Very seldom
	Harry	Ann, Karin		

Harry commented that his pupils often worked in pairs or groups of three, but he explained in the interview that this was not something he emphasised a lot. Neither Ann nor Karin used groups as a main organisation of the class.

7) First I teach theory, then the pupils practise solving tasks.

Very often	Often	Sometimes	Seldom	Very seldom
	Karin	Ann	Harry	

Here the order is reversed, which makes sense since the statement supports a traditional way of teaching. Karin was in favour of a more traditional approach to teaching mathematics, and she therefore claimed she often used this approach. Ann sometimes used this method, while Harry seldom practised this approach in his teaching. Harry commented explicitly that he would seldom start with focusing on solving tasks.

8) The pupils are actively involved in the (re-)construction of the mathematical theories.

Very often	Often	Sometimes	Seldom	Very seldom
Harry	Ann	Karin		

Harry claimed that his pupils very often were actively involved in the reconstruction of mathematical theories. Ann replied that it was often so, and Karin that this was only sometimes the case in her class. Letting the pupils take part in the reconstruction of theories is one of the methods where they can bring their own experiences and knowledge into play, and a method that was strongly recommended by Freudenthal. Guided re-invention is important in the tradition of RME, but we should be careful about concluding that these teachers have the same understanding of the concept as the Dutch tradition.

9) The pupils find the mathematics they learn in school useful.

Very often	Often	Sometimes	Seldom	Very seldom
	Harry	Ann	Karin	

This question proved to be difficult for the teachers to answer, and we should therefore probably not put too much emphasis on it. It is based on a subjective opinion from the teacher about the thoughts and experiences of the pupils, and it is difficult for a teacher to know what a pupil really finds useful. The answers give us an idea though, and they fit into our model as well.

10) The pupils work on problems that help them understand mathematics.

Very often	Often	Sometimes	Seldom	Very seldom
Harry			Ann, Karin	

Harry believed that this is a very important part of his teaching, and he emphasised this a lot. Karin seldom let the pupils work with problems that help them understand mathematics. This might be connected with her view on mathematics as a school subject, being mainly a kind of mental exercise. Ann also experienced that her pupils seldom work with problems that help them understand mathematics. According to what she said in the interview, we would believe that this was something she would actually wish to be true, but that she experienced difficulties in actual classroom situations.

11) The pupils work with open tasks.

Very often	Often	Sometimes	Seldom	Very seldom
	Harry		Ann, Karin	

‘Open tasks’ are probably a vague notion, and there is of course a possibility that the teachers have different impressions of what they are. In our opinion, open tasks are exercises or problems where the method of solution is not given, and where the answer might involve several solutions, estimated rather than absolute values, etc. In many ways they are similar to situations from real life. Harry focused quite a lot on this, while Ann and Karin did not.

12) Situations from the media are often used as a background for problems the pupils work with.

Very often	Often	Sometimes	Seldom	Very seldom
	Harry		Ann	Karin

Using situations from the media is one way of incorporating everyday life situations into school mathematics, and this might be an additional source to the textbook. Based on their replies to the other questions, like question 4, it should not come as a surprise that Harry often did this, while Ann seldom did it and Karin very seldom did it.

All in all, the answers the three teachers gave to these 12 questions fit well together. There is an internal logic and connection between them, and we therefore believe that the teachers were honest, and that the answers are at least somewhere close to the ‘truth’. Harry was clearly positive and Karin was negative towards connecting with everyday life. Ann was more difficult to fit into one of the groups. When we look more closely at the answers, she appears to be somewhat less negative than Karin, and we therefore place her in the negotiating group of our initial model of extremes.

To learn more about the teachers’ beliefs and actions, we will have to go beyond such a simplified model of extremes. The list of categories referred to above distinguish teachers when it comes to activities and organisation, content and sources, and practice theories. In the analysis and presentation of data from the study of three teachers, this list will be used and referred to.

We will now examine the other sources of data, to learn more about the three teachers and their beliefs. They will be presented in reverse order (when compared to the initial model of extremes): first Karin, then Ann and in the end Harry.

8.6 Karin's beliefs

Karin had about 18 years of teaching practice at the time of this study, 5 ½ years in elementary school and 13 years in lower secondary school. She had studied mathematics and statistics for about a year at the university, she had studied Christian religion, philosophy and pedagogy, and she also had one year of administrative studies. We have already been given a glimpse of Karin's beliefs from the questionnaire. When looking deeper into the teachers' beliefs concerning real-life connections we will work on three levels. These levels were presented in chapter 6 and we will present our findings through these levels. The first level has to do with real-life connections and the conception of them. The second addresses the content level, dealing with the kinds of problems worked on, or the sources in use, while the third level addresses the more organisational issues.

8.6.1 Practice theories

Karin described herself as a traditional teacher. Experience from her own school days as well as teaching experience from a catholic school in Africa could have contributed to this. She taught a class of grade 8 pupils in mathematics.

Karin said in the questionnaire that she sometimes emphasized connecting the teaching of mathematics with the pupils' everyday lives. 'Sometimes' can be a rather vague answer, and we will explore this a bit further. In the interview she said this, when asked what she thought about this connection:

"If it is their daily life ... as I said, I am opposed to that thought in everything!"

Yeah, well, I must say that I am not very fond of the idea. Like, at least not when it comes to having a direct connection. Just as I believe that when a teacher of sports makes them do the high-jump, it is not because they are going to do the high-jump later in life. It is plainly to train the body. And I actually have that idea about most of the things we do here, that – at least when it comes to mathematics, what the mathematics offer of training – is logical thinking, being able to transfer principles from one ... or, yeah, transfer something to something else, rules and principles. Plainly to use your head. And ... because they need this! No matter what kind of job. So, right, you have x and y-s and a-s and b-s and lots of things they don't have to do for the rest of their lives ... But this is my motivation for the pupils (Teacher interview).

The main aim of school mathematics is logical thinking, she believed, and exercising your brain. Mathematics is brain training, getting to know and mastering your own mind and your own thoughts. It would not be enough, according to her, to change the curriculum in order to carry out ideas like that.

In the questionnaire, we asked the teachers to comment on a phrase that was present in several earlier Norwegian curricula. This stated that the children should learn to solve problems that are usually encountered in everyday life, that they should be able to solve these quickly, in a practical way, etc. Karin replied that this was not a main aim in mathematics. Developing understanding, logical abilities, being able to transfer knowledge from one example to another was, in other words brain training. She clearly claimed to be opposed to the idea of connecting any school subject with the pupils' everyday life, and making this the main emphasis. It is important for the pupils to struggle and work hard, as she put it: like standing on the edge of the unknown.

"It isn't enough that someone produces a new curriculum and hope that you will get a new content."

It would have been nice to know what caused Karin's opposition towards connecting mathematics with daily life. One reason might of course be that she found this connection troublesome, and that she believed that it does not help the weaker pupils. We find some

statements that at least give us the impression that she found it hard to connect mathematics with daily life experiences:

And then, when I am teaching practical things, like foreign currency, then my head ... then I am just as thick as the pupils. How was that again? Oh yeah, like that. Then the understanding of it kind of is not present in my head. It is quite embarrassing! It probably doesn't interest me much. And that means that I don't carry that understanding around. It is kind of embarrassing... But I am well prepared for those lessons, hehe. Practical calculations. No, but with practical tasks there is something new in every ... problem, kind of. So, it is in a way very hard to help the pupils there, give them the right baggage. They kind of have to go into it themselves. But I have pupils who love it when they meet these practical tasks, right. So, fortunately where I feel weak, many find it fun! But at the same time I must say that it isn't like the weak [pupils] are finding it great. Unfortunately it is not like that! (Teacher interview)

It might be with what we call real-life connections as with what she here called teaching practical things, or practical calculations, that she found them hard herself. When using more open tasks, which often resemble the kind of problems we encounter in real life, the teacher will lose some of his or her control. The answer is not necessarily given explicitly, and there are so many components that influence the learning situation. Some teachers find this problematic. A straight answer that might be correct or incorrect is easier to relate to. This might also be a reason why many teachers say that connecting mathematics with everyday life does not necessarily make it easier to understand (for the weaker pupils), and it might actually be the contrary.

8.6.2 Content and sources

“So, the textbook? No, I don't think I could manage without it!”

In the questionnaire Karin said that she often let the pupils solve tasks from the textbook. She only sometimes used other sources than the textbook. She often started off teaching theory in her lessons, and then she let the pupils practise solving problems. In the interview she elaborated further on this, and she said that she would often lecture for the first fifteen minutes of the lesson. For the rest of the lessons the pupils would be allowed to work on tasks.

In her teaching, Karin used the so-called pupils' book a lot. She told the pupils to write in this note book, and she also told them explicitly what to write. In this way she believed that the pupils would make this into their own, and they would see that it was for themselves and not for the sake of the teacher or anyone else they were doing this. Making things clear to the pupils was presented in different contexts as an important principle, also when it came to the pupils' book:

I believe in a way that they get more of an ownership towards what they themselves have written in a book from an example, than from an example that is printed in the textbook. So, they return to something they feel more related to. So in that way I believe, I am quite convinced that this is a way of making things more clear, emphasising and carving something into their brains (Teacher interview).

She did not believe, on the other hand, that the pupils would automatically adopt all the things she said. She believed that they need to apply it, and that was why she did not want to spend all the time on teaching and not leave time for working with problems. Her motivation for working with the pupils' book came from her own school days, when she had had a biology teacher who emphasised this a lot. She was still amazed by the pupils' book her old teacher encouraged her to make.

When it comes to the problems the pupils work with, it seems as if they were normally problems from the textbook. In the questionnaire Karin replied that the pupils would seldom work with open

tasks, situations from the media would very seldom be used, and the pupils would very seldom be actively involved in the formulation of problems from their own everyday life. She replied that she would sometimes use other sources than the textbook, but it is hard to see what kind of sources this might be. We do not learn more about other potential sources in the interview either.

8.6.3 Activities and organisation

Karin said that she was a conservative and quite old-fashioned teacher. This also became apparent when she was asked about working methods in general and the use of projects in particular:

Absolutely exaggerated. Hehe. Absolutely exaggerated! Because it demands lots of skills if anything is to come out of it. It demands a lot of knowledge (...) So, I feel it is sometimes a bit wishful thinking. A bit like living in a dream world (Teacher interview).

Further down she stated that she was not opposed to the idea in principle, but she believed that it had been too much emphasised in the curriculum. In a school system where everyone is included it is difficult to manage project work. Karin was in favour of dividing classes or groups according to their skills and level of knowledge, and she had experienced this herself when she worked as a teacher in an African country.

On the other hand, Karin believed that the pupils have to apply the theories and problems they work with. She would probably have had this application carried out by practising textbook tasks:

(...) it is important that I don't just put things into their heads, and then believe that it will become theirs. I don't believe in that! They have to apply it. So, it is important for me not to spend too much of the lesson teaching. But on the other hand it is ... because there are pupils who are uncertain, who will look at the neighbour, who will look in the answers, so it isn't good enough just throwing them out into it (Teacher interview).

There are several ways of letting the pupils apply theory, and there is always a discussion about what comes first, applications or theory. When connecting mathematics with real life, both are possible, but where re-invention is concerned, applications or real life connections would come before the reconstruction of theory. A process of re-invention, which is guided by the teacher, demands planning. Karin preferred what she called 'the shorter way':

It is, I suppose, that one takes the shorter way. Approaching the principles first, and then applying them, instead of spending more time out there in real life, fumbling around, and then some principles appear. Hehe (Teacher interview).

From this statement we get the impression that Karin believed that a process of reconstruction involves an element of chance, and that the theories and principles the teacher is aiming for do not necessarily appear. This might be connected with the fact that planning a process of guided re-invention is something Norwegian teachers are not trained to do.

In another discussion we had, Karin explained that she did not think the curriculum had changed that much after all. She did not think much about the curriculum in her daily work. In the classroom activities she mostly related to the textbook. This supports an impression that we sometimes get, that some teachers do not care too much about the curriculum. They have their own ideas about teaching, and they teach mathematics the way they have always done it. Karin said that the curriculum is filled with beautiful words that are not always easy to put into practice, and this might be one reason for the 'conservation factor'.

8.7 Ann's beliefs

Ann was also an experienced teacher, and she was teaching at the same school where she once was a pupil herself. She had three years of teacher education with focus on mathematics and the natural sciences. For 17 years she had been teaching mathematics at the lower secondary school where she was now. She had many ideas about teaching, and she was open towards new ideas. At the time we visited her class, which was a group of pupils from grade 9, she had a rather stressful time. She had struggled with the discipline in her class, and for a period of time she had been supervising four student teachers. Because of this she was now exhausted, and she felt that she had much catching up to do in her class. These were reasons why we chose to focus more on Karin and less on Ann than we had initially planned.

8.7.1 Practice theories

Contrary to Karin, Ann was in favour of connecting school mathematics with everyday life, she told us in the interview. She did, however, experience difficulties in doing this in her class. She encountered many practical and organisational problems, often linked to pupils' bad behaviour, and she had a strong feeling of not being successful in implementing the ideas in her teaching. When asked what she thought about connecting school mathematics with everyday life, she responded:

No, well that is the very problem: to manage to connect the mathematics with their everyday lives. I believe so. I get this question very often. Why do we have to learn this? What is the point? So, that's where the challenge lies. No, when it comes to me, I am probably not good enough at this at all, to connect with that. Because I am too bound by the textbook that is! Just like that. I have no problems admitting that. But again, the final exam is what directs me (Teacher interview).

Ann was in favour of the idea, she told us, but the struggles and demands that she encountered in her daily life as a teacher made it difficult for her to carry it through.

"I have a good feeling for introducing the parents."

When asked specifically how she believed this connection could be made, she suggested introducing the parents into the classroom, and having them reveal for the pupils in what ways they use mathematics in their vocational lives. Ann was also in favour of

the idea behind the mathematics day, which they had just had in their school. On such occasions it could also be possible to invite the parents. It is difficult for a teacher to know how much mathematics is used and needed in other vocations, she said.

The question of educational philosophy was a hard one for her, but she told us that one of the main ideas behind her philosophy as a teacher was to tickle the pupils' curiosity:

No, first I feel that the kids at least have to see [come up with] the problem formulation for themselves. They have to feel that: This is something I wonder about. And to tickle their curiosity. That is actually no simple matter. But it is almost a prerequisite to learning, that they actually want to find the answer to something. How to do it... It is to take their everyday life into account! Grasp problems they would have. Then you have to explain it to them, and concretise as best as you can (Teacher interview).

It was important for her to start with the pupils' everyday life, and she also emphasised getting into a discussion, a dialogue with the pupils, posing the right questions. To explain things using concrete examples that the pupils were familiar with seemed to be important to her also:

So when I for instance work with fractions and everything like that, I take simple fractions that they can relate to half-litre bottles of coke, they know very well what that is. Use it, so they can see ... and

when they get to these things later, I hope they will be able to bring back the simple examples, and see: yes, one half plus one half, that cannot be two quarters! Because many add both numerator and denominator, because then... No, a half and a half, that is two halves... No, so ... for it is important that the kids get a feeling of success! And that is what makes mathematics such fun, when they feel that things fit together. They also see that it is logical, that it has to be like that! And I also thought when I work with area, many pupils don't understand what area is. And that is why I took up that ... to make them understand what it is (Teacher interview).

These comments support our impression that Ann was concerned with the pupils understanding. She seemed to have intentions of teaching in a way that promoted the pupils' understanding more than teaching them the mere procedures. This also seemed to be a point where she wanted more than she managed to carry out, and in the questionnaire she replied that her pupils would seldom work on problems that helped them understand mathematics.

8.7.2 Content and sources

Karin gave us the impression that the textbook more than the curriculum influenced the way the teachers teach. Ann also brought up this thought, and she pointed to the final exam as an additional source of influence:

No, I have said that I use it [the textbook]. It is what directs/controls my mathematics! And again, the exam at the other end directs me. So I think that if one is to change the teaching a lot, one also has to change the final exam. If that had been done, it is absolutely certain: I would have changed at once! I believe so (Teacher interview).

In another discussion with Ann, she said that she felt dependent on the textbook, and she also believed that this was the case with many teachers. Many teachers of mathematics in Norwegian compulsory education are not mathematicians. They do not have a strong background in mathematics, some hardly any, and not everyone is so interested in the subject either. Some simply try to teach the content of the textbook, and they do this in a rather traditional way. Karin claimed that this was the case for her, but Ann wanted something more. The problem was to know how this could be done. Although she felt dependent on the textbook, Ann replied in the questionnaire that one of the things she believed would make mathematics more interesting for the pupils was if the teacher managed to put away the textbook more often.

Her pupils very often solve many textbook tasks, she replied in the questionnaire, and she felt dependent on the textbook. She would sometimes use other sources than the textbook, but, as was the case with Karin, it was hard to figure out what these other sources might be. From the questionnaire we learn that Ann seldom let the pupils work on open tasks, situations from the media were seldom used, and the pupils were seldom actively involved in the reconstruction of problems from their everyday life. We will have to look closely into the classroom observations to try and discover what these other sources might be.

8.7.3 Activities and organisation

The use of projects is one of the methods of work that L97 is strongly in favour of. Mini-projects are explicitly mentioned in the curriculum as a way of implementing the connection between mathematics and everyday life. When asked about projects, Ann replied:

Yes, very good. But as I said: since I started off this autumn, I have felt that there have been too many projects, and too many loose things. And as I said, in this class, when you do that, everything will float. I am in need of putting things into some kind of system. And when you in a way have got the system and are in control, then you can start loosening up (Teacher interview).

When talking about projects, she meant large projects involving several subjects. And in such projects, she had experienced that mathematics only got a minor part. She therefore found this hard.

“I would probably have emphasised more practical tasks.”

We have seen what Ann thought about the textbook, projects and connecting her teaching to everyday life, and we will now focus on what she thought about organising the classroom activities in groups:

That they can ... discuss and ... help each other and, ... no, there is a lot of learning in that! And then you can both ... that is, and put together pupils that are on the same level. You do that from time to time. And that can become very successful! But you might also put together pupils that you believe might complement one another. And then you have a stronger pupil who can help one who is not so strong. And I believe that both will benefit a lot from it! But again, so ... the pupils must have confidence in each other. I have experienced here that they sit side by side, but they kind of sit and do individual work (Teacher interview).

In the questionnaire she replied that the pupils would sometimes work in groups. Group-work was also an issue that Ann believed in, but she found it difficult to practise. In the classroom observations we will see how she actually organised her class, and how the pupils worked in groups or individually.

An aspect that was brought up by many of the mathematics teachers at the school where Ann and Karin worked was the time aspect. Two teachers claimed that there were so many things the curriculum and the textbook wanted them to go through, that they did not have the time to teach the connection of mathematics with everyday life. They felt this was something they should teach in addition to all the other parts of the curriculum, so they normally abandoned it. Quite a few teachers claimed to be traditional in their teaching, focusing more on teaching the facts and solving lots of tasks, the way they had always done. Ann expressed some different views on this, but she felt that it was hard to carry out. She did not always know how to do it. The daily routines took so much time and energy that it became difficult to achieve the aims of the curriculum.

8.8 Harry's beliefs

Harry was concerned with the connection between the mathematics taught in school and real life.

“So, to conclude, I believe that we teachers lack good ideas of what could be the pupils' everyday life.”

He also thought about this a lot when planning lessons. He was concerned with activating the pupils, because he believed that pupils in activity and interaction would learn more. On one occasion, when there were student teachers in his class, he said:

And then when the student teachers came to me, I told them that you have two legs to stand on: the one is that I don't want to see you at the blackboard! Blackboard is active teacher and passive pupils. Then I said that your main task is to activate the pupils, and make yourselves passive. That kind of scared them (Teacher interview – 2).

His thinking was influenced by the social learning theories of Stieg Mellin-Olsen (cf. Mellin-Olsen, 1977, 1979, 1984, 1991), and Harry's ideas on methods of work in the classroom have been further explained and elaborated in a seven-page brochure called 'Exploratory methods of work' ('Undersøkende arbeidsmåter').

8.8.1 Practice theories

In the questionnaire Harry said that he often emphasised the connection of school mathematics with the pupils' everyday life, but he found the very notion of 'school mathematics' to be troublesome. Harry believed that the pupils often find the mathematics they learn in his classes useful, and that they very often work on problems that help them understand mathematics. Sometimes the pupils' everyday lives were incorporated into the lessons in a special way.

For instance, one year in 10th grade we worked with buying and selling and the interest rate and stuff. And we know that a lot of people buy on credit at IKEA and such. And then we worked with those brochures, and they said that they have 24% interest over 3 months, and we compared this to if they went to a bank and got a loan instead. 20 000 NKR from the bank to buy furniture. And then one of the girl says: "but this is, in a way, completely wrong," she says. Yes, why so? "Because we only buy on credit!" They kind of borrow money, whether it is from Best Buy or whatever... And she said that without kind of knowing what she said then, but ... and I took up this with her in a conversation afterwards, and I said that we should have a talk with your mother. And then we should get this right. So then the pupils' everyday life actually made the teacher interfere and help the family with some financial planning (Teacher interview – 2).

At a meeting with other local teachers of mathematics, a female teacher claimed that mathematics was more mathematical before. Harry disagreed with this statement quite strongly, and it led him to think about what could have been different.

*An elderly female teacher said:
"Before, mathematics was
more mathematical".*

But I used this expression, when I was visiting the upper secondary school, and referred to it and said that it is possible that mathematics consisted of more sums before, harder sums, they were more, and perhaps larger and so. But to say that this is necessarily more mathematical for the pupils; I will deny that quite clearly! (Teacher interview – 1)

He continued to think about these sums, and tried to analyse the mathematics in them.

Before it was much more like 256 times 48, lots of arranged tasks that they were going to calculate. With decimals and so on. But now, there are more of a kind of task that says that ... yes, I mentioned that they were shopping for a birthday party, exactly 200 kroner. They could buy candy bars or chocolates. One candy bar cost 3 kroner, and the chocolates cost 8. Then the question: how many combinations can they manage to buy for exactly 200 kroner? And then one of the pupils says: "But this is what is mathematics, because now we get to use our heads in a way, and we have to think!" (Teacher interview – 1)

Harry encountered some disagreements when proposing to upper secondary school teachers that the calculation techniques were not so important, and, as he described it, there was a rumble in the room. He focused on such tasks, and he often let the pupils make texts and explain them.

“Yes, and I have an impression that in upper secondary school, they don’t test my pupils on what they have been working with.”

The concept of ‘school mathematics’ was quite troublesome for Harry, and he believed that mathematics is something different from what we often find in the classroom.

Yes, well, I believe that the main problem lies exactly in the expression “school mathematics”. Because, I said in a meeting we had here, that there is a big difference between school mathematics and mathematics. Where school mathematics is mainly calculations on a piece of paper, as I see it. What the teachers do, I don’t know, but it is certainly difficult to draw upon the pupils’ everyday lives. Not least because the pupils in a way have a school tradition where they are removed from everyday life ... in school, so the pupils’ everyday life is not a part of school (Teacher interview – 2).

Harry’s vision, he told us, was to create a new school subject called science or technology. Then he wanted to throw away all the old concepts and let the pupils experience the issues in practical exercises. He wanted to build up a room with all kinds of practical materials, and he wanted all the teachers to visit a business, an industrial site, a factory or similar for a couple of weeks, to get real experience with what kind of mathematics they use.

Harry was an innovative teacher with many new ideas and visions, but as he said, he sometimes found it hard to get through to his colleagues. Teachers are often reluctant to try out new things, and schools and school systems are known to change slowly. But he believed that what most teachers need is a good source of ideas, activities, projects, etc., because as of now, the teachers are often too much tied to the textbook.

Yes, because it is strange, really, how much the textbook marks the teachers. It is strange! With such a practical subject that mathematics in reality is (Teacher interview – 2).

Teachers often need a source of ideas beyond the textbook and the teacher’s manual. Harry mentioned this as one of the most important points of focus for a teacher, aiming at making mathematics understandable for the pupils:

- 1) To concretise the problem
- 2) To create curiosity and interest from the pupils
- 3) That I have a source of activities to choose from (The teacher has no capacity of finding these himself) (Questionnaire)

This was also touched upon in the list-questions in the questionnaire, so this seemed to be a point of importance for Harry.

8.8.2 Content and sources

“The textbook cramps the teachers’ style.”

Textbooks are important to many teachers, and their teaching is often based on the textbook. Harry disagreed. He believed that the textbook is cramping the teachers’ style, and he did not use it much. He mainly used it as a source of tasks for the pupils to work on at home. When working with projects and practical themes, he tried to use other sources. When asked if he uses other sources than the textbook, Harry replied that this was very often the case, and already from the

questionnaire we could get an idea of what kind of sources he used. He answered, for instance, that he often used open problems or open tasks. No other teacher in our survey did so. He often used situations from the media, again something no other teacher in the survey did. He did not, on the other hand, let the pupils take part in the formulation of problems from their everyday life much, at least he replied that this was only sometimes done. Our impression is that Harry really did use lots of other sources than the textbook, and we also got an idea about what these sources might be.

Harry turned out to be a rather unique teacher in our study. Unlike nearly all the other teachers he did not use the textbook a lot, and he seldom started off with a focus on solving tasks. We got the impression that Harry was a special teacher in his own school also. He had many ideas, and he was involved in several projects of different kinds.

He said in one of the interviews that he often tried to find material that was connected with real life. If he could not find any such connections, he would search for interesting and motivating problems and tasks for the pupils to work on. As a source for such problems he would use different textbooks, but he would also let the pupils work with problems from their surroundings, like industry and architecture. Unlike many of his colleagues, he also used some computer programs and games, in which the pupils got to practise methods and skills that were connected with both mathematics and technology.

Harry was opposed to relying on the textbook only, and he believed that the textbook would influence the teacher in a negative way. The problem is that the teachers often do not have access to a source of good problems to work on, and Harry also expressed a need for such sources.

8.8.3 Activities and organisation

Harry used a lot of projects in his teaching, or ‘mini-projects’ as he preferred to call them.

And ... I work a lot with those kinds of mini-projects, but I don't follow the ideology of projects a lot, like you are going to write a project plan etc. (Teacher interview – 2)

A large proportion of his teaching was based on working with projects or themes, and this was the way he would often arrange the learning sequences.

Very often, I say that today we will, or for the next two weeks we will work with ... And then I present, call it a plan or an angle of incidence. And then the pupils work on that. But my aim then is that I believe that they will do many mathematical calculations through that. My experience is that the pupils find it interesting. Then there are periods where I don't follow the book much. Like now, we are going to work with the bicycle as a geometrical phenomenon, and with this Pythagoras – so I believe that I get the pupils to work differently. And I force them to relate to mathematics in a completely different way (Teacher interview – 2).

These projects would normally include some practical activity by the pupils. Harry gave many examples from his teaching, and he had lots of ideas. As much as he could, he tried to connect mathematics with everyday life.

But otherwise, for instance with geometry, every time I have worked with that, I have gone to Øvre Tinfoss (a local factory) with the pupils, and then we work with geometry down there, where they measure whatever is necessary to measure. Where they evaluate things, like I did at the college for teacher education. But they are not going to do estimations in a meaningless context! They are not going to count bricks in a wall. But they might estimate the number

“No, I try to draw upon it [everyday life] as much as I can!”

of bricks, and then they estimate the cost. They can look up the price of bricks, so that they can estimate the costs (Teacher interview – 1).

He told us about a similar teaching project he conducted some years ago, which also included a visit to a construction site:

The last time the neighbouring college for teacher education was rebuilt, and that is about five years ago I guess, my pupils and five students (I guess they were third or fourth year students) were up there, and they had two lessons, an hour and a half up there where they should note everything mathematical and science related. It could be about sizes, shapes, speed, acceleration; everything with measurement and weight and density that they could find. They didn't get any measuring instruments, and the point was that they should use their heads, vision, and the things they could find to measure with. And they made as precise measurements as possible (Teacher interview – 1).

In another project he brought a couple of bicycles into the classroom for the pupils to measure, and draw to a certain scale. Since Harry was also a teacher of natural sciences, he often made connections between these two subjects.

Yes, I gave an example earlier today, where I did some investigations with one of the girls – it was in connection with the geometry they had last year, in grade 8 – how such a tip-x was formed on the inside with two cogwheels, and the gear relation between them. And then we tried how many times the one rotated for the two marks to meet again and likewise. And then I asked the girl: “what might be the reason that the cogwheels don't have the same size?” And then we had a quiet and calm situation, so I got a very good discussion with her about that. So, it doesn't have so much to do with the pupils' everyday lives, but it has to do with technology. So, I believe that the pupils' everyday life is very seldom incorporated into school mathematics. But I believe that the teachers use it when they come up with it. And some also have really good examples (Teacher interview – 2).

We often hear that learning must be directed towards the learner, the pupil, and this is a process of active rather than passive transfer of knowledge. Harry believed that the pupils should be given at least one experience each day, an experience that could be physical, mental, intellectual, or subject-matter related. These could be experiences of using their own creativity, like in this activity:

For example in geometry – you can see that afterwards – I hand out a quadratic piece of paper, and I tell them to make a pattern. You can use a pair of compasses and colours. Basically nothing – a pair of compasses, a ruler and colours – basically nothing else. And it is with such open tasks that the pupils have complete freedom to do what they are going to do (Teacher interview – 2).

After the interview he showed us some examples from papers the pupils had handed in. There were many beautiful patterns, colourful and using different geometric figures, symmetry, etc.

8.9 Into the classrooms

We have now presented the findings from the interviews. When comparing the results of the questionnaires with the interviews, we find that there is a consistency between the answers. We therefore suggest that the teachers' replies were honest, and that they not only told us what they believed we would like to hear, which is always a possibility in such situations.

We have been able to uncover some ideas and beliefs of these teachers, and we have at least tried to capture their interpretations of the curriculum. Although we have studied only a small sample of

Norwegian teachers, we find it probable that some of these ideas are also present with other teachers.

So much for beliefs and opinions, now we will move into the classrooms, to see how the teachers actually teach, and try to find some of the strategies and teaching methods they actually use to reach their aims.

The teaching philosophy of any teacher consists of an explicit teaching philosophy that is professed, and an implicit teaching philosophy that is acted out (Freudenthal, 1971). We have made an attempt to elaborate on the explicit philosophy, which we might call the teachers' beliefs. We believe that beliefs and actions belong together as part of the same picture, in the same way that explicit and implicit philosophy are both part of the teachers' teaching philosophy. Now we will look more closely into what our teachers actually did in the classroom.

8.10 Harry's teaching

We have studied transcripts from five of Harry's lessons. The first two of these contained the same activities in two different classes. In addition to the transcripts, we have the data material from the field-notes. We have collected data from 22 of Harry's lessons altogether. In the subchapters below we have chosen four typical lessons for further analysis. The first one is only covered in the field-notes.

8.10.1 Fibonacci numbers

For the first couple of lessons we spent with Harry and his two classes, Harry brought his classes to the library, which also served as a computer room. They were asked to search the internet for information about Fibonacci numbers and the Golden Proportion. Harry had already checked out some sites, and he gave them hints on where to look. They found sites that showed how these numbers occur in nature, in art, in the human body, in commercials, etc. In our coding scheme, this activity would be coded RLNP-OS-IW. It was a real-life connection in a non-problem setting. Other sources than the textbook were used, in this case the internet, and the pupils mainly worked individually.

When working on a task like this, it is natural that some pupils are more focused than others. We observed that the teacher walked around and encouraged the pupils, asked questions, provided them with ideas, pushed them forwards. Some pupils lost their concentration in periods. After the session in the computer room, the teacher brought up some issues they had seen on the net in a discussion with the entire class. He did this to make sure that all the pupils learned something about mathematics from the session.

Harry told me after the lesson that he seldom used the internet, because it contains so much information and it is hard to find good sites. He had therefore made some preparations and found some good sites that contained correct information. The reason that he used the internet for this activity was also for the pupils to get the opportunity to practise using a computer as a tool in the learning process. These are important remarks, and it was interesting to observe how Harry brought up the discussion again when they were back in the classroom. By doing this, he made sure the activity was not only an individual activity, with its limitations, but a collective learning experience.

Our curriculum calls for the use of computer technology, and mathematics is a subject where this kind of technology could be incorporated. In these lessons the pupils could see many examples of how Fibonacci numbers and the Golden Proportion appear in nature, art, etc. The lessons were also

a good example of the use of other sources when connecting with real life. We believe that it was wise of Harry to bring the important issues up again in a discussion with the entire class when they returned to their ordinary classroom. In this way he could explain things to the pupils and make sure everyone had received the most important information. Some of the web pages showed results of research on Fibonacci numbers and the Golden Proportion, and many of these results were connected with real life. When the pupils surfed through these pages on their own, however, the impression some pupils got was that mathematicians waste their time with some stupid things. It was therefore important for the teacher to follow up, engage in discussions with the pupils, bring up important issues later, etc. Such a lesson could easily become no more than a pleasant break from the normal classroom routines. Harry explained that his goal for the lesson was for the pupils to get some practice in using the internet, but the mathematical content would have to be brought up again and worked on further when they returned to the classroom.

Why would anyone bother counting the seeds in a sunflower?

As far as the real-life connections are concerned, these lessons showed some interesting examples on how mathematics could be connected with real life, but the examples or applications would not be of much practical influence or use for the pupils. The connections did not affect their own everyday life much, and the examples were mostly interesting because of their peculiar nature. “Why would anyone bother counting the seeds in a sunflower?” could have become a main question from the lessons. The real-life connection here is also an example of an application rather than starting with a situation from real life and using this to recreate or discover some mathematics. The examples from the internet pages could have been used as starting points for problem solving tasks or discovery tasks for the pupils, but this could easily take a lot of time, and the outcome would also be uncertain.

8.10.2 Pythagoras’ theorem

Pythagoras’ theorem is one of the mathematical theorems most frequently taught in Norwegian schools. If there is one mathematical theory that people would remember from their school days, this theorem would most likely be among those. When we visited Harry’s classes they were working with geometry, and, naturally, the famous theorem of Pythagoras was being taught.

These activities were actually taking part in several lessons, but we have regarded it as one activity here. The first part of the activity is only covered from the field-notes, the last also from transcripts. When teaching Pythagoras, Harry presented the pupils with a piece of paper with some figures and instructions. From this paper they cut out some triangles and quadrangles (see illustration below). By putting these together in the correct way, the pupils re-discovered Pythagoras’ theorem. On the paper were instructions for what to do, and the pupils followed them individually, cutting and pasting into their workbooks. They wrote a description, in their own words, of what they had done and what they had found out. Their work was meant to result in a sentence that was going to be as clear and mathematically correct as possible. In the introduction to this activity, Harry gave some comments from history and real life. The main activity could be coded RLNP-OS-R/GR. Thereby Harry introduced us to a way of letting the pupils take part in the reinvention of a mathematical theory. This is also recommended in the curriculum, and in the questionnaire, Harry claimed he emphasised this very often in his teaching.

When the pupils had finished this activity, Harry presented something on the blackboard that he called ‘carpenter knowledge’. He drew figures and showed how carpenters can make right angles without a protractor. He used the knowledge the pupils had just recreated about the squares (Pythagoras) to explain why this was correct.

This sequence is a good example of guided reinvention. The pupils worked with a kind of puzzle, and with some help from the teacher they came up with the sentence that is known as Pythagoras theorem. During this work, the pupils also got practice in the proper use of mathematical concepts, and they got to see how this theory could be used in practice to explain the carpenter-knowledge. In the next lesson they worked in the woodwork room. Here they made right angles and rectangles and used their knowledge in a practical way.

Although this is an example of guided reinvention, and some connections to real life were made, there are several things to discuss. The starting point of the activity was not a real life situation or context, but the activity involved participation and practical considerations from the pupils. The pupils were allowed to cut out figures, try to make them fit together like a puzzle, and they were engaged in activities that can be regarded as typical activities in mathematical problem solving. These are activities that mathematicians would often be involved in. Harry made several comments that were connected with real life, but the activity itself can not really be defined as a real-life connection.

Pythagoras was a theme for several lessons, and Harry brought his classes to the woodwork room to let them use their knowledge of Pythagoras in a practical project. We will look at the introduction to one of these woodwork-lessons. We let Harry speak:

But the point now, is that ... I work with the aim that you should understand mathematics, and discover the things behind what we are working with. Look here! I showed you this carpenter knowledge, where they measured 80 centimetres there, then 60 centimetres here, and if that was – they could adjust it so that it became exactly 1 metre. Then the carpenter would know that it was 90 degrees. And the point now is that you will work like that to get 90-degree angles. And listen, I'm telling you now to use millimetre precision! (...) And the point is, if Hugh is going to attach his to Nigel's, and that one is a bit crooked, then we have a problem. So I think a little about the aesthetics. Now that I am going to make rectangles and such (...) And then we will attach them together and make a class product (Transcriptions 120503).

Harry made a comment here in the beginning, where he brought this carpenter knowledge up again. This comment provided a connection with real life. It was authentic in the way that the issues he presented could have been used by carpenters in their work. For the rest of this lesson, the pupils worked practically with these ideas. Harry made several comments that were connected with real life, but most of them were of a technical matter, concerning their work.

The pupils produced right angles and rectangles with sticks and pieces of wood. They cut the sticks to the right measurements and glued them together in the right places, so that the angles should be 90 degrees. They discussed how long each side could be, and some of the pupils discovered that the two sticks could be any length; you just have to calculate the hypotenuse. Some practical issues also

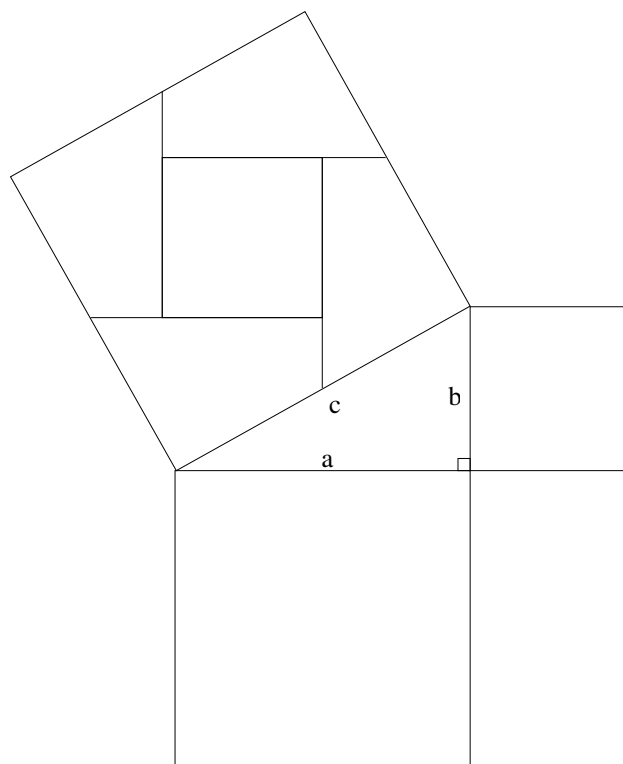

Illustration 22 This figure was used in the activity of re-inventing Pythagoras' theorem

came up, like cutting the sticks a bit too long on each end, and they found out that it did matter how the pieces were attached for the angle to get right.

It was important to Harry that the pupils enjoyed this kind of activities. In one of the discussions we had, he told us about a girl in his class who had been absent when they made these right angles in the handicraft room. The next day she had come up to him and said that she heard what they had done the day before, and she said that this sounded fun. Harry had a feeling that the pupils enjoyed the mini-projects and activities he presented to them.

8.10.3 Science magazine

EKSPERTNØTTEN

Klodenes kamp

En stor globus med en radius på 90 cm og en mindre måneglobus med en radius på 40 cm har falt på gulvet der de har trillet sammen i et hjørne. Hvor langt er det mellom klodenes berøringspunkter på gulvteppet, kalt A og B på tegningen ovenfor?

Send oss svaret slik at vi har det senest onsdag 19. mars. Lykke til!

Illustration 23 This illustration is from the Norwegian science magazine 'Illustrert Vitenskap'

When working with triangles and Pythagoras, Harry introduced some problems from a Norwegian magazine called 'Illustrert Vitenskap' (Illustrated Science). This monthly science magazine presents some mathematical problems each month, and Harry used some from the latest issue in a couple of lessons. He showed the pupils how these problems could be simplified and easily solved if you draw the right helping lines. The pupils were then asked to draw the figure to a certain scale. We let Harry introduce the lesson:

Today and tomorrow, you will work with some problems from a magazine called 'Illustrert Vitenskap'. I have brought some problems from that, and each month they present a page with some tasks to ponder over. You have also worked before with some of them that I have handed out. And now we will work with the expert problem from last month, I believe it was last month. And then we will see that those tasks are actually quite easy to solve, if we can draw some more lines than those on the figure. The problem is that there are two balls that are lying close to one another on a floor. So they lie close to another. And this is what you will draw, but you can wait a bit. So, look here before you start. (...) Now you get one task, and that is to draw this in a reasonable scale (Transcriptions 060503).

And so he continued, presenting the problem and discussing it with the pupils. The pupils could use their knowledge about triangles of 30, 60 and 90 degrees.

Harry: 90, 60 and 30. Why so? ... (repeats) Can you give any reasons for it?

Pupil: Because it is half of an equilateral triangle, no...

Harry: Yes, it is. But how do you see that it is half of an equilateral triangle?

Pupil: Because if you put it the other way, then ... yes.

(...)

Harry: Yes, you are on the right track. But you got this one little piece of information here, that the hypotenuse is two times the leg. You have been working with this in several tasks. But then you have been given this information about the angles. At the same time I remove this information about the angles, then in a way you are not able to connect this knowledge that you have ... As long as the hypotenuse is double the size of the leg, the angles are 30, 60 and 90. Always!

Harry also addressed the issue of transfer here. The pupils should have the knowledge about these triangles, but they were used to problems where the information about the angles being 30, 60 and 90 degrees is always presented. When the problem formulation was slightly different, they did not manage to make a connection.

The pupils also solved some other problems from the science magazine in another lesson. This first problem could be coded as a real-life problem, although being somewhat artificial, while some of the others were purely mathematical. Although the context provided had some connection with real life, the solution of the problem was purely mathematical. The problem context merely served as a wrapping for a mathematical problem in this case. One could also regard it as a real-life connection here that the problems were collected from a familiar science magazine. This was a source of motivation for the pupils, who worked devotedly on these problems.

This lesson was similar to some Japanese lessons, at least as far as methods are concerned. The pupils worked with one problem for the entire lesson, and we could code it RLC-OS-IW/TAWC. (We have already looked at some examples from Japan in chapter 3.4.) The other source, which in this case was a science magazine, could also be called an example from the teacher's everyday life, but we chose to code it OS nevertheless. In this lesson the pupils were asked to write their own presentation of the answer. However, the solution methods to be used were mainly presented by the teacher.

8.10.4 Bicycle assignment

The bicycle assignment was the last activity we followed in Harry's class. In this mini-project, Harry asked some of the pupils to bring along their bicycles to class.

When you are now going to work with the bicycle assignment, you are going to draw the bicycle on the scale of 1:5. You are going to collect as accurate measurements and angles as possible! And I just said: draw a sketch today, a rough draft! So that you can sit down later and make an accurate drawing. And then you will pick out as many geometrical shapes as possible (Transcriptions 130503).

Harry spent some time introducing this assignment, before he let the pupils start measuring the bikes. In the introduction he talked about several issues related to real-life, such as how the digital speedometer worked, the brake, etc. The pupils decided for themselves whether they wanted to cooperate or not, and some pupils worked outside in the school yard.

One of the first practical issues that came up was how large they should make the sketch for the drawing to fit into the page.

Harry: Yes. Perhaps we should say something about how big this bicycle will be. Is there room for you to draw it on a page?

Pupil: No!

Harry: If it is 1 metre high, how big will it be in your book then?

Pupil: 5, 50, no 5 centimetres.

Harry: Remember to draw on a scale of 1:5.

Pupil: I don't have a clue. 5, 15, something else, 5 then! I haven't got a clue! Asking me about these things...

Harry: No. No. Do you follow, Sandra? If that one is 1 metre high, if we say that the bicycle is 1 metre high now. How high will it be in the book then?

Pupil: Yes of course. You just divide by 5!

Harry: Yes, of course.

Pupil: But I don't know what that is. Fourteen.

Harry: 20 centimetres (Transcriptions 130503).

Many issues came up and the pupils got several opportunities to discuss different mathematical concepts in natural and realistic contexts. They also got the opportunity to measure different geometrical objects in practice, using measuring instruments like the slide calliper. Harry was also a teacher of natural science, and he used the opportunities to go into discussions about technological and physical issues concerning the bicycle. In these discussions we saw examples of many RLNP comments and discussions between Harry and the class, or between Harry and individual pupils. An example of this is:

Harry: For instance – you are going to find as many geometrical figures as possible – and for instance, I would have included the length of that [the pedal]. Yes, so you must write the length of it. But why is it necessary to include the length of it, why is that a point?

Pupil: Yes, because you must see how much force ... no, I don't know.

Harry: Yes, you are on the right track. If it were shorter, what would it be like to cycle then?

Pupil: Hard.

On a couple of occasions one of the pupils came up to Harry and asked about some technical issues regarding the bicycle, like: "How come the pedals have that exact length?" Then they would get into an interesting discussion on this. These were not purely mathematical questions, but they had to do with technology. There could also be questions on measuring, sizes, lengths, also involving other geometrical phenomena.

All in all, the activity has been coded RLC-OS-P, and it is a good example of Harry's many mini-projects. It could of course be discussed whether this was a problem situation, but we have chosen to call it that, since it was part of a task or project that the pupils worked with. The lesson is a good example of how a real-life context can be used to facilitate different kinds of activities in which mathematical knowledge is involved or derived. The real-life connection or context in this example is the starting point rather than the application, and this activity meets the demands of the curriculum in this respect.

We have seen four examples from Harry's teaching, and interestingly enough all of them contain the use of other sources than the textbook. In 21 of the 22 lessons we observed in Harry's classes the main activity involved work with other sources than the textbook. This strongly supports the beliefs that became evident in the questionnaire. Harry replied that he very often used other sources than the textbook, and that he seldom focused on solving textbook tasks in his classes. It should also be mentioned that Harry himself claimed that his pupils solved many problems from the textbooks, but they mainly did this for homework. Other activities and mini-projects were emphasised in the lessons.

8.11 Ann's teaching

Because of practical issues that came up, we could only follow four of Ann's lessons in their entirety. Two lessons have been transcribed, and we will focus mostly on these two here. We will also give a couple of other examples from her teaching. When we came to the school three student teachers were visiting Ann's class, which was the case during the whole of the first week of our stay. In the following weeks there was a teachers' strike, and tests and other things also came up. There was also a mathematics day for all the 9th grade pupils, including Ann's class. To get the best data material possible in this situation, we had several discussions with Ann in addition to the classroom observations, the questionnaire and the interview.

8.11.1 Construction of 60 degrees

Ann's class was working with geometry when we were visiting, and the theme was the construction of angles. In one of the lessons the class focused especially on the construction of 60-degree angles, and she introduced this topic in a discussion with the class. While doing this she was constantly drawing upon their comments and knowledge.

Ann: Everybody look up here, please! Everybody! How do you construct 60 degrees? ... Annie knows. Does anybody else know? Yes, most of you should know it by now. Annie, how do you do it?

Annie: You start with a circle, and then...

Ann: Did you hear what she said? Why is it that you start with a circle?

Mike: That's the way it is.

Ann: That's just the way it is... But it is completely right! I think that it is, when I have made a centre in the circle, kind of. And then I start making a circle. And I can make this circle as big as I want to, but I start on a circle. Yes, and then?

Annie: Then you have the same opening, and place it where you started...

Ann: Use the same, that is: I use the radius and mark it on the arc of the circle, that opening. You are certain it will become 60 degrees. How come?

All along Ann tried to challenge the pupils, ask them questions and guide them on their path towards discovery. The pupils had difficulties explaining the construction of the 60-degree angle, but Ann would not give the answer until they had discovered it for themselves.

Ann: Yes. That opening there, it is 60 degrees. How much is the entire circle?

Mike: 360.

Ann: Yes, 360. Michael, how many times do you think I can mark this around [the circle]?

Mike: Many...

Ann: There is 60 (draws). Do you agree that this is 60?

Mike: Mmm.

Ann: Do you see? How many times can I mark it then?

Annie: Six times.

The pupils then followed the idea that the radius divides the circle in six equal parts along the circumference, and they therefore got 60 degrees using their method. This has elements of discovery learning, or guided reinvention. The teacher leads the pupils towards an understanding by asking them these Socratic-like questions, and the pupils are thus actively involved in the reconstruction of this knowledge.

This is much like what we might call discovery learning.

This example does not include much reference to everyday or real life, but it is a good example of how a teacher made use of the pupils' knowledge and led the pupils towards a better understanding. Many topics that are taught in mathematics cannot easily be connected with real life. The curriculum does not suggest always doing this either, but the principles of learning through discovery and building upon the already existing knowledge of the pupils can be followed nevertheless.

8.11.2 Area of figures

In one of the lessons a piece of paper with different geometric figures was presented. Some were ordinary rectangles and triangles, while other figures were more unusual geometric figures, like a large T. In all these figures, a square net was inscribed. The pupils were told to pair up and find the areas of these figures. There were different ways of solving them, and they were supposed to discuss these. One of the pupils asked in the beginning if they had to measure. Ann replied that they should decide what to do for themselves. After a few minutes, they discussed the solutions in class. In this discussion, a lot of real-life connections appeared, both from the teacher and the pupils.

Ann: But, ...eh, you can buy boxes of mineral water, right? (the teacher draws on the blackboard) One, two, three, four, five... Imagine you're having a birthday party, and you buy mineral water. Eh, and you buy a box, and you are to count the number of bottles in the box, how would you do that? Put your hands up.

Pupil: You count the vertical row and the horizontal.

Ann: Are there other ways of doing it?

Pupil: Look at the receipt, and see the number that is printed there.

Ann: Yes, ... the receipt says so? But, as we heard before, instead of counting them all, you can count the vertical row and the horizontal. And then you could say that the area of this box of mineral water is actually 24 bottles then!

Ann commented on how this method could also be used to calculate the area of a room, but that it was easier if everyone used the same label. It would be troublesome if someone should enter a building shop and ask for a floor covering of 670 bottles.

This activity resulted in some fruitful discussions, but many of the pupils showed that they were bound by the textbook's way of solving area problems. There is one real-life connection in this example that we will take a closer look at: the birthday-party comment. We noticed how Ann tried to guide the pupils towards new knowledge, and she was building upon their existing knowledge. Many pupils think of areas as a formula where you multiply the length by the width and get an answer. Here Ann made a connection with the pupils existing knowledge about how to quickly calculate the number of bottles in a box and the mathematical notion of area. One pupil suggested counting the vertical and horizontal rows of bottles and multiply them. Ann then challenged them to use the same approach when calculating the area of a room, by thinking of the floor covered with bottles. In the other tasks there were also several ways of finding the areas. One could simply count the squares in the net, or one could use some kind of formula. When discussing the solutions she always let the pupils discuss and decide what methods or algorithms to use and why. The real-life connection in this example became a starting point for a discussion, and it ended up in a mathematical formula, rather than being just an application of a formula.

The real-life connection became a starting point for a discussion.

8.11.3 Size of an angle

In a lesson introducing geometry and angles, Ann showed the class a piece of ordinary paper, asking: "What geometrical figure is this?" One of the pupils recognised that it was a rectangle, and then she continued to ask how we could identify a rectangle. Using this example of a practical and everyday item, Ann introduced many geometrical concepts in a discussion with the pupils. When talking about right angles, she also gave a real-life example using a famous Norwegian mountain formation called 'Prekestolen'. This has the shape of a right angle, formed by the plateau and the cliff falling several hundred metres down into the fjord. In this example she did not use the real-life connection as anything else than a comment, unlike the example above.

Further out in the lesson, she introduced another piece of paper, cut as a triangle. She ripped off the corners of this figure and put them next to each other, to show in practice how the angles of the corners added up to 180 degrees, or a straight line. She did this in a continuous discussion with the pupils, rarely presenting the mathematical facts, but rather asking the pupils questions. An example of this was when they talked about the sum of angles in different geometrical figures (from the Field Notes 130203):

Ann: What is the sum of the angles in the quadrangle?

Pupil: 360.

Ann: What about the pentagon then?

Pupil: 360?

Ann: How much is the sum of the angles in the triangle then?

Pupil: 180.

Pupil: Then it will become 540!

Ann: Do you think so?

Pupil: Yes, that is it.

Ann: Yes... Do you agree? (to the entire class)

Pupils: Yes.

(teacher draws another triangle next to the quadrangle, to get a hexagon)

Ann: What about this?

Pupil: ... 720.

This is a typical example of how Ann often taught: asking the pupils a series of questions, ending up with the theories based on the pupils' answers instead of presenting it herself.

One could argue whether this example, where she showed an actual paper triangle, consists of a real-life connection. It does, however, include the use of concrete material. A simple piece of paper is used here in order to demonstrate some geometrical properties for the pupils.

8.11.4 Blackboard teaching

In one of the lessons, the pupils wanted Ann to go through one of the problems they had worked with at home. This was a quite complex construction problem, where they had to draw a helping figure in order to keep track of all the information. During the presentation of this problem, one of the pupils commented that they had to learn this if training to become carpenters. This was only a comment between two pupils and was not noticed by the teacher, who only presented this as a geometry task. Since it was a complex and hard problem, Ann spent almost the entire lesson explaining it to the class. The pupils seemed to get only more confused. After the lesson Ann told me that she had a bad feeling about it. She believed that there had been too much blackboard teaching, and the pupils seemed to be only more confused at the end of the lesson. This was also discussed in the interview we had the same day.

This construction problem, which was quite complex, had the potential of constituting a real-life connection, but this possibility was never taken advantage of. Such a difficult and complex problem could be too hard for some pupils. It could perhaps have been motivating for the pupils if the

problem context had been talked about and elaborated on. Some pupils are motivated to solve any problems just because the teacher tells them to, while other pupils continuously ask themselves why they have to do it and what use they will ever have for learning it. For the latter group of pupils a discussion about the problem context and the considerations involved could be motivating. Such discussions could also help the pupils to become aware of the applications of the mathematical algorithms and theories and how they are connected with real life.

8.12 Mathematics day

Many Norwegian schools have arranged a so-called ‘mathematics day’. This is normally a day or half a day where the pupils spend their time on a certain set of mathematics related activities. School 3 had a mathematics day during our study and we observed the activities. We will take some time to describe the activities of this day, and we will also discuss how such a day might be used.

The teachers decided to let both classes in 9th grade take part in this mathematics day. The activities lasted for an entire school day of six 45-minute lessons. In the preparation for this day, the teachers had discussed the organisation of the day, and they decided to prepare six different activities at six stations. The pupils were divided into six groups and each group worked with each activity for one lesson. Some teachers, like Ann, wanted to let the pupils work more extensively with each activity and rather have fewer activities, but the final decision was to have six smaller activities.

We followed two groups during the day, and we thus got the opportunity to experience almost all the activities. In the morning we started off in the library. The group that started off there worked with problem solving. They got a piece of paper with different problems to solve. Some of these problems were quite normal textbook tasks, while some were more open problems. One was about percentages, where a certain item had a certain price. The question was: in what way do you get the best price, if you add 10% and then get a 10% discount? Or if you first get a 10% discount and then add 10%? Or do you get the best price if you never change the price at all? Another problem was to cut out a certain puzzle and rearrange the pieces to get a square. This was the most time consuming problem for the groups, and they enjoyed this puzzle work.

The next station was in the computer room. Here the pupils were supposed to solve two tasks individually, using the spreadsheet program in Windows. The first exercise was to set up a formula to calculate some money-related problems. In the next exercise they were going to use spreadsheets to find sides in a triangle with Pythagoras’ theorem. The idea was to create a table where they could insert the length of the legs in a right-angled triangle. The formula they had made in the spreadsheet program would then automatically calculate the hypotenuse. At this station we observed how pupils who were normally regarded weak in mathematics would blossom behind the computer.

The third station was in the handicraft room. Here they got a practical task or problem to solve. A pile of bamboo sticks and a pile of rubber bands were provided. The group was asked to construct a bridge using these aids. This bridge was going to be at least 2 metres long and it should carry a weight of 1.5 kg. Before they started, the teacher showed them how they could attach the sticks in the corners with rubber bands, and he showed them how triangular units were more stable than quadrangular. Both groups we followed ended up making some pyramid units, which they attached in the corners to build a bridge-like construction. Ideally the pupils should have been able to spend some more time on a task like this to test it out, think out other ways of constructing solid bridges, etc., but since they only had a limited amount of time the teacher gave them several hints. Afterwards, the teacher told me that they had carried out a similar project some years ago, but then the entire class had worked on the bridge for an entire school day,

They were going to build a bridge of bamboo sticks.

making it into a competition between the different classes. This would probably make it a more realistic problem-solving task, and the pupils are normally motivated when a competitive aspect is introduced. The pupils made several mathematical considerations, although they were probably not aware of these as being mathematics, and they worked actively with geometrical shapes. The mathematical ideas could easily become hidden in this task. If the teachers do not address such issues in a follow-up discussion, the mathematical ideas can still remain hidden for the pupils.

The following station was related to physics. The aim was for the pupils to measure speed, using the formula: $s = v \cdot t$ (speed equals velocity multiplied with time). The group went down to the main road, where the teacher already had measured a distance of 200 metres and a distance of 300 metres on both sides of a footbridge. They then divided the group into four units. Two units were standing on the bridge, measuring time with a stopwatch. The other two groups stood along the road on both sides of the bridge, one group 200 metres up the road, and the other group 300 metres down the road. Each time a car passed either of these groups they would give a sign, and the pupils standing on a bridge would start their clocks. When the car passed under the bridge, they would stop their clocks and note down the time on a piece of paper. When the groups had noted down the times for about ten vehicles each, they went back to the classroom. In the classroom they used the formula and pocket calculators to find the speed of the cars. Because they only had a limited amount of time for this activity also, they did not find out how to calculate the speed on their own, but they simply followed the formula. Speed is a physical entity that is a natural part of everyday life, and the relationship between speed, distance and time is an interesting one for the pupils to discover and work with. This real-life connection could provide a natural starting point for mathematical activities and discovery learning, but our group was not given this opportunity because of the lack of time.

At the penultimate station the task was to plan the decoration of a room. They were given a paper with the relevant data: the measurements of the room, the number and size of windows and doors, etc. The room was going to be painted and the floor covered. The teachers had collected colour samples of paint and samples of floor coverings from shops. The pupils then had to find out how much paint and floor covering they needed, and they had to calculate the costs. The pupils worked on this task towards the end of the day, and they were starting to lose their concentration. This was an interesting task, at least in our view, but it could perhaps have been even more interesting if the pupils themselves had to collect the data, find samples and prices in different shops and work on it as a more extensive project. The real-life connection is the starting point for mathematical activities, and the mathematical content is a natural part of it. This is consistent with the demands of L97, and the context is part of the pupils' future everyday life.

At the final station the pupils watched a video. Because this station did not involve any pupil activity, we chose to follow a second group at the bridge-constructing project instead.

All in all this day consisted of many tasks and activities with real-life connections. Some of the activities were more like extensions of more traditional classroom activities or problems, while others were more like mini-projects. This day also raised several questions, and it provided ideas for activities and kinds of activities that could be extended. It surprised us that the teachers had not made any plans when it came to incorporating the activities of this day in the total plan for mathematics in the school year. Ann told us that she would not regard the issues worked on during this day as completed topics, but rather believed that she would have to introduce them again in the classroom to make sure the pupils got the point. The mathematics teachers had thought of this day as no more than a break from the normal classroom activities, and none of them had planned the activities as an extension or continuation of their everyday activities in mathematics. Such a day could provide opportunities for interesting projects and work that would have been impossible to carry out in ordinary lessons. The teachers had to organise this day in addition to all the things they

would normally do in the classroom. One result was therefore that the teachers would get less time to cover all the issues of the curriculum.

Ann discussed the choice of many smaller activities as opposed to a few larger ones. Ann was initially more in favour of only a few larger activities, but afterwards she felt that the choice of several smaller activities was also wise. This day was seen more as an experiment, and in many ways it was also a break from the normal activities in class. Therefore she believed that it was a good thing for the pupils to get to try out several different activities. We also discussed how such a day could be incorporated in the total image of activities and work that the pupils did during the school year. She believed that a mathematics day should be incorporated in a better way, but she was not sure that she would regard the issues worked on here as finished. The reason for this was that she felt a strong obligation to go through all the elements of the syllabus, and she was not sure that all the pupils had understood what they had worked with during the day. Ann was in favour of arranging such a mathematics day though, and she told us later in an interview that she believed that such a day was a good tool for making mathematics more interesting and connected with real life for the pupils.

8.13 Karin's teaching

Karin was mostly negative towards connecting school mathematics with everyday life, and she expressed these beliefs both in the questionnaire and in the interview. Visiting her classroom gave us the impression that this was true. We have chosen some teaching sequences from Karin's class to exemplify her teaching. We visited 11 lessons in Karin's class altogether. Two of these have been transcribed, and we will analyse these two lessons in addition to some other examples from the field notes on Karin's teaching.

8.13.1 Lazy mathematicians

Karin was good at coming up with funny stories, wrappings and presentations that make the pupils laugh. In one lesson she explained to the pupils how mathematicians are lazy:

Karin: This is how a writer would have written it (writes on the blackboard: "one monkey plus one monkey equals two monkeys"). This is what a writer might have written. But a journalist might have written it like this: (writes: "one ape + one ape = two apes"). Or he might have written like this: (writes: "ape + ape = 2 apes"). A mathematician doesn't bother writing the entire word, so he writes...

Pupils: A!!! (almost all the pupils shout)

Karin: (writes: " $a + a = 2a$ ") (Field Notes, school 3).

In this way Karin used connections with everyday life as wrappings for explanations of mathematical theories. The connection with everyday life (in this case: monkeys) became irrelevant to the topic. It could have been anything, and it mainly served as fun names for mathematical notions. In another lesson she used the same method to introduce invisible multiplication signs, and this time it was about horses:

Karin: (writes on the blackboard: $4 + 4 + 4$) What ... there it says $4 + 4 + 4$, right? How can we write that in another way? E?

Pupil: 4 times 3

Karin: 4 times 3, or? If I wanted to take the other way round, then I would take?

Pupil: 3 times 4.

Karin: Yes, but that is the same answer. But can you imagine why I would now have 3 times 4, E?

Pupil: Yes, because there are three 4-s.

Karin: Yes. There are three 4-s, so it will be very close to our [everyday] language to say three 4-s. Eh, if I now write horse + horse + horse...

Pupil: Three times horse!

Karin: Yes. Three times horse, yes. That's a suggestion.

Pupil: Three times h!

Karin: But what do we often do in language?

Pupil: Three times h!

Karin: Do we say three times horse?

Pupil: THREE TIMES H!

Teacher: What do we say?

Pupil: Three times h!

Karin: Yes, now we are mathematicians, but I think ... Three horses, we say, yes! Do you agree that when we use our language, when counting things, we don't use "times". But one could have used it. Three horses equal three times one horse. Right? So, we cut the multiplication sign. Could we have done that up here? Could we have cut the multiplication sign up here? ... Three-four.

Here Karin used a kind of real life connection, in the example. First she introduced the relationship between multiplication and repeated addition, and then she provided a follow-up example with the repeated addition of horses. This way of using real-life connections seemed artificial. It did not have anything to do with the horses, as we could see in the following:

Pupil: Are we going to write that with the three horses?

Karin: No. Example 1 ... Now, I will tell you what to write. This is a mathematics lesson, so we skip horses, and stick simply to h-s. And we can write 4 times, no: 4h is the same as 4 times h, in mathematics.

Karin here used horses to replace numbers, but the connection to real life made by introducing horses was not important. The horses were merely disguises for mathematical symbols and signs, and she used the example to introduce invisible signs.

The use of artificial real-life connections is also commented on by other researchers (cf. Foong & Koay, 1998), and we could call these ‘faked real-world problems’, or rather fake real-life connections, since they are more connections than problems. The ‘realistic’ context mainly serves as a wrapping for the mathematical theories, and we could see other similar examples of this in Karin’s lessons. We do not claim that this is a wrong strategy per se. It might be motivational for pupils, and it has been used in textbooks all along. They are not real-life connections in the sense that these are presented in the syllabus. L97 presents an approach to real-life connections that involves contexts from the pupils’ present or future everyday life, gaming situations or others. These contexts should be used as starting points for meaningful mathematical activities. The examples we have seen here do not fulfil these demands for real-life connections.

Later in the same lesson she made some comments about the horses, but it became obvious that the use of horses was mainly to make the pupils remember the rule. Horses are possibly easier to remember than h’s (h = horses). This indirectly became evident by something Karin said later in the same lesson, after she had talked about how two minus signs become plus.

Horses are possibly easier to remember than h-s.

Karin: Ok, but the main point here was to show that it is very important to remember that about invisible multiplication signs. Now you will get an extra challenge. (...)

The idea of invisible signs was humorously explained as being caused by laziness on the part of the mathematicians:

Karin: (...) This is about learning to read mathematics. It is a language in a way, right? As I said, it is the language of the lazy man. So, they don’t even bother to write the multiplication sign. And then we have to know that when a 4 is put just outside of a parenthesis, it means that the number 4 is supposed to be multiplied with every number inside! (...)

8.13.2 Grandma’s buttons

The example with grandma’s buttons occurred in another lesson. The idea was quite similar to the previous, only this time it was elaborated more:

Karin: When my grandmother died, they found two drawers filled with paper clips, safety pins, buttons and pins. (Then she tells about the administration of her late grandmother’s estate.) (She writes down an account of the buttons, pins etc.:

$$\begin{aligned} \text{Eks.3 } & (75b + 55s + 275k) + (25b + 15s + 80kn) \\ & = (75b + 25b) + (55s + 15s) + 275k + 80kn \\ & = 100b + 70s + 275k + 80kn \end{aligned}$$

(The pupils are very active here, and they come with many suggestions. They believe it is strange that you cannot add them all, and one of the pupils suggests that you can throw all the items out the window.) (Field Notes, school 3).

The pupils found this story amusing. They also laughed a lot when Karin called the a's apes and the b's bananas in another example. But no matter how amusing the stories are, the buttons, paper clips, apes and bananas do not have much to do with the mathematical operations, and they do not have much to do with real life either. As in the previous example they are merely artificial wrappings to make it more fun and motivating for the pupils, and perhaps some pupils also find it easier to understand it that way. There are of course some disadvantages involved in calling them apples instead of a's and so on, but we will not go into that here.

8.13.3 If I go shopping

If I bring 100 kroner to the store, then buy some item at a cost of 20 kroner and then something for 10, how much do I have left?

This was presented as an example for the pupils in a lesson introducing algebra. Karin used this example, which the pupils solved easily, to introduce arithmetical operations. She was interested in how the pupils calculated. One of the pupils explained that she calculated it like this: $100 - 20 - 10 = 70$. Another pupil used parentheses: $100 - (20 + 10)$. Karin gave further examples like these for the pupils to write in their rulebook. In this lesson we could also observe how Karin presented new theory when discussing with the pupils, using their answers actively (from Field Notes, school 3):

(Blackboard: $3 + 4 * 2$)

Karin: What is the answer, and how do you get it?

Pupil: You take four and multiply by two, and then you add.

Karin: Would anyone do it differently?

Pupil2: 3 plus 4 and multiply with 2.

Karin: Here we see that we have to choose, because we can only have one answer. Which is correct?

Pupil: 11.

Karin: Can we make a rule?

Pupil: No parenthesis.

It is also interesting in this example to observe how Karin let pupils present their different solutions to the problem. She encouraged them to participate in a discussion of what method to use, and the pupils were thereby actively involved. The real-life connection, which in this lesson is the introduction of a shopping context, is merely used as a wrapping. The purpose is to provide a familiar context for a purely mathematical discussion. The context is not used for any other purposes in the introduction, and it might serve as an example of how teachers give an already

existing mathematical problem a ‘realistic’ wrapping in the introduction of a context. We can also find examples of this approach in many textbooks, where purely mathematical problems are presented in contexts that often sound artificial. Again we do not claim that this use of everyday contexts is wrong per se, but we believe that they are in some sense fake real life connections.

8.13.4 Textbook teaches

In another lesson Karin told the class that they will let the textbook teach them this lesson. All the pupils turned to page 265, and one of the pupils started reading. Karin made remarks and asked questions along with the reading. At one occasion, Karin showed how they could make a formula with an unknown in order to calculate something. Here she made some interesting remarks:

So we can turn reality into a story, a formula with which we can calculate. (She writes a formula on the blackboard, for the pupils to copy down in their rulebooks) (...) Something like this $[8*x - 5*y]$ is called an ‘expression’, but we don’t get to know a story behind it. We can very well come up with a story, the teacher says and comes up with a story with weekly wages and buying magazines (Field Notes, school 3).

In this and other examples, like the previous one, the context in word problems seem to be merely amusing stories. It is possible to come up with a story but there is no need to, Karin believed. The everyday life connections serve more as artificial wrappings that you can easily manage without.

The contexts in word problems seem to be merely stories that you can manage without.

This lesson also gave indications on how important the textbook might be for some teachers. We do not claim that teachers often let the textbook teach like this, but we have seen an example of how it is done. Some teachers told us how important the textbook was for them. In chapter 5 we therefore gave a closer study of textbooks, to find in what way the textbooks actually implement the ideas of the curriculum with respect to everyday mathematics – our theme.

8.13.5 How many have you slept with?

In the last lesson that we followed Karin’s class, she introduced a project related to probability. The pupils were going to work in pairs in a two-week project. The teacher had arranged the pairs, and the topic was going to be statistics. In the introduction Karin presented an example where she asked all the pupils how many sisters or brothers they had. They marked this out in a table and made a diagram to represent it. In this connection, Karin made some remarks and comments from real-life settings. Now the pupils were asked to choose a problem like this to work on, and the groups should carry out a survey in the class. The pupils chose many interesting research questions, and all were related to their everyday life. Many pupils were from farms, and one of the groups asked: “How many horses do you have in your field?” A problem arose when they realised that some of their classmates did not live on a farm and therefore did not have any horses. How were they supposed to handle that? Another group, consisting of two low attaining boys, asked: “How many have you slept with?” This question was of course both tricky and intimate. Most pupils at this age probably had not slept with anyone. Many were reluctant to admit this, since the question had strong connections with status, self-esteem, etc. This raised a discussion on ethics. The boys were eventually asked to consider a different question, because there was a very strong possibility that the answers they got were not true. The boys then reconsidered, but since they did not want to let this idea go completely, they ended up with the question: “How many have you kissed?” This was also a tricky question, but they were allowed to carry it out since it was not so ‘dangerous’.

9 Five high-school teachers: Beliefs and actions

The teachers at upper secondary school teach pupils who have completed the 10-year compulsory education. We will present their ideas about mathematics in everyday life and discuss how they correspond with the ideas of the teachers in lower secondary education. Five teachers have been studied: Jane, who was teaching mathematics in a vocational school and George, Owen, Ingrid and Thomas, who were teaching mathematics at a more theoretical upper secondary school.

9.1 Curriculum expectations

The ideas about connecting mathematics with everyday or real life are extensively represented in the national curriculum for grades 1-10, which we have already seen. In upper secondary school there are separate plans for each subject, but the general introduction from L97 is in force for upper secondary teachers also. The upper secondary plan for mathematics also contains the ideas of connecting mathematics with everyday life. We list some of the suggestions made in the chapter on aims in the curriculum for upper secondary school, and we focus on the obligatory mathematics studies in the first year. The pupils should be able to:

- transform a problem from real life to mathematical form, solve it and evaluate the correctness of the solution;
- choose proper units in problems from daily and vocational life;
- interpret and handle formulas and algorithms connected with everyday and vocational life;
- use geometry to solve practical problems connected with length, area and volume;
- use trigonometry in practical situations;
- know examples of how the golden section has been used in art, handicraft and architecture;
- know some practical examples of functions, and be able to interpret results of various calculations on functions in practical situations;
- use regression on the pocket calculator to find linear and exponential connections in practical situations;
- know how mathematics can be used to date historical findings.

These are some concrete suggestions for teachers in upper secondary school for how to make connections with everyday life. We did expect to see some of these ideas realised in the practices of teachers in our study. The syllabus states that the pupils should be assessed according to how they have reached the aims, including those listed above, or to what degree they have reached these aims. It is therefore reasonable to assume that some of these issues would be visible in the classrooms.

9.2 Questionnaire results

We will first present the answers that the five teachers gave to our questionnaire, which was the same as for the teachers in lower secondary school (see also chapter 7 for a discussion of the questionnaire results).

1) I emphasise the connection between mathematics and the pupils' everyday life.

Very often	Often	Sometimes	Seldom	Very seldom
Jane	George, Owen	Thomas, Ingrid		

Jane would very often connect school mathematics with the everyday life of the pupils, George and Owen claimed to do this often, while Ingrid and Thomas did it sometimes. These are interesting statements, and we will discuss them further in comparison with the interviews and the classroom observations. In a comment-on question later in the questionnaire, George presented some important questions:

What are problems from real life? Isn't a mathematical problem real life?

This indicates that George had an understanding of real life that implied not only the world outside of school. This should be taken into consideration in our discussion. Thomas commented that:

One shouldn't forget the value of learning mathematics for its own sake, without always trying to connect the subject to practical situations.

Thomas experienced a difference between mathematics and real life, and he did not always emphasise a connection between the two.

2) I use projects when I teach mathematics.

Very often	Often	Sometimes	Seldom	Very seldom
		Thomas	Jane, George, Ingrid, Owen	

Working with projects is emphasised at the lower levels but not so much in upper secondary school, at least not by these teachers. The curriculum only suggests that the pupils should carry out one extensive individual piece of work or project in mathematics during the school year. Therefore it should not come as a surprise that upper secondary teachers do not emphasise projects, at least not in the sense of more extensive projects where the pupils have to write reports, etc.

3) The pupils are actively involved in the formulation of problems from their own everyday life.

Very often	Often	Sometimes	Seldom	Very seldom
	George		Jane, Thomas, Owen	Ingrid

George let the pupils often take part in the formulation of problems from their everyday lives, and he also said in question 1 that he often emphasised the connection of school mathematics with the pupils' everyday lives. Owen made the same claim, but he seldom let the pupils take part in the formulation of such problems. Ingrid pointed out later in the questionnaire that it is important to base teaching on what is known to the pupils, in order to make mathematics understandable to them. Here she claimed to focus very seldom on letting the pupils formulate problems from their own everyday life. From question 1 we learn that she did not focus too much on connecting school mathematics with everyday life either.

4) I use other sources than the textbook.

Very often	Often	Sometimes	Seldom	Very seldom
Jane	George	Thomas, Ingrid, Owen		

Jane and George emphasised the connection of mathematics with everyday life very often and often, so it will be interesting to learn more about how they do this. The use of sources other than the textbook is an interesting aspect. Jane very often used other sources than the textbook, and we will see what kind of sources later. George claimed to do this often, while the other three only did it sometimes.

5) The pupils solve many textbook tasks.

Very often	Often	Sometimes	Seldom	Very seldom
George, Thomas, Ingrid, Owen		Jane		

There was a strong consensus about letting the pupils solve many textbook tasks in the theoretically based upper secondary school (school 2). Jane, who taught at a vocational school did not emphasise this as much. George used other sources than the textbook often, and at the same time his pupils would very often solve many textbook tasks. This is an interesting case, and it might indicate a belief that solving textbook tasks could provide a connection with real life. This could also be connected with George's statement that mathematical problems are real life to the pupils. Solving textbook tasks would thus be a way of connecting with the pupils' everyday life.

6) The pupils work in groups.

Very often	Often	Sometimes	Seldom	Very seldom
Ingrid, Thomas	George	Owen	Jane	

Ingrid and Thomas worked together in a class where cooperative groups were focused on. Their classes were normally organised in cooperative groups. This was part of a larger project in their school, and was motivated by the ideas of Neil Davidson (Davidson, 1990) and others. George often let the pupils work in groups, but, as in Harry's classes, this would normally be more unstructured group work.

7) First I teach theory, then the pupils practise solving tasks.

Very often	Often	Sometimes	Seldom	Very seldom
Owen	Jane, George, Ingrid	Thomas		

This represents what we might call a traditional approach to the teaching of mathematics, and most of these teachers focused on starting with the teaching of theory followed by practice in solving tasks. Thomas only followed this approach sometimes, and thus was an exception. George and Jane, who emphasised real-life connections the most, often had this traditional approach to teaching mathematics.

8) The pupils are actively involved in the (re-)construction of the mathematical theories.

Very often	Often	Sometimes	Seldom	Very seldom
	Owen, Ingrid, Thomas	Jane		

Owen, Ingrid and Thomas claimed that their pupils were often actively involved in the (re-)construction of the mathematical ideas. George did not answer this question, seemingly because he raised questions about the content of the concepts. Jane claimed to emphasise discovery in another question in the questionnaire, where she answered that when the pupils discover mathematics and solve the problems, they become motivated and develop an understanding of the subject, which then becomes useful for them. She also put exploring as the number one strategy to make mathematics more meaningful and exciting for the pupils. Thomas pointed out the importance of letting the pupils take part in the construction of mathematical theories and rules in order for mathematics to become understandable for them.

9) The pupils find the mathematics they learn in school useful.

Very often	Often	Sometimes	Seldom	Very seldom
	Owen	Jane, Ingrid		

The notion of mathematics being ‘useful’ is a somewhat troublesome notion to use. Perhaps it was because of this that neither George nor Thomas answered this question. Owen believed that his pupils often find school mathematics useful, but there is a possibility that this indicated usefulness within the school context rather than outside of it. Ingrid replied to a comment-on question in the questionnaire:

Can’t mathematics sometimes be a free spot – a game, without thinking of usefulness?

George, who did not answer this question, said in a comment-on question that:

The aspect of usefulness is overestimated. It underestimates man’s joy in solving mathematical problems, systematising, beauty. Compare this with English teaching that is going to teach tourists to order a room. Shakespeare is also part of life.

This indicates that George’s opinion on what everyday life is could be more connected with culture and what the pupils do in school, rather than what would often characterise everyday life – outside of school.

10) The pupils work with problems that help them understand mathematics.

Very often	Often	Sometimes	Seldom	Very seldom
	George, Owen, Thomas	Jane		

This was also a question some teachers found hard, and Ingrid chose not to answer it. In the interview she explained that she could not answer this question because she did not really understand it. George, Owen and Thomas believed that their pupils often worked with such problems, while Jane had an impression that her pupils only sometimes worked with such problems. She also believed that the pupils only sometimes found school mathematics useful.

11) The pupils work with open tasks.

Very often	Often	Sometimes	Seldom	Very seldom
		Jane, George, Ingrid, Thomas		Owen

Owen very seldom let his pupils work with open tasks, and this is connected with his statements about drills and exercise. He also followed a more traditional and textbook-oriented approach to the teaching of mathematics, and most textbooks do not contain many open tasks or problems. When listing the three most important points to focus on for a teacher, when the aim is that pupils should learn to understand mathematics, Owen put:

1. Calculate a lot, so that it will become ‘automatic’

2. Repetition

3. Practise more and more, understanding comes later

It is interesting to see that open tasks were not used much by the teachers who emphasised real-life connections either.

12) Situations from the media are often used as background for problems the pupils work with.

Very often	Often	Sometimes	Seldom	Very seldom
		Jane	George, Ingrid, Thomas	Owen

Situations from the media were not used much in upper secondary school, at least not in the school where George, Owen, Ingrid and Thomas taught. Jane sometimes used situations from the media.

9.3 Models of analysis

In the presentation of findings from the study of three teachers in lower secondary school, we referred to an initial model of extremes. The teachers in upper secondary school could also be compared with such a model, but from the analysis of the questionnaire we discover that there are some issues that make it hard to place them within such distinct and simplified categories. Owen claimed to emphasise the connection with real life often in question 1, but from the other questions in the questionnaire we conclude that he did not really seem to focus all that much on this. The table above also indicates that he belonged to the negative group. Jane was positive towards real-life connections, although she did not always have as strong ideas as Harry. According to the table she fits the negotiating group more, so we will have to take more data into account in order to decide where she fits more. George supported the idea, but he did have a more traditional approach to teaching in practice. Ingrid expressed the most negative views towards the idea connecting with real life, while Thomas was not completely negative towards the idea, but his focus was on other aspects of teaching. There is a greater variety in the answers given by these teachers, and the initial model of extremes proved to be less useful in the analysis.

The model of extremes has been replaced by a list of categories and themes, as presented in chapter 7.6, and this will be used when presenting and analysing the findings from our pilot study of teachers in upper secondary school also.

Our main impression was that the teachers in upper secondary school were more concerned about the mathematical content of the lessons, and they also expressed more support for traditional methods of teaching. Some teachers supported a connection with real life, using other sources, etc. They were, however, also tightly bound to a model of presenting mathematical content and letting the pupils practise applications of the methods on textbook problems.

9.4 Jane's beliefs

Jane was a younger teacher with a strong background in mathematics. In addition to the ordinary teacher education, she had a Master's degree in mathematics education. She had been a teacher for two years in contemporary school and six years in upper secondary school, where she was teaching

now. She was teaching only mathematics, and she therefore had several classes to teach. School 1, where she taught, was a vocational school, where the pupils could choose programs to start preparing for vocational training for hotels and restaurants, designers, hairdressers, etc. We mainly observed three classes of Jane's in our visiting period, one for hotel and nutrition and two other classes for 'shape and colour', with pupils in a program that was focused on art and design.

9.4.1 Practice theories

Jane replied in the questionnaire that she very often focused on the connection with everyday life in her teaching of mathematics. In the interview she elaborated on her conceptions of everyday life:

The pupils' everyday life, then I think about for instance ... calculations they need when they go shopping, knowledge they need in order to understand illustrations in the newspaper. Many of them have a part-time job in their spare time. And many times I use examples from my own everyday life in the teaching (S1-teacher interview-1).

These ideas are closely connected with what has been called everyday mathematics. Jane was also concerned about connecting mathematics with what the pupils could meet in their future vocational life. She constantly tried to find examples from their future vocational life and used those in the mathematics lessons. With pupils who were training to become cooks or chefs, she used examples from the kitchen, like weights, measures, waste, etc. She also believed that it was important for her as a teacher to get to know the pupils, to find out what interests they had, etc. Then it was easier to find examples that were motivating for them. Her main concern, however, was to find examples that were connected with their vocational training.

Yes, so often it is the topic or the setting that is the door to some new topic in mathematics. And then you try to find mathematics within something that is familiar to the pupils within the vocation, and then you present the mathematics with a basis there (S1-teacher interview-1).

When asked if there were any parts of the syllabus where everyday life was especially hard to incorporate, Jane answered:

Hehe. Algebra. Calculating with letters, however much we are going to include that. Equations. Equations might be connected with puzzles and stuff, but... powers and stuff. Because they are very large and very small numbers, the pupils seldom meet them. It might be very large number that you can read about in an atlas or something. Like measurements of something ... the earth (S1-teacher interview-1).

It is interesting to see that she here claimed, at least in an indirect way, that issues that we are familiar with from our own everyday life are easier to understand in the mathematics classroom also. The previous statement also indicates that she emphasised a connection of mathematics with issues and relations that were familiar to the pupils from their everyday or vocational life.

9.4.2 Content and sources

Jane said in the questionnaire that she would very often use other sources than the textbook, and that the pupils would only sometimes solve many textbook tasks. She told us in the interview that she was not satisfied with the textbook, and she believed that it often presented problems that were connected with everyday or vocational life in an artificial way. The pupils would only

"The pupils just laugh at it. It is childish!"

laugh at such attempts and found them childish. The result was that the pupils would dislike the textbook. She was therefore tempted to throw away the textbook, she said. She had sometimes toyed with the idea of writing a new textbook herself. Jane seldom let the pupils take an active part in the formulation of problems from their everyday life, they worked with open tasks sometimes, and sometimes situations from the media were used. Open tasks and situations from the media could be part of it, but we would suspect there was more, since she said that she would very often use other sources.

When asked in the interview what kind of sources she was using in addition to the textbook, Jane replied:

Yeah, ... I have been using drawings of houses. I have used maps, I have used ... kitchen supplies. You find a lot of nice things in the kitchen! Empty boxes, packing, much of that kind ... Then you can also get newspaper articles. You can find statistics in the newspaper, for this and that (S1-teacher interview-1).

We understand that concrete materials and items that the pupils know from everyday life were used often. The pupils' everyday life was also incorporated through subjects that reflect their future everyday life in work.

(...) like in subject about hotel and items of food, which we have ... they work quite a lot with nutrition and theory about that ... and they work with calories and suchlike. And this is also calculated in mathematics. For instance, last Friday one of the girls found out that if she should cover her daily needs by only eating potato chips, she had to eat three bags of potato chips. So, she figured out that this wouldn't fill her up! Or she might drink ... what was it again ... she could drink eight and a half litres of mineral water. So kind of ... they could see that maths were used for something with a purpose! That ... if I eat more of that, I actually get bigger. And if I eat less, I lose weight (S1-teacher interview-1).

Sometimes she used problems or tasks from old textbooks, problems that she had used with success before. These were mostly easier problems, and she found it problematic that their textbooks did not contain enough easy tasks.

All in all Jane had many ideas about connecting mathematics in school with the pupils' everyday life, but she also experienced practical difficulties with pupils who were not motivated. It is quite common in Norwegian vocational schools that the pupils are less motivated for the theoretical subjects, she said. They want to start working and they do not always see the need for further studies in mathematics.

9.4.3 Activities and organisation

There are several ways of organising the class in activities connected with real-life, and the syllabus suggests using projects, both in the curriculum for year 1-10 and for upper secondary education. Jane replied in the questionnaire that she seldom used projects in her teaching. By the end of our visit, she was starting a project in one of her classes, and she told us about this in the interview. The project was given the title: 'bedroom of my dreams'. In this project the pupils decided what the bedroom of their dreams would look like, and they made a drawing of it. They had to decide the size and looks of walls, roof, floor, furniture, etc. The plan was supposed to be presented in a drawing. Jane was also conscious about the difference between working in groups and doing projects. There were certain elements that had to be present if they were working with projects, a certain structure. She described a project she had made in cooperation with the teachers of the vocational subjects:

We have worked together both the teachers of the general subjects and the teachers of the vocational subjects. They have more or less given the problem formulation, and we have found some common points of connection. Then, we have organised a project together, and the pupils have been given the task of solving it and the problem in the curriculum. How can I build a house, right? Often it has been about area and volume, scales and suchlike (S1-Teacher interview-1).

In her everyday teaching a common strategy was to teach theory first, and then let the pupils practise working on tasks. She answered in the questionnaire that this was often the case. Her way of teaching theory was not much like traditional lectures though, and even though she did present the topic for the class she would often do this in an untraditional way. Re-construction or re-invention was sometimes used, but the pupils seldom worked in groups.

In the interview Jane recalled a situation where the pupils had been particularly active and full of initiative. She used to teach a class in building trade, and they were working with craft theory, or mainly the legal matters concerning these issues. They had been engaged in the regulations concerning the air space that a work place must have for every worker. Some of them had been complaining that there was not enough air in their classroom, so they did some calculations and found that according to the regulations, their classroom did not contain enough air. This was a situation that the pupils became really involved in, and it was connected with their everyday life in a direct way. Jane had also experienced that the pupils got involved when they were learning about proportions of the body, in connection with the golden section and suchlike.

9.5 George's beliefs

George was one of the older and more experienced teachers in his school. He had a Master's degree in English, and he had studied mathematics for a year and a half. He had more than 30 years of teaching experience at the upper secondary school where he was now. For five years he had taught a bilingual class in mathematics. George taught mathematics and English language as his main subjects, and he was interested in arts and culture. Occasionally he would teach art history. He was a reflective teacher, and he had many ideas and thoughts about teaching and learning, the role of the school system, etc.

9.5.1 Practice theories

George found "the pupils' everyday life" to be a problematic notion, and we have seen indications of this in the discussion of the questionnaire (see chapter 7.5). He was not sure how the phrase was to be interpreted. Did it mean discussing problems of building a swimming pool in the garden, or measuring the angles on cookies? Practical problems, he said, have been emphasised at all times. In the old days they were called word problems, but he believed that the content was still the same.

For ... if you are going to include the pupils' everyday life, then there have to be mathematical methods that they master. That they don't have to rely completely on technical aids and things they don't understand at all. Because in that case they are distanced from their everyday life. But nobody who is working with mathematics is opposed to the importance of solving practical problems, and working with applied mathematics, but it must not become two-dimensional. And you also have to stimulate the pupils to abstract thinking, I believe (S2-teacher interview-1).

He also believed that practical problems should not be so hard that the pupils were forced to use pocket calculators, computers and equipment that they did not understand. In such cases it would be more as if the pupils were playing around with the keys and eventually got an answer. It would be

beyond their knowledge and capability to even check the reliability of the answers. That would, according to George, be a serious break with everyday life. If you want to incorporate the pupils' everyday life, there have to be methods they master.

George believed that the pupils' everyday life changed in upper secondary school. The pupils' everyday life is the fact that they want to qualify for a university or some further education. George said that the emphasis on connecting with everyday life had become a fashion wave, and that this had actually made it more distant from everyday life.

“You cannot expect the pupils to like an obligatory subject!”

He believed that the teaching was much more tied to the final exam in upper secondary school. In lower secondary education the teachers could make more choices, he believed.

George also pointed out that a teacher cannot expect the pupils to enjoy any obligatory subject, but they can be expected to do a good job. The didactic innovations are often like fashion waves, according to George, and he believed that it is more important to teach the pupils how to do a good job, and to enjoy the experience of finishing a job that is well done.

But when it comes to the usefulness of mathematics, I am of course aware that you should apply it. And all these calculations with areas, digging ditches, and hours and pounds, were good applications, and then it is also possible that you should let them try and find problem formulations themselves, to illustrate mathematical problems (S2-teacher interview-1).

All in all George had a positive but reflective view on connecting with everyday life. He emphasised other issues than this more in his teaching.

9.5.2 Content and sources

According to the questionnaire George very often let the pupils solve many problems from the textbook, but he also used other sources than the textbook often. George thought the Norwegian textbooks in mathematics were not very good. They often appeared to have been produced in a rush. Compared with British textbooks, which he liked for the way they made things clear, he found the Norwegian textbooks less thorough. He also criticised Norwegian textbooks when it came to the issue of everyday life connections:

But there have been some that have driven this business about everyday life far into parody. I refer to those with Paul the Pirate and ... sheep grazing on areas that are quite unreal. So, I believe that when they make problems, they should know that the mathematical problem has to be realistic, no matter how it is. That is also everyday life (S2-teacher interview-1).

Since he often used other sources than the textbook, we should try and uncover some of these sources. From the questionnaire we learn that he often let the pupils take an active part in the formulation of problems from their own everyday life. He was unique in this respect, and no other teacher in our study replied that they often or very often did this. He seldom used situations from the media, and the pupils would only sometimes work with open tasks. Letting the pupils formulate problems might therefore be his main way of connecting with everyday life. From the interview we do not get any more idea of how he might do it either, except from a comment on open tasks:

(...) there are some open tasks in the textbooks also, that they can discuss. But it is rather limited what kinds of open tasks you can use, because those that appeared in the beginning were quite absurd, I think. I think so. You drive a car, and then you have so and so much gas left. Are you going to fill it up, or are you going to think about how far you have got, or... (S2-teacher interview-1).

We do not learn much more about what other sources he might use, so this will be something to look for when the classroom observations are discussed.

9.5.3 Activities and organisation

Like most of the colleagues in his school, George would seldom use projects in his teaching of mathematics. When it comes to working in groups, he said in the questionnaire that the pupils often worked in groups. From the interview, we learn that group work is not something he emphasises in his lessons, but he believed it to be fine for the pupils to sit in groups and cooperate. This is similar to Harry's idea of group work. George also emphasised the importance of pointing things out to the entire class. In the interview he said that it was vital to be systematic in group work, and that he called most activities in his lessons group work. His definition of projects was a strict one, and he believed that projects and group activities often coincide. There is reason to believe that George would not have used the notion 'project' for many of Harry's mini-projects, and this might be a reason why he replied that he would seldom use projects.

One of George's ideas was to introduce the tutor system in upper secondary school. He believed that every student should have access to a tutor, a kind of supervisor that he could discuss with and get advice from. In this way, the apprenticeship idea would be introduced in upper secondary school, in the same way some British universities do.

My suggestion is that, for instance when you reach 2nd or 3rd Grade [upper secondary school], that there should be a teacher with a science degree that could have some pupils, for instance 10 pupils who studied science, and could be a supervisor and help them. And also see how their work went along, problems and ... have some closer contact with them (S2-teacher interview-1).

He would also like the school to become a more open community, in closer contact with the surrounding world. Their school was going to arrange a science week, which was going to be open for other people to join. In this way he wanted the school to be a vital centre in the community.

He underlined the importance of clarifying and pointing things out for the pupils. The pupils need to know rules and algorithms in his opinion. When it comes to exploring, his opinion was that the pupils should not always have to make their way through the difficulties on their own. He would let the pupils read the chapters through before the lessons, and then he would simplify it, so they can learn it.

For these are the things I find important. And there are also some things nowadays that I believe are being neglected in school, and that is the ability to examine, asking questions (S2-teacher interview-1).

George found it important, above all, to believe in what you do as a teacher and to show enthusiasm.

9.6 Owen's beliefs

Owen was another experienced teacher, who taught mathematics and natural sciences. His main subject was chemistry, in which he had his Master of Science degree. He had studied mathematics for a bit more than a year. His teaching experience was almost 30 years, mostly in the upper secondary school, but he also had been teaching his subjects at the local university college, and at several private schools and teaching institutions. He was a confident teacher, with strong beliefs about teaching.

9.6.1 Practice theories

“Connecting with everyday life makes it too hard for the pupils!”

From the questionnaire we got the impression that Owen was positive towards connecting mathematics with everyday life. When he was asked about these issues in the interview, he smiled and said that he just answered the questionnaire without much thinking. He then revealed strong ideas about teaching mathematics in a quite rigorous and traditional way. When connecting with everyday life, it instantly gets too hard for the pupils, he claimed. He believed that it would have been much easier with smart pupils, because they could educate each other. That would be the school of his dreams. The problem with the Norwegian school according to him is that mathematics is obligatory for all.

9.6.2 Content and sources

For Owen, the main characteristics of a good teacher were enthusiasm and justice. He viewed the teacher as an actor. When it came to the textbook, which he claimed to use a lot in his teaching, he also had opinions:

The textbook should be just the way it is now! Explanations, followed by problems that are just like the previous examples. That is the way the textbook should be! Very easy problems in the beginning (S2-teacher interview-2).

In the questionnaire he replied that he sometimes used other sources than the textbook. He also said that the pupils very often solved many tasks from the textbook and that he would very often start off teaching theory and then let the pupils practise solving textbook tasks. He believed that the final exam should control the teaching, and he indicated in the interview that the additional sources he might use were other textbooks and the supplementary books for the textbook or the teachers' book. He very seldom used situations from the media, very seldom let the pupils work on open tasks, and seldom let the pupils formulate problems from their everyday life.

9.6.3 Activities and organisation

Like most of the colleagues at his school, he seldom used projects, and in the interview he stated that he wanted to take away the projects entirely. They take too much time, he believed, and the pupils do not have the proper knowledge from their earlier school years. At upper secondary school, the pupils should be taught the tools, the methods and algorithms.

He did not believe much in group work either, and he let his pupils work less in groups than many of his colleagues. The reason for not organising the class in groups, according to him, was that the pupils were too weak. The pupils' lack of knowledge made it impossible to work in groups. He had tried group work in his class, he told us, but the pupils' grades had instantly dropped, so he was forced to cut this out. He also had an interesting explanation for the success (or failure) of all curriculum reforms:

The reason that all the reforms in school have worked out so well is that the teachers have continued doing what they always did! For instance, some pupils that had been taught German in lower secondary school came a while ago and asked if they could start all over now again. The advisor asked them why they wanted to start all over again when they had been taught German for three years at lower secondary school. Well, the pupils replied. In the school we went to, they had new pedagogy, so we haven't learned a thing! So the teachers at that school had not been doing what they always did, so there is the result (S2-teacher interview-2).

Owen found it problematic that many pupils nowadays have too much time for individual studies, with no control. As a result of this they do not have enough knowledge and skills. Owen believed that the pupils in years 1-10 should be drilled. Word problems should not be introduced at an early stage, because the pupils must learn the methods by heart first. Moral: “Do not believe in modern pedagogy!”

“The new pedagogy is not good!”

9.7 Ingrid’s beliefs

Ingrid was teaching a class together with Thomas. Although a mature lady, she had few years of experience as a teacher. Most of her experience was from the field of psychology, but she had a Master’s degree in Christian religion and about a year of mathematical studies. She had five years of teaching practice as a mathematics teacher.

9.7.1 Practice theories

In the questionnaire Ingrid was not so positive towards connecting school mathematics with everyday life. She replied that she only sometimes emphasised a connection with the pupils’ everyday life. In the interview she confirmed this impression.

I was so enthusiastic about getting away from everyday life for a while, and mathematics was like you went into a playground I felt. Moving x-s and y-s, and had a lot of fun in there. So, I think that has made an impact on my attitude towards mathematics (...) So, I suppose I have seen more of that side of mathematics, where you can sit and play, in the same way you can with crosswords. So I haven’t been so much occupied with the idea that it should be useful to you (S2-teacher interview-3).

Her own experience with mathematics in upper secondary school was not connected with usefulness, and she did not emphasise that a lot. She believed, however, that this could be a good idea in the introduction for weaker pupils. She believed that word problems could be all right if they were realistic, but she found many of them rather artificial. She believed that this would not be motivational to the pupils. Ingrid believed that school mathematics could be meaningful and make sense to the pupils although it was not realistic.

“I think it is okay for mathematics to be a refuge.”

When it came to certain aspects of mathematics that could be connected with everyday life, she said:

... yes, trigonometry could be connected with everyday life of course. And I remember that we wondered one year if we should include a project in our class where they were to measure the height of the trees in the schoolyard. The municipal department for parks and recreation grounds was very interested in that. And the golden section is very promising really. And then you have everything about personal finance, and ... volumes, areas are also like that ... I think that very much lies in the subject matter itself (S2-teacher interview-3).

In the evaluation study of L97, Alseth et al. (2003) conclude that the everyday teaching was still very traditional. In extended activities like projects these would often connect more with everyday life. In the quote above, Ingrid told us about such a project or extended activity where the pupils could make practical use of the mathematical theories. She also mentioned some topics that were easier to connect with everyday life than others, like the golden section and personal finance. Her main idea was that there was no need for mathematics to be connected with real life in order to

become interesting. These suggestions were more ideas for activities a teacher could organise rather than actual experiences of things she had done herself.

9.7.2 Content and sources

Ingrid claimed to use other sources than the textbook sometimes. She very seldom let the pupils formulate problems from their everyday life, and she seldom included situations from the media. Sometimes she let the pupils work with open tasks though, according to the questionnaire. Her pupils very often solved many tasks from the textbook, and she would often teach theory first and then let the pupils practise working on tasks (from the textbook). From the interview we could not figure out what other sources she might use in her teaching, so we will discuss this when presenting the classroom observations.

9.7.3 Activities and organisation

Ingrid seldom used projects, like her colleagues, and in the interview she claimed that many pupils were tired of projects. According to the syllabus though, the pupils are supposed to have one project each year, and this was done in her class also. She believed that this could be motivational, in that the pupils got to work with different things than they usually did. An example was when one of her colleagues, George, had guided her class around the art museum downtown.

She had experienced that the use of cooperative groups, as they did in their class, was motivating for the pupils. But she believed that weaker pupils would often give up in the beginning. They would not believe that they could do anything or that it could be inspiring.

She experienced frustration among her colleagues concerning the devaluation of teachers and their experiences. In connection with this she did not believe in the idea of controlling everything that happened in school to the tiniest detail.

9.8 Thomas' beliefs

Thomas and Ingrid were teaching the same class. It was a double-size class which was organised in cooperative groups. Thomas was the more experienced teacher, with previous teacher experience from lower secondary school also. For 13 years he had been teaching in lower secondary school, and then he had been teaching in upper secondary school for about 20 years. He had about a year and a half of mathematical studies, and he had also studied English, physics and chemistry.

9.8.1 Practice theories

“Many places it is not natural to try and draw upon the pupils’ everyday life and their everyday life experiences!”

Thomas was not so much in favour of connecting mathematics with everyday life. In the interview, however, he revealed many interesting and thoughtful opinions on these issues. Thomas did not believe that a connection between

mathematics and the pupils’ everyday life was the main point of importance in upper secondary school though:

I believe, from my experience in lower secondary school, that in those days there was ... I believe that it was very important to motivate the pupils, that they got a feeling that this was having some

connection with ... with their everyday life, with something they could use when they finished school, that it was useful ... like that. But I feel now, when I work with pupils in second and third grade at upper secondary school, these pupils find the mathematics interesting in itself. So I hardly ever get the question in those classes: When are we ever going to use this? So in those groups, I believe that it will become very artificial if one is always going to connect it with some practical application (S2-Teacher interview-4).

In the courses in upper secondary school, he believed that there could be some naturally occurring practical applications, like in economics, but in the higher grades he did not find this so important.

9.8.2 Content and sources

Thomas replied that he would sometimes use other sources than the textbook. Like his colleague Ingrid, he claimed that the pupils would very often solve many tasks from the textbook. He said that he only sometimes taught theory first and then let the pupils practise solving tasks. Here he differed from his colleague Ingrid. Thomas was in other words not as tied to the traditional way of teaching as some of his colleagues. Ingrid claimed that she would very seldom let the pupils formulate problems from their everyday life, while Thomas replied that this would seldom be the case. When it came to using situations from the media they both agreed that they would seldom use this. Thomas also replied that the pupils would sometimes be engaged in open tasks.

Thomas believed that the upper secondary textbooks were not good enough, at least not the textbooks for the vocational lines. He also believed that the pupils do not really read the mathematics in the textbooks. In his opinion one could write textbooks for teachers and not so much for pupils. The pupils in his classes did not use textbooks much, he said, and they mainly used them as a source of exercises to work with. He said in the interview that he would often use the internet to find examples and problems for the pupils to work on. He believed that in the future it would be important to use other sources than the textbook. When comparing with the earlier phase of his career, he believed that he was much less dependent on the textbook now. If only he had a source of problems or exercises for the pupils to work on, he believed that he could manage just fine without the textbook.

9.8.3 Activities and organisation

One of his main beliefs as a teacher of mathematics concerned cooperative groups (cf. Davidson, 1990; Kagan, 1992), and the idea of activating the pupils:

And we have, I suppose, had the belief that the pupils get a different relationship to it, and that you might get a better learning effect from drawing them more actively into the learning process than if you just stand there and lecture. That is what I have experienced anyway, and I have reduced the time I spend in front of the blackboard myself ... rather enormously. (...) So that is perhaps the biggest effect of it, that I have noticed anyway, that we have managed to turn this around, so that the pupil activity very often is larger than the teacher activity (S2-Teacher interview-4).

Ingrid and Thomas often challenged the pupils to go through difficulties from the homework assignment in front of the whole class or within their group:

Yes, and we sometimes, when they have homework, so instead of us going through it, we ask them to clear these things up in their groups, you know. If someone has managed to complete the task, they can explain it to the others, and if there is something that a lot of groups have trouble with, then there are probably some difficulties in understanding it, so we might have to go through it on the blackboard together (S2-Teacher interview-4).

Thomas felt that by doing this the teachers and the pupils were cooperating, and the lessons involved not only the teacher lecturing. The methods of teaching they used would also vary:

We vary between ... between the more traditional teacher-controlled teaching, teaching where they work on problems in groups, and where you have a combination of these. Quite often, we have a kind of teaching where you present a problem on the blackboard or on the overhead projector, and they get a minute or two in the groups to agree on the solution to the problem. Then we kind of go through the answer on the blackboard, instead of saying that it is like this and such (S2-Teacher interview-4).

When it came to projects, Thomas were not in favour of large projects where mathematics was included as a kind of excuse, in an artificial way.

Then they say: You can always make some tables, right, or maybe you can make some diagrams or such. But that isn't mathematics! I think I wrote something like if you are going to include mathematics, it has to be done somehow based on the premises of mathematics also (S2-Teacher interview-4).

Thomas was more in favour of purely mathematical projects, but again it would often be a question of time. He experienced hard pressure to get through all the contents of the curriculum.

He also brought up the discussion of learning to know, or learning to learn.

So the kind of simplified argument you hear, also from some politicians nowadays, that the most important thing for the pupils to learn isn't the facts; the most important thing is to learn how to learn, because now the pupils can take in anything. There are so many sources of information, the internet and ... yes, other things also, that the only thing that is important for the pupils is to learn how to orient themselves in this jungle of information, but that is just not how things are! (S2-Teacher interview-4)

Even if he did not support the idea of teaching where the teacher lectures in front of the blackboard all the time, Thomas found it important to let teachers explain and present things to the pupils. Thomas also called for a forum, as Harry did, or a source where the teachers could get ideas, activities to work on, etc.

9.9 Into the classrooms

This part of our study has a comparative function, and it also worked as a pilot where the methods could be tried out. We carried out the small survey and the interviews in the same way as we did in the main phase of our study, but when it came to the classroom observations we tried out different strategies. In school 1 we mainly visited Jane's classes for several weeks. We visited four classes and five teachers in school 2. Since all the mathematics lessons were parallel, it was impossible to observe all four classes in the same week. We therefore chose to take a brief look into several classrooms, to get an idea of what happened there, and focus more on the interviews and questionnaires. In doing this, we got to try out different approaches, and the methods and approaches developed and matured before the main part of our study, which we have already presented. Due to all these issues, we can present quite a few sequences from Jane's classes, but only one from most of the others.

9.10 Jane's teaching

9.10.1 Mathematics in the kitchen

Jane worked as a teacher of mathematics in a vocational school, and among other things this school educated pupils to work in hotels and kitchens. For these pupils, practice in the kitchen was naturally important. Jane would normally be in the kitchen with the pupils once a week as a mathematics teacher, as part of a project they called 'mathematics in the kitchen'. On these occasions Jane would accompany the pupils and help them with mathematically related issues, like measuring, weighing, etc. The situations and problems that appeared were mainly practical, everyday life applications of quite simple mathematical issues. In one of the lessons, a pupil carried a box with two fish weighing 7 kg altogether. Jane then asked him what the weight of each fish could be.

There was a set of digital scales in the kitchen, and these caused many problems and interesting situations. In each lesson the pupils were going to prepare a meal for themselves and the teachers. A natural issue to come up was how many potatoes they needed, etc. Through these naturally occurring incidents, the pupils got practice in estimating, weighing, doing simple calculations, etc. The contexts were realistic and closely connected with real life. This was an interesting approach, and it brings us into the discussion of everyday knowledge and knowledge in school mathematics. Researchers have found that the knowledge people can apply to problems outside of school does not automatically translate into seemingly similar situations or problems in a school context (cf. Carraher, Carraher & Schliemann, 1985; Nunes, Schliemann & Carraher, 1993). The main focus for these pupils would be to attain the knowledge and skills, including mathematical skills that are necessary for their future vocational life. The practical applications of mathematics they encountered in these lessons were probably the same as they would meet in a future job.

9.10.2 Is anyone here aunt or uncle?

Jane often used the pupils' experiences and incidents and issues from their daily lives in her teaching. When they worked with units of measurement, she asked the pupils if anyone was an aunt or uncle. Normally one or two in each class were. She followed up by asking them how much the child weighed at birth. One of the girls answered "3750", and Jane replied asking "3750 what?" This was used in a discussion of the relationship between kilograms, grams and other units of weight. In every mathematics lesson Jane asked questions, trying to incorporate the everyday life of the pupils. She would ask them if they had seen this and that sign when they were out driving, and use this to introduce the units of kilometres, etc. This was also something she emphasised in the interview, to constantly try and draw upon the daily lives of the pupils. To be able to do this, she had to get to know the pupils to learn more about what they were interested in and what occupied them.

9.10.3 Techno sticks and angles

When introducing the concept of angle, Jane drew many figures on the blackboard. They were not only geometrical figures of different angles, but also figures to illustrate how angles occur in our natural environment and in everyday life. For instance, she drew a pair of scissors, to challenge the pupils' concept of angle. She also asked the pupils if they had ever played with techno sticks when they were younger. These sticks can be attached in different manners, thus forming angles of different degrees, and different objects can be built with them. She asked them if they could find angles in the classroom, and they talked about the corners of the door, the blackboard and the

windows. She also gave an interesting description of obtuse angles, telling a story about how beavers gnaw wood that ends up forming obtuse angles. Some of the pupils might never have seen a beaver, but at least Jane challenged them to think. When discussing parallel lines, she explained how the rails of a railway line were parallel, but when seeing a railway line disappear on the horizon it would look as if they meet.

9.10.4 I am going to build a garage

Jane often brought materials from her own everyday life, like boxes from the kitchen, maps, pictures, newspaper articles, etc. In one lesson she brought a plan of her house and the surrounding terrain. First she asked the pupils to reflect on the scale that such maps used. She then told them that she was going to build a garage, and she presented them with the building sketches of this garage. She had a caravan, she told them, and presented them with the measurements of it. They were then challenged to do the necessary calculations to decide if there would be enough space in the garage for the caravan. Jane also used the drawings and maps to introduce concepts like scale, proportions and ratios, giving the pupils examples to work on from these drawings. Because of such activities and the concrete materials Jane brought, she did not use the textbook much. She told us in the interview that she would often make the problems and examples on her own.

9.10.5 Pythagoras

In another lesson Jane's class was busy with Pythagoras' theorem. She made a drawing of a house on the blackboard, and she said that they were going to paint this house. To do that, they needed a ladder, which, according to Jane, was 3 metres long. Then she asked them how far this ladder would reach up on the wall. 'What kind of mathematical instrument do we need to calculate how far up it reaches', she asked them. 'Our heads', one of the pupils replied. This was of course a decent answer, but Jane guided them into a discussion about the right triangle and the sides of it. After a while they remembered the theorem of Pythagoras. Jane showed them transparencies of stamps with images of Pythagoras' theorem on them, and she told the class about a friend of hers, who also happened to be a mathematics teacher. He had arranged the tiles on his bathroom floor so that they represented this theorem. This friend also had windows that were golden rectangles and cars where the number plates had prime numbers. Some of the pupils seemed to decide that this teacher was a nut case.

9.11 George's teaching

9.11.1 Trigonometry and Christmas cookies

We only observed one lesson in George's class, which was a bilingual class. The pupils were both Norwegians, who for some reason had chosen a bilingual class, and foreign pupils whose mother tongue was other than Norwegian. The teaching was almost exclusively in English, and George was also an English teacher in this school.

The lesson we followed was an introduction to trigonometry. George had asked the pupils to read the textbook chapter on this in preparation for the lesson. He therefore started the lesson by asking questions from what the pupils had read at home. He was careful to clarify all the terminology they met in their discussion, and they spent some time discussing triangles, right angles, opposite, adjacent, hypotenuse, and all the other words that appeared. He also gave some examples of how to

use these concepts, starting off with sine. The example he gave for the use of this knowledge was how to find an unknown side in a right-angled triangle, if you knew the length of the hypotenuse and an opposite angle. When he finished this example, the pupils were given some tasks to work with.

After the break, the pupils continued to work with tasks concerning sine. After a while, George also introduced cosine, and the pupils got tasks on that. Occasionally, George would interrupt the pupils, calling their attention to an example. He motivated them to think about when to use sine and when to use cosine, and he continuously focused on pupils' understanding.

George did not use many real-life connections in his teaching, at least not in this lesson, and his presentation was rather traditional. He only gave one real-life example that we could discover, and that was a comment on how to use trigonometry to find angles and sides of a certain brand of Christmas cookies. From the interview, we learned that George was conscious about the pupils' everyday life, what that consisted in and how teaching should be carried out. As we have already seen, George would question the notion of everyday life, and his idea was that school was an important part of the pupils' everyday life. He believed that real-life connections were often two-dimensional, and he emphasised hard work and devotion from the pupils. He also wanted the pupils to practise abstract thinking. The aim was for the pupils to learn the mathematical methods, and he had a quite traditional, yet reflective, conception of how this could be achieved. Human beings have learned to master mathematics for centuries, he said, so some things must have been done right in the past also.

9.12 Owen's teaching

9.12.1 Areas

The one lesson we followed in Owen's class was an ordinary lesson. Owen was accompanied by a young student teacher, and this teacher was responsible for the presentation at the beginning of the lesson. Owen mainly walked around and helped pupils when they were solving tasks individually. We will not say much about the introductory presentation, other than that it was a straightforward presentation of the area sentence in trigonometry, illustrated by a couple of examples that were similar to many textbook tasks. Before the pupils started working on the tasks, the young teacher explained a problem that the pupils had solved at home.

When the pupils were solving problems, Owen walked around and helped. He spent some time with each pupil, and he did not present the pupils with the answer at once. He often asked questions and let the pupils think first, to let them figure it out for themselves. The younger teacher, however, often gave the answer and explained the method straight away. Our main knowledge about Owen's teaching and his ideas and beliefs is from the interview, which we have presented earlier, and not from the lesson we observed. What we could deduce from this lesson though, is that Owen was in favour of a traditional way of introducing and presenting a topic, giving some examples and showing how to solve them, and then letting the pupils work with textbook tasks to practise solving similar tasks. The pupils normally worked individually rather than in groups, and the teacher would walk around and help them whenever they encountered problems.

9.13 The teaching of Thomas and Ingrid

9.13.1 Cooperative groups

We followed three lessons in a class that Thomas and Ingrid had, one of which was a double lesson. They had organised their class in groups, and much of their teaching was organised as cooperative learning activities. This approach was motivated by Neil Davidson (cf. Davidson, 1990), who had visited their school some years earlier. A student at the neighbouring college for teacher education had carried out a project on problem solving in groups as part of his Master thesis, and this had also been a source of motivation. He was now a teacher at this school.

The first lesson we followed in this class, the double lesson, was an introduction to trigonometry. In the beginning of the lesson, Thomas and Ingrid asked if there were any questions concerning the homework assignment. When a question occurred, the teachers asked if some of the pupils could explain the task on the blackboard. Two pupils eventually came up and explained it to the class. This approach was normal in their class, Thomas told us in the interview. They would also sometimes let the pupils work on the problem in their group. One of the important results of the approach was, according to Thomas, that they had managed to lower the teacher's activity and raise the pupils' activity.

When they had finished the review of problems from the homework assignment, Thomas introduced the new topic: trigonometry. He started off, saying a few words about what trigonometry was, what the word meant, and then he handed out a task for the groups to work on. In this task, the groups were exploring the issues, and they were more or less re-inventing the theories of sine, cosine and tangent. The teachers walked around and made small comments, but they never gave any solutions to the pupils. One of the pupils had already learned about trigonometry in his lower-secondary school, and he was told not to tell the others anything yet. The idea was that each pupil should get a chance to find this out for himself.

After the break, some representatives from the groups came up and presented their findings to the class, and the teachers asked them questions during the presentation. When the presentations were finished, the teachers continued bringing up some more issues on the subject. The pupils then got to practise solving problems from the textbook. The pupils normally discussed the problems within their group before asking the teacher.

10 Discussions and answers

In the second phase of analysis a list of themes and categories was created based on the analysis of the questionnaire results. This list was used to create profiles of the three teachers in the main part of the classroom studies, and these profiles were finally used as a basis for the discussion below. In addition to the data analysis (analysis of the profiles as well as the earlier analysis), other aspects are brought into discussion, such as: curriculum intentions, textbooks, teachers' beliefs and practices, TIMSS videos, the pilot study, as well as theory. The profiles were created according to the following list of themes and categories:

Activities and organisation

- Cooperative learning
- Reinvention
- Projects
- Repetitions and hard work

Content and sources

- Textbooks
- Curriculum
- Other sources

Practice theories

- Teaching and learning
- Vocational relevance
- Connections with everyday life

The themes in this list have been used to organise the presentation of data in the previous chapters, and the entire list is used as an organiser for the presentation of the further data analysis in the following.

10.1 Activities and organisation

10.1.1 Cooperative learning

According to the curriculum, the pupils should be given the opportunity to “work co-operatively on assignments and problems” (RMERC, 1999, pp. 167-168). The issue of cooperation is not explicitly mentioned in the curriculum area of mathematics in everyday life for years 8-10, but the intention quoted above should go for all years. In the years 1-4, within the area of mathematics in everyday life, they should:

They should learn to cooperate in describing and resolving situations and problems, talk about and explain their thinking, and develop confidence in their own abilities (RMERC, 1999, p. 170).

The curriculum thereby expects teachers to provide the pupils with opportunities to work cooperatively, and especially on assignments and problems.

When discussing the relationship between curriculum intentions, textbook implementation and teaching, it appears that the issue of providing opportunities to work cooperatively on assignments and problems is mainly a challenge for the teacher. Some of the textbooks present suggestions for projects that could be used for cooperative learning, but these will be referred to in the section on projects.

As far as our three teachers are concerned, cooperative learning did not seem to be something they focused a lot on. Harry answered in the questionnaire that his pupils mostly worked in pairs or three and three, but he explained in the interview that he did not focus much on whether the pupils are working in groups or individually. His main focus was on getting a good “mathematical discourse” with the pupils.

Both Karin and Ann replied in the questionnaire that their pupils sometimes worked in groups, and Ann explained in the interview that she believed in group work and cooperation, that the pupils could help each other and discuss things. Karin was somewhat more reluctant. In the interview she explained that working in groups could be beneficial on some occasions, but mostly it was about ‘being responsible for your own head’.

The teachers seem to have split opinions as far as cooperative learning is concerned. What about teaching practice?

With Karin, we could not find much evidence of a focus on group work or cooperative learning in her classroom practice. The pupils mostly worked individually with textbook tasks. Some of the pupils had chosen to work in pairs, but this was their own choice rather than a conscious strategy from Karin’s side. When having projects, as we will discuss in the following, Karin organised the pupils in pairs so that they could work together, but we could not find any evidence of an emphasis on the cooperative learning part as such, nor the group work process.

Harry claimed that his pupils mostly work in pairs or three and three, but that this was not something he emphasised. This was also evident in his teaching. The pupils worked in pairs or three and three (or even individually if they so chose), but Harry did not intervene in the selection of groups and he did not seem to focus on group work in particular. In his small-projects (like the bicycle assignment and the woodwork sessions), the pupils were given the opportunity to work cooperatively, but it was the activity rather than the cooperation that was in focus.

On one occasion, Ann let the pupils work in pairs to solve a special assignment (the area of figures on a piece of paper handed out). On this occasion, she had chosen before the lesson which pupils were going to work together in pairs. The pupils worked on the problems in pairs, and in the last part of the lesson they discussed their results and how they had approached the problems with the other groups (and in the whole class). This was one of the very few examples (if not the only) of the teacher having a more active approach towards the issue of cooperative learning and group work in the case study of three teachers. This example was somewhat similar to the strategy they used on a daily basis in the classes of Thomas and Ingrid in the pilot. In school 2, and particularly in the classes of Thomas and Ingrid, cooperative learning was a main idea. The classes were organised in cooperative groups, of 5-7 pupils, and the approach had a strong theoretical foundation in this school.

The idea of letting the pupils work on problems (in pairs or groups) and then discuss their results and algorithms with the entire class in the end, was something that could often be observed in the Japanese classrooms (see chapter 3). The Japanese teachers would often let the pupils work individually first, then sometimes continue in groups, and by the end of the lesson they would spend

quite some time on letting the pupils present and discuss their solutions and solution methods in the whole class.

The focus on group work and cooperative work could also be found in some of the contemporary approaches described in the theory chapter. In the High/Scope curriculum for example, small-group mathematics workshops of 50-60 minutes per day and individual plan-do-review activities were the main ingredients of the mathematical activities. These group-workshops seemed to be an integral part of their mathematics curriculum. Cooperative learning activities inside and outside the classroom was also emphasised in this curriculum.

In the Everyday Mathematics curriculum, cooperative learning and sharing ideas through discussion were among the key features.

The idea of letting the pupils discuss their own solutions and questions in groups was also put forward in the RAMP project (as a point c) in their conclusions):

Put up examples of pupils' own questions on display. Invite groups to look at and perhaps work on other groups' questions (Ahmed, 1991, p. 19).

Civil made a distinction between three different kinds of mathematics, and she explained the difference between them, and their implementations in the classroom. The second kind, which she called "Mathematicians' mathematics in the school context", involved an aspect of collaborative work in small groups. One of five points describing this kind of mathematics was that:

(...) the students collaborate in small groups on challenging mathematical tasks and are encouraged to develop and share their own strategies (Civil, 2002, pp. 42-43).

This is quite similar to the approach found in Ann's class, and also by Thomas and Ingrid, as well as many Japanese classrooms, and it has also strong connections with the idea of (guided) re-invention.

Cooperation is also one of the main issues in situated learning, which have as some of the main principles: an authentic context, cooperation and social interaction (cf. chapter 2.4). Cooperative learning and cooperation were also important in Freinet's pedagogy, and in the Dalton schools, where an important aspect was for the pupils to explain problems to each other.

A main idea of constructivism is that pupils should get the opportunity to construct their own mathematical concepts, and when solving rich problems in groups, the collaborative aspect is also included. Cooperative groups appear to provide rich opportunities for the pupils to learn from each other, to draw upon experiences from their own everyday life, to discuss mathematics and construct (or re-invent) the mathematical theories. The classes of Thomas and Ingrid, as well as some of the Japanese classes from the TIMSS 1999 Video Study, provide nice examples on how this can be done, and they also imply that the teacher has an important role. For cooperative learning and group work to be successful, the teachers need to be conscious of their role, and the preparation for such an approach seems to be important.

10.1.2 Re-invention

Re-invention or reconstruction is often connected with the Dutch tradition of Realistic Mathematics Education (RME). The approach has its roots in constructivism, and it is also among the intentions of our Norwegian curriculum.

Learners construct their own mathematical concepts (RMERC, 1999, p. 167).

According to L97, the pupils should also be given the opportunity to:

(...) investigate and explore connections, discover patterns and solve problems (RMERC, 1999, pp. 167-168).

The idea of reconstruction or re-invention was something our three teachers seemed to emphasise. In the questionnaire, Harry replied that “the pupils are actively involved in the (re-)construction of the mathematical theories”. Ann replied that it often was so, and Karin that this sometimes was the case for her. Karin further explained in the questionnaire, that “the pupils need lots of knowledge in order to create a mathematical formulation of a problem”. Her idea was that it is her job as a teacher to prepare the pupils for a process of reinvention.

Although this was something they seemed to focus on, we could not find much evidence of it in their teaching. One of the few examples was in Harry’s class, where he let the pupils participate in the reinvention of Pythagoras’ theorem. The pupils were given a sheet with the well-known (to us) figure that gives a geometric illustration of this theorem (see illustration 22, p. 177). They were supposed to cut out the pieces of this figure with their scissors, rearrange them and in the end write down a mathematical sentence describing what they had found.

A similar example was found by Thomas and Ingrid in the pilot study, where the pupils worked cooperatively in their groups with exercises that lead to a reinvention of the basic issues of trigonometry (sine, cosine and tangent). These were concepts that were unknown to most of the pupils, so it seemed to be a matter of true reconstruction to most of the pupils.

A possible explanation for the apparent discrepancy between the teachers’ beliefs (their replies to the questionnaire) and actions in this instance, could be connected with their interpretation of the question in the questionnaire. The question was for the teachers to mark the following statement with very often, often, sometimes, seldom or very seldom: ‘The pupils are actively involved in the (re-)construction of the mathematical theories.’ Our intention was that this question would imply how much emphasis the teachers put on the process of re-invention or re-construction, but there is a possibility of the teachers interpreting this question differently than our intention. It is possible that some teachers would interpret this question as ‘a process of construction is something the pupils are (automatically) involved in’, i.e. that reconstruction of mathematical theories is an integral part of learning rather than something they actually focus on in their teaching. The answers to this question could therefore give indications of the teachers’ ideas of learning mathematics rather than their beliefs or ideas of what they emphasise in their teaching. We should therefore be careful to conclude that there is a discrepancy between the teachers’ beliefs and actions on this specific instance.

Based on our knowledge from earlier reading about the role of RME, we expected that the Dutch classrooms would contain activities where the pupils were mathematizing and reinventing mathematical theories through realistic or real-life connected problems. In the analysis of videos from the TIMSS 1999 Video Study this was not so evident. In the videos we have analysed, they were working with real-life connected problems, but often in a traditional way. The pattern here seemed to be more of the teacher addressing the entire class in connection with review of textbook problems.

In Japanese classrooms, however, who had the least amount of real-life connections in the TIMSS 1999 Video Study, the situation was the opposite. It seemed to be a normal approach to let the class work with one or two rich problems in each lesson, letting the pupils spend time on solving the problem, discussing their solutions and strategies in class. We observed several examples where the pupils were guided through a process of re-inventing the mathematical theories in the Japanese lessons. The content of the lessons was normally purely mathematical, but the methods of work was often much like the ideas we know from the Dutch RME tradition.

These findings from the TIMSS 1999 Video Study were interesting examples on how ideas of connecting with everyday life and leading the pupils through a process of re-invention could be implemented in the classrooms. It was also interesting to see that many of the Dutch lessons focused so much on solving textbook tasks, whereas the Japanese lessons often had a more RME-like approach when it came to teaching methods, but not so much for the content.

If we focus on Dutch classrooms, we might argue that working individually with context problems, as the Dutch pupils often do, will lead the pupils into a process of mathematization and re-invention. This idea might have been advocated by textbook writers also, and it could be an explanation to the apparent lack of focus on re-invention in Norwegian textbooks. In the Japanese classroom, this process was more explicit, and the teachers organised their teaching in such a way that the entire group of pupils could be actively involved in this process. With focus on the individual pupil, it might be true that the Dutch pupils were mathematizing and reinventing, and we observed that they were working a lot with real-life connections in (textbook) problems. The Japanese classrooms also fit the ideas of RME well, although the starting point was not always a context problem. The focus was more on the group though, while in the Netherlands the focus seemed to be more on the individual pupil.

The idea of re-invention and letting the pupils construct and discover the mathematical theories are present in many curricula, but our study has provided evidence that this is difficult for teachers to apply in practical teaching. The Japanese lessons gave us interesting examples on how it can be done, and so did the example from the lesson of Thomas and Ingrid in the pilot study. The example of re-inventing Pythagoras theorem in Harry's class was also interesting.

The issue of re-invention is often mentioned in the theory. Smith (2000) quotes Piaget and claims that pupils have to invent or re-invent mathematics in order to learn it. Instead of simply explaining mathematics to them:

Children must "reinvent" mathematics, in situations analogous to those in which relevant aspects of mathematics were invented or discovered in the first place. They must construct mathematics for themselves, using the same mental tools and attitudes they employ to construct understanding of the language they hear around them (Smith, 2000, p. 128).

In the report from the LAMP project, which focused on low attainers in mathematics, it was stated that mathematics is:

(...) effectively learned only by experimenting, questioning, reflecting, discovering, inventing and discussing (Ahmed, 1987, p. 16).

When discussing the theory of re-invention in mathematics education, it is impossible to avoid the Dutch tradition of Realistic Mathematics Education (RME) following in the footsteps of Hans Freudenthal. Guided re-invention is one of the main ideas in this tradition, and Freudenthal himself connected the theories with history and the genetic principle (cf. Freudenthal, 1991, p. 48). The following, which was also quoted in the theory chapter, gives a nice overview of the understanding of re-invention according to the Dutch tradition:

In the realistic view, the development of a concept begins with an intuitive exploration by the students, guided by the teacher and the instructional materials, with enough room for students to develop and use their own informal strategies to attack problems. From there on, the learning trajectory leads, via structuring-, abstracting and generalizing activities, to the formalization of the concept (van der Kooij, 2001, p. 237).

Re-invention is closely connected with the idea of ‘mathematizing’ in RME. The notion of ‘mathematization’ was one of Freudenthal’s main concepts, and it describes the process of organising the subject matter, normally taken from a practical, real-life situation. When teaching mathematics, the emphasis should be on the activity itself and its effect, and the process of mathematization represents the manner in which the student re-invents the mathematical theories.

Discussing an issue like re-invention in mathematics education is difficult. On the one hand it represents a more general idea of constructivism. According to constructivism, reinvention is an integral part of the learning process. The pupils have to reinvent the theory for themselves in order to learn it. On the other hand, re-invention is an integral part of RME, and within this tradition it has a specific interpretation. Re-invention can therefore be described as an integral part of the learning process, or as a specific approach in the teaching of mathematics (as in the Dutch tradition of RME). We should also consider the possibility of L97 advocating the issue of re-invention as a specific teaching strategy, but that their (L97’s) understanding of the concept differs from the interpretation presented by the Dutch tradition.

In this thesis, we have mainly considered re-invention to be a teaching strategy (but we still consider reinvention to be a part of the learning process as suggested by constructivists), and we have tried to identify examples of this approach by the teachers. Some examples have been found, like Harry’s reinvention of Pythagoras and the reinvention of the basic trigonometric concepts in the class of Thomas and Ingrid. It is important to notice the differences in the role of the teachers in these two examples. In the reinvention of Pythagoras, Harry went further in his intervention than Thomas and Ingrid did. Harry explained more to the pupils and gave some more indications as to what they were going to find out than Thomas and Ingrid did. Thomas and Ingrid seemed to be more conscious about not telling too much, and they wanted the pupils to figure it out for themselves. This was especially apparent when they realised that one of the pupils in their class had already learned about trigonometry in his old school. Thomas explained in the interview that they had asked this pupil specifically not to tell the other pupils in his group what he knew, but rather let them figure it out for themselves. Similarly, Freudenthal considered it to be a crime to present to the pupils something they could have figured out for themselves (Freudenthal, 1971).

10.1.3 Projects

Projects are important according to the Norwegian curriculum, and the use of projects and small-projects are explicitly mentioned in the area of mathematics in everyday life also. The curriculum states that the pupils in the 9th grade should have the opportunity to “use mathematics to describe and process some more complex situations and small projects” (RMERC, 1999, p. 180). In 10th grade they should have the opportunity to “work on complex problems and assignments in realistic contexts, for instance in projects” (RMERC, 1999, p. 182). The last quote indicates that projects can actually be a way of implementing problems with realistic contexts, or more generally to make connections with real or everyday life.

Some of the textbooks, like the textbook Harry’s class used (Breiteig et al., 1998a), has an emphasis on projects. The book presents itself as a textbook that takes L97 seriously, lets the pupils create, use and understand mathematics, connects mathematics and everyday life, provides good opportunities for differentiation, builds on the pupils current knowledge and suggests computer technology and projects (according to the back cover of the book). At the end of each chapter, the author discusses suggestions for possible projects, so the intentions presented on the back cover are implemented in the book. Other textbooks do not make suggestions for projects.

In our case study of three teachers, Harry seemed to be the one that focused more on projects. In the questionnaire he replied that he often uses projects, whereas Ann and Karin only seldom and very seldom use projects in their teaching of mathematics.

In the interviews, Harry explained that he did not follow the more formal project ideology a lot. He rather had a focus on small-projects and activities. He gave some examples of projects that his pupils had been involved in, and they included finding geometric shapes in industry sites, draw shapes and patterns on a quadratic piece of paper with only pencil, ruler and compass. When the teacher training college (in their neighbourhood) was last rebuild, he guided a group of pupils to the construction site and asked them to make all kinds of measures and estimations of size, weight and volume.

Karin was the one who claimed to use projects the least, and she explained that she did not care much about project work. Project work demands lots of knowledge, she said. In her teacher training college back in the 1970's, she had some bad experiences where their teacher said that it is no use in knowing things, and the students had to tell him what they wanted to learn. This was a little 'dream world', according to Karin. She did admit in the interview that there are many positive elements in project work. She therefore would not say that she is completely negative, but she is opposed to the emphasis that this way of working has been given. Some pupils go through school doing not much more than drawing front pages to their groups' project reports...

Ann replied in the questionnaire that she seldom uses projects, and she further explained that she found it hard to implement mathematics in projects involving other subjects. It became clear from the interviews that she mainly thought of larger projects with several subjects involved. Ann explained that she found projects important. In larger projects involving several subjects, mathematics should also be incorporated, but this was something she found difficult.

Several examples of projects were found in the classroom observations. Many of these examples were found in Harry's lessons. In one of the examples, his class was divided in two groups and taken to the woodwork room. Their project was to make right angles of wooden sticks, using their knowledge of Pythagoras theorem (and what Harry called 'carpenter knowledge'). Harry first explained how it worked, and the pupils then made the angles of sticks and pieces of wood. Many practical issues came up, like the width of sticks, how they should be connected, etc. Another interesting example was the bicycle assignment. The pupils were told to draw a bicycle in scale 1:5. Some of the pupils had brought their bicycles to the classroom, so that they could do all the measures they needed in order to make the best possible drawing. They were asked use geometrical shapes, and make exact measures of lengths and angles. This brought up some interesting discussions about brakes, speedometers, etc. The pupils worked in pairs, groups as they chose.

We did not see any examples of projects in Ann's class, but with Karin, who claimed to use projects very seldom, we observed two nice examples of projects. In the first project, the pupils were creating tiles. They worked in pairs and created paper-tiles with different geometrical patterns. The goal was to make four different patterns in each group. The second project was in the introduction to the chapter on statistics. Karin started with presenting an example on how they could make a small survey in the class. She asked everyone how many brothers and sisters they have, and wrote down the results on the blackboard. She then put the information into a frequency table and created a diagram to display the results. The pupils were then put in pairs and asked to make similar surveys on their own in the class. Karin wrote down the aims on the blackboard: "Make a survey, put the results into a frequency table. Create a diagram. Come and show me your results" There were many interesting surveys, like: "How many horses are on your field?" (not everyone lives in a farm...) "How many have you slept with?" (a rather 'dangerous' topic, and a bit too personal also...)

This last project we observed in Karin's class matched the curriculum description well:

When dealing with a relevant theme or problem area, pupils will be able to collect and analyse information using the language of mathematics, to develop results using methods and tools they have mastered, and to try out their approaches on the matter in question (RMERC 1999, p. 178).

This finding corresponds with the results of the evaluation study of L97 (Alseth et al., 2003), which concluded that most teachers still teach traditionally in their everyday teaching. They make no particular connections with real life. Occasionally they organise more extensive activities, like projects, where the pupils work with many real-life connections in a setting that coincides more with the aims of the curriculum.

The analysis of TIMSS videos did not provide many examples of projects. One example was from a Dutch classroom, where the pupils observed and registered pedestrians and cars that were passing outside their classroom windows.

Many research reports and publications have discussed projects, and in our review of theory we could find several examples of this. Boaler's study of teaching at the two schools called Phoenix Park and Amber Hill is one example. Phoenix Park had a progressive philosophy, and this was especially noticeable in the teaching of mathematics. The pupils at this school normally worked with projects of an open character, and they had a large degree of freedom (cf. Boaler, 1997).

The emphasis on projects was also visible in the High/Scope curriculum as well as in the Everyday Mathematics curriculum.

Our findings indicate that there are different understandings of what projects are. One explanation is that projects have to follow a specific approach, and that they have to be formal and often involve other subjects. This appeared to be Ann's understanding of projects, and she found it difficult to incorporate mathematics in such projects. Harry, on the other hand, had an understanding of projects more as activities, and he used the notion of small-projects. This notion is also found in L97, and the curriculum indicates that both these understandings could be implemented in teaching.

10.1.4 Repetitions and hard work

This category could have been given other labels also, like 'traditional teaching' for instance, but 'repetitions and hard work' was chosen for it to be more inclusive. 'Traditional teaching' is a difficult term, and it might not even be a good one. In our analysis process, we found it more appropriate to focus on the content, analysing the teaching, choice of methods, etc., rather than judging something as 'traditional'.

Some teachers focus a lot on the textbook, and their pupils solve many textbook tasks during the lessons. Among the three teachers in the main part of our study, Harry seldom started with a focus on textbook tasks, whereas Karin often let her pupils solve many textbook tasks and Ann very often did so, according to their replies in the questionnaire. Harry further explained, in the interviews, that he had an emphasis on understanding more than learning rules (or skill drill, as it is often referred to). This did not mean that he never wanted his pupils to learn rules. Some rules have to be learned by the pupils, he said, like the area of the circle. This was something his pupils just had to learn (by heart).

Karin had a strong focus on what she referred to as brain training and concentration. She explained in the interview that one of her main ideas was that her task as a teacher was to prepare the pupils, to exercise their brains. She said that the reason why pupils do high jump in school is not because they are all going to become athletes, but because they need to exercise their body. The same is the case with mathematics, according to Karin: the pupils do mathematics because they need to exercise their brain (not because they are all going to become mathematicians).

Harry said that there were some rules that his pupils just had to learn, and an example of this was found in a lesson where the pupils were given a small test to see if they had learned their homework. The test was about angles and names on the angle. Harry explained that this test was just as much for him as a teacher, to see if the pupils had understood what they were supposed to have learned.

In Karin's class there was a strong focus on repetition. After a couple of lessons where the pupils had been introduced to algebra, Karin started a lesson with repetition. She wrote down an example on the blackboard ($8x - 5x$), and asked the pupils different kinds of questions, like: "What should be in front of 5 and why?" (a minus sign); "What is the answer to this?" ($3x$); etc. After this repetition, where the pupils only listened, and did not write anything in their rule books, they started working with textbook tasks. Another example was when the pupils were given the opportunity to prepare for a test they were having the next day. They spent the entire lesson solving repetition tasks from the textbook, only interrupted by Karin, who occasionally gave some comments and examples from the blackboard.

In Ann's class, the pupils often worked individually with textbook tasks. In such sessions, Ann sometimes interrupted them with some repetition of related issues that they had been introduced to in a previous lesson. The pupils had a weekly working plan to guide their work. They were often working with tasks on different levels, although they were all working on the same main topic.

When this category was called 'repetitions and hard work' rather than traditional teaching, it was because these are often considered to be aspects related to so called 'traditional teaching'. A common misunderstanding is that according to the 'new' way of teaching mathematics (i.e. according to L97), the pupils are not focused on learning, but to work with the issues. Teachers find that they do not have enough time for teaching this way, and they often end up teaching the way they have always done.

We believe, however, that repetitions and hard work are certainly important elements of the teaching of mathematics according to L97, and what might be referred to as a progressive approach to teaching. The pupils have to learn something, and working with projects, re-invention, etc., demands hard work from the pupils as well as from the teachers. What we refer to as 'traditional teaching' is an approach that starts with a presentation of the theories (from a textbook) and is followed up by letting the pupils practice solving exercises from the textbook. This approach involves repetition and hard work, but these are not components that are bound to this approach alone. The approach described in L97 differs mainly when it comes to how the concepts are presented and how the pupils approach the mathematical content.

This category has strong connections with the next one, which is about textbooks. So far, the categories we have discussed here have all been concerning activities that the teachers organise in their classes. The next main theme has a focus on the sources that teachers use, directly or indirectly.

10.2 Content and sources

10.2.1 Textbooks

In the questionnaire, Harry replied that he seldom started with a focus on solving textbook tasks, whereas Karin, on the other hand, often started teaching theory and then let the pupils practise solving textbook tasks. Karin further explained that it seems to be a strong tradition among teachers to cover everything in the textbook.

In the interviews, Harry said that he found it strange that teachers are so driven by the textbook, especially since mathematics, in his opinion, is such a practical subject. He claimed to use textbooks (1) to get an overview of the content (for himself) and (2) as a source of tasks for the pupils' homework. Harry said that he liked the textbook they were using, because it had lots of content (follow-up material, extras) and it did not have so many sets of similar tasks for practice, repetitions, etc.

Karin and Ann used a different textbook than Harry, but they also liked the textbook they were using. Karin said in the interview that she liked it when textbooks present sets of tasks sorted after levels, and Ann explained that she liked their current textbook because it had many good examples and was self instructing.

Ann further explained that she felt too bound by the textbook. The textbook guided the teaching, and the exam also had a major influence. Ann said that when the aim is to change teaching, one also has to change the evaluation form (exam).

Harry did not have a strong emphasis on the textbook, he told us, and he mainly used it as a source of exercises when the pupils were going to practise at home what they had been working with in class. This was also evident from the classroom observations. The pupils mostly worked with different activities and small-projects in school, and then they solved textbook tasks for the homework assignments. In the following lessons, Harry sometimes spent some time explaining to the whole class some difficult issues from the homework assignment. On some occasions, the pupils also solved textbook tasks in class, like when they were presented with the problem from the illustrated science magazine. When the pupils had finished working on this problem, they continued solving textbook tasks.

To start teaching theory and then let the pupils solve textbook tasks, was an approach that we could observe in several lessons, and it seemed to be a normal approach for Karin. The pupils were solving many textbook tasks in class, and they often worked individually. Those who wanted to were given the opportunity to work in pairs. Karin often put down sets of tasks on the blackboard, or in the weekly working plan, and these sets of tasks were normally divided in three levels: A, B and C. This division was made already in the textbook.

In one lesson, Karin let the textbook 'replace' her as a teacher. This was done in the way that one of the pupils started reading a passage from the textbook for the whole class. After a while, another pupil took over reading, and then another, etc. They spent quite some time reading from the textbook, only interrupted by Karin making some comments and explanations on the blackboard. At one stage, Karin wrote down some passages on the blackboard that the pupils were told to copy into their rulebooks. After this session, the pupils started solving textbook tasks again.

Ann had an approach that was similar to Karin's, in that she also started many lessons with presenting some theory, and then let the pupils solve tasks from the textbook.

Many mathematics teachers, at least in Norway, are dependent on the textbooks. In our study we have seen examples of teachers who used the textbook a lot in their teaching, and sometimes as the main or even only source of material. This is not to imply that we believe this is a wrong or insufficient approach. Textbooks are supposed to be a source for the teachers, but the curriculum implies that other sources should also be drawn upon. Teachers appear to depend on the textbook though, and their teaching would therefore be influenced by these textbooks. Dutch textbooks, for instance, have a strong focus on problems connected to real life, and we would therefore assume that Dutch classrooms – through the textbooks – would involve many real-life connections in problems.

From the TIMSS 1999 Video Study, we learn that the Dutch classrooms contained the highest amount of real-life connections. Our analysis of videos indicated that the textbook was an important source or tool for the teacher. This was supported by the analysis of the public lessons. The researchers' comments to the public videos indicated that more than 75% of the Dutch lessons relied on the textbook. In the videos we analysed, the Dutch pupils spent a lot of time working individually with textbook tasks. The TIMSS 1999 Video Study revealed that individual work accounted for 90% of private work time per lesson in the Netherlands, and 55% of the time per lesson was spent on private activities. This indicates that a large amount of the real-life connections in Dutch lessons were through tasks presented in the textbook.

Japan was the country with the lowest amount of real-life connections in the TIMSS 1999 Video Study, and our analysis of videos indicates a significantly different teaching practice from that in many other countries. A normal approach in Japanese classrooms was for the pupils to work with one or two rich problems per lesson. These problems were different from common textbook tasks, in that the algorithm for solving the problem was not always given. The teachers presented a problem at the beginning of the lesson, often with help of some kind of concrete material, and then the pupils would spend some time trying to solve this problem. While the pupils were working, the teacher would walk around and actively observe what they were doing, what methods the different pupils were using, etc. After a while, the pupils were given the opportunity to present their solutions and solution methods to the class. The teacher had then picked out some pupils that had different kinds of solutions and algorithms to present their ideas, and the teacher discussed these with the class. The pupils were often guided through a process of deciding which solution(s) was better, and which algorithms were more appropriate. This was quite different from the Dutch approach, and also from the way Karin and Ann normally started with the presentation of the theory and methods and then let the pupils solve textbook tasks.

In Boaler's study (Boaler, 1997), the school called Amber Hill was described as traditional. The teaching was traditional, and often strictly textbook based. The teachers normally started with explaining the rules and theory on the blackboard. The teachers would then tell the pupils what to do and they would work individually (although mostly seated in pairs) with some textbook tasks. If problems were encountered, the teachers would come along and help them. A similar approach was also found in some of the classrooms in our study of Norwegian teachers, for instance in Karin's classroom. Boaler explained that the pupils worked devotedly in these classrooms, and the mathematics teachers had good contact with the pupils, and this seemed to be the case for Karin also. After Boaler's study, the more progressive school, Phoenix Park, returned to a more textbook based teaching to adjust to the governmental initiatives.

The connection between curriculum intentions and textbooks has appeared to be important, especially since so many teachers seem to have the textbook as the main source in their teaching. In Norway, there is no longer any governmental control with the textbooks, which was the case before, in order to assure that they represent the curriculum intentions. The Everyday Mathematics curriculum is different, in that it not only includes a curriculum paper, but also textbooks, teacher manuals, resource books, etc.

The connections between curriculum intentions and textbooks have also been emphasised in Japan (cf. Stevenson & Stigler, 1992). There are only a few different textbook series that dominate the Japanese market, and all of them have to fit the intentions of the curriculum. These textbooks are not so different from each other, although they might have different ways of presenting problems and the order in which the concepts are presented might also be different. Japanese textbooks are quite thin. They contain few illustrations, and they depend on the teachers to assist the pupils.

The report from the British RAMP project (cf. Ahmed, 1991) displayed a list of ideas for the teachers. One of these were concerning textbooks directly:

1) Think how you might “twist” tasks and questions described in textbooks or worksheets to involve pupils in making more of their own decisions and noticing things for themselves.

This suggestion implies a view of learning where the pupils need to take an active part in the construction of knowledge. Another suggestion from the report was related to the category of repetition and hard work, and it was a suggestion for the teachers to consider ways of involving pupils in generalising before teaching generalisations.

The connections with everyday life, or lack thereof, have been discussed for years. Already in 1868 Bergius criticised the organisation of Swedish textbooks, because they supported routine learning of several similar tasks with little connection to the pupils’ everyday life (cf. Prytz, 2003). A more recent publication displays a similar discussion:

Although schools aim to prepare students for some combination of everyday, workplace, and academic mathematical practices, traditional school mathematics has provided access mostly to school mathematics. Textbook word problems do not parallel the structure of everyday problems, which are open-ended, can be solved in multiple ways, and require multiple resources, including tools and other people (Brenner & Moschkovich, 2002, p. 7).

Most teachers rely upon one or a few textbooks to guide their classroom instruction, and they need guidance in order to change their teaching practice (cf. Lloyd, 2002).

10.2.2 Curriculum

The Norwegian curriculum, L97, has a strong emphasis on mathematics in everyday life, and this has become one of five main areas for mathematics. This area is different from the other four, in that it is a more superordinate area that is supposed to show how mathematics can be placed and used in a social and cultural context. Words like ‘meaningful’ and ‘useful’ are applied in this connection, and mathematics should be directly connected with the pupils’ personal experiences. The curriculum provides several practical suggestions for this area, and a process of re-invention can be identified.

A challenge regarding the implementation of the curriculum intentions is that mathematics in everyday life was not supposed to be taught as a distinct topic. It was supposed to be a superordinate area or topic that should be woven into all the other main areas. Some teachers seem to have the impression that this is yet another area that they have to teach in addition to all the other areas like algebra, geometry, etc. If this is a main impression among Norwegian teachers, it might lead to a lower emphasis on mathematics in everyday life, because many teachers seem to experience a significant time pressure and the ‘traditional’ areas are often believed to be more important.

When the mathematics part of L97 was created, international curricula and research was analysed, and several key ideas from L97 can be recognised from other curricula. The Norwegian culture in general is strongly influenced by English speaking countries, especially the US and Great Britain, and important documents like the NCTM Standards and the Cockroft report appears to have had a strong influence on the formation of L97.

When NCTM published the first curriculum standards in 1989, the emphasis was on mathematical understanding. The pupils should frequently use mathematics in order to solve problems in the surrounding world. Like in our previous Norwegian curriculum, M87, the Standards presented problem solving as a central goal. Word problems were an important part of this goal, and these word problems should often reflect everyday situations. Word problems created by the pupils were also mentioned as a possible strategy. These ideas are clearly adopted in L97, although the emphasis

is on mathematics in everyday life rather than problem solving. The idea that meaningful situations from everyday life should be the outset, rather than simply applying mathematics on problems from

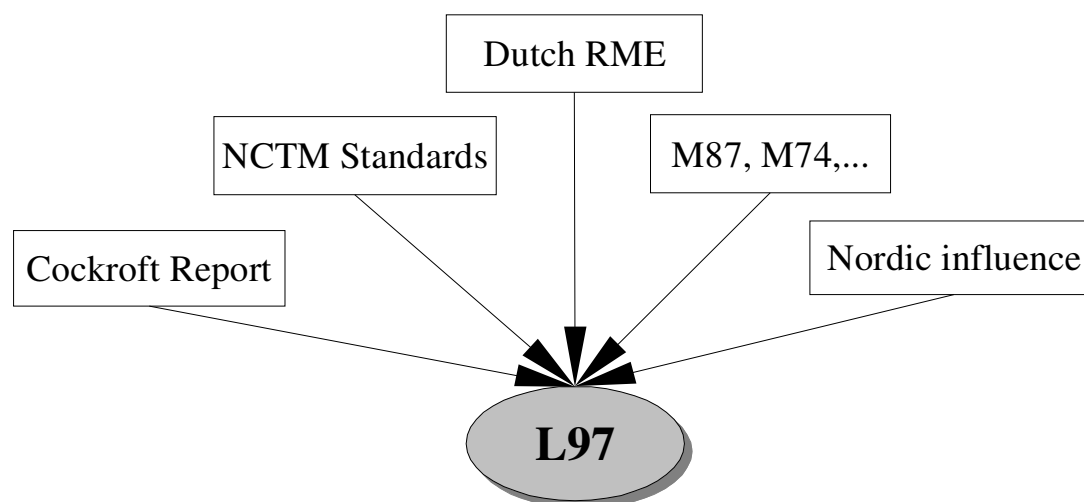

Illustration 24 L97 - main sources of influence

everyday life (cf. RMERC, 1999, p. 167), seems to originate in the Dutch tradition of Realistic Mathematics Education, which also influenced the Norwegian curriculum development.

The Cockcroft report is a central document, and it includes discussions of central ideas like usefulness, practical tasks and connections with everyday life, pupil activities, etc. Some teachers believe that if they are only going to teach mathematics that is practical or connected with everyday life, this would limit the subject too much. Thomas and several of his colleagues at school 2 expressed a similar concern. The Cockcroft report concluded that it is possible to sum up the mathematical requirements for adult life as ‘a feeling for number’, and much of the need for employment as ‘a feeling for measurement’ (Cockcroft, 1982, p. 66). This implies that practical use of mathematics and the connection with everyday life cannot be the only parameter by which to judge mathematical activity in school.

There are many indications that the intentions of a curriculum are not easily transmitted into teaching practice, and further into pupils’ learning (cf. Alseth et al., 2003). Our study supports this. Findings from our study also indicate that the curriculum intentions are not even easily transmitted into the textbooks, and the textbooks are among the most important (if not the most important) sources that teachers use in their everyday teaching practice. The connection between curriculum intentions, textbooks and teaching practice is therefore an important one, and it is a connection that should receive much attention in the development of new curriculum reforms. In addition to the curriculum framework as such, the Everyday Mathematics curriculum provides textbooks, teacher manuals, resource books, etc. Teachers who follow this curriculum receive special training in the use of this new curriculum material. By following a similar model, there should be better chances for the curriculum intentions to be implemented in the textbooks and further in teaching practice (and finally in pupils’ learning). Norwegian schools decide what textbooks to use (there are several different textbooks), and there is no longer a controlling instance to ensure that the curriculum intentions are implemented in the textbooks. When L97 was introduced, the teachers followed regular courses to learn about the curriculum intentions, but such limited courses do not seem to be enough to change teaching practice. The evaluation of L97 (Alseth et al., 2003) concluded that the

teachers' knowledge about the curriculum and the curriculum intentions was good, but it was only to a small degree that this knowledge had transformed into a changed teaching practice.

10.2.3 Other sources

The textbook has been, and still seems to be, the most important tool or source for the mathematics teacher. The national curriculum, L97, gives a description of mathematics and mathematical activities that strongly imply a different way of working with mathematics. The curriculum also presents several concrete suggestions of sources to use, such as situations from the media, bring in the pupils' own experiences, small-projects and computer tools.

From the questionnaires, we learned that Harry claimed to use other sources than the textbook very often, while Karin and Ann only sometimes did so. The questionnaire gave some further clues about what other sources Harry used. In some following questions he replied that he often used open tasks in his classes, and situations from the media were also used often, and the pupils sometimes got the opportunity to formulate problems from their everyday life. Although Harry appeared to be an innovative teacher with many ideas, he said that he would like teachers to have a common source of ideas for activities and good problems. In the interviews, Harry explained that he often found problems and tasks from old exams and tests. He also let his pupils solve problems from the KappAbel contest, which has a database of problems. According to Harry, there are not many good computer games for use in school. Some games that he had good experiences with were "The incredible machine" and "Crocodile Clips". The teacher manual was also a source that he frequently used, and he had gained many ideas from a book called "Matematikkens krydderhylle". Sometimes he used the internet in his teaching, but he explained that it is hard for the pupils to find appropriate information there without help from the teacher. Much of the information that can be found on the internet is simply too difficult to understand for the pupils, and it can be hard to decide what information that is trustworthy. When Harry used the internet in his teaching, it was mainly to wake the pupils' interest.

Both Karin and Ann replied that they sometimes use other sources than the textbook, but the questionnaire did not give any indications as to what these other sources might be. Both replied that they seldom use open problems or tasks, Ann seldom used situations from the media while Karin very seldom did so, and Ann seldom let the pupils formulate problems from their everyday life while Karin very seldom did so.

Karin told in the interview that she used the pupils' book a lot. She often told the pupils to take up their rulebooks and write certain things down. This approach was inspired from a biology teacher she once had as a teacher herself. She further explained that while it is nice for the pupils to use the pocket calculator, it is more important that they get an understanding of multiplication, division, etc. A problem with elementary school, according to Karin, is that so few teachers are mathematicians. The textbooks present problems connected with all kinds of issues from everyday life, but the pupils are not made aware of what they are actually working with.

Although Ann claimed to use other sources only sometimes, the interview with her gave us the impression that using other sources was something she wanted to do more. She explained that a main idea for her was to draw upon the parents and their knowledge. Her wish was that they could participate and share their knowledge. She had also made contacts with a couple of banks, which had expressed a positive attitude towards visiting the class and talk about issues related to economy, etc. In the interview, Ann also said that she sometimes use the teacher manual and the resource books as a source of ideas, and she had tried to use the internet to find good examples. She had also experienced that working with ICT tools can activate pupils, and some of the weaker pupils excel when put behind a computer.

The classroom observations provided some practical examples of how the teachers used other sources than the textbook in their teaching, and these observations were mostly coherent with the professed beliefs that could be distinguished from the interviews and the questionnaires.

In Harry's class, we observed some nice examples of how he used the internet in his teaching. He had prepared the lesson by finding some appropriate web sites for the pupils to visit, to assure that they would actually find some interesting information rather than playing around. The pupils were sitting alone or in pairs in front of the computers, and they were asked to search some web sites for information about Fibonacci numbers and the golden section. In these web sites they found examples of how heart rhythm and many other issues that occur in nature relate to the Fibonacci numbers. After the internet session, Harry had a discussion with the class, and the pupils told what they had found. Some of the issues were further discussed, like how the golden proportion can be found in letters that pupils write. This resulted in some nice activities among the pupils. In another lesson, Harry used a problem from an illustrated science magazine (the Norwegian magazine 'Illustrert Vitenskap'). He presented the problem for the pupils and explained how they could get started by drawing some helping lines. The pupils spent almost the entire lesson working with this and other problems from the science magazine.

Harry also used concrete items in several of the activities and small-projects he arranged for his pupils. In one of the projects the pupils were asked to make a drawing of a bicycle. This activity involved lots of measurements of lengths, angles, etc. In another lesson, the pupils were creating right angles of pieces of wood in the woodwork room.

Karin claimed to use the pupils' rulebooks a lot in her teaching, and this could be observed in the classroom as well. A common approach was for her to give an oral example to the pupils, tell them to find their rulebooks and start writing. She would often write down on the blackboard exactly what she wanted the pupils to write in their books. After a presentation of some examples and theory, the pupils would start working with textbook tasks. There were no observations of Karin making use of other sources than this in her teaching, except for in the two projects that have been described and discussed above.

In Ann's lessons there were a few examples of her making use of other sources than the textbook. In one example, she illustrated geometric shapes with a piece of paper (rectangle). She then showed the pupils how to get a triangle by cutting the rectangle along the diagonal. By ripping off the corners of the triangle and putting the corners together, she showed the pupils that the sum of angles in a triangle is 180 degrees. A similar example was also used by Jane in the pilot study. In another lesson, Ann handed out a paper with different kinds of geometrical shapes (some were more unusual than others), and the pupils worked in groups to find the areas of these shapes. In the end of the lesson they explained how they had found the areas and discussed different possibilities of finding the areas.

In the analysis of videos from the TIMSS 1999 Video Study, there were also some examples of teachers using other sources than the textbook. Some of the Japanese lessons had interesting approaches to the use of concrete materials. In one of the lessons, the pupils had been given as a homework assignment to bring examples of items that had the same shape but different sizes. The teacher had also brought some such items, and she used these to introduce congruence and similarity. In the following the pupils were constructing geometric figures of similar shape but different sizes, and they were lead through the discovery of the fact that shapes are congruent if the angles were similar.

In one of the lessons from Hong Kong, the teacher had also brought some concrete items, which he used actively in the lesson. First he introduced the pupils with some maps of the surrounding area, and the pupils were asked to figure out the scale of the map, and to calculate some distances. He also showed the pupils some Russian dolls, to illustrate three dimensional expansion.

The Hong Kong teachers and the Japanese teachers used other sources than textbooks to a large extent. One difference was perhaps that the Hong Kong teachers were more concerned about teaching the procedures, while Japanese teachers seemed more concerned about organising activities where the pupils could discover these procedures for themselves (Hiebert et al., 2003, p. 116). The Japanese approach, if we generalise, seemed to involve more elements of guided reinvention and mathematizing than the Dutch approach.

There are lots of nice examples of teachers using other sources than the textbook in their teaching, but the challenge is for the teachers to find such ideas and suggestions and apply them in their teaching. It is hard for teachers to come up with good ideas for every lesson, and Harry's call for a common source of ideas and suggestions for teachers seems to be relevant for many. Research projects like this, where different classrooms and teachers are observed and good ideas discovered, should provide an excellent basis for the creation of such a common store of ideas. Most teachers probably do not read research journals, scientific reports and dissertations though, so this material would have to be presented in a different form to benefit teachers.

10.3 Practice theories

10.3.1 Teaching and learning

Harry's theory of teaching and learning was strongly connected with the concept of activity. He explained in the questionnaire that he considered teaching to be 'teachers in activity', whereas the goal is pupils in activity. He further explained in the interview that the reason why he did not like teaching from the blackboard was that 'blackboard is teacher in activity and passive pupils'.

Karin, on the other hand, often used the blackboard to 'put things forward', and she often told the pupils to write certain things in their rulebooks. She explained in the interview that pupils have more ownership towards something they have written themselves. The normal approach for Karin, according to the questionnaire and the interview, was to start explaining the theory on the blackboard and then let the pupils practise solving textbook tasks.

In order to facilitate understanding, Ann proposed the following:

- 1) 'Activate' the pupils' existing knowledge,
- 2) pupils must feel that they deal with a problem they would like to solve, and
- 3) make the pupils conscious of how they think.

In the interview, Ann explained that an important part of her teaching philosophy is to arouse interest by the pupils, so that they really want to find answers to certain issues. In the interview she explained that she emphasises providing concrete examples and explaining things to the pupils in a way they could relate to. She also explained that she puts much emphasis on creating a good learning environment in the class, and this was something she had to focus on with her present class. This class was particularly noisy, and she was forced to spend a lot of time on creating an environment for learning (and teaching).

From the classroom observations we learned that Ann often tried to get a mathematical discourse with the class. In many lessons she would ask questions so that the pupils could get to the theory themselves, and she seldom presented the finished theory straight away. She did, however, often start talking about theory, and then let the pupils practise solving textbook tasks. When the pupils worked with textbook tasks, Ann walked around and helped them, and she spent much time with every pupil.

Harry's emphasis on activities came to show in the observations also. There seemed to be a focus on generating rich activities that would result in mathematical activities by the pupils, like in the example with Fibonacci numbers and the golden section, and in the bicycle assignment. We could observe how these activities appeared to create interest and enthusiasm by the pupils. Harry often started off with some kind of activities or small-projects, which he followed up in the next lessons. Only later did the pupils get homework assignments where they solved textbook tasks.

Karin's teaching was quite traditional, like she told us herself. After one of the lessons, she explained:

I just teach the way I have been taught myself. I am no more revolutionary than that.

In the analysis of videos from the TIMSS 1999 Video Study, we could identify a Japanese approach and a Dutch approach. The Japanese approach was more consistent with ideas of learning as a social process, at least to some extent, whereas the Dutch approach was more directed towards the individual. In the Dutch Dalton schools, however, there was a strong element of interaction among the pupils, and the teachers clearly emphasised that pupils should explain things to each other. It might be a weakness of the Dutch approach that a great deal of responsibility is left with the pupils. Not all pupils, at least not in compulsory school, are mature enough to handle such responsibilities. A more collective approach, like the Asian one, might be better.

The Japanese conception of pupils' errors and mistakes was interesting. Errors and mistakes were dealt with in a constructive way, rather than merely being means of assessment. A possible suggestion could be for teachers to incorporate both the context problems from the Netherlands and the Japanese approach of collective discussion and reinvention of the theories. The pupils would then be encouraged to take an active part in the construction of mathematical theories, and they would thereby be more likely to develop an ownership towards the theories.

10.3.2 Vocational relevance

Vocational relevance is present in the upper secondary curriculum in particular:

This subject is common to all branches of study, and is supposed to strengthen the pupils' basic knowledge of and skills in mathematics, especially in respect to their needs in everyday life, life in society and vocational life. (...) The subject matter should as much as possible be connected with practical problem formulations in vocational life and everyday life, but the pupils should also get to experience the joy of exploring mathematical connections and patterns without having direct practical applications (KUF, 1999).

Even the curriculum for compulsory school (L97) mentions the applications for vocational life, and mathematics is regarded as an important foundation:

Mathematical knowledge and skills are an important foundation for participation in working life and leisure activities, and for understanding and influencing social processes. Mathematics can help individuals to master challenges (RMERC, 1999, pp. 166).

One of the main aims is:

(...) for mathematics to become a tool which pupils will find useful at school, in their leisure activities, and in their working and social lives (RMERC, 1999, p. 170).

For the usefulness in the pupils' working life, it will normally be a question of future rather than present working life, since most pupils do not have regular jobs (although some do). In upper secondary education, pupils are training for their future vocations directly in school, so for these pupils vocational relevance will be a matter of present as well as future relevance.

Despite this focus in the curriculum, the teachers in our study did not seem to emphasise the vocational relevance much in their teaching. Harry was an exception, and he explained in the interviews that he would like all teachers to be given the opportunity to visit some industry/handicraft site for a couple of weeks, in order to learn more about how they can connect mathematics, technology, sciences, etc., with what happens in real vocational life. The classroom observations did not give any further ideas on how the teachers (in lower secondary school) connected with vocational life or included this aspect in their teaching of mathematics.

The situation was different among the teachers in upper secondary school (the pilot study), where Jane in particular (who was teaching mathematics at a vocational school) put much emphasis on the connection with vocational life. Her pupils were training to become hair dressers, cooks, etc., and she explained:

Yes, so often it is the topic or the setting that is the door to some new topic in mathematics. And then you try to find mathematics within something that is familiar to the pupils within the vocation, and then you present the mathematics with a basis there (S1-teacher interview-1).

In her teaching there were several practical examples on how to connect mathematics with vocational life. The most interesting example was 'mathematics in the kitchen'. When her pupils had cooking lessons in the kitchen, Jane was following them as an extra teacher. She helped them with different things, but she was focusing particularly on connecting with mathematics and trying to make the pupils use strategies they had learned in mathematics when dealing with estimations, weighing, counting, etc. The mathematical content in these practical lessons were mainly quite simple, but the practical use of mathematics in many vocations is rather limited (cf. Cockroft, 1982), so this was only to be expected.

Vocational relevance is not a main topic of this thesis, and it was not emphasised by many of the teachers in the study. It is mentioned in the curriculum though, and vocational life must be considered as part of real or everyday life. For Jane's pupils, who were doing considerable vocational training in school, vocational life was part of their everyday life. For other pupils, the connection with vocational life is normally part of their future everyday life rather than their present everyday life, but still vocational life must be said to be part of real or everyday life in general. In this instance, a distinction between everyday life and real life could be regarded as proper. Real life could refer to life outside school, or the physical world, whereas everyday life could be interpreted as the part of real life that the pupils relate to in their everyday. Vocational life would thereby become part of real life but not everyday life to most pupils. For pupils in upper secondary school, it is, like George argued, part of the pupils' everyday life that they are going to start a vocational education, for instance as engineers.

10.3.3 Connections with everyday life

The connection of mathematics with everyday life is the main theme of this thesis, and although we have discussed issues like projects, group work, textbooks, etc., these are all related to our main theme. Here we are going to discuss the issues that are more directly related to the connections with everyday life, in the teachers' beliefs and actions, theory, curriculum development, etc.

In the questionnaire, Harry replied that he often emphasises the connection of mathematics with everyday life, whereas Karin and Ann sometimes did so. This corresponded with the observations from their teaching. An analysis of how the teachers connect mathematics with everyday life is more interesting than a distinction as to how much emphasis they put on such a connection, so the following discussion is aiming at answering the 'how' question rather than the 'if' and 'how much' questions. We have discussed the different activities and sources that teachers used above, and there were many interesting approaches. This section will focus on the issue of real-life connections (or the connection with everyday life) as such.

There are many ways for a teacher to connect mathematics with real or everyday life. Some of these possibilities are presented in the national curriculum (L97). The syllabus aims at creating close links between school mathematics and mathematics in the outside world. In order to build up the concepts and terminology of mathematics, day-to-day experiences, play and experiments are proposed (cf. RMERC, 1999, p. 165). L97 seems to distinguish between school, leisure time, working life and social life, and the so called 'outside world' should thereby include the latter three, since these are the parts of (everyday) life that take place outside of school. (It is because of this distinction in the curriculum that we have defined 'everyday life' to imply everyday life outside of school in this thesis, although school life is certainly part of the pupils' everyday life more generally.) Mathematics is supposed to be useful in all these areas.

The connection between school mathematics and mathematics in the outside world, which is manifested in the area called 'mathematics in everyday life', is strongly connected with a more general aim of the curriculum. The pupils should not only develop skills in the subject, but also understanding and insight, so that they can use mathematics in different contexts. Pupils should be given a chance to experience and become familiar with the use of mathematics at home, at school and in the local community. This should be done in a process of reinvention where the pupils create their own concepts, and the starting point for such a process should be a meaningful situation or problem. The real-life connections in L97 therefore seem to incorporate at least two aspects: 1) being able to use mathematics in situations outside of school (as well as in a school context), and 2) to start with a process of reinvention from a meaningful situation (which could be from real or everyday life), in order to create a better understanding and insight by the pupils as opposed to mere factual knowledge. The meaningful situations that should be starting point for a process of reinvention do not have to be from real or everyday life, but this is a possibility. Rich mathematical problems can also be used as a starting point, as observed in some of the Japanese classrooms.

The curriculum (L97) describes what the pupils should work with, and the goals and contents for the area of mathematics in everyday life appear to be quite detailed. L97 puts more emphasis on the 'what' than the 'how', and although some methods are suggested, the teachers still have to figure out for themselves how the intentions can be implemented in actual teaching. The curriculum suggests, for instance, that the pupils in 8th grade should get the opportunity to 'work on questions and tasks relating to economics, e.g. wages, taxes, social security and insurance'. In one sense this is a concrete suggestion, but the teachers are still left on their own when it comes to how they are supposed to organise their teaching to do this.

The pupils are intended to construct their own concepts in a process of reinvention, with meaningful and realistic contexts as a starting point, and the pupils are also going to learn mathematics that they

can use in ‘the outside world’. These issues are complex, however, and they imply ways of teaching and learning that are quite different from what is normal in Norwegian classrooms (cf. Alseth et al., 2003). The curriculum suggests that teachers use projects and small-projects, but it remains for the teachers to figure out how these projects can be organised and applied in order to reach the curriculum intentions. The teachers themselves ask for a source of ideas and suggestions when it comes to how they can do things, and this is one of the issues we address in this thesis.

Teachers’ beliefs have strong influence on their teaching practice, and in order for a curriculum reform to be carried through, it is not sufficient to change the curriculum paper and textbooks only. A change of teachers’ beliefs seems to be important in order to change the teaching practice. This is a reason why this study has a focus on the teachers’ beliefs as well as classroom practice.

In the questionnaire, Karin explained that she focuses on understanding, logical skills and ‘brain training’. She did not consider it a main goal to teach the pupils how to solve problems that are useful in everyday life. Ann, on the other hand, put more focus on what is useful for pupils in everyday life, and she believed that it was mainly addition, subtraction, multiplication and division that the pupils used in everyday life. Her pupils often asked why they have to learn this, and what is the use for the particular topics in mathematics, so she did find the connection of school mathematics and everyday life to be a challenge and a main problem for teachers.

Some teachers, like Harry and George, questioned the notion of school mathematics. Harry found the concept itself problematic, and he explained that his definition of school mathematics is mathematical exercises on a piece of paper. He therefore did not focus on connecting with everyday life in textbook tasks, but rather with reality and technology as examples or starting point for rich activities that can arouse the pupils’ curiosity and enthusiasm. Harry wanted the pupils to work with mathematics in a new way, and he focused a lot on activities and experiments.

Karin was not fond of the idea of making (direct) connections with everyday life as such. Her focus was more on exercising the brain. She found real-life connections and ‘learning by doing’ too time consuming, and she therefore put more emphasis on presenting examples that pupils could understand and relate to. She described her way of teaching as taking the shortest way, i.e. to teach principles first, and then teach the applications, rather than letting the pupils ‘spend time in real life, fumbling around, and then some principles arrive’.

Problems from everyday life are often complex, and there is something new in every problem. Karin therefore found it hard to help the pupils with such problems, and she believed that practical problems are not the easiest for the pupils.

Practical examples of how to connect mathematics with everyday life was requested by some of the teachers in our study. Such examples and suggestions for teaching activities are not found in the curriculum, and only occasionally in the textbooks. One of the indirect goals for this study was to contribute to such a store of ideas and examples, and the analysis of these practical examples can provide important information about the issue of connecting with everyday life.

Harry’s teaching included several examples of real-life connections. In one lesson, Harry introduced what he called ‘carpenter knowledge’, in a more ordinary lecture-style. He told the pupils how carpenters indirectly use Pythagoras theorem to make right angles, and this knowledge was then used by the pupils in a small-project where they should create right-angles with pieces of wood. In another example, we experienced how Harry used the internet as a starting point for discussions with the pupils. Harry was particularly concerned with creating mathematical activities, and the bicycle assignment was a good example of this. The pupils used their mathematical knowledge and skills to measure and draw some real bicycles. In all these examples, the situations from real or everyday life were starting points, and they involved opportunities for the pupils to create or reinvent the mathematical knowledge.

Karin was more negative towards connecting with everyday life, but we have analysed several situations from her teaching that involved some kind of real-life connections. There were some examples where Karin used contexts from everyday life to illustrate some mathematical theory. In the introduction to algebra, she introduced an example with such a context: “If I bring 100 NOK to the shop, I first buy something worth 20 NOK, then I buy something worth 10 NOK. How much do I have left then?” The example is from a real-life setting, but unlike many of the examples from Harry’s class, where the pupils were involved in activities, Karin only referred to the real-life connection in a presentation of the theory. One might argue that this situation or context was used as a starting point, but it was the starting point for a further presentation of the theory rather than the starting point for an activity where the pupils were allowed to create or reinvent the theory. This is the main difference with the examples from Harry’s class, and with the curriculum intentions.

In other examples, the connections with real or everyday life became even more artificial (in that they obviously served as wrappings for the presentation of theory). Somewhere else in the introduction to algebra, Karin explained that when faced with an expression, like $8x - 5y$, we could always come up with a story to illustrate it. She then presented the pupils with a story that involved buying magazines for a certain weekly salary. In another lesson, Karin started by giving an example on how mathematicians are lazy. A writer could have written ‘one monkey plus one monkey is two monkeys’, she explains. Journalists, who apparently are somewhat more lazy, could write ‘ape + ape is two apes’. Mathematicians, on the other hand, are the most lazy, so they write ‘ $a + a = 2a$ ’. The real-life connection (the monkeys and apes, or even the writers, journalists and mathematicians) is clearly a wrapping that is presented in order to explain the use of letters instead of words.

Ann explained that she was positive towards connecting mathematics with everyday life, but she apparently had problems with the practical implementation of this in her teaching. The observations from her classroom only contained very few connections with real life. When she explained the concept of area to the pupils, she used an example from everyday life. If you are going to put floor covering on the classroom floor, what would you have to do before you could go to the shop and buy it? She explained how one could use bottles of mineral water to measure area in a different way. Square metres, she explained, is more appropriate a measure than bottles, and going to the shop to buy 637 bottles (area) of floor covering would not be a good idea. In this example, the real-life context is used as a wrapping for some theory. Unlike the example with Karin’s lazy mathematicians though, the context is used to elaborate on the explanation, rather than just being a wrapping. The issue about measuring areas was discussed, and the context of floor covering influenced the discussion. When comparing with the curriculum intentions, this example could also have been organised differently in order to serve as a starting point for a process of creation or reinvention of theory.

The analysis of videos from the TIMSS 1999 Video Study provided several interesting examples of connections with everyday life, and one of the most interesting observations was that so large an amount of the real-life connections that were observed in the Dutch lessons appeared to be related to textbook tasks. The Dutch lessons had about 42% of real-life connections (cf. Hiebert et al., 2003), but most of the connections analysed in our sample of videos appeared in individual work with (or review of) textbook tasks. The Japanese lessons, although having the least percentage of real-life connections in the TIMSS 1999 Video Study, involved methods and organisation of activities that were more in correspondence with the intentions of the Dutch tradition of Realistic Mathematics Education (RME) (and also with the intentions of the Norwegian curriculum, L97). The Dutch approach seemed to be more traditional, although having a large amount of real-life connections (mainly in textbook tasks). Guided reinvention and mathematization are key concepts in the Dutch tradition of RME, but these ideas seemed to be better implemented in the Japanese classrooms than in the Dutch classrooms.

Many teachers, in the Netherlands as well as in Norway, seem to believe that word problems in textbooks can be a way of implementing real-life connections. These word problems are, however, significantly different from everyday problems. Everyday problems are open-ended, can be solved in different ways, and require multiple resources (cf. Brenner & Moschkovich, 2002). The solutions and solution methods in problems that appear in school mathematics (including word problems presented in textbooks), on the other hand, are usually known by the teacher. This is a possible reason why some teachers, like Karin, find it hard (or even scaring) to use problems from everyday life in the school context.

There seems to be a gap between the everyday mathematical practices and school mathematics (as there seems to be a gap or glass wall between the real world and the world of mathematics), and Arcavi (2002) presented three concepts to discuss in order to create a bridge between these two worlds: everydayness, mathematization and context familiarity. The first included a discussion of what everyday is and for whom. Mathematization can be divided in horizontal and vertical mathematization. Horizontal mathematization is when a problem is moved from its context towards some kind of mathematics, whereas vertical mathematization is when pupils' constructions are formalised and generalised.

When school mathematics is connected with everyday life in textbooks, this is often done through word problems with some kind of realistic context. This is believed to be motivational and even useful for pupils. Carraher & Schliemann (2002) suggest that we should not be so focused on realism, because it is questionable whether a realistic context is really motivational, or even useful. Like the Dutch tradition, they suggest that we focus more on whether a problem is meaningful to the pupils. The constructivist tradition suggests that pupils should construct their own knowledge, and this construction (which is often a matter of reinventing something rather than constructing genuinely new knowledge) can be facilitated with a meaningful situation as a starting point, like L97 suggests. This meaningful situation does not have to include a realistic context, but it might. Now, to conclude that teachers should focus more on meaningful situations and problems does not necessarily make life easier. What is a meaningful situation? Meaningful for whom?

The word 'meaningful' might be equally troublesome as the words 'real', 'everyday' and other terms that we have discussed in this thesis. One possible explanation could be that meaningful situations are situations that pupils could relate to. Then it is possible to argue that situations from the pupils everyday life are such situations, and we would have returned to the starting point. Another possibility is to incorporate the Dutch definition of the word realistic, which means something that you could imagine. Although the words 'meaningful' and 'realistic' could have different interpretations, they are somewhat related, and it would be possible to define a meaningful situation as one the pupils could imagine (implying that it is sensible to them, something they can relate to). A definite interpretation of the word is hard to reach, but the main idea is to focus on how the pupils might relate to certain situations or problems. This appears to be a more sensible focus than just being concerned with whether the problem involves a context that could be related to real or everyday life. As we have seen, real-life connections in textbooks can often have an artificial appearance, and this could have a negative effect on the pupils' attitude towards these problems. In that sense, a focus on what the pupils would find meaningful could be a better solution.

This does not mean that real-life connections are no longer important. Supporters of the Dutch tradition of RME believe that (which is also a main idea of constructivism as such) the pupils need to reinvent mathematical understanding rather than having it explained. This reinvention will often include, or have as a starting point, situations from real or everyday life, since the mathematical ideas and theories often originated from practical situations and the urge to solve problems from real life. Similar practical situations or problems could often be used as starting points for a process of reinvention.

10.4 Answering the research questions

Based on the data material gathered and the discussions above, we will now formulate answers to our initial research questions. In chapter 1.4 two main research questions and six sub-questions were posed. We will now address them in the opposite order, first letting our findings constitute answers to the more concrete sub-questions, and then use these to see how our main research questions could be answered.

10.4.1 Are the pupils encouraged to bring their experiences into class?

The curriculum clearly implies that the pupils should take an active part in the construction of mathematical knowledge, and that they should draw upon their experiences from life outside school. In the main aims for mathematics, L97 states that the pupils should:

...be stimulated to use their imaginations, personal resources and knowledge to find methods of solution and alternatives through exploratory and problem-solving activities and conscious choices of resources (RMERC, 1999, p. 170).

The curriculum for the upper secondary education also implies this. One way to achieve this is for the teachers to encourage the pupils to take part in the formulation of problems. In the questionnaire, we therefore included a question where the teachers were asked how often they let the pupils formulate problems. The results showed a strong tendency towards not doing this, and more than half of the teachers answered that they seldom or very seldom let the pupils take part in the formulation of problems. One teacher, George, replied that he often let the pupils formulate problems. We only observed his teaching in one lesson, and we did not see this practised. The main tendency among the teachers was clearly negative to this issue, and we could not find any examples of this approach in the classrooms.

Letting the pupils formulate problem is only one of several possible ways of letting the pupils bring their experiences into class. Teachers like Harry and Jane had interesting discussions with the pupils, and they challenged the pupils to use their knowledge and experiences from outside school. Jane told us in the interview that she tried to learn about the pupils' interests and activities outside of school to be able to draw upon that in her teaching. Cognitive and constructivist theories of learning emphasise the incorporation of previous knowledge and experience, and some suggestions on how to do this are presented in the curriculum. One suggestion is to let the pupils register and formulate problems. However, this idea was not put into practice by the teachers we observed.

10.4.2 Do the teachers use examples from the media?

Situations from the media might lead to interesting problems that involve different mathematical issues, and making use of examples from the media could be an excellent way of connecting mathematics with real life. Finding good examples is not always a simple task, and teachers continually ask for sources of ideas.

In our survey we asked the teachers if they made use of examples from the media in their teaching of mathematics. More than half of the teachers replied that they seldom or very seldom did this. Only one teacher claimed to do this often. From the classroom observations we could only find one example of using examples from the media, namely in the lessons where Harry let the pupils solve problems from a science magazine. Letting the pupils work on a set of problems presented in a magazine was not exactly what we had in mind here, but the lessons were interesting. Some mathematics textbooks present tables, diagrams and statistical information that could have been

found in newspapers and magazines. The teachers could also present such material from the original sources, and we believe this would make it more authentic. Textbook problems are often experienced as purely mathematical, and when pupils are faced with similar problems in an out-of-school setting, they have difficulties using the mathematical methods and ideas they have used in a classroom setting. The opposite also seems to be true (cf. Carraher, Carraher & Schliemann, 1985).

10.4.3 Are the pupils involved in a process of reconstruction or re-invention?

When the question on whether the pupils were actively involved in the reconstruction of mathematical theories was posed in the questionnaire, we had in mind the notion of reconstruction or re-invention as presented in the Dutch tradition of Realistic Mathematics Education (RME). This is an issue from constructivism, and we find the idea also in L97, although the connection to RME is not clearly stated:

Learners construct their own mathematical concepts. In that connection it is important to emphasise discussion and reflection. The starting point should be a meaningful situation, and tasks and problems should be realistic in order to motivate pupils (RMERC, 1999, p. 167).

This idea is also present in the current syllabus for upper secondary education. When dealing with the answers to this question in the questionnaire, we must be aware of the possibility of the teachers understanding the concept of reconstruction in a different way than we intended. It is possible to say, in a more everyday language, that reconstruction is what happens when a certain theory is being recalled from the memory. Construction or constructivism as theory of learning might be understood in different ways and on different levels. We should be aware of these issues when the results are discussed. In the questionnaire, almost half of the teachers claimed that their pupils were often or very often actively involved in the reconstruction of the mathematical theories. The trend therefore seems to be very positive. When we observed their teaching in the classrooms, this tendency was not so visible however, and many classrooms could be considered traditional. There were some examples, nevertheless, where these ideas were incorporated, like in Thomas and Ingrid's lessons. During the short period we visited their class, we observed an example of how they let the pupils discover and reconstruct theories of trigonometry in their cooperative groups. In Harry's class we also observed examples of reconstruction in the introduction to Pythagoras.

10.4.4 What sources other than the textbook are used?

Studies have shown that the textbook is the main source of mathematical tasks as well as teaching ideas for many teachers of mathematics in Norwegian schools (cf. Alseth et al., 2003), and there are reasons to believe that this is the case in other countries also. We wanted to find out more about what other sources these experienced teachers also used, and we let the curriculum statements guide us in making proposals. When confronted with a question on how often they would make use of other sources than the textbook, more than half of the teachers replied that they would sometimes do so. The teachers also claimed to use the textbook quite often, and we would therefore assume that other sources could be used in occasional projects or mini-projects that would occur as breaks from the ordinary teaching. This would, in that case, eventually fit the results of Alseth et al. (2003). Finding out what these other sources might be was not so easy. Situations from the media and open tasks could have been among them, but none of these were used frequently by the teachers in this study. From the observations of classrooms we could find several examples of other sources in use, like objects from real life (boxes, maps, kitchen items, bicycles, etc.). Many teachers also requested help with finding sources of ideas for their teaching, even innovative teachers like Harry and Jane.

10.4.5 Do they use projects and more open tasks?

About two thirds of the teachers replied that they seldom or very seldom used projects, in spite of the fact that this is strongly suggested in the curriculum. In upper secondary school, the pupils are supposed to be engaged in one large project each year, and the teachers did not seem to present any additional projects to the pupils. In the plans for lower secondary school, projects and mini-projects are given even more emphasis, but even here many teachers seemed to be negative. Some teachers, like Ann, thought of projects as larger, multi-subject assignments. Others, like Harry, used different kinds of mini-projects. The teachers in upper secondary school told us that they had one large project per year in their classes, and that this was called for by the curriculum. Teachers in lower secondary school, like Karin and Ann also told us about larger projects that often involved other subjects than mathematics. The definition of projects turned out to be a main topic of discussion here, and most teachers expressed a strict understanding of projects. Only Harry practised using mini-projects, even though the curriculum explicitly suggested them as a tool for teaching mathematics and connecting with everyday life.

About 25% of the teachers claimed to use open tasks seldom or very seldom in their teaching, while more than half of them did this sometimes. It was hard to make any clear conclusions about this from the classroom observations also.

10.4.6 How do they structure the class, trying to achieve these goals?

Many teachers were still teaching in a traditional way, and this influenced the way they structured their classes. This was visible in the classes of Owen and Karin in particular, but also in those of the other teachers. Jane and Harry were exceptions, and both had a teaching practice that was different from the traditional approach. Neither of them emphasised groups in their organisation of the class, but both focused on activities. The pupils occasionally worked in pairs or groups in their classes, but this was not a structured approach. This was also the case for George, Karin and Ann, whereas Owen was opposed to groups. Thomas and Ingrid organised their classes in cooperative groups, and the pupils worked in the same groups in every lesson. The teachers had organised the groups rather than allowing the pupils to do so, and they had spent much time on getting the groups to work successfully.

10.4.7 Answering the main questions

It is now time to repeat the main research questions that we posed, to see how our findings so far provide answers to them:

- 1) What are the teachers' beliefs about connecting school mathematics and everyday life?
- 2) What ideas are carried out in their teaching practice?

It has been a main theme in this study to investigate the teachers' beliefs about connecting mathematics with everyday or real life. We have aimed at uncovering these beliefs through a triangulation of sources of data. The teachers have answered a questionnaire and they have been interviewed to find out what they believe about these issues. We have also observed their teaching for a period of time, in order to investigate how their professed philosophies correspond with the applied philosophies that we observe. When answering the questions above we are going to include both elements in one discussion, since we believe that they are closely connected.

One of the main issues that have emerged in this study, is that real-life connections or the

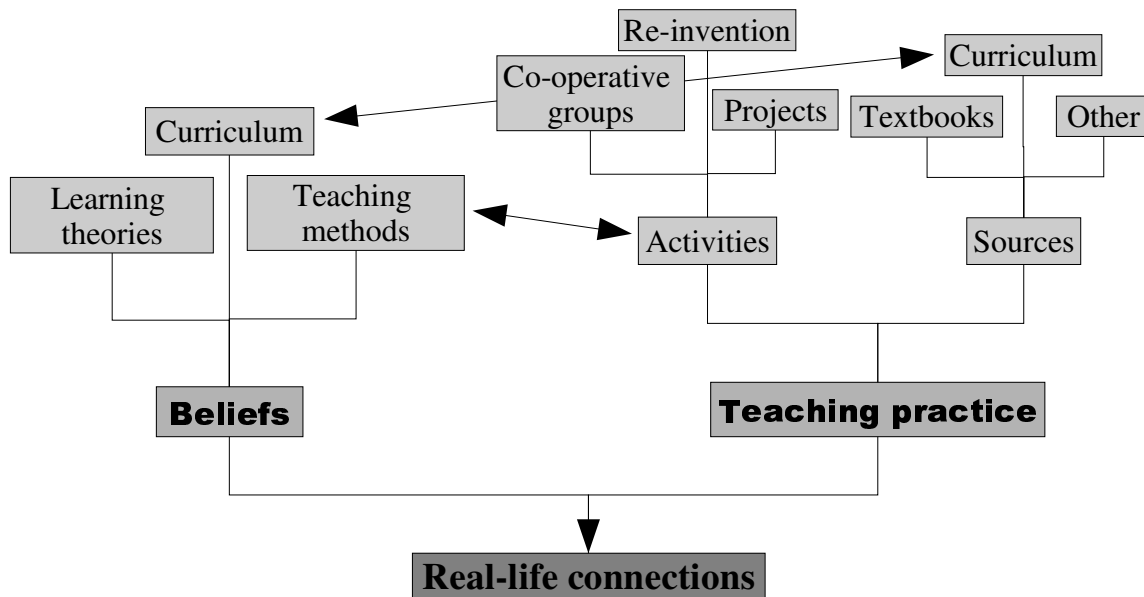

Illustration 25 Real-life connections, beliefs and practice

connections of mathematics with everyday life is a complex matter, which is illustrated in illustration 25 above.

In the introduction we presented a model of three extremes concerning real-life connections. Our hypothesis was that teachers fit into one of these categories, and we believe that a study of teachers from all the categories can teach us valuable things about real-life connections. It also turned out that it was less satisfying to discuss whether the teachers belonged to this or that group in the initial model of extremes, and a list of categories was generated that described their practice theories, the content and sources they used, and the activities and methods of organisation they used.

Harry and Jane were positive towards connecting school mathematics with everyday life, and they emphasised this in their teaching. Their approaches were different, however, and one reason for this could be that they were teaching at different kinds of schools.

Harry, who was teacher at a lower secondary school, emphasised mini-projects. These projects were often based on contexts from real life, and there was often a relation to technology and science. The pupils often worked practically with mathematics, and the activities were not restricted to the classroom arena. The pupils were often engaged in textbook tasks also, but this would normally be done at home. Harry would seldom start off with textbook tasks.

Jane worked in a vocational upper secondary school, and she was therefore more focused on connecting mathematics with the pupils' (future and present) vocational life. She displayed strong support for connecting mathematics with everyday and vocational life, although her methods of organisation, and partly her choice of material, were somewhat more traditional. She was regularly present with a group of her pupils in the kitchen. They were attending a program for hotel and nutrition, and Jane was going into practical issues that came up there with a mathematical viewpoint. She also used many concrete items from everyday life in her teaching, and her teaching was not so dependent on the textbook. Projects were not emphasised, but this was common for all

the teachers in upper secondary school. A main idea for Jane was to get to know the pupils, learn about their interests, etc., so that she could draw upon this in her teaching.

Ann and George were placed in the 'negotiating' group of our initial model of extremes, but both expressed some positive attitudes towards connecting with real life. Ann was positive, but she experienced many practical problems, of disciplinary and organisational kind. She therefore felt that she could not manage to fulfil the aims. Her teaching was focused on dialogues and discussions with the pupils, and she encouraged the pupils to discover or obtain the mathematical knowledge without her presenting it to them directly. She often let the pupils discuss mathematics, and her approach was in that sense quite similar to the Japanese way of teaching that was presented in the TIMSS 1999 Video Study.

George expressed support for the idea of connecting with real life, but he called for a discussion of what lay within precisely this conception. He believed that school, and therefore also mathematics, was indeed part of the pupils' everyday life. To limit everyday life to problems with 'Paul the Pirate' therefore seemed artificial to George. Some pupils in his class were aiming at a scientific education, and this would be part of their everyday life. He did not make a lot of connections to real life in his teaching, at least not in the way we use the term, but he encouraged the pupils to reflect and work hard. This is also an aspect of real life.

Karin was negative towards making real-life connections, and she described herself as a traditional teacher. She did not believe in real-life connections, or projects for that matter, and the references she made to real life often served as artificial wrappings for mathematical problems rather than a basis for an activity. In the period of our visit to her class the pupils were engaged in two fairly large projects, and both had connections with real life. This corresponds with how Alseth et al. (2003) present the beliefs and actions of teachers. Their everyday teaching is traditional, but they also have projects and other extensive activities where real-life connections appear.

Thomas focused a lot on cooperative groups in his teaching, and he was influenced by the work of Neil Davidson (cf. Davidson, 1990), who had once visited his classroom. With this approach his teaching had changed from a large amount of teacher activity to a large amount of pupil activity. He was not completely against making real-life connections, but this was not something he emphasised. He did not believe in making such connections all the time. In upper secondary school, he said, there would be much more focus on mathematical content where real-life connections would be artificial. We observed how the pupils in his class were encouraged to present their own solutions, and they discussed problems within the groups before the teacher would give any hints about a solution. Sometimes a new topic was introduced by letting the pupils reinvent or discover the issues through a certain activity.

Ingrid's background was from psychology, and it was important for her to create a classroom environment where the pupils could feel confident and comfortable. She believed it was all right for mathematics to be a refuge, a kind of sandbox where the pupils could play around with concepts and problems that were removed from everyday life. She did not focus much on real-life connections in her teaching.

Owen was a traditional teacher, and he focused a lot on exercises, practice and repetitions. Projects and other activities, which he called 'new pedagogy', do not work, he claimed. He did not connect much with everyday life in his teaching. His main source of tasks was the textbook, and he believed that the only way the pupils could learn was to practise mathematical algorithms through constant repetition. The main reason, he said, that all the curriculum reforms had not turned out all that bad was that there always is a considerable number of teachers who ignore them and keep on doing things the way they have always done.

Teachers of all the categories have been observed in our study, and all of them were experienced teachers. Some were positive towards connecting school mathematics with real life, some were negative and some were negotiating somewhere in between. These teachers have ideas and standpoints that are valuable in a discussion of our topic, and we do not wish to label them as 'good' or 'bad' teachers because of their beliefs and practices. They were all regarded as experienced and good teachers (although we do not wish to go into a discussion of what a 'good' teacher really is), but they had different views about the aspects of the curriculum that we have focused on. If nothing else, this teaches us that there are many ways of teaching and learning mathematics.

11 Conclusions

This study deals with several issues relating to the connections of mathematics with everyday life. From the data analysis we have distinguished three different themes, with several categories for each theme. The themes are:

- Activities and organisation
- Content and sources
- Practice theories

On a meta-level, we might say that the study referred to in this thesis has a focus on real-life connections, teacher beliefs, and the connections between curriculum intentions, textbooks and teaching. This chapter aims at drawing conclusions concerning all these themes and aspects.

A brief overview of some of the results from this study can be listed as below:

- 1) Some teachers emphasise real-life connections often, but most teachers do this only occasionally.
- 2) The traditional way of teaching is still normal.
- 3) Teachers do not use other sources than the textbook much.
- 4) Pupils are not encouraged to formulate problems from their everyday life.
- 5) Situations from the media are seldom used in the mathematics classroom.
- 6) The pupils do not work with open tasks a lot.
- 7) Teachers seldom use projects.

We do not claim that these results are valid for the entire population of Norwegian teachers. They are, however, in agreement with the results of a larger evaluation study of L97, and they thereby appear to represent a trend. These results indicate, as did the evaluation study of L97 (Alseth et al., 2003), that the teachers do not apply many of the ideas of L97 although they have good knowledge about the curriculum and its content. However interesting such findings might be, they are not the main findings in our study. We have chosen to focus more on how the teachers connect with real life, what other sources they use, how they use projects, etc.

Having answered the research questions, and having established a need for change in teaching practice, we would like to address the question about what teaching practice could look like when it comes to connecting mathematics with real life. Although the questions behind our research were more about what teachers believed and did, and how they carried out their ideas, there was also a strong interest in gathering information in order to improve teaching. The conclusions therefore include suggestions of how the results and findings in this study can be used to change and improve teaching practice. We will address the issue of connecting mathematics with everyday or real life according to the three themes from the list of categories described in chapter 7.6, because we believe every topic that teachers have to deal with in the teaching of mathematics includes decisions about content and sources, as well as a choice of activities and organisation. All these decisions are made according to the teachers' beliefs and practice theories. After this presentation we will discuss some of the implications of our study of teacher beliefs; issues concerning the connections between curriculum intentions, textbooks and teaching; how problems can be made realistic; the lessons

learned from using the various research methods and analytic tools in this study, and some ideas for the future.

11.1 Practice theories

The TIMSS 1999 Video Study started off with a coding scheme that distinguished between real-life connections in problems and in non-problem situations. We adopted this coding scheme in the first phase of our data analysis. Real-life connections can certainly occur in problems that are connected with real life, i.e. on a content level, and we can also have connections with real life in methods of work that are connected with real life, i.e. on an organisational level.

In our study more than 25% of the teachers emphasised real-life connections often or very often, but by far the largest proportion of the teachers placed themselves within the category of ‘sometimes’ connecting with real life. When studying the teachers and their beliefs more closely, we discovered that the teachers would often fall into one of three possible categories. Some teachers were positive towards real-life connections, some were negative and others were somewhere in-between, for various reasons. This result would perhaps not seem like an interesting result in particular, and it would not represent the main aim of our study either. We do not believe that increased knowledge alone will change teaching practice, and there are reasons to believe that the teachers have good knowledge about the content of the curriculum (cf. Alseth et al., 2003). Information about how much emphasis the teachers put on real-life connections is not the most interesting finding in our study. It was more important for us to go beyond these first impressions, or the professed views of the teachers, and learn more about their beliefs in a wider sense. It was even more important to learn how these ideas were carried out in the classroom. Real-life connections can be discussed on (at least) two levels, i.e. on a content-level and on an organisational level. The following is a presentation of our conclusions from the discussions of these levels.

We initially proposed a model of three extremes, and we tried to place the teachers (the eight Norwegian teachers) within this model. Karin seemed to be a teacher who did not focus a lot on real-life connections, Ann was in favour of the ideas but found them hard to carry through, while Harry was in favour of the ideas, and he also carried them out in his teaching.

The data from the questionnaire as well as the interview indicated that Karin was a traditional teacher as she claimed to be. This was also the impression we got from the 11 lessons we followed her class. In nine of these lessons the main focus was on working with textbook tasks, and she also focused a lot on the rulebook each pupil wrote. From the lessons we did not observe much reference or connection with real life. The comments that could be interpreted as real-life connections were artificial wrappings more than true connections with everyday life. The comments that could be interpreted as real-life connections seemed to have the purpose of amusement more than being actual connections with everyday life. Karin was negative towards projects as well, both in the interview and the questionnaire, but in the period of our visit the pupils were engaged in two interesting projects. Both projects had clear real-life connections. Perhaps it was a coincidence, and perhaps these were the only projects they had during the year, but they were interesting projects nevertheless, and they indicated that her negative attitude on this point was actually more of an attitude than something she always acted out. These findings coincide with the evaluation study of L97 (Alseth et al., 2003), which concluded that teachers were still teaching in a traditional way. In larger projects though, teachers would include real-life connections to a much larger degree. The teaching practice could thus be divided in two categories: the ‘normal’ teaching and these occasional projects or themes.

Both Karin and Ann supported an idea that projects had to be large and formal, following the ideas of a more formal project framework. L97 clearly suggests mini-projects in mathematics also, and it thus presents a wider understanding of projects than some of these teachers.

Ann was positive towards the idea of connecting mathematics with everyday life to a certain extent, as we indicated. She was also positive towards using projects, but she encountered difficulties in her daily work that made the incorporation of these ideas hard. She was in favour of trying to get a good discussion going with the pupils, and thus incorporate their everyday life ideas. From her teaching we could observe that she was good at this. There was often a kind of Socratic discussion in her lessons, where she asked questions and stimulated the pupils to think and discover methods, strategies and answers for themselves. The lessons we observed in Ann's class did not contain so many explicit references to everyday life, so it could be true that she found it hard to carry out this connection.

Harry was an innovative teacher, and he had many exciting ideas on how to connect with real life and technology. He carried out the ideas he professed, and he made several connections to real life in his teaching. In the questionnaire he claimed to use the media and open tasks in his teaching. The lessons where he presented problems from a science magazine were examples of this. There were also examples of lessons where he used the internet in his teaching, but, as he explained us, this was something he did not do a lot. He also said that it was hard to find websites that contained reliable information with the proper degree of difficulty for his pupils. In his opinion, the internet was too hard for the pupils to navigate in, and there would always be a danger that they found material that was misleading or simply too difficult for them to comprehend. When using this tool he had to make preparations in order to find some good websites before the lesson.

From the pilot study, we found that Jane was the only teacher in our study who claimed to emphasise real-life connections very often in her teaching. When observing her teaching practice we could also find many examples of this, and this was an important aspect her teaching. Her approach was different from Harry's though, and she had a stronger focus on the connection with vocational life. Both George and Owen claimed to emphasise real-life connections often in the questionnaire, but when comparing with the interviews we got an idea that this was not an entirely true indication of their beliefs about the issue. George seemed to fit the middle category, although there are indications that he could fit either the positive or the negative group. He expressed some support for the issue of connecting with everyday life, but he also questioned it. In the interview, he told us that he believed everyday life for pupils was their school-life, and their everyday life experience could be that they wanted to continue their education with studies in engineering. We would therefore rather place him in the category of teachers who are positive, but for various reasons do not practise it in their classrooms.

Owen expressed in the questionnaire that he often emphasised real-life connections, but in the interview he told us that he answered the questionnaire without thinking. He also believed a connection with everyday life would be too difficult for many pupils, especially the weaker pupils. In reality he was quite negative towards real-life connections.

Thomas was positive towards the idea of connecting with real life to some extent, although he replied in the questionnaire that he only sometimes emphasised it. He also believed that a connection with real life should not be emphasised at all times. In many areas of mathematics a connection with real life often seems artificial and unnatural, and he believed other issues should be emphasised as well. Real-life connections were not the main focus of his teaching.

Ingrid also replied in the questionnaire that she sometimes emphasised real-life connections, but in the interview she explained that she believed mathematics could also be a refuge. A main idea for her was that mathematics could be like playing in a sandbox without having to think all that much about the surrounding world.

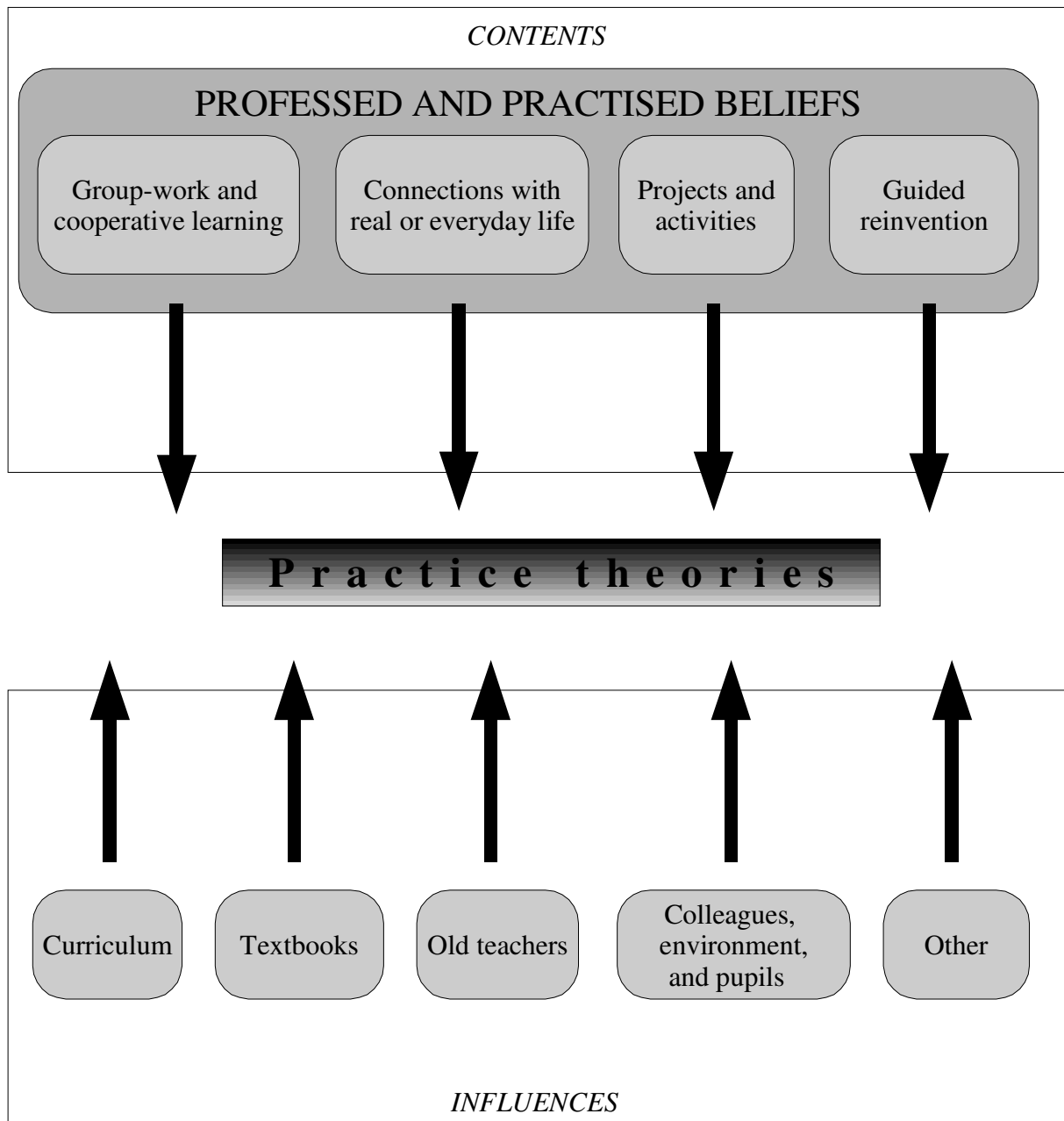

Illustration 26 Practice theories - content and influence

The teachers from the pilot study seemed to focus more on other aspects than the connection with everyday life. Some expressed support for other aspects of teaching than one might expect, and this indicates that a simplistic model of extremes like the one proposed in the beginning of this study will soon be too limited. Neither Jane nor George used projects much in their teaching, for instance, although one might expect so from teachers who emphasise a connection with real life in their teaching. This might be due to a tradition of not having a strong focus projects in upper secondary

school. They also did not focus on re-construction, use of situations from the media that one might expect, but where the use of other sources than the textbook is concerned, they fit the model perfectly. Jane let the pupils take part in the formulation of problems less often than one could expect, but this might have to do with the low motivation and level of attainment of her pupils in the vocational lines. Another issue is that all the 12 questions in the questionnaire were not directly related to the idea of connecting with real life, and therefore mixed answers might be expected.

The teachers' practice theories have strong influence on the teaching and learning in the classrooms, and these practice theories contain the teachers' professed and practised beliefs about the teaching (and learning) of mathematics (see the illustration above). When it comes to connecting mathematics with everyday life, the practice theories contain ideas about the very issue of real life connections, as well as an understanding of what constitutes real life, everyday, etc. The practice theories also contain ideas about activities that can be organised and sources that can be used in order to reach the aims. All these are elements of the teachers' practice theories, but these theories are also influenced by more external sources. The curriculum (the intentions presented in the curriculum paper, as well as the interpretations that each teacher make of these intentions) is supposed to provide the guiding lines for teachers, and should have an influence on the teachers' practice theories, although teachers like Owen claim that teachers will continue to do what they have always done regardless of new curriculum reforms. Textbooks seem to be one of the main sources for teachers of mathematics, and it is therefore natural that they influence the teaching and the teachers' practice theories as well. Research on teachers' beliefs has shown that teachers are highly influenced by teachers they have once had themselves, and environmental sources of influence like colleagues, the school and classroom environment as well as the pupils are other important sources of influence. Other issues like time pressure and the final exam also influence the teachers' practice theories as well as their implementation of their theories and ideas in the actual teaching.

11.2 Contents and sources

The present national curriculum in Norway (L97) has mathematics in everyday life (and thereby also real-life connections) as one of the main areas, and several issues are emphasised in order to connect the mathematics that pupils learn in school with life in society outside of school, or what we might call everyday life. The curriculum does not tell all that much about where the content and sources of ideas for such a teaching could be found. Our study implies that the teachers do not use other sources than the textbook much, they seldom use situations from the media and they seldom present the pupils with open tasks. The reason for the two latter issues might be that these are normally not involved in textbooks, and teachers do not use other sources than the textbook and the teacher's manual much. Some teachers use other or older textbooks as sources, and some teachers have ideas about where to find materials for use in the mathematics classroom. There are some examples of this in our study, and we believe that there should be some common resources for a teacher to get such ideas without having to reinvent them for himself. The internet could be a reasonable forum for such a source of information and ideas, and in Norway a web site has been constructed for that purpose (cf. <http://www.matematikk.org>). This web site presents several resources for the teachers to use, as well as a database of lesson plans with many good ideas for teaching.

Both Karin and Ann claimed to use the textbook a lot, and although they had different approaches the classroom observations supported this. Karin was perhaps the teacher in lower secondary school who used the textbook most extensively. Many of her lessons were traditional, starting with a presentation of some material from the textbook, often writing some sentences down on the

blackboard for the pupils to copy into their pupils' rulebooks. Then they practised solving textbook tasks. She claimed to sometimes use other sources than the textbook, and we could see examples of this in the two projects they were engaged in. Otherwise she would normally let the pupils practise solving many tasks from the textbook. She would also present the pupils with stories from her own everyday life, like the story with grandma's buttons, but the context and setting of these stories were artificial and merely served as a wrapping for the theory she wanted to introduce.

Ann also claimed to focus a lot on the textbook, and she replied that her pupils would very often solve many tasks from the textbook. She also said that she used other sources than the textbook sometimes, but there was no indication of what sources those might be from the questionnaire. In the interview she said that she would like to introduce the parents into the classroom, and let their vocational experiences serve as a source for her teaching of mathematics, but she had not tried this out yet. She replied in the questionnaire that she would seldom use situations from the media or open tasks, and we could not see much of this in her teaching either. On one occasion we observed that she let the pupils work on different problems concerning areas on a handout. These problems were of a somewhat open kind, in that no methods or algorithms were implied. Each question had one correct answer, so they would not qualify as open problems in that respect. The only use of other sources we could find from Karin and Ann was on the mathematics day, which involved lots of interesting activities. Unfortunately this day was not planned to fit in with the other activities the pupils were engaged in. From what we heard from both teachers and pupils the day mainly served as a pleasant break from the ordinary lessons.

Harry claimed to make extensive use of other sources, and this was the impression we got from the classroom observations also. He introduced problems from magazines, he let the pupils use the internet, he involved concrete objects from the pupils' everyday life as the bicycle. He also presented the pupils with an interesting way of re-inventing Pythagoras' theorem. In the interviews he explained that he had also tried out different computer programs and games, but that he did not find many of them to be any good. Harry had many ideas, but he nevertheless asked for a common source of ideas, problems, projects and activities for the teacher to access. He worked hard to build a mathematics room in his school. This room was supposed to contain sources of ideas for the teachers, and he told us that he was interested in using the local environment, like industry and architecture in his teaching.

According to the curriculum pupils should get the opportunity to use geometry to solve practical problems concerning length, area and volume. There were many examples of this in Jane's classroom. She also used several different sources in her teaching, and many of these were concrete items from her everyday life. She expressed a dislike for the textbook and she would often search for tasks in other textbooks, or she would also make her own tasks based on things and items from real life. The four other teachers did not use other sources much, and they all focused on letting the pupils solve problems from the textbook. Jane very often used other sources than the textbook, she replied in the questionnaire, but she only sometimes let the pupils solve many tasks from the textbook. This was consistent with our observations, in which we found lots of examples of how she used other sources. From the lessons we observed, we also got an impression that her main emphasis was not on letting the pupils solve many textbook tasks, although they did solve several tasks in most of the lessons.

George claimed to use other sources than the textbook often, while the other three teachers only sometimes did so. From the lessons, we found an example of Thomas and Ingrid presenting an activity that was not from the textbook, in the introduction to trigonometry. George and Owen mainly used the textbook in the lessons we observed. We could not get any indications of what other sources they used from the questionnaire or the interviews. George replied that he often let the pupils formulate problems from their own everyday life, but the lesson we observed did not contain

evidence of this. Thomas claimed to sometimes use projects, while Ingrid, Owen and Jane did not use any of these two strategies often. Situations from the media seemed to be seldom or very seldom used by everyone but Jane. She claimed to do so sometimes in her teaching, but we could not observe any indications of this in the lessons.

Textbooks have often been criticised for providing artificial contexts, and the very possibility of connecting mathematics with everyday life through textbook tasks could be questioned. When pupils solve tasks from a textbook, this is a strictly context-bound activity, and the difference between this context and the way problems are solved in real life is often significant. Textbook tasks often imply the use of certain algorithms or mathematical theories in order to find a solution, and the solutions as well as the theories and algorithms are generally known (by the teacher) beforehand. Everyday problems, on the other hand, often include several possible solutions, and neither the solutions themselves nor the algorithms or solution methods are normally known before the problem-solving process is started. These are all issues that can contribute to an explanation of why there seem to be a gap between the real (physical) world and the world of mathematics. In order to connect mathematics with real or everyday life, one should therefore assume that other sources than the textbook must be used and other approaches than the traditional lecture-practise sequence must be organised.

Among the possible sources that can be used (as appeared in the analysis of findings from our study) are:

- Include situations from the media
- Use concrete materials from everyday life (like maps, photos, boxes, etc.)
- Let the pupils visit building sites, industry sites, etc.
- Draw upon the pupils' experiences and interests
- Use mathematics in practical activities, like cooking, woodwork, etc.
- Use the internet
- Let the pupils measure, calculate, sketch a bicycle, etc.

11.3 Activities and organisation

The curriculum for compulsory education in Norway, L97, emphasises projects as an organisational method for teaching. This implies not only large and formal projects involving other subjects that are often organised around a certain theme. The curriculum also suggests using small projects in the teaching of mathematics. Yet our study indicates that teachers seldom use projects.

One suggestion from the curriculum is to let the pupils formulate problems from their own everyday life, and this suggestion is also found in the curriculum for the upper secondary school. In our study we have seen that the pupils are not encouraged to do this often. A connection with everyday life is often a connection with the everyday life of the teacher rather than the pupils. Here lies a major challenge for teachers to learn more about the everyday life of their pupils, as Jane pointed out.

Our study indicates that the traditional way of teaching is still normal among teachers, and this was also suggested by Alseth et al. (2003). The teachers normally present the theory first and then let the pupils solve many tasks from the textbook.

We have also observed examples of other and interesting ways of organising the learning sequences. Some teachers made extensive use of cooperative groups; we have observed examples of

mathematics in the kitchen, small projects that involved applications of the mathematical theories in the handicraft room or with physical objects from real life, etc. There are many actual examples of how a teacher could connect mathematics with real life and we have observed how experienced teachers do this. We have also studied how mathematics classrooms have been organised in other countries, and some of these were countries with high-achieving pupils. All these observations provide an interesting source of ideas for practising teachers, and they indicate how these issues can be carried out in teaching.

Projects, larger projects involving several subjects, mini-projects or activities, are suggested as an important way of organising the teaching of mathematics through the L97 curriculum. There seem to be different interpretations among teachers of what projects are and how they can or should be organised. Some teachers exclusively identify projects as larger activities involving several subject areas, and these projects are supposed to follow a strict structure. Norwegian pedagogues had written manuals for how to include project work after L97 (cf. Koritzinsky, 1997; Hansen & Simonsen, 1999). Other teachers use the notion of 'project' on smaller activities or small-projects, and these projects do not necessarily follow a strict structure that ends up with a project report. The teachers in upper secondary school often have one large project each year, and this follows a specific structure. Besides from using projects, the curriculum indicates the possibility of using more open tasks, or activities where the pupils are supposed to collect material and analyse it with mathematical tools. There were different opinions among the teachers when it came to the use of such methods of work.

Karin was negative towards the use of projects, but in the four-week period we observed her, she and her classes were engaged in two projects. Both projects were connected with real life, and both involved activities where the pupils were actively drawing upon experiences from their own everyday life.

We only observed four of Ann's lessons, but it seemed as if her professed ideas were quite descriptive of her teaching practice. She was positive towards using both projects and real-life connections, but the practical problems she encountered in her everyday teaching and the lack of good ideas on how to organise her teaching made it difficult to put her beliefs into action. From what we could observe, Ann was quite dependent on the textbook in much of her teaching, although she tried to use other sources and other activities. Her dialogue with the pupils was good, and she showed great skills in posing questions that provoked thinking. Her method of teaching was often a Socratic discourse more than the traditional lecture.

Karin's lessons were well structured and traditional, whereas Ann's lessons often involved rich discussions between the teacher and the class. Harry's lessons, on the other hand, often involved practical activities and mini-projects. His pupils were often allowed to experiment with and use the mathematical concepts in practical and realistic settings. One of his main aims was that his pupils should have at least one new experience each day, and in the lessons we observed there were several opportunities for this. The pupils were often engaged in activities where other sources than the textbook were used, and they got the opportunity to produce things or describe things using mathematical concepts and methods. They were also given the opportunity to draw links to other subjects, and the mathematical theories often 'came alive' in Harry's lessons. In some projects the pupils used mathematical methods in their local environment, in connection with architecture, industry, art, etc.

Our study of teachers at schools 3 and 4 presented us with many ideas on both the content level and the organisational level, and there were many examples of how experienced teachers organise their teaching. There have also been practical examples of how mathematics could be connected with real life, and we have observed how different beliefs manifest in the everyday teaching practices. It would of course be impossible from a study like this, to conclude to what extent any of the teachers

did or did not fulfil the aims of the curriculum, and that was not the goal either. We have presented several examples of activities and ways of organising lessons, and we have discussed several aspects concerning teaching philosophies and methods in lower secondary school. We will now make a similar presentation of some teachers at the upper secondary level, how they react to the same thoughts and ideas, and how they carry out their teaching.

Projects were seldom used by most of the upper secondary school teachers, except for Thomas, who claimed to use them sometimes. Ingrid and Thomas focused a lot on group work, and for some years several classes at the school had been using cooperative groups as an integral part of their classroom organisation. The class of Ingrid and Thomas was larger than ordinary classes, and in their lessons we could observe how this organisation worked out fine despite the larger number of pupils. This method of work had been successful for them, but other teachers, like Owen, did not believe in group-work. He claimed that his pupils, who were often low attainers in mathematics, had gotten lower grades when he tried to organise them in groups. He therefore believed that group-work was too hard for weaker pupils. He usually taught classes of pupils who were not going to continue with mathematical studies, and he did not organise his class in groups. The lesson we observed was traditional, as far as content, organisation and methods of teaching were concerned. Jane did not focus a lot on groups either, but she allowed the pupils to cooperate in pairs or smaller groups. Like in George's class, her use of groups was more occasional.

A main method of organisation for most of these teachers, with Thomas as an exception, was first to teach theory and then let the pupils practise solving tasks. Owen, Ingrid and Thomas claimed that their pupils were often involved in a process of reconstructing the mathematical theories. We observed an example in the class of Thomas and Ingrid, where they let the groups try and find things out for themselves, without much teacher intervention. This was a nice example of reinvention, guided by both fellow pupils and their teachers. They often let some pupils, or sometimes the groups, present their solutions to problems or tasks they had been working on. Thomas explained in the interview that after he had started to organise his classes in cooperative groups, the amount of time when the teacher was active had decreased, while the amount of time when the pupils were active had increased. This was also something we could see examples of in their lessons.

In vocational upper secondary schools the pupils choose programs according to their interests, and these programs are directed towards a future vocation. If pupils want to become hairdressers they choose one program, if they want to become cooks or work in a hotel they choose another. In Jane's school, the pupils who had chosen hotel and nutrition got the opportunity to learn mathematics in the kitchen. The mathematics teacher regularly accompanied the pupils when they were cooking in the kitchen, and assisted them in situations that required mathematics. She challenged them to think mathematically in the kitchen, and she often drew upon the experiences from the kitchen when she was teaching the same class in a more ordinary mathematics lesson later. This was an interesting organisational approach to mathematics teaching, and it raises questions concerning theories of situated learning. The mathematical skills used by people in an everyday life situation are often a kind of situated knowledge. This knowledge is context dependent, and the transfer of this knowledge to other situations is often troublesome.

11.4 Implications of teacher beliefs

Beliefs are a complicated matter, and there is no single definition of what beliefs are. We can make a distinction between knowledge and beliefs, but this is not sufficient for a definition. Some say that beliefs are the filters through which experiences are interpreted (Pajares, 1992), others suggest that beliefs are dispositions to act in certain ways (Scheffler, 1965). People are not always conscious of

their beliefs, and individuals may also hide their beliefs when they feel that they do not fit someone's expectations. It is therefore possible to make a distinction between deep and surface beliefs, and these could then be seen as extremes in a spectrum of beliefs (cf. Furinghetti & Pehkonen, 2002).

Research has shown that there is a link between teachers' beliefs about mathematics and their teaching practices (cf. Wilson & Cooney, 2002), and Thompson (1992) suggests that teachers' beliefs about the nature of mathematics influence their future teaching practices. Some even suggest that the teaching practice is a result of decisions that teachers make based on interpretations of the curriculum and beliefs they carry into the classroom (cf. Sztajn, 2003), and we have concepts like 'professed beliefs' and 'carried out beliefs'. In this study, we have analysed the data in order to distinguish the teachers' beliefs, and then we have discussed the connection between the teachers' beliefs and teaching practices. In most instances there was a close connection between beliefs and practice. Ann's case was an exception. She seemed to be positive towards connecting mathematics with everyday life, but her teaching did not indicate this and was rather traditional. From an analysis of the data we learned that Ann was positive towards the curriculum intentions (concerning the connection with everyday life), and she expressed a wish to teach according to these intentions. Some issues prevented her from carrying this out in the classroom though:

- She had a very difficult class, and she had to focus more on creating a good learning environment
- The implications were that less time could be spent on the intended learning activities, and this ultimately lead to a considerable time pressure
- She found it difficult to carry out the intentions (because she did not have the practical knowledge on how to do it?)

One might argue that Ann's beliefs (her support for connecting mathematics with everyday life, etc.) were surface beliefs, or that they were only professed beliefs, but our knowledge of Ann implied that this was probably not so. We therefore want to suggest that there does not always have to be a correspondence between a teacher's beliefs and teaching practice, and such a lack of correspondence does not necessarily imply that it is a matter of professed beliefs rather than carried out beliefs, or that the teachers' professed beliefs are surface beliefs rather than deep beliefs. Sometimes teachers are not able to teach the way they want to, or according to their deep beliefs, simply because teaching is a complicated matter and there are several issues that influence the daily life of the classroom. Teachers might be faced with a difficult class, with noisy pupils that have no wish to learn mathematics, and the main effort will then have to be on creating a good learning environment rather than focusing on all the intentions of the curriculum. Learning is, according to the constructivist stance, something that takes place within the individual, and it demands activity by the learner. Learning cannot be forced on the pupils. When the pupils are not 'tuned to learning', as Karin described it, the teachers have to change their teaching, and their initial plans and intentions might be difficult or impossible to carry out. In such instances it is not right to conclude that the teacher's beliefs do not correspond with his or her actions, and that these are probably not their deep beliefs.

Teaching practice is influenced by many practical instances, and these are not only the teachers' learning beliefs and interpretation of the curriculum intentions (cf. Sztajn, 2003). The connection between teachers' beliefs and teaching practice appears to be much more complex, as illustrated below. Sometimes teachers believe in certain theories or ways of teaching, and their beliefs might support certain curriculum intentions, but they simply lack the practical knowledge of how to carry out these intentions. One might argue that beliefs are strongly connected with practice, and that the teachers' beliefs in such cases are therefore only surface beliefs, but we believe that this is not a

productive definition. Beliefs are distinguished from knowledge, and they do include an affective level. It is often so that beliefs are dispositions to act in certain ways, but we wish to emphasise the connection between beliefs and practical knowledge, as well as the fact that practical issues and problems can have a strong impact on teachers' beliefs and teaching practice.

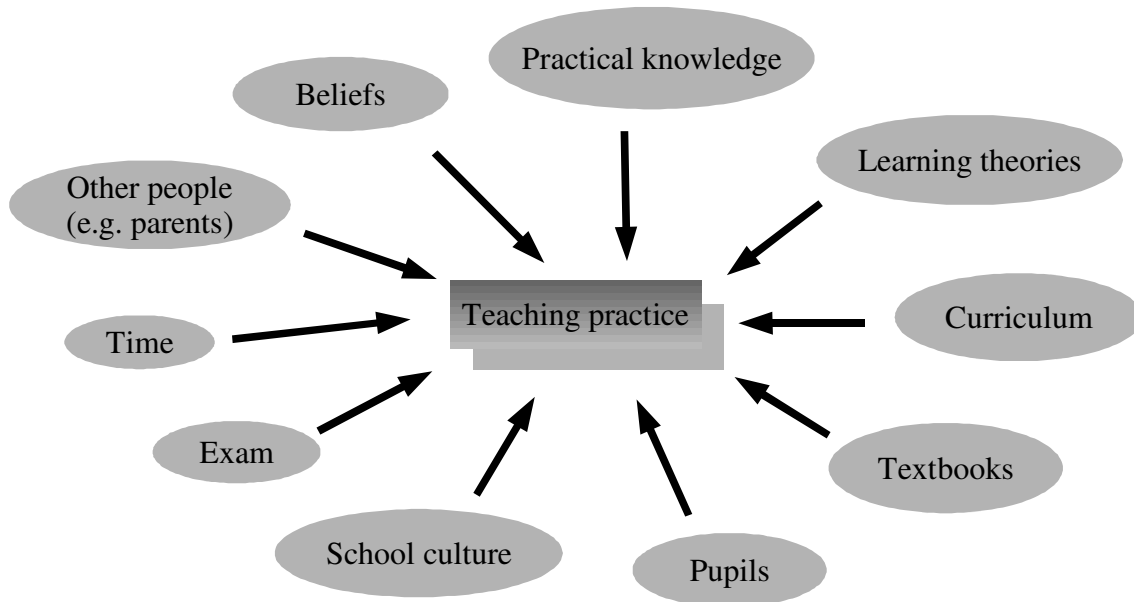

Illustration 27 Influences on teaching practice

Beliefs probably have an impact on teaching practice, and in order to carry out a curriculum reform there probably has to be a focus on changing the teachers' beliefs in order to change their teaching practice, but this is not the only thing that has to be done. Based on the data analysis from our study, we want to suggest that a teacher's beliefs are sometimes prevented from being displayed in his or her teaching practice, and this does not imply that we should question the integrity of the teacher's beliefs. Sometimes, however, the teachers make statements that do not correspond with their true or deep beliefs. An example of this was found in our pilot study. Owen (see chapter 9.6) indicated in the questionnaire that he was positive towards connecting mathematics with everyday life, and one might suggest that this was an indication of his beliefs. In the interviews we learned that this was not the case, and he even said that he did not think much when he answered the questionnaire. He explained that he actually did not believe in this approach. His teaching also indicated that he did not really support the idea of connecting mathematics with everyday life.

There are several issues that influence teaching practice, not only beliefs and knowledge about the curriculum intentions. We believe it is the complexity of this picture that makes the process of changing the teaching practice so cumbersome and time consuming. The illustration above is not supposed to imply that a change of beliefs (alone) cannot result in a change of teaching practice. The idea is that there are several other issues that (might) influence teaching practice as well as beliefs and interpretations of curriculum intentions, and some of these issues (or the sum of them) might prevent the teaching practice from being changed.

11.5 Curriculum - textbooks – teaching

In chapter 4 we presented and discussed curriculum recommendations and intentions, in chapter 5 real-life connections in textbooks were discussed, and in chapters 8 and 9 the results of case-studies of teachers were presented, with a focus on how they connect mathematics with everyday life. There are several aspects to discuss about the relationship between curriculum recommendations, what the textbooks present and what is taught.

In our study we have focused on teacher beliefs and teaching practice, and we have taken the curriculum as a point of departure.

If we characterize reform-oriented teaching as that teaching which attends to context, including basing instruction on what students' know, then teaching becomes a matter of being adaptive (...) rather than a matter of using a particular sequence of instructional strategies (Wilson & Cooney, 2002, p. 132).

This fits the intentions of L97 well, and we could possibly characterise L97 as a reform-oriented curriculum according to such a definition. There has been some research on reform-oriented curricula, and the development of reform-oriented teachers.

The development of a reform-oriented teacher so characterized, is rooted in the ability of the individual to doubt, to reflect, and to reconstruct. Teacher education and mathematics teaching in general then become a matter of focusing on reflection and on the inculcation of doubt in order to promote attention to context (Wilson & Cooney, 2002, p. 132).

This again requires a great deal of knowledge and insight by the teacher, especially as far as mathematics, pedagogy of mathematics, and student learning are concerned.

It has been suggested, as discussed in the chapter above, that teaching practice is a result of decisions that teachers make based on interpretations of the curriculum and beliefs they carry into the classroom. In order for the curriculum intentions to be implemented in teaching practice, one should therefore expect that it would be appropriate to focus on two points. First, one must provide the teachers with knowledge about the curriculum and its intentions, in order for them to make the correct interpretations of these intentions. Second, the teachers would have to be given courses or similar that would challenge their current beliefs, in order for these beliefs or belief systems to adjust to the curriculum intentions. The result would be, one would presume, that teachers' beliefs and practice would change according to the curriculum intentions, and the curriculum reform would have been successfully carried out. Reality, however, appears to be far more complex. As we have suggested above, there are a multitude of issues that influence teaching practice, and it might not be enough just to focus on the teachers' knowledge and beliefs in order to change their practice.

Some teachers do not seem to relate much to the curriculum in their everyday teaching. Karin told us that she did not focus much on the curriculum in her daily teaching life, and some teachers probably use the curriculum actively only when they plan their teaching at the beginning of the school year. Other sources of influence are probably also present, and several teachers, according to Owen, teach the way they always did and do not follow the curriculum intentions more than absolutely necessary. It is important to consider the possibility that some teachers do not want to be told how they should teach, and a curriculum reform might have little effect on their teaching.

The textbook is a main source, if not *the* main source, for many teachers. When discussing the implementation of a curriculum reform, the textbooks and their implementation of the curriculum intentions should therefore be subject to analysis. Our analysis has shown that the textbooks have different ways of implementing and even interpreting the curriculum intentions as far as mathematics in everyday life is concerned. Some textbooks appear to follow the intentions closely,

while others simply present mathematics in everyday life as a distinct topic. The connections with real or everyday life in textbook word problems is a discussion on its own, and a common approach is for textbooks to first present the theory and then present a set of exercises that pupils can solve in order to practise using this theory. The real-life connections in the textbook word problems therefore often have an artificial appearance, and the contexts of the problems are evidently constructed to illustrate some theory. The curriculum suggests to take meaningful situations (or problems) as a starting point for a process of reinvention, but this is an approach that appears to be difficult to implement in textbooks.

Because teachers have such a strong focus on the textbooks, it could often be the textbooks rather than the curriculum that influence the teaching practice. When there is no longer any control of whether the textbooks fulfil the curriculum intentions, which is the situation in Norway now, there is a possible discrepancy between the intended curriculum as described in the printed curriculum paper (L97) and the interpreted curriculum as it appears in the textbooks. The textbooks might therefore be described as a (potential) weak link in the chain, and the result is that the curriculum that is carried out by the teachers and experienced by the pupils could be significantly different from the intended curriculum. The possibility of this could be considered even stronger when taking all the other issues that influence teaching practice into the discussion.

11.6 Definition of concepts

This thesis has dealt with many problematic issues and concepts when it comes to the connections with real or everyday life. In the introduction (see chapter 1.6) we defined the concepts relating to these issues, and this set of definitions has been used throughout the thesis. The analysis of the results has indicated that some of these definitions should be refined. The terms ‘everyday’ and ‘real’ are problematic themselves, because they often lead to a complicated discussion of whose everyday and whether the issues are realistic (and then again for whom?). We do, however, find it more appropriate to refine and clarify the definitions of these terms rather than to omit them entirely.

The reason for using the term (mathematics in) ‘everyday life’ in the first place was that this is the term that our current curriculum (L97) makes use of, and our study has a strong connection with the curriculum. When the term is used in the curriculum, it appears to refer to something that takes place in the ‘outside world’, which could be interpreted as the pupils’ leisure activities, working life and social life in general. Philosophically speaking, we might say that we refer to a distinction (and also a desired connection) between the physical world and the Platonic world of mathematical ideas and concepts. The attempt of connecting these two worlds is problematic, both in a philosophical and a practical sense. In order to prevent that this discussion becomes more difficult than necessary, and in order to suggest a set of definitions that we might agree upon, we present the following refinement of definitions:

- We suggest that **‘real life’**, when used in mathematics education, should refer to life outside of school, and that ‘real world’ refers to what might also be called the physical world as such. ‘Real-life connections’ are references to real life in text, speech or activities. When the latter term is used, we should indicate to whom it might be regarded a real-life connection.
- **‘Everyday life’** refers to the ‘worlds’ that pupils (in this case) relate to in their everyday. The pupils’ everyday life could therefore include school life, social life outside of school, future or present vocational life, games and play, etc. According to such a definition, the connections of mathematics with everyday life are often connections to ... everyday life

(as we have defined it here), but it would be more appropriate to refer to real-life connections or connections with real life, because it is often a matter of relating to issues that pupils do not normally meet in their everyday. The mathematics that pupils encounter in their school life is part of everyday life for them, because school life is a major part of their everyday, and it is therefore more appropriate to use the term real-life connections (which refer to instances in the world outside of school). According to this definition, real-life connections are not only referring to instances that pupils encounter in their everyday life, but rather to issues that occur in the physical world (real world) as such. This appears to be the intention in L97 also, which not only refers to connections with issues that the pupils know from their everyday life.

- **‘Everyday mathematics’** is a term that is often used as opposed to academic mathematics (or even school mathematics), and it might imply mathematics that we need in everyday life and mathematics that is attained in everyday life. In both cases this term is related to a (small) subset of mathematics, on a content-level, as opposed to a focus on the connections as such when using the term ‘mathematics in everyday life’ or ‘real-life connections’.

L97 does not refer to everyday mathematics (and this thesis only indirectly relates to this) but rather to the connection of (school) mathematics with real life. As discussed above, we would suggest to use the term real life rather than everyday life in this instance.

Throughout this thesis, the terms ‘real life’ and ‘everyday life’ has been used with the same meaning, and one might ask why this has not been changed as a result of the definitions suggested above. The reason for this is that the thesis discuss the intentions of L97 (in relation to the implementations in the textbooks, by the teachers, etc.), and the concept of ‘mathematics in everyday life’ is central in the curriculum. We believe that these concepts and issues should be clarified and distinguished between in future research and curriculum development, and the above discussion represents our suggestions for such a refinement of concepts.

11.7 How problems can be made realistic

In this thesis we have spent a great deal of time addressing the issue of connecting mathematics with real or everyday life. An important aspect is how these results can be used for the teachers to make mathematical problems and activities more realistic. The term realistic is here used in the meaning that the problems and activities should be more properly connected with real life, according to the curriculum standards.

This would often lead to a discussion of what realistic problems look like, why the context presented in the problem is artificial or not, whether the problem is meaningful, whether the context relates to issues from the pupils’ everyday life or real life in general (as defined above), etc. We would like to postpone the discussion of these issues and first relate to the organisation of activities. In the TIMSS 1999 Video Study, the Dutch classrooms had the highest percentage of real-life connections, whereas the Japanese classrooms had the lowest percentage of such connections. Our analysis of videos from these two countries showed that the Dutch classrooms often had a rather traditional approach, where the main focus seemed to be on solving and reviewing problems from the textbook. It was these textbook problems that represented most of the real-life connections that were found in the Dutch videos, and a main reason why the number was so high is that it was normal to review a large number of textbook tasks or problems in each lesson. In Japan, however, the normal approach was to work extensively with one or two rich problems per lesson, and the ways in which these lessons were organised was often more related to the theories of RME (and also

to the intentions of the Norwegian curriculum) than the Dutch lessons, although the content did not contain so much real-life connections. These findings, which are of significant importance, has lead to a focus on organisation of learning activities rather than having a merely content-specific discussion of what constitutes ‘good’ real-life connected problems.

From the review of theory (in chapter 2) we can distinguish several suggestions of how it is possible to organise learning activities in order to satisfy the demands of real-life connections. From our study of Norwegian teachers, as well as the study of videos from the TIMSS 1999 Video Study, even more suggestions of strategies are distinguishable. From our list of categories and themes, some main ideas appear: cooperative learning, projects, and (guided) re-invention.

The constructivist stance is that mathematical understanding is not something that can be explained to children, nor is it a property of objects or other aspects of the physical world. Instead, children must “reinvent” mathematics, in situations analogous to those in which relevant aspects of mathematics were invented or discovered in the first place (Smith, 2002, p. 128).

The idea of reinvention, being that pupils must reconstruct the ideas of mathematics in situations that are similar to those in which the ideas were invented or discovered in the first place, is central to constructivism in general. Mathematical ideas were often invented or discovered in relation to concrete issues from real life (or the physical world), and a process of reinvention would therefore often include connections to real life. A problem is that a process of reinvention is not always easy for the teacher to plan, and it might be a very demanding way of organising the teaching. Concrete examples of how it could be done, like some of the examples that have been presented here, might be helpful for teachers.

The way in which people work with mathematics in real life, and the way in which the mathematical theories were invented, is different from the way in which pupils often work with mathematics in school. A traditional approach has been for the teacher to present the theory first, and then let the pupils practice solving tasks from the textbook. Some of the tasks that have been presented in the textbook appear to be problems with a real-life connection. Many of these problems are not problems in the true sense, because the solution and the methods used to arrive at a solution is normally known, and the way in which pupils relate to the ‘real-life’ contexts presented in these tasks often differ significantly from the way they would deal with similar problems or issues in the real world. Many of these real-life connections in textbook tasks have therefore been described as artificial, and teachers often experience that pupils who have been able to solve many of these textbook tasks are not able to solve similar problems once they are posed in a slightly way, or when they meet similar problems in everyday life. If the learning activities are organised as projects (or small projects), and/or if the pupils are guided through a process where they reinvent the mathematical theories, it is believed that they will also be able to use their knowledge in different contexts to a stronger degree than if they have only been solving textbook tasks in a traditional way.

There have been several examples on how projects and small-projects can be organised in this thesis, and there have also been examples of how activities can be organised so that pupils get the opportunity to reinvent the mathematical theories. One main challenge for the teacher is to resist the temptation of explaining things right away, and rather let the pupils find things out for themselves. Organising the teaching in this way might be more time consuming, but we believe that the result (as in pupils’ learning) will be far much better than the alternative, which has been indicated in the study of Boaler (1997) and others.

Learning can be viewed as a process of social constructivism, and ideas of organising the learning activities as cooperative learning or in cooperative groups have been discussed in this study. Many teachers appear to not use group work in a very conscious way, and cooperative learning activities

are not a main approach with many teachers. The examples from the classes of Thomas and Ingrid in our pilot study showed how this could be done in practice, and some of the Japanese lessons from the TIMSS 1999 Video Study showed how some of the processes of group work and cooperation could be implied in a process of guided re-invention also.

When it comes to the content-level, we often see textbook problems with a context that appears to be from real life, but where it becomes apparent that this context has been used mainly as a wrapping for some mathematical theory that is supposed to be learned. An example of this is the textbook problem concerning the garden of a family. The garden had the shape of a rectangle, and the family was going to plant a hedge that was going along the diagonal of this rectangle-shaped garden. This problem appears to have a context from real life, since there is a family with a garden and a hedge (which could definitely appear in real life). The main reason why this problem has become so artificial is that the hedge was planted along the diagonal of a rectangle-shaped garden, which must be said to be unusual at least. The problem was placed in a chapter dealing with Pythagoras' theorem, of course, and the task was to find the length of the hedge when the lengths of the rectangle-shaped garden were given. In real life, a normal approach would be simply to measure the length, but in this problem the idea is clearly to use Pythagoras' theorem to find the answer.

Based on this, one might conclude that a problem with a proper real-life connection is a problem that involves a context that is from real life and where the way of solving the problem would be the same in a school setting as in real life. These two demands make it difficult enough, since methods of solving problems in real life often include measurements and approximations, whereas school mathematics often imply the use of more accurate mathematical methods. The use of so called 'Fermi problems' would be more similar to 'real' problems, in that the solution is not known (or certain) and the methods of arriving at a solution involve approximations and estimations, which is often the case in problems that are encountered in real life. Examples of such Fermi problems are: How many people can be stuffed together in Denmark? How much food is consumed in Norway in a year?

11.8 Lessons learned

The findings from our study of Norwegian teachers that are presented and discussed throughout this thesis have some implications for studies of teacher's beliefs in general. Most important is that a study of beliefs (and practice) should involve a triangulation of sources. Our study has provided evidence that teachers' beliefs cannot always be distinguished from the analysis of a questionnaire. The use of interviews (and observations) in addition to the questionnaire survey proved invaluable for our study. Owen's example showed that answers to a questionnaire (and for that matter answers in interviews) should always be critically evaluated and checked with other sources. The same could be said about interviews, which have to be equally critically evaluated, especially for studies who rely heavily or solely on them.

Our study involved several sources of data, including classroom observations, interviews, questionnaires, videos (and other material related to the videos from the TIMSS 1999 Video Study), textbooks and curriculum papers. The use of multiple sources is common for case studies, and the discussion and analysis of these different sources in a process of triangulation is a potential strength for such studies. It must also be said that triangulation and the use of multiple sources can also complicate a study and the data analysis. It might be difficult to extract meaning from a complex data material, and when a study involves only one researcher the very process of dealing with the data (transcribing audio and/or video recordings, collecting and structuring the results of a questionnaire, etc.) might become overwhelming. For this study, the complexity and multitude of

data did at some point make the process of analysis more difficult, and it was hard to put all the pieces of information together in a sensible analysis and discussion. Although this process have been hard, and taken more time than initially intended, we believe that the results account for the costs.

The process of writing the thesis is often the most time consuming, and for this thesis the writing process started early. The theory chapter as well as the chapter on research methods and paradigms (chapter 6) was drafted long before the collection of data from the classrooms started, and so was the chapter on curriculum development. A research diary was written, especially in the periods of the field studies, and the field notes as well as the other data were written down in a word processor and 'cleaned up' during the process of data collection.

The data (transcripts, field notes, etc.) was written as pure text files and analysed using mainly the GNU text utilities, like `grep` (a tool for finding different kinds of patterns in text), and a small program called `analysistk` (a simple toolkit for analysing text) which was created by the researcher.

For the structuring and revision of drafts as well as the final thesis to be effective, the use of certain computer software is often necessary. This thesis has mainly been written in Open Office, which is a complete and open source office suite. Most of the illustrations have been made with the drawing program that is incorporated in the office suite. It might be a difficult process to structure a thesis, but the use of the excellent styles editor as well as the navigator in the word processor in Open Office has made that process easier.

11.9 The road ahead

We do not believe that curriculum reforms alone are enough to improve learning. Politically it might be a good idea, but research shows that beliefs about teaching and practice are hard to change (cf. Szydlik, Szydlik & Benson, 2003; Lerman, 1987; Brown, Cooney & Jones, 1990; Pajares, 1992; Foss & Kleinsasser, 1996). Curriculum changes do not seem to have much impact on teaching practice (cf. Alseth et al., 2003), and an improved knowledge of the curriculum intentions does not always imply change of teaching practice. With a complex activity like teaching, other solutions are required. A change of the teachers' beliefs is probably necessary in order to change teaching practice, but this also might not be enough. Teachers' beliefs, which can be interpreted as their subjective knowledge and include affective aspects, have proven to be resistant to change. The teachers know what the curriculum says, but their deep beliefs about mathematics and how to teach mathematics remain the same, and they do not always know how to apply these new ideas in practice. They lack the practical knowledge about how to actually manage the demands in the chaotic situations of their everyday classrooms.

Some teachers do not know how to apply the ideas, some are even in opposition to the ideas and do not want to apply them, while others successfully apply these ideas in their teaching. It is our belief that we need to study teachers' beliefs and teaching practices extensively in order to learn more about how to change the teaching on a local as well as a national level. By observing what they do and reflecting on their practices, we get ideas on how to improve our own teaching. Studies of experienced teachers should therefore be used more in teacher education. Lesson studies and a model for continuous development, like in Japan, could also be included in the practice of in-service teachers. Regular courses, which have often been arranged when new curriculum reforms have been introduced in Norway, have proven to be insufficient, and other approaches seem to be necessary. Many teachers ask for a source of ideas, materials, good examples, rich problems, etc. An important question is whether access to such resources will really make a difference. We believe that a complete change of practice needs to be implemented, so that the teachers get more time to prepare

their lessons. Extensive lesson studies need to become an integral part of every teacher's practice. Teaching should be viewed as more of an apprenticeship, where teachers continue to learn and develop their teaching after they have started practising as teachers. Teacher education should be more specific with regard to a knowledge of pedagogical content, and teachers should not have to reinvent everything by themselves.

We would like to suggest building a web site that could serve as a place for teachers to share ideas and exchange experiences for teachers. This could be done in a similar way as already existing web sites like the Norwegian site <http://www.matematikk.org>, but we believe it would be beneficial if the teachers could interact and add to the content to a larger degree. Such a web site could have been built with a wiki-like engine (cf. <http://wikipedia.org>) and it could serve as a place for the teachers to share ideas and thoughts about issues related to teaching and learning of mathematics. The benefit of such an organisation of a web site is that all teachers would have access to share and add content, so it would be a web site that could mirror the ideas and interests of practising teachers to a larger degree than pages that are created and maintained by researchers, lecturers at universities and colleges, etc. As discussed above, such a source of ideas on the internet is probably not sufficient, and it should be incorporated in a more long-term development project, where the teachers get the opportunity to challenge their beliefs, try out new approaches in practice and reflect on these.

Research suggests that experience with teachers in our own education is a strong contributor to our beliefs about teaching and learning. The initial beliefs about teaching and learning also seem to be tenacious and resistant to change. The main aim of our study was not to discover how the teachers' beliefs could be changed most effectively, and we do not claim to have a definite answer to such a question. Our study has revealed some important findings though, and it has provided several ideas and suggestions that could assist in the process of changing teachers' beliefs and teaching practice.

International studies have shown that Norwegian pupils do not perform well in mathematics compared to pupils in other countries. The newspapers tend to have a liking for writing articles that criticise schools and teaching, and the suggested solution often involves new reforms and new curricula. This is a popular solution among politicians also, and at least it gives everyone a feeling that something is being done to improve the situation. There is an ongoing discussion about what teaching should be like, and reforms tend to jump from one extreme to the other. Experiences from the Californian 'Math Wars' indicate the same (cf. Wilson, 2003). In a simplistic way we might say that it is the 'skill-drill-people' against the 'concepts-people' and the 'real-life-application-people'. The discussions seem to be never-ending, and there are always people who come up with stories to illustrate one view or the other. Owen's opinion of why curriculum reforms have been successful gave us a nice example that illustrated his point: the reason why everything has not gone terribly wrong in the Norwegian school system is that there are always some teachers who continue to do what they have always done, regardless of 'new' reforms and theories.

Norwegian curriculum reforms have often been followed by courses over a few days to train the practising teachers in how to teach according to the new reform. There are strong indications that this approach is not sufficient. Teachers are often left on their own to interpret the curriculum documents, and they do this according to their own beliefs and interpretation of the existing rhetoric. Beliefs are resistant to change, and a change of beliefs does not rely on knowledge alone. In our view, a reasonable place to start is the colleges for teacher education, but this again would imply that changes in teaching practice could not happen over night. We believe that lesson studies of experienced teachers should be an integral part of teacher education, but we also believe that lesson studies should become integrated in the activities of practising teachers, like the Japanese model suggests. Teachers are influenced by their colleagues, and a project in teacher education alone would probably not be sufficient either. Similar long-term projects should be arranged for practising teachers as well. The teachers should be given more concrete suggestions on other

sources they might use in their teaching, and there should be several resources other than the textbooks available for the teachers to use. Many teachers have wonderful ideas, which they carry out in their classrooms, and we wish that these ideas would become accessible for other teachers as well. A way of doing this could be to publish books and booklets where the ideas are presented. The Mathematics Centre in Chichester has done so in the UK. A sharing of ideas could also be done in forums where the teachers are encouraged to exchange experiences, on the web, in courses, in the schools, etc. Several web pages exist for that purpose already, but more teachers should use them.

An example of a long-term project for practising teachers, that fits the ideas described above, was the EMIL project in Lillesand (a small town in the southern parts of Norway). In this project, the county of Lillesand decided to do something about the school culture, especially concerning the teaching of mathematics. A two-year project that involved all teachers in the county was arranged, with very positive results (cf. Brekke & Streitlien, 2004).

L97 presents an approach to teaching that we believe in, and this is also in agreement with much of the research that has been done in the field. Our study does not prove, or aim at proving, that this way of teaching is the best (whatever that would mean). We believe, however, that an approach to teaching like what we have seen in the classrooms of teachers like Jane and Harry, and also in some lessons of Ann, Thomas and George, is a good way of meeting the demands of the curriculum. Some of the teachers we have studied in the TIMSS 1999 Video Study also had some interesting approaches that we might learn from. A study of experienced teachers' teaching is something we all can learn from. Even though teachers like Karin and Owen express opinions that are not directly in line with the ideas of the curriculum, at least in this respect, their ideas are important contributions to a discussion and should also be taken seriously. Teaching and learning are complicated matters, and we do not have a definite set of right and wrong approaches. We support one view more, and we believe that this study has shown how teaching according to this view can be organised.

12 Literature

- Ahmed, A. (Ed.) (1987) *Better Mathematics - A Curriculum Development Study*, London: Her Majesty's Stationery Office
- Ahmed, A. (Ed.) (1991) *Raising Achievement in Mathematics Project - A Curriculum Development Research Project*, Chichester: The Mathematics Centre
- Alseth, B.; Breiteig, T. & Brekke, G. (2003) *Evaluering av Reform 97 – Endringer og utvikling ved R97 som bakgrunn for videre planlegging og justering – matematikkfaget som kasus*. Notodden: TFN-rapport 02/2003
- Anderson, G. & Arsenault, N. (1998) *Fundamentals of Educational Research*, London: The Falmer Press
- Andrews, P. & Hatch, G. (2000) A comparison of Hungarian and English teachers' conceptions of mathematics and its teaching, *Educational Studies in Mathematics* 43, 31-64
- Anthony, G. (1996) Active Learning in a Constructivist Framework, *Educational Studies in Mathematics* 31, 349-369
- Arcavi, A. (2002) The Everyday and the Academic in Mathematics, in M.E. Brenner & J.N. Moschkovich (Eds.) *Everyday and Academic Mathematics in the Classroom*, pp. 12-29, Virginia: National Council of Teachers of Mathematics
- Atkinson, P. & Hammersley, M. (1998) Ethnography and Participant Observation, in N. K. Denzin & Y. S. Lincoln (Eds.) *Strategies of Qualitative Inquiry*, pp. 110-136, Thousand Oaks, CA: Sage Publications
- Backhouse, J., Haggarty, L., Pirie, S. & Stratton, J. (1992) *Improving the learning of mathematics*, Portsmouth, NH: Heinemann
- Bacon, F. (1994) *Novum Organon – With other parts of the great instauration*, (translated and edited by P. Urbach and J. Gibson), Chicago and La Salle, Illinois: Open Court Publishing Company
- Bakke, B. & Bakke, I.N. (1998) *Grunntall 9 – Grunnbok*, Elektronisk Undervisningsforlag
- Bakke, B. & Bakke, I. N. () *Grunntall 8 – Ressursperm*, Elektronisk Undervisningsforlag
- Baszanger, I. & Dodier, N. (2004) Ethnography – relating the part to the whole, in D. Silverman (Ed.) *Qualitative Research – Theory, Method and Practice (Second edition)*, pp. 9-34, London: Sage Publications
- Bebout, H. C. (1993) Using Children's Word-Problem Composition for Problem-Solving Instruction: A Way to Reach All Children with Mathematics, in G. Cuevas & M. Driscoll (Eds.) *Reaching All Students With Mathematics*, pp. 219-232, Virginia: National Council of Teachers of Mathematics
- Begg, A. J. (1984) Alternative Mathematics Program, in P. Damerow et al. (Eds.): *Mathematics for all - Problems of cultural selectivity and unequal distribution of mathematical education and future perspectives on mathematics teaching for the majority*, pp. 40-42, UNESCO: Division of Science Technical and Environmental Education
- Bekken, O.B. & Mosvold, R. (2003a) *The TIMSS 1999 Video Study – Helping teachers to become reflective practitioners*, Notodden: TFN Notat 01/03.

- Bekken, O.B. & Mosvold, R. (Eds.) (2003b) *Study the Masters*, Gothenburg: NCM.
- Bergersen, H. (1935) *Morsmålsoplæringen: en undersøkelse av lærestoffet*, Oslo: Gyldendal
- Bishop, A.J. (1988) *Mathematical enculturation: A cultural perspective on mathematics education*, Dordrecht, Netherlands: Kluwer
- Bjuland, R. (1998) Lærerstudenters matematiske tenkning og utvikling i en sosial kontekst. Problemløsning i små grupper, *Nordisk Matematikdidaktikk*, 6, 2, 41-67
- Boaler, J. (1993) Encouraging the transfer of 'school' mathematics to the 'real world' through the integration of process and content, context and culture, *Educational Studies in Mathematics* 25, 341-373
- Boaler, J. (1997) *Experiencing school mathematics - Teaching styles, sex and setting*, Buckingham, UK: Open University Press
- Boaler, J. (1998) Open and closed mathematics: Students' experiences and understandings, *Journal for Research in Mathematics Education*, 29, 49-62
- Boaler, J. (2000) Exploring situated insights into research and learning, *Journal for Research in Mathematics Education*, 31, 113-119
- Bradal, R. (1997) *Matematikk i arbeidslivet – Implikasjoner for skolen*, Kristiansand: Agder University College, Master's thesis
- Bradal, R. (1999) Synspunkter på matematikk i utdanningen sett i lys av matematikkens rolle på to utvalgte arbeidsplasser, *Nordisk Matematikdidaktikk*, 7, 2, 7-27
- Breiteig, T. et al. (1998a) *Matematikk 9 – Grunnbok*, Oslo: Aschehoug
- Breiteig, T. et al. (1998b) *Matematikk 9 – Oppgavebok*, Oslo: Aschehoug
- Breiteig, T. & Venheim, R. (1998) *Matematikk for lærere I*, Oslo: Tano Aschehoug
- Brekke, G. & Streitlien, Å. (2004) *Evaluering av EMIL-prosjektet i Lillesand kommune*, TFN-Rapport 04/09
- Brenner, M.E. & Moschkovich, J.N. (Eds.) (2002) *Everyday and Academic Mathematics in the Classroom*, Virginia: National Council of Teachers of Mathematics.
- Brown, S; Cooney, T. & Jones, D. (1990) Mathematics Teacher Education, in W.R. Houston, M. Haberman & J. Sikula (Eds.) *Handbook of research on teacher education*, pp. 639-656, New York: Macmillan
- Brownell, W.A. (1935) Psychological Considerations in the Learning and Teaching of Arithmetic, in W.D. Reeve (Ed.) *The Teaching of Arithmetic: Tenth Yearbook of the National Council of Teachers of Mathematics*, pp. 1-31, New York: Teachers College, Columbia University.
- Bryman, A. & Burgess, R. G. (Eds.) (1994) *Analyzing Qualitative Data*, New York: Routledge
- Bryman, A. (2001) *Social Research Methods*, Oxford: Oxford University Press
- Burkhardt, H. (1981) *The real world and mathematics*, The Shell Centre for Mathematical Education, University of Nottingham
- Calderhead, J. & Robson, M. (1991) Images of teaching: student teachers' early conceptions of classroom practice, *Teaching and Teacher Education* 7, 1-8
- Carraher, D. W. & Schliemann, A. D. (2002) Is Everyday Mathematics Truly Relevant to Mathematics Education? in: M.E. Brenner & J.N. Moschkovich (Eds.) *Everyday and Academic*

- Mathematics in the Classroom*, pp. 131-153, Virginia: National Council of Teachers of Mathematics
- Carraher, T. N.; Carraher, D. W. & Schliemann, A. D. (1984) Can Mathematics Teachers Teach Proportions? in P. Damerow et al. (Eds.): *Mathematics for all - Problems of cultural selectivity and unequal distribution of mathematical education and future perspectives on mathematics teaching for the majority*, pp. 90-91, UNESCO: Division of Science Technical and Environmental Education
- Carraher, T. N.; Carraher, D. W. & Schliemann, A. D. (1985) Mathematics in the streets and in schools, *British Journal of Developmental Psychology*, 3, 21-29
- Civil, M. (2002) Everyday mathematics, Mathematicians' Mathematics, and School Mathematics: Can We Bring Them Together? in M.E. Brenner & J.N. Moschkovich (Eds.) *Everyday and Academic Mathematics in the Classroom*, pp. 40-62, Virginia: National Council of Teachers of Mathematics
- Cockroft, W.H. (1982) *Mathematics counts*, London: Her Majesty's Stationery Office
- Cooper, B. & Harries, T. (2002) Children's responses to contrasting 'realistic' mathematics problems: Just how realistic are children ready to be? *Educational Studies in Mathematics* 49, 1-23
- Copes, L. (2003) Problems in the real world of mathematics education, *For the learning of mathematics vol. 23*, no. 1, 43-46
- Creswell, J.W. (1998) *Qualitative inquiry and research design – Choosing among five traditions*, Thousand Oaks, CA: Sage Publications, Inc.
- Davidson, N. (1990) Small-group cooperative learning in mathematics, in T.J. Cooney & C.J. Hirsch (Eds.) *Teaching and learning mathematics in the 1990s, 1990 Yearbook*, Reston, VA: NCTM
- Davis, P.J. & Hersch, R. (1981) *The Mathematical Experience*, Boston: Houghton Mifflin.
- Denzin, N.K. (1978) *The research act: A theoretical introduction to sociological methods (2. edition)*, New York: McGraw-Hill
- Denzin, N. K. & Lincoln, Y. S. (Eds.) (1998) *Strategies of qualitative inquiry*, Thousand Oaks, CA: Sage Publications, Inc.
- Denzin, N. K. & Lincoln, Y. S. (Eds.) (2000) *Handbook of qualitative research*, Thousand Oaks: Sage Publications, Inc.
- Dewey, J. (1990) *The school and society and the child and the curriculum*, Chicago: The University of Chicago Press
- Dokka, H.-J. (1967) *Fra allmueskole til folkeskole. Studier i den norske folkeskoles historie i det 19. hundreåret*, Bergen: Universitetsforlaget.
- Dokka, H.-J. (1988) *En skole gjennom 250 år. Den norske allmueskole – folkeskole – grunnskole 1739-1989*, Oslo: NKS-Forlaget
- Dougherty, B.J. (1990) Influences of teacher cognitive/conceptual levels on problem-solving instruction, in G. Booker et al. (Eds.) *Proceedings of the Fourteenth International Conference for the Psychology of Mathematics Education*, pp. 119-126, Oaxtepec, Mexico: International Group for the Psychology of Mathematics Education

- Dreyfus, H. & Dreyfus, S. (1986) *Mind over machine: the power of human intuition and expertise in the era of the computer*, Oxford: Basil Blackwell
- Edwards, H. M. (1977) *Fermat's Last Theorem - A genetic introduction to algebraic number theory*, New York: Springer-Verlag
- Ernest, P. (1988) *The impact of beliefs on the teaching of mathematics*, paper prepared for ICME VI, Budapest, Hungary
- Ernest, P. (Ed.) (1994a) *Constructing Mathematical Knowledge: Epistemology and Mathematical Education*, London: The Falmer Press
- Ernest, P. (1994b) *An introduction to research methodology and paradigms*, Exeter, UK: Research Support Unit, School of Education, University of Exeter
- Ernest, P. (1998) *Social Constructivism as a Philosophy of Mathematics*, New York: State University of New York Press
- Evans, J. (1999) Building bridges: Reflections on the problem of transfer of learning in mathematics, *Educational Studies in Mathematics* 39, 23-44
- Fasheh, M. (1991) Mathematics in a social context: math within education as praxis versus math within education as hegemony, in M. Harris (Ed.) *Schools, mathematics and work*, pp. 57-61, London: The Falmer Press
- Feiman-Nemser, S. & Buchmann, M. (1986) The first year of teacher preparation: transition to pedagogical thinking, *Journal of Curriculum Studies* 18, 239-256
- Flyvbjerg, B. (1991) *Rationalitet og magt: Bind I Det konkrete videnskab*, Århus: Akademisk Forlag
- Fontana, A. & Frey, J. H. (2000) The interview - From structured questions to negotiated text, in N.K. Denzin & Y.S. Lincoln (Eds.): *Handbook of qualitative research*, Thousand Oaks: Sage Publications, Inc.
- Foong, P. Y. (1999) Varför lyckades Singapore i TIMSS, *Nämnnaren*, 26, 3, 40-45
- Foong, P. Y. & Koay, P. L. (1998) Problem med verklighet i skolan, *Nämnnaren*, 25, 4, 6-11
- Forsøksrådet for skoleverket (1960) *Læreplan for forsøk med 9-årig skole*, Oslo: Aschehoug
- Foss, D. & Kleinsasser, R. (1996) Preservice elementary teachers' views of pedagogical and mathematical content knowledge, *Teaching & Teacher Education* 12 (4), 429-442
- Fraivillig, J. L.; Murphy, L. A. & Fuson, K. C. (1999) Advancing Children's Mathematical Thinking in Everyday Mathematics Classrooms, *Journal for Research in Mathematics Education* 30, 2, 148-170
- Frankfort-Nachmias, C. & Nachmias, D. (1996) *Research Methods in the Social Sciences*, London: Arnold
- Freudenthal, H. (1968) Why to teach mathematics so as to be useful, *Educational Studies in Mathematics* 1, (1, 2), 3-8
- Freudenthal, H. (1971) Geometry between the devil and the deep sea, *Educational Studies in Mathematics* 3, 413-435
- Freudenthal, H. (1973) *Mathematics as an educational task*, Dordrecht: D. Reidel Publishing Company
- Freudenthal, H. (1978) *Weeding and sowing*, Dordrecht: D. Reidel Publishing Company

- Freudenthal, H. (1991) *Revisiting mathematics education*, Dordrecht: Kluwer Academic Publishers
- Frøyland, E. (1965) *Matematikk i skolen. Hvorfor – hva og hvordan?*, Oslo: Hovedoppgave i pedagogikk
- Furinghetti, F. & Pehkonen, E. (2002) Rethinking characterizations of beliefs, in G.C. Leder et al. (Eds.) *Beliefs: a hidden variable in mathematics education?* pp. 39-57, Dordrecht: Kluwer Academic Publishers
- Fuson, K. C.; Carroll, W. M. & Drueck, J. V. (2000) Achievement Results for Second and Third Graders Using the Standards-Based Curriculum Everyday Mathematics, *Journal for Research in Mathematics Education* 31, 3, 277-295
- Gardner, H. (2000) *The Disciplined Mind: Beyond Facts and Standardized Tests, the K-12 Education that Every Child Deserves*, New York: Penguin Books
- Gjone, G. (1983) “Moderne matematikk” i skolen – Internasjonale reformbestrebelsler og nasjonalt læreplanarbeid, PhD thesis, Oslo
- Glaserfeld, E. von (1988) *The Construction of Knowledge - Contribution to Conceptual Semantics*, US: The Systems Inquiry Series
- Glaserfeld, E. von (1991) *Radical Constructivism in Mathematics Education*, Dordrecht: Kluwer Academic Publishers
- Glaserfeld, E. von (1995) *Radical Constructivism: A way of knowing and learning*, London: The Falmer Press
- Goldin, G.S. (2002) Affect, meta-affect, and mathematical belief structures, in G.C. Leder, E. Pehkonen & G. Törner (Eds.) *Beliefs: A Hidden Variable in Mathematics Education?* (pp. 59-72). London: Kluwer
- Goodlad, J.I. et al. (1979) *Curriculum inquiry: The study of curriculum practice*, New York: McGraw-Hill
- Gravemeijer, K. (1994) Developing realistic mathematics education, Utrecht: Utrecht University, CD-β series
- Gravemeijer, K. & Doorman M. (1999) Context Problems in Realistic Mathematics Education: A calculus course as an example, *Educational Studies in Mathematics* 39, 111-129
- Guile, D. & Young, M. (1999) Beyond the Institution of Apprenticeship: Towards a Social Theory of Learning as the Production of Knowledge, in P. Ainley & H. Rainbird (Eds.) *Apprenticeship -Towards a New Paradigm of Learning*, pp. 111-128
- Hammersley, M. (1990) *Classroom Ethnography – Empirical and Methodological Essays*, UK: Open University Press
- Hammersley, M. (1992) *What’s wrong with ethnography? – Methodological explorations*, London: Routledge
- Hammersley, M. & Atkinson, P. (1995) *Ethnography – Principles in practice*, London: Routledge
- Hannula, M. S. (2004) Affect in mathematical thinking and learning, *Annales Universitatis Turkuensis B* 273, Finland: University of Turku
- Hannula, M. S.; Kaasila, R.; Laine, A. & Pehkonen, E. (2004) *Student teachers’ views of mathematics at the beginning of their studies*, Paper presented at CERME 4

- Hansen, A. & Simonsen, B. (1996) Mellomtrinnet – mellom lek og alvor, in H. Bjørnsrud & F.D. Raaen (Eds.) *Grunnskolereformen –97. Om læreplanidealer og undervisnings-realiteter*, pp.91-110, Oslo: Universitetsforlaget
- Hansen, A. & Simonsen, B. (1999) *Temaorganisering på småskoletrinnet: helhet og sammenheng*, Oslo: Ad Notam Gyldendal
- Harel, G. (1994) On teacher education programmes in mathematics, *International Journal of Mathematical Education in Science and Technology* 25(1), 113-119
- Hativa, N. (1998) Lack of clarity in university teaching: A case study, *Higher Education*, 36, 353-381
- Heath, C. (2004) Analysing face-to-face interaction – Video, the visual and material, in D. Silverman (Ed.) *Qualitative Research – Theory, Method and Practice* (Second edition), pp. 266-282, London: Sage Publications
- Hiebert, J. et al (2003) *Teaching Mathematics in Seven Countries – Results from the TIMSS 1999 Video Study*. Washington DC: National Center for Education Statistics (NCES), US Department of Education.
- High/Scope (2002a) Educational Programs - Elementary approach: Fundamental goals and purposes, <http://www.highscope.org/EducationalPrograms/Elementary/fundamentalgoals.htm>
- High/Scope (2002b) Educational Programs - Elementary approach: Psychological foundations, <http://www.highscope.org/EducationalPrograms/Elementary/philosophy.htm>
- High/Scope (2002c) Educational Programs - Elementary approach: Mathematics, <http://www.highscope.org/EducationalPrograms/Elementary/mathematics.htm>
- Hopkins, D. (1993) *A Teacher's Guide to Classroom Research*, Buckingham: Open University Press
- Hundeide, K. (1977) *Piaget i kritisk lys*, Oslo: J.W. Cappelens Forlag AS
- Hundeide, K. (1985) *Piaget i skolen*, Oslo: J.W. Cappelens Forlag AS
- Hyde, D.M.G. (1970) *Piaget and conceptual development*, London: Holt, Rinehart and Winston Ltd.
- Imsen, G. (1998) *Elevens verden - innføring i pedagogisk psykologi*, Oslo: Tano Aschehoug
- Irwin, K. C. (2001) Using Everyday Knowledge of Decimals to Enhance Understanding, *Journal for Research in Mathematics Education* 32, 4, 399-420
- Johansson, B. & Emanuelsson, G. (1999) Lektioner i USA och Japan, *Nämnamnaren*, 26, 3, 46-47
- Jørgensen, M. (2002) Tornerose i steinrøysa, kronikk i *Dagbladet* 4. februar.
- Kagan, S. (1992) *Cooperative learning*, San Juan Capistrano, CA: Kagan Cooperative Learning
- Kantowski, M.G. (1980) Describing the affective domain: saying what we mean, in McLeod & Adams (Eds.) *Affects and mathematical problem solving*, pp. 37-45, New York: Springer-Verlag
- Kilpatrick, J. (1992) A History of Research in Mathematics Education, in D.A. Grouws (Ed.) *Handbook of Research on Mathematics Teaching and Learning*, pp. 3-38, New York: MacMillan Publishing Company
- Koritzinsky, T. (1997) *Tema- og prosjektarbeid i grunnskolen*, Oslo: Ad Notam Gyldendal
- Koritzinsky, T. (2000) *Pedagogikk og politikk i L 97: Læreplanens innhold og beslutningsprosessene*, Oslo: Universitetsforlaget

- KUD (1922) *Normalplan for landsfolkeskolen*, Kirke- og undervisningsdepartementet, Kristiania: J.M. Stenersens forlag
- KUD (1925) *Normalplan for byfolkeskolen*, Kirke- og undervisningsdepartementet, Oslo: J.M. Stenersens forlag
- KUD (1965), *Normalplan for byfolkeskolen*, 3. opplag, 2. suppleringsopplag av planen av 1939, Kirke- og undervisningsdepartementet, Oslo: H. Aschehoug & Co.
- KUD (1971) *Mønsterplan for grunnskolen – Midlertidig utgave*, Kirke- og undervisningsdepartementet, Oslo: Aschehoug
- KUD (1974) *Mønsterplan for grunnskolen*, Kirke- og undervisningsdepartementet, Oslo: Aschehoug
- KUD (1985) *Mønsterplan for grunnskolen – Revidert og midlertidig utgave*, Kirke- og undervisningsdepartementet, Oslo: Aschehoug
- KUD (1987) *Mønsterplan for grunnskolen*, Kirke- og undervisningsdepartementet, Oslo: Aschehoug
- KUF (1995) *Høringsutkast – Læreplan for fag i 10-årig grunnskole L 97*, Læreplangruppene, Kirke-, Utdannings- og forskningsdepartementet – 20.07.95
- KUF (1996) *Læreplanverket for den 10-årige grunnskolen*, Det kongelige kirke-, utdannings- og forskningsdepartement
- KUF (1999) *Læreplan for videregående opplæring: Matematikk, felles allment fag i alle studieretninger*, Oslo: Kirke-, undervisnings- og forskningsdepartementet
- Kuhs, T.M. & Ball, D.L. (1986) *Approaches to teaching mathematics: Mapping the domains of knowledge, skills, and dispositions*, East Lansing: Michigan State University
- Lave, J. (1988) *Cognition in practice - Mind, mathematics and culture in everyday life*, Cambridge: Cambridge University Press
- Lave, J. & Wenger, E. (1991) *Situated Learning - Legitimate peripheral participation*, Cambridge, US: Cambridge University Press
- Leder, G.C.; Pehkonen, E. & Törner, G. (Eds.) (2002) *Beliefs: A hidden variable in mathematics education*, Dordrecht: Kluwer Academic Publishers
- Leimar, U. (1976) *Leseinnlæring bygd på barnas eget språk*, Oslo: Tanum-Norli
- Lerman, S. (1983) Problem solving or knowledge centered: The influence of philosophy on mathematics teaching, *International Journal of Mathematics Education in Science and Technology*, 14 (1), 59-66
- Lerman, S. (1987) Investigations: Where to now? in P. Ernest (Ed.) *Teaching and learning mathematics, part 1* (Perspectives 33), pp. 47-56, Exeter: University of Exeter School of Education
- Lesh, R. & Lamon, S.J. (Eds.) (1992) *Assessment of Authentic Performance in School Mathematics*, Washington, DC: American Association for the Advancement of Science
- Lillard, P. P. (1976) *Montessoripedagogiken i vår tid*, Helsingborg: Schmidts Boktryckeri AB (orig. tittel: Montessori. A Modern Approach, 1972)
- Lloyd, G. (2002) Mathematics teachers' beliefs and experiences with innovative curriculum materials, in G.C. Leder et al. (Eds.) *Beliefs: A hidden variable in mathematics education?* pp. 149-159, Dordrecht: Kluwer Academic Publishers

- Maier, E. (1991) Folk mathematics, in M. Harris (Ed.) *School, mathematics and work*, Basingstoke: The Falmer Press
- Malmer, G. (1989) *Matematikk er spennende*, Oslo: H. Aschehoug & Co
- Malmer, G. (1999) *Bra matematik för alla - Nödvendig för elever med inlärningssvårigheter*, Lund: Studentlitteratur
- Malmer, G. (2002) Mindre räknande - mera tenkande, in *En matematikk for alle i en skole for alle - Seminarrapport*, pp. 9-24, Kristiansand: Forum for matematikkvansker
- Marks, R. (1987) Those who appreciate: The mathematician as secondary teacher. A case study of Joe, a beginning mathematics teacher, *Knowledge growth in a profession series*, Stanford, CA: Stanford University, School of Education
- Marton, F. & Morris, P. (Eds.) (2002) What matters? – Discovering critical conditions of classroom learning, in *Göteborg Studies in Educational Sciences 181*, Gothenburg: Acta Universitatis Gothoburgensis
- McLeod, D. B. (1992) Research in Affect in Mathematics Education: A Reconceptualization, in D.G.Grouws (Ed.) *Handbook of Research on Mathematics Teaching and Learning*, pp. 575-596, New York: Macmillan
- McLeod, D.B. & McLeod, S.H. (2002) Synthesis – Beliefs and mathematics education: implications for learning, teaching, and research, in G.C. Leder et al. (Eds.) *Beliefs: a hidden variable in mathematics education?* pp. 115-123, Dordrecht: Kluwer Academic Publishers
- Mellin-Olsen, S. (1977) *Læring som sosial prosess - Om årsakene til at dagens "skoleflinke" elever ofte mangler interesse for lærestoffet*, Oslo: Gyldendal Norsk Forlag
- Mellin-Olsen, S. et al. (1979) *Matematikk i elevens omgivelser - En idébok for lærere*, Oslo: NKI-forlaget
- Mellin-Olsen, S. (1984) *Eleven, matematikken og samfunnet - En undervisningslære*, Oslo: NKI-forlaget
- Mellin-Olsen, S. (1991) *Hvordan tenker lærere om matematikkundervisning?* Bergen: Bergen Lærerhøgskole
- MER (1990) *Curriculum Guidelines for Compulsory Education in Norway* (English version of M 87, published by the Ministry of Education and Research), Oslo: H. Aschehoug & Co.
- MER (2000) *Curriculum for Upper Secondary Education, Specialized Subjects in General and Business Studies: Mathematics*, Oslo: Ministry of Education, Research and Church Affairs
- Miles, M. B. & Huberman, A. M. (1994) *Qualitative Data Analysis*, Thousand Oakes: Sage Publications
- Miller, J. & Glassner, B. (2004) The “inside” and the “outside” - Finding realities in interviews, in D. Silverman (Ed.) *Qualitative Research – Theory, Method and Practice (Second edition)*, pp. 125-139, London: Sage Publications
- Montessori, M. (1964) *The Montessori Method*, New York: Schocken Books
- Moschkovich, J.N. & Brenner, M.E. (2000) Integrating a naturalistic paradigm into research on mathematics and science cognition and learning, in A.E. Kelly & R.A. Lesh (Eds.) *Handbook of research design in mathematics and science education*, pp. 457-486, Mahwah, New Jersey: Lawrence Erlbaum Associates, Publishers

- Mosvold, R. (2001) *Det genetiske prinsipp i matematikdidaktikk*, Kristiansand: Agder University College, Master's thesis
- Mosvold, R. (2002a) *Genesis principles in mathematics education*, Notodden: TFN Rapport 09/02
- Mosvold, R. (2002b) *Læreplanutvikling i historisk perspektiv – med fokus på “hverdagsmatematikk i dagliglivet”*, Notodden: TFN Rapport 08/02
- Mosvold, R. (2002c) *Matematikk i hverdagen – Vinkelbegrepet*, Notodden: TFN Rapport 11/02
- Mosvold, R. (2003) *Mathematics in Everyday Life*, Notodden: TFN Rapport 07/03
- Mouwitz, L. (1999) Problemløsning – några strandfynd vid Nämnaren, *Nämnaren*, 26, 4, 80-96
- Muthukrishna, N. & Borkowski, J. D. (1996) Constructivism and the Motivated Transfer of Skills, in M. Carr (Ed.) *Motivation in Mathematics*, pp. 63-87, New Jersey, Hampton Press, inc.
- NCTM (1989) *Curriculum and evaluation standards for school mathematics*, Reston, VA: Author
- NCTM (2000) *Principles and standards for school mathematics*, Reston, VA: Author
- Niedderer, H. (1987) *Alternative framework for students in mechanics and atomic physics. Methods of research and results*, Paper presented at the Second International Seminar on Misconceptions and Educational Strategies in Science and Mathematics, July 26-29, 1987, Cornell University
- Nielsen, K. & Kvale, S. (1999) *Mesterlære - Læring som sosial praksis*, Oslo: Ad Notam Gyldendal
- Nilsson, J. (2003) Verkligheten som träningsfelt? *Nämnaren* 30, 3, 7-13
- Nordberg, G. (2000) *Matematikk læreren – Håndbok for lærere på ungdomstrinnet*, Akribe Forlag as
- Nunes, T.; Schliemann, A.D. & Carraher D.W. (1993) *Street mathematics and school mathematics*, Cambridge: Cambridge University Press
- Oldervoll, T.; Orskaug, O. & Vaaje, A. (1997) *Sinus IMA – Grunnbok*, Oslo: J.W. Cappelens Forlag
- Oldervoll, T.; Orskaug, O. & Vaaje, A. (2000a) *Sinus for hotell- og næringsmiddelfag*, Oslo: J.W. Cappelens Forlag
- Oldervoll, T.; Orskaug, O. & Vaaje, A. (2000b) *Sinus for formgivingsfag*, Oslo: J.W. Cappelens Forlag
- Oldervoll, T.; Orskaug, O. & Vaaje, A. (2001) *Sinus 1 MXY – Grunnbok*, Oslo: J.W. Cappelens Forlag
- Olsen, K.-R. & Wølner, T. A. (2003) *Storyline for ungdomstrinnet*, Oslo: Universitetsforlaget
- Op't Eynde, P.; De Corte, E. & Verschaffel, L. (1999) *Balancing between Cognition and Affect: Students' Mathematics-Related Beliefs and Their Emotions during Problem-solving*, Paper presented to the Conference on Mathematics Beliefs and Their Impact on Teaching and Learning of Mathematics, Mathematical Research Institute, Oberwolfach, Germany.
- Pajares, M.F. (1992) Teachers' beliefs and educational research: cleaning up a messy construct, *Review of Educational Research* 62(3), 307-332
- Palm, T. (2001) *Performance and authentic assessment, realistic and real life tasks: A conceptual analysis of the literature* (Research reports, No 4, in Mathematics Education), Umeå, Sweden: Umeå University

- Palm, T. (2002) *The Realism of Mathematical School Tasks – Features and Consequences*, Doctoral Thesis No 24, Umeå: Umeå University
- Palm, T. (2002b) *Impact of authenticity on sense making in word problem solving* (Research report, No 2, in Mathematics Education), Umeå, Sweden: Umeå University, Department of Mathematics
- Parkhurst, H. (1922) *Education on the Dalton plan*, London
- Parkhurst, H. (1926) *An explanation of the Dalton Laboratory Plan*, London: Dalton Association
- Penrose, R. (1994) *Shadows of the mind - A search for the missing science of consciousness*, Oxford: Oxford University Press
- Phillips, D.C. (2000) *Constructivism in Education - Opinions and Second Opinions on Controversial Issues*, Chicago: The University of Chicago Press
- Piaget, J. (1972) *Framtidens skola – Att förstå är att upptäcka*, Stockholm: Forum
- Piaget, J. (1979) *Structuralism*, New York: Basic Books, Inc.
- Pong, W.Y. & Morris, P. (2002) Accounting for differences in achievement, in F. Marton & P. Morris (Eds.) *What matters? Discovering critical conditions of classroom learning*, pp. 9-18, Gothenburg: Acta Universitatis Gothoburgensis
- Prawat, R.S. (1991) The Value of Ideas: The Immersion Approach to the Development of Thinking, *Educational Researcher* 20, 2, 3-10
- Prytz, J. (2003) “Moderna” ideer från förr och nu, *Nämnnaren* 30, 1, 42-47
- Ribsskog, B. (1935) *Regning*, Oslo: Gyldendal Norsk Forlag
- Ribsskog, B. & Aall, A. (1936) *Undervisningsplanene i folkeskolen*, Oslo: Gyldendal Norsk Forlag
- RMERC (1999) *The Curriculum for the 10-year Compulsory School in Norway*, Oslo: The Royal Ministry of Education, Research and Church Affairs.
- Säljö, R. (2001) *Läring i praksis – et sosiokulturelt perspektiv*, Oslo: Cappelen Akademisk Forlag
- Scheffler, I. (1965) *Conditions of knowledge*, Chicago: Scott Foresman and Company
- Selter, C. (1998) Building on children’s mathematics – a teaching experiment in grade three, *Educational Studies in Mathematics* 36, 1-27
- Sethne, A. (1953) Normalplanene av 1939. En merkepel i norsk skole, in *Festskrift til B. Ribsskog, 25. januar 1953*, Oslo: Gyldendal
- Silvermann, D. (1993) *Interpreting qualitative data – Methods for analysing talk, text and interaction*, London: Sage Publications
- Skemp, R. R. (1978) Relational understanding and instrumental understanding, *Arithmetic Teacher*, 35, 9-15
- Smith, F. (2002) *The glass wall - Why mathematics can seem difficult*, New York: Teachers College Press, Teachers College, Columbia University
- Stake, R. E. (1994) Case studies, in N.K. Denzin & Y.S. Lincoln (Eds.) *Handbook of qualitative research*, pp. 236-247, Thousand Oaks, CA: Sage Publications, Inc.
- Stake, R.E. (1995) *The art of case study research*, Thousand Oaks, CA: Sage Publications, Inc.
- Stake, R. (1998) Case studies, in N.K. Denzin & Y.S. Lincoln (Eds.) *Strategies of qualitative inquiry*, pp. 86-109, Thousand Oaks, CA: Sage Publications Inc.

- Stake, R.E. (2000) Case studies, in N.K. Denzin & Y.S. Lincoln (Eds.) *Handbook of qualitative research (second edition)*, pp. 435-454, Thousand Oaks, CA: Sage Publications, Inc.
- Stanic, G.M.A. & Kilpatrick, J. (1988) Historical Perspectives on Problem Solving in the Mathematics Curriculum, in R.I. Charles & E.A. Silver (Eds.) *The Teaching and Assessing of Mathematical Problem Solving*, pp. 1-22, Reston, VA: National Council of Teachers of Mathematics
- Sterner, G. (1999) Nämnaren i en lärares vardag, *Nämnaren* 4, 72-79
- Stevenson, H.W & Stigler, J.W. (1992) *The Learning Gap – Why our schools are failing and what we can learn from Japanese and Chinese education*. New York: Touchstone
- Stigler, J.W. & Hiebert, J. (1999) *The Teaching Gap: Best Ideas From the World's Teachers for Improving Education in the Classroom*, New York: Free Press.
- Stillman, G. A. & Galbraith, P. L. (1998) Applying mathematics with real world connections: Metacognitive characteristics of secondary students, *Educational Studies in Mathematics* 36, 157-195
- Streefland, L. (1991) *Fractions in Realistic Mathematics Education - A Paradigm of Developmental Research*, Dordrecht: Kluwer Academic Publishers
- Sunnanå, O. (1960) *Georg Kerschensteiner og arbeidsskulen*, Oslo: Det norske samlaget
- Sztajn, P. (2003) Adapting reform ideas in different mathematics classrooms: Beliefs beyond mathematics, *Journal of Mathematics Teacher Education* 6, 53-75
- Szydlik, J. E.; Szydlik, S. D. & Benson, S. R. (2003) Exploring changes in pre-service elementary teachers' mathematical beliefs, *Journal of Mathematics Teacher Education* vol. 6, no. 3, 253-279
- Thompson, A. G. (1984) The relationship of teachers' conceptions of mathematics to instructional practice, *Educational Studies in Mathematics*, 15, 105-127
- Thompson, A.G. (1992) Teachers' Beliefs and Conceptions: A Synthesis of the Research, in D.G. Grouws (Ed.) *Handbook of Research on Mathematics Teaching and Learning*, pp. 127-146, New York: Macmillan
- Toeplitz, O. (1963) *The Calculus - a genetic approach*, Chicago: Univ of Chicago Press
- Treffers, A. (1987) *Three dimensions: A model of goal and theory description in mathematics instruction – The Wiskobas Project*, Dordrecht: Reidel
- Tryphon, A. & Vonèche, J. (Eds.) (1996) *Piaget – Vygotsky, The social genesis of thought*, UK: Psychology Press
- Törefors, J. (1998) För allt smör i Småland, *Nämnaren* 3, 32-36
- Vaage, S. (Ed.) (2000) *Learning by Dewey: barnet, skolen og den nye pædagogik*, Copenhagen: Gyldendal Uddannelse
- Van Amerom, B. A. (2002) *Reinvention of early algebra - Developmental research on the transition from arithmetic to algebra*, Utrecht: CD-β Press
- Van den Brink, J. (1973) Bijna noemen, *Wiskobasbulletin* 3, 129-131
- Van den Heuvel-Panhuizen, M. (2003) The didactical use of models in realistic mathematics education. An example from a longitudinal trajectory on percentage, *Educational Studies in Mathematics* 54, 9-35

- Van der Kooij, H. (2001) Mathematics and Key Skills for the Workplace, in G.E. FitzSimons et al. (Eds.) *Adult and Lifelong Education in Mathematics*, Melbourne: Language Australia
- Van Reeuwijk, M. (1995) Students' knowledge of algebra, in L. Meira & D. Carraher (Eds.) *Proceedings of the 19th International Conference for the Psychology of Mathematics Education* (PME 19, Vol.1), pp. 135-150, Recife, Brazil: Universidade Federal de Pernambuco
- Verschaffel, L. & de Corte, E. (1997) Teaching Realistic Mathematical Modeling in the Elementary School: A Teaching Experiment with Fifth Graders, *Journal for Research in Mathematics Education* 28, 5, 577-601
- Verschaffel, L.; Greer, B. & de Corte, E. (2000) *Making sense of word problems*, Lisse (NL): Swetz & Zeitlinger
- Wahl Andersen, M. (2002) Om at lære at gange – I den nærmeste udviklingszone, in *En matematikk for alle i en skole for alle - Seminarrapport*, pp. 97-105, Kristiansand: Forum for matematikkvansker
- Wertsch, J. V. (Ed.) (1979 [1981]) *The concept of activity in Soviet psychology*, New York: M. E. Sharpe, inc.
- Wijdeveld, E. (1980) Zich realiseren, in IOWO, *De Achterkant van de Möbiusband*, pp. 23-26, IOWO, Utrecht: The Netherlands
- Wilson, M. & Cooney, T. (2002) Mathematics teacher change and development – The role of beliefs, in G.C. Leder et al. (Eds.) *Beliefs: a hidden variable in mathematics education?* pp. 127-147, Dordrecht: Kluwer Academic Publishers
- Wilson, S. M. (2003) *California dreaming: Reforming mathematics education*, New York: Yale University Press
- Wistedt, I. (1990) *Vardagskunskaper och skolmatematik - Några utgångspunkter för en empirisk studie*, Stockholms Universitet, Pedagogiska Institutionen
- Wistedt, I. (1992) *Att vardagsanknyta matematikundervisningen - slutrapport från projektet Vardagskunskaper och skolmatematik*, Stockholms Universitet, Pedagogiska Institutionen
- Wistedt, I. (1993) *Att använda barns informella kunskaper i matematikundervisningen - slutrapport från ett uppföljningsprojekt*, Stockholms Universitet, Pedagogiska Institutionen
- Wittmann, E. Ch. (2001) The alpha and omega of teacher education: organizing mathematical activities, in D. Holton et al. (Eds.), *The Teaching and Learning of Mathematics at University Level: An ICMI Study*, pp. 539-552, Netherlands: Kluwer Academic Publishers
- Wittmann, E. Ch. (2001b) Developing mathematics education in a systemic process, *Educational Studies in Mathematics* 48, 1-20
- Wood, D. (1988) *How children think and learn*, Oxford: Blackwell
- Woolfolk, A. (2001) *Educational psychology*, US: Allyn and Bacon
- Wubbels, T.; Korthagen, F. & Broekman, H. (1997) Preparing teachers for Realistic Mathematics Education, *Educational Studies in Mathematics* 32, 1-28
- Yin, R. K. (1994) *Case study research – Design and methods (second edition)*, Thousand Oaks, CA: Sage Publications Inc.

13 Appendix 1: Everyday mathematics in L97

We will here present how L97 deals with the issue of mathematics in everyday life, including several excerpts from the curriculum framework. (All excerpts are from the official English version of L97, and not my own translations!)

The subject and educational aims

Man has from the earliest times wanted to explore the world around him, in order to sort, systematise and categorise his observations, experiences and impressions in attempts to solve the riddles of existence and explain natural relationships. The development of mathematics springs from the human urge to explore, measure and grasp. The knowledge and skills which are the necessary tools for these purposes develop through mathematical activities.

Mathematics has many modes of expression and is undergoing constant development. It is a science, an art, a craft, a language and a tool. Reasoning, imagination and experience are all important elements of mathematics. Mathematics as a school subject seeks to mirror this breadth and this development.

The work with mathematics in compulsory school is intended to arouse interest and convey insight, and to be useful and satisfying to all pupils, in their study of the discipline, their work with other subjects, and in life in general. The practical applications, examples and methods chosen are meant to ensure that girls and boys alike, and pupils with different cultural and social backgrounds, have the opportunity to experience a sense of belonging and to develop favourable attitudes to the discipline. They shall gain insight into and confidence in their own potential. The syllabus seeks to create close links between school mathematics and mathematics in the outside world. Day-to-day experience, play and experiment help to build up its concepts and terminology.

Technological development opens up new opportunities while at the same time confronting us with challenges both in school and outside. Mathematical insight and skills are needed in order to understand and utilise new technology, and is also a key to communication in modern societies.

Mathematical knowledge and skills are an important foundation for participation in working life and leisure activities, and for understanding and influencing social processes. Mathematics can help individuals to master challenges (RMERC, 1999, pp. 165-166).

Approaches to the study of Mathematics

Pupils' experience and previous knowledge, and the assignments they are given, are important elements in the learning process.

Learners construct their own mathematical concepts. In that connection it is important to emphasise discussion and reflection. The starting point should be a meaningful situation, and tasks and problems should be realistic in order to motivate pupils (RMERC, 1999, p. 167).

In work on assignments and problems involving problem solving and investigation, calculators and other terms of information technology open up opportunities for new approaches (RMERC, 1999, p. 167).

At the intermediate stage, too, mathematics must be firmly rooted in practical matters. Play and games, and nature and the local environment offer opportunities for putting mathematics into practice. At the same time, pupils will gradually encounter the more abstract aspects of the discipline. Education must emphasise a variety of challenges, so that the discipline can contribute to the good all-round development of each individual pupil.

At the lower secondary stage, greater emphasis is given to the formal and abstract aspects of the subject and to the use of mathematics in society. Practical situations and pupils' own experience remain important, however. Pupils must in addition be challenged to build up chains of reasoning and to combine knowledge from various areas of mathematics. In this way they can develop greater understanding of the discipline and a wider perspective on the use of mathematics.

Pupils' own activities are of the greatest importance in the study of mathematics. The mathematics teaching must at all levels provide pupils with opportunities to:

carry out practical work and gain concrete experience;
 investigate and explore connections, discover patterns and solve problems;
 talk about mathematics, write about their work, and formulate results and solutions;
 exercise skills, knowledge and procedures;
 reason, give reasons, and draw conclusions;
 work co-operatively on assignments and problems (RMERC, 1999, pp. 167-168).

The structure of the subject

The first area of the syllabus, mathematics in everyday life, establishes the subject in a social and cultural context and is especially oriented towards users. The further areas of the syllabus are based on main areas of mathematics (RMERC, 1999, p. 168).

Main stages	Main areas				
Lower secondary stage	Mathematics in everyday life	Numbers of algebra	Geometry	Handling data	Intermediate graphs and functions
Intermediate stage	Mathematics in everyday life	Numbers	Geometry	Handling data	
Primary stage	Mathematics in everyday life	Numbers	Space and shape		

GENERAL AIMS FOR THE SUBJECT ARE

- for pupils to develop a positive attitude to mathematics, experience the subject as meaningful, and build up confidence as to their own potential in the subject
- for mathematics to become a tool which pupils will find useful at school, in their leisure activities, and in their working and social lives
- for pupils to be stimulated to use their imaginations, personal resources and knowledge to find methods of solution and alternatives through exploratory and problem-solving activities and conscious choices of resources
- for pupils to develop skills in reading, formulating and communicating issues and ideas in which it is natural to use the language and symbols of mathematics
- for pupils to develop insight into fundamental mathematical concepts and methods, and to develop an ability to see relations and structures and to understand and use logical chains of reasoning and draw conclusions
- for pupils to develop insight into the history of mathematics and into its role in culture and science (RMERC, 1999, p. 170).

Subject-related objectives for the primary stage, grades 1–4

Mathematics in daily life

Pupils should become acquainted with fundamental mathematical concepts which relate directly to their everyday experience. They should experience and become familiar with the use of mathematics at home, at school and in the local community. They should learn to cooperate in describing and resolving situations and problems, talk about and explain their thinking, and develop confidence in their own abilities (RMERC, 1999, p. 170).

Grade 1 /preschool

Mathematics in everyday life

Pupils should have the opportunity to

- try to make and observe rules for play and games, and arrange and count
- experience sorting objects according to such properties as size, shape, weight and colour, and handle a wide variety of objects as a basis for discovering and using words for differences and similarities
- gain experience with simple measuring, reading and interpreting numbers and scales and with expressions for time (RMERC, 1999, p. 171).

Grade 2

Mathematics in everyday life

Pupils should have the opportunity to

- work with arranging and counting in play, games and practical tasks
- discover differences and similarities by sorting and classifying objects according to their properties
- practise measuring and assessing quantities, work with the clock and time and with Norwegian coins and notes, and practise counting money and giving change
- work practically, with counting stories, for example from the local environment (RMERC, 1999, p. 171).

Grade 3

Mathematics in everyday life

Pupils should have the opportunity to

- cooperate in assessing various possibilities and solutions, in play, games and practical tasks
- practise choosing appropriate measuring instruments and gain experience in their use, and assess and compare quantities. Continue to work with the clock and time
- discuss, assess and carry out assignments relating to past and present buying and selling, for instance organising and playing shop
- collect and try to sort and arrange data from areas they themselves are interested in, from nature and from the neighbourhood where they live (RMERC, 1999, p. 172).

Grade 4

Mathematics in everyday life

Pupils should have the opportunity to

- experience planning and carrying out various activities and cooperative assignments, for instance dividing into teams and groups and organising performances
- continue working with measurement and measuring tools
- collect, record and illustrate data, for instance using tallies, tables and bar graphs
- work with the calendar (RMERC, 1999, p. 173).

Subject-related objectives for the intermediate stage, grades 5–7

Mathematics in everyday life

Pupils should experience mathematics as a useful tool also in other subjects and in everyday life and be able to use it in connection with conditions at home and in society. They should develop their own concepts of different quantities and units, estimate and calculate with them and with money and time, and become familiar with the use of appropriate aids, especially calculators and computers (RMERC, 1999, p. 174).

Grade 5

Mathematics in everyday life

Pupils should have the opportunity to

- try out and experience the connections between units for distance, volume and weight, and work further on time, units of time, and the calendar
- formulate and solve mathematical problems relating to their hobbies and leisure activities
- use mathematics in connection with the disposal of money, buying and selling (RMERC, 1999, p. 175).

Grade 6

Mathematics in everyday life

Pupils should have the opportunity to

- make calculations related to everyday life, for instance concerning food and nutrition, travel, timetables, telephoning and postage
- go more deeply into quantities and units, and especially the calculation of time. Learn about measurement in some other cultures
- gain experience with units of money, rates of exchange, and conversion between Norwegian and foreign currencies
- use mathematics to describe natural phenomena, for instance light and shade, day and night, seasons, and the solar system (RMERC, 1999, pp. 175-176).

Grade 7

Mathematics in everyday life

Pupils should have the opportunity to

- practise using mathematics to express and process information on matters arising in their own environment
- study and solve problems related to money, for example in connection with work and salary or saving and interest
- work with combined units and quantities, such as speed and price, and show the relations graphically and by mathematical terms
- continue to work on monetary units, exchange rates and conversion between Norwegian and foreign currencies
- seek historical information on the sexagesimal system and see how it relates to time – days, hours, minutes and seconds, and to the division of the circle and the globe into degrees (RMERC, 1999, p. 177).

Subject-related objectives for the lower secondary stage, grades 8 - 10

Mathematics in everyday life

Pupils should learn to use their mathematical knowledge as a tool for tackling assignments and problems in everyday life and in society. When dealing with a relevant theme or problem area, pupils will be able to collect and analyse information using the language of mathematics, to develop results using methods and tools they have mastered, and try out their approaches on the matter in question. Pupils should know about the use of IT and learn to judge which aids are most appropriate in the given situation (RMERC, 1999, p. 178).

Grade 8

Mathematics in everyday life

Pupils should have the opportunity to

- continue working with quantities and units
- register and formulate problems and tasks related to their local environment and community, their work and leisure, and gain experience in choosing and using appropriate approaches and aids and in evaluating solutions
- be acquainted with the main principles of spreadsheets and usually experience their use in computers
- study questions relating to personal finance and patterns of consumption. Gain some experience of drawing up simple budgets, keeping accounts, and judging prices and discounts and various methods of payment
- practise calculating in foreign currencies (RMERC, 1999, p. 179)

Grade 9

Mathematics in everyday life

Pupils should have the opportunity to

- work with the most commonly used simple and compound units
- register, formulate and work on problems and assignments relating to social life, such as employment, health and nutrition, population trends and election methods
- work on questions and tasks relating to economics, e.g. wages, taxes, social security and insurance
- experience simple calculations relating to trade in goods, using such terms as costs, revenues, price, value added tax, loss and profit
- use mathematics to describe and process some more complex situations and small projects (RMERC, 1999, p. 180)

Grade 10

Mathematics in everyday life

Pupils should have the opportunity to

- evaluate the uses of measuring instruments and assess uncertainties of measurement
- apply mathematics to questions and problems arising in the management of the nature and natural resources, for instance pollution, consumption, energy supplies and use, and traffic and communications
- work with factors relating to savings and loans, simple and compound interest, and the terms and conditions for the repayment of loans, for instance using spreadsheets and other aids
- work on complex problems and assignments in realistic contexts, for instance in projects (RMERC, 1999, pp. 181-182)

Dimensions of the curriculum

We have now seen what L97 explicitly states about mathematics in everyday life, and how this connection should be carried out in the different levels. We should be aware of the different dimensions of the curriculum, which could be presented through the three different categories of aims that we can find:

- Aims that are based on mathematical content and topics.
- Aims that represent methods of work.
- Aims that deal with context, use, social or cultural connection.

The main areas in L97 are mostly connected with the first category, while mathematics in everyday life is connected with the last category. The second category deals with methods of work, like projects, group work, etc. This is an important distinction, and it is necessary to gain an understanding of the role of mathematics in everyday life as one of the main areas.

14 Appendix 2: Questionnaire

Questionnaire

This questionnaire is an important part of my classroom studies, and it is meant to supplement the information I get from the classroom observations.

The questionnaire has two main parts. The questions on this page are posed to give me a quick overview of your teaching background. On the next pages, different kinds of questions are posed, and I want you to answer them as honestly as possible. Your answers and the observations I make in your classrooms will create a foundation for the interview we are going to have in the end of the period.

I wish that you put down your name here, in order to know who says what, which will be of importance for our further discussions. In all my forthcoming publications you will all be anonymous.

This questionnaire is a part of a larger project, where I hope to get at least some insight into your thoughts and strategies, and to bring further some of your good ideas and experiences. My aim is not in any way to evaluate you or your teaching, but simply to collect ideas and suggestions that you have gained throughout your years of teaching experience. I hope that other teachers will some day benefit from this and get ideas that can change their teaching to the better.

Name:

Describe your educational background, with a main focus on mathematics.

.....
.....
.....
.....

Give a short summary of your teaching practice (number of years, what levels and courses you have been teaching, etc.).

.....
.....
.....
.....

Mark what fits you best.

1. I emphasise the connection between mathematics and the pupils' everyday life.

Very often	Often	Sometimes	Seldom	Very seldom

2. I use projects when I teach mathematics.

Very often	Often	Sometimes	Seldom	Very seldom

3. The pupils are actively involved in the formulation of problems from their own everyday life.

Very often	Often	Sometimes	Seldom	Very seldom

4. I use other sources than the textbook.

Very often	Often	Sometimes	Seldom	Very seldom

5. The pupils solve many textbook tasks.

Very often	Often	Sometimes	Seldom	Very seldom

6. The pupils work in groups.

Very often	Often	Sometimes	Seldom	Very seldom

7. First I teach theory, then the pupils practise solving tasks.

Very often	Often	Sometimes	Seldom	Very seldom

8. The pupils are actively involved in the (re-)construction of the mathematical theories.

Very often	Often	Sometimes	Seldom	Very seldom

9. The pupils find the mathematics they learn in school useful.

Very often	Often	Sometimes	Seldom	Very seldom

10. The pupils work with problems that help them understand mathematics.

Very often	Often	Sometimes	Seldom	Very seldom

11. The pupils work with open tasks.

Very often	Often	Sometimes	Seldom	Very seldom

12. Situations from the media are often used as a background for problems the pupils work with.

Very often	Often	Sometimes	Seldom	Very seldom

Comment on the following four statements:

1.

“When mathematics is used to solve problems from real life, the pupils must participate in the entire process – the initial problem, the mathematical formulation of it, the solving of the mathematical formulation, and the interpretation of the answer in the practical situation.”

.....
.....
.....

2.

“When it can be done, the teacher must connect teaching of mathematics with the other teaching (subjects).”

.....
.....
.....

3.

“The children should learn to solve the kind of problems (tasks) that they normally encounter in life (outside of school), confidently, quickly and in a practical way, and present the solution in writing, using a correct and proper set up.”

.....
.....
.....

4.

“The content of tasks should – especially for beginners (younger pupils) – first and foremost be from areas that the children have a natural interest for in their lives and outside of the home environment. Later, the subject matter must also be from areas that the pupils know from reading books and magazines, or that they in other ways have collected the necessary knowledge about.”

.....
.....
.....

List three issues that you find important to focus on for a teacher of mathematics, when the aim is for the pupils to learn to understand mathematics:

1.
2.
3.

List three possible strategies to make mathematics more meaningful and exciting for the pupils:

1.
2.
3.

List three issues that you find important in order to succeed as a mathematics teacher:

1.
2.
3.

15 Appendix 3: Illustration index

Illustration 1 Many concepts are involved in the discussion	10
Illustration 2 Breiteig et al. (1998a)	105
Illustration 3 Pythagoras on a lake, from Breiteig et al., 1998b, p. 84.	106
Illustration 4 This is the table Kari is going to make.	111
Illustration 5 The image of these table mats is from Oldervoll et al., 2000a, p. 143.	111
Illustration 6 This is a table or a sandbox	112
Illustration 7 Crooked frame	112
Illustration 8 The research cycle	122
Illustration 9 Convergence of multiple sources of evidence (cf. Yin, 1994, p. 93).	132
Illustration 10 Emphasise real-life connections	145
Illustration 11 Projects	145
Illustration 12 Group work, all schools	146
Illustration 13 Group work, schools 1, 3 and 4	146
Illustration 14 Pupils formulate problems	146
Illustration 15 Solving many textbook tasks	147
Illustration 16 First lecture, then solve textbook tasks	147
Illustration 17 Re-invention	148
Illustration 18 Situations from the media	148
Illustration 19 Open tasks	149
Illustration 20 Pupils find mathematics useful	149
Illustration 21 Problems help pupils understand mathematics	150
Illustration 22 This figure was used in the activity of re-inventing Pythagoras' theorem	177
Illustration 23 This illustration is from the Norwegian science magazine 'Illustrert Vitenskap'	178
Illustration 24 L97 - main sources of influence	225
Illustration 25 Real-life connections, beliefs and practice	238
Illustration 26 Practice theories - content and influence	244
Illustration 27 Influences on teaching practice	251

16 Appendix 4: Table index

Table 1 Main areas in L97	3
Table 2 Levels of real-life connections	69
Table 3 Realistic problems in textbooks	114
Table 4 Audio recordings	126
Table 5 Levels of analysis	136
Table 6 From Harry's profile table	140
Table 7 Frequency table, other sources	148
Table 8 Understanding mathematics	153
Table 9 Making mathematics more meaningful	153
Table 10 To succeed as a mathematics teacher	154
Table 11 Frequency table of questionnaire results	155
Table 12 The teachers' replies	156
Table 13 Group of extremes	156