



# **MCJROTC AWARDS & RHS MCJROTC AWARDS**

MCJROTC Awards  
& RHS MCJROTC  
Program Specific Awards  
(2017)



# Learning Objectives



- Awards Criteria
  - Understanding of **Criteria**
  - Not ALL awards will be given. **Strict Criteria!**
  - ***YOU WILL EARN WHAT YOU GET! Unlike the past years.***
- Understanding Award Authority
  - SMI Nomination / Selection
  - Award Association / Process / Monetary Requirement
- Understanding Award Precedence
- Understanding Award Devices
- Understanding RHS specific awards



# Award Evaluation



Study Guide is on School Wire

- **PARTICIPATION AND EXCELLENCE IN THIS PROGRAM!**
  - Awards are meant recognize Participation and Excellence
  - Also to improve morale and incentivize greater level of effort/achievement
  - Other benefits that we will discuss later in this presentation
- **Maintaining YOUR Award Display (I will show you later)**
  - Issuing of Cardboard Layout
  - Future issuing of Ribbon Bar Holders, Ribbons, Badges



# MCJROTC Uniforms



- What are the 4 types of USMC Uniforms?  
(Dress, Service, Combat Utility, Physical Fitness)

## DRESS BLUES DISTINCTIONS:

- Dress Blue “Alphas”
    - Blue Trousers, Medals & Ribbons,
    - No shooting badges
  - Dress Blue “Bravos”
    - Trousers, Ribbons & Badges Only
  - Dress Blue “Charlies”
    - LS Khaki/Tie, Ribbons & Badges
  - Dress Blue “Delta”
    - SS Khaki, Ribbons & Badges
- Who can wear Blues here at RHS?
    - Color Guard Teams
    - Designated Cadets (BY SMI)

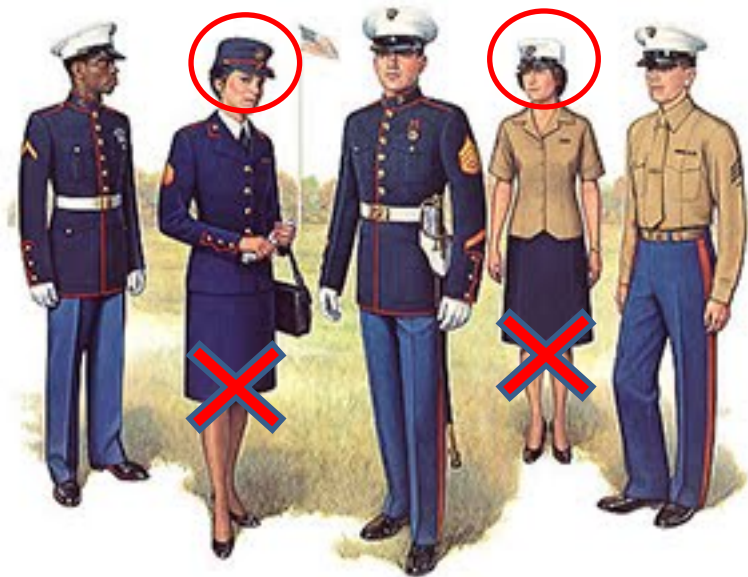

**-No more Alphas  
-No more “Service” Uniforms  
-No Blood Stripe**



# MCJROTC UNIFORM WEAR OCCASIONS



- Dress Blue “Alphas”
  - Blue Trousers, Medals & Ribbons, no shooting badges
  - **Parades, Ceremonies, Formal/Semi-Formal social gatherings**
- Dress Blue “Bravos”
  - Trousers, Ribbons & Badges Only
  - **Parades, Ceremonies, Formal/Semi-Formal social gatherings, leave & liberty**
- Dress Blue “Charlies”
  - LS Khaki/Tie, Ribbons & Badges
  - **Parades, Ceremonies, Designated Uniform of the Day**
- Dress Blue “Delta”
  - SS Khaki, Ribbons & Badges
  - **Parades, Ceremonies, Designated Uniform of the Day**

## AWARDS (Medals & Ribbons) in Precedence Order



### Legion of Valor Bronze Cross Achievement (SMI Nomination)

- A. Have an MCJROTC class standing in the top 25 percent of their class to be considered.
- B. Have a school academic class standing in the top 25 percent of their class to be considered.
- C. Have demonstrated exemplary military leadership.
- D. Have demonstrated academic leadership (demonstrated qualities of leadership in scholastic activities, student organizations, community activities, and interscholastic athletic participation).
- E. Nominees must be enrolled in MCJROTC their senior year in order to be eligible for this award.



### Marine Corps Reserve Association Outstanding Unit (SMI Nomination)

Authorized for those cadets whose unit received recognition by placing first in competition for the outstanding MCJROTC **UNIT**



### American Legion Award for Scholastic Excellence (SMI Nomination)

For the **Scholastic** Excellence Award, the cadet must:

- A. Have an academic average earned on all courses other than MCJROTC in the **upper 10 percent of the class**.
- B. Have grades in all MCJROTC subjects within the top 25 percent of that unit.
- C. Have demonstrated qualities of leadership.



### American Legion Bronze Medal for Military Excellence (SMI Nomination)

- A. Be in the **upper 25 percent of the class in academic standing**, including all MCJROTC subjects.
- B. Have demonstrated outstanding qualities in military leadership, discipline, character, and citizenship.



## Sons of the American Revolution Bronze Medal (SMI Nomination)

Awarded to a **junior cadet** who has exhibited the highest standards of leadership, soldierly bearing, and excellence.



## Daughters of the American Revolution Bronze Medal (SMI Nomination)

The **graduating** cadet must:

- A. Be in the upper 25 percent of the graduating class in all subjects, including MCJROTC.
- B. Have demonstrated qualities of dependability and good character, adherence to military discipline, leadership ability, and a fundamental and patriotic understanding of the importance of JROTC training.



## Military Order of the World Wars Medal (SMI Nomination)

This award is to be presented to an outstanding **first year cadet**. The cadet must:

- A. Excel in **both military and scholastic** activities during the year.
- B. Be in good standing in all military and scholastic courses at the time of selection and presentation of the medal.
- C. Have indicated, by grades, extracurricular activities, individual endeavor, and a desire to serve the United States.
- D. Have committed to continue in the MCJROTC program for the next school year.



## Military Officers Association of America Medal (SMI & PRINCIPAL)

Presented to a cadet **for outstanding academic achievement**. The cadet must:

- A. Be in top 10 percent of the class.
- B. Have an "A" average in MCJROTC subjects
- C. Hold an officers billet in the unit.
- D. Be in the junior year of high school.



## Veterans of Foreign Wars Bronze Medal (SMI Nomination)

Presented to a cadet for outstanding academic achievement. The cadet must:

- A. Be in top 10 percent of the class.
- B. Have an **“A” average in MCJROTC** subjects
- C. Hold an officers billet in the unit.
- D. Be in the **junior** year of high school.



## Daedalian Achievement Award (SMI Nomination)

Presented to a **junior** cadet who has demonstrated an understanding and appreciation of patriotism, love of country and service to the nation. Shows a **desire and potential to pursue a military career**, ranked in **upper 10 percent of the MCJROTC junior class, and a 20 percent of the school’s junior class.**



## Women Marines Association Award for Outstanding Cadet (SMI Nomination)

Present annually to the outstanding cadet in the unit who:

- A. Is participating **in at least the second year of MCJROTC.**
- B. Has satisfactory record of academic accomplishment.
- C. **Has the highest leadership education grades in the MCJROTC unit.**



## Noncommissioned Officers Association (SMI Nomination)

Awarded annually to the **most outstanding cadet NCO in the unit** during the past school year. No minimum time in program is specified. However, the award must be made to the **cadet NCO/SNCO who has consistently exhibited the best military bearing, personal appearance, deportment and leadership ability.**





## Military Oder of the Purple Heart Medal (SMI Nomination)

The award is awarded to a deserving cadet who combines **both military and scholastic excellence** with strong leadership skills.



## Navy League Youth Medal (SMI Nomination)

This award is presented to an outstanding cadet in recognition of **his/her professionalism and academic excellence and dedication to the MCJROTC program.**



## Reserve Officers Association Medal (SMI Nomination)

The award is presented to a deserving cadet who has **demonstrated outstanding competence in military skills and has contributed to the common good of the school, community, and nation.**



## Naval Reserve Association Medal (SMI Nomination)

The award is presented to a cadet in recognition of **his/her outstanding service and dedication to the MCJROTC program, academic excellence and desire to serve the school, community, and nation.**



## American Veterans (AMVETS) Medal (SMI Nomination)

The award is presented to a cadet for **diligence in the discharge of duties and the willingness to serve school, community and nation.**



## National Sojourners Award (SMI Nomination)

Presented annually to an enrolled cadet, a sophomore or junior, not previously a recipient who:

- A. Is enrolled for the next year.
- B. Is in the top 25 percent.
- C. Has encouraged and demonstrated the ideals of Americanism.



## Scottish Rite Medal (SMI Nomination) (Last Medal)

The award is presented to a cadet who has encouraged and demonstrated Americanism by deeds of conduct through participation in extra-curricular activities or unit sponsored community projects and has demonstrated exceptional dependability, character, self-discipline, citizenship and patriotism.



## Outstanding Cadet Award (SMI & PRINCIPAL) (Rest are Ribbons)

- A. Consistent superior performance in all facets of the Leadership Education Course.
- B. Academic achievement in the top 25 percent of the class in all academic subjects including MCJROTC.
- C. Exceptional qualities of leadership, discipline, character.



The bronze, silver and gold Marine Corps emblem device will be used to denote second, third and fourth awards respectively.



## Student Leadership Award (SMI Nomination)

Presented to cadets who hold elected office in the student body of the school.



The bronze, silver and gold Lamp of Learning will be used to denote second, third and fourth awards respectively.



## Officer Leadership Award (SMI Nomination)

Presented annually to that cadet officer who has demonstrated **exceptional** leadership qualities, discipline, character, military bearing, and military proficiency.

 The bronze, silver and gold Marine Corps emblem device will be used to denote second, third and fourth awards respectively.



## Noncommissioned Officer Leadership Award (SMI Nomination)

Presented annually to that cadet noncommissioned officer who has demonstrated **exceptional** leadership qualities, discipline, character, military bearing, and military proficiency.

 The bronze, silver and gold Marine Corps emblem device will be used to denote second, third and fourth awards respectively.



## Civic Service Award (SMI Nomination)

This award may be used to recognize outstanding community service or noteworthy unit participation preformed by a cadet. **WHAT IS THE MINIMUM AMOUNT OF ACCUMULATED HOURS NEEDED? (12 Hrs)**

 The bronze, silver and gold Marine Corps emblem device will be used to denote second, third and fourth awards respectively.



## Best Drill Cadet Award (SMI Nomination)

Presented to cadets(s) who demonstrate superior performance in comparison with other cadets in the following categories:

A. Manual of arms in position. B. Manual of arms while marching. C. Military Bearing and appearance.

 The bronze, silver and gold Marine Corps emblem device will be used to denote second, third and fourth awards respectively.



## Distinguished Scholastic Achievement Award (SMI Nomination)

Awarded annually to the cadet(s) who maintain an “A” average in academic subjects to include MCJROTC Leadership Education, and/or be in the 10% of the class.



The bronze, silver and gold Lamp of Learning will be used to denote second, third and fourth awards respectively.



## Arts and Academics Award (SMI Nomination)

Presented to any cadet who participates in Interscholastic competition pertaining to academic or the arts.



The bronze, silver and gold Lamp of Learning will be used to denote second, third and fourth awards respectively.



## Distinguished Military Training Award (SMI Nomination)

Presented annually to a cadet who demonstrates outstanding proficiency and achievement in all facets of the MCJROTC program



The bronze, silver and gold Marine Corps emblem device will be used to denote second, third and fourth awards respectively.



## Physical Achievement Award (SMI Nomination)

Awarded to any cadet who scores 250 or more points on the National Youth Physical Fitness Program test sponsored by the Marine Corps. League.



The bronze, silver and gold Marine Corps emblem device will be used to denote second, third and fourth awards respectively.



## Superior Marksman Award (SMI Nomination)

Presented annually to cadets who qualify as a superior marksman, either **by placing in regional or national air rifle matches, or by achieving a score of 270 or better during the MCJROTC Postal Match**

 The bronze, silver and gold Marine Corps emblem device will be used to denote second, third and fourth awards respectively.



## Athletic Participation Award (SMI Nomination)

Presented to cadets who participate in interscholastic athletics

 The bronze, silver and gold Lamp of Learning will be used to denote second, third and fourth awards respectively.



## Longevity / Fidelity Award (SMI Nomination)

Presented to those **cadets who have successfully participated in the MCJROTC Program for two years and have met all the requirements of Leadership Education I and Leadership Education II.** In the event a senior student is enrolled in LE II, the award may be made at the commencement of the cadets final semester in the program

 The bronze Marine Corps emblem will be attached to the ribbon on initial presentation. The silver and gold Marine Corps emblem will be used to denote third and fourth year participation in the MCJROTC program respectively.



## Distinguished Conduct Award (SMI Nomination)

Presented to any cadet whose **conduct and demeanor are worthy of special recognition.** Individual shall not have received any demerits or adverse conduct reports from any staff or faculty member for the entire year.

 The bronze, silver and gold Marine Corps emblem device will be used to denote second, third and fourth awards respectively.



## Best Drill **Squad** Award (SMI Nomination)

Presented annually to those cadets comprising the best drill squad. **The best drill squad is determined, through competition with other drill squads in a unit,** to be superior in the following categories:

A. Manual of arms in position. Manual of arms while marching. Military Bearing and appearance.



The bronze, silver and gold Marine Corps emblem device will be used to denote second, third and fourth awards respectively.



## Color Guard Award (SMI Nomination)

Award to those **cadets who distinguished themselves** as members of the unit's color guard.



The bronze, silver and gold Marine Corps emblem device will be used to denote second, third and fourth awards respectively.



## Drill Team Award (SMI Nomination)

Presented annually to those cadets who comprise the unit drill team in the drill team competition.



The bronze, silver and gold bar device lettered "DRILL TEAM" will be used to denote second, third and fourth awards respectively.



## Band Drum and Bugle Corps Award (SMI Nomination)

Presented to those cadets who distinguish themselves in the school's band/drum and bugle corps



The bronze, silver and gold bar device lettered "BAND" will be used to denote second, third and fourth awards respectively.



## Rifle Team Award (SMI Nomination)

Presented to those cadets who **distinguish themselves on the units rifle team(s)**



The bronze, silver and gold bar device lettered "RIFLE TEAM" will be used to denote second, third and fourth awards respectively.



## Orienteering Team Award (SMI Nomination)

Presented to those cadets who distinguish themselves on the unit's orienteering team(s)



The bronze, silver and gold Marine Corps emblem device will be used to denote second, third and fourth awards respectively.



## Recruiting Award (SMI Nomination)

Presented to those cadets who have contributed to the growth of the unit by taking an active role in recruiting cadets into the MCJROTC program



The bronze, silver and gold Marine Corps emblem device will be used to denote second, third and fourth awards respectively.

## MARKSMANSHIP SHOOTING BADGES



MARKSMAN



SHARPSHOOTER



EXPERT



## RHS MCJROTC AWARDS



- Common Theme with majority of all award criteria?
  - Scholastic Excellence
  - Participation & Effort
  - Performance
- Subjectivity with Nominations by SMI





# RHS MCJROTC AWARDS



- Multiple Awards Criteria? Example:
  - Recruiting Ribbon: The more cadets you bring into the program will earn you multiple awards. It may also earn you additional awards.
  - For Majority of ALL awards – what is the first criteria?
- ~~How to handle current Cadets' awards *WITHOUT* any existing documentation?~~
  - ~~STOLEN VALOR?~~
  - ~~“Grandfather” Letter~~
  - ~~MARINES take awards EXTREMELY SERIOUSLY!~~
- Future awards documentation procedures (Unlike past years)
  - Just like Promotions, Community Service, etc...
  - Everything will be documented, every award will have documentation AND be presented in the proper manner
    - Awards Formation



# RHS MCJROTC AWARDS



**WHO IS ULTIMATELY RESPONSIBLE FOR  
MAINTAINING YOUR SERVICE RECORDS?**

**YOU!**

# RHS "R" LETTER



*Example Pins*



# RHS “R” Criteria

## You can earn an “Letter” for participating in the following:

\*NO LE Level Requirement

\*TRY OUTS will begin SY 17/18. **Attendance & Participation** will be one of the key factors in earning a Letter or Pins.

- Air Rifle – Competition participation (MTF from Air Rifle Coach)\*
- Color Guard – As part of Primary Team, or if selected for/completion of 8 Color Guard Events, or if part of primary teams during a Competition\*
- Cyber Patriot – As part of Primary Team and Competitions\*
- Robotics – As part of Primary Team and Competitions\*
- JLAB – As part of Primary Team and Competitions\*
- YPFT Team – As part of Primary team and Competitions\*

*\*MTF on criteria*

## You can earn PINS for participating in the following:

- **After** you have earned your “Letter”
- Pins for Air Rifle, Color Guard
  - Future: Cyber, Robotics, JLAB, YPFT



# RHS MCJROTC LETTERMAN, PINS



- SY 16/17 Romeoville "R" Letter
  - Air Rifle
  - Color Guard
- NO Try Outs conducted this year
  - Competitions Only
- ONE Letter

- SY 17/18 Romeoville "R" Letter
  - Air Rifle
  - Color Guard
  - Cyber Patriot
  - Robotics
  - JLAB
  - PFT
- Try Outs (Future)
  - ONE Letter Earned for being on Varsity / Primary Teams
- PINS & PATCHES
  - Earned for participation on multiple teams and years.

RHS LETTERMAN JACKET = **\$250.00**

Alternative Display?

-RHS Banner = \$30.00





# ANNOUNCEMENTS!

Achievements for years to come -  
Memory Products by Neff!



Memory Frames  
Starting at  
**\$64.95**



Memory Blankets  
Starting at  
**\$60.50**



Memory Banners  
Starting at  
**\$29.95**



selection of memory products...  
1.800.232.6333 or contact your local Neff Rep!



# OTHER RHS MCJROTC AWARDS



## **4-Year Plaque:**

- Must complete all four years of the program
- Must be eligible for graduation
- Must not have pending disciplinary actions
- Must be in good standing with RHS school and MCJROTC program
  - Academically, Financially

## **Scarlet & Gold Cord:**

- For graduating seniors
- Wear on Cap & Gown



# Medals, Ribbons & Badge Placement



- Medals. Authorized medals will be worn on the blue coat when prescribed in the training schedule. They will be worn over the left breast pocket, midway between the first and second buttons. When wearing medals, ribbons for which there are no medals will be worn 1/8" above and centered over the right breast pocket. (Marksmanship badges will not be worn when medals are worn.)
- Ribbons. When worn, ribbons will be worn 1/8" above and centered over the left breast pocket of the khaki shirt or blue coat. When worn with the marksmanship badge, ribbons will be 1/8" above the badge.
- Marksmanship Badge. Cadets are authorized to wear one marksmanship badge representing the classification earned during their **most recent** range qualification. The marksmanship badge will be worn 1/8" above and centered on the left breast pocket. Marksmanship badges will not be worn with medals on the blue coat.



# PROPER PLACEMENT OF CADET RANK INSIGNIA, AWARDS

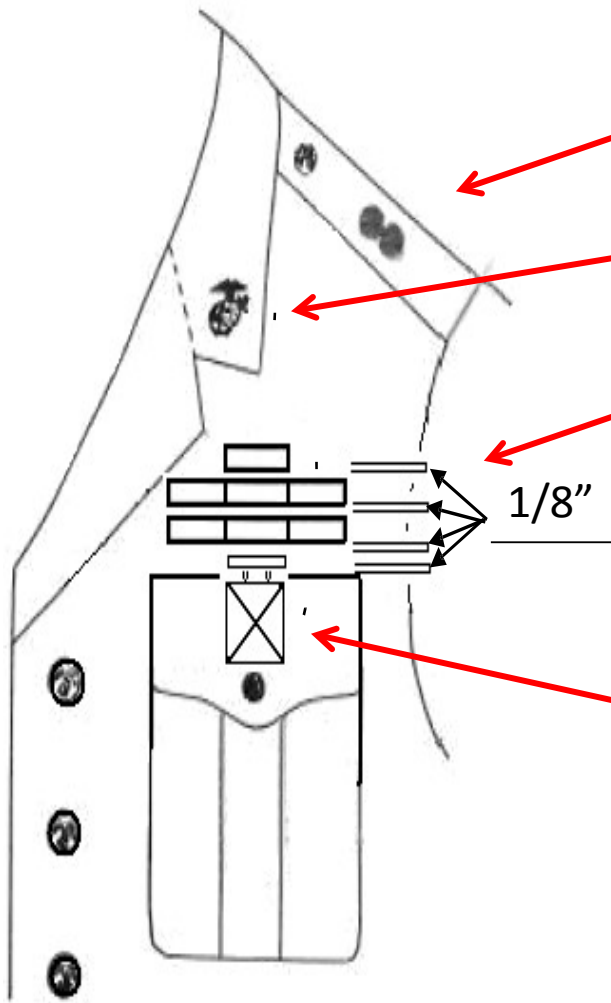

**Officer ranks** = centered on the epaulet

**Enlisted ranks** =  $\frac{3}{4}$ " from outside edge & centered

**EGA** anchors face inboard.

**Precedence of Ribbons**

-Top row = personal awards

-Middle row = service awards

-Bottom row = service/foreign decorations

-No more than  $\frac{1}{3}$  of ribbon may be covered by collar of blouse

**Shooting Badges**

- $\frac{1}{8}$ " above pocket seam

-Top of two badges level

-No more than 3 badges



# Medals, Ribbons & Badge Placement





# Medals, Ribbons & Badge Placement



***NO MORE WHITE TROUSERS***





# Medals, Ribbons & Badge Placement



LEADING  
FROM THE  
FRONT

WHAT IS WRONG WITH THIS?





# TAKE AWAYS



- YOU WILL EARN WHAT YOU GET
  - (Understanding Criteria Requirements / Process)
- NO MORE, “handing out” awards like candy with NO documentation!
- MCJROTC program is NOT about how many medals & ribbons you can get.
- BENEFITS OF AWARDS:
  - Recognition for Excellence, Hard Work, Participation, Team & Individual performance
  - Resumes & Scholarships
- You should never ask if you are going to get an award. Leaders will take care of those that have earned/deserve them.
  - ***Do YOUR part in Academics, Leadership, Participation, Excellence***
  - ***YOU control your work ethic, participation, grades, improvement***



# PRACTICAL APP



- Issue Cardboard Layout
- Irish Pennants (IP's)
  - Toenail Clippers
- Glue for Devices
  - Type
  - Methods for attaching devices
- Practice putting Ribbons, Badges on Bars
  - 3 or 4 across?
  - Ribbon/Badge placement: 1/8", Centered
  - Specific Devices
  - Badges Centered?

# I LOVE ME BOARD



I AM CADET KNUCKLEHEAD



DOR  
BILLET



DOR  
BILLET



DOR  
BILLET



DOR  
BILLET

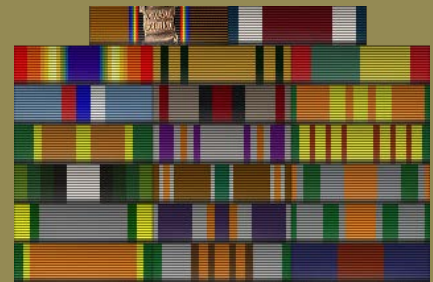

WHATEVER  
ELSE YOU  
WANT TO PUT  
ON YOUR  
BOARD!

NOT EVERYONE  
WILL BE ISSUED  
BLUES, THIS IS  
SOMETHING  
THAT YOU CAN  
DO TO DISPLAY  
YOUR JROTC  
CAREER  
PROGRESSION.





# GOING FORWARD



- Chain of Cmd and S1 will:
  - ~~Generate a Final Draft of CURRENT awards~~
    - ~~Previous Roster~~
  - SMI/MI will conduct FINAL Awards scrub for entry into SRB
    - ~~“Grandfather” Letter (SMI)~~
  - Once final, S1 will enter into SRBs
- **AFTER** THE ABOVE TASKS HAVE BEEN COMPLETE:
  - Issue Ribbon Bars, Ribbons, Badges
  - Lack of Inventory?

**-ISSUING OF AWARDS, HOW USMC DOES IT**

**-ISSUING OF EQUIPMENT**

**-PERFORMANCE MATTERS!**