

“McMillan is an options guru par excellence.”

—Yale Hirsch, *The Stock Trader's Almanac*



McMillan  
*on*  
Options  
SECOND EDITION

LAWRENCE G.  
McMILLAN

A MARKETPLACE BOOK

**McMillan  
on Options**

Founded in 1807, John Wiley & Sons is the oldest independent publishing company in the United States. With offices in North America, Europe, Australia, and Asia, Wiley is globally committed to developing and marketing print and electronic products and services for our customers' professional and personal knowledge and understanding.

The Wiley Trading series features books by traders who have survived the market's ever-changing temperament and have prospered—some by reinventing systems, others by getting back to basics. Whether a novice trader, a professional, or somewhere in-between, these books will provide the advice and strategies needed to prosper today and well into the future.

For a list of available titles, visit our Web site at [www.WileyFinance.com](http://www.WileyFinance.com).

**A MARKETPLACE BOOK**

**McMillan  
on Options**

**Second Edition**

**Lawrence G. McMillan**



**WILEY**

**John Wiley & Sons, Inc.**

Copyright © 2004 by Lawrence G. McMillan. All rights reserved.

Published by John Wiley & Sons, Inc., Hoboken, New Jersey.  
Published simultaneously in Canada.

No part of this publication may be reproduced, stored in a retrieval system, or transmitted in any form or by any means, electronic, mechanical, photocopying, recording, scanning, or otherwise, except as permitted under Section 107 or 108 of the 1976 United States Copyright Act, without either the prior written permission of the Publisher, or authorization through payment of the appropriate per-copy fee to the Copyright Clearance Center, Inc., 222 Rosewood Drive, Danvers, MA 01923, 978-750-8400, fax 978-646-8600, or on the web at [www.copyright.com](http://www.copyright.com). Requests to the Publisher for permission should be addressed to the Permissions Department, John Wiley & Sons, Inc., 111 River Street, Hoboken, NJ 07030, 201-748-6011, fax 201-748-6008.

**Limit of Liability/Disclaimer of Warranty:** While the publisher and author have used their best efforts in preparing this book, they make no representations or warranties with respect to the accuracy or completeness of the contents of this book and specifically disclaim any implied warranties of merchantability or fitness for a particular purpose. No warranty may be created or extended by sales representatives or written sales materials. The advice and strategies contained herein may not be suitable for your situation. You should consult with a professional where appropriate. Neither the publisher nor author shall be liable for any loss of profit or any other commercial damages, including but not limited to special, incidental, consequential, or other damages.

For general information on our other products and services, or technical support, please contact our Customer Care Department within the United States at 800-762-2974, outside the United States at 317-572-3993 or fax 317-572-4002.

Wiley also publishes its books in a variety of electronic formats. Some content that appears in print may not be available in electronic books.

For more information about Wiley products, visit our web site at [www.wiley.com](http://www.wiley.com).

ISBN 0-471-67875-9

Printed in the United States of America.

10 9 8 7 6 5 4 3 2 1

# Preface

When people learn that I have written another book, they usually ask one of two questions: “Is this an update of your other book?” or “What’s the difference between this one and your other one?” First of all, this is most assuredly *not* an update of *Options as a Strategic Investment* (OSI). This is a completely different, stand-alone book that relates option trading in actual examples. Second, there is a substantial difference between this book and OSI. This book is not intended to be a comprehensive definition of strategies—that is better derived from OSI, which is a reference work. This is a book in which the application of options to actual trading situations is discussed. There are plenty of actual trading examples, many of them derived from my own trading experience. In addition, there are a number of stories—some humorous, some more on the tragic side—that illustrate the rewards and pitfalls of trading, especially trading options. In addition, the *content* of this book covers ground that one does not normally find in books on options; that content will be discussed shortly.

There is a continuous discussion of futures trading, as well as stock and index trading, herein. The futures markets offer many interesting situations for option trading and strategies. To that end, the basic definitions of futures options—and how they compare to, and differ from, stock options—are included in Chapter 1.

While the book is not really meant for beginners, it contains all the necessary definitions. Thus, serious traders will have no trouble at all in getting up to speed. In fact, many of the techniques described in this book do not require familiarity with option strategies at all. The more elementary option strategy definitions are not expanded upon

at great length here, however, as my objective is to describe practical applications. For example, it is not my intention to detail the explicit calculations of break-even points and explain follow-up actions for these basic strategies. Readers who feel a need to better understand the basics should refer to the aforementioned work, OSI, which describes virtually all conceivable strategies in a rather large amount of detail.

As for content, the book is basically divided into five major sections, spread out over seven rather lengthy chapters. The first part—Chapters 1 and 2—lays out the basic definitions and reviews option strategies, so that the framework is in place to understand and utilize the material in succeeding chapters. Even seasoned option professionals should enjoy reading these introductory chapters, for the trading tales that accompany many of the strategies are sure to elicit some nodding of heads. Graphs and charts are liberally used. Since things are more easily seen in graphs than in tables, over 120 such graphs and charts are included in this book.

The next three chapters—3 through 5—are intensive discussions of some very important trading tactics, based on options. However, they are more of a basic nature and don't require a theoretical approach to option trading. In fact, a stock or futures trader should be able to absorb this information rather quickly, even if he doesn't have a clue as to what the delta of an option is. Don't get me wrong—I encourage every option trader to use a model via a computer program in order to evaluate an option before he actually buys or sells it. However, these chapters don't require anything more theoretical than that.

Chapter 3 contains material that is extremely important to all traders—particularly stock traders, although futures traders will certainly benefit as well. I like to think of the information in this chapter as demonstrating how versatile options can be—they don't have to be merely a speculative vehicle. A basic understanding of the concepts involving using options to construct positions that are equivalent to owning stock or futures contracts is shown to be necessary for many applications. For example, it allows a futures trader to extract himself from a position, even though the futures may be locked limit against him.

Later in the same chapter, there is an extremely detailed discussion of how the expiration of options and futures affect the stock market. Several trading systems are laid out that have good track records, and that can be used month after month. Finally, the use of options or futures to protect a portfolio of stocks is also discussed in some detail. If we ever go into another bear market, these strategies will certainly become very popular.

Chapter 4 is my favorite—“The Predictive Power of Options.” Since options offer leverage, they are a popular trading vehicle for all manner of speculators. By observing both option prices and option volume, you can draw many important conclusions regarding the forthcoming direction of stocks and futures. A large part of the chapter describes how to use option volume to buy stock (or sometimes sell it) in advance of major corporate news items, such as takeovers or earnings surprises. However, another lengthy discussion involves the put-call ratio—a contrary indicator—as it applies to a wide variety of indices and futures. The work on futures’ put-call ratios is, I believe, unique in the annals of technical analysis in that the techniques are applied to and rated on a vast array of futures markets.

Several trading systems—from day-trading to seasonal patterns—with profitable track records are described in Chapter 5. Many traders, even those who are technically inclined, often overlook the power of seasonality. Moreover, the use of options in intermarket spreads is explained. Options give intermarket spreaders an additional chance to make money, if applied in the ways shown.

For those with a theoretical bent, Chapter 6 may be your favorite. The use of neutral option strategies is discussed, especially with respect to predicting and trading volatility. One of my pet peeves is that the term “neutral” is thrown around with such ease and, as a result, is often applied to positions that have considerable risk. The intent of Chapter 6 is to not only set the record straight, but to demonstrate that—while neutral trading can certainly be profitable—it is not the easy-money, no-work technique that some proponents seem to be extolling. I am often asked how I base my decisions on taking a position, rolling, and so forth, so the backspread example in Chapter 6 is intended to be almost a diary of what I was thinking and how I traded the position over the course of six months.



The book winds up with a discussion of money management, trading philosophy, and some trading guidelines—all in Chapter 7. Some of my favorite trading stories and sayings are related in this chapter. I hope you enjoy them as well.

My hope is that this book will bring more traders into the option markets, as they realize that options can be used in many ways. Options don't merely have to be treated as a speculative vehicle. In fact, you might be strictly a stock or futures trader but find that options can give you valuable buy and sell signals. Those with a more theoretical bent will find that volatility trading can be lucrative as well.

## **SECOND EDITION**

After seven years, I felt a second edition was necessary because there had been sufficient changes in the derivatives industry to justify a rewrite with deletions and additions. For example, Chapter 1, which is mostly definitions, now includes Exchange Traded Funds, Electronic Trading, Single Stock Futures, and Volatility Futures. The main purpose of the second edition is to weed out material that no longer is viable—either because products had become delisted or illiquid or because strategies had become exploited—and to include new tactics and strategies that I apply in my own trading and analysis.

Chapter 3, which discusses various option special applications, now includes a discussion describing how a stock can be “pinned” to a striking price at expiration—what causes it, why it happens, and when to expect it. Furthermore, as options have become more popular as a hedging vehicle for stock owners—particularly professional stock owners—new strategies have developed. They are included in this new edition. One is the use of the newly listed volatility futures, and another is an expanded use of the “collar” strategy with listed options. New examples are included to describe both applications.

In the revised Chapter 4, one major addition is the inclusion of put-call ratio charts and theory on individual stocks. In the first edition, I had felt that there was too much insider trading in stock options and that such activity would distort the usefulness of put-call ratios on individual stocks. But, as time passed, I came to feel that large, well-capitalized stocks were less susceptible to manipulation

and insider trading and that their put–call ratios could indeed provide another good sentiment-based indicator for traders. Another major aspect of put–call ratios included in this edition is *weighted* put–call ratios. This method, which incorporates the *price* of the option as well as its trading volume, is a highly effective improvement on the basic theory of using put–call ratios as indicators. On another related topic—using the volatility indices as a market predictor—we have done a good deal of research over the years, and much of that is now included in Chapter 4. This research not only includes the analysis of peaks and valleys in the VIX chart itself, but also shows how the comparison of implied and historical volatilities is an important indicator.

Chapter 5 still covers trading systems and strategies. One major change that has taken place in the markets in recent years is the loss of effectiveness of the New York Stock Exchange (NYSE) advance–decline figures. This is due to decimalization for the most part. As a result, we have adapted another method of looking at breadth—the “stocks only” approach. This adaptation is applied to some of our systems, and the improvement is significant. The section on intermarket spreads has been updated as well. For some spreads, this is nothing more than bringing charts up to date. But for others—notably, the January effect spreads—significant changes in the *pattern* of the spread have taken place; and, thus, changes in strategy for trading the spread are necessary as well. This also includes the way that intermarket spreads are implemented. There is less reliance on futures and more reliance on Exchange Traded Funds (ETFs), which are much more popular now than they were when the first edition was published. Finally, the seasonal trading systems are updated, and one more has been added—the late-January seasonal buy point. The systems presented in this chapter remain some of my favorite speculative trading vehicles; and with this new, up-to-date information, they should prove to be useful for all readers.

A more advanced approach to option trading is once again presented in Chapter 6. A significant amount of new information is included, most in the area of statistics and probability, that is, applying statistics to trading decisions. The concept of *expected return* is explained and illustrated, as is the concept of the Monte Carlo probability simulation. These concepts and tools allow the theoretically based trader to be more disciplined in his approach to the markets.

He can concentrate on situations where options are mispriced (volatility skews, for example), solid in the knowledge that a consistent investment in positions with above-average expected returns should eventually produce above-average results.

Much of the data and tools necessary for the modern option trader can be found on the Internet, and there is some discussion of where to find data and tools in Chapter 7. I would, of course, be pleased to see readers visit our web site, [www.optionstrategist.com](http://www.optionstrategist.com), where a great deal of free information is presented. We also have a subscriber area, The Strategy Zone, on that web site, where more in-depth reports and data are available, along with a daily market commentary.

There is no doubt that options and other derivatives now hold a major place in the investment landscape, but it is disconcerting to see how many people still don't seem to understand options. In fact, they are quick to place blame on derivatives when things go wrong. Only by dissemination of the kind of information in this book can we hope to overcome such negative and uneducated attitudes. When we have another bear market, option traders will probably do very well—whether they use options as a protective device or as a speculative one. Some have even gone so far as to predict that angry investors, who do not understand derivatives, will attempt to blame that bear market and its concomitant losses on options and other derivatives. That would be ludicrous, of course, but if we can convince more and more people of the viability of option trading, then affixing any future blame will be a moot point.

I've been in this business so long now that there are literally hundreds of people I could thank for helping me get to this point. However, in the interest of space and time, I will limit my kudos to those who specifically helped with this book and with the concepts behind it: Shelley Kaufman, who did all the graphics work in this book and who is an invaluable confidant on all matters; Peter Bricken, who first came up with the idea of monitoring option volume as a precursor of corporate news events; Van Hemphill, Mike Gallagher, and Jeff Kaufman, who provided information on expiration activity that is nonpareil and who have helped me to clarify my thinking on strategies regarding expiration; Chris Myers, who convinced me to write this book; Peter Kopple, off whom I can constantly bounce ideas;

and Art Kaufman, who convinced me that I could go into business for myself. Finally, a special thanks to my wife, Janet, who puts up with my crazy hours, and to my children, Karen and Glenn.

LAWRENCE G. McMILLAN

*Randolph, New Jersey*  
*August 2004*



# Contents

## List of Figures

xix

<b>1</b>	<b>Option History, Definitions, and Terms</b>	<b>1</b>
	Underlying Instruments	1
	Option Terms	3
	The Cost of an Option	4
	The History of Listed Options	6
	<i>The Over-the-Counter Market</i>	6
	<i>The CBOE Beginning</i>	7
	<i>Index Options</i>	9
	<i>Exchange-Traded Funds</i>	10
	<i>Futures Options</i>	10
	<i>Today's Over-the-Counter Market</i>	11
	Option Trading Procedures	12
	Electronic Trading	14
	Exercise and Assignment	15
	<i>Mechanics of Exercise and Assignment</i>	19
	Futures and Futures Options	24
	<i>First Notice Day</i>	25
	<i>Single Stock Futures</i>	26
	<i>Volatility Indices and Futures</i>	27
	<i>Futures Options Terms</i>	28
	Influences on an Option's Price	32
	<i>Volatility</i>	33
	<i>How the Factors Affect the Option Price</i>	36
	Delta	37

*What Affects Delta?* 39  
Technical Analysis 42

**2 An Overview of Option Strategies**

**45**

Profit Graphs 45  
Outright Option Buying 47  
Using Long Options to Protect Stock 52  
    *Buying Puts as an Insurance Policy for Long Stock* 52  
    *Buying Calls to Protect Short Stock* 55  
Buying Both a Put and a Call 57  
Selling Options 59  
    *Covered Call Writing* 60  
    *Naked Option Writing* 62  
    *Naked Put Writing* 64  
    *Naked Call Writing* 69  
    *Straddle and Combination Selling* 73  
Spreads 77  
    *Vertical Spreads* 77  
    *Calendar Spreads* 85  
    *Diagonal Spreads* 88  
    *When Spreads Are Attractive* 89  
Ratio Strategies 91  
    *Ratio Writing* 91  
    *Ratio Spreads* 92  
    *More Complex Constructions* 99  
    *Using an Option Model* 102  
Summary 103

**3 The Versatile Option**

**105**

Options as a Direct Substitute for the Underlying 105  
    *Equivalent Short Stock* 108  
    *Single Stock Futures* 111  
    *Defending against a Limit Move in Futures Contracts* 112  
Options as a Proxy for the Underlying 116  
    *Option Buying as a Short-Term Stock Substitute* 116  
    *Option Buying as a Long-Term Stock Substitute* 117  
    *Using LEAPS Puts instead of Calls* 118  
The Effect of Stock Index Futures on the Stock Market 119  
    *Index Arbitrage* 120  
    *Portfolio Insurance* 124

<i>Program Trading</i>	127	
The Effect of Index Futures and Index Option Expiration on the Stock Market	129	
<i>Games People Play</i>	132	
<i>Open Interest Implications</i>	135	
<i>A Hedged Strategy</i>	137	
<i>Speculation Early in Expiration Week</i>	143	
<i>Trading with the Arbs</i>	148	
<i>The Postexpiration Effect of Futures on         the Stock Market: A Trading System</i>	149	
<i>Expiration's Effect on Individual Stocks</i>	155	
Options as an Insurance Policy	157	
The Collar	168	
<i>Using LEAPS as Collars</i>	170	
Hedging with Over-the-Counter Options	174	
Using Volatility Futures as Portfolio Insurance	177	
<i>The Contract Details</i>	178	
<i>Strategies for Protecting a Portfolio of Stocks with         VX Futures</i>	180	
<i>What Can Go Wrong?</i>	183	
<i>Options on VX Futures</i>	184	
Summary	185	
<b>4 The Predictive Power of Options</b>		<b>187</b>
Using Stock Option Volume as an Indicator	187	
<i>How Much Is Too Much?</i>	188	
<i>The Analysis</i>	190	
<i>Analysis in Real Time</i>	200	
<i>Examples</i>	202	
<i>Profitability</i>	223	
<i>Further Considerations</i>	226	
<i>Using Stops</i>	229	
<i>When Option Volume Is Not a Good Predictor</i>	235	
Using Option Prices as an Indicator	237	
<i>Expensive Stock Options May Predict Corporate News</i>	238	
<i>Analyzing Implied Volatility for Speculative Trades</i>	241	
<i>Implied Volatility Can Predict Trading Gaps</i>	248	
<i>Some Strategies for Trading the Volatility Gap</i>	253	
Implied Volatility Can Predict a Change of Trend	256	
<i>Covered Call Writing When Volatility Increases</i>	258	



<i>Implied Volatility of Index Options</i>	262
<i>A Case Study: The 1994 and 1995 Markets</i>	268
<i>Another Case Study: 1997–1999</i>	272
<i>The Seasonality of Volatility</i>	277
<i>Trading Volatility Directly</i>	281
<i>Further Observations on Index Volatility</i>	282
The Put–Call Ratio	283
<i>The Data</i>	286
<i>Interpreting the Ratios</i>	289
<i>Sector Index Options Put–Call Ratios</i>	308
<i>Using Put–Call Ratios to Trade Individual Stocks</i>	312
<i>Futures Options Put–Call Ratios</i>	318
Futures Options Volume	340
<i>Put–Call Ratio Trading Summary</i>	341
On Moving Averages	341
Summary	350

**5 Trading Systems and Strategies**

**351**

Incorporating Futures Fair Value into Your Trading	351
Day-Trading Vehicles	353
The TICKI Day-Trading System	355
<i>The Intraday Market-Reversal Corollary</i>	363
A Short-Term Trading System	366
<i>Monitoring the Oscillator Intraday</i>	369
<i>Problems with the Advance–Decline Line</i>	374
Intermarket Spreads	378
<i>European Options</i>	381
<i>The HUG/HOG Spread</i>	389
<i>The January Effect</i>	399
<i>Gold Stocks versus the Price of Gold</i>	408
<i>Oil Stocks versus the Price of Oil</i>	414
<i>Utility Stocks and 30-Year T-Bonds</i>	419
<i>Similar-Sector Index versus Futures Intermarket Spreads</i>	422
<i>Pairs Trading</i>	424
Other Seasonal Tendencies	425
<i>August: The Dull Month—Or Is It?</i>	425
<i>September–October: A Very Tradeable Time Period</i>	
<i>for the Stock Market</i>	430
<i>Late-October Buy Point</i>	434
<i>Late-January Buy Point</i>	436
Summary	439

<b>6</b>	<b>Trading Volatility and Other Theoretical Approaches</b>	<b>441</b>
	Volatility	442
	Delta Neutral Trading	445
	<i>Keeping a Position Neutral</i>	450
	<i>Other Forms of Neutrality</i>	452
	Predicting Volatility	455
	Comparing Historical and Implied Volatility	457
	Trading Implied Volatility	461
	<i>Selling Volatility</i>	461
	<i>Buying Volatility</i>	471
	The “Greeks”	483
	<i>The Model</i>	484
	Delta	486
	Vega	491
	Theta	493
	Rho	493
	Gamma, Revisited	495
	Gamma and Delta Neutral	498
	<i>Even More Advanced Constructions</i>	514
	Summary	516
	Trading the Volatility Skew	516
	<i>Price Distributions</i>	521
	<i>Trading the Positive Skew</i>	525
	<i>Trading the Negative Skew</i>	530
	Put Ratio Spread	547
	<i>A Volatility Skew Biases a Position</i>	550
	<i>Finding Where Volatility Skewing Exists</i>	553
	The Aggressive Calendar Spread	555
	Using Probability and Statistics in Volatility Trading	558
	Expected Return	564
	Summary	567
<b>7</b>	<b>Other Important Considerations</b>	<b>569</b>
	Support Activities	569
	Order Entry	569
	Brokers and Brokerage	572
	Data Vendors	576
	Software	580
	Trading Methodology and Philosophy	584
	Managing Your Money	584
	Speculative Trading Procedures	592

xviii CONTENTS

<i>Actual Trading Examples</i>	597
Option Trading Philosophy	609
<i>The Biggest Mistake</i>	615
Summary	616
<b>Appendix A: Listed Index and Sector Options</b>	<b>617</b>
<b>Appendix B: Futures Options Terms and Expirations</b>	<b>621</b>
<b>Appendix C: Option Models</b>	<b>625</b>
<b>Index</b>	<b>631</b>

# List of Figures

<b>1.1</b>	Exercise and Assignment of Stock or Futures Options	20
<b>1.2</b>	Exercise and Assignment of Cash-Based Index Options	23
<b>2.1</b>	Call Purchase	46
<b>2.2</b>	Put Purchase	48
<b>2.3</b>	Long Stock/Long Put	53
<b>2.4</b>	Long Call/Short Stock	56
<b>2.5</b>	Straddle Purchase	58
<b>2.6</b>	Combination (Strangle) Purchase	59
<b>2.7</b>	Covered Call Write	61
<b>2.8</b>	Naked Put Write	65
<b>2.9</b>	Naked Call Write	71
<b>2.10</b>	Short Combination	74
<b>2.11</b>	Short Straddle	74
<b>2.12</b>	Bull Spread	78
<b>2.13</b>	Bull Spread Comparison	79
<b>2.14</b>	Bear Spread	81
<b>2.15</b>	Calendar Spread	86
<b>2.16</b>	Ratio Call Write	91
<b>2.17</b>	Call Ratio Spread	93
<b>2.18</b>	Put Ratio Spread	95
<b>2.19</b>	Call Backspread	96
<b>2.20</b>	Put Backspread	98
<b>2.21</b>	Butterfly Spread	100
<b>3.1</b>	The Collar as Insurance	159
<b>3.2</b>	VIX Volatilities	185
<b>4.1</b>	Southern Pacific Railroad	202
<b>4.2</b>	American Cyanamid	204
<b>4.3</b>	Gerber—Option Volume	206
<b>4.4</b>	Chipcom	208
<b>4.5</b>	U.S. Shoe	210

- 4.6** U.S. Shoe—Option Volume 212
- 4.7** Motorola 213
- 4.8** Sybase 217
- 4.9** Syntex 219
- 4.10** Bethlehem Steel 231
- 4.11** ADM, 12/27/95 232
- 4.12** Grupo Tribasa 234
- 4.13** U.S. Surgical, 7/20/95 235
- 4.14** Gerber—Implied Volatility 240
- 4.15** Gensia Pharmaceuticals 251
- 4.16** Liposome Technology 254
- 4.17** IBM, 8/92–10/94 259
- 4.18** Telefonos de Mexico (Telmex) 261
- 4.19** CBOE's Volatility Index (\$VXO)—Entire History 264
- 4.20** \$OEX Movements after Low \$VIX Readings 266
- 4.21** Volatility Index—VIX 269
- 4.22** OEX 270
- 4.23** \$VIX and \$OEX: 1997–1999 273
- 4.24** \$VXO Composite Spread: 1989–2003 279
- 4.25** Put–Call Ratio 285
- 4.26** 55-Day Index Put–Call Ratio 290
- 4.27** OEX during 1987 292
- 4.28** 55-Day Equity Put–Call Ratio 293
- 4.29** 21-Day QQQ Put–Call Ratio with QQQ Overlay 296
- 4.30** Standard Put–Call Ratio 299
- 4.31** \$OEX: 1999–2000 300
- 4.32** Weighted Equity-Only Put–Call Ratio: 1999–2000 303
- 4.33** Standard Equity-Only Put–Call Ratio 305
- 4.34** Weighted Equity-Only Put–Call Ratio 305
- 4.35** \$MSH Put–Call Ratio 309
- 4.36** \$MSH Weighted Put–Call Ratio 311
- 4.37** Nasdaq-100 Trading Stock (QQQ) 311
- 4.38** MSFT: 1999–2000 313
- 4.39** Standard MSFT Put–Call Ratio 314
- 4.39A** Weighted MSFT Put–Call Ratio 315
- 4.40** Standard INTC Put–Call Ratio 317
- 4.41** Weighted INTC Put–Call Ratio 318
- 4.42** 21-Day Gold Put–Call Ratio 319
- 4.43** Continuous Gold Futures 320
- 4.44** Continuous Live-Cattle Futures 323
- 4.45** 21-Day Live-Cattle Put–Call Ratio 323

<b>4.46</b>	Continuous T-Bond Futures	324
<b>4.47</b>	21-Day T-Bond Put-Call Ratio	325
<b>4.48</b>	21-Day S&P Put-Call Ratio	325
<b>4.49</b>	Continuous Sugar Futures	326
<b>4.50</b>	21-Day Sugar Put-Call Ratio	327
<b>4.51</b>	Continuous Coffee Futures	328
<b>4.52</b>	21-Day Coffee Put-Call Ratio	328
<b>4.53</b>	Continuous Cotton Futures	329
<b>4.54</b>	21-Day Cotton Put-Call Ratio	329
<b>4.55</b>	Continuous Live-Hog Futures	331
<b>4.56</b>	21-Day Live-Hog Put-Call Ratio	332
<b>4.57</b>	Continuous Natural Gas Futures	333
<b>4.58</b>	21-Day Natural Gas Put-Call Ratio	333
<b>4.59</b>	21-Day BP Standard Put-Call Ratio	334
<b>4.60</b>	21-Day BP Weighted Put-Call Ratio	335
<b>4.61</b>	21-Day JY Weighted Put-Call Ratio	336
<b>4.62</b>	21-Day SF Weighted Put-Call Ratio	337
<b>4.63</b>	21-Day EC Weighted Put-Call Ratio	338
<b>4.64</b>	21-Day SI Weighted Put-Call Ratio	339
<b>5.1</b>	Oscillator: 1998-2004	373
<b>5.2</b>	NYSE Advance-Decline Line	376
<b>5.3</b>	Heating Oil/Unleaded Gas Composite Spread: 1992-2003	391
<b>5.4</b>	HOG/HUG 1993 Contracts	392
<b>5.5</b>	HOG/HUG 1992 Contracts	393
<b>5.6</b>	HOG/HUG 2000 Contracts	393
<b>5.7</b>	HOG/HUG 2001 Contracts	394
<b>5.8</b>	HOG/HUG 2002 Contracts	395
<b>5.9</b>	HOG	397
<b>5.10</b>	Value Line/S&P 500 Composite: 1989-2003	400
<b>5.11</b>	Value Line Index Minus S&P 500	407
<b>5.12</b>	\$XAU Divided by Dec Gold Futures	410
<b>5.13</b>	\$XOI Divided by Dec Crude Oil Futures: 1992-1995	415
<b>5.14</b>	\$XOI Divided by Dec Crude Oil Futures: 1993	416
<b>5.15</b>	\$XOI Divided by Dec Crude Oil Futures: 1992-2003	418
<b>5.16</b>	\$UTY Divided by Dec T-Bond Futures	420
<b>5.17</b>	PD Divided by Dec Copper Futures	423
<b>6.1</b>	Naked Straddle Sale versus Naked Strangle	463
<b>6.2</b>	Strangle Sale	464
<b>6.3</b>	Call Ratio Spread	465
<b>6.4</b>	Straddle Buy	472
<b>6.5</b>	Retail Index (RLX)	476

<b>6.6</b>	Call Backspread	479
<b>6.7</b>	Call Calendar Spread	480
<b>6.8</b>	Comparison of Delta and Time Remaining	487
<b>6.9</b>	Delta of At-the-Money Option as Time Passes	489
<b>6.10</b>	Comparison of Delta and Volatility	490
<b>6.11</b>	Two-Year LEAPS Call Pricing Curve	494
<b>6.12</b>	Gamma versus Time	496
<b>6.13</b>	Position Delta of Ratio Spread	500
<b>6.14</b>	Profit of Ratio Spread	502
<b>6.15</b>	Profit and Loss of Ratio Spread If Volatility Changes	503
<b>6.16</b>	Wings Profit and Loss	508
<b>6.17</b>	Profit and Loss of Double Ratio Spread	510
<b>6.18</b>	Calendar	512
<b>6.19</b>	Bell Curve or Normal Distribution	522
<b>6.20</b>	Lognormal Distribution	522
<b>6.21</b>	Forward Skew	523
<b>6.22</b>	Reverse Skew	524
<b>6.23</b>	Call Ratio Spread	526
<b>6.24</b>	Put Backspread	526
<b>6.25</b>	Put Ratio Spread	531
<b>6.26</b>	Call Backspread	531
<b>6.27</b>	OEX Backspread—Stage 1	534
<b>6.28</b>	OEX Backspread—Stage 2	536
<b>6.29</b>	OEX Backspread—Stage 3	540
<b>6.30</b>	OEX Backspread—Stage 4	542
<b>6.31</b>	AMI Short-Term Calendar Spread	557
<b>7.1</b>	Order Flow	570
<b>7.2</b>	Examples of Closing Stops	597
<b>C.1</b>	Binomial Model Lattice	627

# 1 Option History, Definitions, and Terms

There are many types of listed options trading today: stock options, index options, and futures options are the major ones. The object of this book is to explore some of the many ways in which options can be used and to give practical demonstrations that will help the reader make money.

Options are useful in a wide array of applications. They can be used to establish self-contained strategies, they can be used as substitutes for other instruments, or they can be used to enhance or protect one's position in the underlying instrument, whether that is stock, index, or futures. In the course of this book, the reader may discover that there are more useful applications of options than he ever imagined. As stated in the Preface, this book is not really meant for novices but contains all definitions to serve as a platform for the larger discussion.

## UNDERLYING INSTRUMENTS

Let's begin with the definitions of the simplest terms, as a means of establishing the basic building blocks. Before even getting into what an option *is*, we should have some idea of the kinds of things that have options. That is, what are the underlying instruments that provide the groundwork for the various listed derivative securities (options, warrants, etc.)? The simplest underlying instrument is common stock. Options that give the investor the right to buy or sell common stock are called *stock options* or *equity options*.



## 2 OPTION HISTORY, DEFINITIONS, AND TERMS

Another very popular type of underlying instrument is an *index*. An index is created when prices of a group of financial instruments—stocks, for example—are grouped together and “averaged” in some manner so that the resulting number is an index that supposedly is representative of how that particular group of financial instruments is performing. The best-known index is the Dow Jones Industrial Average, but there are indices of many other groups of stocks; indices with a large number of stocks in them are the Standard & Poor’s (S&P) 500 and the Value Line Index, for example. There are also many stock indices that track various groups of stocks that are in the same industry: Utility Index, Oil Index, Gold and Silver Index, for example. There are even indices on foreign stock markets, but they have options listed in the United States; these include the Japan Index, Hong Kong Index, and Mexico Index, as well as several others. Indices are not restricted to stocks, however. There are indices of commodities, such as the Commodity Research Bureau Index. Moreover, there are indices of bonds and rates; these include such things as the Short-Term Rate Index, the Muni Bond Index, and the 30-Year Bond Rate Index. Options on these indices are called *index options*. Appendix A contains a list of available index options.

Finally, the third broad category of underlying instrument is *futures*. This is probably the least-understood type of underlying instrument, but as you will see when we get into strategies, futures options are extremely useful and very important. Some people mistakenly think options and futures are nearly the same thing. Nothing could be further from the truth. The “dry” definition is *a futures contract is a standardized contract calling for the delivery of a specified quantity of a certain commodity, or delivery of cash, at some future time*. In reality, owning a futures contract is very much like owning stock, except that the futures’ price is related to the cash price of the underlying commodity, and the futures contract has a fixed expiration date. Thus, futures contracts can climb in price infinitely, just as stocks can, and they could theoretically trade all the way down to zero, just as stocks can. Moreover, futures can generally be traded on very small percentages of margin, so that the risk of owning futures is quite large, as are the potential rewards. We discuss futures contracts in more detail later, but this brief description should suffice to lay the groundwork for the following discussion of options

terms. As might be suspected, options on futures contracts are called *futures options*.

## OPTION TERMS

An *option* is the right to buy or sell a particular underlying security at a specific price, and that right is only good for a certain period of time. The specific items in that definition of an option are as follows:

- **Type.** Type describes whether we are talking about a call option or a put option. If we are talking about stock options, then a call option gives its owner the right to *buy* stock, while a put option gives him the right to *sell* stock. While it is possible to use options in many ways, if we are merely talking about buying options, then a call option purchase is bullish—we want the underlying stock to increase in price—and a put option purchase is bearish—we want the stock to decline.
- **Underlying Security.** Underlying security is what *specifically* can be bought or sold by the option holder. In the case of stock options, it's the actual stock that can be bought or sold (IBM, for example).
- **Strike Price.** The strike price is the price at which the underlying security can be bought (call option) or sold (put option). Listed options have some standardization as far as striking prices are concerned. For example, stock and index options have striking prices spaced 5 points apart. Moreover stock options also have strikes spaced  $2\frac{1}{2}$  points apart if the strike is below 25. Futures option striking prices are more complex, because of the differing natures of the underlying futures, but they are still standardized for each commodity (1 point apart for bonds, for example, or 10 points apart for a more volatile commodity, like corn).
- **Expiration Date.** The expiration date is the date by which the option must either be liquidated (i.e., sold in the open market) or exercised (i.e., converted into the physical instrument that underlies the option contract—stock, index, or

## 4 OPTION HISTORY, DEFINITIONS, AND TERMS

futures). Again, expiration dates were standardized with the listing of options on exchanges. For stock options and most index options, this date is the Saturday following the third Friday of the expiration month (which, by default, makes the third Friday of the month the last trading day). However, for futures options, these dates vary widely. More about that later. The most heavily traded listed options usually have less than nine months of life remaining, but there are longer-term options—called LEAPS options when one is referring to stock options or index options—that can extend out to two years or more.

These four terms combine to uniquely describe any option contract. It is common to describe the option by stating these terms in this order: underlying, expiration date, strike, and type. For example, an option described as an *IBM July 50 call* completely describes the fact that this option gives you the right to buy IBM at a price of 50, up until the expiration date in July. Similarly, a futures option described as the *U.S. Bond Dec 98 put* gives you the right to sell the underlying 30-year U.S. Government Bond futures contract at a price of 98, up until the expiration of the December options.

### THE COST OF AN OPTION

The cost of an option is, of course, called the *price*, but it is also referred to as the *premium*. You may notice that we have not yet described *how much* of the underlying instrument can be bought or sold via the option contract. Listed options generally standardize this quantity. For example, stock options give the owner the right to buy (call) or sell (put) 100 shares of the underlying stock. If the stock splits or declares a stock dividend, then that quantity is adjusted to reflect the split. But, in general, stock options are spoken of as being options on 100 shares of stock. Index options, too, are generally for 100 “shares” of the underlying index; but since the index is not usually a physical entity (i.e., it does not really have *shares*), index options often convert into cash. We will describe that process shortly. Finally, futures options are exercisable into *one* futures con-

tract, regardless of how many bushels, pounds, bales, or bonds that futures contract represents in terms of the actual commodity.

Only by knowing this quantity can you tell how many actual dollars an option contract will cost, since option prices are quoted in units. For example, if someone tells you that the IBM July 50 call is trading at 3 (and we know that the option is for 100 shares of IBM), then the actual cost of the option is \$300. Thus, one option trading at 3 costs \$300 and “controls” 100 shares of IBM until the expiration date.

It is a fairly common mistake for a beginner to say “I want to buy 100 options” when what he really means is he wants to buy one option (this mistake derives from the fact that if a stock investor wants to control 100 shares of IBM, then he tells his broker to buy 100 IBM common stock). This can result in some big errors for customers and/or their brokerage firms, or possibly even worse. You can see that if you told your broker to buy 500 of the above IBM options, you would have to pay \$150,000 for those options ( $500 \times \$300$ ); but if you really meant to buy 5 options (to “control” 500 shares of IBM), you thought you were making a \$1,500 investment ( $5 \times \$300$ ). Quite a difference.

---

Of course, these sorts of things tend to balloon out of control at the worst times (Murphy’s Law is what they call it). When the market crashed 190 points on one Friday in October 1990 as the UAL deal fell apart, people were genuinely concerned. On Monday morning, a rather large stockholder had been reading about buying puts as protection for his stocks, so he put in a market order to buy something like 1,500 puts at the market. His broker was a little taken aback, but since this was a large stockholder, he put the order in. Of course, that morning, the puts were extremely expensive as people were fearful of another 1987–style crash. Even though the options had been quoted at a price of 5 on Friday night, the order was filled on Monday morning at the extremely high price of 12 because of fear that prices would crash further. Two days later, the customer received his confirm, requesting payment of \$1.8 million. The customer called his broker and said that he had meant to buy puts on 1,500 shares, not 1,500 puts—a difference of roughly \$1,782,000! Of course, by this time, the market had rallied and the puts were trading at only a dollar or two (one or two points, that is). I’m not sure how the lawsuit turned out.

---

The cost—in U.S. dollars—of any particular futures option depends, of course, on how much of the commodity the futures control. We have already said that a futures option “controls” one futures contract. But each futures contract is somewhat different. For example, soybean futures and options are worth \$50 per point. So if someone says that a soybean July 600 put is selling for 12, then it would cost \$600 ( $12 \times \$50$ ) to buy that option. However, Eurodollar futures and options are worth \$2,500 per point. So if a Eurodollar Dec 98 call is selling for 0.70, then you have to pay \$1,750 ( $0.70 \times \$2,500$ ) to buy it. We specify the terms for most of the larger futures contracts in Appendix B.

### **THE HISTORY OF LISTED OPTIONS**

On April 26, 1973, the Chicago Board Options Exchange (CBOE) opened its doors and began trading listed call options on 16 stocks. From that humble beginning, option trading has evolved to today’s broad and active markets. We thought it might be interesting to review how option trading got to where it is today (*nostalgic* might be a better word for “old-timers” who have been around since the beginning). In addition, a review of the history of listed option trading might provide some insight for newer traders as to how and why the markets have developed the way they have.

#### **The Over-the-Counter Market**

Prior to listed option trading, puts and calls traded over the counter. In this form, there were several dealers of options who found both a buyer and a seller (writer) of a contract, got them to agree on terms, and executed a trade between them. The term *writer* arose from the fact that an actual contract was being “written” and the issuing party was the seller of the option. The dealer generally took a commission out of the middle of this trade: for example, the buyer might have paid  $3\frac{1}{4}$  and the seller received 3. The remaining  $\frac{1}{4}$  point was kept by the dealer as payment for lining up the trade.

Options of this type were generally struck at the current stock price; thus if the stock was selling at  $46\frac{3}{8}$  when the contract was agreed upon, then that would be the striking price of the calls (or puts). This made for some very awkward calculations. Moreover, these over-the-counter options normally had expiration dates that were fixed time periods when they were issued: the choices were time periods of 6 months + 10 days, 95 days, 65 days, or 35 days. One other term that was unusual: dividends went to the holder of the call upon exercise. Thus, upon exercise, the striking price would actually be adjusted for the dividends paid over the life of the option.

Besides the relatively arduous task of finding two parties who wanted to take opposite sides of a particular trade, the greatest hindrance to development of the over-the-counter market was that there was virtually no secondary market at all. Suppose you bought a call on a stock with these terms: strike price  $46\frac{3}{8}$ , expiration date 35 days from trade date. Later, if the stock went up a couple of points quickly, you might theoretically have wanted to sell your over-the-counter call. However, who were you going to sell it to? The dealer might try to find another buyer, but the terms would be the same as the original call. Thus, if the stock had risen to  $48\frac{3}{4}$  after 10 calendar days had passed, the dealer would be trying to find someone to buy a call that was  $2\frac{3}{8}$  points in-the-money that had 25 days of life remaining. Needless to say, it would be virtually impossible for a buyer to be found. Thus, option holders were often forced to hold on until expiration or to trade stock against their option in order to lock in some profit. Since this was in the days of fixed commission rates, it was a relatively expensive matter to be trading stock against an option holding. Altogether, this was a small option market, trading less than 1,000 contracts daily in total.

## **The CBOE Beginning**

This over-the-counter arrangement was onerous for all parties. So it was decided to put into practice the idea of standardizing things by having fixed striking prices and fixed expiration dates, and having all trades clear through a central clearing corporation. These solutions all came from the Chicago Board of Trade (CBOT), since standard-

ization of futures contracts had proven to be workable there. The first president of the CBOE was Joe Sullivan, who had headed the research project for the CBOT.

However, since over-the-counter option trading was “the way it had always been,” the idea of standardizing things was met with heavy skepticism. The extent of this skepticism was most evident in one interesting story: the major over-the-counter dealers were offered seats on the fledgling CBOE for the nominal cost of \$10,000 apiece. A seat today is worth over \$450,000. Few of them took the opportunity to buy those seats for what turned out to be a paltry amount; many were convinced that the new exchange was little more than a joke. In addition, since these new options were traded on an exchange, the Securities and Exchange Commission (SEC) had to approve them and issue regulations.

Nevertheless, the Chicago Board Options Exchange opened its doors on April 26, 1973, with first-day volume of 911 calls being traded on 16 stocks. Surprisingly—and even some traders who were around at the beginning may find this hard to remember—IBM was not one of the original 16. It was listed in the second group of 16 stocks, which were added in the fall of 1973. Given the fact that IBM has been, by far, the most active equity option stock, it is hard to remember that it wasn’t one of the originals. In fact, the original group was a rather odd array of stocks. If you were around at the beginning, test your memory. How many of them can you remember? They are listed three paragraphs below.

Besides standardizing the terms of options, the CBOE introduced the market maker system to listed equity markets and also was responsible for the Option Clearing Corporation (OCC), the guarantor of all options trades. Both of these concepts were important in giving the new exchange viability from the viewpoints of depth of markets and reliability of the exercise process. If you exercised your call, the OCC stood ready to make delivery even if the writer of the call somehow defaulted (margin rules, of course, generally prevented such a default, but the existence of the OCC was an important concept).

The second group of 16 stocks that were listed contained some of the most active traders over the years, in addition to IBM: RCA, Avon, Exxon, Kerr-McGee, Kresge (now K-Mart), and Sears, to name a few. Another group of eight stocks was added in November 1974,

and the growth of the listed option market was off and running. The American Stock Exchange (AMEX) listed options in January 1975, while the Philadelphia Stock Exchange added their options in June 1975. Furthermore, the success of this listed market eventually spurred the listing of futures options that we have today (agricultural options trading had been banned since the 1920s due to excesses within the industry, and there was no such thing as a financial future at the time). The continued issuance of new products—such as index futures and options, exchange-traded funds (ETFs), and financial futures—and the subsequent growth and revitalization of the exchanges that listed them can be traced to the success of the CBOE. The old over-the-counter market was virtually eliminated, except for options on stocks that weren't listed on the option exchanges.

The original 16 stocks whose options were initially listed on the CBOE were: AT&T, Atlantic Richfield, Brunswick, Eastman Kodak, Ford, Gulf & Western, Loews, McDonald's, Merck, Northwest Airlines, Pennzoil, Polaroid, Sperry Rand, Texas Instruments, Upjohn, and Xerox.

## **Index Options**

The next large innovation in the equity markets was the introduction of index trading. This historic type of trading began when the Kansas City Board of Trade listed futures on the Value Line Index in 1982. The CBOE invented the OEX index (composed of 100 fairly large stocks, all of which had options listed on the CBOE) and listed the first index options on it on March 11, 1983. Today the OEX index is known as the Standard & Poor's 100 Index, but it still trades with the symbol "OEX." This has been one of the most successful equity or index option products ever listed. Meanwhile, the Chicago Mercantile Exchange (Merc) started trading in S&P 500 futures, whose success and power extended far beyond the arena of futures and option trading—eventually becoming the "king" of all index trading and subsequently being the instrument that was blamed for the crash of 1987 and numerous other nervous days in the market.

The reason that these index products were so successful was that for the first time it was possible for an investor to have a view on the



market itself and to be able to act on that view directly. Prior to the existence of index products, the investor—whether an individual or a large institutional money manager—had to implement his market view by buying stock. As we all know, it is often possible to be right on the market but to be wrong on a particular stock. Being able to trade indices directly took care of that problem.

## **Exchange-Traded Funds**

In the 1990s, a new concept was introduced—the exchange-traded fund. These are merely groups of stocks with a common trait—oil stocks, for example—that are created by large institutions. The resulting ETF is actually listed and traded on the New York Stock Exchange (NYSE) or the AMEX. Thus investors can actually buy an index, where these are listed. Some other similar products have been listed as well. These are unit trusts or depository trusts. Again, a group of stocks is bundled together, and the resulting unit trust is listed and traded on an exchange. In many cases, options are traded on these entities as well.

The most popular and liquid of these products are the SPDRS (S&P 500 Depository Receipts), which are equal to one-tenth the value of the S&P 500 Index itself, and the Nasdaq 100 Tracking Stock (QQQ). However, there are now literally hundreds of these, many of which are called iShares, originally created by Barclays Global Investors to track all manner of indices.

Many institutional and private investors who prefer passive management (an index fund) and diversity are trading these various ETFs. They allow investors to seek out the sectors they desire and to trade them simply and directly, without having to buy several stocks deemed representative of the sector.

## **Futures Options**

The initial listing of financial futures contracts depends on how you define financial futures. If you include currencies, then the 1972 listing of currency futures on the Chicago Merc marked the beginning.

If, however, you mean interest rate futures, the initial listing was U.S. Government National Mortgage Association (GNMA) futures on the CBOT in 1975. U.S. Treasury Bill (T-bill) futures followed in 1976. However, the most popular contracts, the 30-year U.S. Bond contract and the Eurodollar futures were listed in 1977 and 1981, respectively. Options on these products didn't appear until several years after the futures were listed (1982 for the bonds, 1986 for Eurodollars). The first agricultural options were listed on soybeans in 1984.

### **Today's Over-the-Counter Market**

According to the CBOE, there are several hundred million option contracts traded annually in the United States today. There are, of course, many foreign exchanges that trade listed options as well, having patterned themselves after the success of the U.S. markets. Ironically, there is a large volume of option contracts trading that is not counted in these figures, for there is an active over-the-counter market in derivative products again today!

We seem to have come full circle. While today's over-the-counter market is much more sophisticated than its predecessor, it has certain similarities. The greatest similarity is that contracts are not standardized. Today's large institutions that utilize options prefer to have them customized to their portfolios and positions (for it is unlikely that they own the exact composition of the S&P 500 or the S&P 100 and therefore can't hedge completely with futures and options on those listed products); moreover, they may want expiration dates that are other than the standard ones.

A very large difference between the over-the-counter market of today and yesteryear is that the contracts today are generally issued by the larger securities firms (Salomon Brothers, Morgan Stanley, Goldman Sachs, etc.). These firms then employ strategists and traders to hedge their resulting portfolio. This is a far cry from the old days where the brokerage firm merely located both a buyer and a seller and got them together for the option transaction. If history repeats itself, the exchanges will make attempts to move the current over-the-counter trading onto the listed marketplace. The CBOE has

already listed FLEX options (which allow for varying expiration dates and striking prices) as the beginning of the inroad into this market.

Thus, option strategies and option trading are an ever-evolving story. Those who make the effort to understand and use options will certainly have more alternatives available to themselves than those who don't.

### OPTION TRADING PROCEDURES

Listed options can be bought and sold whenever the exchange is open. This is the biggest advantage to trading listed options (as opposed to trading the older style over-the-counter options), and it is the reason why the option exchanges have enjoyed their success. Thus, if you buy an option in the morning, expecting the market to go higher, but then change your mind in the afternoon, you are perfectly free to go back into the market and sell your option.

The concepts of open interest are familiar to futures traders, but not necessarily to stock traders. When a trader first transacts a particular option in his account, he is said to be *executing an opening trade*. This is true whether he initially buys or sells the option. Such a trade adds to the *open interest* of that particular option series. Later, when he executes a trade that removes the option from his account, he is said to be *executing a closing trade*. A closing trade decreases the open interest. Some technicians keep an eye on open interest as a possible predictor of futures price movements by the underlying security. The reason that we mention this is that you must specify whether the trade is opening or closing when you place an option order.

An option order must specify the following seven items:

1. Buy or sell.
2. Quantity.
3. The description of the option (e.g., IBM July 50 call).
4. Price.
5. Type of order (see the next paragraph).
6. Whether the trade is opening or closing.
7. Whether the account is "customer" or "firm."

Order types (item 5) for options are just like they are for stocks or futures. You can use *market orders* (dangerous in illiquid options), *limit orders* (probably a good idea most of the time), *stop orders* (not a good idea with options), and *good-until-canceled orders*. If you are trading directly through professional traders on the floor, you will probably want to use *market not held* orders (which gives the broker in the crowd the ability to make a decision of his own, for your account). Only use “market not held” if you know the floor broker and trust his judgment; it is not a good idea to use this type of order if you’re entering your order through one of the large brokerage firms (they probably wouldn’t accept a “not held” order anyway). Other, more exotic order types, such as *market on close*, are not available for most options, but you can always check with your broker to be sure.

Regarding item 6, if you don’t know the difference between “customer” and “firm,” then you’re a “customer.” For the record, a firm trader is one who is trading the account of a member of the exchange (these are professional traders, many of whom trade from trading desks—you don’t necessarily have to be on the trading floor in order to trade for a member firm’s own account). A customer is everyone else—all the traders who are not members of the exchange or trading for the account of an exchange member. This distinction is placed on the order because a “customer” order has priority over a “firm” order in many situations on the trading floor.

A typical option order, then, might be “Buy 5 IBM July 50 calls at 3, open customer”; or if you are trading through a brokerage firm, they will assume you are a customer, so you might need only to say “Buy 5 IBM July 50 calls at 3 to open.” In either case, this is a limit order because you have specified a price, indicating that you are not willing to pay more than 3 for this option. If you are trading in a very liquid option (the most liquid options are IBM for stocks, QQQ for Indices, and Eurodollars for futures), you might use a market order: “Buy 10 Eurodollar Dec 98 calls at the market to open.” If you get in the habit of stating your orders correctly and making your broker (or floor trader) repeat them back to you, you will eliminate almost all mistakes, or “errors” as they are officially called. I’d bet that more than 75 percent of all errors are caused by confusing buy and sell: the person stating the order says buy, but the person

writing it down on the other end of the phone circles “sell” on the order ticket for some reason; sometimes, even if it’s repeated back, the person giving the order isn’t listening too carefully and the order goes in incorrectly.

---

One of the most embarrassing errors in history didn’t involve options. In 1994, Bell Atlantic and Telecommunications Inc., a large cable TV operator, announced a merger that would have been very beneficial to Telecommunications Inc.’s stock price. The stock symbol for Telecommunications Inc. is TCOMA (its class A stock is the primary trading vehicle), but among “techies” the stock is known as TCI (this is something akin to Texas Instruments being known as TI to all the research labs guys, but its stock symbol is TXN). Well, as you might guess, the television financial news reporters—who often like to appear as if they are one of the “inside” guys—repeatedly stated that Bell Atlantic was buying TCI. As it turns out, there is a stock whose symbol is TCI—Transcontinental Realty Inc., a real estate investment trust, or REIT! Transcontinental Realty was up 3 points in fairly heavy trading before people started to realize their mistake. As soon as they did, it collapsed back to where it was. I have yet to meet anyone who actually admits that they bought TCI when they should have bought TCOMA, but they’re out there somewhere, and some of them are probably “professional” arbs (or were).

---

The point is that each aspect of a trade should be handled in a professional manner—state the order properly, demand that it be repeated back, listen to the repeat. That’s all you can do; if an order clerk subsequently types the wrong information into a computer or mistakenly circles the wrong information on the floor ticket, you can’t control that. But you can demand that restitution be made if you handle your end of things correctly. Most brokerage firm office managers have no problem refunding a customer the amount of an error that is clearly the brokerage firm’s fault—you just don’t want to be in the gray area, where there is some dispute over what was said and never repeated.

## **ELECTRONIC TRADING**

Today, many traders use electronic platforms to place their (option) trades. The same items must be specified as when placing your order over the phone, although the computer software handling your trade

may be smart enough to tell whether you are opening or closing the position—and it won't ask if you're "firm" or "customer" because it will already know that. An electronic order entry screen will normally show you your order before you send it to the floor. This is your chance to check for errors (similar to asking the phone clerk or broker to repeat the order back to you, if you are using humans in your order entry process). Do not get in the habit of automatically clicking on "OK" without rereading the particulars of your order. Any errors that occur are necessarily *yours* because there are no other people involved in the order entry process.

Later on in the process, it may turn out that a computer malfunction at either your electronic brokerage firm or on the trading floor kept you from getting the execution you thought you were entitled to. This is not an "order entry error" and may be correctable, but you would have to talk to some humans at your electronic brokerage firm in order to sort out what, if any, compensation you deserve.

## EXERCISE AND ASSIGNMENT

An option is said to have *intrinsic value* when the stock price is above the strike price of a call or below the strike price of a put. Another term that describes the situation where an option has intrinsic value is to say that the option is *in-the-money*. If the option has no intrinsic value, it is said to be *out-of-the-money*. For calls, this would mean that the underlying's price is currently *below* the striking price of the call; and for puts, it would mean that the underlying's price is *above* the strike price of the put.

Another related definition that is important is that of *parity*. Any derivative security that is trading with no time value premium is said to be trading *at parity*. Sometimes parity is used as a sort of measuring stick. One may say that an option is trading at a half-point or a quarter-point above parity.

---

*Example:* XYZ is 53.

July 40 call: $12\frac{3}{4}$	$\frac{1}{4}$ point below parity
July 45 call: 8	At parity
July 50 call: $3\frac{1}{4}$	$\frac{1}{4}$ point above parity

---

Ultimately, one of two things happens to an option as it reaches expiration: (1) it is exercised or (2) it expires worthless. The owner (also called the *holder*) of an out-of-the-money option will let it expire worthless. This is any call where the stock, index, or futures price is *below* the strike price at expiration. In the same manner, he will let a put expire worthless if the underlying price is *higher* than the strike price at expiration. For example, if one owned the IBM July 50 call and IBM was trading at 45 at expiration, why would you want to exercise your call to buy 100 shares of IBM at 50 when you can just go to the stock market and buy 100 shares of IBM for 45? You wouldn't, of course. Believe it or not, though, in the early days of option trading, things like that did happen occasionally.

---

In the movie *Brewster's Millions*, starring Richard Pryor, a minor league baseball player stands to inherit a large amount of money—something like \$300 million—providing that he fulfill the terms of a rather crazy will: he must spend (or lose) something like \$30 million in a short period of time. Of course, he goes through all kinds of crazy maneuvers to barely accomplish his appointed task by the given date. It's an intriguing movie, as it gets you thinking about how much money you could spend quickly. I've often thought that he could have simplified his life considerably by just buying some options that were about to expire, whose strike price was way above the current market price, and exercising them. He could have squandered the \$30 million in an instant!

---

Of course, if the option is in-the-money—that is, the price of the underlying is higher than the strike price of a call—then the owner of the call will exercise it because it has value. In an example similar to the previous one, if you own the IBM July 50 call and IBM is selling at 55, then you would exercise the call because you can buy IBM at 50 via your call exercise, whereas you would have to pay 55 to buy IBM in the open market. Conversely, a put holder would exercise his put if it is in-the-money—that is, if the underlying's current price were below the strike price—because the put gives him the right to sell at the higher price, the strike.

At the end of an option's life, there is a good chance that it ends up in the hands of a market maker, or other "firm" trader, if it has intrinsic value. This is because most "customers" sell their options in

the open market rather than exercise them. They do this for two reasons: (1) they are required to come up with substantially more cash to buy the stock than it takes to buy the option, and (2) the commission on one option trade is smaller than two stock trades (if you exercise a call and buy stock, for example, you're going to have to sell the stock someday and pay another commission). Firm traders don't pay commissions (so that's why those seats cost so much!), and as expiration nears, they buy options from customers who are selling them in closing transactions. There is nothing particularly good or bad about this phenomenon, it's just the most efficient way for everybody to act as expiration approaches. The firm traders then exercise the options at expiration; they are not as concerned about capital requirements as most customers would be. In all probability, the firm traders have already "squared up" their positions by the time they exercise, so they don't end up being long or short much stock or futures at all.

Many people have heard and even repeated the statement that "90 percent of all options expire worthless." It's unclear where that got started—some say from a study done back in the 1940s regarding the illiquid over-the-counter market at that time. This statement is patent nonsense with respect to listed options, and one only has to think about it to realize the fact. Consider this scenario: when options are initially listed, they have striking prices that surround the current price of the underlying (if IBM is trading at 50, then there will be strikes of 40, 45, 50, 55, and 60, etc.). Now, puts and calls are traded at all strikes—not necessarily in equal quantities, but there will be some open interest in all series. As the stock fluctuates during the life of the options, various strikes will become more liquid as IBM's stock price nears that particular strike. As a result, open interest will build up at various strikes.

By expiration, if IBM has risen in price, nearly all the calls will be in-the-money and therefore will *not* be worthless; if IBM falls in price, nearly all the puts will be in-the-money at expiration. Since options are listed at least nine months in advance of expiration, there is a significant chance that the stock or futures contract will have a serious price change by the time expiration rolls around. In either case, I can assure you that far less than 90 percent of the options are expiring worthless.



Statistics have been kept by the CBOE since options first started trading in 1973, and they show that only 30 percent of equity options expire worthless. The CBOE says that this figure is rather consistent, expiration after expiration, year after year. Not that the CBOE's data would need verification, but we have kept similar statistics at our own firm, McMillan Analysis Corp., since 1998, and our figures match up quite well with the CBOE's. What we have done is to look at the closing bid and offer of all equity options on the last day of trading. If the option has a bid of 60 cents or more, we declare it to "have value." Since 1998, on average, approximately 58 percent of all options "have value" at expiration, based on open interest. The CBOE further claims that about 10 percent of all options are closed out prior to expiration in transactions where both parties (the buyer and the seller) are executing *closing* transactions. Adding this 10 percent figure to our observed statistics of 58 percent gives us the fact that 68 percent of all options have some worth at expiration (and this doesn't even count the ones that are worth more than zero but less than 60 cents). Of course, this doesn't mean that only 30 percent of option buyers lose money—they may have paid more for the option than its worth at the end. Nor does it say anything about what percentage of out-of-the-money options expire worthless, but it *does* prove that the old wives' tale of 80 percent or 90 percent of options expiring worthless is a falsehood. This is important for novices to realize: many are led to naked option selling—sometimes with disastrous results—because they feel that they can sell any option since they are operating under the false assumption that there will be a 90 percent chance of it expiring worthless.

---

I personally began trading options in 1973 when my broker, Ron Dilks, first pointed out a *Business Week* article to me that talked about listed options on Kresge. Since then, through my various endeavors as individual trader, risk arbitrageur, and money manager, I have had several *hundred thousand* contracts that were held until expiration. I have no exact way of knowing how many were exercised or assigned and how many expired worthless, but my general feeling is that the count is about 50-50. That is, about half were in-the-money at expiration, and half were not. I *do* know, with a certainty born of 20 years of experience, that nowhere near 90 percent expired worthless.

---

## Mechanics of Exercise and Assignment

The control of exercise is at the behest of the owner of the option. He is the one that determines when to exercise. To exercise a stock or index option, he must notify his broker by 4 P.M. Eastern time (or 5 P.M. on expiration Friday) that he wants to exercise his option. His broker then notifies the OCC, which is the central clearing house for all listed stock options. The OCC only deals with member firms (your brokerage firm, for example), so it does not “know” individual customers or individual accounts. The OCC then gathers all exercise notices that it received that night and randomly assigns them to member firms who are short the option series that have been exercised. The next morning, the member firm who was assigned then randomly picks out customer accounts that are short that particular option series and notifies those option writers that they have been assigned. This assignment notice should be received by the option writer well in advance of the opening of trading so he can plan any necessary trading action that the assignment notice might necessitate. The trades are deemed to have taken place on the *day of the exercise*; thus the person who is assigned doesn't find out until a day after the trade has actually taken place.

Futures option exercises work in a similar manner, although times may vary slightly; and the exchange is the clearing center, not the OCC.

Figure 1.1 summarizes what transaction takes place in the underlying security when a put or call option is exercised or assigned. For example, if you exercise a put, you sell the underlying; and the seller of the put, who is then assigned, buys the underlying. This illustration is not correct for cash-based options (see Figure 1.2).

Most novice investors understand that you may first buy a security and then later sell it to take a profit or a loss. There are only two rules you need to know about making money in any market.

1. Buy low and sell high, not necessarily in that order.
2. He who sells what isn't his'n, must buy it back or go to prison.

That is, you may sometimes be better able to profit by selling a security first and buying back later. This is apropos to stocks,

**Figure 1.1**  
**EXERCISE AND ASSIGNMENT OF STOCK OR**  
**FUTURES OPTIONS**

	Call Option	Put Option
<b>Exercise</b>	Buy Underlying	Sell Underlying
<b>Assigned</b>	Sell Underlying	Buy Underlying

options, futures, bonds, or just about anything. The second rule, though, indicates that if this is a physical security—stocks or bonds—then you can't sell it without first borrowing it from an existing holder, or you could have a problem on your hands. However, futures and options may be sold short without any searching for existing physical securities since they are contracts.

This is a good place to define what the term *cover* means. In the context of stock trading, when you first buy stock and then later sell it, you are said to liquidate your position. However, if you had first sold it short, then when you later buy it to close out your position, you are said to cover your position. Thus, it is common nomenclature to describe the closing out of a short position as covering. The term also applies to options. If you initially sell an option as the first transaction, that is called an *opening sell transaction*. This leaves you short the option, and you may someday be assigned on that option, if you do not first buy it back (cover it).

An extremely important point should be noted here: *if you are an option seller, you can't always tell if you're going to be assigned at expiration merely by observing the closing price of the underlying stock; you really need to wait until Monday morning to check your assignment notices.* There are two reasons for this. One is that if a stock holder has a large position that he can't sell in the open market, he might decide to exercise puts (if he owns them) to "blow out" his position. This may be easier than holding onto the stock and trying to re hedge it, or trying to sell it in the open market.

When I managed the arbitrage department for a major brokerage firm, we were long a lot of Dayton Hudson stock on Friday, October 16, 1987, the trading day before the crash. The stock had closed at about 50 on October 15. We also owned the Oct 45 puts as a hedge. Friday, October 16, was expiration day for the October options. As the day progressed, the market dropped over 100 points (the first time in history that that had happened) and Dayton Hudson was being smashed. It closed at  $45\frac{1}{2}$ , but with very little stock being bid for. It appeared that there was no way we could sell our stock in the open market on Monday since the market was weak and there weren't many bids for the stock (of course, we didn't realize that on Monday there was going to be a crash). In addition, the longer-term options in Dayton Hudson were quite expensive and also rather illiquid. So, we exercised our Oct 45 puts and sold our entire position at 45—below the last sale price. Thus, whoever was short those Dayton Hudson puts was assigned, even though they were out-of-the-money, and he found out on Monday morning that he had bought stock at 45. I believe the stock opened around 42 and traded down from there.

---

The other reason that an option seller can't be sure about assignments until Monday morning after expiration is that corporate news may be released after the 4 P.M. Friday close. Since options may be exercised up until 5 P.M. on expiration Friday, it is possible for news to come out after the market closes that would make holders of the options want to exercise. This, by the way, is the reason your brokerage firm considers you to have written a naked option if you sell another option on expiration Friday without bothering to cover a deeply out-of-the-money option for a sixteenth.

---

Major news has come out between 4 P.M. and 5 P.M. on expiration Friday many times. Some of these have involved takeovers and some earnings news, or other corporate news. A rather famous one occurred in 1994. Gerber Products was the subject of takeover rumors for quite a while. On Friday, May 20 (expiration day), the stock closed at  $34\frac{5}{8}$ . After the close, a takeover bid was announced, and the stock opened at 51 on Monday, May 23. Many sellers of the May 35 calls received assignment notices on that Monday morning and were rather upset; some had gone home Friday night assuming that their short May 35 calls were expiring worthless. There were even lawsuits filed, claiming that exercise notices were not delivered to the OCC on time. That is a very difficult allegation to prove, however.

---

**Exercises Prior to Expiration.** Futures options are rarely exercised prior to expiration, except when they are deeply in-the-money. In that case, an option holder may exercise in order to reduce his carrying costs for holding an expensive option. Stock options, however, are exercised prior to expiration fairly often. The most common time is on the day before the stock goes ex-dividend. An equity call holder is not entitled to the dividend, so an in-the-money call that has no time value premium will drop in price by the ex-dividend amount.

---

*Example:* XYZ is trading at 55 and is going to go ex-dividend by 50 cents tomorrow. The July 50 call, which has only a short time remaining until expiration, is trading at 5. Tomorrow, the stock will open at  $54\frac{1}{2}$  (after going ex-dividend the 50 cents). Thus, the call will be trading for  $4\frac{1}{2}$  the next morning. The call holder will exercise (or sell his call to a market maker, who will exercise) rather than squander a half point.

---

Hence, if an in-the-money call has no time value premium on the day before the stock goes ex-dividend, the call holder will generally exercise in order to preserve his value. The call seller, who is assigned, doesn't find out until the next day (the morning that the stock is going ex-dividend). Thus, the seller finds out that he actually sold the stock on the previous day, and thus he does not get the stock dividend. For this reason, it is often the case that when a stock declares a large cash dividend, the terms of the option are adjusted. Such an adjustment protects the call holder.

**Cash Option Exercise.** We mentioned earlier that index options convert into cash, rather than stock. This is a convenient arrangement that avoids having to deliver hundreds of stocks for one option exercise. For example, there are options on the S&P 500 index. Suppose that the index is trading at a price of 453.47. Then, if an S&P call option is exercised, rather than receive a few shares of each of 500 stocks—which would be a back-office nightmare—the person who exercises receives cash in the amount of \$45,347 (100 “shares” at 453.47) less the value of the strike price. If a Dec 400 call was being exercised, the call holder would thus receive a net of \$5,347 ( $\$45,347 - \$40,000$ ), less commission. The person who is

**Figure 1.2**  
**EXERCISE AND ASSIGNMENT OF CASH-BASED**  
**INDEX OPTIONS**

	<b>Call Option</b>	<b>Put Option</b>
<b>Exercise</b>	Receive Cash	Receive Cash
<b>Assigned</b>	Pay Cash	Pay Cash

assigned is *debited* a like amount of cash, plus commission. Figure 1.2 illustrates the exercise and assignment for cash-based options.

*American-style* options can be exercised at any time during their life. All stock options, ETF options, and futures options are of this type, as are OEX Index options. *European-style* options can only be exercised at the end of their life. Most index options are European exercise. In Chapter 5, accompanying the discussion of intermarket spread strategies, you will find an in-depth description of how European options behave.

Sellers of American-style options can be “surprised” by an assignment notice, because it can come at any time during the life of the option (there is usually one huge clue as to when such an assignment may happen, and it is that *the option no longer has any time value premium*). Writers of European-style options, however, know that they can only be assigned at expiration, so they can’t get called out of their position early. This is an important difference where index options are concerned because all index options are cash-based, and American-style index options can create rather nasty scenarios when assigned.

---

*Example:* Suppose that you own a spread in OEX options (which are cash-based and American-style): you are long the December 410 call and short the Dec 420 call, with the index trading at 440. Your spread is probably trading near its maximum value of 10 points (the differences of the strike prices). Then, you come to work one morning and find that

your Dec 420 calls have been assigned. Your account is debited 20 points cash (440 – 420) and you are now left with the Dec 410 calls long, all by themselves. You have gone from a hedged position with very little market exposure to complete market exposure from the long side. If the stock market, as measured by OEX, were to open down substantially on the morning that you receive your assignment notice, you could lose a lot of money very quickly.

---

For the reason described in the example, most index options were designed to be European-style so that these problems wouldn't occur. However, OEX options remain American-style, a sort of outlaw venue, where macho traders don't fear to tread. Since OEX options are the most heavily traded—and therefore the most liquid—index options, these situations arise quite often, especially shortly before expiration. In fact, it has become rather commonplace for arbitrageurs with large stock and OEX positions to attempt to influence the market so that they can favorably exit their positions via early exercise. These machinations are discussed in Chapter 3.

## **FUTURES AND FUTURES OPTIONS**

Since futures and especially futures options are less well-known to most investors, some time will be taken to describe them. First, let's discuss futures contracts; then we'll get to the options. As noted earlier, futures contracts are standardized, calling for the delivery of a specific amount of a commodity at some set time in the future. That "commodity" may be a physical commodity, such as corn or orange juice, or it may be cash, typically the case for index futures. Notice that there is no mention of anything like a "striking price" such as we have with options. Thus, futures contracts can rise infinitely and fall all the way to zero—owning one does not have limited risk like owning an option does. The margin required for a position in futures is generally much smaller than the actual value of the physical commodity underlying the futures contract—perhaps only 5 percent or 10 percent of the value. This makes the leverage in futures trading quite large, and consequently makes them a rather risky trading vehicle.

One of the things that makes futures so confusing to many is that there is no real standardization between the various commodities. What one might think of as the “expiration date” of a futures contract is typically referred to as the *last trading day*. The last trading day can vary widely within the expiration month, depending on which futures contract you are talking about. For example, March grain futures (corn, wheat, soybean) don’t necessarily expire on the same day of the month as March pork belly futures or March S&P 500 futures.

### **First Notice Day**

A more important date for a futures trader is actually the *first notice day*. For futures with a physical delivery, the first notice day is usually several weeks before the last trading day. *After the first notice day, the holder of a futures contract may be called upon to take delivery of the underlying physical commodity.* Thus, if a futures contract on gold calls for delivery of 100 ounces of a certain grade of gold, and you are long gold futures past the first notice day, you may have to accept delivery of 100 ounces of gold at the current market price. If the current price of gold were \$400 an ounce, that would require an investment of \$40,000. It was mentioned earlier that futures can be traded for only a small amount of margin, thereby creating huge leverage. However, after first notice day, many brokerage firms will require a much larger margin deposit because you are at risk of having to take delivery.

Normally, individual traders in the futures market are speculators who are not interested in taking or making delivery of physical commodities. They close out their positions in advance of first notice day. However, there is always the possibility that you could forget about the date and wind up being called upon to take delivery of some commodity. There are any number of false horror stories about someone having to take delivery of 5,000 bushels of soybeans and having them dumped in their front yard. These are patently false, but they make for good story telling, of course. In reality, your brokerage firm will make arrangements for a physical storage facility to take delivery in your name. You will then be charged fees for use of the storage facility, and any other related charges.



One trader that I knew had a position in gold futures that he rolled from month to month as each contract expired (that is, he sold the near-term month future that he owned and replaced it by buying the gold futures contract that expired in the next month). He figured it was cheaper to own gold in this manner than to actually buy gold and store it in a safe deposit box. He was very careful about rolling the futures out before the first notice day of the contract that he owned, but once he forgot and received a delivery notice.

His brokerage firm told him that they were taking delivery of the requisite amount of gold, in his name, in a depository in Philadelphia. He was assessed a fee of \$190 per contract for this service. Of course, since he didn't really want to take delivery of the gold, his broker had to sell out the physical gold and then replace it with futures in his account. This type of transaction is rather common and is called *exchanging physical for futures*. Selling the gold cost another commission, of course, but the net result was rather painless for him. He never actually had to take possession of the gold; he merely had to pay the handling fees for delivery and sale of the physical gold.

---

“First notice day” does not apply to cash-based futures, such as S&P 500 Index futures. In the case of that type of futures contract, there is no delivery; a cash settlement takes place on the last day of trading of the contract. Therefore, since there is no physical delivery taking place, there is no need for a first notice day.

## **Single Stock Futures**

In 2003, single stock futures were listed. These are futures that have as their underlying 100 shares of listed stock, such as IBM, Microsoft, or Amgen. These futures have all the qualities of a futures contract; that is, they require very low margin (20 percent), they can be sold on downticks, and they don't need to be borrowed in order to sell short. Moreover, the regulatory agencies have worked out the details so that a stock owner/trader/investor does *not* have to have a separate futures accounts in order to trade these (whereas he *would* need a separate futures account if he wanted to trade index futures). That works both ways, too, so a futures trader does not have to have a separate stock account in order to trade these single stock futures.

There are not single stock futures listed for every stock. In fact, in 2004, there were only a hundred or so. But if the product gains popularity in the future, there will be more. The actual stocks can easily be found via an Internet search, most likely on the sites of the two futures exchanges established specifically for the purpose of trading single stock futures: NQLX and OneChicago.

Single stock futures expire in various months: March, June, September, December, and the two other nearest months. They expire on the third Friday of the month, as options and index futures do; and they require physical delivery of the underlying stock if held to maturity. As opposed to most other futures contracts, there are no daily trading limits on single stock futures.

Although there was much fanfare in the introduction of this product, it has not yet proved to be very popular with traders. The extremely low margin—and, thus, high leverage—is apparently not conducive to what most stock traders are looking for. One of the supposed uses of this product was as a hedge. But if a person owns stock and then sells a single stock futures against that stock, he is not only hedged, he has effectively sold his stock position, for he can no longer profit or lose, no matter what the stock does. In reality, a *hedge* is best established with options (Chapter 3 discusses using options as insurance) so that a trader can limit his loss but still have room to make money from his stock holdings. Futures are *not* options; futures are much more like stock.

Perhaps this product will become more popular in the future, but to date it has yet to find an audience.

## **Volatility Indices and Futures**

A new product was listed by the CBOE in March 2004—futures on the volatility indices. These volatility indices are explained in much detail in Chapters 3 and 4; but for definition purposes, one needs to understand that the CBOE, mainly, as well as the AMEX publish indices that attempt to measure the implied volatility of index options. When the volatility index is high, then options are expensive; and when it is low, they are cheap, statistically. The first volatility index, VIX, was created in 1993 (although its price history was backdated to 1986).

For more than 10 years, one could observe VIX but could not trade it directly. It was, and still is, useful as a trading indicator (see Chapter 4), but it could not be bought or sold. Then, in 2004, the CBOE formed a futures exchange as part of its business and began trading futures on VIX.

While, at the time of this writing, it's too early to tell whether this will be a successful product, it certainly seems to have a large number of uses—from speculation to hedging for even the most conservative account—and, thus, this author feels it will be a success.

## **Futures Options Terms**

**Expiration Dates.** Futures *options* expire in advance of the first notice day, so that all option contracts are out of the way before physical delivery of the underlying commodity begins taking place. This is the reason that some futures options—those on physical commodities, such as soybeans, corn, orange juice, coffee—actually expire the month *before* the expiration month of the futures contract. Thus, March soybean futures options actually expire in February. Ask your broker, check *Futures Magazine* monthly, or check the web site of the appropriate futures exchange for the specific expiration dates of the various futures option contracts. Also, many futures chart books carry the expiration dates of the options. For those who prefer to see the nitty gritty details themselves, Appendix B has a list of when the futures options on most of the major contracts expire. For example, coffee options expire on the first Friday of the month *preceding* the expiration month of the futures contract. Thus, May coffee options would expire on the first Friday of April.

**Striking Prices.** As mentioned earlier, each different type of futures contract has its own set of striking (or strike) prices for listed options. For example, soybean option strike prices are 25 points (cents) apart, corn options are 10 points apart, pork belly options are 2 points apart, and so on. When first beginning to familiarize yourself with futures options, you are best served by obtaining an inexpensive source, such as *Investors Business Daily* newspaper, that lists all the current options on one page. It is then an easy manner to

observe where the strike prices are located for various futures contracts. For those traders with more sophisticated quote machines, an option “chain” is usually available that will display all currently traded options on a specific type of futures. For example, SIGNAL—a popular quote service that can be run on any computer—is one such source.

**Unit of Trading.** Every futures option has *one* futures contract underlying it; that is, if you exercise your futures option, it will convert into one futures contract. That is a simple concept; what is more complicated is remembering how many dollars are represented by a one-point movement of either the underlying future or the futures option. With stock and index options, a one-point move is normally worth \$100 (except in the case of stock splits, possibly). Futures options are less standardized. For example, a one-point (cent) move in grain options is worth \$50, while a one-point move in the S&P 500 Index futures is worth \$250. In every case, a one-point move in futures options is worth exactly the same number of dollars as a one-point move in the underlying futures contract.

Appendix B lists these dollar amounts for most of the major futures contracts. However, you can often determine this information from the newspaper listings of futures option prices. The newspaper normally lists the size of the underlying futures contract, in physical terms. The “dollars per point” can normally be determined by dividing the physical contract size by 100. For example, a soybean futures contract is for 5,000 bushels of soybeans, and that information will be listed in the newspaper right along with the prices. Dividing by 100, you arrive at the fact that a one-point (cent) move in soybeans is worth \$50.

**Price Quotes.** Traders of stocks are accustomed to being able to quote a bid-and-asked price for any stock or option they trade. In addition, any broker can obtain that information on his quote machine. Such is not the case with futures contracts nor with most futures option contracts. Rarely are you able to obtain a bid or offer quote for a futures contract on a quote machine. They can be obtained from the trading floor; but unless you are trading directly with the floor, in most cases it is too time-consuming to have your

broker request a quote, for there would be several phone calls involved in getting it.

The trading floors do supply quotes to the major quote vendors. However, they are often “stale” quotes, and one cannot really rely on them much of the time. Where options are concerned, I don’t recommend trading with market orders, so you need to know the option’s quote. One way to speed up the quote and order-entry process is to place an order at a price you would accept and to ask your broker to relay the *actual* market to you. In this way, your order is effective right away, and you get a quote back, too. If the actual market is far away from your order, then you can adjust the price on your order.

**Electronic Trading.** Futures can be electronically traded, but only a few markets are actually electronic. The most popular electronic market is that of the S&P e-mini futures on the Chicago Merc. It is a completely electronic market, and anyone with a quote machine can see the actual bids and offer (although not the size of them) at any time. These S&P e-mini contracts are worth \$50 per point of movement—one-fifth the size of the “big” S&P futures contract. The big S&P futures continue to trade at auction in the pit during the daytime hours; but at night, they, too, trade electronically on a system called Globex. Some other futures trade completely electronically, and more will surely follow as time goes by.

Be careful when trading with an “electronic futures broker,” though. Sometimes your electronic order merely prints out at a human’s desk, and then it has to be relayed to the trading floor. Because such a double order-entry process might actually cost you time, be sure to investigate how your electronic broker is actually getting the order to the floor—especially where the actual futures pit is *not* electronically enabled.

**Commissions.** In the futures market, commissions are generally figured as a constant dollar amount per contract. For futures contracts, commissions are charged only when your position is closed out. Thus, if you buy a futures contract on wheat, for example, you are not charged any commission at that point. Later, when you sell the futures contract, you will then be charged the commission. The

nomenclature to describe this process is *round turn*. If your commission rate is \$20 per futures contract, it is usually stated as \$20 per round turn.

Futures option commissions are normally a fixed amount as well, but they are charged on both the buy and the sell, just as stock commissions are. In some cases, brokers attempt to charge a percentage of the option's price, but that is not the norm.

The fact that futures and futures option commissions are normally fixed amounts means that they are more or less onerous depending on the contract being traded. For example, if you are paying \$20 per round turn and you are trading wheat (which is worth \$50 per point), then the commission represents a move of 0.40 point in wheat, which is a rather large commission in terms of the distance wheat must move to make the commission back. However, if you are trading S&P 500 futures, which are worth \$250 per point, then the commission only represents 0.08 point, which is less than one tick in the futures and is almost a trivial amount in terms of the future's price movement.

**Serial Options.** Futures contracts on the same commodity do not normally expire in every month of the year. For example, S&P 500 futures expire only in March, June, September, and December. Others may have five or six futures contract months per year. Experienced option traders know that most option trading takes place in the near-term contracts, especially as the options near their expiration dates.

The futures exchanges realized that activity would be lessened if the nearest term option had as much as two or three months of life remaining. So they decided to introduce options that expire in the months between the actual expiration months of the futures contract itself. These options are called *serial options*. They generally are only listed for the one- or two-month expirations preceding an actual futures expiration month. The futures contract that underlies a serial option is the actual futures contract expiring in the next actual month.

---

*Example:* S&P 500 futures expire in March, June, September, and December of each year. There are also futures options expiring in those months. Both the futures and the options are cash-settled and expire on the third Fri-

day of the month. Suppose that the current date is April 1. Then the nearest future expires two and a half months in the future, in the middle of June.

Since the S&P 500 futures contract is a very active one, there is naturally going to be great demand for trading of short-term options. Thus, the Chicago Merc (the exchange where these options are listed) began listing serial options. For example, the April S&P 500 futures options would expire on the third Friday of April; but instead of receiving cash when you exercise these options, you would receive a concomitant position in June S&P 500 futures. Assume you are long an S&P 500 April 460 call. If you exercise it, you would be long one June S&P 500 futures contract at a price of 460 in your account.

---

Serial options exist on the S&Ps, all the currencies, the grains, all the bond and note contracts, gold, silver, platinum, live cattle, pork bellies, sugar, and orange juice. It should be noted that not every futures contract will have serial options. Some don't need them; for example, crude oil and its related products and natural gas all have futures that expire each month of the calendar year, so serial options are not necessary for those futures. However, many of the others have serial options, although not all.

Remember, the easiest way to tell if serial options exist is to see if there are options with expiration dates that *don't* match the expiration dates of the corresponding futures contracts. If there are, then those options are serial options. This can easily be determined from the newspaper or from your quote machine, if you have access to one.

There are many other nuances of futures options that are different from stock or index options, but they are addressed in the specific chapters on strategy and trading that follow.

## **INFLUENCES ON AN OPTION'S PRICE**

As listed, but *not* in order of importance, there are six factors that influence the price of an option:

- 1.** Price of the underlying instrument.
- 2.** Striking price of the option.
- 3.** Amount of time remaining until expiration.

4. Volatility of the underlying instrument.
5. Short-term interest rates, generally defined as the 90-day T-bill rate.
6. Dividends (if applicable).

Each of these six factors has an influence on the price of an option. In some cases, the factor has a *direct effect*. For example, the more *time remaining* until expiration, the more expensive the options will be—both puts and calls. Conversely, as time decreases, so do option prices. Thus, option prices are directly related to the time remaining. Volatility is also a direct factor—the higher the volatility, the more expensive the options.

However, some of the factors have different effects on calls than they do on puts. Take *interest rates*. When interest rates are high, calls will be more expensive, since arbitrageurs can pay more for the calls that hedge their short stock. However, *puts* will become cheaper when interest rates increase, since arbs will pay less for them. Also having a diverse effect is the *underlying price* itself. For example, as the *underlying's price* increases, calls get more expensive while puts get cheaper. *Dividends*, also, have opposite effects on puts and calls. If a company increases its dividend, calls will be cheaper, and puts will get more expensive. This is because the listed options do not have any right to the dividend. The options' prices merely reflect what the stock price will do; and if the dividend is increased, it will drop farther when it goes ex-dividend. Thus, puts increase in value, to account for the expected ex-dividend drop in stock price, and calls get cheaper.

## Volatility

We discuss volatility at length in this book, so we want you to be clear about what it is. *Volatility is a measure of how fast the underlying changes in price*. If the underlying stock or future has the potential to change in price by a great deal in a short amount of time, then we say that the underlying is volatile. For example, over-the-counter biotech stocks are volatile stocks; orange juice futures in winter or soybean futures in summer are volatile as well.



There are two types of volatility that are pertinent to the discussion of option pricing. One is *historical* volatility, which is a statistical measure of how fast the underlying security has been changing in price. Historical volatility is quantifiable; that is, it is calculated by a standard formula, although some mathematicians disagree as to the best exact formula for calculating historical volatility. The other type of volatility is *implied volatility*. This is the volatility that is “implied” for future time periods, and the things that are doing the implying are the *listed options*.

The most startling example of implied volatility that I know of occurred during the crash of 1987. When implied volatility increases, the prices of all options increase as well. Thus, this trader received a pleasant surprise, one of the few pleasant surprise stories that relate to the crash of 1987.

---

On the Wednesday before the crash (10/14/87), OEX was trading at 295. A customer paid  $1\frac{1}{8}$  for the Dec 320 calls. These calls were trading with an implied volatility of about 15 percent, which was actually quite low for that era.

On the following Monday (10/19/87), the market crashed, and OEX was trading at 230. The customer figured he had lost his entire investment, and considering the large losses that others had taken, he was actually glad to have only lost a point and an eighth. He didn't even bother getting a quote on these options until Tuesday, the day after the crash, because he figured there wouldn't be any bid for them if he wanted to sell them.

What he didn't realize was that implied volatility had skyrocketed to nearly 50 percent for OEX options in the wake of the crash. The Dec 320 calls—now 90 points out of the money with less than two months until expiration—were trading at 1! Thus he had only lost an eighth. The power of implied volatility is great; it can even bail out losing trades sometimes.

---

Of course, most stories relating to the crash of 1987 were not so pleasant. In fact, one dogma circulating on the “street” was that “the crash of 1987 was so bad that even the liars lost money.”

Another example of the difference between implied and historical volatility occurred in the following litigation situation, where the possible outcome of a lawsuit caused implied volatility to inflate, while the actual volatility of the underlying was quite stable.

An example from early 1994 dramatically shows the difference between historical and implied volatility. Advanced Micro Devices is a maker of semiconductor chips. So is Intel, the leader in the field. Intel had filed a lawsuit against Advanced Micro, claiming patent violations, and the case went to trial. The news caused Advanced Micro stock to drop in price and then stabilize in the low 20s.

The resulting court decision was sure to have a large effect on the price of Advanced Micro. If the courts decided in favor of Intel, Advanced Micro's stock was destined to drop a lot; however, if the decision went against Intel, then Advanced Micro stock was destined to rise back into the 30s, where it had been trading prior to the lawsuit.

As the decision approached, the historical (or actual) volatility of Advanced Micro Devices stock was rather normal: the stock was trading back and forth from about 19 to 22. Thus, the stock was not acting very volatile because no one knew what the odds were of the stock moving up or down when the court handed down its decision; buyers and sellers were about in equilibrium. However, since the option prices were based on where the stock was going to be in the future, they were extremely expensive. For example, with the stock at 20, the calls expiring in one month were selling for over four points! This is extremely expensive for a one-month option on a \$20 stock. The puts were similarly expensive. Thus, the options were implying that there was going to be a big change in price by Advanced Micro Devices; or, alternatively stated, the options were trading with a high implied volatility. As it turned out, the court decided in favor of Advanced Micro, and the stock jumped six points higher in one day. After that, the option prices settled back down, and historical volatility and implied volatility were once again in line.

---

It is often the case that historical and implied volatility on a certain underlying issue are very nearly the same. Even when they differ, the reason is not normally as obvious as in the preceding example. In later chapters, we discuss how to measure these volatilities, how to interpret them, and what strategies to use when they differ.

You might think that it should be a fairly easy matter to determine the "fair" value of an option, given that the price is only dependent on the six factors listed earlier. Five of the six factors are known for certain at any one time. We certainly know the *price of the underlying*, and of course we know what the *strike price* is. We also know how much *time* is left until expiration of the option. Moreover,

it is a simple matter to find out where short-term *interest rates* are. And, if there are any *dividends*, it is an easy task to find the amount and timing of the dividend. The one factor that we can't quantify with any certainty is volatility, especially the volatility in future time periods. This, then, is the "rub" in determining the fair—or theoretical—value of an option. If we don't know how volatile the underlying security is going to be—that is, we don't know how much the underlying is going to change in price and how fast it's going to do it—then how can we possibly decide how much to pay for the option? The answer to this question is not an easy one, and we spend a great deal of time in this book trying to shed light on it.

## How the Factors Affect the Option Price

It was shown earlier that each of the six factors has its own effect on option prices. The following table, which shows what happens as each factor *decreases* (if the factor were to *increase*, the result would be the opposite of that shown in the table, in each case):

Factor	Time	Underlying	Interest	Dividends	Volatility
Call price	Decreases	Decreases	Decreases	Increases	Decreases
Put price	Decreases	Increases	Increases	Decreases	Decreases

Moreover, some of these factors are interrelated so that it is not necessarily easy to tell which is exerting more power at any time. For example, if a stock or futures contract rallies, we can't say for certain that a call will necessarily increase in value. If the strike price is too far above the current price of the underlying, even a rather large short-term rally may not help out the call much at all. This would be especially true if there were very little time remaining.

---

*Example:* Suppose a stock has been in a long bear market and is trading at 20. Then a rally sets in, and the stock jumps by 5 points to 25 in a day or two. Furthermore, suppose this happens with only a week or so remaining until the nearest expiration. The following data summarize this situation.

	February 7	February 9
Stock price	20	25
Feb 35 call	$\frac{1}{16}$	$\frac{1}{16}$
Aug 35 Call	$\frac{1}{2}$	$1\frac{1}{4}$

The Feb 35 call, which is going to expire in a little more than a week, was not helped out by the stock's jump in price; but the longer-term Aug 35 call *was* helped because there is more time remaining for the August option. So stock price, strike price, and time are all related in determining whether the value of an option would increase or not when the stock makes a favorable move.

---

## DELTA

Much more is said about the interdependence of these factors later, but first let's define some terms that are common among option traders. These terms describe just how much of an effect each factor has on the stock price. The best known such term is the *delta* of an option. *The delta of an option measures how much the option changes in price when the underlying moves one point.*

---

*Example:* XYZ is trading at 80, and the March 80 call is selling for 4. We observe that when XYZ rises one point to 81, the March 80 call now sells for  $4\frac{1}{2}$ . Thus, the option increased by a half point when the stock rose by one point. This option is said to have a delta of one-half, or 0.50.

---

The delta of a call option is a number that ranges between 0.00 and 1.00. To verify this for yourself, note that if a call is way out-of-the-money, it will not move at all, even if the stock rises by one point—the Feb 35 call in the prior example. Thus, the delta of a very deeply out-of-the-money call is 0.00. On the other hand, if the stock is trading far in excess of the striking price—that is, the option is way in-the-money—then the option and the stock move in concert. Thus, if the stock rises by one point, so will the option; hence, the delta of such a deeply in-the-money option is 1.00. The delta of a *put* ranges

between 0.00 and  $-1.00$ , reflecting the fact that the put moves in the opposite direction from the underlying security.

In between these two extremes (deeply out-of-the-money and deeply in-the-money), the delta of a call option ranges between zero and one. Call options that are out-of-the-money have small deltas, such as 0.25 or 0.30, meaning that they will increase by only about  $\frac{1}{4}$  or  $\frac{3}{8}$  of a point when the underlying stock rises by a point. In a similar manner, call options that are somewhat in-the-money will have higher deltas, such as 0.70 or 0.80, indicating that they will move much more like the common stock, but not *quite* as fast as the stock moves.

---

*Example:* The following table is an example of the deltas you might expect to see for various call options on a particular stock XYZ. As you will find out later, there are other factors that affect delta; but for now, we will just observe how delta behaves when we view the relationship of the underlying price and the strike price.

Underlying Price: 80                      Date: February 1

Call Option	Call Delta	Put Delta
May 70 call	0.94	-0.06
May 75 call	0.79	-0.21
May 80 call	0.58	-0.42
May 90 call	0.36	-0.64
May 100 call	0.20	-0.80*
May 110 call	0.10	-0.90*

---

The delta of a put and a call at the same striking price, with the same expiration date, are related by the general formula:

$$\text{Put delta} = \text{Call delta} - 1$$

There is an exception to this formula when the put is deeply in-the-money (the two asterisks in the preceding table). The deltas of stock or index puts, but *not* futures puts, may go to their maximum ( $-1.00$ ) well in advance of expiration, even when the corresponding

call option still has a positive, nonzero, delta. This has to do with the effects of conversion arbitrage. Thus, in the preceding table, the May 100 put and the May 110 put would probably have deltas of nearly  $-1.00$ , rather than  $-0.80$  and  $-0.90$ , respectively, as shown.

Did you notice that the delta of the at-the-money option is *not* 0.50? In fact, it is generally higher than that for any type of *call* option—stock, index, or futures (while it is lower for the put option). The reason for this is that stocks or futures can move farther to the upside (they can rise infinitely, in theory) than they can to the downside (they can only fall to zero). This means there is more than a 50-50 chance of prices rising over any extended time period, and thus the delta of the at-the-money call reflects this fact.

Some traders also think of the delta as a simple way of telling whether the option will be in-the-money at expiration. While this is not mathematically correct, it is sometimes useful. Thus, in the table, under this interpretation, we can say that there is a 20 percent chance that the stock will rise and be over 100 at May expiration, because the May call has a delta of 0.20. You may prefer to think of delta in this way, if it makes it clearer to you. There is really nothing wrong with this interpretation.

Understanding the concept of delta is mandatory for option traders, for it helps them to envision just how the option is going to move when the stock price moves. Since most traders have a feeling for what they expect of a stock when they buy it, or even when they buy the options, the understanding of delta can help them decide which option to buy.

## **What Affects Delta?**

Anyone who has traded options, or even thought seriously about them, realizes that an out-of-the-money option does not gain much value when the stock rises slightly; the at- or in-the-money option will rise faster than the out-of-the-money call option. This is true for both puts and calls. Delta gives us a way to measure these relative movements.

For example, suppose a trader were going to buy the stock in the previous example, and he was looking for a quick move of 3 points, from 80 to 83. How much will the May 100 call appreciate? The delta tells us that the May 100 will increase by about 20 cents for

each point that XYZ rises. The increase will then be  $3 \times 0.20$ , or 60 cents. Between commissions and the bid-asked spread in the option, there might not be much profit left if that option were bought; it just won't appreciate enough for a 3-point stock move. However, buying the at-the-money May 80 call should work just fine: it will appreciate by  $3 \times 0.58$ , or 1.74 points ( $1\frac{3}{4}$ ), which is a good move and should leave a good profit even after commissions and the bid-asked spread are taken into consideration.

Of course, if this trader were looking for a move of 20 points by the stock over the next three months, then the purchase of the out-of-the-money calls is more feasible. The trader must therefore adjust his option purchase with respect to his outlook for the underlying security, and the delta helps him do just that.

The previous examples demonstrate the relationship between the delta and the stock's price. However, other factors can influence the delta as well. One important factor is time. The delta of an option is affected by the passage of time. *An out-of-the-money option's delta will trend toward zero as time passes.* This merely means that an out-of-the-money option will respond less and less to short-term price changes in the underlying stock as the amount of life remaining in the option grows shorter and shorter. Sometimes it helps to envision things by looking at the extreme, or "end," points. For example, on the last day of trading, any option that is more than one strike out-of-the-money will probably have no delta at all—it is going to expire worthless and a one-point rise by the underlying stock will not result in *any* price change in the option. On the other hand, if an out-of-the-money option has a *long* time remaining (three years, say), then it *will* be responsive to movements by the underlying stock. *Thus, the more time value that an out-of-the-money option has, the farther its delta will be from zero.*

Just the opposite is true for in-the-money options: *the delta of an in-the-money option will increase to its maximum as time passes.* Again, thinking in the extreme may help. Any option that is more than just slightly in-the-money behaves just like the underlying on its last trading day. Thus, such a call would have a delta of 1.00, and a put would have a delta of  $-1.00$ . However, if there is a great deal of time remaining in the option (e.g., three years), even though it is in-the-money, it will have *some* time value premium. Conse-

quently, while its movement may reflect *most* of the price change of the underlying security, it won't reflect all of it, so its delta will be less than the maximum. *Thus, the more time value premium that an in-the-money option has, the smaller its delta will be.*

The delta of an option can change swiftly, sometimes apparently defying the elementary mathematical definition. These concepts are discussed in great detail in Chapter 6, but an example at this time may be sufficient to illustrate the point.

---

H. J. Heinz stock was the subject of takeover rumors in January 1995. Another food company had recently been acquired, and gossip swirled about the same thing happening to Heinz. As a result, options on Heinz had gained quite a bit of implied volatility. Takeover rumors often "heat up" on Fridays, as traders seemingly feel that there is a greater chance of a deal being announced over a weekend. Thus, it was not unusual that on a Friday, implied volatility reached a peak of about 50 percent. The accompanying table lists some of the option prices on that Friday, and then also shows where the same options were trading on the following Monday, when the stock closed off only  $\frac{3}{8}$  of a point.

---

	Closing Price Friday	Closing Price Following Monday	Change
Stock	$39\frac{1}{4}$	$38\frac{7}{8}$	$-\frac{3}{8}$
Jan 40 call	$15\frac{1}{16}$	$\frac{3}{8}$	$-\frac{9}{16}$
Feb 40 call	$1\frac{3}{4}$	$1\frac{5}{16}$	$-\frac{7}{16}$
March 40 call	$2\frac{3}{8}$	$1\frac{3}{4}$	$-\frac{5}{8}$

---

What was going on here? Each of these slightly out-the-money options was down *more* than the underlying stock. That is, each of these three options had a delta of more than 1.00! Normally, a slightly out-of-the-money option would have a delta of about 0.50 or less.

The actual delta of an option after any stock move can be computed by dividing the option's price change by the stock's price change. This simple calculation yields the following deltas for the preceding options:

<u>Option</u>	<u>Actual Delta</u>
Jan 40 call	1.50
Feb 40 call	1.17
March 40 call	1.67



In fact, what had happened was that a negative newspaper article appeared over the weekend. The article basically denigrated the takeover rumors and gave evidence that the company was *not* “in play.” Thus, even though the stock itself only traded off three-eighths of a point, the options were crushed as implied volatility fell to about 35 percent from the 50 percent level of Friday. That is a huge change in implied volatility in one day, and it had a very harmful effect on the call prices. This is a vivid example of how a change in implied volatility can affect the price and the delta of an option.

---

Thus, there is a relationship between price and volatility. It is a well-known fact that a change in one of these factors can affect an option’s price. What is sometimes forgotten is that these factors can work together to dramatically affect an option’s price, as in the Heinz example. Both volatility and stock price can change dramatically in a short period of time. The other three factors that determine an option’s price—short-term interest rates, striking price, and dividend—have little or no effect most of the time, for they don’t change much, and certainly not over a short time period.

## TECHNICAL ANALYSIS

There are two major approaches to analyzing markets—technical and fundamental. Most investors are familiar with *fundamental analysis*, that is, the process by which analysts attempt to forecast the future profits of a company by analyzing their market penetration, pricing structure, and other things having to do with the actual operation of the company’s business. *Technical analysis*, on the other hand, has nothing at all to do with the tangible operations of the company. Rather, it is an analysis of the *price* of the company’s stock. Technicians (practitioners of technical analysis) feel that past price patterns leave valuable clues as to the future direction of prices. Technical analysis can be applied to any price pattern—stock, bonds, futures, and so on.

There is merit in both camps, although each camp tends to view the other as being somewhat inferior. This is a classic example of how each camp was “right” and yet each thought the other was wrong.

In 1991, the market was beginning to roll to the upside after the Gulf War was “won.” Many brokerage firm analysts were predicting great things for basic U.S. companies, such as Coca-Cola. Earnings were projected to increase for each of the next few years.

Technicians, however, were more interested in what the *market* was saying about Coke. The market’s opinion is, of course, registered in the price of stock on a day-to-day basis. In this instance, Coke had traded up to a price of 44 several times but had never been able to go higher. Thus, a technician would have said that while he might believe the fundamental analysts’ prediction of good fortune for the future earnings of the company, he would not buy the stock until its price could actually go higher than 44.

That would have been a good strategy, for it wasn’t until over two years later that Coke actually traded higher than 44—after repeatedly trying to exceed that level, but failing. A technician would thus have saved his investment capital until the stock price had some momentum.

---

Technical analysis is more apropos to short-term trading, since it attempts to give some timing on when to buy and when to sell. Fundamental analysis is a good long-range tool, but on the short run it is often woefully late (or way too early) in predicting the actual movement of stock prices; it is therefore a poor technique for timing. Fundamental analysts attempt to predict whether the tangible business operations of a company will make money. However, that information is only vaguely related to the price of a stock in the short term. Most option trading strategies are of a short-term nature, so fundamental analysis is almost useless, and technical analysis is a better approach.

Fundamental reports, however, can and do have an effect on the short-term trading of a stock (in Chapter 4, we examine ways to take advantage of this phenomenon). This usually happens when a company announces quarterly earnings that are significantly different from what the analysts have been expecting. A worse-than-expected earnings report will inevitably cause a stock to drop as soon as the information is made public, while better-than-expected earnings will normally cause the stock to rise in price immediately.

Don’t confuse the market’s short-term reaction to these fundamental reports with fundamental analysis itself. In fact, had the analysts been able to correctly predict the earnings, there would have

been no “surprise.” This is particularly true when the earnings are bad. Usually, by the time that Wall Street analysts change their opinions from positive to negative on a stock, it is too late to benefit stockholders. How many times have you seen a company report surprisingly bad earnings, which causes the stock price to immediately drop, and *then* all the brokerage firms downgrade the stock? Or how about a stock falling from lofty levels—perhaps by as much as 50 percent—and then a brokerage firm downgrades it from “buy” to “hold”? Of what use is that to a short- or intermediate-term trader?

Thus, fundamental analysis may be more appropriate for the long-term picture, but it is not useful for short-term decision making. The following story shows the difference between fundamental and technical analysis quite clearly.

---

Recently, I read an article that was originally published in 1948, regarding the price of Coca-Cola. The article stated that the price of Coke—which had rallied strongly following the end of World War II—was discounting all of the good fortune in the foreseeable future. Fundamental analysts disagreed, arguing that Coke was on its way to becoming a world leader in soft drinks (at the time, Coke was sold mostly in the United States).

In fact, the inflation-induced recession of 1948 *did* harm the price of Coke and it dropped 30 percent; but today it is many, many times its 1948 price. So, for the long term, fundamental analysts were right; but on the short term, technicians were correct.

---

Since many of the strategies presented in this book are of a short-to-intermediate-term nature, we favor technical analysis for that purpose. Technical analysis bases its price projections for the future on past prices, moving averages, or volume considerations. These are valuable tools in many cases, and we discuss them in detail as they arise in the context of the option strategies that we are presenting.

This chapter has covered a lot of ground in a short amount of space. Definitions, price behavior, and relationships of the variables affecting option prices have all been described. This has laid the groundwork for most of the later discussions in this book. In the next chapter, we take a look at various option strategies.

# 2 An Overview of Option Strategies

Even though the main thrust of this book is modern option trading applications, we want to cover the basics in terms of strategies. The purpose of this chapter is twofold: (1) it will serve as a foundation of definitions for terms used later in the book and (2) it may serve as a learning or reference section, depending on the reader's previous knowledge of option strategies. Each of the major strategies is briefly described, with an example and a graph showing the strategy's profit and loss potential.

## PROFIT GRAPHS

Some traders prefer to see columns of numbers, and others—myself included—prefer to look at graphs or charts. A “profit graph” is a graph of the potential profits and losses from a position. With options, it is possible to describe most of the major strategies by the shape of their profit graphs. A simple example should be sufficient to demonstrate the concept.

*Example:* Suppose that XYZ common stock is trading at 50, and the XYZ July 50 call is selling for 3, or \$300. The profit *table* shown here details the potential profits and losses at various XYZ prices at July expiration. The same information is shown in the profit *graph*, Figure 2.1, which shows that this position has a limited loss on the downside and can make theoretically unlimited profits on the upside.

At July Expiration		
Stock Net Price	Call	
	Price	Result (\$)
40	0	-300
45	0	-300
50	0	-300
53	3	0
55	5	+200
60	10	+700
70	20	+1,700

**Figure 2.1**  
**CALL PURCHASE**

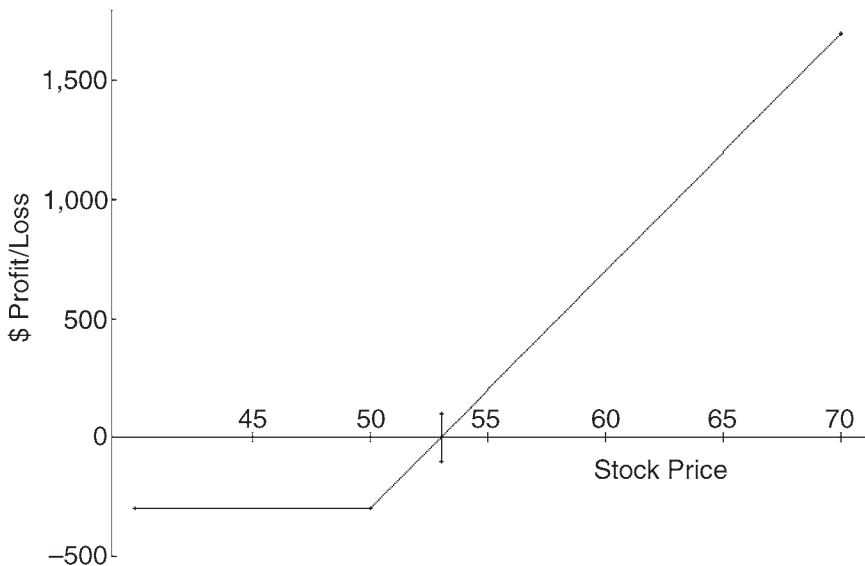

A quick look at the graph is all that is needed to understand the nature of this strategy. When the graph is labeled with the dollar amounts of risk and profit and with the break-even point, then we have a specific graph of this particular call option purchase. Thus, the profit graph can be generic or specific, depending on whether or not the axes are significant profit and loss points.

## OUTRIGHT OPTION BUYING

The outright purchase of an option is the simplest type of option trade for most traders to understand, and some prefer to go no further. When we say “outright,” we are referring to an option purchase that is not hedged by anything else, such as the sale of a similar option or the sale of stock. In the preceding example, the purchase of the XYZ July 50 call for 3 has several definable qualities that are fairly easily understood by most traders. First, the cost of one option is \$300, and that is the most that can be lost. Second, the break-even point at expiration is 53 (plus commissions), for a call option is always worth at least the difference between the stock price (53) and the striking price (50). Third, nearly unlimited profits are available, for the option will appreciate in price as long as the underlying stock, XYZ, continues to rise in price.

This is typically felt to be an aggressive strategy, because the leverage is so high. You can lose all your money in a fairly short amount of time if the option expires worthless. In the preceding example, if the stock drops at all from the price of 50 (where it was trading when the option was purchased) by expiration, the option will expire worthless, and the trader will lose the \$300 he paid for the call. Leverage works both ways, of course, and thus huge percentages are possible as well. For example, if the stock were to advance by only 20 percent (from 50 to 60), then the option would be worth \$1,000. So the stock trader would make 20 percent, while the option trader would make 233 percent (\$300 becomes \$1,000) from the same stock movement.

Before discussing option buying in more detail, let's look at an example of a put purchase. Since the put gives the holder the right to *sell* the underlying strike at the striking price (up until the expiration date), this is a bearishly oriented strategy. The put option will

appreciate in value if the stock falls and will lose value if the underlying stock rises in price.

*Example:* Suppose that XYZ common stock is trading at 50, and the XYZ July 50 put is selling for 2, or \$200. The profit table and profit graph (Figure 2.2) are shown below.

At July Expiration		
Stock Net Price	Put Price	Net Result (\$)
30	20	+1,800
35	15	+1,300
40	10	+800
45	5	+300
50	0	-200
55	0	-200

**Figure 2.2**  
**PUT PURCHASE**

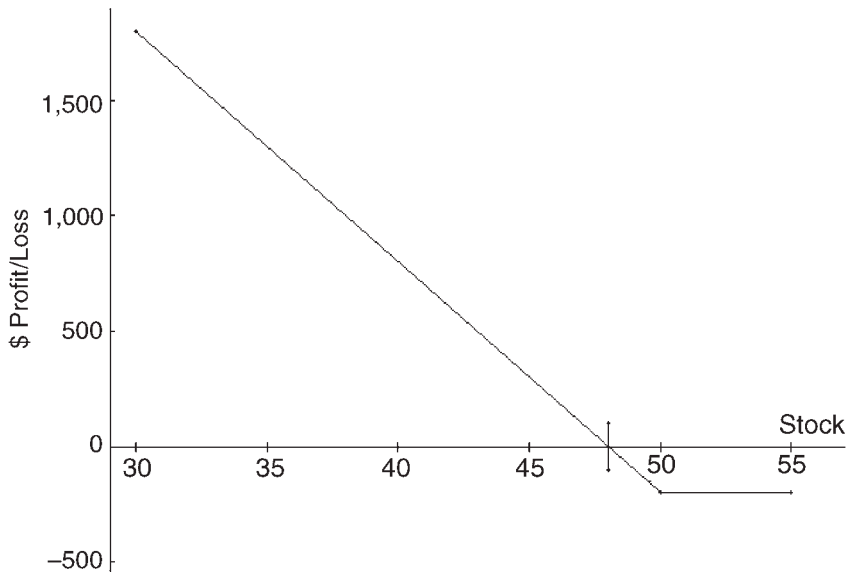

Figure 2.2 shows that this position has a limited loss on the upside and can make very large profits on the downside.

---

Many experienced traders prefer option purchases to stock purchases, however, because they feel that if they can pick a reasonable percentage of trading winners—perhaps only 30 percent or 40 percent—the leverage provided by the winning trades will outweigh the more frequent but limited losses incurred by the losing trades. The key in such a strategy is to be able to let profits run when they occur.

Buying options is often regarded as one of the most speculative trading activities. However, there are often differing ways in which to establish a strategy. These differing ways may change the speculative to the conservative, or at least moderate things somewhat.

Before actually discussing the type of option you should purchase, it must be stated that the outlook for the performance of the stock is of utmost importance. *If the underlying stock drops in price, you are not going to profit from a call option purchase, no matter which call you buy.*

The main attraction for buying options—at least to the average or novice trader—is the leverage that is available. You can put up a fairly small amount of money (a couple of thousand dollars) and make returns in the 200 percent or 300 percent area. Of course, you can lose 100 percent fairly quickly as well.

In this regard, many novice traders buy out-of-the-money options in order to keep their cost down. They then dream of huge potential returns, but these returns are usually attainable only if the stock can make a rather large percentage move. To make matters worse, the typical buyer of out-of-the-money options buys options that have too short a life span—he does not give the stock enough time to make the large move that is required.

Over the years, I have spoken to numerous stock traders who have given up on options. They feel that they can make money trading stock but always seem to lose when options are concerned. Their problems generally result from one mistake: buying too far out-of-the-money.

Professional stock traders often use options for one purpose only: to reduce their required investment in a position. They are not



attempting to capture huge leveraged returns; rather, they are merely using the option as a substitute for the stock itself. *In order to create an option position that is virtually the same as a stock position, you should buy in-the-money options, probably with little time remaining.* Moreover, if a professional normally trades 2,000 shares of stock, then he would probably buy 20 in-the-money calls; he does not usually attempt to leverage the quantity—the leverage is in the price.

By buying in-the-money options, you are minimizing the amount of money spent for time value premium. Time value premium is the part of an option that wastes away as time passes. Out-of-the-money options are *entirely* composed of time value premium. In-the-money options may have little or sometimes even no time value premium.

Also, the in-the-money option will most closely match the performance of the underlying stock on a day-to-day basis. If the stock is up a point, the in-the-money call option will probably rise in price by at least three-quarters of a point or more. The out-of-the-money option may not move much at all. Of course, this fact could work against the call option holder if the stock moves *down* in price. That is why we originally stated that stock selection is of the utmost importance. An example may be helpful.

---

*Example:* Suppose that you have decided that XYZ is a good stock to buy for a short-term trade, and the stock is selling for 19 per share. If today were the first trading day of the year, which option would you buy?

Call Option	Offering Price
Jan 15	4
Jan 17½	2
Jan 20	½
March 17½	2½
March 20	1⅛
March 22½	½

The professional stock trader would buy either the Jan 15 call (which has no time value expense at all) or the Jan 17½ call (which has a half point of time value, but is 1½ points in-the-money and will move upward quickly if the stock advances).

The novice would be more inclined to buy the cheapest options (either the Jan 20 or the March 22½, both trading at ½) or maybe the March 20s.

---

In the preceding example, suppose the stock makes a quick move to 21—a 10 percent increase. The professional will make 2 points on the purchase of a Jan 15 call or 1½ points on the purchase of a Jan 17½ call—returns of 50 percent or 75 percent, respectively. The novice might have a larger percentage return, but he might actually make less money because it is unlikely that he would buy such a large quantity of out-of-the-money options that he would make more money than the trader who bought, for example, 20 in-the-money calls.

In order to quantify these concepts, you can judge how aggressive your option purchase is merely by looking at the delta of the call being bought. *The lower the delta, the more aggressive the option purchase.* If you think of the delta as being the probability of the option being in-the-money at expiration—which is an alternative, but still correct, way of viewing delta—you can see how speculative an out-of-the-money option purchase is.

Even if you do correctly predict the direction of the stock and your option purchase is profitable, you must be prepared to take follow-up action to lock in your profits where applicable. One of the easiest ways to lock in some profits while still retaining potential, is to sell out part of your position after gains have been made. This works for any type of investment—stock, options, futures, bonds, and so on. The biggest problem with doing that is that if really large gains occur, you have reduced the quantity of shares or contracts that you own and you therefore don't participate as much as you could have on the upside.

However, options actually sometimes provide a fairly easy means of having your cake and eating it, too—you can nail down some nice profits, but still preserve your “presence” in the stock. All that is required is to so sell the options you already own (and that are profitable) and buy the same number of options at the next strike. This is best accomplished when the stock has already reached the next strike, so that you are selling an in-the-money option and buying an at-the-money one.

*Example:* Suppose that you bought 10 XYZ June 20 calls for 2 each when the stock was 21. This costs \$2,000 before commissions. XYZ subsequently rallies to 25, and your calls are now worth 5 (at least). Upon investigation, you see that the July 25s are selling for 1½. You could therefore do the following:

Sell 10 June 20 calls at 5: \$5,000 credit  
Buy 10 July 25 calls at 1½: \$1,500 debit

You therefore take a nice healthy \$3,500 credit out of the position, less commissions—which more than covers your \$2,000 initial cost—and you still have 10 long calls in case the stock explodes on the upside. The worst that can now happen is that the July 25s expire worthless, if the stock takes a dive. However, you have locked in a profit already, so that needn't overly concern you.

---

## **USING LONG OPTIONS TO PROTECT STOCK**

Another advantage of owning options is that they can be combined with stock or futures to produce a position that has much less risk than that of the underlying. Long puts can be bought as a hedge against the downside risk of owning stock, or long calls can be bought as a hedge against the risk of selling stock short.

### **Buying Puts as an Insurance Policy for Long Stock**

If a trader wants to protect against the downside risk of owning stock, he can buy a put against that stock. The ownership of the put will eliminate much of the downside risk, while still leaving room for plenty of gains on the upside.

---

*Example:* Suppose XYZ is selling for 51 and the July 50 put is selling for 2. If you buy 100 shares of stock and also buy the July 50 put, your profit potential at expiration would be the figures depicted in Table 2.1, or shown

in the profit graph in Figure 2.3. Note that the position has limited risk, equal to the initial cost of the put (2 points) plus the amount by which the put was out-of-the-money (1 point). Moreover, it has unlimited upside profit potential, which is almost as large as that of owning the stock itself.

**Table 2.1**  
**LONG STOCK/LONG PUT PROFIT POTENTIAL**

Stock Price	Long Stock Profit (\$)	Option Price	Long Put Profit (\$)	Net Profit (\$)
30	-2,100	20	+1800	-300
35	-1,600	15	+1300	-300
40	-1,100	10	+800	-300
45	-600	5	+300	-300
50	-100	0	-200	-300
55	+400	0	-200	+200
60	+900	0	-200	+700
70	+1,900	0	-200	+1,700

**Figure 2.3**  
**LONG STOCK/LONG PUT**

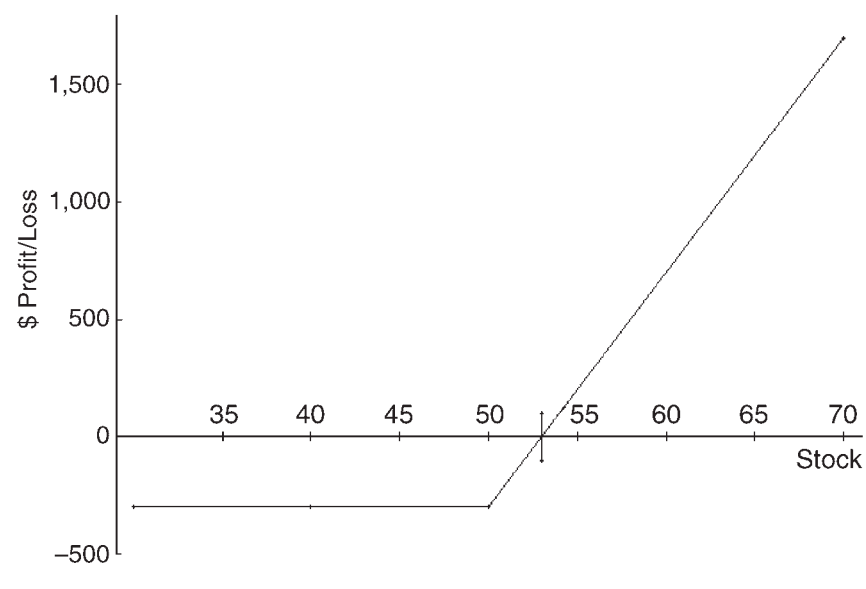

One other item is important: note that the *shape* of the profit graph of this position is exactly the same as the shape of the profit graph for owning a call. When two strategies' profit graphs have the same shape—as do call buying and this strategy of protecting long stock with a long put—then the two strategies are considered to be *equivalent*, which means they have the same profit and loss potential. We discuss equivalences repeatedly in this chapter. Note that just because two strategies are equivalent doesn't mean they have the same rates of return. For example, the cost of buying a call is far less than the cost of buying both 100 shares of stock and buying a put.

When you consider buying a put to protect a holding in your stock, you have several things to consider, just as you do with another form of “insurance.” How much coverage do you want, how long a time period does the insurance cover, and how much are you willing to pay? Since options have varying expirations—even going out to two years or more with LEAPS options—as well as several striking prices, usually there are many choices. You might consider the amount by which the put is out-of-the-money as the “deductible” portion of your insurance policy.

A very short-term insurance policy that has a large deductible is not very expensive. Thus, if XYZ were at 51 in April, then the purchase of a July 45 put would represent a rather short-term, large-deductible insurance policy. However, a two-year LEAPS put with a striking price of 50 would be a much more expensive form of insurance because (1) it is long-term and (2) there isn't much of a deductible (only one point).

This strategy was employed, but rather rarely, back in the days of over-the-counter options, prior to the 1973 introduction of listed options. The first listed options were only calls (puts weren't listed until 1976, and then only on 25 stocks). Thus, in the early days of listed options, investors were forced to use covered calls as their only real means of lessening the downside risk of stock ownership.

---

The introduction of listed options coincided fairly closely with the 1973–1974 bear market that saw the Dow Jones Industrials decline from 1,000 to about 580 in a matter of approximately one year. The havoc wreaked on some of the “high-flying” stocks was even worse than the more than 40 percent loss suffered by the averages. The “nifty 50” stocks were supposed

to be a group that would outperform the regular market, regardless of bull or bear markets. These stocks were very overpriced and eventually suffered some of the worst declines of that bear market.

One trader owned Polaroid at about 150 a share at the beginning of that market and wrote covered calls against it all the way down to its eventual low of 15! He claimed that he was able to protect nearly 75 percent of the loss with covered calls, a figure that may be a *slight* exaggeration—all trading stories grow in stature as the years pass—but is probably not a gross exaggeration. This shows just how expensive call options were in those early years (recall, there were no listed puts). It also reflects how large the volatility of that 1973–1974 market became as the months wore on.

---

In today's market, of course, option premiums are much smaller, and investors do not view covered call writing as providing much more than a modicum of downside protection. Today's strategy of insuring your stock holding by buying puts has become more and more popular since the crash of 1987. The main problem is that the protection is static; that is, if the underlying stock were to rally by a substantial amount after the insurance was purchased, the "deductible" portion of the policy becomes huge. For example, with XYZ at 51, if the stockholder initially bought the LEAPS put with a striking price of 50, his deductible was one point. If the stock then proceeds to rally 20 points to 71 over the next year, his policy is still in force, except that the deductible is now 21 points since the put *still* has a striking price of 50. The only way to "upgrade" the insurance would be to sell the original put and then to buy another put with a striking price closer to the current stock price.

Some money managers and individuals with large holdings have found that it is easier to buy index puts on a sector or broad-based index whose characteristics more or less match those of their stock portfolios. Then, they can buy all of their insurance at once—puts don't have to be bought individually for each stock in the portfolio. This subject is covered in more detail in the next chapter.

## **Buying Calls to Protect Short Stock**

Selling stock short is often considered a somewhat sophisticated strategy because theoretically there are unlimited risks involved. The

stock could soar in price and cause large losses. While it is usually the case that a trader can limit his risk with stop-loss orders or by paying attention to the market on a constant basis, it is sometimes easier for the short seller to know for certain that he has a limited loss even if the stock soars mightily. He can accomplish the task of limiting his loss by merely buying a call—probably an out-of-the-money one—against his short stock. Then, even if there were a high-priced takeover bid for the company, his loss would be limited on the upside. Thus, a long call acts as insurance against large loss for a short seller, much in the same way that the *stockholder's* loss was limited by the ownership of a put in the previous section.

The profit graph of the long call/short stock position is presented in Figure 2.4. Note that its shape is the same as that of merely owning a put. Thus, long put is equivalent to long call/short stock. As a result, the strategy is also known as a *synthetic put*.

In fact, when options were first listed—and for the ensuing three years—there were only listed *calls*. Thus, the only way that you could have large downside profit potential with limited risk was to utilize this long call/short stock strategy. Even when puts first were listed in

**Figure 2.4**  
**LONG CALL/SHORT STOCK**

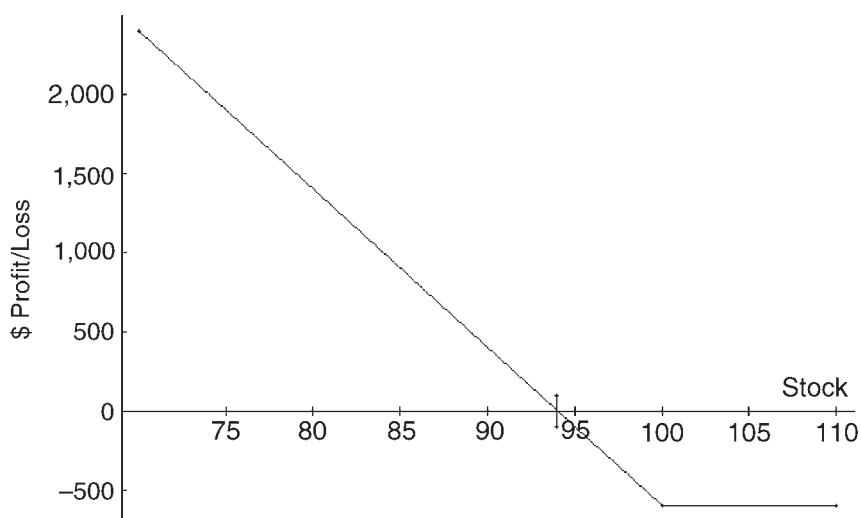

1976, there were only 25 stocks that had listed puts trading. If you wanted a position that was similar to owning a long put in any of the other optionable stocks, you still had to short the stock and buy a call.

The strategy was widely used, especially by professionals and arbitrageurs, and its name was shortened merely to “synthetic.” If you were “doing synthetics,” you were setting up a sizable position of short stock and long calls, for the purpose of making an arbitrage profit via the interest earned on the short sale, and/or for the purpose of capitalizing on the collapse of the stock price. Today, since all stocks with listed options have both a listed put and a listed call, this strategy is no longer as widely used as it once was.

## **BUYING BOTH A PUT AND A CALL**

In some cases, a trader may feel that there is the potential for explosive movement by an underling instrument, but he is uncertain of the direction that that movement might take. In such a case, he might consider buying *both* a put and a call with the same strike—a straddle. Then, if there is a large move—either up or down—he will make money. The drawback, of course, is that nothing much happens and time decay eats away at both the put and the call. This strategy has profit potential as shown in Figure 2.5; the maximum loss, which is equal to the initial premium paid, would be realized if the stock were exactly at the striking price at expiration. However, the possible rewards are large if the stock rises or falls far enough by expiration.

As a general rule of thumb, this is a strategy that should only be undertaken if two conditions are met: (1) the options are inexpensive on a historical basis (we have more to say about how to judge this condition in later chapters) and (2) the underlying has a history of being able to move distances large enough to make the straddle profitable.

Markets have a tendency to trade in small increments most of the time and then to make most of their ground in a very short period of time. Studies have been done that show that 90 percent of the gains are made in only 10 percent of the trading days (other studies show similar figures for downside moves as well). It is often the case that options get very cheap just before large moves. This is especially true if the market has been rather trendless for a while just before a big



**Figure 2.5**  
**STRADDLE PURCHASE**

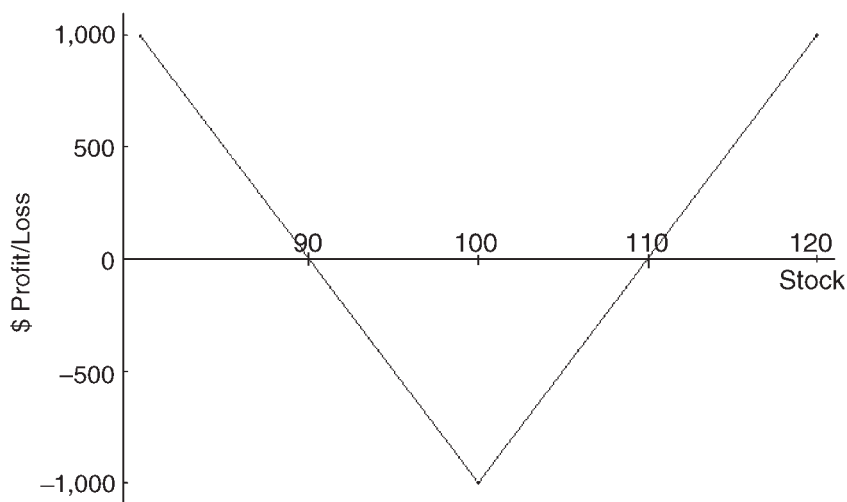

move occurs; option buyers are losing money to time decay and therefore are less aggressive in their bids for options, while option sellers become more aggressive as their profits build up. There have been many examples of options getting “cheap” just prior to large market explosions. One of the most famous was the cheapness of index options just prior to the crash of 1987, but there are many other instances as well, both in stocks and in futures. In fact, you might think that buying straddles works best just before big market declines because option prices tend to expand very quickly during declines (in stocks and indices). However, two of the swiftest rallies we have had since index options were listed were both preceded by very cheap options—one rally was in August 1983, and the other in the first half of 1995—and straddle buyers profited handsomely.

When the put and the call that are purchased have the same striking price and expiration month, you are buying a straddle. If they have different striking prices, you are buying a strangle, or combination. The straddle purchase usually involves more risk in the worst case; however, it has better profit potential. The two profit graphs, Figures 2.5 and 2.6, compare the profitability of straddle buying and

**Figure 2.6**  
**COMBINATION (STRANGLE) PURCHASE**

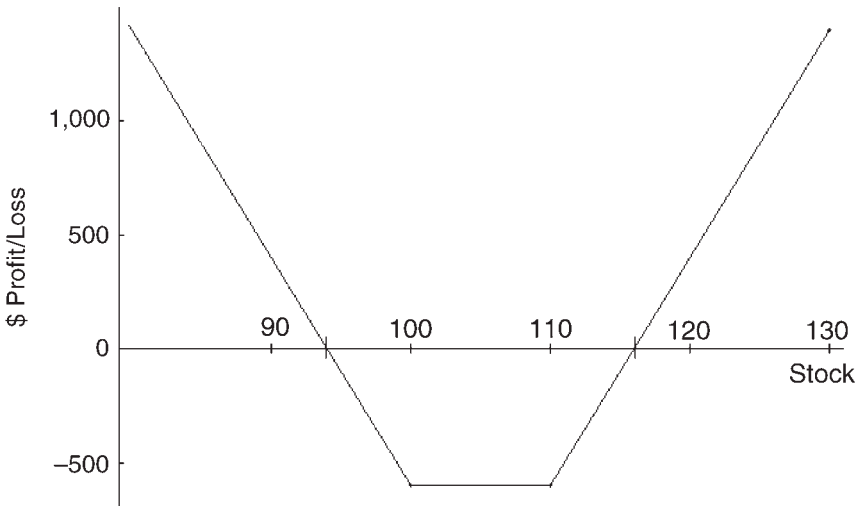

combination buying. It has been my experience that if you have determined that you want to buy options in advance of what you perceive to be a potential price explosion by the underlying, you are better off buying straddles than buying combinations (strangles).

## SELLING OPTIONS

Just as with any other type of security, the initial, or opening, option transaction may be a sale rather than a purchase. When you do that with a stock, you must first borrow the shares before you can sell them "short." However, with options or futures, that is not necessary. The mere option transaction itself creates a contract, so that the buyer of the option is *long* the contract and the seller of the option is *short* the contract. The common term to describe the sale of an option as an opening transaction is to say the option has been *written*. This term comes from the old days when a physical contract was issued by the seller and delivered to the buyer. In today's paperless trading world, there is no longer any physical contract, but the term remains.

## Covered Call Writing

When you write a *covered call*, you own the underlying *and* have sold a call option against it.

---

*Example:* Assume that XYZ is trading at 51 and a July 50 call is selling for 4. If you bought 100 shares of XYZ and sold one July 50 call, you would have a covered write with the following profit potential *at July expiration*:

---

Stock Price	Stock Profit (\$)	Option Price	Option Profit (\$)	Total Profit (\$)
40	-1,100	0	+400	-700
45	-600	0	+400	-200
50	-100	0	+400	+300
55	+400	5	-100	+300
60	+900	10	-600	+300

---

Figure 2.7 shows the same results as in the example profit table. Covered call writing is considered to be a conservative strategy. There is limited upside profit potential and rather large downside risk. The profit potential is limited because the trader has written the call and therefore has assumed the obligation to sell his stock at the striking price should he be assigned on the call. The risk of covered writing is less than that of owning the common stock, although that risk can still be considerable if the stock falls by a great distance. It is this reduction in risk that has made covered writing a “conservative” option strategy not only in the eyes of institutional money managers but in the eyes of the courts as well.

Covered call writers are usually interested in two numbers: (1) the kind of return that would be made if the underlying stock were called away at expiration (called the *return if exercised*) and (2) the kind of return that would be made if the underlying stock were unchanged at expiration (called the *return if unchanged*). Of course, opinions of what is an acceptable return would probably differ depending on whether the stock were being bought specifically for the purpose of

**Figure 2.7**  
**COVERED CALL WRITE**

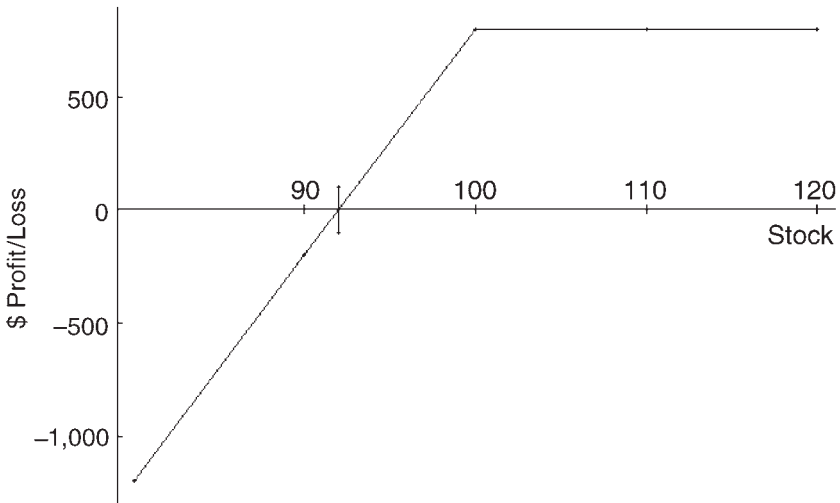

writing calls against it or whether an existing stockholder was writing calls against his long stock. The former probably represents the operation of the entire position as a strategy, while the latter may just be looking for a little additional income without really wanting to sell his stock.

There is an inherent attraction in selling options, since an option is a wasting asset and the writer enjoys the benefit of the time decay. This seems especially true to those who have suffered substantial losses due to time decay from owning options. As we pointed out earlier, option buyers who lose too much due to time decay are probably buying options that are too far out-of-the-money. Unfortunately, writing a deeply out-of-the-money option, while it will probably expire worthless, is not really a very conservative way to approach covered call writing. The minimal amount of premium brought in by such an approach does not provide much in the way of downside protection. As with any strategy, covered writing can be operated in a conservative or an aggressive manner; the writing of deeply out-of-the-money calls is an aggressive approach.

A quite conservative covered write can be constructed by selling an in-the-money call against long stock. In such a case, there is

downside protection all the way down to the striking price of the written option, which can be a considerable distance below the current stock price. Of course, the return from such a strategy is not going to be huge on the upside, but it is sometimes surprisingly large when you consider that the hefty call premium you receive can be used to reduce the cost of buying the stock.

Overall, covered writing is usually employed as a moderately bullish strategy, so that one can make money if the stock rises or remains relatively unchanged until expiration. What is sometimes forgotten is that this is *not* a very good strategy for bear markets, for stocks will normally fall faster than the protection provided by the limited amount of premium from the written call. Advocates of the strategy will say that even in a bearish scenario, all you have to do is keep writing calls at lower strikes and eventually you will collect enough premium to recoup your losses. However, if after a stock falls quickly, you write a call with a lower strike and then the stock rallies back quickly, you will surely have locked yourself into a loss no matter how large the premium you took in.

In summary, then, covered writing is a strategy designed to do best when stock prices are stable or moderately rising. If the underlying stock is, or becomes, volatile, this is not an attractive strategy because you cannot participate in large moves on the upside, but you *will* suffer the results of any large move to the downside.

## **Naked Option Writing**

When an option is written without any offsetting position in the underlying stock, or without being hedged by a similar long option, that option is considered to be written *naked*. In general, naked option writing is considered to be risky because you can make only a limited amount of money, yet could lose large sums if the underlying stock or futures contract moved so far that you were forced to buy the option back for a great deal of money. In general, larger margin and equity requirements are required by most brokerage firms before they will allow a customer to participate in the sale of naked options as a strategy. Yet, in the next few sections, we see that naked option writing may not be all that risky if approached in a reasonable manner.

The “investment” required to write a naked option is somewhat different from that required for buying stock or options. You must have collateral of a sufficient amount to cover your risk in the eyes of your broker. Currently, if you are writing naked *stock* options, you must have collateral equal to 20 percent of the stock price, plus the premium of the option, less any out-of-the-money amount.

---

*Example:* Suppose XYZ were a \$100 stock, and you wanted to write one July 110 call naked for a premium of 4 points. You would need to have the following collateral:

\$2,000	(20 percent of the value of 100 shares of XYZ)
-1,000	(the amount by which the call is out-of-the-money)
+400	(the premium of the option)
<u>\$1,400</u>	

---

There is a minimum collateral requirement that you must meet, which is 10 percent of the underlying price, no matter how far out-of-the-money the option is when initially written. Since the option premium is credited to your account when you sell the option, you can apply it toward your initial collateral requirement.

What is *collateral*? It's any type of equity in your account that is not already borrowed against; it could be cash or any marginable security, such as stock, bonds, or government or municipal debt securities. Note that you are not charged any interest for the naked option collateral requirement, as you would be if you were buying stocks on margin, for you are *not* borrowing any money from your broker. In fact, if you use government securities as collateral, you are allowed to earn interest on the credit balance that is generated from the sale of the naked options. Thus, in the preceding example, the \$400 call premium could be invested in a money market fund and allowed to earn interest as long as you had \$1,400 worth of equity in your T-bills.

The collateral requirement changes as the underlying stock moves up and down, to reflect the risk your broker envisions that you have in the position. For example, if XYZ rose to 120, the July 120 call might then be selling at 13. Your requirement would be \$2,400

(20 percent of \$12,000) plus \$1,300 for the option premium, for a total requirement of \$3,700—considerably larger than it was when the option was first written.

For index options, the calculation is similar, except that only 15 percent of the index value is required, as opposed to the 20 percent required for stock options. This is because indices are less volatile than individual stocks.

For futures options, if you are using SPAN margin, the requirement is based on the volatility of the underlying futures contract. This is a sophisticated and enlightened way of approaching the matter and hopefully one day will be employed for stock options. Thus, SPAN margin might require more collateral for pork belly options than it would for heating oil options, even though both futures might be trading at the same price (most of the time, pork bellies are more volatile than heating oil). If you are *not* using SPAN margin, then the requirement for writing a naked futures option is usually equal to the futures margin plus the option premium less one-half the out-of-the-money amount, if the option is out-of-the-money.

As with naked options, naked index or futures options require a minimum amount of margin. This is normally in the neighborhood of \$200 to \$300 per option, so that even an extremely out-of-the-money option will still require some collateral in order to write it naked.

## Naked Put Writing

The sale of a put, without any accompanying position in the underlying stock, is termed *naked put writing*. It is a popular strategy among moderately sophisticated investors. The profit potential is a limited one; if the underlying security rises in price, the put that was sold will expire worthless and you will profit by the amount of the original premium that was collected. The following example and Figure 2.8 define the strategy.

---

*Example:* Suppose XYZ is selling for 51 and the July 50 put is selling for 2. If you sell the July 50 put naked, your profit potential *at expiration* would be:

Stock Naked Put Price	Option	
	Price	Profit (\$)
30	20	-1,800
35	15	-1,300
40	10	-800
45	5	-300
50	0	+200
55	0	+200
60	0	+200

Figure 2.8 shows the shape of the profits and losses associated with naked put writing. The profit is limited to the premium collected. On the other hand, if the underlying security falls in price, large risks could materialize. You would be forced to either buy back the put at a much higher price in that case or accept assignment of the stock at expiration. That is, the sale of a put obliges you to buy

**Figure 2.8**  
**NAKED PUT WRITE**

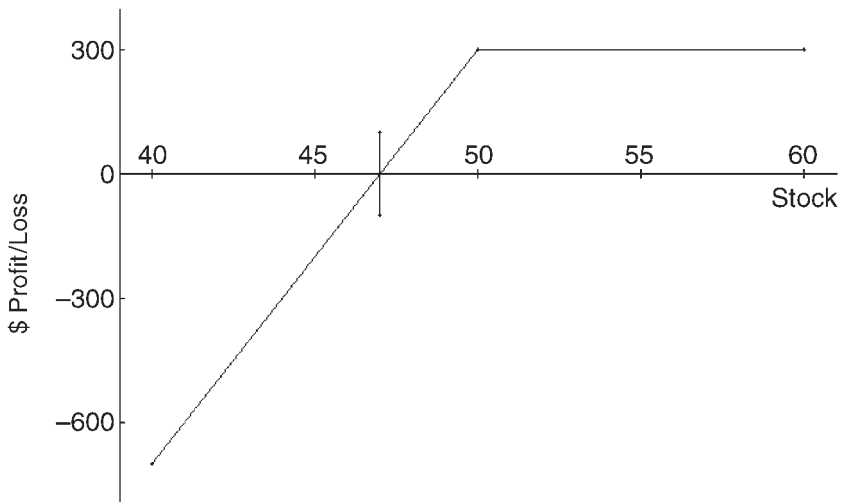



the stock if you are assigned at some later date. The purchase of this stock could require considerable money.

---

One of the worst put-writing debacles of all time occurred in the crash of 1987. In the years and particularly the months leading up to the crash, many investors had been writing naked puts on the “stock market.” In this case, the stock market was generally represented by the Standard & Poor’s Index (OEX), although some other broad-based indices were being used as well. One of the great attractions was that you only had to have collateral of 5 percent (!) of the value of the index at that time.

As the stock market inexorably ground its way higher and higher through 1986 and 1987, more and more investors became enamored with the idea of putting up about \$3,000 in collateral to collect \$100 or \$200 in profits every month, month in and month out. Of course, when the crash came, OEX fell almost 100 points in two days. Thus, puts that had been sold for \$100 were suddenly worth \$8,000 to \$10,000. To make matters worse, volatility had increased so dramatically that the puts were even more expensive than they normally should have been.

Needless to say, many investors were wiped out, some brokerage firms were wiped out, and lawsuits flew back and forth. In the aftermath, margin requirements were raised, brokers required more sophistication from their customers who wanted to write naked options, and limits were placed on stock market movement.

---

It is stories like this that make many traders leery of writing naked options. However, before turning the page to look for the next strategy, stop for a minute and look at the preceding profit graph of the naked put write (Figure 2.8) and compare that profit graph with the one of the covered call write in the preceding section (Figure 2.7). They are the same! The profit and loss potential of a covered call write (which is considered to be a conservative strategy) is exactly the same as the profit and loss potential of a naked put write (which seems, by the previous example, to be a very risky strategy).

What is going on here? Is there some trick? No, there isn’t. In fact, the two strategies *do* have the same profit and loss potential. The *investment* required for the two is slightly different, but the dollars of profit and loss are the same. But, you may ask, what about the disaster scenario in the preceding example? Well, owning stocks during the crash was pretty risky, too, you may remember. In fact, any

time you own stock, you have large risk to the downside—whether or not you take in some call premium as a hedge—just as you have downside risk from selling naked puts. In reality, covered call writing probably isn't as conservative as some would have you believe, and naked put selling isn't as dangerous, either.

The conventional wisdom is that covered call writing is the safest form of option trading because it has less risk than owning stock. I've always had some trouble with this argument because a stock can fall a long way; and even if you sell calls against it several times on the way down, you can still suffer some rather large losses in bear markets. Moreover, no matter what kind of market you're in, the sale of a call against your stock deprives you of the potential for large gains on the upside, since you are obligated to sell your stock at the striking price.

More realistically, it could be said that covered call writing *can* be a conservative strategy. As with all option strategies, it depends upon how they're implemented as to whether they are conservative. If you're selling "expensive" calls against a stock that is oversold (or cheap by some other measure), then I would agree that that is probably a conservative method of covered call writing. However, if you're selling out-of-the-money calls against a volatile, overpriced stock, that's not very conservative because you are taking too much downside risk.

Recall that when two strategies' profit graphs have the same shape—as do covered call writing and naked put selling—then the two strategies are considered to be *equivalent*.

I generally prefer the naked put selling strategy for two reasons: first, you are only dealing with one security's bid-asked spread rather than two, and second, the margin requirement is considerably smaller. The stock owner receives dividends (if any are paid), but the naked put seller can use T-bills as his collateral and earn interest that way. Moreover, the price of the put has the dividend factored in (i.e., puts are more expensive on high-dividend-paying stocks, all other things being equal).

**Put Writing Philosophy.** The naked put writing strategy is often approached in this manner: if you sell an out-of-the-money put on a stock that you like—and wouldn't mind owning—then you are in a "no-lose" situation. If the stock goes up, you profit by the amount of the premium received from selling the put. On the other hand, if the

stock goes down below the striking price of the put you sold, you buy the stock at a low price, which is theoretically good since you don't mind owning the stock. At that point, you can just hold the stock or maybe even write some calls against it. This philosophy is quite widespread among naked put sellers. That is, they choose the puts they sell by looking at the qualities of the underlying stock. They are not overly concerned with whether the puts are "cheap" or "expensive" by statistical measures. In this manner, if you do eventually wind up being put the stock, you are buying a stock that you have confidence in and that is fundamentally attractive to you.

Unfortunately, the theory and the practice of it are sometimes at odds. It's all well and good to say that you wouldn't mind owning a stock if it dropped to the striking price of the puts you sold. However, what if it dropped to that level and kept on dropping? Then, it's not so much fun.

---

When LEAPS options (options with expirations extending out to two years) were introduced, they were generally only listed on some of the biggest and best stocks. One of the reasons this was done, as opposed to listing them on volatile highfliers with big option premiums, was to attract put writers who adhere to the philosophy just described. One of these stocks was IBM, which at the time was selling between 105 and 100. Long-term puts with a striking price of 90 were listed; and many investors sold them naked, figuring that if they had a chance to own IBM at 90, they wouldn't mind. Well, they all got their chance as the stock began to drop rather precipitously and fell all the way to 45. It didn't recover right away, either. When the puts got so deeply in the money, most of them were assigned, even though there was over a year of life remaining in the puts. Many of those put writers, in the final analysis, were not really ready to buy IBM and hold it through a plunge like that. Some of them didn't have the money required to take on the debit necessary to buy the stock, so they tried to roll their puts to even longer-term puts, but those too were assigned. The moral is that even the best of stocks can go through its own bear market; and, if it does, it will hurt covered call writers and naked put sellers.

---

**Protecting Your Positions.** Regardless of whether you use covered call writing or naked put selling, you have downside risk, as the

previous story shows. Moreover, if you have a whole portfolio utilizing this strategy, you are especially subject to the risk of a market correction (or worse, a bear market). When markets get overextended, you should start thinking about protecting your covered writes or naked puts.

“How?” you ask. Well, there are several ways, assuming you want to continue to operate the strategy. One way would be to make your portfolio more conservative, utilizing underlying stocks that are less volatile and perhaps “cheap.” Another way would be to buy some (other) puts to protect yourself. The easiest thing to do would be to buy some out-of-the-money OEX LEAPS puts, but they may be quite expensive in terms of implied volatility.

A less costly approach would be to buy (deeply) out-of-the-money puts on the individual issues that you own or have written naked puts on. If you are a covered call writer, you would then have a strategy that the professionals term a *collar*: long stock, short out-of-the-money call, long out-of-the-money put. If you are a naked put seller, then your resultant position would be a bullish put spread. In either case, you have limited your downside risk at the expense of some of your option writing profits.

Thus, a covered call writer or naked put seller should attempt to limit his losses; for if he sustains large losses in this limited-profit strategy, it will take a long time to make them back.

## **Naked Call Writing**

The writing of naked calls is considered to be an extremely risky strategy, and many brokerage firms require their customers to demonstrate a certain amount of experience and/or sophistication before embarking on the strategy. In reality, it is really not much more risky than writing naked puts—and therefore, by equivalence, doing covered writes—for all those strategies can incur large losses if an unfavorable movement occurs in the underlying. The fact that a stock can rise more than 100 percent but can only fall 100 percent makes the ultimate risk larger with naked calls than with naked puts, but it can be very large in either case. An example of a naked call write follows.

---

*Example:* Suppose XYZ is selling for 51 and the July 50 call is selling for 3. If you sell the July 50 call naked, your profit potential at expiration would be:

---

Stock Price	Option Price	Naked Call Profit (\$)
40	0	+300
45	0	+300
50	0	+300
55	5	-200
60	10	-700
70	20	-1,700

---

Figure 2.9 shows the shape of the profits and losses associated with naked call writing: limited profit potential to the downside and large risk if the underlying stock should rise dramatically. Most writers of naked calls are intrigued by the relentless effects of time decay and want to be on the side of a trade that benefits from that decay. This is generally the main impetus for the strategy. It is *not* primarily used as a way to profit if you expect the underlying to decline in price—long puts or synthetic puts and bear spreads would be more appropriate for that bearish scenario.

Writers of naked calls usually sell out-of-the-money calls that, in the call writer's opinion, are too expensive; he often feels that there is not enough time for the stock to climb to the striking price of the written call before expiration or that the call is selling for just too high of a price. These are reasonable approaches, but even reasonable men can lose money.

---

Every option that is worthless at expiration had some value sometime during its life. However, if the option is out-of-the-money (perhaps by a relatively large amount), its value will begin to slip away, until, one day, the option will have the smallest possible bid: five cents for stock options, and similarly tiny amounts for futures options. This bid sometimes lingers for a while as traders who are short the option—either naked writers or covered writers—often attempt to cover their position and move on to the next trade. These option writers sometimes are therefore bidding for an option

**Figure 2.9**  
**NAKED CALL WRITE**

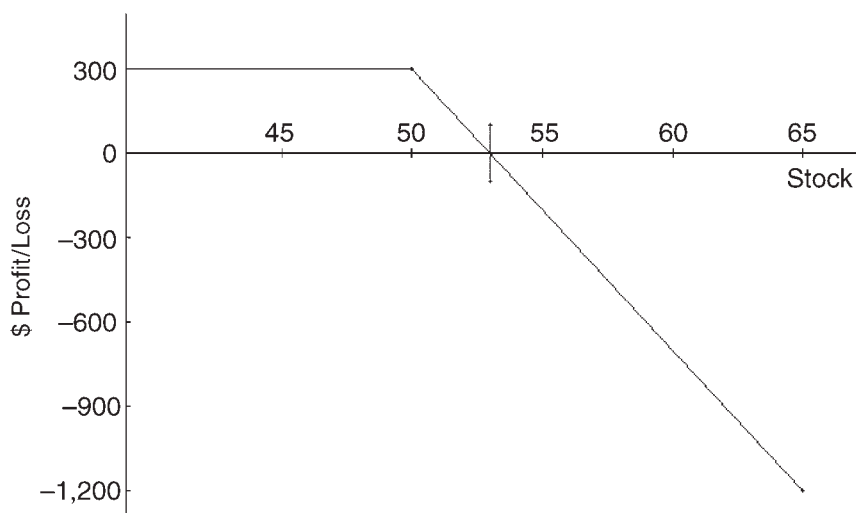

that is, by all statistical measures, doomed to be worthless. However, they are interested in closing out their trade.

In the early to mid-1980s there was a tendency among market makers and professional firms to “sell the teenies.” That is, they would look for these situations where there was a sixteenth bid for options that had no statistical value and sell them. This sale normally took place quite close to expiration—within a week or so. Therefore, there was a very large probability that these professionals would collect the \$6.25 for each sale. Moreover, the collateral requirements were quite low: \$250 at the most for the public and much less for market makers. Thus, the annualized rate of return was over 100 percent for this strategy (and much higher for floor traders).

The only problem was that there was the occasional gap up or down by a stock that would turn one of the “worthless” options into something with value. However, these were rare and the strategy was highly profitable for a long time. As with any profitable strategy, word gets around, and more and more people start utilizing it. Such was the case with “selling teenies” on calls of Amax Corp., a metals stocks. It was trading under 30 with only a few days left until expiration. Moreover, the stock had been in a severe downtrend, and there were striking prices all the way up to 50 and above. It appeared that the calls at all those strikes would expire worthless. Since the

stock had at one time or another traded near each of those higher strikes, there was decent open interest at each one. Consequently, when each one eventually became bid at a sixteenth, the teenies were sold. Then, the unthinkable happened: an \$80 per share bid was made for the company right before expiration. Small firms went out of business, and even large ones suffered more than they had bargained for.

---

The resulting havoc pretty much ended “selling teenies” as a widely practiced strategy. However, the practice continues today in similar form, with the same results upon occasion. Now, option writers are more apt to cover their short options at fractional prices of a quarter or so, because too many times they sold an option at two or three dollars, only to see it fall to a fractional price and then spring back to life once again as the stock reversed direction. This is the reality of the postcrash market, whose volatility still lingers in the memory of every option writer. When these writers cover, there are surely others out there attempting to use a strategy similar to “selling teenies,” only now they can get a quarter of a point for that sale. Even with only a week to go, this strategy produces its share of naked writing disasters every so often. Thus, naked option writers should not attempt to sell these extremely low-priced options just before expiration. Eventually, the large loss can and probably will wipe out all the “teeny” profits that were made.

Many futures traders also sell very low-priced options with a short time remaining until expiration. At least with futures, you can't have a takeover; but that still doesn't prevent the option owner from exercising if something changes with respect to the fundamentals.

---

In the spring of 1995, a large client was long a substantial number of calls on silver. The striking price of these calls was 550, but silver had drifted down over the life of the contract and was settling around 535 on the day that the calls expired. This client, however, was not a speculator, but was intensely interested in actually owning silver futures (and perhaps, eventually, the metal itself). He owned a very large quantity of calls, and he looked at what would happen to the futures market if he let those calls expire and instead bought the same number of silver futures. He realized that his buying pressure would most likely push the price of silver futures back up over

the 550 level and that his average price to buy all the futures he wanted might actually be higher than 550 by the time he was done. Therefore, he exercised the calls! Traders who were short the 550 calls had obviously gone home expecting to ring up some realized profits that expiration night. Instead, they found themselves in a nightmare situation as silver gapped open at 560 and traded even higher the next day. Not only did this gap opening cause panicky short covering by regular futures traders, but, after assignment, all of the naked options writers were now short futures as well and fed the frenzy even more. This proves that even futures option sellers should be extremely careful about operating a strategy of selling extremely low-priced options right before expiration.

---

## Straddle and Combination Selling

One of the ways in which naked option writers attempt to hedge their positions is by selling both a naked put and a naked call. The losses on one may be more than offset by the profits on the other, for they cannot both lose money at the same time unless volatility increases. The put and the call may have the *same* striking price (which is a straddle), or they may have *different* striking prices (a combination, or strangle as it is sometimes called). In either case, one still has unlimited risks—and by selling both the put and the call, the risks exist in either direction, up or down—but there is more profit potential if the stock is relatively unchanged, which is what stock or futures prices *are* most of the time over a short period. Figures 2.10 and 2.11 show the short combination and the short straddle.

Earlier, the collateral requirements for writing naked options were spelled out: 20 percent of the stock price, 15 percent for an index, and the futures margin for futures option. When you are writing both a naked put *and* a naked call, the collateral requirement is the *greater* of the put requirement or the call requirement; the other side does not require any additional collateral. In the case of a naked straddle, this means that you are forced to collateralize the in-the-money option, while the other one is “free.” In the case of a combination (strangle), the “greater” collateral requirement normally is applied to whichever option is nearer to the money (if both are out-of-the-money). Generally, it seems that combination selling is better



**Figure 2.10**  
**SHORT COMBINATION**

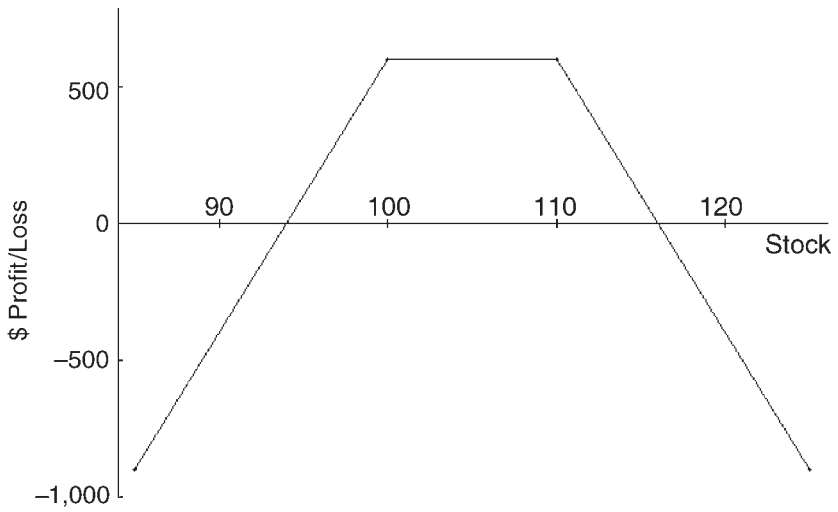

**Figure 2.11**  
**SHORT STRADDLE**

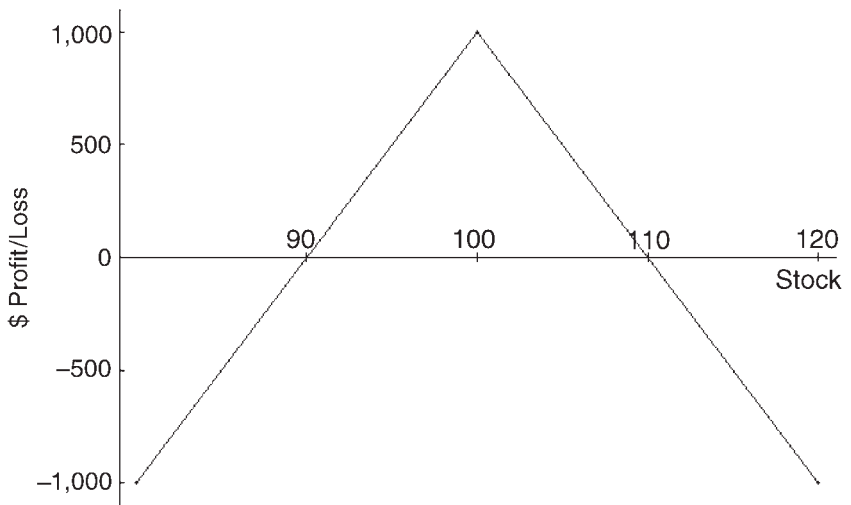

than straddle selling because there is a better chance that both options could expire worthless; moreover, if one option becomes an in-the-money option, it would generally take a major reversal for the underlying to swing back far enough to make the *other* option go in-the-money. Of course, when you are dealing with unlimited risk positions, you are constantly at risk of a volatile and sudden move by the underlying stock, index, or futures.

---

When puts were first listed, straddle trading was the de rigueur strategy. Even though only 25 stocks had listed puts, there was plenty of interest in trading straddles on them. In particular, since this was 1977 and there was a bear market of sorts going on, straddle *selling* was more popular than straddle buying. In those days, markets declined slowly instead of all at once as is the custom now, so that a strategy involving time decay worked well. As profits were built up over time, there was a general feeling that a long-term strategy of straddle selling would be the best approach to the market. Since most stocks wandered in trading ranges most of the time, according to computers, if you were to merely diversify and sell straddles in nearly all of the 25 issues available, you would have a nicely hedged portfolio. Of course, there were stopgap measures designed to limit losses should big moves occur, but they generally consisted of something like recentering the straddle at new strikes if the stock moved too far away from the current striking price of the straddle. Since IBM was by far the most liquid stock on which puts were trading, there were a large number of straddles sold on IBM.

The strategy was working rather well up until the second week of April 1978. It was on that Friday that a sleepy market awoke and bolted upward 20 points (up 3 percent on the Dow) and volume reached the previously unheard of levels of 52 million shares! What caused this was a discussion in Congress regarding lowering the capital gains tax; that same piece of news can still rally the market dramatically even today. What was even more noteworthy for straddle sellers, however, was the fact that IBM shot up over 14 points in one week—from 239 to 254. Most straddle sellers had long since covered their naked puts or rolled them to lower strikes as IBM had fallen farther and farther during the spring of 1978. What was left were a lot of naked calls that were going to expire worthless, or so the thinking went. Instead, the rally by IBM through several strikes brought ruin to many a straddle seller that day. Similar, but smaller, moves in many other stocks pretty much ended the diversified straddle selling approach to trading as a popular strategy.

---

Of course, someone *made* money that was being lost by the straddle sellers—mostly owners of calls. The following story really doesn't apply to straddle selling *per se*; but since it involves the same set of events that were just described, it belongs here nevertheless.

---

The bearish market of late 1977 and early 1978 had been rough on many bulls, and one bullish professional trader was about wiped out. He was down to his last few positions—a rather sizable amount of deeply out-of-the-money calls on IBM, plus some calls on Avon, and a few other stocks. When the ApriIs expired, he was destined to be out of business, for he had no further source of funds. So he was just waiting around for April expiration—not exactly anticipating the word from his clearing firm that his trading account was worthless. Then, only a week before April expiration came the big market rally, exploding the price of IBM dramatically higher. As it turned out, the trader made all his losses back in that one day and in the subsequent trading the next week.

---

Today, straddle and combination writers are much more apt to buy out-of-the-money options to protect themselves against disaster. This strategy is discussed in a later section, entitled “Credit Spreads.”

**Covered Straddle Writing.** In the wake of the 1978 debacle that naked straddle writers suffered, another approach to straddle writing became a little more popular; but it has never really captured the fancy of large quantities of option traders. It is the *covered straddle*, in which one buys 100 shares of the underlying stock and also sells a straddle at the same time. The call from the straddle sale is covered by the ownership of the stock, so what the trader really has is a covered call write plus a naked put. This is a fairly bullish position because, if the price of the underlying falls dramatically, he will lose money on both the long stock and the short put. It has limited upside profit potential; although if the stock remains relatively unchanged, the covered straddle writer would capture a fair amount of decaying time value premium.

If you recall our discussion of naked put selling and covered call writing, you may recall that we said the two strategies are equivalent. So a covered straddle—which is a covered write and a naked put—is *equivalent* to selling two naked puts. Therefore, it would be more

efficient to just sell two naked puts rather than bother with the covered straddle write. It is more efficient not only in terms of collateral requirements but also from the viewpoint that a covered straddle involves three separate securities (underlying, call, and put), while the naked put involves only one. So, merely selling two naked puts would lower commission costs and would also avoid having to deal with three bid-asked spreads.

## SPREADS

Spreads are constructed by being both long an option and short another option on the same underlying, where both options are calls or both options are puts. Spreads are designed to limit risk, and they often limit profit potential as well, although not always. The risk-limiting nature is probably the more important aspect of a spread. If you are normally a naked call seller, you could limit your risk by buying another call that is *more* out-of-the-money than the one you sold. If the underlying rises dramatically, the call that you own will limit losses; therefore, you no longer have unlimited risk from the option sale. Of course, buying that call will cost you some of your profit if both options expire worthless, but many traders feel that the peace of mind that the spread provides is worth the small amount of money that is spent on the long, protective call.

We first describe the strategies in which the spreads are linear, that is, where the same number of options is bought as is sold.

### Vertical Spreads

A spread is a *vertical* spread if both options have the same expiration month but different striking prices. There are two main types of vertical spreads: the *bull spread* and the *bear spread*. Either one may be constructed with puts *or* with calls. In fact, it is even possible to construct them using the underlying and options as well.

**Bull Spread.** A bull spread is a vertical spread that is typically constructed by buying a call at one strike and selling another call at a

higher strike (both calls typically expire at the same time). The resulting position has profitability as shown in Figure 2.12. Since the profit potential is on the upside, you need to have a somewhat bullish outlook for this spread to work, hence the name. There is both limited risk and limited profit potential, although the risk is equal to 100 percent of the capital required—the same percentage risk as owning a call option.

If the underlying is near or below the lower strike when the spread is established, the profit potential can be several times the loss potential. If the underlying is initially midway between the two strikes, then the profit and loss potential will be approximately equal. Finally, if you establish bull spreads with the underlying at or above the higher strike, the risk is great in comparison to the potential rewards, but the probability of gain is high since both options are in-the-money to begin with.

One of the main reasons that traders use bull spreads instead of just buying calls outright is that they want to hedge their bets somewhat. This is particularly true if the options are “expensive”; the trader feels that he is at least selling something expensive against the

**Figure 2.12**  
**BULL SPREAD**

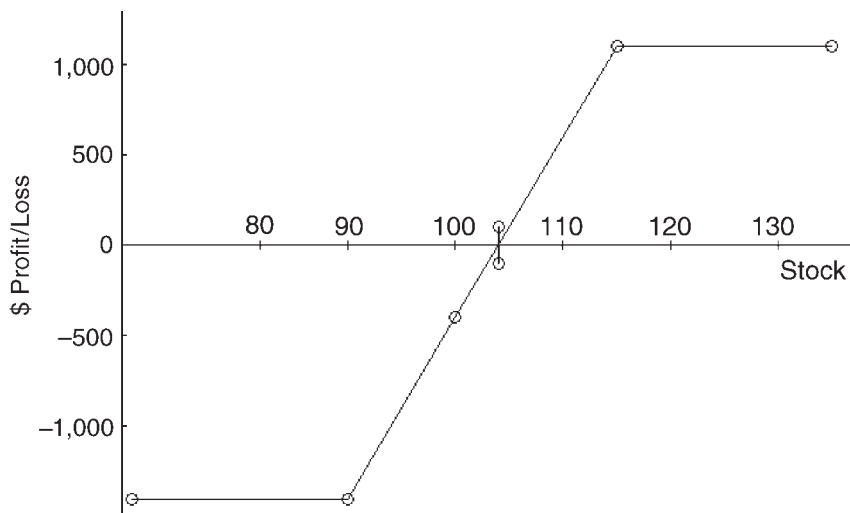

expensive call that he is buying. However, he should not always use the bull spread approach just because the options have a lot of time value premium, for he is giving up a lot of upside profit potential in order to have a hedged position. If the underlying is volatile, then he should not be queasy about having to pay for time value premium on an in-the-money option—it is probably worth it, as the implied and historical volatilities most likely are closely in line.

Once the bull spread is established, it might not perform exactly as you expect. Figure 2.13 shows a typical bull spread using the 80 and 90 striking prices, bought when the underlying was 85—midway between the two strikes. The profit potential at several intermediate points in time is shown: at 15 days from inception, 30 days, 45 days, and 60 days. Notice that there is very little difference in the results as time passes (until you get very close to expiration, when the profit potential approaches the final shape of the bull spread). This phenomenon can sometimes be frustrating: if the underlying has a nice upward move shortly after you establish the spread, you will probably

**Figure 2.13**  
**BULL SPREAD COMPARISON**

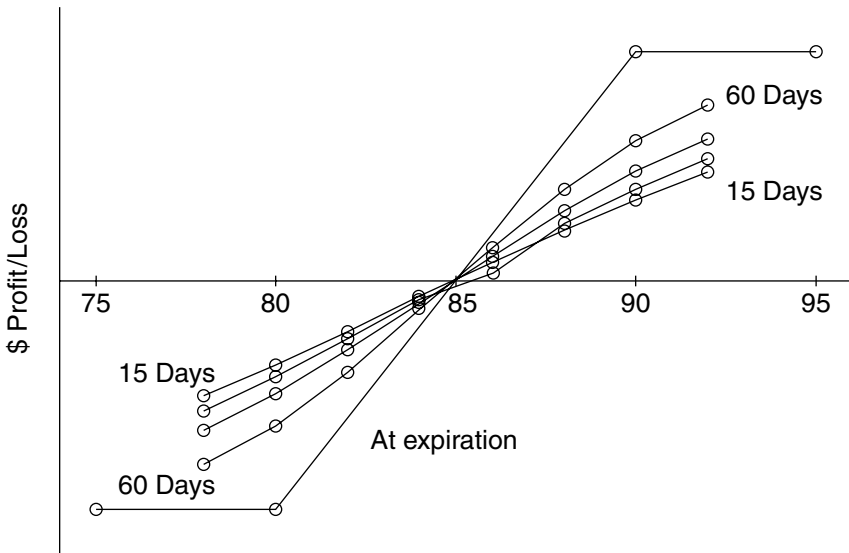

be disappointed in your profits at that time. This fact often causes bull spread holders to “overstay their welcome,” as they figure they will continue to hold on for better results closer to expiration, only to see the underlying slip back and their profits dissipate.

Thus the bull spread is a low-risk- and low-profit-potential strategy—particularly if you remove it prior to expiration—but that is not what many traders intend when they establish it. To get a larger profit potential, you must establish the spread with the underlying close to the lower strike, or merely buy the call and not use the bull spread at all.

The preceding bull spread using calls always requires a *debit* to establish, since the call with a lower striking price will always cost more than the call with the higher strike that is being sold. However, an equivalent position can be established using puts, and the put spread is a credit spread. The following example illustrates this fact.

---

*Example:* XYZ is 55.

July 50 call: 7      July 50 put: 1½

July 60 call: 2      July 60 put: 6½

Call bull spread: buy July 50 call and sell July 60 call = 5 point debit.

Put bull spread: buy July 50 put and sell July 60 put = 5 point credit.

---

With either spread, you would make 5 points at expiration if XYZ is over 60, and you would lose 5 points if XYZ were below 50 at expiration.

The advantage to credit spreads is this: in the credit spread, the brokerage firm requires the difference in the strikes to be margined with collateral; then you can use the credit generated to reduce the requirement, if you want. We have already described collateral as any type of security that you own, stocks or bonds. Most brokerage firms will allow you to put up T-bills as collateral for the difference in the strikes, *and then they will let you put the credit from the spread in a money market fund and earn interest on it.* This additional feature makes the credit form of the spread more attractive to many investors.

There is actually one more way to construct a position that has the same profit potential as a bull spread: buy the underlying stock,

buy an out-of-the-money put (which limits downside risk), and sell an out-of-the-money call (which limits upside profit potential). This position, known as a *collar*, is a rather popular form of protecting a stock position. It is discussed in more detail in the section on protecting a portfolio in Chapter 3. Thus, all three ways of constructing a bull spread are considered to be equivalent positions.

**Bear Spread.** The bear spread (Figure 2.14) is also a vertical spread, but it is constructed by taking the opposite actions of the bull spread: if you are using calls, you buy the call with the *higher* strike and sell the call with the *lower* strike. This creates a spread that has its profit potential to the downside (hence, the name *bear* spread). Like the other vertical spreads, it has limited profit and risk potential.

When you establish a bear spread with calls, you take in a credit; so it has the advantages outlined earlier in terms of earning interest from the credit. The bear spread may also be constructed with puts, in which case you would have a debit spread: you would buy the put at the *higher* strike and sell a put at a *lower* strike as a hedge.

**Figure 2.14**  
**BEAR SPREAD**

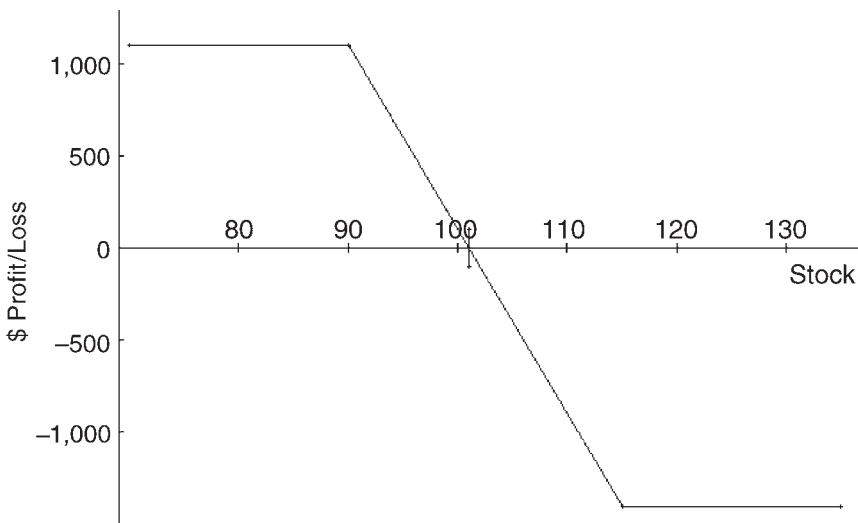



As with the bull spread, you may use the spread because the options are expensive. This helps reduce the risk if things go awry but may severely limit the profit potential over the short term if the underlying moves in a favorable direction.

---

Sybase, a technology stock, was trading near 45 in the spring of 1995, and the options had become very expensive in advance of the company's earnings report. Since technology stocks were "in favor," there was a contingent that thought the stock would soar if the earnings were merely "in line." On the other hand, there were rumors that the earnings were going to be terrible. These two facts combined to make the options very expensive.

I knew a trader who felt that earnings were going to be bad and therefore wanted to buy puts. His initial reaction was to buy the April 45 puts, or perhaps the April 40 puts, but they were extremely expensive. With Sybase at 45, the April 40 puts were  $2\frac{1}{2}$  with only a month remaining until expiration. Figuring that these were just *too* expensive, he decided that it would be better to pay  $4\frac{1}{2}$  for the April 45s and then offset some of that cost by selling an out-of-the-money put. Thus, he created a bear spread—he bought the April 45s and sold the April 35s for a net debit of  $3\frac{1}{2}$ .

Less than a week later, Sybase let the Street know that not only would earnings be bad, they would be terrible. The stock plunged 20 points to 23. The bear spread widened to its maximum potential—10 points (the difference in the two strikes,  $45 - 35$ )—and the trader made  $6\frac{1}{2}$  points on his  $3\frac{1}{2}$  investment. Not a bad trade, but nowhere near the return that he could have made had he merely bought the "overpriced" April 45 puts in the first place. They rose from  $4\frac{1}{2}$  to 22. Using the spread cost a lot of money.

---

Thus, while it is sometimes attractive to use a spread to offset the cost of an expensive option, you should evaluate *why* the option is expensive and how far the underlying might move. If it's expensive because there is a potential for a short-term, explosive move in the stock, then a spread is probably ill-advised because the options *deserve* to be expensive. If, on the other hand, the options seem expensive only because the underlying has been stagnant or if a move might be only a modest one, then a spread may be a viable strategy.

For example, gold sometimes goes into tight trading ranges for extended periods, during which time the options don't really get correspondingly cheaper. The options retain their premium because traders know that gold could once again become volatile at any time.

The result of all this is that the options appear to be expensive (and they are, in comparison to the movement in the underlying gold futures). At times like that, bull or bear spreads are viable strategies. This same sort of relative option pricing can occur in any stock, index, or futures contract whenever the underlying price becomes sluggish while the options retain their former premium levels.

**Credit Spread.** We have already described the two basic credit spreads—the bull spread constructed with puts and the bear spread constructed with calls. However, “credit spreading” has taken on a wider meaning in the wake of the crash of 1987 and other stock market gaps, which have caused ruin for many a naked option writer. Such trading gaps are also common in futures; so the credit spread strategy, as it is applied today, is fairly widely practiced in futures option trading also.

A look at the philosophy behind the credit spread, plus some historical evidence, will help to explain the current popularity of the strategy. Most option traders “know” that selling options is the more profitable way to approach option trading because (1) time decay works in their favor and (2) everyone says option buyers lose a lot of money. These are popular misconceptions that aren’t always true. Many novice traders are convinced that professionals sell options almost exclusively, so they want to do what the “pros” do (it is my personal experience, however, that most professional traders attempt to establish a net long option position if they can).

The main problem with selling naked options is that there is unlimited risk—or, at least, very large risk—if the underlying experiences a sudden move or gap opening. After the crash of 1987, when many naked put sellers were carried out on their shields, the limited risk nature of the credit spread caused it to gain tremendously in popularity.

Another problem with selling naked options is that, assuming you pass the suitability tests and have enough equity in your account, brokers want collateral of 20 percent of the value of a stock or 15 percent of the value of an index in order to allow you to sell a naked option. With OEX at 600, this is a requirement of \$9,000 to write the 600 call or put naked (15 times \$600). The higher that OEX rises, the greater will be the requirement, as it is recalculated each day by your

brokerage firm. However, the requirement for a credit spread is only the difference in the strikes, less any credit received; thus a 10-point credit spread in OEX would require less than \$1,000 apiece to establish—quite a savings over the \$9,000 for a naked option.

Of course, the profitability of the sale of an option is reduced by buying the other option that creates the credit spread. This is a negative to some traders; but considering the reduction of capital required and the lessening of ultimate risk, it is often seen as a worthwhile cost.

*Do credit spreads really win 90 percent of the time?* I have seen proponents of the credit spread advise establishing the spread with extremely far out-of-the-money options so that there is a very large chance of making money. For example, with OEX at 475 at the beginning of April, they might recommend the April 450–460 put spread for a half credit (\$50). The probability of OEX falling 15 points in two weeks is small. Therefore, they reason, there is a good chance of making money. In fact, this type of spread has been very consistently profitable since the crash—the length of the current bull market.

But what's the *real* risk of the spread? It's that OEX could fall to 450 or lower, thereby causing a loss of \$950. So you're risking \$950 to make \$50, but the probability of making the \$50 is far greater than that of losing the \$950. Let's just say that there's a 95 percent chance that the options will expire worthless and a 5 percent chance that the maximum loss is realized. These are not the true mathematical numbers, and we haven't allowed for any possibility of OEX being *between* 450 and 460 at expiration, but they will suffice for this simple example. So we have a 95 percent chance of making \$50, which means our expected gain is \$47.50 ( $\$50 \times 0.95$ ), and a 5 percent chance of losing \$950—a \$47.50 loss! Therefore, our expected result is that we would make nothing and lose our commissions if we operated the strategy long enough.

Proponents of the strategy usually counter by saying that they would never let the spread lose its maximum amount—that they would close it out if OEX fell to some predetermined level, usually before either option gets to be an in-the-money option. This tactic means that they might only lose a point or less on the spread if they had to buy it back prematurely.

Mathematics would then tell us that they have greatly reduced the probability of both options expiring worthless because there is a much greater chance that OEX could fall to 460 at any time before expiration than there is that it would be *below 450 at expiration*. So now, maybe there's a 70 percent chance of making \$50 and a 30 percent chance of losing \$100—again, not much better than an even-money proposition after commissions are included.

Why does the math seem to belie actual fact? The math says “don't waste your time with these spreads,” while in actual fact, they have been very profitable. For one thing, the math is assuming a random market, and we have been in a mostly bullish market for the past several years. However, this doesn't mean the math is wrong. If you were to flip a coin 100 times and got 90 heads, would you say that the probability of getting heads on the next toss was greater than 50 percent? You might, but you would be wrong—it's still 50 percent.

In much the same manner, the credit spread strategy can be summed up. It doesn't have any theoretical edge, even though many people will tell you that it does; but if you want the reduced-risk feature and the increased leverage offered by the lower collateral requirements, then it is an attractive, but not necessarily statistically superior, alternative to naked option writing. At the end of this section on linear spreads, we discuss when a spread is statistically attractive.

## Calendar Spreads

A calendar spread is also called a *time spread* because one is theoretically attempting to spread *time* and not *price* (although price is still a factor in how the spread behaves). A calendar spread in stock options consists of buying an option that expires in a certain future month and selling an option, with the same striking price, that expires in a closer month. For example, if the current month is April, then buying an IBM July 80 call and selling an IBM May 80 call would be a calendar spread. As time passes and May expiration approaches, time decay will begin to weigh more heavily against the May 80 call that is short than it does on the July call that is held long. As that happens, *the spread will make money if the underlying is near the striking price*.

Sometimes calendar spreads are also called *horizontal* spreads to indicate that spread is across various expiration months, to differential from vertical spreads, where the spread is across various strikes.

The true spread trader will remove the position at or *before* May expiration, as he is interested in the characteristics of the spread itself—it will widen if the underlying remains near the striking price, and it will shrink if the underlying moves too far away from the striking price. This profitability, at near-term expiration, is shown in Figure 2.15. The spread has both limited profit potential and limited risk, with the risk being limited to the amount initially paid for the spread (a feature similar to the vertical spreads described earlier).

A more aggressive tack would be to continue to hold the long calls after the short calls have expired. This is not a recommended method of approaching the calendar spread strategy.

One of the biggest differences between stock (or index) options and futures options is that the expiration months are not necessarily directly related in futures options. Therefore, you must be careful when constructing calendar spreads with futures options. For example, there may be options on March Swiss franc futures and on June

**Figure 2.15**  
**CALENDAR SPREAD**

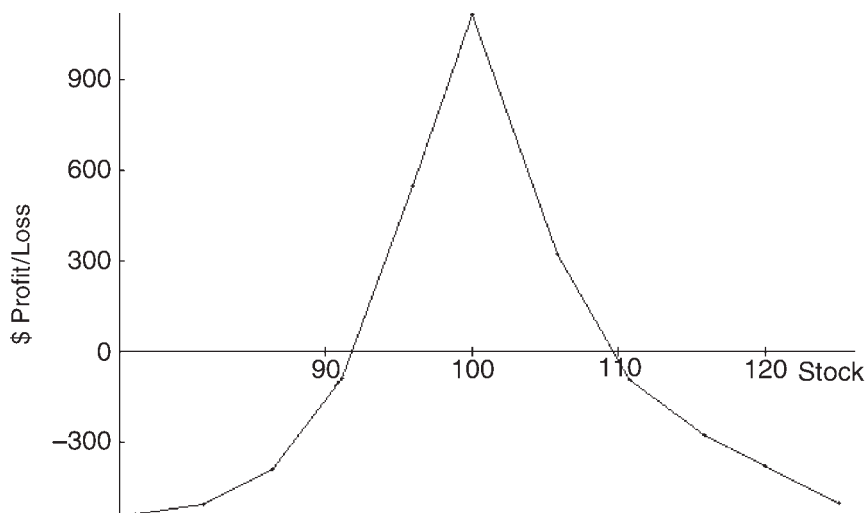

Swiss franc futures. If you buy a June option and sell a March option, you do not necessarily have a calendar spread in the same sense that you do in the IBM example. The reason that this is true is that there are two distinct futures underlying the two Swiss franc options—the June contract and the March contract. Whereas in the IBM example, only IBM stock underlies both of the options in the calendar spread.

While it is true that the March Swiss franc futures and the June Swiss franc futures are related, they do not necessarily move in concert. In fact, in some futures—particularly those with actual commodities underlying them, such as grains and oil—the spread between the two futures contracts can vary substantially. This variation in the spread will cause the related options to behave in a manner that is not what one is used to seeing in calendar spreads on stocks or indices. It can even cause the option values to invert to the point where the near-term option sells for a higher price than the longer-term option. An example may be useful.

---

*Example:* Assume it is currently February, and you notice that March Swiss franc (SF) options are expensive with respect to June Swiss franc options. Therefore, you want to establish a calendar spread. The following prices might exist:

March SF futures: 77.00	June SF futures: 78.00
March 78 call: 1.00	June 78 call: 3.00
	June 79 call: 2.00

Your initial reaction might be to try to establish a calendar spread by buying the June 78 call and selling the March 78 call. However, even though the strikes are the same for each call—78.00—the March call is one point out-of-the-money, while the June call is at-the-money. This increases the debit that you must initially pay for the spread and actually makes it a bullish position. A more neutral calendar spread would be to use calls that are equally out-of-the-money to begin with: buy the June 79 call and sell the March 78 call. Both options are one point out-of-the-money.

Even in that case, though, the spreader is subject to the vagaries of the relative movements of the March and June SF futures. For example, if interest rates in the United States or in Switzerland were to change, then the price differential between the two futures contracts themselves would surely change as well.

---

Currency futures have serial options. Therefore, there would also be SF options that expire in both April and May. Moreover, the actual futures contract that underlies those serial options would be the June futures contract. Thus, you could construct a true calendar spread if you were to buy June SF calls and sell April or May SF calls. In that case, the only variable involved in the option spread would be time, for the same contract—the June SF futures contract—underlies both options.

## Diagonal Spreads

Diagonal spreads are a combination of vertical and calendar spreads. The long and the short option in a diagonal spread have *both* different strikes and different expiration months. Usually, the diagonal spread is used in lieu of the vertical spread if you feel that it may take some time before the underlying makes its ultimate move.

Suppose that you're interested in establishing a bull spread. However, you also notice that the near-term options are quite expensive in comparison to the longer-term options. This type of situation often occurs in a fast-moving stock, or in rumor situations. So, instead of merely buying a bull spread, the trader might decide to diagonalize the spread not only to still have some bullish potential, but also to have the benefit of the time decay of the short-term option.

---

NCR Corp., a computer company, was the recipient of a takeover bid from AT&T in December 1990. Several factors were at work after the bid was made. First, the stock didn't advance to its full potential because of antitrust concerns. In addition, there were indications that the bid might be raised, so the near-term options were more expensive—on a relative basis. This presented an excellent opportunity for a diagonal spread. The following prices existed at the time:

NCR: 90

NCR Jan 90 call: $3\frac{1}{2}$	NCR March 90 call: 5
NCR Jan 95 call: 2	NCR March 95 call: 3

Many risk arb traders who understood options were fairly certain that the deal would go through, but they thought there might be some delay.

So they chose the diagonal spread: buying March 90 calls and selling Jan 95 calls. Indeed, there was a delay, and NCR was still trading at 88 when the Jan 95 calls expired worthless. The arbs then were able to sell Feb 95 calls to further reduce the cost of the March 90 calls that they held. Those, too, expired worthless, and many arbs then just held onto their long calls. Eventually, the government acquiesced, and the stock moved up to 100 in early March, bringing good profits to both bull spreads and outright long positions.

Things got even better, as there were more delays and the arbs repeated the whole process with long June 100 calls and short April 105 calls (and then May 105 calls when those expired). In this entire situation, the diagonal spread was best.

---

This example also demonstrates the second step in a diagonal spread if things work out right: if the underlying remains fairly stable until the short-term call expires worthless, then you can sell an out-of-the-money call expiring in the next month to further reduce the cost of the option that you continue to hold. If there is initially only one month between the expirations of the calls in the spread (as in the NCR example), then there is only one additional opportunity to sell an out-of-the-money call against the one you already own. However, if there were several months between the two options' expirations when the spread is first established, then there can be numerous opportunities to continue to sell premium against the call that continues to be held long. Of course, once the stock makes a large move in either direction, the spread will more or less reach its maximum potential or maximum loss, and there will be no further opportunities to sell short-term premium.

In summary, diagonal spreads can be an attractive alternative to vertical spreads, especially if the near-term options are expensive with respect to the longer-term options. This applies to any underlying—stock, index, or futures contract.

## **When Spreads Are Attractive**

At the beginning of the section on spreads, we stated that one of the main reasons traders enter into spreads is to reduce the risk of a



single-sided position. This is especially true for naked option sellers; the large risk that naked option writing entails can be tempered by using a credit spread instead.

There is another consideration in any spread, and that is the relative pricing of the two options involved in the spread. If the option being purchased is “underpriced” with respect to the one being sold, then the spread has a statistical “edge” to it. When viewed from this perspective, spread trading becomes a strategy unto itself and is one that has a mathematical advantage.

---

Grain futures call options—particularly corn and soybeans—have a natural tendency to be more expensive, on a relative basis, the farther they are out-of-the-money. Thus, if you buy an at-the-money soybean call and sell an out-of-the-money soybean call, which is a simple bull spread, you have a nice statistical advantage. You’re buying something that is “cheaper” than the thing you’re selling. Of course, you could still lose money if soybeans declined in price, since the initial spread’s debit would be lost. Thus, an “edge” doesn’t guarantee a profit, but it does mean that you have a better than even chance of making money if you pursue the same situation many times.

---

This soybean situation described how a debit spread might have an advantage. This advantage can sometimes exist with credit spreads as well, and would increase their attractiveness in those cases. For example, ever since the crash, out-of-the-money OEX calls have been less expensive than at-the-money OEX calls; so a credit call spread (which is a bear spread) has had a built-in edge, statistically. However, since the market basically went up for the next 13 years, the OEX bear credit spread was not particularly profitable.

In fact, many statistically oriented traders recognize the problem with applying statistics to spreads that have a price bias, such as vertical spreads do. For no matter how favorably priced the options are in a vertical spread, you still need the underlying to move in a favorable direction in order to make money. Other spread strategies were born from this, many of which involve ratio writes or ratio spreads. We discuss those as the last section in this chapter. Their application as neutral spreads is reserved for a later chapter.

## RATIO STRATEGIES

### Ratio Writing

The most basic form of “ratio” strategy is the *call ratio write*. In this strategy, you buy or own a certain quantity of the underlying and then sell a number of calls representing a *greater* number of shares than you own. Thus, you have naked call options in this strategy. As such, it is considered a relatively sophisticated strategy, as it has theoretically unlimited upside risk.

The strategy has a profit graph as shown in Figure 2.16. It has both an upside and a downside break-even point and can make money anywhere in between, with the point of greatest profit at expiration being at the striking price of the written options. You may recognize this as the same shape as a naked straddle write; and since the two strategies have the same shape to their profit graph, they are equivalent.

Ratio call writing was the predecessor strategy to naked straddle selling—at least as far as listed option markets go—because there

**Figure 2.16**  
**RATIO CALL WRITE**

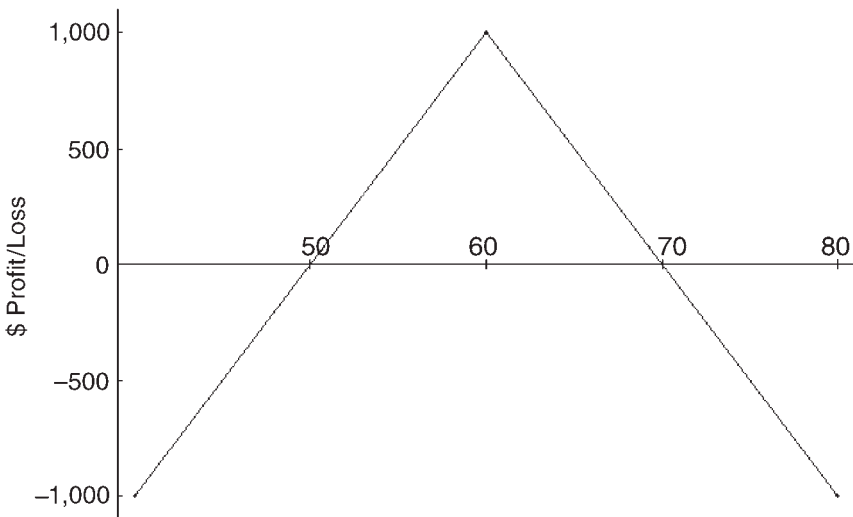

were listed calls for several years before there were listed puts. The strategy is considered to be a “neutral” strategy because you make money if the stock stays in a trading range.

You can also construct a ratio write by *shorting* the underlying and selling two puts. This is a rarely practiced form of the ratio write; but if you think about the shape of the profit graph, you will realize it is the same as the one shown earlier. For stock options, the put ratio write is inferior to the call ratio write unless you are a professional and are able to earn interest on the credit balance generated by your short sale. For futures options, the call ratio write and the put ratio write should produce identical profit potential, although calls are often more liquid than puts, so this fact may also favor the call ratio write in any market.

## Ratio Spreads

When the number of options that you buy in a spread differs from the number of options that you sell, you have a ratio spread of one form or another. As with other option strategies, the various types of ratio spreads have acquired their own names in order for traders and strategists to be able to quickly identify the profitability of the strategy merely by hearing its name.

**Call Ratio Spreads.** In a call ratio spread, one typically buys calls at a lower strike and then sells a greater number of calls at a higher strike. The credit brought in from the sale of the extra calls generally covers all, or nearly all, of the cost of the calls being purchased.

This strategy has little, if any, downside risk—equal only to the initial debit of the spread plus commissions. If the spread was initially established for a credit, then there is no downside risk. As with the ratio write, the point of maximum profitability at expiration is at the striking price of the written options; and a profit can be had all the way up to the upside break-even point. Beyond that point, there are theoretically unlimited losses if the underlying were to rise too far, too fast, because there are naked calls involved in this strategy. These points are all shown in Figure 2.17.

**Figure 2.17**  
**CALL RATIO SPREAD**

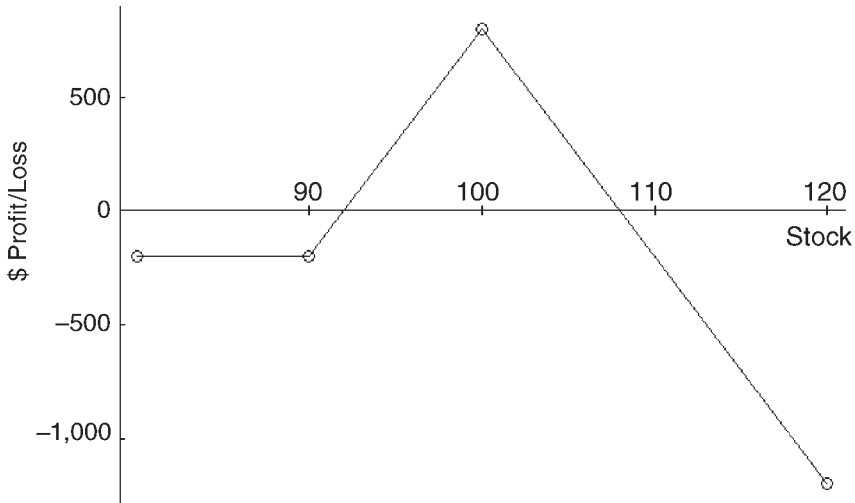

This strategy is one that is favored by many traders over the ratio write because there is only risk on one side of the spread (the upside). Thus, it is easier to monitor. Moreover, if the underlying is initially at or below the *lower* strike in the spread, you often have a profit by the time it rises to the higher strike. In that case, many traders prefer to take their profit at that time rather than waiting until expiration.

---

Ratio spreads are often attractive in futures options due to the fact that out-of-the-money calls are more expensive than at-the-money calls. This gives a built-in edge to the strategist who is using a call ratio spread. In the spring of 1993, gold futures were languishing in the \$330-an-ounce neighborhood. However, professionals were amassing call ratio spreads by buying gold June 340 calls and selling enough June 360 calls to cover their costs. They were essentially buying one June 340 call for every two June 360s they sold. Thus, they had positions with no risk unless gold rose to nearly 380 before June expiration. In the spring and summer of that year, gold had an impressive rally that eventually carried to \$400 an ounce. The rally was methodical, however, and not too explosive—the perfect scenario for the ratio spread. For as gold rose to 360, the long calls were worth over \$20 apiece, since they were 20 points in the money, while the short calls were

worth only \$5 or \$6. Thus, the traders were able to remove their entire position for a nice profit—selling their longs for 20 and buying back the two short for 6 each, leaving them with an \$8 credit for each spread. Even though gold eventually traded higher, the traders had taken their profits and moved on to other situations.

---

This tale illustrates the real beauty of the call ratio spread: you can lay back with little or no downside risk (although capital is tied up; but that capital can be in the form of T-bills, so it at least earns interest). Then, if the underlying makes a move, you have a nice opportunity to exit with a profit. The danger is that the upward move by the underlying will be an explosive one and that you will not have a chance to remove your spread when it trades through the higher strike. This is especially true if there are gap or limit moves that occur when the underlying nears the point where you intended to take profits. Even in that less-than-desirable case, however, the ratio spreader is not in terrible straits. As long as you protect against unlimited upside losses, which would occur if the underlying rose through the upside *break-even* point of the spread, this strategy should produce profits over the course of time. In one sense, this is an even more favorable strategy with futures options than it is with stock or index options, because of SPAN margin computations that are available for futures traders.

**Put Ratio Spreads.** A similar strategy can be constructed with put options, only with puts you buy a put with a *higher* strike and sell a greater number of puts with a *lower* strike. Again, the sales offset most or all of the cost of the purchases.

As shown in Figure 2.18, the put ratio spread has little or no risk to the *upside*. It makes its maximum profit at expiration if the underlying is near the strike of the written options, and it has theoretically large downside risk if the underlying should plunge too far prior to expiration.

Similar theories apply to ratio put spreads as to ratio call spreads. It is generally best to establish the spread for no debit or a credit and normally to initiate the position when the underlying is trading at a price above the higher strike in the spread. Then, if the underlying

**Figure 2.18**  
**PUT RATIO SPREAD**

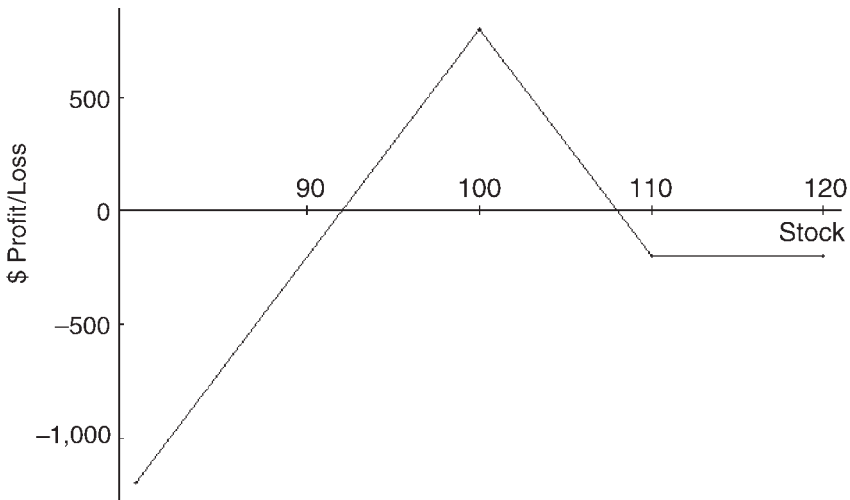

declines, there may be a chance to remove it as it passes through the lower strike—the point of eventual maximum profitability.

The main difference between ratio call spreads and ratio put spreads, especially for stock and index options, is that stocks tend to fall faster than they rise; so you may find yourself with something of a “tiger by the tail” if a sudden downward move develops. Overall, though, this is also a reasonable approach to trading spreads.

**Backspreads.** Strategies in which you own more options than you sell, and that therefore have theoretically large or unlimited *profit* potential, are known as *backspreads*. In essence, they are just the opposite of ratio call spreads or ratio put spreads. In a larger sense, however, any strategy with unlimited profit potential and limited risk is called a backspread by some traders. In this broader definition, even a long straddle would be considered a backspread. For the purposes of this discussion, we are just going to concentrate on the backspread strategy that is the opposite of the ratio spreads described earlier.

**Figure 2.19**  
**CALL BACKSPREAD**

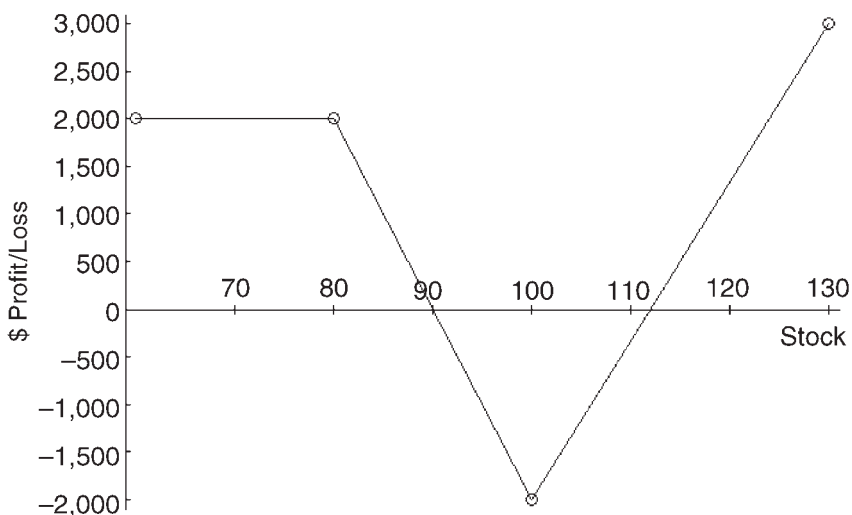

Let's start with a call backspread. In this situation, we sell a call with a lower striking price and buy more calls at a higher striking price. Thus, we have extra long calls in this position, and that provides us with unlimited profit potential (see Figure 2.19). Moreover, if the entire position was established for a credit, we have profit potential on the downside as well. If the underlying were to collapse and all the calls expired worthless, then we would keep the initial credit as our profit. The risk occurs near the higher striking price in the spread. The worst result occurs if the underlying is exactly at the higher strike at expiration. Thus, the entire profit picture looks something like a long straddle, with the downside profit flattening off at prices lower than the lower strike.

Normally, a call backspread is established when the underlying is somewhere in the near vicinity of the upper strike. When established in this manner, the strategist is looking for the underlying to make a move in either direction in order to give him some profitability. Another factor that experienced backspreader look for when they establish these types of spreads is cheapness in the options. If the options are somewhat "underpriced," then there is an additional pos-

sibility that the preponderance of long calls in the spread will benefit from an increase in overall premium levels if, in the future, the options become more expensive. Moreover, if by some good fortune the options being sold were relatively expensive in comparison to those being bought, then the spread has another built-in edge to it.

---

All of these factors came into play in what turned out to be one of the best backspreading opportunities of all time: the big upward move in the market from December of 1994 through all of 1995. That rally began with the OEX Index at a level of about 420 in December of 1994. By February, it had already reached 450, and many market seers were predicting a top after such an extensive run. Conversely, many bulls were predicting even higher prices because of the improving economy and the lack of inflation. Both arguments seemed to make some sense, so there appeared to be the possibility for a large move in either direction. This satisfied the first criterion in deciding when to use backspreads—that the underlying has the ability to move by a good deal in either direction.

Second, OEX options had become rather inexpensive, which is typical of index options' action in a bullish trend. So, with the options being cheap, backspreads were a good strategy because, if the options eventually became more expensive at a later date, the preponderance of long options in the backspread would benefit. Third, out-of-the-money OEX calls were selling at much cheaper relative prices than their in-the-money call counterparts. So all three of the main criteria for establishing a backspread were in place in the late winter of 1994–1995.

Backspreads established at that time became wildly profitable as OEX roared its way to levels above 600. Even traders who kept their backspreads neutral, by rolling the long calls to successively higher strikes as OEX rose in price, managed to make very large returns—all of this while continuing to remain in a position to benefit from a market drop if one had occurred. We examine this strategy thoroughly in Chapter 6.

---

This last point—that the backspread trader was always in position to benefit from an unforeseen market drop (or even a crash)—is what, in my opinion, makes the backspread strategy superior to the long straddle strategy. For in the backspread, you merely have to keep rolling your long calls up to higher strikes if the market rises. Your short calls remain where they were and provide downside profit potential if the downward move ever comes. However, with a long



straddle, if you merely roll your long calls up to higher strikes after a rally, you've done nothing for your downside profit because the puts that you own will then be quite far out-of-the-money. To gain downside potential, you would have to roll the puts to higher strikes as well. In essence, you have to move the *entire* straddle to a higher strike. The backspread trader has a much easier time adjusting and keeping neutral during a long rally.

**Put Backspreads.** Put backspreads are just the opposite of put ratio spreads: you *sell* a put with a higher strike price and simultaneously buy a larger number of puts with a lower strike price. The position is normally established for a credit, with the underlying trading near the lower striking price.

The resultant position has profitability, as shown in Figure 2.20. There is limited upside profit potential, equal to the amount of the initial credit taken in when the spread is established. Downside profit potential is quite large, due to the excess long puts in the

**Figure 2.20**  
**PUT BACKSPREAD**

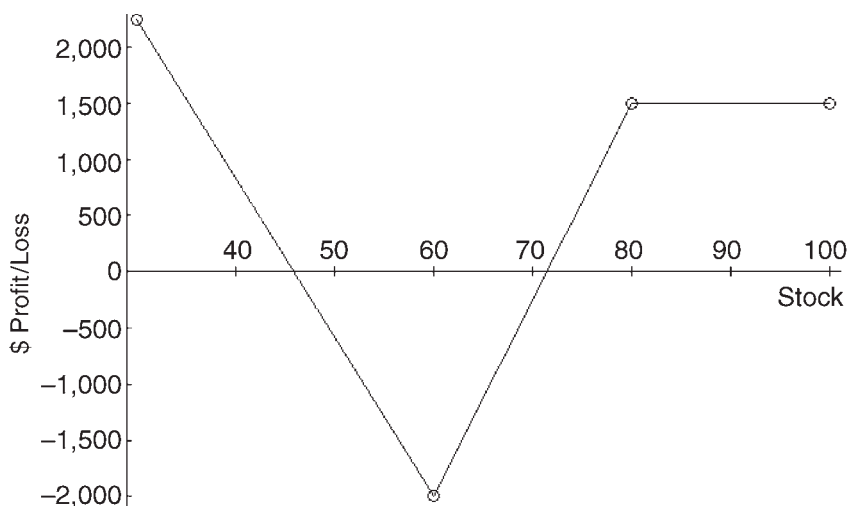

spread. The maximum risk occurs at the striking price of the long puts at expiration.

The ideal situation for put backspreads is to find cases where the puts with higher strikes (the ones you are going to sell) are relatively more expensive than puts with lower strikes (the ones you are going to buy). This would be the case in grain futures options and metals (gold and silver) futures options at almost any time. Thus, one of the best ways to play for a downward move in those markets—if you are interested in a limited-risk strategy that can also make money if you are wrong and prices rise—is with a put backspread.

### **More Complex Constructions**

Obviously, other strategies can be constructed by combining the strategies discussed in this chapter or by modifying them. For example, the butterfly spread is a strategy that is the combination of both a bull spread and a bear spread, where both are credit spreads. Such a strategy is also the same as selling a straddle and protecting your risk by buying both an out-of-the-money call and an out-of-the-money put. The butterfly spread has profitability as shown in Figure 2.21. There are actually several ways to establish a butterfly spread; in addition to the two ways just mentioned, it can be established with all calls or with all puts (using three different strikes in either case). Many traders who protect their naked straddles with out-of-the-money options are using the butterfly spread, although they may not necessarily call it by that name. Incidentally, if you sell a naked combination, or strangle (different strikes for the put and the call), and then protect *that* position with out-of-the-money options, your position involves *four* striking prices and is sometimes known as a *condor*.

It has become fashionable for underwriters and exchanges to create securities that are actually one of these option strategies and to then sell the security as a single unit to investors. For example, some of the larger investment banking houses created a security called PERCS (Preferred Equity Redemption Cumulative Stock). A PERCS is a preferred stock. These are issues on some of the largest corporations—General Motors, for example. A PERCS has a fixed life, such as three years. During that time, it yields far more than the

**Figure 2.21**  
**BUTTERFLY SPREAD**

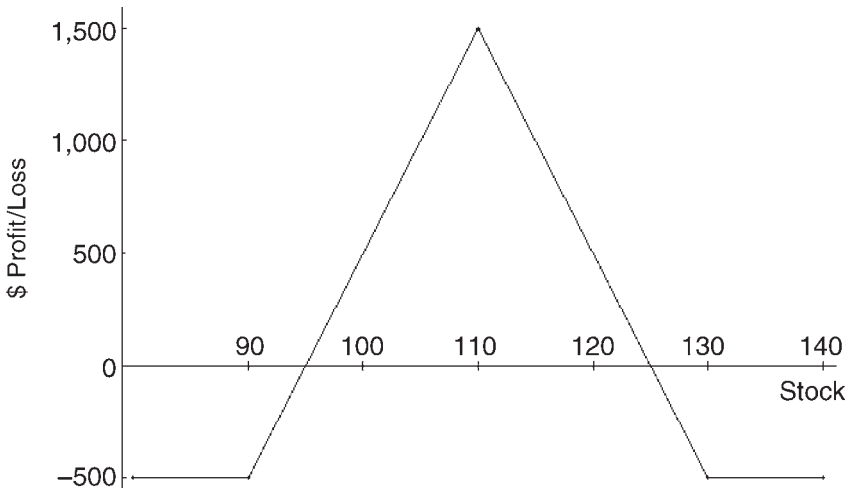

underlying stock does. At the end of three years (or whatever time period is specified when the PERCS is initially issued), the PERCS becomes shares of the underlying stock itself, with one exception: if the underlying has risen too far, then the value of the PERCS is limited to a fixed price. If the underlying is above that price, then the PERCS holder receives cash for his preferred shares at the end of the three years, rather than receiving shares of the underlying stock.

What you really have here is the equivalent of a covered write of a three-year option, but it's not sold that way, nor is the word *option* ever mentioned when PERCS are sold. Consider the premium received from writing a covered call that is a three-year, out-of-the-money option; it would be rather large. Suppose that the premium is distributed to the stockholder in quarterly amounts over the three-year period. Then, it would appear to the stockholder as if he were receiving an extra dividend. Furthermore, if the option expires worthless at the end of three years, then what is left is common stock. On the other hand, if the underlying climbs in price and rises above the striking price of the written call, then at the end of three years, the investor would be called out of his stock and he would receive cash. These qualities exactly describe the PERCS.

Other securities have been listed that resemble covered writing or other option strategies, and more of these securities are being listed all the time. Most are similar to PERCS but have names like ELKS (Equity-Linked Securities) or SUNS (Stock Upside Note Securities).

Moreover, there are securities called structured products that are guaranteed to return a specific amount, while allowing for the possibility of appreciation if the stock market rises during that time. These securities are the equivalent of taking some money and buying a zero-coupon bond with part of it, so that you are guaranteed return of principal, and then buying an option with the balance so you have substantial upside potential.

---

One of the earliest publicly traded structured products was a Stock Index Securities, traded under the symbol SIS on the AMEX. It was based on the value of the Midcap 400 Index (symbol: MID). The SIS value at expiration was calculated by the following formula:

$$\text{Cash Value} = 10 + 11.5 \times (\text{MID}/166.10 - 1)$$

At a minimum, the security was to be worth \$10 at maturity on 6/20/2000 (it was issued on 6/20/1993). However, if MID were above the strike of 166.10 at maturity, then the holder was entitled to the \$10 *plus* 1.15 times the percentage appreciation of the MID Index above the strike of 166.10.

The SIS securities were issued by PaineWebber; so, in effect, they were debt of PaineWebber Corporation. So if PaineWebber were to be insolvent on the maturity date, the “guaranteed” portion of the security would have been in jeopardy (in reality, PaineWebber had actually been acquired by the maturity date—and thus was quite solvent). Due partially to the potential for insolvency and the fact that the Internal Revenue Service (IRS) taxes these securities as a zero-coupon bond (making holders pay taxes annually on their “discount” at which they bought it, if any), the SIS stock traded at sometimes extreme discounts to the cash value formula for several years. This is somewhat akin to a closed-end mutual fund trading below net asset value.

For example, with MID trading at 185 in early 1995, SIS was selling for \$9 per share. The cash settlement value of SIS, with MID at 185, was 11.31 ( $10 + 11.5 \times (185/166.1 - 1)$ ). Thus, you could have bought the stock at 9 when it, in essence, had a net asset value of 11.31. Even with a tax consideration, this was a very attractive discount. Any closed-end mutual fund trading with that type of discount and having the quality of securities of

the Midcap 400 would certainly be considered an attractive buy by many investors.

As the market rallied throughout the life of the SIS security, MID rose to 505.59 by 6/20/2000. Thus, SIS matured at a cash value of 33.50. Owners of the SIS security thus saw them removed from their accounts and replaced by \$33.50 of cash per share.

---

There are other securities like the one just described. You can obtain their terms by visiting the web site of the appropriate exchange where they are traded—the American Stock Exchange, the New York Stock Exchange, or the Chicago Board Options Exchange (CBOE—yes, the CBOE does trade some stocks, particularly structured products such as these).

## Using an Option Model

Even the most experienced option traders check an option's theoretical value with a model before making a transaction. Thus, it should be even more mandatory for an inexperienced option trader to do the same. Without getting into the technical aspects of option modeling—the subject is discussed in Appendix C—traders should know that there are relatively easy and inexpensive ways to gain access to an option model.

There are six things required in order for an option's theoretical value to be calculated: the stock price, the strike price, the expiration date, the short-term interest rate, the volatility of the underlying security, and the amount of the dividend (if there is one). These items can be either typed in by the user or supplied from a larger computer somewhere.

A scientific calculator, such as the better ones manufactured by Texas Instruments or Hewlett-Packard, are quite capable of calculating option theoretical values. You can buy the program that performs the calculations. Obviously, you have to enter the data items by hand if you choose this method.

Computers, of course, are a better alternative for evaluating options. Simple option calculation programs that calculate the implied volatility or theoretical value can be bought for \$100 or less.

The user is generally required to input the underlying price, the strike price, the expiration date, and so on. If implied volatility is desired, then the user has to type in the price of the option in question, and the program will return implied volatility as an output.

More expensive calculation programs are available, and these are generally tied to a data source so that you don't have to enter anything other than the trading symbol of the underlying security. Not only are these types of programs more expensive to buy, but you must also pay for the data that is automatically being fed into them.

All of these approaches are valid, depending on your needs, and they are discussed in more detail in Chapter 7. Just make sure that you do indeed have access to a model and that you use it before making trades. Then you will know whether the option you are trading is expensive or cheap. We are *not* saying that you must only buy "cheap" options; we are saying that you should know if the option you are buying is cheap or not. If it's expensive, that's okay, but you are at least aware that you are buying an option that might lose value if implied volatility decreases, even though the underlying security rises slightly in price.

## **SUMMARY**

The broad overviews of the various strategies expressed in this chapter should be enough of a foundation for understanding the material in later chapters. As explained in the Preface to this book, it was not our intention to detail the explicit calculations of break-even points and explain follow-up actions for these basic strategies.



# 3 The Versatile Option

In this chapter and in the two succeeding chapters, we are going to address the use of options in ways that don't require much in the way of theoretical evaluation of options (we are always in favor of an option trader using a model to evaluate an option before buying or selling it). These techniques, strategies, and trading methods are very useful and can be extremely profitable. It's just that they aren't so mathematical; they are of a more practical variety and, as such, may appeal to a broader audience of traders and short-term investors.

## OPTIONS AS A DIRECT SUBSTITUTE FOR THE UNDERLYING

Options can be useful in a number of ways—ways that go beyond the basic profit and loss of predefined strategies. Some of them depend on an understanding of basic equivalent positions. For example, in this segment we show you how to avoid ever having to worry about limit moves in futures contracts ever again. We also discuss ways in which using options can actually make your use of capital more efficient than merely trading stock.

Recall that two positions are *equivalent* if they have the same profitability, that is, their profit graphs have the same shape. One of the most important equivalences is the following: *a long position in the underlying security is equivalent to being both long a call and short a put with the same terms*. Conceptually, you can see that the long call gives you unlimited upside profit potential (just as being long



the stock does), while being short the put gives you large downside risk (again, just as owning the stock would). An example may help to clarify this statement.

---

*Example:* With Microsoft trading at 92, in July 1995, the Aug 90 call was trading at 6 while the Aug 90 put was trading at 4. An option position that is equivalent to owning the common stock can be constructed by buying the Aug 90 call for 6 and selling the Aug 90 put at 4. We can verify this with a profit table.

---

Stock Price at August Expiration	Profit on Long Stock (\$)	Profit on Long Call (\$)	Profit on Short Put (\$)	Total Option Profit (\$)
70	-2,200	-600	-1,600	-2,200
80	-1,200	-600	-600	-1,200
90	-200	-600	+400	-200
100	+800	+400	+400	+800
110	+1,800	+1,400	+400	+1,800

---

Note that the totals in the second column (Profit on Long Stock) and the last column (Total Option Profit) are the same. This means that the option position and a long stock position are equivalent.

---

This is an important concept that should be routinely understood and used by all traders. First of all, it allows you to use options instead of the underlying. Using the Microsoft stock as an example again, note that if you bought 100 shares for cash, you would have to invest \$9,200 plus a stock commission. However, the *collateral* requirement for the option position is this: first, the call option has to be paid for (\$600), and then the naked put must be collateralized. The requirement for the naked put is 20 percent of the stock's price plus the put premium, less the out-of-the-money amount. So the naked put requires \$1,840 (20 percent of \$9,200), plus \$400 (the price of the put), less \$200 (the two points that the put is out-of-the-money), for a total collateral requirement of \$2,040 for the naked put. The net collateral requirement for the option position is thus:

<i>Position</i>	<i>Requirement</i>
Long Call	\$ 600
Naked Put	+2,040
Put Premium	-400
Total	<u>\$2,240</u>

Therefore, one can have nearly the same profitability as a stock trader for a much smaller collateral requirement. In the preceding Microsoft example, the profit was *exactly* the same whether you bought the stock or used the option strategy. However, if you look at most option prices, the option strategy will not generally have exactly the same profit and loss potential as the underlying stock, although it will be quite close. There are two reasons for this usually small differential: dividends and interest rates.

The stockholder receives the dividend (if there is one), while the option trader does not. The option trader can partially offset the loss of dividend if he uses U.S. Treasury bills (T-bills) as collateral for the position, since he can earn interest on the \$2,000 or so of collateral while the position is in place.

The stock trader is tying up a lot more money. If the option trader invests the difference between the full cost of buying the stock and the collateral he needs for the option position—about \$7,000 in the previous example—in certificates of deposit or in T-bills, he will earn a substantial amount of interest. Without going into detailed calculations to prove it, we state that the difference in the profitability of owning the stock or being in the option position can be offset by investing the \$7,000 in short-term, interest-bearing instruments until the options' expiration date.

There is one other material comparison: the option trader is dealing with *two* bid-asked spreads and must pay two commissions to enter the position. The stock trader only has to be concerned with one of each of those items. In these days of discount commissions, the bid-asked spread is the more important consideration of the two and can be a serious one. Especially if you're dealing with relatively illiquid, or thinly traded, options, you may find that the option position becomes much more expensive than is necessary. In a situation such as this, it's often a good idea to use an option model to check

what the theoretical difference between the call and the put price should be. Then you have some idea as to how to enter the order. A continuation of the same example illustrates this concept.

---

*Example:* Again assume that Microsoft is at 92, but this time you're interested in using the Oct 90 puts and calls in order to establish an option position that is equivalent to a long put position. The actual prices of the October options (in July) were:

<u>Option</u>	<u>Bid-Offer</u>
Oct 90 call	9.00-9.50
Oct 90 put	6.00-6.50

Since there is a half point spread on each option, you might be in danger of "overpaying" for the option position if you merely buy the call and sell the put with a market order. At the market, buying the call and selling the put would cost a debit of 3.50 points (9.50 minus 6.00).

Here's where using an option model comes in handy. If we input 92 as the stock price, 90 as the striking price, October as the expiration date, and the current T-bill interest rate (it makes no difference what volatility we use), the model will tell us that with the stock at 92, the call should sell for 3.27 more than the put. So, one might enter an option order as a spread: "Buy the Oct 90 call and sell the Oct 90 put for a debit of 3.30 points." Using the model in this way would prevent overpaying for the position (recall that it costs 3.50 at the "market" prices).

If the price of the underlying changes, the prices of the put and the call would change in a relative manner also. For example, with Microsoft at 91, the call should then sell for 2.27 more than the put. The model is useful in showing you this information also. So, if you don't receive an execution right away and then Microsoft changes in price, you'll know how to adjust your option order as well.

---

## **Equivalent Short Stock**

Similarly, a short position in the underlying security is equivalent to being both long a put and short a call with the same terms. There are more benefits to the option equivalent position, when comparing it to a short sale of stock, than there were for long stock.

First, you're able to benefit from the reduced collateral requirements—you can “equivalently” short stock on just over 20 percent margin, as opposed to the 50 percent required for shorting the actual stock itself. This benefit is quite similar to the same one for long stock.

When shorting stock, an uptick is required in order to establish the position, in both listed and Nasdaq stocks. However, an uptick is not required to enter into the option position, so it is easier to establish an “equivalent” short sale in a down market. This is especially useful in situations where a stock is breaking down quickly. This may involve a stock that has broken down through a major support level, or it may involve a lot of stocks when the market goes into one of its famous nosedives. With the option equivalent strategy, you can always get “short” (or the equivalent thereof) right away. You may have to use market orders, which give up something in terms of price, but at least you can get the basic position established.

The final benefit for the option position as compared to a short sale is that you don't have to actually borrow the stock to enter into the option position; again, a time-saving and convenient benefit of the option position. It can sometimes take a long time to find stock to borrow, or your broker may not be able to find the stock at all. With the option equivalent strategy, you don't really need to worry about whether the stock is borrowable or not, with the exception pointed out in the next paragraph.

There is one possible complication with the equivalent short position: it *should* be noted, that if the stock is truly difficult to borrow, then you must be careful how you apply the option strategy. You may not be able to sell in-the-money calls as part of your strategy. This problem can be avoided by using a higher striking price—if one exists—so that the put is in-the-money and not the call. In the case of “unborrowable” stock, in-the-money calls may be so cheap that you would have to sell them at or below parity; if that happened, you might receive an early (perhaps immediate) assignment notice—thereby making you short the stock, which you could not fulfill since you can't find the stock to borrow. Your broker would then buy you in at the market and probably wouldn't be too happy with you, either. Your account might even be restricted if he feels you intentionally sold in-the-money calls on a stock that was clearly not borrowable.

Whenever a partial tender offer for stock is pending, there is a very high probability that all existing in-the-money calls will be assigned early. This situation has occurred many times over the years since listed options began trading, but there is always a story of someone who thinks he can make free money. He can't, and he sometimes learns an expensive lesson.

Suppose that a partial tender for half of a company is in progress: \$100 per share will be paid for 50 percent of the stock. The stock is trading at 80, though, because the remainder of the company is expected to trade at a price of 60 in the open market when the partial tender is completed. Thus, the stock will drop in price by \$20 after the tender date is past.

A quick \$20 could be made by any trader who shorted the stock. However, this stock cannot be borrowed because all stockholders want their shares in hand so they can tender them and receive \$100 a share for half of them. So a trader cannot short it.

In-the-money calls on this stock will be selling at parity—for example, a Feb 60 call would be selling at 20 (the stock is at 80, so this is parity). Invariably, some fairly novice option trader, who knows that the stock will drop but can't find any stock to borrow, sells the Feb 60 call for 20 points, as an opening transaction. He can do this because one does not have to borrow an option in order to sell it short. He figures he will cover the option after the stock drops to 60 and make a fortune.

What *really* happens is that the call is exercised by the person who bought it (that person buys stock in this manner and tenders the stock to receive the partial tender price). This exercise results in the novice option trader being assigned on his short call. He normally doesn't find out about this until the day after the tender is over; that is, the stock is all set to begin trading at 60 when he receives the assignment notice. So, he quickly becomes short *stock*; and since the stock can't be borrowed, his brokerage firm will not be happy. First, they will buy him in. But it won't be just a normal buy in the open market at 60. In fact, they will buy him in for *cash* because the stock is owed to someone who has already tendered and needs the stock immediately. The cash market price is going to be something higher than 80, so the novice trader ends up with a loss on the trade and perhaps restrictions on his trading account.

---

The point is that you can expect to be assigned on any call that is sold below parity. The call is trading there for a reason—whether that be an impending tender offer, an impending dividend, or the approach of expiration. If you sell a call at or below parity, you

should be prepared to be short the stock by assignment in a very short time, probably as soon as the next day. If you have reason to expect that the stock is not borrowable, then don't sell an in-the-money call trading near parity, for you will only create problems for yourself.

## Single Stock Futures

One viable use of single stock futures is to replace the option-oriented strategies described in the previous pages. Selling single stock futures, for example, is a lot simpler way to short a stock than is buying a put and selling a call. First of all, there is only one set of bid-asked spreads to deal with and one commission where the single stock futures are concerned. Conversely, someone looking to buy stock on margin—or perhaps thinking of buying an option because of the leverage involved—might choose to buy single stock futures.

Single stock futures owners are not entitled to a stock's dividend. So single stock futures will trade at a discount to the actual stock price if a large dividend is involved. But they will trade at a premium otherwise, and that premium is related to short-term interest rates. In fact, the net effect is that the futures contract will trade with the same premium as the equivalent stock position using options will—as shown in the previous Microsoft example.

The most important thing that a trader must understand about single stock futures is that they have tremendous leverage. Only 20 percent of the stock price is required as initial margin. So, for example, if IBM is trading at 90 and a trader buys a single stock future on IBM, his initial margin would be \$1,800 (20 percent of \$9,000). Since the single stock futures are worth \$100 per point of movement, his margin would be wiped out if IBM fell to 72, that is, if it declined by 18 points or 20 percent. Moreover, if some unforeseen circumstance should occur and IBM should fall by more than 18 points, then the single stock futures trader would lose more than 100 percent of his initial investment. Short sellers face similar peril if a stock should rise by more than 20 percent.

Even so, when one wants a derivative to mimic stock price movements, nothing serves the purpose better than a single stock futures

contract, as long as one is willing to assume the risk that such leverage entails.

### **Defending against a Limit Move in Futures Contracts**

All futures contracts are limited in the amount by which their price can change in any one day. The exchange where the future is traded determines the size of that daily limit. Limit moves usually occur as a result of an unexpected increase in supply or demand, perhaps caused by weather (storms or droughts), cartels (OPEC), or an unexpected government crop report. The greatest fear that any futures trader has is that he will get caught on the wrong side of a prolonged limit move and not be able to get out of his position. If this happens, huge losses could occur.

However, whenever there are listed futures options trading, the trader can extract himself from a limit move at any time. This strategy—using options as the equivalent of the underlying—is *mandatory* knowledge for every futures trader, for it can allow him to remove himself from a position that is locked limit against him. This knowledge can keep a loss small, preventing it from ballooning out of control to the point where the account might even be wiped out.

---

In late January of 1993, lumber had an extended move, trading up the limit several days in a row. March lumber futures were trading at 279 when housing starts were reported to be a very positive number. This expected increase in demand for lumber caused the futures to rise the five-point limit and lock there, limit up at 284, for the remainder of the day. The next seven(!) days, lumber was also up the five-point limit with virtually no trading taking place. Buyers were bidding, but there were very, very few willing sellers as more bullish statistics regarding housing sales and building projections were released by the government. As with many commodity futures, the limit increases if it is repeatedly hit. So after the eighth day of limit moves, the limit was increased to 10 points. Still, the demand was so great that the futures locked limit up for two more days! It now had risen to 339, and virtually no trades had taken place for 10 days. Short sellers were on the verge of being wiped out, since a one-point move in lumber is worth \$160.

So, the 55-point move from 284 to 339 was costing shorts \$8,800 per contract.

Worse yet, the bull move was far from over, and the limit was raised to 15 points. After trading off the limit for a few hours on the 11th day, the futures contract locked limit up once again. Even the increased trading limit still couldn't stem the tide. Over the next nine days, lumber closed limit up eight times. Moreover, on five of those nine days, it was locked limit up all day. By this time March lumber was trading at 441. Thus, the loss on one short contract—if it was not covered during the few times that there had been free trading—had now reached 157 points, or \$25,120!

This was a classic case where options could have saved the shorts a great deal of money. Lumber traders who understood options could have covered on that first day, when the futures locked limit up at 284. They would have paid a price of about 288 to cover their position. Thus, they could have taken a 4-point loss, even after the series of limit moves had begun, as compared to the 55-point, or 157-point, losses that nonoption traders had to sustain. Moreover, option traders, if they didn't cover that first day, could have covered any day thereafter that they wanted to, although it got more expensive to do so each day.

---

Veteran futures traders can relate many horror stories of being caught on the wrong side of extended limit moves. A couple of others that come to mind are orange juice, in the fall of 1991, when it rose from 127 to 168 on a series of six limit moves without any chance to cover. Since orange juice is worth \$150 per point, that translated into a \$7,650 loss per contract. Also, in the spring of 1995, cotton futures sustained a series of limit moves *in both directions!* The wildest action came when the July contract was first limit *down* for five days in a row. Then, after a couple of days of free trading, it was *up* the limit for eight days in a row. In fact, cotton continued to be crazy all summer, with several others series of limit moves taking place.

In this section, we have talked about only two equivalences: (1) long call plus short put is equivalent to being long the underlying, and (2) short call plus long put is equivalent to being short the underlying. It is these two concepts that can save the skin of any futures trader. *If you are trading futures and you don't understand this concept, then stop trading futures or learn the concept.* You have no other



choice, in my opinion. Let's use the lumber futures and their options, from the narrative, to look at just how this works.

---

*Example:* On the first day that November lumber locked limit up at 285, the Nov 285 call settled at 8 and the Nov 285 put settled at 5. Now, normally, a futures put and call with the same terms would trade for the same price when the underlying futures settle right at their striking price. However, that is not necessarily the case when limit moves are involved, because the options are “predicting” where the futures should be trading, were they allowed to trade freely.

Suppose that we are viewing this situation from the viewpoint of a trader who is short the November lumber futures contract, which is now locked limit up. He could have bought the Nov 285 call for 8 and sold the Nov 285 put for 5, a 3-point debit. By executing this simple trade, he would have eliminated any further risk for himself. His option trades—long call and short put—are the equivalent of being long November lumber futures, and his futures position is short November lumber futures. Therefore, the sum of the two is a flattened position. Moreover, the price at which he has covered the futures is equal to the striking price plus the debit of the option position, or  $285 + 3 = 288$  in this case.

In order to verify this, note that if futures continue to rise, he will eventually be able to exercise his long call at expiration (or if it becomes very deep in-the-money and loses its time value premium). The call exercise means he buys lumber futures at 285, no matter how high they actually are at the time of the exercise. Since he also paid the 3-point debit for the option position, he has a net cost of 288 ( $285 + 3$ ) for covering his futures. Thus, he was able to cover his short futures at 288, saving himself countless heartaches as the ensuing bull move developed—a move that trapped the shorts who didn't understand this concept.

---

Note that if the lumber futures had suddenly plunged after the trader established his option position (long call and short put), it would have made no difference to him in terms of his exit price. Although this didn't really happen, suppose that lumber futures had fallen to 225 or so. Eventually, he would be assigned on his short put. That assignment means he would buy the futures at 285, the striking price. Again, he must add the 3-point debit that he originally paid for the option position, so his net cost for covering the futures would again be 288. Thus, no matter which way futures go after the option trade

is established, he has locked himself into a buy at 288. He has no further risk or reward potential once the option trade is established; he has equivalently covered his short at 288.

Oftentimes, it's best to take the first loss—it may be the smallest one. In the case of lumber, that first loss would have involved using options to equivalently cover the short at 288. In the real-life lumber example, things got much worse as time passed. By the time lumber had risen the daily limit for six days in a row and had reached 335, the options were priced quite a bit higher than the market. In fact, the following prices were quoted at that time:

November lumber: 335 (limit bid)  
 Nov 335 calls: 30  
 Nov 335 puts: 12

If the short seller had waited this long to attempt to cover, he would have had to pay a greater premium over the settlement price. In fact, if he bought the calls at 30 and sold the puts at 12, this would entail an 18-point debit. Thus, his eventual buy price would be the striking price plus the debit,  $335 + 18 = 353$ . So, you can see that as more and more limit days piled up, the options began to get more and more expensive. Still, covering at 353 was a bargain compared to waiting until 460, when the bull move finally ended.

This strategy would have been a welcome one for cotton traders in the spring of 1995 when, as mentioned earlier, the futures traded limit down for five days and then shortly after traded limit up for eight days. Think how frustrating it would have been to be short the cotton futures and have a nice unrealized gain, only to get caught in the limit up moves and give it all back. Cotton traders who understood options wouldn't have worried, for on the first limit up day, they could have executed the long-call–short-put option strategy (equivalently covering their short position) and locked in their profits at that time.

Traders who are *long* and who get trapped in a series of down limit moves can use the companion option strategy to extract themselves. They would buy the put and sell the call in order to establish an option position that is the equivalent of a short futures contract. This would then offset their long futures contract that they actually

own, and the loss would be locked in. There would be no further risk (or reward either).

In summary, futures traders must understand this strategy. It does not prevent losses from ever occurring, but it does allow one to take his losses when he wants. He will never be “caught” by a series of limit moves and have to stand helplessly by while his equity dissipates. As to *when* you should use the option strategy, I would use it when the futures trade through your stop price. For example, if you were short November lumber that day and had a stop in to cover at 289.25, your stop was never executed because the futures jumped from 285 to 290 and no trades took place—not even at 290. I would *then* step in and execute the option strategy because the stop price had been exceeded.

## **OPTIONS AS A PROXY FOR THE UNDERLYING**

In the first part of this chapter, we discussed how to use options to completely replicate a position in the underlying security. Another useful option tactic is to use options as a *proxy* for the underlying. Generally, this is done when you want more leverage or less risk, or both, than the underlying security itself possesses.

### **Option Buying as a Short-Term Stock Substitute**

In Chapter 1, we dealt with buying calls as a substitute for buying stock or futures. The idea was to use an in-the-money call option for that purpose, for it provides leverage but also is not so subject to the ravages of time decay. The in-the-money option has very little time value premium to begin with.

The same philosophy can be applied to buying short-term, in-the-money puts as a proxy for shorting stock. This has the additional advantages that we described when we discussed fully equivalent positions: the short sale proxy can be obtained without needing an

uptick; and, in the case of common stock, there is no borrowing necessary. Moreover, since in-the-money puts generally have even less time value premium than in-the-money calls do, it is usually quite easy to find an in-the-money put that has very little time value premium. In both cases, the in-the-money option will mirror almost all of the short-term movement of the underlying. This is an especially attractive feature for a short-term trader.

### **Option Buying as a Long-Term Stock Substitute**

Short-term traders aren't the only ones who can benefit from the limited-risk nature of owning a call as opposed to owning the underlying security. Investors with a longer-term viewpoint can avail themselves of this feature as well; they could substitute a long in-the-money call for their long stock. As long-term calls (LEAPS) have become more popular, brokers have been advising investors of the benefits of selling the stock they own and buying LEAPS as a substitute, or buying LEAPS instead of making an initial purchase in a particular common stock. This strategy also increases in popularity during long bullish runs in the stock market.

If an investor sells his stock and buys a call option, he has removed quite a bit of money from the market. He should then take that money and buy a bank certificate of deposit (CD) or a T-bill whose maturity more or less matches the expiration date of the option he purchased. The option gives him upside profit potential, while most of his money is safe in CDs or T-bills. Even if things go terribly awry and the stock collapses and the option expires worthless, he will still have his money in the bank, plus the interest earned by the CD or T-bill.

The costs to the stock owner who decides to use this strategy are commissions, the time value premium of the call, and the loss of dividends. The benefits are the interest that can be earned from freeing up a substantial portion of his funds, plus the fact that there is less downside risk in owning the call than in owning the stock. There generally is a *net cost of switching*; that is, the interest earned won't completely offset the loss of the dividend, the time premium, and the

commissions. The investor must decide if it is worth that cost in order to have his downside risk limited over the life of the LEAPS options.

The cost to switch may seem like a reasonably small price to pay to remove a lot of downside risk. However, one detriment that might exist is that the underlying common stock might declare an increased dividend or, even worse, a special cash dividend. The LEAPS call owner would not be entitled to that dividend increase—in whatever form—while, obviously, the common stock owner would be. If the company declared a stock split or a stock dividend, it would have no effect on this strategy since the call owner is entitled to a stock split or stock dividend.

There may be other mitigating circumstances involving tax considerations. If the stock is currently a profitable investment, the sale would generate a capital gain, and taxes might be owed. If the stock is currently being held at a loss, the purchase of the call would constitute a wash sale, and the loss could not be taken at the current time.

## **Using LEAPS Puts instead of Calls**

In the preceding strategy, the stock owner paid some cost in order to limit the risk of his stock ownership to a fixed price. He might be able to accomplish the same thing at a lower cost to himself. If he buys a LEAPS put against the stock that he owns, he has a position that is *equivalent* to owning a LEAPS call. He would still have upside profit potential (now in the form of long stock), he would have downside protection (provided by the long put), he would have spent less in commissions (only the commission for the put), and he might not disturb the tax holding period of his stock.

The comparison between substituting a call or buying a put is a relatively simple one. Merely compare the cost of switching with the cost of the put. If arbitrageurs are doing their job, the put will most likely be the better way to go. Moreover, capital gains don't have to be realized with this method. The purchase of a put may suspend his holding period for tax purposes (if he is not already a long-term holder), but the LEAPS call strategy had its own tax complications. Moreover, he would remain fully represented for all dividends since he continues to own the common stock.

Whether the strategist uses the put or the call, if the underlying stock rises in value, he will want to sell the LEAPS option he owns and buy another one with a higher strike, in order to further protect the profits that build up as the stock rises.

In my opinion, the purchase of a LEAPS put is a more efficient way to protect long stock. However, the former strategy—selling the stock and replacing it with a long call—is usually preferred by brokerage firms.

## **THE EFFECT OF STOCK INDEX FUTURES ON THE STOCK MARKET**

The strategy of buying puts on individual equities in order to protect them from downside loss is the simplest usage of a derivative security to hedge a position. Another simple strategy is to sell index futures against stock holdings. The main problem with doing that is that it removes the upside potential from one's portfolio, a distasteful alternative to almost all stockholders. There are more complex strategies, of course, most of which have to do with hedging an entire portfolio of stocks with derivatives.

The idea of using derivatives to insure a portfolio of stocks first achieved recognition in the mid-1980s when the term *portfolio insurance* became widespread. At that time, the theory involved selling Standard & Poor's (S&P) 500 futures contracts against a portfolio of stocks in a particular manner. Since there are a couple of other strategies that also involve selling S&P 500 futures against a portfolio of stocks—index arbitrage and program trading—the various strategies are often confused with each other, especially by the media. There are also theories that involve the purchase of index *put* options to protect portfolios. We explore these various strategies in this section.

First, it may be useful to spend some time clarifying the three strategies involving futures before we actually approach the topic of how portfolio insurance is structured today. These futures strategies often have an effect on the movements of the overall stock market, so it is important for nearly all stock traders to understand these effects.

## Index Arbitrage

*Index arbitrage* is the easiest one to understand, for in this strategy the arbitrageur takes a position in a stock index futures contract and takes exactly the opposite position in the stocks themselves. For example, an arbitrageur might sell the S&P 500 futures and more or less simultaneously buy the correct amount of each of those 500 stocks, in order to set up a perfect hedge. With computerized trading, 500 stocks can be bought almost simultaneously with the push of a button.

*Arbitrage*, by the way, is merely *the simultaneous buying and selling of the same thing in two different forms*. For arbitrage to be profitable, the arbitrageur must have at least a small positive differential in price between what he buys and what he sells. One common example involves the strategy that we have spent a great deal of this chapter discussing—using options to establish a position that is equivalent to the underlying security. Thus, if you buy a call and sell a put, you have a position that is equivalent to long stock. If you then short the underlying stock, you have an arbitrage, because you bought the stock in one form (the option equivalent form) and sold the stock itself. Most of the time, arbitrage produces a profit that is only a fraction of a point; however, when done repeatedly, these profits add up. There are countless ways in which arbitrage can be done, but usually only member firms can trade arbitrage profitably, because commissions would wipe out the profits for a public trader or customer.

Arbitrage is an ancient and widely practiced trading method. It is both useful and necessary, especially in the derivatives markets, in order to provide liquidity and depth to markets. If arbitrage is not possible in a derivative contract, or if arbitrage is extremely difficult, the contract often fails within a short period of time.

Now let's return to index arbitrage, specifically. If an index arbitrage is established at favorable prices, the arbitrageur locks in a guaranteed profit on the trade. It may behoove us to spend a minute explaining *why* and *when* index arbitrage is profitable, for that knowledge is necessary for any day trader of index futures contracts, particularly, the S&P 500 Index futures. On any day, the trader can calculate the *fair value* of the S&P 500 futures contract. This fair

value is a function of only four things: (1) the price of the S&P 500 Cash Index, (2) interest rates, (3) the time until the contract expires, and (4) dividends on the S&P 500 stocks themselves. The actual formula is

$$\text{Fair value of S\&P futures} = [\text{SPX} \times (1 + r)^t] - \text{dividends}$$

where SPX = S&P 500 Cash Index,  $r$  = the risk-free interest rate, and  $t$  = time remaining in years.

*Example:* Suppose the S&P 500 Cash Index is trading at 561.00. Also, there are 51 days remaining until the contract expires, short-term T-bill rates are 6 percent, and the total of all dividends to be paid by the S&P 500 stocks during the next 51 days is \$3.23. Note that 51 days is 0.1397 year.

$$\begin{aligned} \text{Fair value} &= [561.00 \times (1.06)^{0.1397}] - 3.23 \\ &= [561.00 \times 1.0082] - 3.23 = 562.36 \end{aligned}$$

Sometimes the fair value is stated strictly in terms of the premium of the futures contract, which in this case is  $562.36 - 561.00 = 1.36$ , premium.

The premium of the futures versus the cash index fluctuates during the trading day as supply and demand forces the market around. If the futures acquire too much premium (we'll define *too much* shortly), they are said to be expensive; and arbitrageurs will sell the futures and buy stocks. This action alone will force the stock market higher for a short while, until the excess premium is removed from the futures. Since the arbitrageurs are *selling* futures at the same time that they are buying stocks, it usually only takes a short time before the arbitrage opportunity disappears—the arbitrageurs' own actions force the premium of the futures versus the cash index to shrink.

In a similar manner, the futures may trade down below fair value; that is, they are said to be trading at a "discount" [to fair value]. If futures get too cheap, then arbitrage can be done in the opposite manner: futures are bought and stocks are sold. If the arbitrageur has no position prior to establishing this position, then he must sell the stocks *short*. Since selling stocks short requires that they be sold on



upticks, this form of arbitrage is more difficult to enact. However, many arbitrage firms will initially buy stocks and sell futures at fair value—meaning they have no profit in the position—in order to have “ammunition” to be able to sell stocks (long) and buy futures when the futures go to extreme discounts.

Index arbitrage is available almost every trading day. All the arbitrageur (arb) needs in order to make money is for the futures premium to deviate from fair value by an amount large enough to cover the arb’s transaction costs (which are low).

---

*Example:* Suppose again that the fair value for the S&P 500 futures premium is 1.36, as in the previous example. Arbitrageurs have quote machines that can display the S&P 500 Index in at least three ways: the last sale value (which is what is widely disseminated), the bid value, and the offer value. For example, the offer value would be the price that the arb would pay for the S&P 500 Cash Index if he were able to buy all 500 stocks on their current offering price.

An arb sees that the S&P 500 Cash Index is trading at 561.00 and the Index is offered at 561.50; that is, it would actually cost 561.50 for the arb to buy the Index in its correct composition (the proper amount of all 500 stocks). Furthermore, he notes that the futures are running to the upside, and they are currently selling at 563.75. So, if he could sell futures at 563.75 and buy the Cash Index on the offering at 561.50, he would have established the arbitrage at a 2.25-point differential. Since fair value is only 1.36, this means that he has 0.89 profit in his pocket (2.25 minus 1.36, less transaction costs, which will be quite small).

---

In reality, our mythical arbitrageur is not the only person in town who sees this opportunity. In fact, *every* index arbitrageur sees this opportunity on his quote machine. Therefore, they may all rush in at once to execute the arbitrage. This causes two things to happen: (1) the arbitrage opportunity usually disappears quickly, and (2) none of them actually get to buy the S&P 500 Cash Index at 561.50 because they are all forcing prices higher.

So, in reality, an index arbitrageur builds in a “fudge factor,” or slippage, to account for the fact that he may have to buy the Cash Index at a higher price than is shown on his screen. Most arbitrageurs want to see the futures at least 0.70 to 0.90 overvalued or

undervalued before they will attempt to execute the arbitrage. For this reason, we do not constantly see the stock market being buffeted by buying and selling from index arbitrageurs. The futures don't normally get that far away from fair value; but, as stated earlier, they do get far enough out of line at least once or twice a day, almost every day, for arbitrage to be profitably established.

I have noticed a very easy way to tell if buy or sell arbitrage is actively being done in the market: watch an indicator called TICKI. It can be quoted on all the major quote machines. It is the *net* upticks or downticks of the 30 stocks in the Dow Jones Industrials. Therefore, its maximum value is +30 and its minimum value is -30. If TICKI rises to +22 or higher, you can be sure that computerized buy programs are being executed; if TICKI falls to -22 or lower, computerized sell programs are taking place. A trading system using this indicator is explained in Chapter 5.

So, the action of index arbitrage being established causes short-term movements in the stock market. However, it also causes the arbitrage opportunity to disappear (in theory), so index arbitrage does not have a lasting effect on the market. It may all be over within a matter of minutes, depending on what causes the futures to be mispriced in the first place. In fact, you may wonder why the futures ever get overpriced or underpriced to begin with. Usually, it is because someone who is not interested in arbitrage decides to take a relatively large position in the futures. What follows is one of history's classic examples.

---

In the winter of 1995, Barings Bank collapsed under the weight of a now-infamous trader who overextended the bank's resources. Many people still don't understand what happened there, but we can summarize the debacle: the trader sold naked straddles on the Japanese stock market; and then, when the market suffered a rather severe and quick decline, he didn't cover the naked short straddles. Instead, he bought index futures in an attempt to force the entire Japanese stock market higher in order to bring his position back to profitability. Perhaps the first part of this story belongs in Chapter 2, along with the discussion of selling naked straddles, but we prefer it here because it relates to index arbitrage as well.

Once the market fell initially, it was at levels below the break-even price of the straddles. The trader then decided to buy index futures on the

Japanese stock market. He was able to buy these on small amounts of margin. As he bought enough of these futures, he created a large premium on the futures. This attracted index arbitrageurs, who actually bought Japanese stocks and sold the futures. Thus, the arbitrageurs were in fact forcing the Japanese stock market higher, but only briefly. After each bout of arbitrage buying, the index futures returned to approximately fair value, and the Barings trader had to buy more futures and start the cycle all over again.

By the time that Barings ran out of money, the strategy had worked to a certain degree—open interest in the Japanese index futures was at its largest level in history, indicating that plenty of index arbitrageurs were loaded to the gills with positions. Unfortunately, the Japanese stock market dropped farther, due to natural market activity; and Barings was wiped out, for they not only were short straddles but now were also long massive amounts of index futures. Add to that the fact that they had bought those futures at inflated prices, which added more to the losses, and you have the story of how a long-standing institution went out of business in a very short time. The *real* problem, of course, was that the trader—or his supervisors—should have covered some or all of the short puts when the naked straddles first got into trouble. This would have meant taking a loss, but they would have still been in business.

---

## **Portfolio Insurance**

Now let's move on to the second of the three strategies that involve selling index futures against stocks that are owned, portfolio insurance. Many portfolio managers in the mid-1980s were attracted to the protective quality of owning puts against their stocks, but they didn't like the cost of the (expensive) puts. If the market continued to rise, the puts that the manager bought would expire worthless, and his performance would suffer in comparison to both his competitors who didn't buy puts and the overall stock market.

Despite this aversion to paying put premiums, the fast-rising markets of those years—which saw the Dow Jones Industrials nearly triple between 1982 and 1987—were making stockholders nervous; and there was demand for a product that would offer downside protection without having the onerous cost of owning puts. In addition, the protection should still afford room for upside appreciation if the market continued to rise.

In response to this demand, a strategy was created that was termed *portfolio insurance*. In essence, it worked like this: initially, the stockholder did nothing to hedge his stock position. However, if the market dropped by a certain fixed amount, then the portfolio manager would sell futures against a portion of his holdings, perhaps 10 percent to 20 percent on this first sale. Then, if the market dropped further, more futures would be sold to provide more protection. Finally, if the market dropped far enough, enough futures would be sold so that the entire portfolio would be protected. This strategy had several attractive features. First, even though futures weren't sold until the market started to fall, if the strategy was executed properly, the only loss to the portfolio would be approximately the same as the time value premium if puts had been bought in the first place. Second, if the market rallied initially, then there was no expense at all since no futures were sold. Finally, the portfolio manager was getting the benefit of selling futures, which trade at a premium to the cash index, so he eventually would be making a small profit from that premium as well. On paper, the mathematics all worked out, and the strategy attracted several large institutions as practitioners.

Unfortunately, there was one flaw in the strategy, a flaw that is common to many theoretical attempts at trading in the market: it assumed a relatively stable and rational market environment in which to operate. This flaw led to disaster and was the main reason why the crash of 1987 became a crash, rather than just a very nasty downturn in the market.

---

The stock market had peaked at just over 2,700 in late August of 1987 (the rally had begun from just below Dow 800 in August of 1982). It then fell back to about 2,500 but rallied again to 2,640 by the first week in October. Some portfolio insurance was sold on that drop, and things seemed to be working fairly well, as intended.

The first sign that things might be getting dicey was a 92-point, one-day drop on October 6. However, the market seemed to weather that; and, although it slid some over the next week, there was actually a good rally on Tuesday, October 13, when the market was up over 70 points at midday and managed to close nearly 40 points higher, at just over 2,500. Again, the decline was orderly enough for most of the portfolio insurance to be sold, although rumors were circulating that some portfolio managers were

now becoming traders and hadn't sold all the futures that they were supposed to. They were waiting for a further rally back toward 2,600. That rally never came (not for a couple of years, anyway).

Trouble began on Wednesday, Thursday, and Friday, October 14 through 16. The market was down 96, 57, and 109 points, respectively, on those three days. The swiftness of the decline left the portfolio insurance managers gasping for breath. They did not sell the required number of futures for two reasons: (1) the decline was so fast that it was almost impossible to sell that many futures in so short a time, and (2) the futures were trading at discounts to fair value, a fact not accounted for in the theory of the strategy. Thus, some of the portfolio managers did nothing (with the exception of praying, perhaps). To their dismay, their stocks were losing huge chunks of value; and they were not getting the protection that they had theorized from their short futures, since they were not short nearly as many futures as they were supposed to be.

Monday, October 19, only made the problem worse. The market gapped down 200 points right on the opening, and the portfolio insurance crowd hoped against hope for a reflex rally. When that rally did not materialize by about noon, they decided that they had to catch up on their futures selling and at least hold the losses to their current levels (the Dow was now just over the 2,000 level). So they waded in and sold futures . . . and sold futures . . . and sold even more futures. They were selling futures at 15.00 points discount to parity (forget fair value; forget theory; just sell the required number of futures!). Many professionals who were long stock realized that they could sell their long stocks and buy futures and lock in 15 points, so they did that. This added more selling pressure to the market, which continued to collapse until it finished off 508 points on that fateful day.

---

Obviously, there was plenty of natural selling in the stock market on the days leading up to, and including, October 19. But the portfolio insurance strategy exacerbated the decline to disastrous proportions. No one knows the exact extent to which portfolio insurance contributed to the debacle, but it was substantial. Not only that, the institutions practicing the strategy got hammered anyway, as they never did get their protection properly in place. In addition, they became the subject of derision from Wall Street; government investigations were initiated; and, in general, things were very uncomfortable.

This fiasco pretty much ended the strategy of portfolio insurance as practiced with index futures. Two new measures that came out of the government investigation were that index futures trading limits be installed and that futures halt trading at various points if the Dow Jones Industrials should rise or fall too far, too fast. These rule changes effectively wiped out the portfolio insurance strategy using futures, for no money manager could ever trust that he would be able to sell his futures when he wanted to, even if he religiously followed the strategy to the letter. If the futures were locked limit down or if they weren't available for trading, then he would never be able to sell the required number of futures.

## **Program Trading**

Today, portfolio insurance is conducted with put options, which brings its own brand of problems. We discuss that strategy using puts shortly. First, however, let's touch on the third use of futures as a hedge to a stock portfolio, program trading. This term is the catchall for all forms of computer-generated buy or sell programs that enter the marketplace. You often hear the financial media blame a market decline on "sell programs" or credit "buy programs" for a market advance. In reality, many of those "programs" are index arbitrage, but the media don't make the distinction.

To professional traders who hedge stocks with futures, *program trading* has a distinctly different definition from index arbitrage. The name originally came from the functions provided by block desks to hedge themselves (or their customers) while large stock orders, or programs, were executed. A large customer might call one of the larger trading houses and give an order to buy millions of dollars worth of stock, say, by the close of trading. Usually, there is some sort of price level at which the trading house attempts to fill the order; otherwise, the client could pay up wildly for the stocks. If the trading house actually has to pay more for the stocks, it still gives the execution to the client at the client's price and takes a loss for the difference in the house's error account.

Since these trading houses are not in the business of losing money, they will often hedge themselves by buying some futures

while also buying the stocks. Then, if the stock buying forces the overall market too high and they are looking at losses in order to satisfy the customer's prices, at least they will have some profit from the futures to offset those losses.

---

Suppose a large customer calls a major trading house and says that he has \$30 million worth of stock to buy and that there are about 200 stocks that comprise the order. In order to get the order, the trading house may tell the customer that he can get the best execution through them, because they will guarantee the prices at the time that the order is received.

Now, obviously, the trading firm can't really do that without taking some risk, but they will risk a little in order to get the customer's business. If they decide that the 200 stocks behave in a manner that is essentially the same as the S&P 500, they might buy S&P 500 futures as a hedge. Thirty million dollars is about 200 futures contracts if the futures are trading at a price near 600.

So the trading firm buys 200 futures and then sets about buying the stocks. If they have to pay more for the stock than the price they promised the customer, that will be a cost of doing business. However, that cost is offset by a similar profit in the futures. As the stocks are bought, the futures are sold out.

---

Note that the futures and the stocks are *both* being bought in this case. The futures are sold out when their hedging function is no longer needed. When these programs are executed, the market jumps, the futures often get large premium, and index arbitrage may be a by-product. Also, the TICKI Indicator, which we mentioned earlier, usually registers a high number (over +22) as well.

Because analytic methods have become more sophisticated, it has become possible for clients and traders to determine how many index futures, and *which* index futures, are best used to simulate almost any diverse portfolio of common stocks. This has allowed trading houses to be very competitive in their business, for those with better hedging techniques can offer an institutional client better prices (whether buying or selling). Thus, the larger institutions will often show a program out for bids before deciding which trading house gets the order. The institution has to be rather secretive about

the actual details of the portfolio, however, or else the information would be leaked all over Wall Street.

So, *program trading* is a more general term that describes the machinations involved in these institutional buy or sell orders. The entire process works in reverse when large quantities of stock are being sold; the trading houses will sell futures to hedge their risk while they execute the client's sell order. In some cases, the trading house may be able to execute the order for the client (probably via loading it into a computer and letting the computer generate orders) without using futures at all. This would still qualify as a buy program or a sell program, even though the general public and the media associate futures with programs.

In summary, these three strategies—index arbitrage, portfolio insurance, and program trading—are ways in which large traders hedge portfolios of stocks with index futures. When the strategies are initially executed, there is a short-term effect on the stock market, as it accelerates up or down, depending on whether stocks are being bought or sold as part of the strategy. In general, however, this effect is short-lived and the market quickly returns to an equilibrium state.

## **THE EFFECT OF INDEX FUTURES AND INDEX OPTION EXPIRATION ON THE STOCK MARKET**

As long as we're discussing the effect that futures have on the stock market, we might as well address a related topic: their effect at expiration. Sometimes, expiring options and futures have a rather large influence on the market. This effect used to be limited mostly to expiration day itself, but in recent years it has expanded to the point where there may be an effect at certain times preceding and following expiration also.

The reason that there is a noticeable expiration effect is related to the fact that the index futures and options settle for *cash*, while the common stocks that are used to hedge them settle for actual shares of stock. Thus, even if the position is a perfectly hedged arbitrage



position, only the stock side is traded at expiration—the futures automatically settle for cash without any trade taking place.

---

*Example:* The final cash settlement price of the S&P 500 futures is determined, somewhat artificially, by using the opening price of each of the 500 stocks in the index on expiration day (the third Friday of the expiration month). Suppose that an index arbitrageur has a perfectly hedged position, in which he is long all 500 of the stocks in the S&P 500 Cash Index in their proper proportions and is simultaneously short enough S&P 500 futures in order to perfectly hedge the stocks.

If the arbitrageur decided to remove his position at expiration, all he would have to do would be to sell each stock at its opening price on expiration day (he uses “market on open” sell orders). By definition, if each stock were sold on the opening, the eventual price that he received for selling his stock portfolio would be exactly the same as the cash settlement price of the S&P 500 futures. Thus, he would remove his arbitrage at parity, receiving the same price for both his long side (stocks) and his short side (futures).

The by-product of having executed the removal of this completely hedged arbitrage position, however, is that a lot of stock is sold. Thus, the stock market would be down on the opening, for no reason other than index arbitrageurs were removing positions.

---

Where index options are concerned, the position is slightly different, but the result is the same. If you owned all 100 of the S&P 100 Index (OEX) stocks in their proper proportion, your hedge would be short OEX calls and long OEX puts, where both the puts and the calls have the same terms (same expiration date and striking price). From the discussion at the beginning of this chapter, you know that being short the calls and long the puts is equivalent to being short OEX itself. So, in effect, the OEX arbitrageur in this case is long the physical OEX stocks and is short the equivalent of OEX, or, as it is commonly called, an “equivalent futures position” (EFP).

The “artificial” effect that the index expiration has on the stock market has bothered (and still does bother) some investors, mostly those who don’t trade derivatives; and they are usually only bothered if the market is driven *down* artificially. If the arbs are short stock and long futures, then they must *buy* stock to remove their positions,

which forces the market higher at expiration and is normally okay with the critics.

Note that arbitrageurs don't *have* to remove their position at expiration. Instead, they might roll their futures or options out to the next month. If they do this, then of course, that has zero effect on the stock market because no physical stocks are bought or sold. The arbitrageurs make an economic determination, based on dividends, interest rates, and the prices of the respective futures or options, in order to decide whether to remove the position at expiration or to roll it out to an ensuing expiration month.

A little history of how the S&P futures expiration has evolved over the years might be useful. Initially, S&P 500 futures settled at the close of trading on that third Friday, expiration day. This created rather wide swings because the New York Stock Exchange (NYSE) specialist was being bombarded with large sell orders (for example) at what is generally an illiquid time—late Friday afternoon. Moreover, OEX arbitrage was also sizable and was being unwound at the same time, generally in the same direction.

In order to dampen the expiration effect, the S&P 500 contracts and many other futures and option contracts were switched to *opening settlement*. Opening settlement is what was described in the previous example, where the opening price of each stock is used to determine the actual cash settlement price. (*Note:* when a futures or option contract has opening settlement on Friday morning, then the last trades in the contracts themselves take place at the close of trading on Thursday night—they do not trade on Friday morning.) By doing things this way, the specialist can attempt to round up large institutions and brokerage firms to help him with the trade; if a large quantity of stock is being sold by an arbitrageur, the specialist may be able to find several institutions willing to buy part of that block of stock. This might delay the opening of the stock, but it generally allows for less of a gap opening and, therefore, less of an effect on the overall stock market itself.

---

In reality, the perception for arbitrage to have a large effect on the stock market was always larger than any actual effect. The movements on the

expiration Fridays during the mid- to late 1980s are listed below. You can see that there was never any huge effect on the quarterly expirations, when the S&P 500 futures expired:

<i>Date</i>	<i>Dow Change</i>	<i>% Change</i>	<i>Date</i>	<i>Dow Change</i>	<i>% Change</i>
9/83	+10	0.8	9/86	-12	-0.7
12/83	+6	0.5	12/86	+16	0.8
3/84	+17	1.4	3/87	+34	1.5
6/84	-11	-1.0	6/87	+12	0.5
9/84	-21	-1.7	9/87	+27	1.1
12/84	-5	-0.4	12/87	+51	2.6
3/85	-13	-1.0	3/88	+1	0.0
6/85	+25	1.9	6/88	+10	0.5
9/85	-9	-0.7	9/88	+6	0.3
12/85	0	0.0	12/88	+17	0.8
3/86	-36	-2.0	3/89	-48	-2.1
6/86	24	1.3	6/89	+6	0.2

The opening settlement went into effect for the December 1987 expiration. You can see that the two biggest moves on the chart occurred *after* the opening settlement was created, so it is debatable whether it helps much. In theory, however, it does; and it is certainly here to stay, at least as far as the S&P 500 futures are concerned. By the way, if you look at the monthly expirations between the quarterly expiration, which are predominantly influenced by OEX, you will find even less volatility in general (the one exception being October of 1987, of course—but what happened that day [down 109 points] was far greater than any expiration effect of OEX options).

Most other index futures and index options use an opening settlement as well. The main exception is the OEX Index options, which continue to use a closing settlement. This is mostly due to the fact that the Chicago Board Options Exchange (CBOE—where the options trade) is reluctant to tamper with a highly successful contract, which is certainly a valid point.

## **Games People Play**

If you were able to discern, in advance, what the intentions of the arbitrageurs were and how much stock they had to buy or sell, then

you could make a nice little trade for yourself. That is, if you knew that the OEX arbs were going to buy a lot of stock at the close of trading on expiration, then you could wait until about 3:30 P.M. Eastern time and buy OEX in- or at-the-money calls, expiring that day. When the arbs bought stock to unwind their positions and thereby forced OEX quickly higher, you would profit.

Since things are never that easy on Wall Street, you might correctly suspect that it is not an easy matter to find out what the arbs intend to do at any expiration. However, because of the fast potential rewards, it is an endeavor that many traders undertake, trying to predict the stock market's movement as affected by expiration unwinding of arbitrage positions. It is my opinion that the best index to use for this type of short-term trading is OEX, as the moves occur at the end of the day. On the other hand, if you attempt to play the S&P 500 expiration, you must hold a position overnight from Thursday night to the opening on Friday morning (recall that SPX is opening settlement on Friday morning, but there is no trading of SPX options or S&P 500 futures after Thursday's close). Too many things can happen overnight, especially since many government statistics are released prior to the opening on a Friday. Such nonexpiration factors can affect the expiration, so I feel you're better off trying to trade the OEX expiration.

If you're going to trade the expiration, but not as an arbitrageur, the three things you should attempt to determine are (1) whether the arbs are long or short stock coming into the expiration, (2) if they are going to unwind their positions or are going to roll them, and (3) what the open interest in in-the-money OEX calls looks like. It turns out that a good floor source can give you the best information on the first two. The reason that this is true is that the arbs will *always* attempt to roll their position out to the next expiration month if they can; it is a lot of work to establish these arbitrage positions (whether 100 or 500 stocks are involved), so it's a lot easier for the arbs if they can keep their stocks and merely roll their options. But they will only execute the roll at a price that is favorable to them; if they can't get their price, then they'll unwind the position at expiration and look to reestablish it at some later date.

The reason floor brokers are of great help is that spread brokers in the OEX pit can see how the arbs are bidding for the "rolls." That

is, they can see if the arbs are attempting to roll a long call/short put position or are trying to do the opposite. If the arbs are attempting to roll a long call/short put position, then the arbs must be short stock. Therefore, there is potential buying power at expiration. In addition, spread brokers can tell whether the “rolls” are actually being traded or are just being bid for. If they are actually trading, that lessens the potential expiration effect.

---

In April 1995, there was a large arbitrage position. The market had been in the midst of a strong bull run, and there was huge open interest in OEX calls, indicating a large OEX arbitrage position. Floor sources told us that the arbs were attempting to roll long calls out to May or June expiration, so it was apparent that the arbs held short stock positions hedged by long call/short put option positions. These facts were known more than a week prior to expiration, and seemed to be fairly common knowledge among professional traders.

Moreover, as expiration approached, there was very little actual trading of the rolls. Open interest was remaining fairly constant in the OEX April calls, and floor traders did not see many rolls being executed. This emboldened traders; and by Thursday afternoon of expiration week, it was becoming obvious that there just wasn't enough time or supply for the arbs to be able to roll. Therefore, there was going to be rather massive buying of stocks in the OEX Index at the close of trading on Friday.

The buying actually started on Thursday (more about *that* strategy later), when the market reversed from a moderate down day to close up 23 on Thursday. Friday saw another 40 points tacked on, with the majority of it coming late as the buy programs were executed. Traders who had done the analysis of the arbs' position made very good profits in short-term OEX calls, as OEX rose over 7 points.

---

You can see from this example that foreknowledge of the arbs' positions and their subsequent handling of those positions as expiration approaches can produce a profitable speculative trade. Don't be dismayed if you don't know floor sources—it may be possible to glean similar information from your brokerage firm's option department, as they talk to floor traders. Also, since the advent of CNBC's more advanced coverage of the day-to-day aspects of trading, you can often get the opinion on TV of some of the more “connected” floor traders.

## Open Interest Implications

It is important to understand that it is not necessarily easy to discern this information regarding arbitrage positions. Some of the arbs even go so far as to leak *incorrect* information about their positions. The best that an outside observer can do is to put together enough information to make an educated guess; if the guess is good enough, the rewards will be ample. There are certain basic facts that are irrefutable and will help anyone determine what is going on. One important guide is open interest of OEX options. As expiration approaches, public customers tend to sell in-the-money options and hold at- or out-of-the-money options. Those in-the-money options are predominantly in the hands of arbitrageurs by expiration. Thus, if you observe the day-to-day changes of open interest of in-the-money options as expiration approaches, you can get a “feel” for how much buying or selling power remains in the market.

---

June 1995 expiration was a fairly good example of how open interest provided clues beyond the information that was generally available. It was fairly common knowledge that the arbs were once again short stock, hedged by long calls and short puts. Also, the market had rallied to new highs at 510 during the previous month, so most of the OEX calls were in-the-money as expiration drew near.

On Wednesday morning of expiration week, open interest in the calls with strikes from 440 (the lowest strike) through 505 totaled almost 130,000 contracts. On Wednesday night, at the close of trading, 40,000 contracts were exercised. This early exercise was announced on TV and was pretty much common knowledge. Exercise figures are available on any given day from the Option Clearing Corporation in Chicago. On Thursday evening, another 46,000 contracts were exercised. Again, this early exercise was widely broadcast on TV.

At this point, many analysts, having seen two days of early exercises, felt that there wasn't enough firepower left for expiration. They felt that expiration day itself would be a dull one. However, that was not the case at all. Most of the open interest had *not* been rolled out to later months, so there were still 44,000 in-the-money calls that represented buying power. In fact, it turned out to be good buying power as OEX meandered slightly higher most of expiration day and then spurted on the closing buy program to finish over three points higher on the day.

---

Although static numbers are subject to change, I find that an open interest of 40,000 to 50,000 in-the-money contracts is sufficient to cause a market move of at least 1.00 OEX or S&P point at expiration or at the close of trading on one of the days immediately preceding expiration. Of course, at many expirations the open interest is far greater than that, and larger moves can occur.

Open interest can therefore be a valuable guide to what is happening at expiration. Always check it as a backup to whatever “stories” you are hearing, for it is a reliable indicator. Unfortunately, it is only published once a day (before the market opens), so you can’t tell if it is changing during the day. That is where floor sources can come in handy. For example, if you know open interest is large entering expiration day, but your floor sources tell you that the arbs are rolling their positions out to the next expiration month, then you would have to modify your plans, since the effect of the arbs on the closing would be reduced or eliminated. You should always expect a number of positions to be rolled on expiration day itself; some arbs would just rather keep their stock positions in place at almost any cost. However, as a rule of thumb, if there is an open interest of at least 40,000 in-the-money contracts as the day begins, you have a good shot at having enough program activity to be able to make a profitable trade.

A few other important points should be made. If there is 40,000 open interest in in-the-money puts, then sell programs are possible. So you should really net out the open interest between the in-the-money calls and the in-the-money puts. Over the years, buy programs at expiration have been far more prevalent than sell programs, but be mindful of the possibility of a sell. You need to monitor the in-the-money put open interest for that purpose.

As expiration day itself approaches, the largest open interest will probably be in the at-the-money strike (or perhaps two strikes, if OEX is right between two of them). This open interest can be critical, for it might tilt the balance between buys and sell, depending on the way the market moves; or it might add enough additional ammunition to push the open interest total from below 40,000 to over 40,000, thus creating a tradeable situation.

Suppose that OEX is trading at 579 as expiration Friday begins and that the total open interest of all in-the-money calls up through the 575 strike is 35,000 contracts. Moreover, the open interest of all in-the-money puts down through the 585 strike is 25,000 contracts. On the surface, it appears that this expiration will not offer much in the way of a trading opportunity, because there is only a net of 10,000 contracts on the buy side.

However, when we look at the expiring 580 calls, we see that open interest is 40,000 contracts. At the beginning of the day, most of that open interest is probably in the hands of customers. However, if OEX were to rise and be above 580 by the end of the day, a large portion of that open interest could pass from customers' hands into the hands of arbitrageurs. In turn, that would mean, also, that there was net of 50,000 in-the-money contracts on the call side, and therefore buy programs might be possible at the close of trading.

---

## **A Hedged Strategy**

We're going to spend more time discussing the arbs' actions, but first we want to give you a strategy that is a hedge, but that can still make some nice money for you on expiration day. Obviously, if you have the arbs' intentions pegged exactly right, you can just buy some expiring OEX calls and make money. But there are a number of things that can go wrong, even if you have done your homework correctly. First of all, the market may have an interim adverse move *before* the arbs swing into action. *Just because there is going to be buying on the close, for example, it does not mean that the market will be up for the day.* Some speculators hear that there is going to a buy program on the close, and they look for an entry point all day long in order to buy the market. This could mean that you have bought the wrong calls or that you lose money on your call even though you had things figured out correctly.

---

In May 1995 there was a fairly large arbitrage position that once again consisted of the arbs being short stock, hedged by the long call/short put position. Expectations were high that the arbs were actually going to buy their stock a day early, on Thursday night. Speculators who had this figured out



waited until about 3:30 P.M. on Thursday to buy calls on OEX, expecting the arbs to begin forcing the market higher shortly thereafter.

However, at the same time, the news media were interviewing a Federal Reserve System (Fed) governor who made some bearish comments regarding the future of interest rates. As a result, the bond market and then the stock market got slammed.

At the close, there *was* a small buy program, followed by a rather large exercise of OEX calls by the arbs, but it came too late for those who had bought calls *before* the Fed governor's remarks.

This example shows the frustrations that can accompany the unhedged OEX call buyer who is attempting to figure out what the arbs are going to do. He might be right, but he might not make money. There is another strategy—a hedged strategy—that can help prevent losses like that, while still allowing for profits to be made. For example, if you are approaching expiration as a *strategist*, and not as a *speculator*, then you would take the following position on expiration Friday, if you expected the arbs to execute buy programs on the close:

Buy five in-the-money expiring OEX calls.

Sell one S&P 500 near-term futures contract as a hedge.

Note that the S&P 500 contract is never expiring that Friday (the *old* contract may have expired that morning, but the currently trading S&P 500 contract always has at least one month remaining until expiration, and sometimes as many as three months). The reason we use five OEX calls and only one S&P 500 future is that OEX options are worth \$100 per point, while S&P 500 options are worth \$250 per point. In addition, OEX trades at about half the price of the S&P 500. In essence, this is a complete hedge—all stock movements are accounted for, except for the difference in movement of OEX versus SPX (the S&P 500 Cash Index). That's what we're looking for—for OEX to outperform the S&P 500 on the close.

The *margin* required for this strategy is that both sides must be fully margined, even though they are obviously hedged. Until cross-margining becomes a reality, you must pay for the calls in full and also margin the S&P futures.

*Example:* The February 1992 expiration was a classic example of how this strategy worked well as a hedged vehicle. After the market opened and stabilized, these prices were available:

OEX: 386.02  
 OEX Feb 380 call: 6½  
 S&P March future: 413.30

The hedged strategy was established by buying five of the OEX Feb 380 in-the-money calls that were due to expire that evening, and they were hedged with the sale of an S&P March future (the nearest term futures contract). Note that the OEX calls have a slight premium, because traders are expecting a buy program. The premium on OEX calls, as expiration nears, is often a “tip” as to how OEX market makers view the upcoming expiration. If the in-the-money calls have a premium, as in the preceding prices, then market makers are expecting a buy program. If in-the-money puts have a premium, then market makers are looking for a sell program.

On that Friday, the market traded lower almost all day. Then, later in the day, as expiration approached, large buy imbalances were posted for “market on close” orders. These imbalances are released at 3:40 P.M. by the NYSE in order to advertise the blocks of stocks to be traded; this will draw in sellers (in theory) to help out the specialist in making a fair and reasonable market.

As the close of trading approached, and then as the “market on close” buy programs hit the tape, the relevant prices were as follows:

Time (P.M.)	OEX	SPX	S&P March Futures
3:59	384.51	410.81	411.80
4:00	384.68	410.90	412.25
4:01	384.95	411.04	412.20
4:03	385.47	411.29	411.90
4:05	385.80	411.42	412.00
Final	385.82	411.43	412.15
Gain from 3:59 P.M. to final:	1.31	0.62	0.35

First, notice that OEX rose 1.31 after 4 P.M. on the buy programs—from 384.81 to 385.82—while SPX only rose 0.62 over the same six-minute time period. This confirms the fact we stated earlier: that OEX will rise faster than SPX when the buy programs enter the market. Also, notice that the S&P March futures only rose 0.35—from 411.80 to 412.15. This means that the premium was shrinking on the futures as the end of trading neared.

The actual strategy would be unwound by exercising the Feb 380 calls, receiving 5.82 as the settlement price (OEX closed at 385.82), and buying the March futures back in the open market. The profits and losses would be (*note: in 1992, S&P 500 futures were worth \$500 per point*):

Position	Buy Price	Sell Price	Net Gain (\$)
5 OEX Feb 380 calls	6.50	5.82	-340
1 March S&P future	412.00	413.30	<u>+650</u>
Total Gain			+310

Of course, commissions would have to be subtracted from this figure, but they shouldn't be more than \$100 or so. Therefore, a profit remains. The investment required would be the full cost of the OEX calls, \$3,250, plus the futures margin, which is about \$9,000.

The final point that should be made here is that this profit was made, even though OEX declined on the day (OEX was 386.02 in the morning, when the position was established, but closed at 385.82). Almost certainly, a straight call purchase would have lost money; but the hedged strategy made money because it was only attempting to capture the differential between OEX and SPX, and not necessarily to predict the direction of the overall market on expiration Friday.

The idea behind this strategy is that the OEX will go up at the close of trading on expiration day, as the "market on close" buy orders are executed. The S&P Cash Index will not increase as much, nor will the futures contract, since the buy programs have a smaller effect on the broader-based SPX. Since it is expected that the buying will be concentrated in the stocks that make up the OEX, this strategy is a reasonable way to approach the problem of expiration in a hedged manner. The recommended hedged strategy is not con-

cerned with the eventual market direction other than to attempt to predict the relationship between OEX and SPX at the close of trading.

The strategy is only intended as a day trade; keeping it as short-term as possible (less than one full trading day) will help keep losses small. The risk is that SPX outperforms OEX on expiration day. This could happen if institutional sellers come into the market to meet the buy orders of the arbs, or if the arbs roll their positions after you, as a strategist, have established your hedged strategy, or if you have misjudged the arbs' position.

In any case, you, as strategist, are attempting a day trade. You should wait until the market opens and stabilizes on Friday, expiration day, before taking a position. Even then, you shouldn't establish your entire position; you might wait to see if better prices are available during the trading day. The extent of the buy programs, if any, should be known by about 4:05 P.M. Eastern time as the market on close orders hit the tape. The futures trade until 4:15 P.M. The position can easily be removed: merely exercise your OEX calls and buy your S&P futures back in the open market before 4:15 P.M. (Note: expiration day is the only day that you can wait until *after* the close of trading to exercise your OEX calls.)

There may be additional benefits as well. Sometimes, the premium *shrinks* in the S&P futures, giving the hedged position an additional profit. Also, if the market were to suffer a severe drop on expiration day, large profits could accrue since you have a limited loss on your calls but are not limited on the potential downside profits from the short futures contract. This has happened twice in recent years.

---

Expiration day, October 1987, was a rather harrowing day for the market. The arbs *had* been short stocks and long futures coming into expiration week. There had not been much opportunity to remove the positions because the portfolio insurance practitioners pushed the futures to discounts on Wednesday and Thursday of the week. So, coming into Friday, it seemed as if there were going to be arbitrage buy programs. A strategy of long October in-the-money calls and short December S&P futures worked beautifully as the market plunged 107 points that day and the futures closed at a 4-point discount as well!

It is a much lesser known fact that the November 1991 expiration was even worse for the market. Again, as Friday, November 15, opened for trading, it was a fairly common assumption that the arbs were short stock and long calls. Thus, buy programs were expected on the close of trading. However, the market began to sell off in midafternoon, and the selling gathered momentum. Eventually the Dow closed down 110 points and finished on the low of the day (OEX was off 16 points). Moreover, by the close of trading, arbs had removed their positions, and there were actually *sell* programs on the close! Again the futures closed at a discount, so our hedged expiration strategy position profit was even greater than anticipated.

---

A risk of this strategy is that the S&P futures might gain a lot of premium near the close for some reason, forcing the strategist to buy back overpriced futures in order to close out his position. Finally, one other point should be made about the hedged strategy. It can be modified into an aggressive one if conditions are right. If the buying on the close is particularly heavy, there is almost always a downward opening to stock prices on the following Monday morning, as stocks return to levels near where they were trading before the artificial buying took place. That doesn't always happen, but it has occurred many times in the past. In that case, the aggressive strategist might want to keep (some of) his short S&P futures over the weekend with the intention of covering them on Monday morning after the opening of trading. This is obviously not part of the hedged strategy, but it often proves profitable. This aggressive addition to the strategy introduces extra risk into the position because some news item might come out that forces the market higher on Monday morning, expiration forces notwithstanding.

The preceding discussions all assumed that the arbs were going to be executing buy programs on the close of trading. However, that is not always the case. Sometimes they have sell programs, in which case the hedged strategy would be to buy five OEX in-the-money puts and one S&P 500 futures contract as a hedge. This hedge is similar in concept: the risk is limited by the two hedged positions; and in this case, a large market rally (which wouldn't normally be expected to occur if there are sell programs around) could result in very large profits.

## Speculation Early in Expiration Week

There is sometimes arbitrage activity *prior to* expiration day itself. This has become more common in recent years, and the activity is predominantly concentrated in OEX programs, since the OEX options can be exercised early. In fact, if this preexpiration activity is large enough, it can have the effect of reducing expiration Friday to a total nonevent. That is, the arbs can actually remove their entire position in the last days prior to expiration. Thus, even if you have done your homework and were ready for expiration Friday, that may not be enough. You may have to be prepared to trade on Wednesday or Thursday preceding expiration as well, or be left with no trades at all. First, let's discuss this from an arbitrageur's perspective, and then later we'll see how interested outsiders, such as ourselves, could make money from the arbs' actions.

The examples in the preceding section showed how the arbitrageurs unwind their positions on expiration Friday. However, the phenomenon revolving around the surge in prices on a Wednesday or Thursday preceding expiration Friday is less well known. Sometimes arbs will attempt to unwind their position early because, although they are not guaranteed a perfect closeout of their position as they would be on expiration Friday, they can often make more money this way. Once again, they unwind their position at or near the close of trading; but in this discussion, they are unwinding a day or two early. The early unwinding relies on the fact that OEX options can be exercised prior to expiration day (they are American-style).

Let's assume that the arbs are short stock, hedged by the long call/short put option position. We know that an arbitrageur can unwind his position at exactly *parity* on expiration day by buying all his stocks back with market on close orders and also exercising his long, in-the-money calls (or allowing himself to be assigned on his short, in-the-money puts). In either case, he unwinds the position without risk. However, *what if he could remove the position at a discount to parity?* Then he could make even more money. In order to unwind at a discount, however, he would have to buy his stocks back *before* the market closed and then exercise his calls *after* the market closed. If he had bought those stocks back at a lower price

than the actual market close, this would in effect result in his removing his position at a discount to parity.

---

*Example:* Suppose an arbitrageur is short all the component stocks of the OEX in the proper proportion and has them hedged by long, in-the-money OEX calls. Furthermore, suppose that he wants to attempt to remove this position at a discount to parity. At about 3:45 P.M. on the day *before* expiration, he begins to buy some of his stock back in the open market. This forces OEX a little higher, so he buys more stock back. Again, OEX is forced higher by his buying actions. Finally, he buys the remainder of his stock back, market on close, and exercises his calls. The following figures might be representative of the prices he received.

---

Time of Day (P.M.)	OEX Price	Action
3:45	525.00	Buy back one-quarter of short stock position
3:50	525.50	Buy back another quarter of position
4:00	526.00	Buy back the remainder market on close and exercise the long calls

---

Thus, the arb has bought back one-quarter of his short stock position at 525.00, one-quarter at 525.50, and the balance at 526.00. His net OEX buyback price is 525.62. Meanwhile, he exercises his calls, all at parity with the close—526.00. Thus, he has removed his position at a 0.38-point discount to parity. If his position were large enough, that could represent a lot of money.

---

Arbitrageurs are, by nature, rather risk-averse people; arbitrageurs like to make a little, mostly risk-free money on each trade and do a lot of trades. However, the arbitrageur assumes a certain amount of risk by attempting this early unwinding of his position; so you won't see all the arbs trying this. *His major risk in the early unwinding strategy is that someone else—a natural seller, perhaps—will enter the market and force OEX to go down while the arb is in the midst of unwinding his position.* If that happens, the arb may end up removing his position at a premium to parity, an act

that could cost him a good deal of money. Still, there are more and more arbs who will attempt this early unwinding *if conditions are right*. We'll define what that means shortly.

But first, there is one additional way that the arbitrageur can make money by an early unwinding, but it involves even more risk: he can wait until the following morning to cover some of his short stock. It should be understood what happens when a large OEX in-the-money option position is exercised: it often removes one side of another trader's hedged position. An example of this was given in Chapter 1, under "Cash Option Exercise." Essentially, what happens is that some other trader (*not* the arb) has a spread in OEX in-the-money options, where one side is completely hedging the other. Then a call assignment removes the short side of this trader's spread, and he is left with a long position. Since he had no market exposure before the assignment and now has great market exposure after the assignment, it is reasonable to assume that this trader will try to sell something in order to reduce his exposure.

Thus, an early assignment of OEX calls produces selling pressure on the market the next morning; similarly, an early assignment of OEX puts produces buying pressure on the market the next morning. Consequently, an arbitrageur who was short stock and also exercised his calls on, say, Thursday night might wait until Friday morning to cover some of his short stock because he knows that it is likely that his large call exercise will force the market lower on Friday morning. Of course, the arb assumes additional risk by attempting to do this, for there could be some news items that come out overnight and make the market rally, which would force him to cover his short stock at *higher* prices.

In summary, then, the arbitrageur can remove his position in one of two ways:

1. The riskless way: on expiration Friday, buy stocks back with market on close orders and exercise his calls for cash.
2. The aggressive way: on Wednesday or Thursday preceding expiration day, buy stocks back aggressively during the last half hour of trading; exercise calls for cash after the close; and possibly cover some remaining short stock the following morning.



We mentioned earlier that the arbs will only attempt the second way—the aggressive early unwinding—if conditions are right. What we mean by that is that they won't try to force the market in the opposite direction from which it is naturally trending. Thus, if they were contemplating an early unwinding on Thursday's close, but late on Thursday afternoon the market was selling off sharply, they would not attempt to jump in the way with their buy programs. In that case, they would most likely just unwind their positions on Friday, via the riskless way. On the other hand, if the market were already rallying on Thursday afternoon, they might feel more certain that they could "pour fuel on the fire" and get a *really big* rally going by buying back their short stock as part of an early unwinding.

---

The September 1994 expiration saw one of the biggest market moves due to early unwinding. As expiration week approached, open interest was one of the largest ever. A persistent rally since late June had allowed arbitrageurs to establish large hedged positions of short stock and long calls/short puts. Moreover, that same rally had now placed almost all of those calls in-the-money, so the potential was great for arbitrage activity near the September expiration.

On Monday, Tuesday, and Wednesday of expiration week, OEX closed higher each day, although only by a point or two. OEX closed at 435.22 that Wednesday. Then, as Thursday's trading unfolded, another modest rally was under way. By Thursday afternoon, the rally had gathered a little steam, and OEX was trading near 437 shortly after 3 P.M. At that point, the rally began to gather more steam, and OEX was up to nearly 439 by 3:50 P.M. Then, a huge buying spree hit the market late in the day, driving OEX all the way up to 442.03 on the close. So, OEX closed up 6.81, and the Dow Jones Industrials were up 58 points.

The arbs had had a field day, jumping on an already rising market and pushing it higher quickly. But the arbs weren't done yet: on Thursday night, they exercised all of their in-the-money calls. It was the largest call exercise ever in OEX (up to that date). All OEX in-the-money calls—even the September 440 calls, which were only slightly in-the-money—closed at parity, as market makers knew that the exercises were forthcoming (by the way, those Sep 440 calls rose from one-quarter on Wednesday's close to a price of 2 on Thursday's close). Those call exercises represented over \$6 billion worth of OEX stock; thus, \$6 billion of stock had been bought by arbs on Thursday afternoon.

The next morning (Friday), the market opened down substantially (OEX was off nearly three points in early trading), partly due to a reaction to the early exercise and partly due to bond market jitters. Thus, arbs who had held any short stock overnight were able to cover it at better prices on Friday morning. Needless to say, there was no buy program on Friday: OEX closed down 3.82 on Friday. The close of trading on Friday was very dull.

---

Thus, September 1994 was perhaps the ultimate real-life example of how early unwinding takes place and how it can affect the market. In fact, the overall stock market declined for several weeks after that, with OEX reaching a low of 418 on October 6. This is not to imply that the expiration activity caused the market to decline for several weeks, but it *does* demonstrate that expiration week can move entirely differently from the natural tendency of the stock market.

For those who understood the strategy, the events of that Thursday, September 15, 1994, seemed rather logical. But it was soon apparent how many people didn't really understand what had happened. The aftermath of that expiration produced some almost comical comments by the media. After Friday's down day, CNBC television reported that expiration was a "sell," and they figured the market should rebound on Monday morning as an opposite reaction to the expiration sell programs. Apparently, since Friday was expiration and a down day, the television commentators figured that there had been sell programs (they seemed to have totally missed the buy programs on Thursday). In fact, there had been almost no expiration-related programs at all, and the market traded lower on Monday also. *Barron's* ran numerous articles trying to explain what had happened; and in those you could almost feel that certain arbitrage firms were feeding somewhat nonsensical information to the media, perhaps in an attempt to keep everyone from understanding what really took place. The gist of the *Barron's* summary was that OEX traders and arbs bought OEX calls, then went in and bought OEX stocks in order to increase the price of their calls, and then exercised their calls on the close. If *that* was true, how were these "OEX traders" supposed to have disposed of their long stock—at big losses on Friday? Nonsense, to be sure; but when it was printed in *Barron's*, a lot of people believed it. Not all public commentators were unaware of what had happened, of course. After the market was down 67 on

Tuesday following expiration, Larry Wachtel of Prudential acknowledged that the market needed to work off the artificial *buy* program of the preceding week. So at least *he* got it right.

The arbs were able to make such a large impact that September because “conditions were right”: the market was trading higher, and there was ample knowledge that a large arbitration position existed. However, when conditions are not right, the arbs will stand aside. You might want to go back and look at the example of the May 1995 expiration, which was described earlier in this chapter. That time, a Fed governor’s negative comments generated true sellers of stocks, and the arbs conveniently stepped aside late in the day, preferring not to fight the trend. Conditions were not right for the arbs in that case.

## Trading with the Arbs

So now that we have spent all this time explaining what the arbs are doing, let’s see how the individual trader or interested outsider can make some money from this knowledge. Again, you have two approaches: (1) you can buy calls and attempt to speculate on what the arbs will do, or (2) you can take a more hedged position, figuring that you might not make as much, but it won’t hurt as bad if you’re wrong, either.

If you are going to merely buy calls—a strategy that has been highly profitable whenever the arbs do indeed make their early move—I would recommend approaching it in this manner: try to think like the arbs do, for they will do their buying late in the day and they won’t fight a declining market. So, you, too, should wait until fairly late in the trading day before buying in- or at-the-money OEX calls, *but only if the market is up on the day or has risen significantly from a much lower low.*

If those conditions are met, then buy your calls; *but you must sell them (or exercise them) at 4 P.M. that same day*, for you don’t want to get stuck with them overnight. If the arbs exercise a massive quantity of OEX calls, that could force the market lower the next morning; and that would harm your long call position. So, in essence, you approach this like a very short-term day trade: buy your

calls at 3 P.M. or 3:30 P.M. and get out at 4 P.M. As you can see from the example of September 1994 expiration, the market can move a great deal in the last hour or half hour if the arbs are “operating.”

A *hedged* position can also be taken, much like the one that was previously described for trading on expiration day itself. With the hedged position, you would once again buy five OEX in-the-money, short-term calls and hedge them by selling an S&P 500 futures contract.

If you are implementing this hedged strategy on Wednesday or Thursday before expiration, you should be careful not to use the S&P futures contract that expires on that Friday. Rather, you should use the “front-month” contract, which is the term that describes the active contract. For example, if it is currently September, one would buy OEX September calls and sell the December futures contract. Experienced futures traders know that the fastest and best executions are only available in the “front-month” contract. As before, this hedged strategy should be removed at the close of trading.

However, there is another small difference between using either strategy on a Wednesday or a Thursday rather than on expiration Friday itself. That difference involves exercising the OEX calls. Recall that on expiration Friday, you can merely call your broker after the close and exercise the calls (or they will be automatically exercised for you if they are in-the-money). However, the same courtesies do *not* apply to early exercise of OEX calls. On a regular trading day, which would include the Wednesday and Thursday before expiration Friday, you must have your OEX exercise instructions in by 4 P.M. So while you may certainly have a good idea in advance of 4 P.M. (say, at 3:45 P.M. or so), whether or not you will exercise your calls, you might prefer to actually trade out of the calls after 4 P.M. rather than bother with the exercise.

### **The Postexpiration Effect of Futures on the Stock Market: A Trading System**

Earlier, there were allusions to the fact that in the week following expiration, the stock market often has an opposite reaction to the buy and sell programs of expiration week. In general, this is true; but

as with all general statements of this kind, you must be careful if you intend to use them as a basis for trading.

Using OEX as the measure of market performance, we did some specific historical analyses of what happens to the market in the week following expiration. The results are quite interesting and have proven to be tradeable in the past.

In order to conduct this study, we needed to determine whether there were buy or sell programs during expiration week and if there was an opposite move during the week following expiration. First, we determined the largest *absolute* move that occurred the week prior to expiration by observing the move from the second Friday of the month either to the *highest* closing price of Wednesday, Thursday, or Friday of expiration week or to the *lowest* closing price of those three days. This gives us the information as to whether buy or sell programs occurred during the week prior to expiration.

Then, we looked at the resulting moves from expiration Friday's closing price to the minimum (maximum) closing price during the following week. So, if the market was up during the week prior to expiration, we looked for the lowest closing price of the following week to see if the market had a reverse reaction to the buy programs. Conversely, if the market was *down* during expiration week, we looked for the maximum close during the week following.

The data in Table 3.1 summarize the study (months in which there was no significant move prior to expiration were ignored). From this data, it can be seen that the market does, indeed, often have an opposite reaction to the movements of expiration week. Some traders seem to feel that this effect is more pronounced at the quarterly expirations, when S&P futures expire on the same day as OEX options. Thus, we have broken the data out for those quarterly expirations as well. In either case, the market appears to reverse about 80 percent of the time, or four months out of five.

The pertinent question, of course, is "Is there a system that can be devised to trade this phenomenon?" In order to answer that question, we ran several sets of data, with different entry points and different (or even no) stop levels. The first conclusion that we came to was that you need to use a stop of some sort. There were several expirations in which the market continued on in the same direction *after* expiration as it had been going *prior* to expiration. These are

**Table 3.1**  
**SUMMARY OF THE STUDY OF**  
**FUTURES' POSTEXPIRATION EFFECT**  
**ON THE STOCK MARKET**

Time Period	Number of Expirations	Number of Times Market Reversed
<i>Monthly Expirations</i>		
All expirations	142	115 (81%)
After 1/1/85	120	97 (81%)
After 1/1/90	61	47 (77%)
<i>Quarterly Expirations</i>		
All quarterly	50	40 (80%)
After 1/1/85	42	34 (81%)
After 1/1/90	22	16 (73%)

losses, and some of them were quite large without using stops (interestingly, many of these came in December, a month that you might want to avoid if you are trading this system).

Surprisingly, it turns out that using an absolute stop is far superior to using a *trailing* stop. A trailing stop is one that you adjust to lock in profits as a trade moves in your favor.

*Example:* Suppose that you buy the S&P 500 futures at a price of 563.00 and want to use a trailing stop of 1.50 points. Initially, your stop would be 561.50. However, suppose that the trade moves in your favor and the futures close at the following prices over the next few days following inception of the trade. The new trailing stop is shown for each day, as it would be recalculated after the close of trading.

S&P Futures Close	Trailing Stop	Comment
(1) 564.20	562.70	Market up, raise stop
(2) 566.10	564.60	Market up, raise stop
(3) 565.50	564.60	Market down, same stop
(4) 568.00	566.50	Market up, raise stop
(5) 566.00		Stopped out

**Table 3.2**  
**STOP = 2.20 OEX POINTS**

Time Period	Number of Trades	Number of Profits	Total Profit	Average Profit
<i>Monthly Expirations</i>				
All expirations	133	61 (46%)	139.08	1.05
After 1/1/85	115	48 (42%)	111.02	0.97
After 1/1/90	59	25 (42%)	87.71	1.49
<i>Quarterly Expirations</i>				
All quarterly	48	25 (52%)	88.09	1.84
After 1/1/85	40	19 (48%)	74.48	1.86
After 1/1/90	22	12 (55%)	66.24	3.01

Note that on day three, when the futures closed lower at 565.50, but not low enough to stop out the trade, the trailing stop was not lowered. It can only be raised, never lowered.

In our OEX trading system, we ran several scenarios, but these two seem to be representative: using a stop of 2.20 OEX points, or using a stop of 3.10 OEX points. In Tables 3.2 and 3.3, we break

**Table 3.3**  
**STOP = 3.10 OEX POINTS**

Time Period	Number of Trades	Number of Profits	Total Profit	Average Profit
<i>Monthly Expirations</i>				
All expirations	133	69 (52%)	135.11	1.02
After 1/1/85	115	56 (49%)	108.10	0.94
After 1/1/90	59	30 (51%)	97.59	1.65
<i>Quarterly Expirations</i>				
All quarterly	48	27 (56%)	84.76	1.77
After 1/1/85	40	21 (53%)	70.92	1.77
After 1/1/90	22	14 (64%)	71.25	3.24

down the results by total number of trades, the number of profitable trades, OEX profit per trade, and total OEX profit over the life of the system.

The best average profit, in either table, is the more than 3-point profit per trade attained by trading the quarterly expirations since 1990. However, all of the systems are reasonably good. Since 1990, the larger stop (3.10 OEX points) seems to work better, but that is probably related to the fact that OEX has been trading at a higher price in the 1990s than it was in the 1980s. You should also note that the studies encompassing monthly expiration summaries prior to 1990 were hurt by the October 1987 expiration that lost 27 OEX points (that is, if you bought OEX on Friday night, October 16, you lost 27 points when it opened that much lower on Monday, October 19).

These results are good enough to trade, so here is the system.

**Step 1.** Using the OEX closes on Wednesday, Thursday, and Friday of expiration week, determine the largest change from the previous Friday's OEX close.

---

*Example 1:* Suppose OEX closes at 530 on the second Friday of the expiration month. Then, during the ensuing week, the following closes are registered:

Day	OEX Close	Change from Second Friday
Wednesday	528.35	-1.65
Thursday	533.25	+3.25
Friday	529.50	-0.50

In this case, we would use +3.25 as the largest change, assuming buy programs on Thursday pushed the OEX to that closing high for the three-day period.

*Example 2:* Again, suppose OEX closed at 530 on the second Friday of another expiration month. Then, during the ensuing week, the following closes are registered:



---

Day	OEX Close	Change from Second Friday
Wednesday	532.05	+2.05
Thursday	529.00	-1.00
Friday	527.00	-3.00

---

In this case, we would use  $-3.00$  as the largest change, indicating that sell programs on Friday pushed the OEX to that closing low.

---

If the absolute value of the largest change is less than 1.50 OEX points, then don't make a trade—there were apparently *no* buy or sell programs during expiration week, at least not enough to materially move the market.

**Step 2.** If the largest change was at least 1.50 points in one direction or the other, then do the following. If the largest change was positive (Example 1), then buy programs took place during expiration week, and *the system says to short the market*. If the largest change was negative (Example 2), then *sell programs* took place during expiration week, and the system says to *buy* the market. Given the statistics in the previous tables, you may want to take a larger position at quarterly expirations than you do at regular monthly expirations.

**Step 3.** Use an intraday stop of 3.10 OEX points if the market moves against you. Otherwise hold the trade until the following Friday (the Friday following expiration day) and close it down at that time. If any of the Fridays in the system are holidays, then use Thursday's close of that week instead of Friday for the appropriate calculation given earlier.

It might be better to implement this strategy by buying OEX puts or calls, rather than by buying or shorting S&P 500 futures. For example, in the debacle of 1987, your loss would have been limited had you owned OEX calls rather than S&P futures.

Finally, you should use some trading common sense. For example, if you have built up a very large profit in just a day or two of trading, it would probably be wise to realize at least a part of that profit.

Even though the system says to hold on until Friday, you would be neglectful if you let the entire profit evaporate on a reverse move by OEX.

There does not seem to be any longer-term effect after expiration, as the market's results are mixed when measured one month after expiration. In fact, the percentage of months that gained ground the month after expiration are about 60 percent—approximately what one would expect to find in an ongoing bull market of such long duration.

To summarize this entire section, it is important to understand the effect of futures and options on the market at or near expiration. Moreover, this understanding can lead to profitable trades if you have correctly assessed the arbitrageurs' positions and intentions. Observing open interest can help determine the arbitrage position, as can receiving reliable reports from floor brokers. During expiration week, should you decide to trade along with the arbs, the safest way is to use the hedged strategy—buying OEX calls and selling S&P 500 futures against them, for example—but outright call buying can sometimes be attempted successfully, as well. Also, it was shown that expiration activity is often reversed to a certain extent in the week following expiration. That postexpiration phenomenon can be traded as well, using the trading system presented.

### **Expiration's Effect on Individual Stocks**

Option expiration can also have an effect on the trading of an individual stock. In general, if a stock is near a particular strike in the last day or two of its life *and* if there is a fairly large open interest in the puts and calls at that strike, then it's possible that the stock will be "pulled" right to the striking price. As was the case with index options affecting expiration, this phenomenon affecting stock is also arbitrage related. The arbitrage in this case is generally conducted by the market makers themselves, although in the distant past, it used to be possible for upstairs traders to engage in this sort of arbitrage as well.

---

*Example:* Suppose that on the Friday before February expiration (the last trading day), XYZ stock is trading with this market:

Bid: 46.92      Asked: 46.94

Moreover, suppose there is a large open interest in the Feb 45 calls. Since this is the last day of trading, the market in the calls might be 1.90 bid, 1.95 offered.

The public owns these calls in large quantity, as evidenced by the large open interest. In general, a public customer will want to sell his calls rather than exercise them—due to commissions, margin, and so on. When a public customer looks at this market, he sees that he is not able to sell his calls at parity (which would be 1.92—the stock price, 46.92, minus the striking price, 45.00). However, he *can* sell them at 1.90, which is pretty close, so he might well do so. The market maker buys the calls from the public customer.

From the market maker's point of view, he does not want to be long calls on this stock for even the balance of the day; so he executes an arbitrage to lock in small profit. These are the market maker's trades:

1. He buys the XYZ Feb 45 call at 1.90.
2. He issues an exercise notice for the call: to buy 100 shares of XYZ at 45.
3. He sells 100 shares of the XYZ stock (short exempt) at 46.92.

He is allowed to sell the stock on a downtick even though he doesn't technically own it yet (this is what selling "short exempt" means) because he has already issued an irrevocable exercise notice to exercise the calls.

The market maker makes 2 cents on this transaction: he loses the 1.90 he paid for the call; but the difference between the stock purchase price, 45.00, and the stock sale price, 46.92, is a profit of 1.92, for an overall profit of 2 cents.

So the market maker, who has no costs except for minimal clearing costs, will do this trade all day long. As long as the public wants to sell their calls at even the tiniest discount to parity, he will execute this arbitrage. When open interest is in the thousands, this may result in tens of thousands of shares of stock being traded.

How does this affect the stock price? Notice that the market makers *sells* stock in the open market (100 shares at 46.92 in this example). As the public sells more and more calls and as the market maker buys them, he

sells more and more stock. All of this selling begins to take its toll, and stock drops. However, *that* may just spook more call owners, and they sell even more calls, in which case the market maker buys those calls and sells even more stock.

Where does this spiral end? When the stock reaches the striking price. When that happens, the calls may be 0.05 bid and 0.10 offered, with the stock at 45.00. The market maker can no longer execute an arbitrage, and the public may no longer want to sell calls at a mere nickel, so the process ends—with the stock “pinned” to the striking price (if it were to rally again, the process would begin anew).

It should be noted that there is a companion arbitrage involving puts. If the stock in the preceding example were to fall below the strike, then the Feb 45 *puts* would be in-the-money, and a similar arbitrage would take place: the public sells Feb 45 puts to the market maker. The market maker, in turn, after buying the puts at a slight discount, then *buys* the underlying stock and exercises the puts to sell the stock. Again, he makes a few cents on each trade. Meanwhile, he is now *buying* stock in this form of the arbitrage, and that forces the stock back *up* to the striking price. When it reaches the strike, this arbitrage will also cease.

So, the stock is “pinned” to the strike by the call *and* the put arbitrage. That’s how stock can get pinned to the strike on expiration day. It has nothing to do with some nefarious *X-Files*-type conspiracy to make the poor options buyers lose their money, as some cynics have suggested. It is merely a function of the arbitrage that takes place in the open market.

It should be pointed out that if there is an extraneous news event that moves this stock, it can easily dominate the arbitrage effect. The arbitrage scenario works only if there is little or no price influence in the stock that day from external sources.

## **OPTIONS AS AN INSURANCE POLICY**

We first entered the subject of how futures affect the market when we were discussing how derivatives can be used to hedge stocks.

Examples of using *futures* as that hedge were 1980s-style portfolio insurance and program trading. Options can, of course, be used as protection for stocks as well, sometimes with greater efficiency.

We saw earlier that insurance for individual stocks can be most efficiently created by buying equity put options specifically against those stocks. This method—buying individual equity puts to protect each individual equity in your portfolio—is often the most efficient and cost-effective way of creating insurance for a portfolio of stocks. You merely buy slightly out-of-the-money puts against the individual issues that you own. For example, if you own 2,000 shares of Microsoft, selling at 93, then you might want to buy 20 Microsoft Oct 80 puts as protection. Or if you desire greater protection, then buy 20 Oct 85 puts or even Oct 90s.

You could buy puts individually for each stock in your portfolio (assuming that the stock has listed options trading). Then, when you were done, you would have a “perfect” hedge—perfect in the sense that the puts will increase in value at the same rate your stocks fall, if they fall far enough. Thus, no matter what happens to each stock individually, your puts will provide protection below their respective striking prices.

Money managers sometimes modify the insurance strategy so as to decrease the cost of the puts used as insurance: the stock owner not only buys an out-of-the-money put as insurance, but also sells an out-of-the-money call in order to pay for most or all of the cost of his put. The resultant position—long stock, long out-of-the-money put, and short out-of-the-money call—has a profit potential as shown in Figure 3.1. By using this strategy, which is called a *collar*, the stock owner is giving up some of his upside profit potential in order to lower the cost of his insurance. We’ll talk more about the collar strategy shortly.

You can also protect an entire portfolio of stocks with index or sector options. This is an easier protection method, as you only need to place a single order and pay one commission in order to create the protection. The problems with using index options are twofold: (1) there is almost certain to be tracking error (*tracking error* is a term that describes the difference in performance between your portfolio and a broad-based index); (2) the index options often trade with an inflated implied volatility, meaning that you are “overpaying” for

**Figure 3.1**  
**THE COLLAR AS INSURANCE**

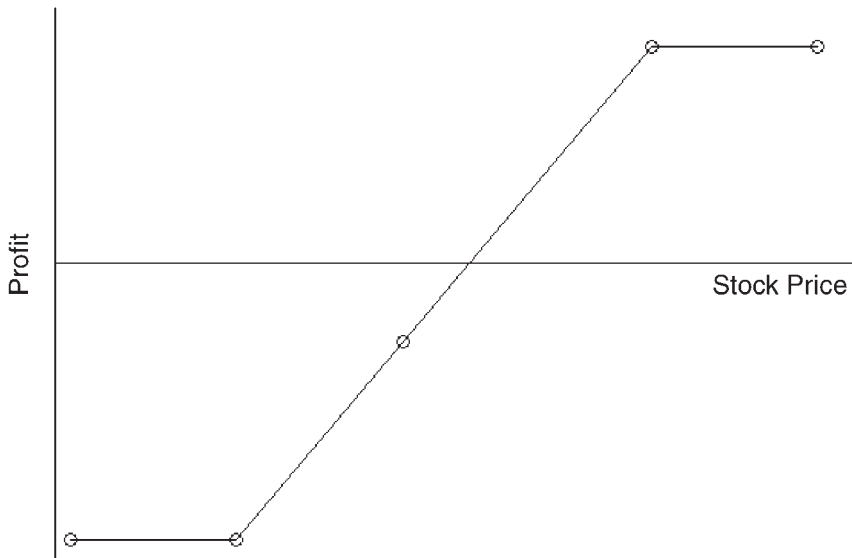

your protection. Individual equity puts often trade with an implied volatility that is very much in line with the stock's historical volatility. This means that you generally won't be overpaying for individual equity puts. In addition, there is no tracking error when you buy individual equity puts. Despite these drawbacks, many portfolio managers prefer to use index options for protection, simply because they can't physically buy options on the 300, 400, or 500 stocks that they own in their large portfolios.

---

*Example:* Suppose that a stockholder owns a rather diverse portfolio of stocks—worth \$1.4 million—and he wants a temporary hedge because he feels the market is due for a sharp, short-term decline. He might decide to sell some S&P 500 futures against his portfolio. Recall that a one-point move in S&P 500 futures is worth \$500. Therefore, if the S&P 500 futures were trading at 560, then each futures contract represents \$280,000 worth of protection (560 times \$500 per point). He would thus sell 5 futures to hedge his \$1.4 million portfolio, since  $\$1.4 \text{ million} \div \$280,000 = 5$ .

Now suppose that the market does indeed drop and his portfolio loses almost 15 percent of its value, falling to \$1.2 million, a loss of \$200,000. Furthermore, during the market decline, the S&P 500 futures drops by 30 points. Thus, the five S&P futures that he is short netted a profit of only \$75,000.

Even though he sold an appropriate *dollar* amount of S&P 500 futures, his portfolio and the S&P 500 performed in a different manner. This difference in performance may be due to tracking error. However, it could be the Beta as well (we discuss Beta shortly). These two would account for the \$125,000 net loss that he suffered in this example.

---

If you owned a portfolio of stocks that were the exact makeup of the S&P 500 or the OEX (S&P 100) indices, then you wouldn't have to worry about tracking error at all; you could easily compute the number of options or futures that would be required to hedge your position. However, no individual investors and few institutional investors are in this position. Rather, you usually have a portfolio of stocks that bear little resemblance to the indices themselves. In order to hedge this portfolio, you have to use the options or futures that are listed—ones that don't exactly match the makeup of your portfolio. So you must try to select an index that will perform more or less like your portfolio of stocks if you want to use index puts as protection. If the portfolio is broad-based, then OEX or SPX will suffice. If the portfolio is more specific, you may be better served by using puts on a Sector index.

It's a simple matter to calculate your portfolio's actual net worth; but when you are attempting to use index puts as protection—assuming you don't own *exactly* the stocks that make up the index—then you must first calculate the *adjusted* net worth of your portfolio. In order to do this, it is necessary to use a factor that we call *relative Beta*. We define relative Beta later, but for now suffice it to say that it is a measure of how each stock in the portfolio in question relates to the index that you are using as a hedge. Simply stated, if the relative Beta is 2.0, then the stock in question moves twice as fast as the index in question.

---

*Example:* To show how this calculation works, assume that a trader has a small portfolio that consists of 1,000 IBM, 2,000 General Motors, 300

Texas Instruments, and 500 AT&T. This is a rather diverse portfolio, so he might consider using a broad-based index such as the OEX for his hedge. In order to do so, he multiplies the actual net worth by the relative Beta in order to determine the *adjusted* net worth.

---

Stock	Quantity (a)	Price (b)	Net Worth (a × b = c)	Relative Beta (d)	Adjusted Net Worth (c × d)
IBM	1,000	110	110,000	1.1	121,000
GM	2,000	50	100,000	1.3	130,000
Texas Instruments	300	160	48,000	2.0	96,000
AT&T	500	50	25,000	1.0	25,000
Totals:			283,000		372,000

---

This portfolio’s adjusted net worth is higher than its actual net worth, indicating that it is more volatile than the OEX. If he were comparing the portfolio to a *different* index or sector, then the relative Betas would change.

Assume that OEX is trading at 525. Then he would divide 372,000 by 525 to arrive at the number of “shares” of OEX he needs to hedge this portfolio. That division tells him that 708.57 shares of OEX would be required as a hedge. If he were going to buy OEX puts, which represent 100 shares of OEX, then he would buy seven puts as a hedge.

---

The preceding example is a simple one, since you would expect this portfolio to perform more or less like the stock market. Although, even *that* is a big assumption, since IBM was falling for quite some time, while the overall market was rising. The calculations become more perplexing when you have a portfolio that performs less like the broad market and more like one of the sector indices. The following examples illustrate this problem.

---

*Example:* Now suppose that we are discussing a more volatile, technology-stock portfolio consisting of 2,000 Microsoft, 1,000 Intel, 500 Texas Instruments, and 500 IBM. This portfolio might perform extremely differently from the OEX. In fact, one of the technology sector indices



might be a better hedge. First, let's see how the calculations relate to the OEX:

### Hedging with OEX

Stock	Quantity (a)	Price (b)	Net Worth (a × b = c)	Relative Beta (d)	Adjusted Net Worth (c × d)
Microsoft	2,000	100	200,000	3.1	620,000
Intel	1,000	67	67,000	4.0	268,000
Texas Inst.	500	160	80,000	2.0	160,000
IBM	500	110	55,000	1.1	56,500
Totals:			402,000		1,104,500

This portfolio is almost three times as volatile as OEX (i.e., the adjusted net worth is almost three times the net worth). With OEX at 525, this would necessitate hedging with 1,104,500/525, or 2,103.81, shares of OEX, or 21 OEX puts.

When the adjusted net worth is so disparate from actual net worth, you should consider using a sector index as a hedge instead. The large discrepancy between actual and adjusted net worth indicates that tracking error could be a large problem. There is a Semiconductor Sector Index (Symbol: SOX) that might be a better hedge for this high-tech portfolio. Each stock has a totally different relative Beta when the SOX is considered.

### Hedging with SOX

Stock	Quantity (a)	Price (b)	Net Worth (a × b = c)	Relative Beta (d)	Adjusted Net Worth (c × d)
Microsoft	2,000	100	200,000	1.2	240,000
Intel	1,000	67	67,000	1.5	100,500
Texas Inst.	500	160	80,000	1.0	80,000
IBM	500	110	55,000	0.7	38,500
Totals:			402,000		458,500

Using SOX gives us a much closer relationship between actual and adjusted net worth. Since SOX is trading at about 300, you would need

458,400/300, or 1,528, shares of SOX to hedge this portfolio. Or you would need to buy about 15 SOX puts.

*Note:* the reason that the relative Betas are smaller for SOX is that the index itself is quite volatile—as are these stocks—so on a *relative* basis, the index's volatility is much closer to the portfolio's volatility.

---

This might be a good time to describe how to compute the relative Beta. *Beta* is a statistical measure that is used by portfolio managers to correlate how well a certain stock “tracks” the broad stock market. There are two problems with using Beta: (1) the Betas that are published are generally for a long period of time, such as one or two years, and that is an awfully long time to be measuring how a stock performs and (2) Beta is not really a measure of volatility, but of direction *and* volatility. Thus, a stock that goes up when the market goes down will have a small Beta, even though it might be a relatively volatile stock.

---

IBM is a classic example of a relatively volatile stock that has a low Beta—at least in the summer of 1995—because it has correlated poorly with the stock market in recent years. For example, IBM fell from 140 to 47 during 1991 and 1992, while the broad stock market was rising about 20 percent. Then, from the summer of 1994 through the summer of 1995, IBM doubled in price, while the broad stock market rose 31 percent. The Beta had fallen to 0.86 by the end of 1992, reflecting the negative correlation between IBM and the broad market. But, by the summer of 1995, it had risen to 1.52! So which one is correct? *Both*, but at different times. That's why it's sometimes difficult to use Beta as the *relative* Beta.

---

Other measures of volatility that option traders are familiar with are the historical volatility and implied volatility of the stock's options. Because you can also compute the historical and implied volatilities for an index or sector and its options, *you can construct another measure of relative Beta by dividing the stock's volatility by that of the index*. For example, in the summer of 1995, IBM's historical volatility was approximately 24 percent, and OEX's historical volatility was about 12 percent; so the relative Beta would be

24/12, or 2.0. Incidentally, the same calculation done for IBM at the end of 1992 would have yielded a very similar result. So, this method of computing relative Beta is more stable, as the volatility of a stock tends to remain fairly constant, even though its price may change.

Using either historical or implied volatility for computing relative Beta is acceptable, although my gut feeling is that the historical volatility method gives a better picture of how the stock is going to perform and, thus, reduces tracking error.

The following fact, mentioned earlier, is worth repeating: *if, when you compute the adjusted net worth with respect to a certain index, there is a large difference between the actual net worth and the adjusted net worth, then you might be subjecting yourself to a rather large tracking-error exposure by using that index.* Thus, you should be willing to use sector indices to hedge small portfolios and/or portfolios that do not correlate well with the broad market.

There are further nuances involved in hedging a portfolio of stocks, and we will touch on some of them now. The preceding examples involved calculating the number of “shares” of the index that were needed as a hedge. That number was then converted into “number of puts to buy” merely by dividing by 100. This assumes that you are buying at-the-money puts as protection. In reality, this protection won’t be full protection until the index falls and the put’s delta nears 1.0 (actually, *minus* 1.0).

If you were to buy out-of-the-money puts, their protective quality wouldn’t kick in until the index fell below the striking price of those puts. So, to be correct, you should convert the *adjusted net worth* directly into “number of puts” to buy by using the following formula, which is quite similar to what we did earlier:

$$\text{Number of puts to buy} = \frac{\text{Adjusted net worth}}{100 \times \text{strike price of put}}$$

---

*Example:* Returning to the first OEX example, in which the portfolio consisted of IBM, GM, Texas Instruments, and AT&T, recall that the adjusted net worth was \$372,000 vis-à-vis the OEX. OEX was trading at 525 at the time. In order to determine how many puts to buy, according to the preceding formula, you would arrive at the following figures:

Insurance Put Strike Price	Formula Result	Number of Puts to Buy
525	7.0857	7
500	7.4400	7 or 8
475	7.8316	8

You can see that you would buy slightly more puts at lower strikes because you need them to provide “full” protection should the index fall to that lower level. Of course, the protective capability of these out-of-the-money puts doesn’t take effect until the index drops in price. For example, with OEX at 525, if you buy the 475 puts, then you don’t have any real protection until the index falls almost 10 percent ( $50/525 = 9.5\%$ ).

Buying out-of-the-money puts is a cheaper form of insurance—almost like disaster insurance. As with any type of insurance, whether it be fire, personal injury, et cetera—it costs less if there is a smaller probability of actually being used. Thus, the total dollars spent on insurance will be far less if you buy out-of-the-money puts than if you buy at-the-money puts. You need to make a decision on two things: (1) the length of the insurance, and (2) the deductible portion that you are willing to assume. As always, the bigger the deductible that you assume, the lower your insurance premiums will be. For example, many self-employed individuals have opted for high-deductible health insurance; they are willing to pay a couple of thousand dollars of medical expenses themselves, but they are insured for anything over that amount, in case a real medical crisis arises. The cost of that form of insurance is much lower than a normal individual policy.

The type of insurance you select for your stock portfolio can be structured in a similar manner. The “deductible” portion of portfolio insurance is the distance between the current index value and the striking price of the out-of-the-money put that you are purchasing. With OEX at 585, you might buy Dec 575 puts and have very little deductible—only 10 OEX points, or about 2 percent. This means that if your portfolio performs in line with OEX, your portfolio would be protected if OEX fell below 575. Your portfolio would lose money while OEX declined from 585 to 575, but below that level it would be protected.

This low-deductible policy would be fairly costly insurance—the puts would be rather expensive since they're not very far out-of-the-money. On the other hand, you might decide to buy the 550 strike, which has a much larger deductible of 35 OEX points, or 6 percent. That would be less costly because the puts are farther out-of-the-money.

So, in the final analysis of purchasing insurance, you must know what it costs and what kind of protection it provides. Thus, I would recommend making a table similar to the one shown in the next example.

---

*Example:* Suppose that a money manager has a portfolio that has an *adjusted* net worth of \$1.7 million. He wants to use OEX as a hedge but is uncertain about what strike price and expiration date to use. He might make a spreadsheet similar to the following one in order to help him decide.

First, use the formula given earlier to decide how many puts to buy, depending on the striking price involved:

#### **Number of OEX Puts to Buy**

Striking Price of Protective Put	Number of Puts Needed as Protection
450	38
475	36
500	34
525	32

Second, assume that the following prices exist for puts of varying expirations at these striking prices. These prices conform closely with actual OEX put prices in effect during the late summer of 1995. The longer-term puts have higher implied volatilities than the short-term puts do; this is to be expected and is a fact that buyers of insurance have to live with.

#### **Prices of Various OEX Puts**

Strike	Expiration		
	Dec 1995	Dec 1996	Dec 1997
450	1	10	17
475	3	14	21
500	6	20	28
525	13	27	35

Third, using the “number of puts to buy” from the first table in this example and the prices in this table, we can calculate the *actual cost* of insurance for these various striking prices and expiration dates. Obviously, longer-term insurance is going to cost more, and so is insurance with a higher striking price because it provides more immediate protection (i.e., it has a smaller deductible).

**Actual Dollar Cost of Insurance**

Strike	Expiration		
	Dec 1995 (\$)	Dec 1996 (\$)	Dec 1997 (\$)
450	3,800	38,000	64,600
475	10,800	50,400	75,600
500	20,400	68,000	95,200
525	41,600	86,400	112,000

Finally, convert these actual dollar amounts into percentages of the actual net worth in order to see how the purchase of this insurance might affect performance figures.

**Cost of Insurance as a Percent of Net Worth**

Strike	Expiration		
	Dec 1995 (%)	Dec 1996 (%)	Dec 1997 (%)
450	0.2	2.2	3.8
475	0.6	3.0	4.4
500	1.2	4.0	5.6
525	2.4	5.1	6.6

This portfolio manager can now see that if he buys the longest-term protection, using at-the-money options (Dec 1997 expiration, 525 strike), he will have to pay 6.6 percent of the current value of his portfolio. If the market rallies over that time period, his performance will be 6.6 percent worse (about 3 percent annually, since there are more than two years of life in those puts) than that of some money manager who did not buy puts. If he wants cheaper protection, he can buy out-of-the-money puts or shorter-term puts.

Earlier, we described the *collar*, a strategy in which the stockholder not only buys an out-of-the-money put, but also sells an out-of-the-money call as a means of financing the put. This has been a very popular strategy with index options in the past few years and has been somewhat responsible for keeping OEX puts expensive and OEX calls cheap, relatively speaking.

## THE COLLAR

Using options to protect your portfolio is, for most people, more of a theoretical exercise than a practical application. By that I mean that most people *think* about using puts to protect their stocks—and they might even look at a few prices in the newspaper and figure out how much it would cost to hedge themselves—but when it comes right down to it, most people consider the put cost too expensive and don't bother buying the protection.

Especially in a bull market, an investor may feel that money spent buying puts was merely flushed down the drain. That *laissez faire* attitude could get you in trouble, however. Do you have that same perspective on your homeowner's insurance? It's something akin to feeling that fire insurance is unnecessary because the house hasn't burned down before (or recently). The comparison, admittedly, is not a direct one because a natural disaster can occur on a moment's notice, while a decline in stock prices is usually less sudden—unless another crash were to occur—so you would have some chance to buy insurance for your stocks as prices started to fall. However, if you are sitting on large stock profits, you should take a serious look at buying protection using options.

One approach that I like that limits the cost of insurance, although it may remove some or all of your upside profit potential, is the *collar*. In this protection strategy, you buy an out-of-the-money put as insurance and also sell an out-of-the-money call to help finance the cost of the insurance. Thus, you have placed a sort of collar on your stock—you have limited downside risk, but you have limited upside profit potential as well. Often, with a collar, it is assumed that you sell calls and buy puts in equal quantity. However, there is a

modification to the collar strategy that is useful because you don't necessarily have to eliminate all of your upside profit potential.

---

*Example:* Disney (DIS) was on a strong run in 1995 but suffered a setback in late November after earnings were announced. The stock was selling at about 61, and perhaps a holder of 1,000 shares would like to lock in some of the 50 percent-plus gains generated by the stock that year. Assume that he is willing to risk 10 percent (down to 55) but wants insurance if DIS falls farther than that. The following prices exist:

DIS: 61            April 55 put:  $1\frac{1}{8}$             April 65 call:  $2\frac{1}{4}$

Since the call is selling for twice the price of the put, he can sell 5 April 65 calls and buy 10 April 55 puts without actually laying out any money. Then, not only is his entire 1,000-share position protected at exactly 55, but he will make profits up to 65 on all of his shares. Even if prices rise beyond 65, he still has 500 shares that are not covered by the calls that were sold; and those 500 shares can provide upside profit potential.

---

This form of the collar is often a more palatable type of insurance to many investors, since there is no actual cost (in the form of a debit) for the insurance. The cost comes in the form of reduced upside profit potential. With this form of collar, however, you don't even have to give up all of your upside profit potential, only a portion of it. This type of collar even works for highly volatile stocks. Try looking at the option prices on the most extended stock in your portfolio, and you may find a collar that fits like a glove.

Collars can often be best constructed with long-term options (LEAPS) because of the way that the long-term options are priced in order to conform with the lognormal distribution, which is the way that stock prices behave.

---

*Example:* In 2000, Advanced Fibrecom (AFCI) wanted to hedge 5 million shares of Cisco (CSCO) that they owned. At the time, CSCO was trading at \$130 per share with a relatively high volatility of 50 percent. AFCI approached a large underwriting firm that specialized in derivatives to place a "no-cost" collar on their CSCO stock. A *no-cost collar* is one in which the



premium from the call exactly covers the purchase price of the put. Moreover, AFCI wanted the put to have a striking price of 130; that is, there was to be no downside risk. The broker asked AFCI if they minded going out three years for the hedge; and when they said, “No problem,” the deal was structured (these were *not* exchange-traded options, but over-the-counter options created by the underwriting firm). The final terms of the deal may seem quite amazing, but they are in line with Black-Scholes model theoretical prices for three-year options. The three-year put was bought with a striking price of 130, and the three-year call was sold (completing the collar) at a striking price of 200! Yes, that’s right—a volatile stock such as this enabled AFCI not only to own a put that completely eliminated their risk for three years (during which a nasty bear market took place), but also to have the potential to see their stock appreciate by slightly more than 50 percent, if it continued to rise. This was, indeed, an excellent collar.

---

Individual investors can’t trade three-year options with underwriters such as those in the previous example; but when LEAPS options series are first listed on the option exchanges, they have about two and a half years of life. Thus, a similar collar could be established for your own holdings if you act when the LEAPS still have plenty of life remaining in them.

### **Using LEAPS as Collars**

It was mentioned earlier that individual investors can establish collars with listed LEAPS options that might be nearly as attractive as the previous CSCO example—the collar was established with three-year options, where the put strike was 130 and the call strike was 200 (and short-term interest rates were about 5 percent). This collar was a no-cost collar, meaning that no money was required to establish the collar (in other words, the put and the call sold for the same price). There were two factors that led to this attractive situation: (1) the relatively high volatility of the stock and (2) the length of time involved in the options.

Generally stated, the higher the volatility of the stock and the longer the time horizon involved, the greater will be the difference in the striking prices between the call and the put trading for the same

price. Conversely, if an investor were to try to establish a collar with short-term options, it is unlikely that he could find much difference at all between the striking price of the put and that of the call and still find them trading at the same price. The reason behind this is the way stock prices are distributed. Since the markets are lognormal (biased to the upside), a very long-term, out-of-the-money call can be quite expensive (and an at- or out-of-the-money put would be relatively cheap).

Using the Black-Scholes option pricing model, one can construct a general guideline for how far apart the striking prices of the put and the call would be for various volatilities and expiration dates. Table 3.4 shows two possible LEAPS expiration—1.5 years and 2.5 years—and six different volatilities, ranging from 15 percent to 100 percent, assuming interest rates (90-day, T-bill rates) are 5 percent. Lower interest rates will lower all the striking price values in the table, whereas higher interest rates would result in higher striking prices in all cases.

Perhaps the table can best be explained by referring to the previous example in CSCO. In that case, the stock and the put strike were equal—130. The call that paid for the put had a striking price of 200, so the call strike was 54 percent higher than the put strike. In Table 3.4, it is assumed that the put strike and the stock price are both 100, so then the call strike can be viewed as a *percentage* of the put strike. If CSCO were in this table, it would be on the 50 percent volatility row, with 3 years remaining, and the call strike would be 154 (54 percent higher than the put strike). Now look at the 50 percent volatility row in Table 3.4. You can see that 2.5-year LEAPS shows the call strike as 141 (again, if the put strike is 100). So that reduction in time from 3 years down to 2.5 years lowers your potential call strike from 154 (CSCO) to 141 (as in Table 3.4).

You can easily see that the longer the time remaining *and* the higher the volatility, the higher the call strike will be. In some cases, you may decide *not* to collar if you can't get the upside potential you want. For example, suppose you are looking at a 1.5-year LEAPS collar on a stock with 30 percent volatility. Your call strike will only be 20 percent higher than your put strike. Perhaps you are unwilling to cap off your stock's potential at a 20 percent over the next year and a half. If so, then the collar would not be your best strategy.

**Table 3.4**  
**HIGHEST CALL STRIKE THAT PAYS FOR PUT**

Stock Price = Put Strike = 100	Interest Rate = 5%	
	Call Strike	
Volatility (%)	1.5-Year LEAPS	2.5-Year LEAPS
15	117	130
30	119	134
40	120	137
50	121	141
70	124	150
100	130	170

Table 3.4 assumes that the underlying stock pays no dividend. If it, in fact, *does* pay a dividend, then the call strike will be lower because the stock price will essentially be discounted by the dividend stream (i.e., the present worth of all the dividends to be paid until the option expires). Thus, if you try to collar Altria (nee Philip Morris), for example—which pays a big dividend—then you may find that you can't even get 10 points between the strikes. The way to adjust for this is to first subtract the present worth of all the dividends from the current stock price and *then* look at the available options. This simple technique will help to visualize what strike's call will cover the put price (although that put's strike will appear to be out of the money without having subtracted the dividend). An example may help.

---

*Example:* Assume MO is trading at 55 and pays a quarterly dividend of 60 cents. You are considering the use of 2-year LEAPS as a collar. However, when you examine the prices, you find this:

MO price: 55, in early 2004

Jan (2006) 55 put: 9

Jan (2006) 60 call: 3.50

So, not only can't you set up a no-cost collar, but you can't even come close! What is going on? Well, the dividend is what's causing this, along with

low interest rates (at the time, T-bills rates were below 2 percent). MO is destined to pay eight dividends of 60 cents each over the 2-year period—\$4.80 in total. At the time, interest rates were very low, so the present worth of those dividends is \$4.65.

To get a fairer look at things, subtract the 4.65 from the current stock price, giving you an adjusted stock price of 50.35 ( $55 - 4.65$ ). Now, try to find a collar. *These prices are now applicable:*

Adjusted MO price (discounting the dividends) in early 2004: 50.65

Jan (2006) 50 put: 6

Jan (2006) 55 call: 5.5

Thus a collar can be established for a 0.50 debit. Even *this* does not seem real attractive, but you must remember that MO is a low-volatility stock, having a volatility of just below 30 percent. If you refer to Table 3.4, the theoretical calculations would show that you could expect the call's strike for that low volatility over a 2-year period to be about 25 percent above the put's strike. In real life, though, the call in this example has a striking price of 55—10 percent above the put's strike of 50—and a small debit would be incurred for the 2-year collar in that case. The difference is the decline in interest rates. When they are as low as 2 percent, the call's strike in this case is expected to be only about 9 percent above the put's strike, and that's what we see.

You might well decide *not* to use the collar in this case, but at least you have correctly evaluated your alternatives and can make a rational decision after having discounted the current stock price to the extent of the dividends to be paid during the life of the collar.

Since interest rates in recent years have been much lower than 5 percent, we have included Table 3.5, which is the same as Table 3.4 except for the fact that the risk-free interest rate (90-day, T-bill rate) is 2 percent in Table 3.5, whereas it is 5 percent in Table 3.4. The figures in Table 3.5 show that when interest rates are low, the collar is not nearly as attractive a strategy. The call strike is not very far above the put's strike. It is ironic that when interest rates are low, the stock market generally does well, so the chances of the stock rising in price are actually increased—something that also argues against using the collar in this case.

**Table 3.5**  
**HIGHEST CALL STRIKE THAT PAYS FOR PUT**

Volatility (%)	Call Strike	
	1.5-Year LEAPS	2.5-Year LEAPS
	15	107
30	108	113
40	108	114
50	109	116
70	110	119
100	112	126

Of course, as an alternative, a stock owner could merely buy puts as insurance. The low interest rates will also have lowered the price of a LEAPS put. Even so, the purchase of a put will incur a debit, which presumably is not as attractive to the stock owner as a no-cost collar would have been.

In any case, it is imperative that the stock owner understand the effect that dividends, volatility, and interest rates can have on the cost of the collar. For only then can he assess it accurately to decide if it is something he wants to use at the current time.

## **HEDGING WITH OVER-THE-COUNTER OPTIONS**

Another avenue that many large institutional stockholders use in order to hedge their stock portfolios is over-the-counter options. As described in Chapter 1, these *over-the-counter options* are transactions between two parties directly, not traded on an exchange. Typically, over-the-counter transactions can be tailored exactly to what the portfolio manager wants, so he can buy puts and sell calls on his exact stock portfolio, and he can utilize nonstandard striking prices if he wants to. Tracking error can be completely eliminated in this manner, for the over-the-counter put can be constructed as a put on *exactly* the stocks in the money manager's portfolio at that time.

The ability to utilize nonstandard strikes can be advantageous. Suppose the stock owner says, "I want to protect my portfolio if the market declines by more than 8 percent. At what strike can I sell a call that will cover the cost of a put with that protection?" The over-the-counter option dealer (typically a large trading firm such as Goldman Sachs or Morgan Stanley) will then return to him with an offer such as, "You can sell calls 10 percent out-of-the-money and buy puts 8 percent out-of-the-money for the same price on each." This strategy can be used for a single stock or for an entire portfolio; the trading firm will structure the options to fit the portfolio manager's wishes.

There are even more "complicated" options that are being used in the current markets in order to hedge portfolios. They fall in the category of *exotic options*. Exotic options are ones whose values may be dependent on a vast array of conditional parameters.

One simple type of exotic option is called a *down-and-out option*. This option behaves like a normal option, except that it has an additional feature: *if the stock drops to a preset price at any time prior to expiration, the option automatically becomes worthless*. For example, if IBM is currently at 110, then someone might buy a Dec 110 call that is down-and-out at 100. So, if IBM drops to 100 at any time before the December expiration of the option, the call becomes worthless at that time. Otherwise, if IBM never falls that far, then the option behaves just like a normal call and has value if IBM is over 110 at expiration.

You may wonder why anyone would want to buy an option that could "disappear" like that. The main reason is that it's cheaper than an ordinary listed IBM Dec 110 call. It's cheaper because there's a greater chance that the down-and-out option will be worthless. So, if the call buyer feels that IBM will *not* trade at 100 during the life of the call, he can buy a cheaper option initially by utilizing the exotic option as opposed to a listed option.

These exotic options can be structured in many different and imaginative ways. An entire book could probably be written just describing these exotic options. That is beyond the scope of what we are attempting to discuss here. However, there is one interesting exotic option that is being used today as a means of portfolio insurance: the *pay-later option*. This kind of exotic option is obtained for free, initially, and only has to be paid for if the option

finishes in-the-money at expiration. Thus, a money manager who wants downside protection might contact an over-the-counter firm and buy a pay-later put option. If the market goes up, this money manager owes no money, and his performance is the same as any of his competing money managers who did not own insurance. He only has to pay for the put if the market does indeed collapse. He doesn't get a completely free ride, of course, for if the market drops and the put has to be paid for, it will be far more expensive than an ordinary listed put would have been. This is just one example of the many ways that exotic options are being used by sophisticated money managers.

Whenever over-the-counter options are concerned, the Option Clearing Corporation is *not* involved. This could present a problem at some time in the future. Recall that most of these options represent a transaction between a customer (institution) and a large brokerage firm, which is creating these options. Thus, the large firm acquires a position that it eventually must hedge. For example, if money managers are repeatedly buying put options as protection—in whatever exotic form they may be—the brokerage firm is selling those puts. There is the possibility that eventually the brokerage firm's position may become quite large: they could be short many puts.

The possibility that this might happen worries many regulators, for they realize that these large firms must hedge their positions. If the market falls and the firms are short a lot of puts, then they must either sell stocks or sell futures in order to hedge those short puts. Does that have a familiar ring to it? It's exactly what happened in the crash of 1987, when there was a rush by the portfolio insurance crowd to sell futures. A similar but less dramatic event occurred in October 1998 when the market took a rather nasty nosedive in a short period of time. It wasn't exactly a "crash," but it was certainly panicky selling. That decline was partly fueled by market makers who were short puts and selling futures as a hedge. Eventually, one of the larger firms removed its hedge at exorbitant prices, and that put an end to the decline. But if the decline had gone on a little longer, it could have turned even bloodier than it was because more and more naked puts would have had to be hedged. Of course, no one wants to see either scenario repeated, and the large firms do their best to find over-the-counter sellers of puts to help offset their positions. The worrisome

part of this situation is that no one knows the total extent of the exposure. There are no open interest figures that need to be reported and no reports that are filed. Therefore, there always exists the possibility that a dramatic down market could turn into another crash if there is a rush to hedge the over-the-counter positions.

## **USING VOLATILITY FUTURES AS PORTFOLIO INSURANCE**

The CBOE's new volatility contracts (futures symbol: VX) were listed on March 26, 2004. These new contracts are *dynamic* in that they will provide a hedge for you during a declining market, *no matter when that decline occurs and no matter where the market is when the decline begins*. This is a vast improvement over, say, buying puts for insurance purposes. We'll spell out the mechanics of operating such a hedging strategy, and we'll look at some of the problems that may occur.

We expect this to be a very successful product—perhaps the most successful new listed derivative product since the introduction of index options in 1983.

The CBOE's volatility trading instrument is a futures contract that is traded on the newly created CBOE Futures Exchange (CFE) (base symbol: VX). Thus, in order for any trader or investor to be able to trade the new contracts, he or she must open a *futures* account. Now, this may seem like a formidable impediment to many stock owners, but it shouldn't be. You don't have to trade corn, pork bellies, and cattle futures. You merely have to put some cash in a new account, fill out a new account form, and, voila, you are ready to trade the VX futures. All stock owners should consider using these futures as a hedge against declining markets. Suffice it to say that, during a bearish trend—or a full-fledged bear market—I believe this is the most efficient way to safeguard your assets that has yet been designed for use by the layman in the listed markets. The benefits of that ability to hedge are overwhelmingly superior to the minor inconvenience of having to open an additional account—a *futures* account—at your favorite brokerage firm.



## The Contract Details

The Volatility index (VIX)—created to measure implied volatility of OEX options—was introduced in 1993. In 2003, the CBOE changed the VIX to be the measure of implied volatility of the S&P 500 Index (SPX) options. The “old” VIX became VXO, which still measures the implied volatility of OEX options.

The sole initial product of the CFE is futures on the VIX. To implement this contract, a new volatility index, called the Jumbo CBOE Volatility Index (symbol: VXB), was created. VXB is equal to 10 times VIX. The futures are futures on the Jumbo VIX and are worth \$100 per point of movement. *So, one futures contract will make or lose \$1,000 when VIX moves by one full point (from 15.00 to 16.00, for example).*

The futures trade with the base symbol VX and expire in February, May, August, and November, plus there is a contract in each of the two nearest months not included in that February cycle. There are four months available for trading at any one time. So, if today were June 1, then there would be contracts expiring in June, July, August, and November. (If the contracts prove to be successful, there will probably be additional months added.) The minimum tick in the volatility futures is 0.10 (which is the same as 0.01 for VIX) and is worth \$10.

The VX futures have different expiration dates than CBOE-listed index options do. The last trading day is the Tuesday immediately before the third Friday of the expiration month. The actual settlement price, though, is determined on the Wednesday morning following that Tuesday. In a procedure somewhat similar to the “A.M. settlement” that exists for most cash-based index options, a “Special Opening Quotation” (symbol: SOQ) of VIX is calculated from the opening price of the options used to calculate the index on the settlement date (the Wednesday morning in question). The opening price for any series in which there is no trade shall be the average of that option’s bid price and ask price as determined at the opening of trading. The final settlement price is rounded to the nearest 0.10. The futures then settle for cash at a price equal to 10 times that “Special Opening Quotation.”

Futures must be margined. The margin requirements are set by the Exchange, and you should check the CBOE web site for the exchange minimum margin (currently \$3,750 per contract). The CBOE allows SPAN margin to be used—a volatility-based margin calculation, which is generally favorable to customers.

---

*Example:* On April 1, suppose that VIX is trading at 16.48 and that the May VX futures are trading at 174.301 (they will have some premium in them, most likely). You buy one May VX futures contract at a price of 174.30.

Since the futures contract is worth \$100 per point and you paid 174.30 for this contract, you are therefore “controlling” \$17,430 worth of VIX initially. Let’s suppose the margin for this trade is \$3,750. That can be satisfied with equity from your account.

Suppose that shortly after your purchase the stock market rallies and VIX drops quickly to 16.05—a drop of 0.43 points. Your futures will drop accordingly, but not by necessarily that exact comparable amount, which would be 4.30. If panic selling sets in, your futures could lose some of their premium. Let’s say that the futures you own drop to 169.00 and the market closes. You now have a loss of 5.3 points on your futures. A one-point move is worth \$100, so you have a \$530 loss (unrealized) at this time. Your account is debited that amount, and the margin calculations are redone to see if you are still in compliance. If you fall below maintenance margin requirements, your broker will ask for more margin (and will sell you out if you fail to comply—just as would happen with stock bought on margin).

Let’s say you hold on; VIX rallies over the next few weeks, and expiration day has arrived. You decide not to sell your futures in the open market, but rather to let them settle for cash on expiration day. Remember, each day, the daily profit or loss is credited to or debited from your account. On the last day, suppose that the SOQ for VIX is 21.40. Your futures would then settle at a price of 214. That’s a profit of 29.70 points from your initial purchase price of 174.30. You would have made \$2,970, less commission, on the trade. Since you held them all the way to settlement, the last day’s profit/loss is credited or debited, and the futures disappear from your account. The sum of all the daily credits and debits will total \$2,970; so that much cash would have accumulated in your account (assuming you didn’t use it for something else in the meantime), and the futures would no longer be in your account.

---

## Strategies for Protecting a Portfolio of Stocks with VX Futures

The reason that VX futures are a good hedge in a down market is that implied volatility (i.e., VIX) shoots up when the market falls, especially if it falls sharply. The long-term graph of VIX presented as Figure 4.19 clearly shows this. Any long-term chart of VIX verifies that it rises strongly during declining markets.

So a simple hedge for a portfolio of long stocks would be to buy some volatility futures. Furthermore, a hedge of this sort is *dynamic*—it works for you no matter when the market starts to decline (as long as it's prior to the expiration of the VX futures contract you own) or from what level. This is distinctly different from buying put options as protection. In the latter case, if you buy puts as protection and market rallies strongly for a while, your puts are then so far out-of-the-money as to be essentially worthless for insurance purposes should the market suddenly decline from that elevated level. That is *not* the case with VX futures. They will shoot up whenever and wherever the market declines.

---

*Example:* Suppose that you own a broad portfolio of stocks worth \$100,000. Furthermore, you agree with the premise of hedging by buying VX futures. Let's say you are cautious about the idea, though, and buy only one futures contract, as shown in the following.

With VIX near 15 in April, you buy one August VX futures contract at a price of 159. Note: this means that there is a premium in the futures (150 would be parity, so you are paying 9 points, or \$900, above parity to buy the futures). Such a premium is likely to be built into the futures, especially when they are trading at low levels; so that there is an expense to this hedging strategy—the premium in the futures.

Furthermore, let's assume that your stock portfolio moves more or less in line with the broad market.

Shortly after your purchase, the market starts to head south and gains momentum. By the time it has fallen 10 percent, VIX has traded up to 20. Your future contract is now trading at 205, say. So, you have a \$10,000 loss (on paper) in your stock account and a 46-point gain (\$4,600) in your futures contracts. Now, the one futures contract has not completely hedged away the loss in your stock account, but it has certainly helped.

However, suppose that the market continues to decline and a bit of panic sets in. With the market now down 20 percent from the top and falling rapidly, VIX shoots up to 30. The futures should be trading somewhere near 300—a gain of 141 points from your purchase price. So, while there is a \$20,000 loss on paper in your stock account, you have a \$14,100 gain in your futures account.

---

Thus, the futures in the preceding example provided an excellent hedge against a declining market. A complete hedge could have been constructed by buying more than one futures contract, of course. Once VIX has made its move, you could remove the hedge or keep it, realizing that if the market rallied, you would lose back some of the profits on your futures. Of course, if the market continued to decline rapidly, your VX futures would shoot through the roof.

Just as an example, when the last bear market began in March 2000, VIX was near 20. By the time that bear market bottomed, in July or October 2002, VIX had risen above 40. Hence, one VX futures contract (had they existed at the time) would have appreciated by \$20,000.

Such random or selective data points don't make for a long-term study, though. So let's construct a more rigorous study. Table 3.6 compares the semiannual changes in VIX and SPX in percentage terms. The final column shows how a trader's portfolio would have done had he invested 90 percent of its assets in the SPX and hedged that by taking a 0.1 position in VX futures—in other words, the right-hand column is 90 percent (0.9) of the percentage change in SPX plus 0.1 the change in VIX.

With just this simplistic model—long 90 percent SPX and long 10 percent VX futures—one can see the benefits of the hedge. The total profit is nearly the same, where the total of the "SPX %" column is 108.6, and the same total for the hedged position (the right-hand column) is 105.6. However, the *volatility* of the portfolio was greatly reduced. Notice that during the bear market, the SPX was down five periods in a row; but in four of the five, the hedged portfolio lost less (since VIX rose during those quarters). To put it in statistical terms, the standard deviation of the semiannual returns was near 11 percent for the SPX, while it was just above 9 percent for the hedged portfolio. Hence, the hedge not only reduces losses in a

**Table 3.6**  
**A SEMIANNUAL HEDGE WITH VIX FUTURES**

Date	VIX	SPX	VIX%	SPX%	0.9*SPX% + 0.1*VIX
1993020	12.33	442.5			
1993080	11.47	450.2	-7.0	1.7	0.9
1994020	10.64	479.6	-7.2	6.5	5.2
1994080	11.16	461.0	4.9	-3.9	-3.0
1995020	11.72	470.4	5.0	2.0	2.3
1995080	13.55	559.6	15.6	19.0	18.6
1996020	12.64	638.5	-6.7	14.1	12.0
1996080	18.76	650.0	48.4	1.8	6.5
1997020	19.57	786.7	4.3	21.0	19.4
1997080	22.29	947.1	13.9	20.4	19.7
1998020	21.35	1001.2	-4.2	5.7	4.7
1998080	25.98	1112.4	21.7	11.1	12.2
1999020	27.67	1273.0	6.5	14.4	13.6
1999080	25.58	1328.0	-7.6	4.3	3.1
2000020	23.45	1409.2	-8.3	6.1	4.7
2000080	20.54	1438.1	-12.4	2.1	0.6
2001020	21.66	1373.4	5.5	-4.5	-3.5
2001080	20.55	1215.9	-5.1	-11.5	-10.8
2002020	21.11	1122.2	2.7	-7.7	-6.7
2002080	36.95	884.6	75.0	-21.2	-11.6
2003020	31.01	860.3	-16.1	-2.7	-4.1
2003080	20.75	980.5	-33.1	14.0	9.3
2004020	17.11	1135.2	-17.5	15.8	12.4
<b>Totals</b>				<b>108.6</b>	<b>105.6</b>
<b>Standard Deviation</b>				<b>10.9%</b>	<b>9.2%</b>

bear market, but it also reduces the volatility of the portfolio's returns while not harming the overall return significantly.

The forgoing study is really quite simple. A more complicated study was performed by Merrill Lynch published under the title, "Volatility—The Perfect Asset?" While it is quite mathematical in nature, several conclusions are drawn from the paper: a portfolio of long 10 percent VIX and long 90 percent SPX, rebalanced weekly,

has outperformed the S&P 500 Index by about 5 percent per year with 25 percent lower risk since 1986. (Note: the strategy made a large amount of money, theoretically, in the crash of 1987 since VIX rose nearly sevenfold on the day of the crash; this fact helps the overall returns since 1986. Without including 1987, the yearly outperformance was about 2 percent—still very respectable, considering the lowered volatility of the combined portfolio.)

## What Can Go Wrong?

The theoretical studies just mentioned did not encompass one thing that we had shown in our original examples—there may be a premium in the futures contract. If one had to pay a premium consistently, that would reduce returns for the hedging strategy.

When can we expect the futures to have a premium? When they are low-priced. The reason I can state that with some assurance is this: VIX trades in a range. Its lifetime low is about 10, and its lifetime high (excluding the crash of 1987) is about 60. So when VIX is near 10, speculators will be buyers along with hedgers; and VIX will probably trade at a premium as a result. When VIX gets expensive—say, at or above 40—then VIX will probably trade with a discount, since sellers figure it will decline from there. The latter (discount) is less certain than the former (premium) because VIX *could* temporarily spike quite high, as it did in the 1987 crash.

However, it is a certainty that VIX cannot go below zero and cannot go up forever. So the lower it goes towards zero, the more buyers there will be among speculators; and the higher it goes, the more sellers there will be. The speculative activity is likely to put a premium on the futures when they are low and perhaps produce a discount when they are high.

So, suppose that we as hedgers pay 160 for the futures when VIX is 15.0. Yet, nothing transpires that quarter, and VIX is literally unchanged at quarter's end. So the futures expire at 150—a loss of \$1,000 per contract. Now, the hedger must buy the *next* futures contract, which is likely to have a premium; and the whole procedure could repeat itself. As long as VIX remains low-priced, the premium on the futures will likely persist, and the cost of the hedge will be increased by the amount of the premium.

I view this as the biggest problem with the hedging strategy. How expensive will the premium be? It's hard to say at the current time; but since VIX can't be arbitrated\* (there is no underlying or equivalent), it won't necessarily remain at "fair value" and, therefore, the premium may be larger than expected. Even so, the strategy is worth consideration by any holder of stocks.

## Options on VX Futures

Eventually, the CBOE intends to list options on VX futures. Maybe someday there will even be options on the volatility of individual stocks, like IBM. But even with options on VX futures, the hedging possibilities expand for the stock investor. Rather than buying VX futures to go along with a portfolio of long stocks, the investor could just buy out-of-the-money VX calls instead. Then if VX spikes, the calls would profit. However, if VX stays in a trading range, the calls have much less risk than the futures would. Therefore, they would presumably be less of a drag on performance in rising and flat markets.

For example, if VIX were trading near 15, rather than buy the VX futures, an investor might buy VX futures calls with a striking price of 30. The calls would profit if VIX moved above 30 before the calls expired, which presumably would happen in a sharp market decline. This is much better than buying SPX puts, say, because the protection is still dynamic. No matter where the SPX is trading, when it begins to fall sharply, VIX will rise, and the calls will be providing portfolio protection. Since VIX moves in a more or less constant

---

\*In order to be able to arbitrage the VX futures, one would have to be able to trade the VIX itself as a cash index or trade an equivalent. You might think that you could, for example, sell a representative portfolio of SPX options on the CBOE and buy VIX futures as a hedge. That is not arbitrage. One big problem is that the volatility of the SPX options eventually converges on the *actual* volatility of VIX at expiration, but VIX does not ever have to trade at a level equal to actual SPX volatility. Also, the sale of SPX options introduces other risks—price, time, delta, and gamma—not just volatility. Hence, there is no arbitrage. But if the premium on VX futures were to get extremely far out of line, the arbs and market makers would execute the SPX options versus VX futures trade as a hedge, trying to capture *some* of the differential from fair value at which the futures are presumably trading. This risk hedging action will *help* to keep VX futures "in line," but it won't guarantee by any means that they will trade at "fair value."

range, owning VIX calls at 40 would always be an effective hedge in a severe market drop. But that’s not the case with SPX puts. If the market rallies strongly after you buy SPX puts and then later collapses, the puts’ strike may not be close enough to the SPX price to provide any protection to the stock portfolio.

When and if the VX options begin trading, an investor will need to use the “volatility of volatility” to price them. In others words, the actual (historic) volatility of the VIX will be used as one of the inputs into the Black-Scholes option pricing model in order to price such options. The volatility of VIX is surprisingly large. You might think it would be small since VIX constantly trades in a range between roughly 15 and 35, but it does so in a phrenetic manner. So the volatility of volatility (VIX) is higher than you might expect—generally ranging between 50 percent and 120 percent. Figure 3.2 features a

**Figure 3.2**  
**VIX VOLATILITIES**

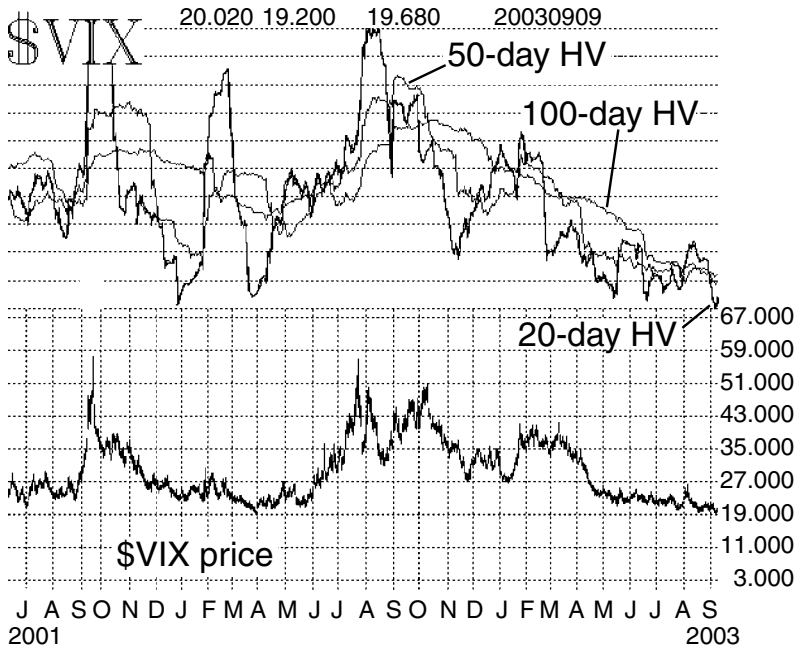



chart of VIX with the 20-, 50-, and 100-day historical volatilities graphed above it. Just during the two-year period 2001–2003, the 20-day volatility ranged from 42 percent to 140 percent.

## **SUMMARY**

In this chapter, we presented some basic option methodology that can be very profitable in a number of situations. An understanding of the option positions that are equivalent to being long or short the underlying is a useful tool, and a mandatory one for futures traders. Considerable time was spent explaining how great an effect S&P futures have on the stock market, and then strategies were laid out for profiting from that knowledge, especially at expiration of options and futures. Finally, techniques for protecting a portfolio of stocks with options were demonstrated.

# 4 The Predictive Power of Options

Options can sometimes be a very useful tool for predicting the movement of the underlying instrument. In certain cases, option statistics are sentiment indicators, indicating what the “public” is doing. In other cases, it pays to watch option volume and pricing levels because “smart money” might be buying options in preparation for a move by an underlying stock. In this chapter, we explore how to use and interpret option statistics for the purposes of trading the underlying.

## USING STOCK OPTION VOLUME AS AN INDICATOR

Most traders have noticed, or at least have heard financial commentators mention, the fact that a takeover offer or other surprise corporate announcement was “tipped” off by heavy option trading on the day(s) preceding the actual announcement. Obviously, someone had advance knowledge of the corporate event, or at least rumors were strongly circulating among the “in crowd.” Of course, most people only find out about this heavy volume *after* the fact.

*A significant increase in the trading volume of a stock’s options often is a precursor of movement by the underlying stock.* This statement is only true if the volume is speculative in nature. If the increased volume is due to irrelevant factors, such as arbitrage or spread trading, then it is meaningless as far as predicting stock movement. Later, we discuss methods for screening out such irrelevant data.

The reason that the preceding statement is true is leverage. Those with inside knowledge will buy options because they can score highly leveraged gains when that knowledge becomes fact. For the same reason—leverage—they prefer to buy options rather than stock. Their “tracks” are visible to the entire investment community, in terms of increased option trading volume. Whether those insiders are acting legally is unimportant, for it is perfectly legal to monitor option volume and trade accordingly.

I’ve had some traders argue with the premise that those with inside information buy options rather than stock, and I usually ask them this question: if you had tomorrow’s newspaper, what would you do, buy stock or options? Actually, the correct answer to that question is “play the lottery,” but you get the point. If you know you have an almost sure thing, you would look to maximize your percentage returns as much as possible. By the way, if you ever *do* get a copy of tomorrow’s paper and there isn’t any lottery tomorrow, then head out to the race track.

It should be pointed out that stock volume also often increases prior to major corporate announcements. Some of the stock volume is spillover from the option pits as market makers rush to buy stock to cover some of the options they have been selling in the course of making markets. Also, the stock market is generally more liquid than the option market, so the insiders may be forced to buy stock in order to amass a large position. However, it is the option volume that provides the most reliable clues to the major corporate announcements that make stocks move: earnings reports, takeovers or mergers, and filings or settlements of major lawsuits.

## **How Much Is Too Much?**

When looking for “increased option volume,” don’t be concerned with the most active options. These are two distinctly different things: *increased option volume* refers to the amount of trading in a stock’s options *compared to the average number of options traded on that stock*. The stocks with the heaviest option volume are likely to be IBM or Philip Morris, for example, but *any* stock can see its option volume shoot up to high levels when compared to its normal volume.

On a typical day in the summer of 1995, the most active optionable stocks and their average option volume were:

Stock	Total Option Volume	Average Option Volume
IBM	37,705	33,743
Intel	36,984	30,688
Micron Tech	25,539	21,569
Microsoft	22,455	21,371
Compaq	18,409	11,973

As you can see, the high-tech stocks dominated the trading volume. There is very little that is unusual in these figures when you compare the total volume for that particular day with the average volume. However, these volume figures were also traded on that same day:

Stock	Total Option Volume	Average Option Volume
Novell	24,410	8,489
Home Shopping	1,430	148
Integrated Silicon	1,158	368
Maxtor	1,670	557

You can see that the ratio of total option volume to average volume on each of these four stocks was at least three-to-one and was quite a bit larger for Home Shopping Network. On that particular day, Novell's option volume was due to news that was already out (bad earnings), but the other three were definitely ones to watch, as their option volume might be foretelling some significant corporate news. As it eventually turned out, not much happened in Home Shopping or Maxtor, but the Integrated Silicon volume was another story. The option volume shown here mostly consisted of puts, which was a bearish indication by the options. The stock fell 14 points within a week, an excellent trade produced by option volume.

It is situations of this latter variety that can alert you to stocks that are about to make significant moves. If there is excessive call option volume, then you would expect to see positive news announced soon

and would look to buy the underlying stock. If there is excessive put option volume, then a short sale is possible because bad news may be just around the corner. If there is excessive volume in both the puts and the calls, it is my experience that the stock is generally leaning to the positive side, but not always; so you should be ready for a breakout in either direction and follow it in that case.

## The Analysis

Now let's discuss, theoretically, the steps to follow after first spotting a potentially true high-volume situation. After that, we discuss some of the specifics (and problems) involved with applying this theory. Experience has taught us that only situations in which today's total option volume is greater than *double* the "average" option volume are worth exploring; and where the options are normally very active, an even greater ratio is desirable. Once one of these high-volume situations has been identified, some additional work must be done.

First, you must screen out situations where the option volume is related to nonspeculative things, such as arbitrage. On a given day, you may find between 40 and 60 different stocks that have traded double their average option volume. As expiration approaches each month, that number can swell to well over 100 underlying issues. In reality, only a handful of these have true speculative volume; the others can be disregarded after careful analysis. This analysis can be time-consuming, but computers can help to a certain extent. Over the years, though, we have found that it can be a mistake to let the computers screen out too many situations. If you miss just one 20-point takeover because you were trying to save yourself a couple of minutes of analysis each day, you will rue your decision.

One screen is to see if too much of the total volume is concentrated in too few options. *If almost all of the option volume is concentrated in one series (that is, just one call or just one put), then it is unlikely that anything special is going on with that stock.* For example, if most of the total volume is in one call series, then it is quite likely that an institution executed a sale of calls against stock that they own. This sale of options would most likely be executed at one time and would appear on the tape as a block sale (if you have

access to option time and sales, you would readily spot this fact). On the other hand, if most of the volume is in one put series, then an institution probably bought a block of puts to protect a holding in the underlying stock. In either case, the trade, no matter how large it is and how many times it exceeds the average volume, has nothing to do with supposed corporate developments. Thus, this situation should be rejected as not having any trading viability.

*Example:* This situation is fairly common; ones like it occur almost every day. Assume that total option volume in XYZ options was 1,385 contracts, while average option volume at the time was only 250 total contracts per day. Thus, this situation would show up on the initial computer runs. Suppose the stock had closed at 35 that day. Upon further inspection, however, this is how that volume broke down:

<i>Option</i>	<i>Volume</i>
Sep 35 call	1,350 contracts
Sep 30 put	23 contracts
Oct 40 call	12 contracts

Thus, even though total volume of 1,385 contracts was significant in light of the fact that average volume is only 250 contracts, it appears that a block trade of 1,300 or more contracts took place. We say this is a block trade because there is only significant volume in the one series: the Sep 35 call. In fact, if you subtract out the block trade, you often have a situation where option volume was *below* average that day.

If the volume is predominantly concentrated in one series but is not identifiable as a block trade from the time and sales tape, it is probably still not noteworthy. It is our feeling that if the public (which includes unknown inside traders) enters the marketplace and repeatedly buys one option series, the market makers end up selling them most of the options. The market makers are, by definition, risk averse. They attempt to make their money, if possible, by buying on the bid and selling on the offer. If they can do that repeatedly and go home “flat” every night, they would be quite satisfied. When there is large demand in one series, the market makers cannot get flat; so they must hedge themselves by buying other options to partially

offset the ones they are selling to the public. When they do this, the heavy option volume propagates itself out from the series that the speculators are buying into other months and striking prices. This telltale “picture” is what we look for to define a true speculative situation. We show some examples of it shortly. For now, suffice it to say that if nearly all the option volume is concentrated in one series, then there is very little chance (note, we do not say *no* chance) that a true speculative position is at hand.

There is always an exception to any rule, and the exception to this concentration of volume screen may occur in a low-priced stock. If a stock is selling for less than \$5 per share, it is possible that the only striking price for its options is 5. Moreover, since you can fairly assume that the stock has been declining for some time in order to be so low-priced, there is probably very little activity in the options. In such a case, there may be virtually no options offered in the midterm or long-term options. Thus, if “insiders” come in to buy options from the market makers, the market makers may have no place to go to buy other options (they can always buy stock, of course; but it would be in fragmented pieces, so it would be hard to spot). Thus, at the end of the day, almost all of the option volume might be concentrated in one series because that is the only series that is virtually available for trading.

---

*Example:* Suppose that XYZ is a \$4 stock and that it has been depressed at those levels for some time. The option exchange may even be considering delisting it. At one time there were striking prices of 15, 12½, 10, and 7½, but these are all now delisted because they have no open interest. Suppose that it is June and that the only options available for trading are the July 5s, August 5s, and October 5s.

An insider wants to buy options in XYZ because he knows that the company is going to announce the signing of a large contract that will spur the stock and make it rise in price. He first attempts to buy the July 5 calls, and the market makers sell him several hundred before they realize that this is such a large buyer. Since this is a rather illiquid issue, there are no offers to speak of in either the Aug 5 calls or the Oct 5 calls. In fact, these same market makers won't sell those calls, of course. Finally, they are forced to buy stock as a hedge. The insider is probably buying stock by now, too, since they won't sell him any more calls.

The end result is that we have a truly speculative situation; but at day's end, almost all of the option volume is concentrated in the one series—the July 5 calls. This is a stock that option volume watchers should want to be in, but they will “screen” themselves out of it if they blindly apply the screen that discards all situations in which the option volume is mostly in one series.

---

Another reason that there may be a large increase in volume is because a spread trade has been executed. There are option strategists who control rather large sums of money and who sometimes execute large ratio spreads, vertical spreads, or combinations. Again, this type of trading has nothing to do with predicting forthcoming corporate announcements, and we must screen it out also. *Thus, if almost all of the option volume is concentrated in just two series, especially if the two series have approximately equal volume, then once again it is unlikely that a true speculative situation exists.*

---

*Example:* Suppose XYZ is trading at 50, and we notice the following option activity at the end of a trading day:

Average volume: 100 contracts

Today's volume:

<i>Option</i>	<i>Volume</i>
Feb 50 call	400 contracts
Feb 55 call	425 contracts
March 50 call	40 contracts
Total volume:	865 contracts

On the surface, this looks like a huge option volume day, since 865 contracts traded, as opposed to the average of a mere 100 contracts. However, most of the volume was in just two series—the Feb 50 and Feb 55 calls—so it looks like this was a spread positioned by a nonspeculative trader. We would discard this stock from further consideration as a trading candidate for that day.

---



Another screening “rule” will also get rid of arbitrage situations. In conversion or reversal arbitrage, the arbitrageur takes a position that is equivalent to the underlying stock. This is the type of trade that we discussed at length for some other applications, in Chapter 3: buying the calls and selling the puts with the same terms is the same as being long the stock. If a large arbitrage has taken place, then we will notice increased volume in just those two series—the put and the call with the same terms. If that constitutes most of the option volume, then we can ignore the situation as having much validity in terms of a true prognostication.

---

*Example:* This time, suppose XYZ is trading at 40, with the following option volume:

Average volume: 300 contracts

Today’s volume:

<i>Option</i>	<i>Volume</i>
March 45 call	700 contracts
March 45 put	700 contracts
March 40 call	250 contracts
Total volume:	1,450 contracts

Once again, we would probably discard this situation, as it appears that the volume in the March 45 calls and puts is part of an arbitrage (or a stock equivalent position, as described in Chapter 2).

---

Further screens can be applied. For example, a significant portion of the option volume will consist of at- or out-of-the-money options if insiders are doing the buying. Remember, they are attempting to use leverage, so they will normally attempt to buy the cheapest options possible. *Thus, if you see that a large amount of the daily volume is being contributed by deeply in-the-money options, then you can be reasonably assured that this situation can be discarded.*

---

*Example:* Suppose XYZ is trading at 48 and option volume is heavy at 1,000 contracts, as compared to the average volume of 250 contracts. However, the distribution of the option volume looks like this:

<i>Option</i>	<i>Price</i>	<i>Volume</i>
Oct 40 call	8½	400 contracts
Sep 35 call	13	400 contracts
Sep 45 call	4	150 contracts
Sep 50 call	1½	50 contracts

Here, 80 percent of the volume is in options that are 8 or 13 points in-the-money. If the call buying were being done by speculators with some sort of inside information, they would want leverage. They would buy the Sep 50 call and the Sep 45 call before they would buy the more expensive in-the-money calls.

Admittedly, you would get some leverage by owning an 8½ dollar call or a 13 dollar call as opposed to a 48 dollar stock, but that wouldn't be your first choice if you had inside information. Thus, we would have to conclude that this option volume is not predicting any corporate developments. It is more likely that a quasi arbitrage or deeply in-the-money spread or covered write was established by an institutional or arbitrage trader.

---

There is an exception to this screen also, and it involves put options. There is a strategy that some very large traders use in order to get short stock in a fairly easy manner. Suppose that you had a large amount of capital at your disposal and knew that a stock was about to get some bad news. Or perhaps it was already trading down some, and you were having trouble getting an uptick to short the stock. No problem. If you could just buy a block of stock and simultaneously buy some in-the-money puts at parity, your problem would be solved. Why? Because you could then just sell your stock, which is long, as sloppily and rapidly as you wanted in the open market. This would leave you with just the long puts, which would of course be increasing in value as you pummelled the stock. After you were done selling your long stock, you would probably have scared other stockholders into selling, so they would be pushing the stock down farther and increasing the value of your puts as well. Finally, you could exercise your puts to get short if you wanted to, but there wouldn't really be any necessity for that.

You might say that this all sounds well and good, but how could the trader just buy stock and buy puts in large size so easily? The answer is that an arbitrageur will take the other side of the trade,

merely in order to earn interest on the credit balance generated by selling the stock and selling the puts. Eventually, when the speculative trader exercises the puts, the arbitrageur will be assigned and his position will disappear.

The following example is in two parts. The first part shows the arbitrage; the second part shows how the situation looks to the trader who is monitoring option volume.

---

*Example:* Assume that it is early in July, XYZ is selling at 22, and an insider knows bad earnings are on the way. He buys some out-of-the-money puts, and a negative rumor circulates on the Street. A large, aggressive trader gets wind of the rumor and decides to capitalize on the situation also.

The large trader calls up an arbitrageur and asks if he would sell the stock (short) and sell the July 30 puts. The arbitrageur says that he will, subject to being able to borrow the stock. A check with the stock loan department shows that 60,000 shares of the stock are available for borrowing. Thus, the following trade takes place as two block trades: (1) the stock being executed probably on a regional stock exchange and (2) the options being executed on the option exchange.

<u>Large Trader</u>	<u>Arbitrageur</u>
Buys 60,000 XYZ at 22 $\frac{1}{8}$ (an uptick)	Sells short 60,000 XYZ at 22 $\frac{1}{8}$ (an uptick)
Buys 600 July 30 puts at 7 $\frac{7}{8}$	Sells 600 July 30 puts at 7 $\frac{7}{8}$
Net money: \$1,800,000 debit	\$1,800,000 credit

As long as the position is in place, the arbitrageur is earning interest on \$1,800,000. The arbitrageur has risk that the stock could rise above 30, in which case it would cost him more than \$1,800,000 to buy his position back. But the large trader will tacitly assure the arbitrageur that the puts will be exercised before that happens. Note that when the puts are exercised, the arbitrageur's position is completely closed out: the put exercise causes him to be assigned—the arb buys stock—60,000 shares at 30.

Meanwhile, the large trader begins to sell the 60,000 shares that he is long into the open market. He “pounds” the stock downward until he draws out other big sellers, at which point he buys back the stock for a nice profit, exercises his puts, and closes out both his and the arb's positions. This may take place in as short a period as one day, or it may stretch out a little. There are also slight variations on the order of events that the large trader

transacts after the arbitrage position is established, but the end result is the same: the stock goes down.

Now, suppose that, separate from all of this, you are monitoring the option volume of XYZ on that first day and you notice that 850 contracts traded, while average volume was only 250. Furthermore, these contracts are mostly puts, but they have this distribution:

<i>Option</i>	<i>Volume</i>
Sep 20 put	200 contracts (bought by the insider)
Sep 20 call	50 contracts (unknown origin)
Sep 30 put	600 contracts (described above)

If you blindly applied the screen against in-the-money options, you would ignore this situation; but since puts are involved, a closer look is required. If the stock starts to “tank,” you should probably buy some puts yourself, as you can then be fairly certain that whoever bought those 600 in-the-money puts is hammering the stock, and you can ride his coattails profitably.

The last major screen that is usually applied is one concerning the expiration dates of the options that are most heavily traded: the near-terms or the far-terms. For reasons of leverage once again, the speculators with inside information will buy the near-term options (assuming that they are not too near-term), for these are cheaper in price and are generally the most liquid contracts. The one exception would be if the most near-term options are going to expire in a matter of just days, then the majority of volume might move out one month to the next contract. However, if a majority of the volume is concentrated in longer-term contracts, then you would have to suspect that institutions are writing covered calls; they often prefer to write call options with several months of life remaining or to buy midterm puts as protection.

As mentioned earlier, the approach of an expiration Friday can cause option volume to increase in many issues. This is because many option traders either close out their positions or roll them out to the next month. These activities are again among those that are *not* indicative of speculative activity, but are just in the normal course of events. Of course, such activities will still show up in the initial test

when you look for stocks whose daily option volume is at least double the average volume.

Most option traders who have positions in expiring options will wait until nearly the last trading day—the third Friday of the month—before closing out those positions, although some expiration-related activity begins on Wednesday and increases on Thursday. Thus, the observer of option volume must allow for this potential increase in activity when he is applying his screens. On expiration Friday itself, he can literally ignore all trading in the expiring options as having anything to do with speculation. In addition, some of the volume in the next month's options—whatever amount is related to positions being rolled out to later months—is irrelevant as speculation also.

On the Thursday before expiration, these same statements are *mostly* true, although there have been a few cases throughout the history of listed options where a takeover did occur on expiration Friday. One of those was Gerber, whose story was related in Chapter 1. Another occurred back in 1987.

---

Farmer's Group options had been extremely active all day on the Thursday prior to expiration; moreover, a substantial portion of that volume was in options that were expiring the next day. Option volume continued to be heavy on expiration day itself. Rumors were running rampant that a takeover of the insurance company was imminent. But by the time the stock market closed, there was no news of the merger. Moreover, when the time had come to submit exercise notices, there was still no announcement. However, it was not long thereafter that news of a large takeover was announced. Thus, it was necessary to monitor the Thursday volume in expiring options in order to "catch" this takeover.

---

So, while you can ignore *most* of the volume in options that are going to expire in two or three days as being irrelevant due to expiration, it would be a mistake to be dogmatic and say that all such volume can be ignored. Thus, as expiration approaches, you will have a larger and larger universe to screen. The screening process itself thus becomes more of an art than a science as expiration approaches. My general guideline is that I will tend to eliminate any situation near expiration unless the option volume is truly dramatic, probably at least three or four times the average volume. And even

then, of course, that volume must pass all of the previously mentioned screens.

There is another “message” that stock options can give you at expiration: they can often tell you *whether “old” rumors are still alive*. This information can be gleaned by seeing what the option volume looks like in a stock that was recently a takeover rumor, perhaps a month or so before expiration. At the time of the initial rumor, traders buy call options. However, if the rumor dies down, they continue to hold many of these calls all the way to expiration, hoping for the best. At expiration, they will sell these calls to recoup what they can. Then, if the rumor is still alive, they will buy calls in the next expiration month. So, as an observer of these option activities, if you see that all of the volume in a recent rumor stock is concentrated in the expiring options, then you can assume that the rumor is “dead.” However, if you see approximately equal volume in the expiring options and the options of the next month, then you can assume that the rumor is still alive. Knowing this, you can continue to monitor the stock for signs of a breakout.

So, now that we have spent a great deal of time describing what to screen out, we will show you what a real takeover- (or rumor-) inspired option volume pattern looks like. This is one that we spotted for the customers of our daily service.

On July 26, 1995, Southern Pacific Railroad (RSP) suddenly spurted a point higher, from 19 to 20, in one day. Option volume was heavy. Nearly 2,600 contracts traded that day—almost all of which were calls—as opposed to an average volume of less than 900 contracts daily. August expiration was more than three weeks away, so there was plenty of trading in the August options. The call option volume looked like this:

**RSP: 20; July 26**

Strike Price	Expiration		
	Aug	Sep	Nov
12½ calls			30
15 calls	25	50	
17½ calls	220	88	
20 calls	1,100	580	120

Only a few puts had traded: 140 of the Aug 17½ puts and 230 of the Nov 230 puts.

The strike price of 20 was the highest strike price available. Note the preponderance of call volume at that strike. That is good. Also, note how the August calls are the most active at the two highest strikes; that is also good. In addition, the put volume doesn't seem to indicate that much, if any, arbitrage was going on, since there is very little matching of call volume and put volume in the same series. Finally, there doesn't really seem to be much, if any, spread activity either; even if all of the in-the-money calls were related to spreads against the calls with a striking price of 20 (and they most assuredly are not *all* in that category), that would still leave a lot of speculative activity in both the Aug 20 and Sep 20 calls. In fact, it is more logical to assume that the Nov 20 calls and many of the in-the-money calls were bought by market makers as a hedge against the Aug 20 and Sep 20 calls they were selling to the public.

All in all, this is a "classic" volume pattern, and it was justified. Option volume remained high as the stock oscillated back and forth around 20 for the next five days. Then, on the sixth day, the stock received a takeover bid from Union Pacific Railroad.

---

## **Analysis in Real Time**

You have surely noticed that all of analyses are based on closing option volume and closing prices. Most of the time, this is sufficient, because option volume will generally begin to significantly increase at least two days or more in advance of a major corporate news announcement. In fact, I am often suspicious of option volume that "springs up" only on the day before an expected announcement, such as an earnings report. However, there have been cases where option volume is related to a takeover that occurs the next day. Thus, waiting for the market to close before doing the analysis may cost you some profit opportunities.

---

On December 16, 1994, Caesar's World options traded nearly 2,500 contracts, and the stock jumped two points. Average option volume was just over 400 contracts, so this increase was significant. The stock had previously been rather dull, trading in a range between 40 and 46, and option volume had been quite low for some time. However, the next day, before

the market opened, Caesar's received a takeover bid from ITT Corporation and subsequently opened 20 points higher!

Another significant and similar situation occurred on June 2, 1995. That was a Friday, and Lotus Corporation rallied  $3\frac{1}{2}$  points to  $32\frac{1}{2}$  on option volume of nearly 8,200 contracts. Average daily option volume was 2,500 contracts. Lotus *had* been trading down previous to that day, as it had reported bad earnings a few weeks earlier, and the stock was under selling pressure. Monday morning, before the market opened, IBM announced a \$65 a share takeover, and Lotus opened up 29 points at  $61\frac{1}{2}$ !

---

Those observers of option volume who only use closing prices were unable to capitalize on these situations because, even though option volume on the day in question had a significantly speculative look, the takeover bids were received before trading began the next day. Although there are only a few of these situations each year, they can be lucrative to spot if you have the wherewithal to do so.

In order to trade these latter situations, you must do your option volume analysis in real time, *during* the trading day. Then, if your analysis reveals a truly speculative situation, you can buy stock or options during the same trading day. Some small adjustments need to be made to the volume screens when analyzing option volume in real time, during the trading day. The amount by which total volume exceeds average volume should be lessened, depending on the time of day at which you are running the analysis. For example, if you are running the analysis at noon, you might want to see all situations in which the total daily volume is equal to or greater than average volume (rather than *double* average volume, which is what we look for at the close of trading).

Experience has shown that running a real-time analysis about an hour or an hour and a half before the close of trading is appropriate. This gives you enough time to do analysis and still be able to take a position if you feel one is warranted. The main problem with real-time analysis is that it can lead to buying overhyped late-day situations, especially on a Friday, when rumors are swirling very fast. Therefore, my advice is to be rather stringent on your criteria for taking on a position based on real-time analysis. Remember, *most* rumors don't turn into takeovers the next day, so you'll normally have plenty of time to take a position.



### Examples

Now that we have gone over the methodology for selecting some of these stocks, let's look at some actual examples. The following ones are all taken from actual trading situations that we identified for customers of our daily fax service in 1994 or 1995.

The Southern Pacific Railroad example, whose option data were just shown, is a good place to start. Review the data printed in the table on page 199, showing the option volume on July 26, 1995. Figure 4.1 is a price chart of Southern Pacific at that time. Along the bottom of the graph, option volume is shown. The option volume line looks very "choppy" because on many days, Southern Pacific options were not trading at all.

**Figure 4.1**  
**SOUTHERN PACIFIC RAILROAD**

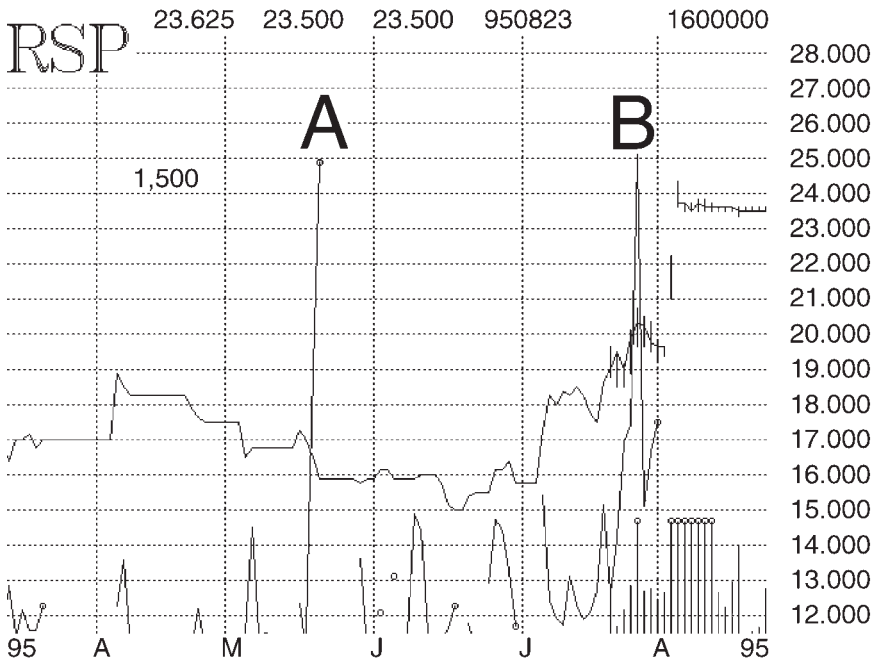

This graph of option volume only tells us the *total* volume, of course, and does not give us information on the detailed breakdown, which is necessary for the various screening activities that we have described so far in this chapter. Look at the graph of option volume in May 1995. Note the large volume spike (point A). That apparently was unrelated to speculative activity, as the stock not only traded sideways after that, but there was no option volume at all for the next several days. Now, look at the option volume on the graph in late July 1995 (point B). This time the volume spike *was* speculative in nature, with the actual peak coming on July 27, 1995 (one day after the volume that we first noticed in the preceding example). Not only that, but volume remained heavy for several successive days.

The stock traded between 19 and 20 for several days while this heavy option volume was occurring. Then, on August 3, 1995, Union Pacific made its takeover bid, and the stock jumped to 24 the next day (the graph only shows the option volume *prior* to the takeover bid; there is always plenty of option volume on the day after the corporate news is announced). Thus, this Southern Pacific Railroad situation was a classic example of using option volume to spot a takeover just before it was announced. There was a good speculative look to the option volume for a full week before the actual announcement, so traders had plenty of time to get into the stock.

One of the most profitable takeovers of 1994 was the bid for American Cyanamid (ACY) made by American Home Products. This one, too, was able to be detected by observers of option volume. The graph of ACY during the pertinent period is shown in Figure 4.2.

The stock was trading modestly downward with little option volume in January and February of 1994. In fact, it made a low at 43 in March, and the first burst of option volume accompanied the initial rally off of that low (point A). The latter half of March had very heavy option volume, considering that average volume was running at very low levels in those days. All option volume statistics would increase as the spring and summer of 1994 passed.

ACY traded sideways during April, and option volume once again dropped off to nearly nothing. Then, on May 1, another burst of option volume got the stock rolling to the upside. At that time, this was the heaviest option volume to date in ACY (point B). This burst

**Figure 4.2**  
**AMERICAN CYANAMID**

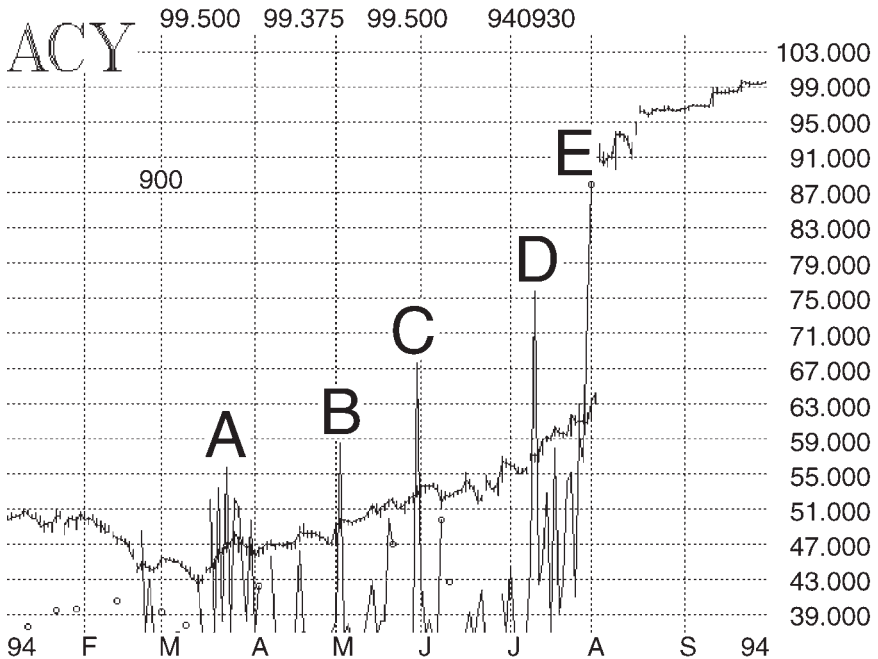

of option volume proved to be short-lived, but the stock continued higher for the month of May, climbing to 53 by month's end. Then, *another* day of heavy option trading was recorded (point C).

After this once-again short burst of option activity, the stock backed and filled a little before advancing again in late June and early July. Finally, on July 11, the stock gapped two points higher, accompanied by the heaviest option volume yet (point D). By this time, takeover rumors were circulating. You can see that the stock worked higher during the middle of July. But there was a major difference this time: while option volume backed off some from the point D peak, the option trading remained active, trading at levels about equal to where they had been at point A back in March.

By late July, the stock was trading near 60, and option volume then proceeded to reach the highest levels ever (point E). On July 29 (a Friday) and August 1 (the following Monday), the option volume

**Table 4.1**  
**ACY: 63; JULY 29**

Strike Price	Expiration			
	Aug	Sep	Oct	Jan
55 calls	100	33		
60 calls	542	315		
65 calls	1,189	369	45	29

accelerated to extreme levels. Table 4.1 shows the option trading data for July 29, but a very similar pattern occurred on August 1.

A total of 2,622 calls had traded. A total of 297 puts also traded, scattered among five different series. Average volume at the time was 697 total contracts. So option volume on this particular day was about four times the average. You can see that the “speculative” look that we have talked about existed in the distribution of the call volume: most of it was in the near-term, August, options, and most of it was in the highest strike (65).

Finally, late in the day on August 1, American Home Products made their bid. ACY was halted on the New York Stock Exchange (NYSE) at 63 and reopened at 91 in the third market. This was a successful culmination to the story for option volume observers. Since watching option volume is a short-term trading activity, these traders were probably in and out of the stock several times during the spring and summer of 1994, each time garnering small profits, until the big strike in early August.

Another 1994 takeover that was signaled by increased option trading volume was Gerber (GEB). In fact, the first signs of speculative activity in Gerber were increasing option prices, but that is a phenomenon that we discuss later in this chapter. Figure 4.3 shows the price history and option volume of Gerber during 1994.

Until early March 1994, Gerber was trading in a very tight range of 27 to 29 with no option volume on most days. Then, in March, the stock broke out to 33, accompanied by heavy call volume (point A). A couple of weeks later, the stock managed to move up to 35

**Figure 4.3**  
**GERBER—OPTION VOLUME**

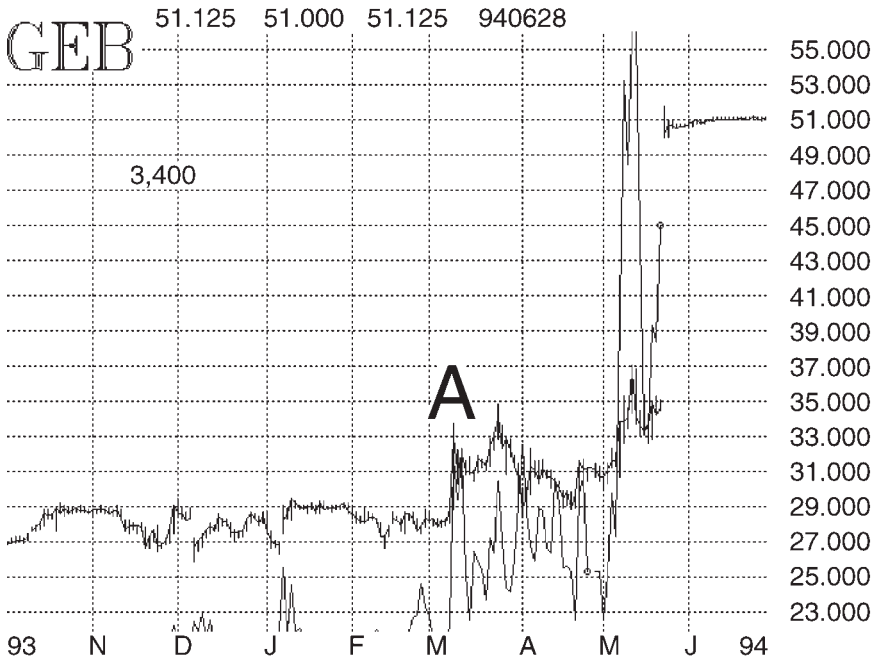

intraday, and option volume remained relatively heavy on most days. Rumors of a takeover were rampant; and when nothing happened, traders began to exit the stock. So Gerber fell all the way back to 29 by mid-April.

Then, on May 6, the stock jumped two points, from 31 to over 33, and option volume hit its highest levels ever. This was a clear-cut signal that the stock was “in play” once again. Table 4.2 shows what the option volume looked like on that day. It is another classic example of what speculative option volume looks like in advance of corporate news. Nearly 8,800 calls traded that day, and about 400 puts traded as well. At the time, average daily option volume was 2,770 contracts. This tripling of normal volume was an impressive sign that something was happening in Gerber.

**Table 4.2**  
**GEB: 33<sup>5</sup>/<sub>8</sub>; MAY 6**

Strike Price	Expiration			
	May	June	July	Oct
25 calls	78	15	40	2
30 calls	1,909	414	268	29
35 calls	4,112	1,079	584	252

The stock continued to climb higher over the next two weeks, and option volume rose to even loftier levels. The peak price was 37 and by Friday, May 20 (option expiration day for the May options), Gerber had fallen back a little to close at 34<sup>5</sup>/<sub>8</sub>. As related in a story in Chapter 1, the takeover bid was received that night. On Monday, Gerber opened at 51. Much to their chagrin, some option writers were assigned on (out-of-the-money) May 35 calls.

Chipcom (CHPM) was a stock that was on the defensive for much of 1995; but then it turned—almost on a dime—and option volume observers picked up another takeover. From Figure 4.4, you can see that option volume was moderately heavy in April 1995, when the stock was falling from 46 to 28. Then as it settled in a trading range of 32–34 in May, option volume almost disappeared. The company announced bad earnings on May 26 and fell 12 points in one day. This caused option volume to surge briefly (point A on the graph).

However, the stock began an almost immediate recovery and got back up to 26 in June, before falling back some. It closed at 26 again on Friday, July 21, and option volume surged. As shown in Table 4.3, option volume that day had a speculative look to it as well, although it wasn't as "classic" a pattern as some of the ones described earlier. A total of 2,014 calls had traded (and 562 puts traded also). This total volume of 2,576 was huge compared to the average volume of 280 total contracts per day—more than nine times the average.

This volume pattern has some slight anomalies in it. First, the heaviest volume is in the September options, even though the August

**Figure 4.4**  
**CHIPCOM**

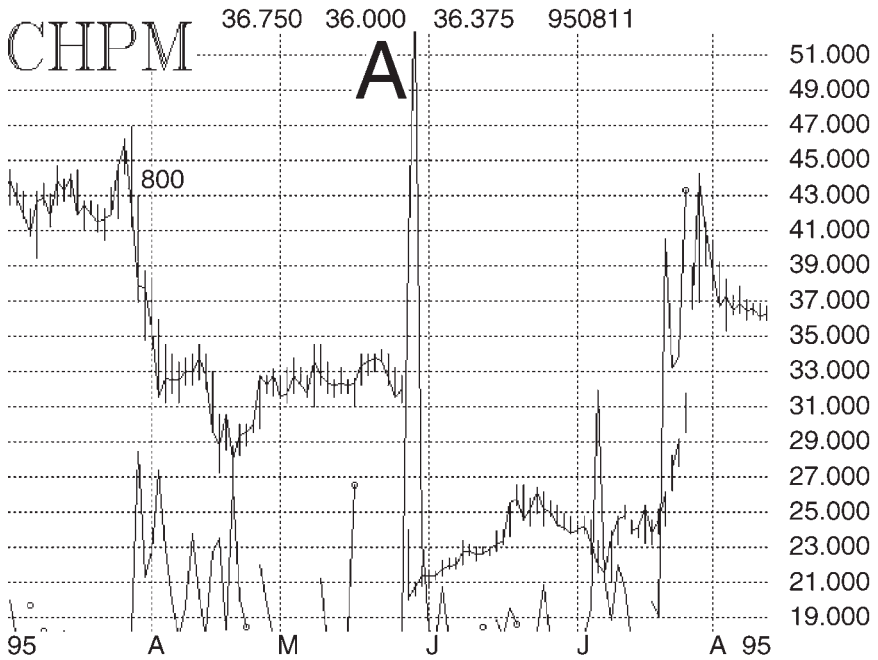

options had four weeks of life remaining at the time. Second, the majority of the volume is in the *at-the-money* strike (25) instead of the *out-of-the-money* (30). Both of these facts are slightly different from what you would hope to observe in an ideal situation. Note that there were not any August 30 calls available for trading at the exchange.

**Table 4.3**  
**CHPM: 26; JULY 21**

Strike Price	Expiration		
	Aug	Sep	Oct
22½ calls	77	31	28
25 calls	338	1,482	59
30 calls	n/a	69	66

Overall, this volume pattern was not “perfect,” but it was encouraging. Because of that, you might bring other factors in the decision making. At the time, I felt that since the stock had topped out previously at 26 back in June, I would want to see it break out over that level in July in order to confirm that the option volume pattern was a meaningful one.

The next trading day, Monday, CHPM did indeed break out over the 26 resistance, and on a small gap to boot. Option volume remained heavy, and the stock closed at 27½. This was a clear sign to buy the stock. It traded as high as 31¾ over the next three days, and option volume continued to be very heavy all during that time. Surprisingly, the volume never did develop the “classic” pattern, as more September and October options traded than did Augusts.

Nevertheless, a merger bid was received on July 27 from Three Com, and the stock jumped to 37. As an added bonus, after that there were rumors of a competing bid by Cabletron Systems; and the stock traded at 44 the next day! Although, the competing bid never developed, Chipcom rallied as the price of Three Com stock rallied. Again, a takeover situation was detected in advance by observers of option volume, although this time a little technical analysis had to be thrown in to complete the picture.

There is one other trait of the Chipcom situation that is interesting—a trait that occurs with some frequency in takeover situations: the stock, while trending down, becomes a takeover target because of its low stock price. It’s sort of a catch-22 situation. The target company is doing poorly and its earnings are bad, so the stock sells off. However, if they have a good basic business, product, and so on the low stock price itself may raise the eyebrows of cash-rich companies in its field. These cash-rich companies can then step in and buy the relatively low-priced stock for what they feel is a reasonable price. In the case of Chipcom, the stock had traded as high as 51 in late 1994 (not shown on Figure 4.4), before plunging to a low of 20 in May 1995. This vast decrease in stock price obviously attracted the attention of Three Com, who apparently saw an opportunity to buy a (mismanaged?) company at a price well below its highs of the previous year. This theme of a stock becoming a takeover target after its stock hits new lows is



repeated in several of the upcoming examples, including the next one—U.S. Shoe—to a certain extent.

U.S. Shoe (USR) had traded up to a high of 24 in the summer of 1994 before beginning an eight-month slide that took it to the 18–19 area. While this wasn't a large percentage drop, it was probably enough to help attract a buyer.

The chart of USR's stock price and option volume is in Figure 4.5. The first high-volume day for option trading saw the stock rise to  $20\frac{1}{2}$  (point A), as there were rumors that the company was going to sell its footwear business. The very next day, the company announced that those talks had broken off, and the stock plunged to 16 at one point before recovering a little to close at  $17\frac{1}{4}$ . Then, the day after that—February 21—the stock jumped two points to  $19\frac{1}{4}$  as takeover rumors surfaced. Table 4.4 shows the pattern of option

**Figure 4.5**  
**U.S. SHOE**

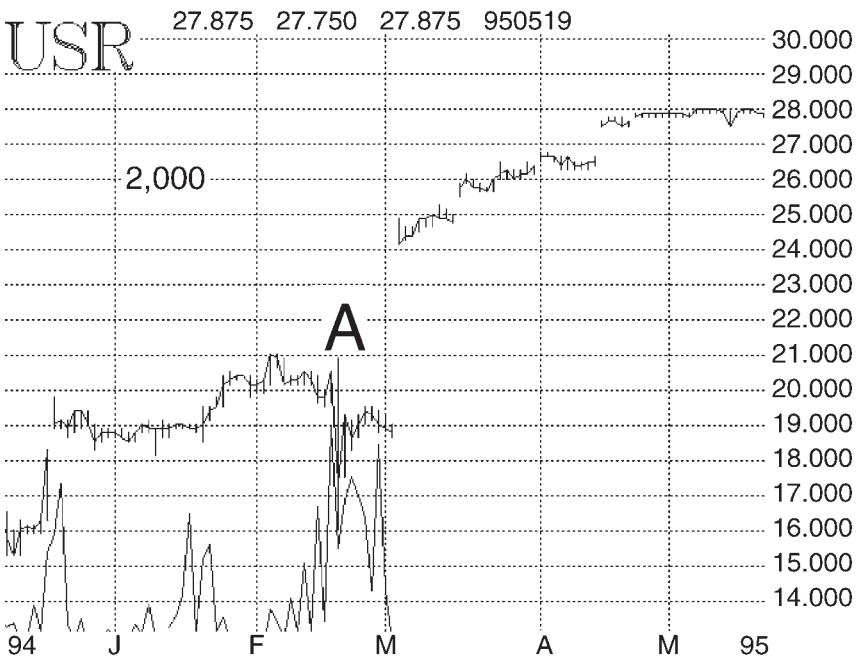

**Table 4.4**  
**USR: 19<sup>1</sup>/<sub>4</sub>; FEB 21**

Strike Price	Expiration			
	March	April	July	Oct
17 <sup>1</sup> / <sub>2</sub> calls	285	130	31	40
20 calls	654	603	105	
22 <sup>1</sup> / <sub>2</sub> calls	60	460	60	

trading on that day, February 21, when 2,428 calls had traded, plus 168 puts as well. Average volume was only 876 total contracts at that time, so that day was nearly triple the normal option volume, a wake-up call for option volume observers.

Option volume continued to run heavy during the rest of February as the stock hovered near 19. It is somewhat ironic that volume tailed off on March 1 to 970 total contracts and to a *very* low 209 contracts on March 2. The stock slumped to 18<sup>3</sup>/<sub>4</sub> as well, and it looked like the rumors had cooled off. Then, the next day—March 3—the company received a \$25 per share takeover bid, and the stock jumped six points. The takeover bid had come from an outside company, not the one that was originally discussing the sale of the footwear division.

*Ordinarily, when you are trading based on increased option volume, we recommend that you take profits as soon as the news becomes public.* You have established your position on the basis that “someone” knows something about future corporate news. If you are fortunate enough to have a position and then see that news actually announced, you should say “thank you” and take your profit, as a general rule.

However, as with all general rules, there can be exceptions, and U.S. Shoe was one of them. There is a postscript to the story of U.S. Shoe. Look at the graph in Figure 4.6. It is the same as the graph in Figure 4.5, except that the option volume is shown on through the rest of the stock’s life. There was a huge surge in option volume on the day the stock rose six points, which is certainly to be expected. However, option volume normally abates after that, especially if the

**Figure 4.6**  
**U.S. SHOE—OPTION VOLUME**

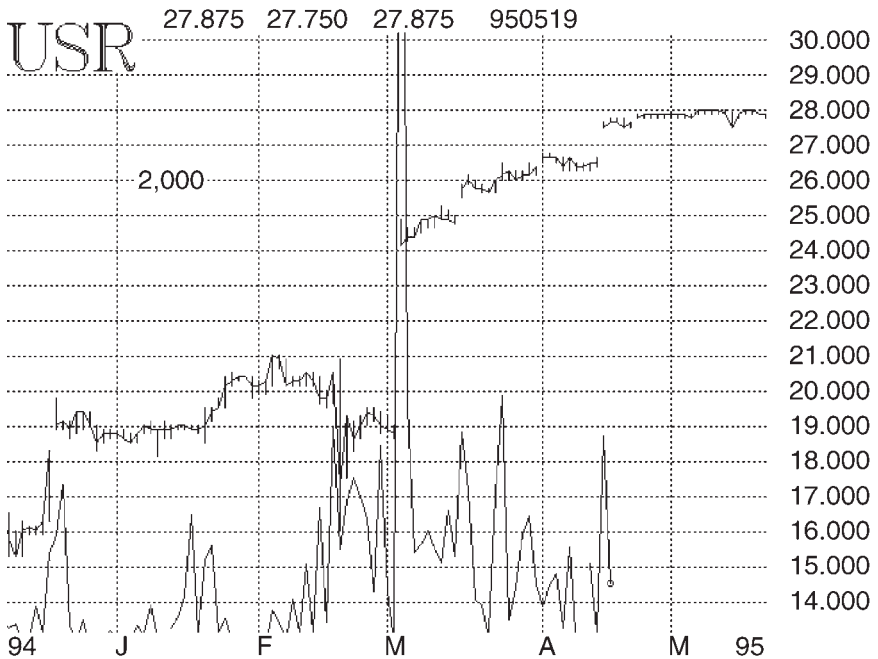

takeover bid is a “done deal.” In the case of U.S. Shoe, though, option volume continued to be heavy (it technically wasn’t more than twice normal because the heavy option volume on that one day had inflated the average volume figures). Sure enough, the company that had originally wanted the footwear division came back and bid a higher price for U.S. Shoe. You can see from the graph that the stock was eventually taken over at 28 in May, a nice premium to even the \$25 offer of March.

Option volume doesn’t just spot takeover situations. It is also very useful in catching corporate earnings surprises. It has been my experience that option trading activity will often pick up on the day before a company releases its quarterly earnings. This is such a frequent occurrence that option observers should probably *not* attempt to trade under those circumstances. However, if the option volume

picks up several days before the earnings announcement—perhaps remaining heavy for several days prior—then there is a much better chance that a meaningful trade is being predicted by the options. The next two examples are cases in point.

Motorola (MOT) was due to release earnings on Tuesday, July 12, 1994. Motorola’s options are generally quite active; but on Wednesday, July 6, and for the next four trading days, the option activity picked up tremendously. Moreover, since the majority of that activity was in call options, it appeared that insiders had knowledge that the quarterly earnings were going to be better than expected.

Figure 4.7 shows Motorola’s stock price and option volume during that time. Notice that the stock had been trading in the 43–48 range during most of May and June 1994. During that time, option volume was fairly active, but normal. However, with the stock near

**Figure 4.7**  
**MOTOROLA**

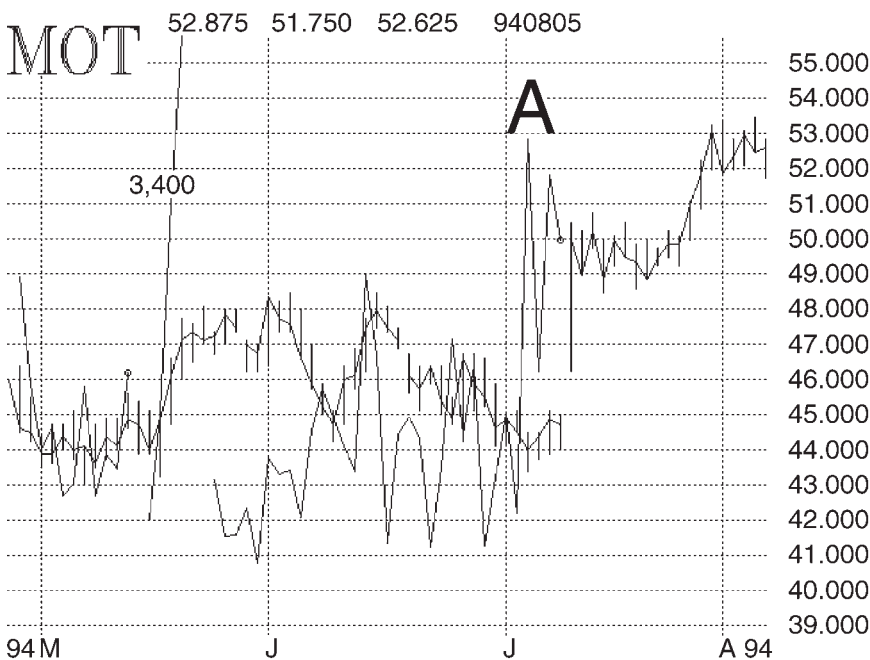

the low end of the range during the first week of July, option volume began to surge (point A). The following data are from the first day of increased option volume—July 6—and are representative of the pattern that occurred during each of those four days prior to the actual release of earnings. Since a lot of puts traded that day, as well as calls, Table 4.5 details the trading in all options. Just over 7,500 calls traded that day, and almost 5,400 puts traded as well. Average total volume at the time was 5,624 contracts, so the total volume on that day (12,900 contracts) was over twice the average volume.

The volume pattern in Table 4.5 is not as clear-cut as one might like to see; but since the options were so active, it is worth analyzing. First, you must remember that Motorola options are always active to a certain extent. So, whatever normally causes that activity was probably taking place on July 6 in the normal course of events; then, on top of that activity, there was some speculative activity as well, in advance of the earnings report. If you only look at the striking prices of 45 and higher, the pattern looks fairly speculative in terms of call volume. There are a number of puts trading at those strikes, but nothing unusual compared to the calls. So, from observing the activity at the three higher strikes, you would figure that the option vol-

**Table 4.5**  
**MOT: 44½; JULY 6**

Strike Price	Expiration			
	July	Aug	Oct	Jan
40 calls	1,980	52	30	50
puts	998	167	1,451	42
42½ calls	122	0	19	
puts	1,113		46	
45 calls	1,152	746	103	22
puts	399	220	125	49
47½ calls	1,363	504	244	
puts	322		125	
50 calls	804	299	122	
puts	0	290	31	

ume was predicting a positive earnings surprise because of the heavy call volume.

However, at the two lower strikes, things get a little cloudy. There are a lot of puts traded at those strikes, and you might think that those puts were predicting bad earnings on the horizon. The July 42½ puts, which traded 1,113 contracts, certainly look like speculative volume. However, the Oct 40 puts, which traded 1,451 contracts, probably are not speculative because speculators would be buying July or August puts. Finally, the July 40 puts (998 contracts traded) might easily be part of an arbitrage with the July 40 calls, since so many of those calls traded, too.

Sometimes, when both call volume and put volume are heavy, the stock can be ready to make a rather large move in either direction. It can be very difficult to determine that direction merely from observing the option volume, because of the balance in call volume and put volume. This phenomenon can arise, in part, because market makers are trading puts to hedge calls, or vice versa, thereby distorting the option volume patterns created by the speculators. Motorola calls were quite expensive, since the speculators were buying them heavily. So, market makers, who were short calls by virtue of their market-making activity, might have sold stock and bought some of the puts to hedge their short call position.

In Motorola data just discussed, it *appears* that the call volume has a more speculative look than the put volume because of the facts mentioned regarding the Oct 40 puts and the July 40 puts. However, rather than attempt to get too deep into analyzing *why* there was heavy option volume in specific series, I prefer to watch the stock price for a minor breakout in either direction in order to confirm the direction of the move. On July 6, the day in question, MOT had had a high of 44½ and closed at 44. The stock traded higher over the next two days, which to me was a confirmation that the pending move was going to be to the upside.

This volume pattern continued pretty much the same way for the ensuing three days. Total volume was more than double normal volume; and, while call volume was dominant, there was a lot of put volume trading as well. Finally, on July 12, the earnings were released and were a huge positive surprise. The stock gapped higher on the opening and closed over five points higher that day.

All in all, this example shows several typical things. First, if you are going to use option volume to predict an earnings surprise, you want to see the option volume reach high levels for several days prior to the actual earnings announcement itself. Second, when option activity increases in a stock where options are normally quite active, then you are going to have extraneous volume clouding the issue, so you must be a little more analytical in interpreting what the option volume is predicting. Third, whenever puts and calls are both active, you can use the stock price itself as a guide to the direction of the eventual move.

Another classic example of how option volume predicted an earnings surprise occurred in the spring of 1995 in Sybase (SYBS). This one, however, came on the downside and was predicted by heavy trading in Sybase puts for a significant period of time.

The graph of Sybase and the total option volume are shown in Figure 4.8. The stock had been under a little pressure in the fall of 1994 and then made a disappointing earnings announcement in January 1995. The stock fell over six points on that day, and option volume surged (point A on the graph). That volume, however, was not predictive—it was reactive, as it came *after* the news was released.

SYBS continued to trade sideways at a lower level—42 to 46—until late February, when rumors began to circulate that the earnings were going to be bad again at the next earnings release. This caused another spike in option volume (point B), much of which was put volume. However, after a brief foray below 40 on the last trading day of February 1995, the stock climbed back into the trading range.

On March 21, option volume surged again (point C), and it had the same pattern of heavier put volume than call volume. That came with the stock at  $44\frac{1}{4}$ . From that time on, the stock basically traded down. Since that day—March 21—was the best day to buy puts, that is the day whose detailed trading is shown in Table 4.6. A total of 3,670 contracts traded that day, and 2,450 of them were puts, an unusually large percentage (67 percent). Note the volume in the deeply in-the-money puts, a very bearish sign. Average volume at the time was 1,256, so the 3,670 contracts was almost three times normal—enough to bring this situation to the attention of option observers.

**Figure 4.8**  
**SYBASE**

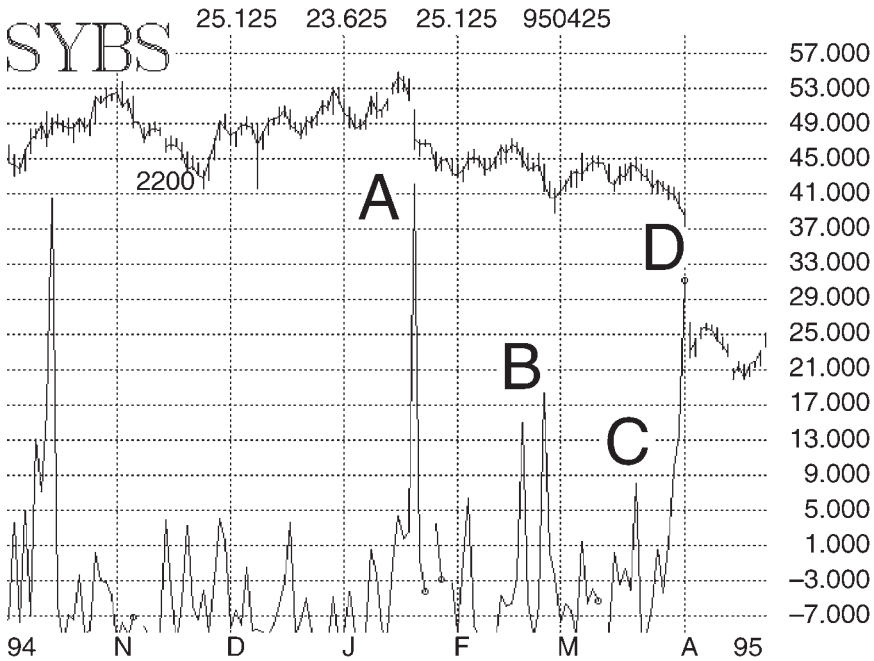

**Table 4.6**  
**SYBS: 44¼; MARCH 21**

Strike Price	Expiration		
	March	April	June
40 calls	150	0	
40 puts	0	280	
45 calls	180	270	
45 puts	420	450	
50 calls	0	620	0
50 puts	0	1,100	100
55 calls	0		
55 puts	100		



**Table 4.7**  
**SYBS: 38½; APRIL 3**

Strike Price	Expiration		
	April	May	June
35 calls	0	0	0
puts	960	750	110
40 calls	890	220	
puts	940	630	150
45 calls	410	78	
puts	200		
50 calls	0	180	
puts	280		
55 calls	0		
puts	100		

From that day on, Sybase traded lower, eventually breaking below 40 on April 3. There was heavy option volume on both Friday, March 31, and Monday, April 3 (point D in Figure 4.8). On March 31, 3,638 contracts traded, of which 1,830 (or 50 percent) were puts. That wasn't quite as impressive as the option volume shown in Table 4.6, but the trading on April 3 left little doubt as to what the option volume was attempting to say (see Table 4.7). Option volume jumped to nearly 5,800 contracts on this day, and puts accounted for a staggering 4,120 contracts (71 percent of total volume). Look at the huge volume in the out-of-the-money puts with a striking price of 35. This was a sign that the bearish speculators were out in force and with confidence.

The next day, April 4, the company made a preearnings announcement, indicating that earnings (which were not to be released until later in April) would fall short of expectations. The stock opened 14 points lower. A masterful coup for observers of option volume.

The next example is one that is less clear-cut than some of those previously shown. It involves Syntex (SYN), which was a long-

rumored takeover stock. Unfortunately for most of the people who had bought Syntex over the years, the takeover never actually materialized; and, in fact, the stock kept drifting down to lower and lower levels. As was mentioned earlier, if a company has a viable business, a low stock price may attract suitors. This fact is not lost on the Wall Street crowd, however, so the least little hint of a rumor was all it would take to get Syntex stock and options excited. We discuss this example in some detail in order to show you that things don't always work out as planned.

The graph of Syntex and its option volume is shown in Figure 4.9. The time frame is late 1993 and the first third of 1994. Syntex stock had been as high as 54 in the past (1991) but by late 1993 was trending down toward 15. In mid-December 1993, option volume surged a little and the stock made a bottom, rallying to 17 by year-end. The big volume came on the first trading day of 1994, however

**Figure 4.9**  
**SYNTEX**

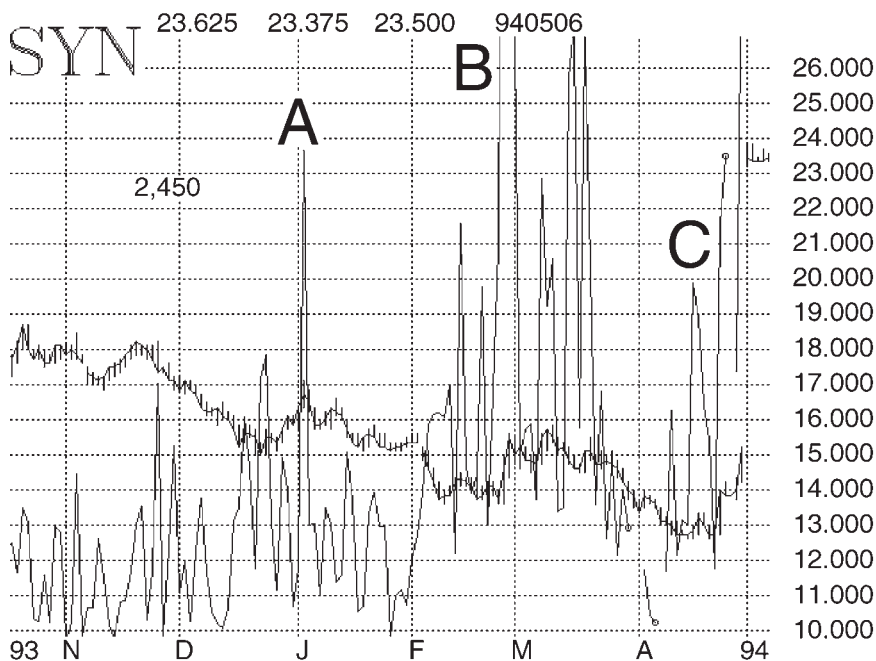

**Table 4.8**  
**SYN: 16<sup>7</sup>/<sub>8</sub>; JANUARY 4**

Strike Price	Expiration			
	Jan	Feb	March	June
15 calls	350	544	214	185
17 <sup>1</sup> / <sub>2</sub> calls	2,924	529	993	83
20 calls	302		1,229	579

(point A on the graph). On that day, January 4, the option trading volume was as shown in Table 4.8.

Call option volume surged to 7,931 contracts that day, and 479 scattered puts traded as well. Since average volume was only 2,377 at the time, this was indeed a significant surge of option trading. Moreover, it had a very speculative look, although it might have been preferable if more trading had occurred in the January and February series and a little less in the March series.

As good as the option volume looked on January 4, it proved to be a one-day wonder and—worse yet—it marked an intermediate-term top for the stock, exactly the opposite of what is “supposed” to happen. Instead, the stock fell to 14 by early February, and option volume died down substantially.

The stock stabilized in mid-to-late February, and option volume began to surge once again. This time, however, traders were more reluctant to chase the stock; and it didn’t advance much until late February, when option volume surged so much that it went clear off the top of the graph in Figure 4.9 (point B). Somewhat ironically, the stock only rose by <sup>5</sup>/<sub>8</sub> to 14<sup>5</sup>/<sub>8</sub>, again demonstrating the skepticism with which stock traders viewed Syntex. However, those with inside information were becoming even more aggressive in buying the calls. Table 4.9 shows how the option volume looked on that day of heaviest volume, February 25. Call volume was a massive 12,851 contracts, and an additional 6,500 puts traded as well. At the time, average daily volume was 3,383, so once again this was an opportunity for followers of option volume to buy the stock.

**Table 4.9**  
**SYN: 14<sup>5</sup>/<sub>8</sub>; FEBRUARY 25**

Strike Price	Expiration			
	March	April	June	Sep
12 <sup>1</sup> / <sub>2</sub> calls	514	33	265	188
15 calls	8,081	1,154	3,964	379
17 <sup>1</sup> / <sub>2</sub> calls	1,168	177	2,744	253
20 calls	172		535	
22 <sup>1</sup> / <sub>2</sub> calls	30		414	

Option volume remained very heavy for the rest of February and the first half of March (see Figure 4.9). Unfortunately, the stock did not make much headway. It *did* trade up to nearly 16, but that was in early March. Then, once again, it began another rather nasty descent, eventually falling to 12<sup>1</sup>/<sub>2</sub> in mid-April. With the decline in the stock price, option volume had almost completely dried up by mid-April. At that time, however, option volume once again returned (point C in Figure 4.9). As had happened in February, the stock price did not really trade higher—again showing the skepticism amongst traders.

Then, in late April (April 23), both the stock and the options got “heated” together. First, the stock jumped from 12 to 13 in one day, and simultaneously option volume rose to the highest levels since March. Then on April 29, Syntex traded over 15, and option volume once again had an extremely speculative look (see Table 4.10).

**Table 4.10**  
**SYN: 15<sup>1</sup>/<sub>8</sub>; APRIL 29**

Strike Price	Expiration			
	May	June	Sep	Dec
12 <sup>1</sup> / <sub>2</sub> calls	56	85	71	
15 calls	2,453	3,922	693	34
17 <sup>1</sup> / <sub>2</sub> calls	436	3,596	370	32
20 calls	24	741	164	

Nearly 13,000 calls had traded; and even though over 3,000 puts traded (most of them with a strike of 10), this was a sign that the rumors were back in force.

Those traders who weren't gun-shy from having traded Syntex before were able to buy it and reap the rewards—which were huge in percentage terms—as the stock received a takeover bid and opened at 23½ the next day. In the minds of many traders, Syntex was a “good riddance” type of stock. This was true for short-term traders, who had been “burned” by many false takeover rumors in the past, as well as for long-term holders, who saw the stock taken over at a price that was less than 90 percent of the daily closes over the previous several years. Only the observers of option volume felt somewhat redeemed, and even they had lost money a couple of times before the final takeover occurred.

This example not only shows that surges in option volume are not guarantees that a takeover or earnings surprise will happen every time, but it also stresses the need for money management. Since these are short-term trading situations, I strongly recommend that you use a tight stop on any purchase made using option volume as the catalyst for establishing the position. In my mind, that means *taking a loss of no greater than one point on any position* (unless, of course, the stock gaps open). Thus, if you had bought the stock in early January at 16⅞, you would have been stopped out within two days. Then, in late February, you would once again have been stopped out in late March or early April (although most short-term traders wouldn't hold a stock for a month if it wasn't going higher). Even though these were both losing trades, losses would have been small. That is an important fact, for you need to have your capital fairly intact because the next opportunity—in late April—was the real thing. So, if you had limited your losses on the first two trades, you would have wound up with a nice overall profit on the third trade, which resulted in a big gain.

As an end to these examples, it should be pointed out that *not every major corporate news event is leaked beforehand*. It is fairly common to see a takeover occur that had little or no advance notice. Mostly these unknown takeovers are in smaller stocks, but occasionally they occur in very large stocks as well. One large takeover that

was kept quiet was Matsushita's takeover of MCA/United Artists in the early 1990s. MCA was in the midst of a very nasty decline in connection with the bear market of that year; it traded down to 34, from a high of 71 earlier in the year. Suddenly, and without warning, Matsushita made a bid for \$71 for the company, and it gapped up to \$60 the next day.

In a similar manner, one of the biggest mergers of all time, in terms of dollar amount of stock purchased, was kept quiet; and it was never rumored—even by analysts—because the combination didn't seem possible. That was Disney's takeover of Cap Cities ABC in the summer of 1995. Cap Cities had been trading quietly at 96 on a slow Friday in July. The total option volume in Cap Cities that day was 100 contracts, as compared to an average volume of 272—nothing unusual at all there. Moreover, Cap Cities had been in a downtrend with low stock volume. Disney made an astounding bid of \$65 per share *plus* one share of Disney. Since Disney was trading at about 65 at the time, this equated to a \$130 bid for Cap Cities.

This just goes to show that a takeover can be kept quiet, but it usually isn't if too many people know about it. In the Disney situation, the deal was originally proposed personally by the chairman of Disney to the chairman of Cap Cities. Then they brought in a few trusted confidantes to hammer out the details. However, as soon as you start involving investment bankers, printers, and the like, the chances of someone "spilling the beans" increases greatly. Once the information is in the hands of disinterested parties, those parties are probably going to buy options; and that's where we can profit.

## **Profitability**

The preceding examples are certainly enough to demonstrate the worth of trading stocks based on increasing option volume. Large profits are possible; and if you limit your losses with fairly tight (mental) stops, you can expect to achieve an excellent rate of return. In order to help you gauge what to expect, some general statistics can be offered.

First, no matter how careful you are with your screening of option activity, *you are probably going to have losers on slightly*

*more than 50 percent of your trades.* Some of these are caused by picking up stock in which the option volume was due to extraneous factors rather than being caused by those with inside information. Second, with the use of tight stops, you may find that a stock backs off and stops you out, due to a large seller—who sells because of price considerations, having nothing to do with corporate news—or due to a cooling of somewhat widespread rumors. You may find yourself reentering these stocks (à la the Syntex example given earlier) if the rumors return. Personally, I prefer to take the small losses and then reenter the position if it becomes active again.

As for taking profits, or at least protecting them, there are at least three considerations. First, as mentioned before, you can liquidate your position when the corporate news becomes public. Generally, this is a most pleasing task, for the announcement will make the stock move in your favor. Sometimes, however, the corporate announcement means taking a loss, and these losses can be some of the largest and most painful. For example, I have seen situations where call trading volume built up heavily for several days prior to a stock's earnings release. Then, the actual earnings, when announced, were only in-line; or perhaps the earnings were good but projections for the next quarter's sales didn't look so good; or something similarly negative was stated by the company along with the earnings release. In a sensitive market, such a stock can gap down, perhaps opening below your stop price, thereby causing a loss.

Second, you can use a trailing stop. If the stock begins to move in your favor, but no actual corporate announcement is forthcoming, then I would suggest that you raise your stop price. As these unrealized profits begin to accrue, you may want to give the stock a little more breathing room by setting the (mental) stop price somewhat *more* than a point below the stock's price. You would approach the profits in this manner because the objective of (short-term) trading is to let profits run.

In fact, I use a trailing stop as a *mental closing stop* in nearly all of my trading. You can use something simple, such as the 20-day simple moving average; or you can use more advanced stops—ones that “hug” the stock price more closely in the case of a strong, even parabolic move in your favor—such as a chandelier stop or a parabolic stop. The old Wall Street adage, promoted by the media, is that it's

hard to cut your losses and let your profits run. But it really isn't. If you set a reasonable stop to begin with and have the discipline to adhere to it, you will cut your losses. In addition, if you use a *trailing stop*, you will let your profits run. In this way, you can be a smart trader.

Note: by using a mental closing stop, you don't actually place a stop order on the trading floor. Rather, you check the market near the close of trading and, if the stock is below the stop price (when you're long), then sell out your stock or your long calls. If you are busy and don't get a chance to look at the stock price before the market closes, then sell out your position the next morning if the closing stop was violated. Finally, notice that these stops are based on the closing *stock* price, not the option price. I think this is the most efficient way to operate, as stop orders on options can be difficult. These concepts are expanded in the later section in this chapter: Using Stops.

Third, I would recommend taking partial profits if you get a substantial, quick move in your favor and no corporate news has been announced. This tactic allows you more freedom to hold the remainder of your position with a slightly wider stop. It also ensures that an unforeseen news development won't be as painful as it might have been.

---

A classic example of the usefulness of money management occurred in the trading of U.S. Surgical in July 1995. The stock had, at times in the past, been the subject of takeover rumors, and heavy option volume occasionally developed. This time, the stock was trading at about  $24\frac{1}{2}$  when the option volume shot up, and option observers bought the stock in that price range. Two days later, better-than-expected earnings were reported, and a major brokerage firm upgraded the stock on projected improved earnings. The stock traded above 27 in just three days. At the time, we recommended to our clients that they take partial profits and raise the stop to  $25\frac{1}{2}$  from its initial level of  $23\frac{3}{8}$ .

The very next day, after opening near 27, the *same* analyst recanted his positive expectations. It doesn't really even matter what his reasoning was (although it certainly seemed specious), but the stock proceeded to fall over two points that day, stopping us out of the position. Fortunately, with the use of the trailing stop and the fact that we took a partial profit, we still had nearly a two-point gain in a very short period of time.

---



This tactic of taking some partial profits can even be applied to intraday trading, as sometimes you will already be in a position when rumors come into the market and make the stock go to extreme levels. At extremes, natural sellers may appear, based merely on price (or buyers, if you are short). For example, Integrated Silicon stock was mentioned in an earlier example as having had heavy put volume. We had our customers short the stock, and it proceeded to fall seven points in three days. Then on the third day, it was down another six points before rallying nearly four points near the close. Natural buyers had appeared; they figured the stock had gotten so cheap that it was a buy regardless of what kind of bad news was coming out. The next day, the stock rallied five points. Those traders able to watch the stock in real time were able to react when they saw it reverse direction as buyers stepped in. Covering at that time was superior to waiting until the closing or until a buy stop was later elected.

### **Further Considerations**

You can readily see that this analysis of option volume requires you to have access to “average option volume.” We use the 20-day moving average of volume in our calculations. We also keep the 20-day moving average of both puts and calls separately. There are very few software systems that provide this information; and none of them do the screening that is necessary, for that is largely a human function. One software vendor that provides this information is Option Vue; and through their Opscan service, you can customize your analysis significantly, but you may still be left with a large number of choices. On an average day, there will be 40 or more stocks whose option volume is more than double its average volume. However, after screening, only a handful are actually showing speculative option buying—the others are distorted by covered writes, spreads, and arbitrage. This means that the best, and only, way to accurately screen the volume is for a trader who understands what he is looking for to analyze the data. With practice, this can be you, if you have access to the data. Another way is through our Daily Volume Alert service, where we do the screening and report

the few situations that represent true speculative volume each day to our subscribers.

I am often asked the question, “Do you personally buy the stock or buy the options, and, if options, which ones?” A lot of the time, the options in these rumor stocks are quite expensive because not only are the insiders buying them, but other traders and market makers are buying them as well. This makes the at-the-money and out-of-the-money options too expensive to buy in most cases. *I typically prefer buying the short-term, in-the-money option* because it has little or no time value premium and therefore behaves very much like the stock does.

While an in-the-money option doesn't have the extreme leverage capability of an out-of-the-money option, it still provides leverage; and it will generally make a profit whenever the stock makes a move in your favor, no matter how long it takes or how small the move, which cannot be said for owning out-of-the-money options. There is nothing worse than owning an expensive option out-of-the-money if a rumor that is supporting the stock is denied by the company. The stock drops, but the options absolutely collapse as implied volatility drops. Thus, you can have situations where the at-the-money option drops in price nearly as much as or more than the underlying stock does.

Even though I prefer using the in-the-money option, *I would never argue with someone who wanted to purchase the stock itself*. In a trading situation, it is often better to be in the stock than in options. Stock is more liquid, the bid-asked spread is often tighter, and you can use stop orders if you want to. I do not recommend using stop orders with options—you will invariably be disappointed with the results over the long term. Also, you will find that in a trading situation you will be taking small profits fairly often, perhaps when the stock moves a point or two in your favor. Options, of course, will move in your favor when the stock does, but the liquidity of the stock often makes it a better trading vehicle.

Is there ever any purpose in using out-of-the-money options in these speculative situations? Yes, there is. When the options are expensive, then I often use a bull spread, even an out-of-the-money bull spread.

With Federal Paperboard (FBO) at about 41 in early November 1995, option volume was very strong, so that a purchase was in order. However, the options were extremely expensive:

<u>FBO: 41</u>
Nov 40 call: 4
Nov 45 call: 2
Nov 50 call: 1

These options had only a couple of weeks of life remaining, so you can see how heavy the speculation was. I recommended that our customers purchase the Nov 45–Nov 50 call bull spread. This cost 1 point, or perhaps  $1\frac{1}{4}$ , the next day.

Within a week, the stock was taken over, and it traded at 53. The spread was removed for  $4\frac{7}{8}$ . This is a classic case of why a bull spread is sometimes useful.

For comparison purposes, let's say the spread was sold for 5, and any of the other options could have been sold at parity with the stock at 53. The following table compares the various returns that would have been available from various purchases:

Purchase	Cost	Sale Price	Return (%)
Bull Spread	1	5	400
Nov 40 call	4	13	225
Nov 45 call	2	8	300
Nov 50 call	1	3	200
Common stock	41	53	29

Thus, the spread was the best choice by far, in terms of returns realized. The reason that it was able to outperform the other calls was that each individual call was so expensive to begin with that it hampered the overall returns. However, at least in the bull spread situation, we were both buying and selling an expensive option; and that balanced itself out somewhat. Of course, had the takeover been at a much higher price, the spread would not have been the best winner; but it would still have done very well, and its initial cost was small—only one point.

## Using Stops

It was mentioned earlier that you should use protective stops, and fairly close ones at that, when operating a short-term trading strategy. This concept pertains not only to stock trading (whether based on option volume or any other criteria), but to futures trading as well. With the use of stops (and letting your profits run), you can operate very profitably even if you only have 40 percent to 50 percent winners. You should also favor the use of trailing stops—adjusting your stops to lock in profits if you are fortunate enough to have the stock make a move in your favor. You don't necessarily have to keep the trailing stops as tight as the initial stop; you may want to leave the stock a little more room if it is already moving in your favor.

A concept that I usually recommend if you have access to real-time data or if someone is watching your account for you is to use *mental* stops instead of actual stops. An actual stop is a stop order that is actually placed with your broker and is therefore an order on the floor of the exchange. The advantage of the actual stop is that you don't have to monitor it—it's always working for you even when you're away doing something else. The *disadvantage* of the actual stop is that you don't get a chance to assess the situation when the stock gets to your stop price; you are automatically out. Moreover, you might not get a particularly good execution; and even though this sounds a little paranoid, it does happen; sometimes the specialists or market makers will drive the stock down only to "pick off" your stop and then the stock will go right back up again.

The *mental* stop allows you some flexibility when the stock hits your stop price. The way a mental stop is normally implemented is to set a limit minder on your quote machine at the price in question. Then, when the stock hits that price, your quote machine will "beep" or otherwise signal you that a limit has been reached. You can then look at the stock and perhaps watch its trading activity for a few minutes to see if this is actually a time to sell the stock. For example, if the stock hits your mental stop price, but you see that there is a large bid for the stock and that the selling has been rather light, you may decide that this would not be a good time to sell the stock, and you would continue to hold it. On the other hand, if you see that the sell-

ing has been aggressive and that bids are small in size, you would probably decide to go ahead and sell, as it seems that the stock might drop even farther. The mental stop allows you this flexibility. It may sometimes cost you an extra eighth of a point versus the actual stop, but it will save you in those situations where it is fairly obvious that the stock is going to lift right back up. Of course, the mental stop can only be used if you are present when the stock reaches your stop price. If you have another job or are often away from a quote machine, then you must use actual stops.

Another type of mental stop that I have found useful is the *closing stop*: I won't stop myself out unless the stock is actually closing below my sell stop price (or above my *buy* stop price). This is an order that can be placed as an actual stop in the futures market, but not in the stock market ("Stop, close only"). I have found that, especially with rumor stocks and other short-term situations, the stock may trade down through what appears to be minor support, intraday, but then bounces back above it by the close of trading. If you were using an intraday stop, you would have stopped yourself out. However, with the closing stop, you retain your position. It's relatively easy to monitor, even if you don't have access to a quote machine; merely call your broker just before the close of trading, and if the stock appears that it's going to close lower than your stop price, sell the stock. The drawback, of course, occurs when the stock not only violates your stop level, intraday, but continues on down and closes *much* lower. That is why you may want to pay attention in real time if you are using this type of stop because you may want to liquidate your position *before* the close if you see a nasty situation developing.

In any case, placing stops can be more of an art than a science. Some traders prefer to use money management stops; that is, they will risk only a certain amount of money on a trade and will, therefore, determine their stop price based on a dollar amount of risk. This concept is discussed in Chapter 7. Other traders prefer to use technical analysis to aid them in placing their stops. I think both concepts can be used together in a short-term trading methodology. In this system of using option volume to select stocks, we want to keep our initial losses small, approximately three-quarters of a point to one point. That is the money management part of the stop. Then, if

we can find a point in that range that is a technical support point, we can combine both philosophies.

For example, if there have been a couple of daily bottoms at the same price, that represents technical support. If that support is approximately at the distance where we want our stop, we would set the stop—actual or mental—at a point *below* those two daily bottoms. Figure 4.10, a chart of Bethlehem Steel (BS), illustrates this concept. If we bought BS at  $14\frac{1}{4}$  (the last bar on the chart on the right), we might set our stop at  $13\frac{3}{4}$ , based on the fact that there had been double bottoms at 14 during the previous week.

Of course, you won't always be able to find such a convenient thing as a double bottom, but you may often be able to identify a support area that, if breached, would be a rather negative occurrence. This would be your stop point.

**Figure 4.10**  
**BETHLEHEM STEEL**

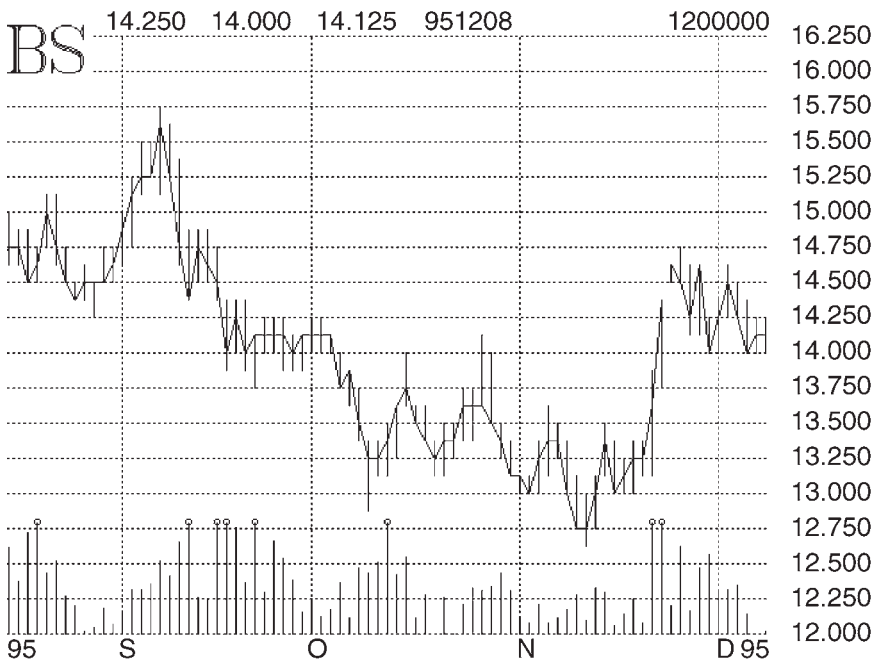

Figure 4.11 illustrates the concept. If you buy ADM at the last sale (on the right of the chart), you might feel that its price represents a nice breakout. However, if it fell back below the row of daily tops that had occurred over the preceding month at  $17\frac{1}{2}$ , the breakout would be negated. So you might place your stop at 17, which is well below the row of intraday tops.

Finally, if there is no technical support area visible, then you would just have to rely on your money management stop. The money management part of the stop-selection process is the most important and should be the first consideration. If, for example, you are going to place your stops at 1 point below your entry price because of money management, you would not override that consideration because technical support is  $2\frac{1}{2}$  points below your entry price. To use a stop of  $2\frac{1}{2}$  points below your entry price is just too

**Figure 4.11**  
**ADM, 12/27/95**



far and too much risk, if your normal money management stop is 1 point. The technical-analysis portion of the stop-selection process should only be used if it falls within the guidelines of your money management stop.

The preceding discussion was from the viewpoint of protecting a long position in a stock. Obviously, for a short position, things would be similar. A protective buy stop might be placed just *above* a couple of intraday *tops* on the bar chart. Or if the stock has broken down below a congestion area, then a buy stop might be placed just above the intraday bottoms that defined the breakdown.

Stop orders can also sometimes be used for entering a position, as can limit orders. We spent a good deal of time going over the reasons and methods for screening out option volume that was not speculative in nature. However, we also stated that you may still end up with a stock whose increased option volume was due to something other than insiders buying options in advance of corporate news. As one further type of screen, I often wait until I see the stock trade above the high price it made on the day of the heavy option volume before I actually buy the stock. The reasoning is this: if the stock can't even penetrate the previous day's high, then maybe the option volume wasn't as good as I thought it was.

If you are waiting for the stock to reach a slightly higher price (i.e., above the previous day's high), you can use a *buy stop* order to get into the stock. Just place the buy stop an eighth of a point above the previous day's high. If it is elected, you know the stock has continued on from the previous day's action, and you are in a stock with momentum. If it is not elected, you may have avoided a stock whose option volume was extraneous. You can, of course, leave the stop in place for subsequent days if you continue to like the option activity.

The chart of Grupo Tribasa (GTR), Figure 4.12, is a good example of this philosophy. Option volume first picked up when the stock was trading near 8 (point A on chart). The high that day was  $8\frac{3}{8}$ , and there had been several failures, intraday, at  $8\frac{1}{2}$  previously. Thus, even though there was good option volume, we wanted to see the stock break out to  $8\frac{5}{8}$  before actually buying it. It could not do so for nearly a month, and then there was heavy option volume again (point B). Again, it couldn't follow through on that volume the next day. But, finally, it did break out three days later.



**Figure 4.12**  
**GRUPO TRIBASA**

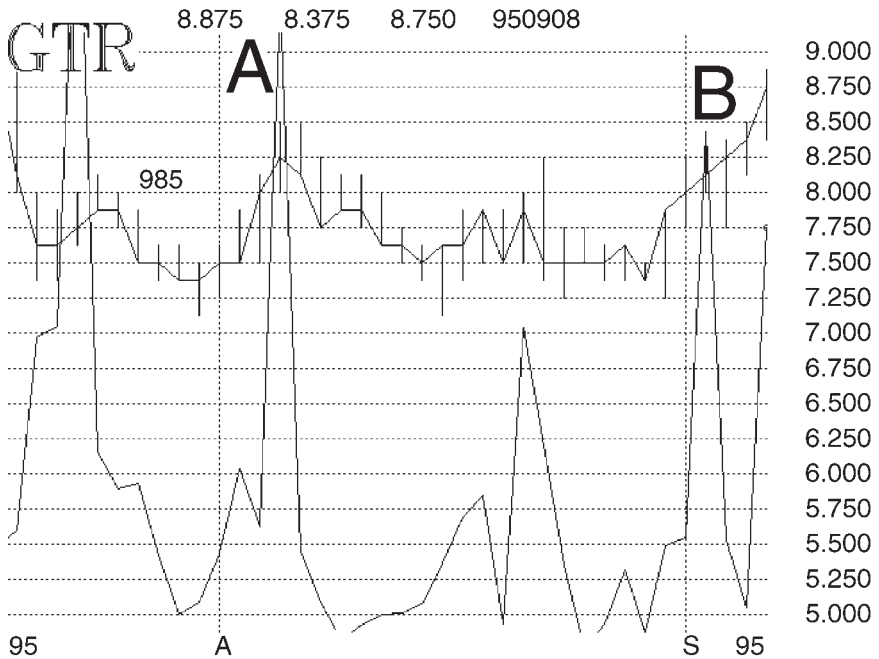

Limit orders can also be used to enter a position. Many traders don't like to "chase" stocks on breakouts, and I can agree with that philosophy, especially if you miss the actual breakout itself. In the Grupo Tribasa example, we were able to catch the breakout just as it was occurring. However, you may find that sometimes you won't have heavy option volume until the day a breakout occurs. This doesn't necessarily mean that you should avoid the stock, but you might wait for a pullback to buy it, depending on how the news reads.

Figure 4.13, the chart of U.S. Surgical (USS), illustrates this concept. In late July 1995, the stock was trading just above 23. There had been previous resistance at 24. On the day in question, USS bolted  $1\frac{1}{2}$  points higher on heavy option volume and closed at the high of the day,  $24\frac{3}{4}$ . The situation looked attractive, but not so spectacular that the stock had to be chased and bought at the daily

**Figure 4.13**  
**U.S. SURGICAL, 7/20/95**



high after its breakout. In fact, we used a limit order to buy the stock at  $24\frac{1}{4}$ , which was just over the support area. It traded down to that level a couple of times over the next few days, before embarking on a move to 28.

### **When Option Volume Is Not a Good Predictor**

Before concluding, it should be pointed out where equity option volume does *not* work as a predictor of a movement by the underlying. It seems to be able to work for almost all stocks, with the exception of gold stocks and foreign stocks. It has been my experience that heavy option volume in gold stocks is merely a reflection of speculation in the stocks themselves and not a predictor of an upcoming

corporate news item. Much the same is true of foreign stock ADRs, which have listed options trading. It seems that if someone actually had inside information on one of those stocks, he would buy the stock in the foreign market and not risk Securities and Exchange Commission (SEC) penalties by trading in the United States.

You may also be wondering if this same concept can be applied to index options or to futures options. After rather extensive research, I have concluded that option volume is *not* useful in predicting the movement of either indices or futures, as it is for stocks. At first, I thought there might be some logic involved in using option volume to predict the movement of indices, especially sector indices. For example, if a large brokerage house was doing a positive research piece on the oil stocks, then I thought the report might leak in advance and that leak would appear in the marketplace as call buying the Oil & Gas Index (symbol: \$XOI). That sort of thing has just never materialized. Either the brokerage firms are extremely secretive with their reports (unlikely), or the sector options are just too illiquid for insiders to bother with (certainly possible). Since history has shown there to be almost no correlation between index option volume and the subsequent moves in the index, we have to conclude that index option volume is not a good predictor of index movement.

As for futures options, there also seems to be no relationship between an increase in option volume and a move by the underlying futures. This seems logical in the case of futures. There can't be a takeover of corn or soybeans, for example. The only news items that materially affect commodities are government reports of supply and demand. These reports are closely guarded; and while many analysts attempt to predict what the government report will be, the actual reports are never leaked. The only time they were leaked was in the movie *Trading Places*, when Eddie Murphy and Dan Aykroyd got the best of the Duke Brothers. But in real life, it just doesn't happen. So, since there are no news events that can be obtained in advance by "insiders" in the futures markets, futures option volume cannot be used to predict the price of the underlying future in the way that equity options are used to predict stock prices.

This concludes a rather extensive section on using option volume to predict moves in stocks. This is a valid approach to short-term

trading, as can be seen by the many examples shown. Admittedly, the system isn't simple and takes some work to apply, but the rewards can be quite beneficial.

## USING OPTION PRICES AS AN INDICATOR

The actual price level of the options on a stock, index, or futures contract may sometimes also be useful in predicting the forthcoming movements of that underlying instrument. Option premiums are sometimes useful not only in identifying corporate-news-related items, much as option volume is, but also in other situations. We will look at several ways in which expensive options or cheap options are useful for predictive purposes.

Just as it was necessary to compare option *volume* to something meaningful (its 20-day moving average of volume), it is equally necessary to have a strict measure of option prices so that we can decide whether options are expensive or not. In order to judge the expensiveness or cheapness of options, we use *implied volatility*. Implied volatility was defined through examples in Chapter 1, but we will give a slightly more illustrative definition here, for those now familiar with the concept.

---

*Example:* As stated earlier, an option's price is a function of:

Stock Price  
 Strike Price  
 Time Remaining until Expiration  
 Interest Rates  
 Volatility

(We'll omit dividends for now.) Now suppose IBM is trading at 99, and we are attempting to determine the implied volatility of an IBM Oct 100 call, trading at 7.

Of the factors that compose the option's price, four of them are known and fixed: we know the stock price (99), the strike price (100), the time remaining until expiration (however long it is until the third Friday in October), and the short-term interest rate. What we don't know is volatility.

But we *do* know that the Oct 100 call is trading at 7. So, what volatility would we have to plug into a mathematical option pricing model, given the values of the other four factors, to make the model say that the call was worth 7? Whatever volatility that is, is the *implied volatility*.

---

Each separate option on the same underlying security will have somewhat different implied volatilities. Therefore, you need to average them in some manner in order to arrive at a single daily number for implied volatility for the stock, index, or futures contract in question. I prefer to weight the individual implied volatilities by both their trading volume and the distance between the current strike price and the option's striking price. More heavily traded options get the most weight, and options that are either at-the-money or close to it get the most weight.

Finally, once the daily implied volatility is determined, it may oscillate rather crazily from day to day; so I prefer to use a moving average of implied volatilities in order to smooth things out. A 10- or 20-day moving average seems to work best. If you use too "long" a moving average, then you may be including too much extraneous, "old" data in your moving average of implied volatility. We want to be able to spot sudden changes in implied volatility, but we want those changes to be meaningful. It is rather common for implied volatility to change by quite a bit over 50 days, but not so common for it to change significantly over 10 or 20 days' time.

## **Expensive Stock Options May Predict Corporate News**

Just as heavy option volume can be a predictor of corporate news items, so can expensive options, but only in certain specific situations. In fact, you may often find that option volume and implied volatility are increasing *together* in rumored takeover situations or prior to other significant corporate news releases. This phenomenon is caused once again by traders who have inside information attempting to take positions with the most leverage. When both volume and volatility are increasing, it is usually most beneficial to apply the analyses of option volume that were discussed earlier in this chapter.

However, at times, you may find the implied volatility increasing without a concomitant increase in option volume. In many cases, this can be the first warning sign that someone is attempting to trade with inside information. This situation of increased volatility *without* option volume usually occurs in illiquid options.

---

Consider this scenario in order to see why options might get expensive before they get active: aggressive traders want to buy options because they feel they have information that will make the stock move significantly. However, the options are illiquid, so the market makers only sell the traders a few options before raising the offering price. The traders then step up and buy a few more options at the higher price before the market makers once again raise their offerings. This may go on for a little while, but eventually the options will have gotten so expensive that the traders will stop chasing them higher. The traders may decide to buy stock instead, or they may just bid for the options. In any case, what has happened is that the options have gotten quite expensive, but with very little option volume actually having traded.

---

We mentioned earlier in this chapter that Gerber option volume signaled the eventual takeover in Gerber (GEB); but at that time we also mentioned that increasing option prices were the first warning sign. You may want to compare this discussion with that previous one.

Figure 4.14 shows Gerber's stock price history, and the "wiggly" line on the bottom of the chart is the *daily* implied volatility of the options (weighted in a manner as described previously).

On the bottom left of the chart, there was so little option trading in general that there is no implied volatility line shown for many of those days. In fact, Gerber options were some of the most illiquid options listed. The stock was very dull; and as a result, traders had little interest in Gerber options. For example, GEB was locked in a narrow trading range between 27 and 29 from September 1993 until March 1994, an astoundingly narrow range for seven months!

However, note that in December and January, implied volatility began to increase (point A). This was evidence that someone was trying to buy the options well in advance of the actual pickup in option volume. There wasn't really much option volume until early March, when the stock broke out of its trading range and rallied. At that

**Figure 4.14**  
**GERBER—IMPLIED VOLATILITY**

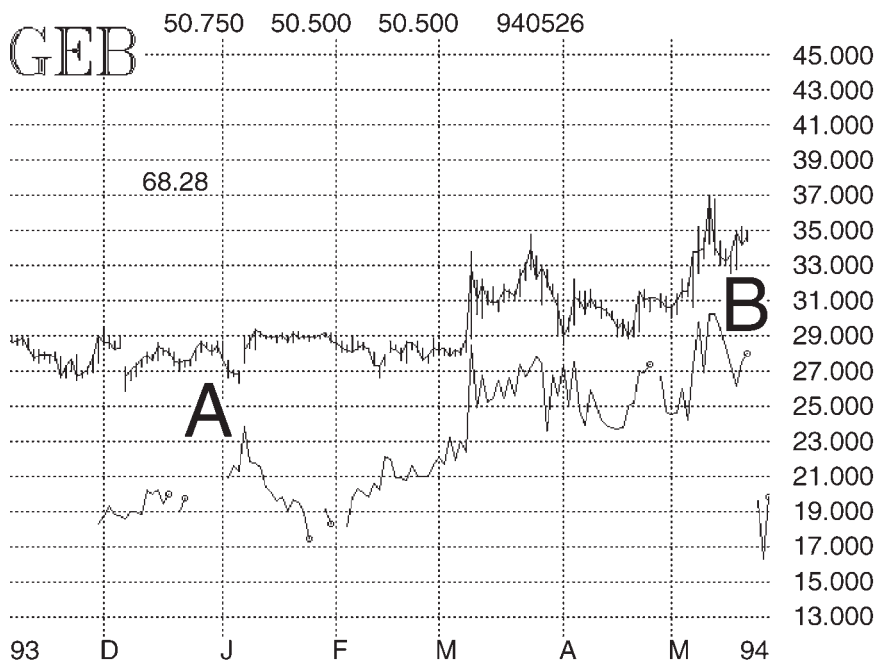

time, you can see from Figure 4.14 that *implied volatility* jumped to new highs in March as well.

For the next two months—through April and May—the stock rallied, along with heavy option volume and steadily increasing implied volatility, culminating at point B on the graph, just before the takeover. This “double combination” was an important harbinger of the takeover to come. You will notice, however, that option *volume* players never really got “notified” until the stock had already broken out to 32 or 33. Even then, the stock suffered a pullback to 29 before eventually heading higher. However, those traders who were paying attention to implied volatility could easily have bought in the 27 to 29 range back in January or February 1994.

Even casual observers of option premium levels understand that options often get expensive right before a takeover or other signifi-

cant corporate news announcement. One group of such casual observers would be covered call writers; those covered writers may sometimes have access to lists such as “the best covered writes,” which are generally the highest returns from selling covered options. Invariably, takeover and rumor stocks appear on such a list. This is not to say that you should write covered calls on rumor stocks; it’s just an observation that the calls are often expensive prior to a takeover actually occurring.

---

A friend of mine, who is a professional trader, has often said that “the only option worth buying is an overpriced one.” Now, while this is a mathematical non sequitur, it has a modicum of truth in it. Obviously, in the long run, you would hurt your statistical chances of making money if you constantly bought overpriced options. However, in certain situations—and this is what the trader was referring to—these overpriced options foretell profitable moves by the underlying stock.

---

Mathematicians will tell you that constantly overpaying for options is the road to ruin. If you constantly buy every rumor and every expensive option, you will be a loser in the long run. However, expensive options *can* be useful in helping to pinpoint potentially profitable stock movements. In fact, you might use that fact to actually buy stock rather than options.

### **Analyzing Implied Volatility for Speculative Trades**

It is difficult to quantify exactly how to decide if the options are “expensive,” but these are the guidelines that I use. First, the *daily* implied volatility—the weighted average of the implied volatilities for each of the various options for today’s trading—is what I use for the comparison. This is the most recent measure of the expensiveness of the options and is therefore the most useful implied volatility to compare against other statistics. This daily implied volatility can then be compared to various other implieds: the 20-day moving average of *implied* volatility and various moving averages of *historical* volatility.



It seems best to compare the daily implied volatility with the various historical volatilities. If there is a significant differential between them, then that is a situation that should be examined. It is less important to compare the daily implied volatility with a moving average of implied volatility, because that is less likely to highlight interesting situations, especially if the implied volatility has been creeping higher for some time. This method, by the way, is different from the analysis that we use in Chapter 6, when we want to *trade* volatility.

The three following examples illustrate some of the considerations that take place. The first two examples involve the Gerber options depicted in Figure 4.14.

---

*Example 1:* In January 1994, with Gerber near 29 on one of the early days of Gerber's increased implied volatility (point A in Figure 4.14), the various measures stood at these levels:

Daily Implied Volatility: 51 percent  
10-day historical volatility: 23%  
20-day historical volatility: 20%  
50-day historical volatility: 28%  
100-day historical volatility: 26%  
20-day implied volatility average: 28%

You can see that the implied volatility has literally exploded as compared to any of the other measures of volatility. Look at the historical volatilities. They are meandering around in the mid-20 percent range, indicating that the stock has been rather trendless. Not much has been going on. Moreover, the recent moving average of implied volatility is low, reflecting the fact that not much has been happening in the options either.

---

Obviously, this is a situation that demands some attention—perhaps not right away (because there is always the chance of a one-day fluke), but certainly if the implied volatility keeps registering at such high levels. It *did* persist (Figure 4.14), allowing the purchase of stock at low levels. (*Note:* buying the options at this point would probably not have been profitable, for it is unlikely that you would have bought options that expired in June or later. However, a stock

buyer would have been buying near the low and could have carried the position profitably all the way until the takeover.)

The next example is also of Gerber, but at a much later time: in May, right before the actual takeover occurred. Once again, implied volatility had taken a sudden jump, but from much different levels.

---

*Example 2:* By the middle of May, just a week or so before the takeover (point B in Figure 4.14), Gerber's stock had rallied to the 35 level and option implied volatility took another jump.

*Daily Implied Volatility: 84%*

---

10-day historical volatility: 67%

20-day historical volatility: 55%

50-day historical volatility: 57%

100-day historical volatility: 44%

20-day implied volatility average: 78%

All of these numbers are at vastly increased levels, when compared with Example 1. First, note that the daily implied volatility is still much higher than each of the historical volatilities.

The historical volatilities themselves tell an interesting tale, too. Note how much higher the short-term historical volatilities are as compared to the longer-term ones. This was caused by the fact that the stock broke higher, then fell, and then rallied (see Figure 4.14). The 100-day historical volatilities still contained some of the older, stodgy price movements, while the 10- and 20-day historical volatilities contained only the recent, volatile movements. Nevertheless, the daily implied volatility is still higher than any of the historical volatilities.

Finally, the daily implied volatility is not much higher than the 20-day average of implied volatility. Obviously, this means that implied volatility had been on the increase for some time.

---

What is important to recognize from this example is that the takeover occurred within a week, so we should treat the preceding data as significant. This means that a comparison of *daily* implied volatility and the *20-day average* of implied volatility need not show

a significant difference. It is more important for the various historical volatilities to differ from the daily volatility. When that happens, we have a situation that is worthy of note.

Example 2 showed how implied and historical volatilities look when a stock has just been getting hotter and hotter until a takeover occurs. The next example shows a slightly different situation: a stock *had* been the subject of a fairly hot-and-heavy takeover rumor, but the rumor then died out. Suddenly, the rumor recurred, and shortly thereafter the takeover happened.

*Example 3:* In May 1995, there was a rumor that Banksouth (BKSO) was going to be taken over. At the time, implied volatility increased, as did option volume. Moreover, the stock itself became rather volatile. However, nothing happened; and by the summer, the stock was down rather substantially from the May levels.

Then, in late August 1995, the rumors returned and implied volatility took a sudden leap. On September 1, the volatilities were as follows:

*Daily Implied Volatility: 46%*

---

10-day historical volatility: 15%

20-day historical volatility: 22%

50-day historical volatility: 26%

100-day historical volatility: 32%

20-day implied volatility average: 34%

The trend of historical volatilities in this example is just the opposite of those in the previous example. Banksouth's actual (historical) volatility was on the wane at the time of this snapshot of volatility. It had been volatile earlier in the summer; but by September 1, it was becoming a very docile stock. The only remembrance of the earlier volatility was in the longer, 50-day and 100-day historical volatilities.

Note that the 20-day moving average of implied volatility is also higher than all of the historical volatilities but is quite a bit lower than the daily implied volatility. Once again, the moving average of implied volatility does not seem to be that important.

The takeover occurred the next day; and while it was a modest one—only boosting the stock by about three points—it was still a takeover.

---

These examples show that implied volatility can be an important consideration. If it significantly exceeds the various historical volatilities, you should take a closer look at what is going on in the stock.

Here are the steps that I feel should be followed in order to identify situations such as those just described. The first two steps can be done with a computer: (1) compare the daily implied volatility with the 20-day moving average of implied volatility; if the daily is lower than the 20-day moving average, discard this stock; (2) compare the weighted daily implied volatility with the 10-, 20-, 50-, and 100-day historical volatilities. If it is at least 20 percent higher than three of those four historicals, the situation should be investigated further.

Further investigation necessitates taking a look at the individual option's implied volatilities that make up the weighted daily implied volatility for the stock. It is always possible that a "strange" occurrence has distorted the daily implied volatility, especially if you are using closing prices in your analysis. In that case, there is no speculative value to this stock and it can be culled from your list of prospects.

---

As an example of how individual options might distort the daily implied volatility, consider these data, collected in September:

XYZ: 25                      Daily weighted implied volatility: 33%

Option	Price	Volume	Implied Volatility (%)
Jan 20 call	5.75	1,800	40
Oct 25 call	0.75	300	23
Dec 25 call	1.00	100	19
Jan 25 call	1.50	100	25
Oct 27½ call	0.13	150	26
Dec 27½ call	0.38	250	23

All of the options except the Jan 20 call have implied volatilities well below the weighted daily implied volatility of 33 percent. Thus, the Jan 20 call is dominant, but you can see that it was probably a covered write that caused the volume. Speculators would not be buying a January, in-the-money call with the stock at 25 in September. Thus, you would discard XYZ

as a stock whose increased implied volatility was a potential precursor of corporate developments—at least for that day.

---

Thus, the individual option's implied volatility must be examined; and in doing so, the volume must be looked at as well. While there might not be enough volume to allow the stock to make the “high-volume” screens, there should at least be a speculative pattern to whatever volume there is. Obviously, in the preceding example, the volume did *not* have a speculative look to it. The following example depicts what we would expect to see in a typical low-volume situation with high implied volatility.

---

Equifax (EFX) is a small company whose options are not normally active—trading on average about 400 contracts per day. In addition, the 20-day moving average of implied volatility is 29 percent.

However, on a day in September, the daily weighted implied volatility shot up to 44 percent. This alerts us to look at the individual options. EFX closed at 40 on this day.

Option	Price	Volume	Implied Volatility (%)
Oct 40 call	2.000	110	42
Nov 40 call	2.875	120	44
Oct 45 call	0.750	160	50

In this case, while *volume* was small, it does have a potential speculative look to it. Moreover, each of the options is expensive when compared with the 20-day moving average of implied volatility (29 percent). So this is a stock that we would want to regard as a potential buy.

---

Before ending these examples, there is one other scenario involving increased implied volatility that occurs with some frequency. When a stock has been the subject of a rumor for some time, its options often get quite active, thereby inflating the 20-day volume average. Thus, it becomes harder and harder for the stock to appear on the high-volume list because it can't double the now-inflated volume. In a situation such as this, your only clue to the fact that the

stock may still be “hot” is high implied volatility. The following example details such a situation.

---

Interdigital Communications (IDC) is a stock that had been “hot” a couple of times in 1995. Early in the year, it had roared from 3 to 13 on the back of increasing business plus rumors that it was about to win a large lawsuit from Motorola. However, IDC eventually lost the lawsuit to Motorola, and the stock collapsed to 5. Those events caused option volume, as well as volatility, to increase a lot.

However, after being calm for a couple of months, option volume picked up again as the stock gathered momentum once more, trading up to near 9. This once again caused option volume to increase. But nothing came of that move, and the stock slowly began to settle below 8 as speculators exited the stock, looking for more action in other places.

Then, in September 1995, Interdigital options got expensive and somewhat active. However, since the average *volume* was already inflated by the previous action, the only clue for traders was the increased volatility.

IDC: 7¾ 20-day moving average of implied volatility: 60%

Average daily volume: 2,444 contracts

Daily Weighted Implied Volatility: 77%

10-day historical volatility: 36%

20-day historical volatility: 42%

50-day historical volatility: 46%

100-day historical volatility: 49%

---

Option	Price	Volume	Implied Volatility (%)
Oct 7½ call	0.81	700	76
Dec 7½ call	1.31	200	76
Mar 7½ call	1.81	200	78
Oct 10 call	0.19	500	85
Nov 10 call	0.38	200	81
Dec 10 call	0.50	200	75
Mar 10 call	1.00	200	76

---

Total volume was a healthy 2,200 contracts; but because the *average* volume was an inflated 2,444 contracts, this stock doesn't show up on the volume screens. However, the daily implied volatility is 78 percent, well

above the 20-day moving average, and well above the historicals also. Since the individual options also look speculative in nature, we would want to take a look at IDC as a trading candidate. It quickly moved two points higher.

---

Thus, implied volatility was useful in even a situation where we had relatively active options because it helped identify a potential trading candidate even though the volume screens would not.

As a final word on using implied volatility to select speculative stock trading candidates, let me stress that *volume is still important*. Without volume eventually appearing, I wouldn't get too excited about buying the stock. Thus, in the previous examples, the implied volatility is used to *identify* a potential trading situation; but I would usually want some confirmation from volume (which may not come for a few days) before taking too large a position in the stock. The reason that we want a volume confirmation is to avoid being in a stock that suffers a huge gap to the downside; for option implied volatility can be a predictor of such gaps also, as we see in the next section.

## **Implied Volatility Can Predict Trading Gaps**

When a corporate event that is going to cause a large change in a stock's valuation is on the horizon—and it may be a publicly announced event—the options will become extremely expensive in advance of the actual event occurring. One example could be the appearance of a small biotech company before the Food and Drug Administration (FDA) regarding approval of the company's only viable drug. Another might possibly be the pending culmination of a lawsuit whose outcome will cause a company's (or perhaps even two companies') stock to change in price dramatically.

What we are basically talking about here is an event that will dramatically change the fundamentals of a corporation. After the announcement of the event, the company's fortunes will have changed so much that its stock price will be drastically different. These types of events can also be forewarned of by implied volatility

increases in a stock's options. What *cannot* be foretold in these situations, however, is the *direction* in which the stock will move, only that the stock *will* move.

This can still be useful information, especially if you are already a stockholder or if you are considering making a purchase of the stock. If the options are foretelling a major price change in the stock—direction unknown—you may want to avoid the stock until the news event is released.

In these situations, we are not talking about a news event that is “leaked” in advance. In general, no one knows what these outcomes will be. Courts do not release their verdicts in advance to anyone (in fact, if it is a jury trial, no one even knows what the verdict will be until it is announced in court). Nor does the FDA leak any of its decisions in advance.

A few actual historical examples will best serve to illustrate this phenomenon. We have already alluded to a couple of these in previous chapters. One was the Intel Corporation patent-infringement lawsuit against Advanced Micro Devices (AMD).

As the date approached, in March 1994, for the court to reach a decision, the implied volatility of options in both stocks increased; but those of Advanced Micro, the smaller company, were most noticeable. Intel's normal daily implied volatility was about 30 percent; but just before the announcement of the verdict, it grew to nearly 40 percent—an increase, but not much of one, as you shall see from these examples. On the other hand, Advanced Micro's normal daily implied volatility was in the 50 to 60 percent range. But, during February and early March 1994, its implied volatility rose first to 120 percent and then to over 130 percent! Now *that's* an increase in implied volatility.

All of this increase in volatility was taking place without the stocks actually changing much in price, because no one knew which way the verdict was going to go. However, they did know that the stocks would react strongly when the verdict was eventually announced.

When the verdict was finally announced, Advanced Micro had won. The stock jumped six points higher. AMD's implied volatility immediately collapsed, dropping down to 58 percent after the verdict. Intel fell three points over a two-day period following the verdict.



Some trial outcomes are less difficult to predict. Obviously, the AMD/Intel trial was a “too close to call” situation. Large trading firms employ their own lawyers to give them guidance on how a trial might turn out, and they sometimes even send lawyers to the courtroom to observe the proceedings. If they can glean an indication of what the trial’s outcome might be, they can act before most other investors. In general, though, there is little or no clue as to the outcome. As I wrote in my daily fax report, prior to a court verdict being released, “attempting to predict these outcomes is about as difficult as predicting an election (look in your encyclopedia under Clement Attlee, Harry Truman, or George Pataki if you think elections are predictable), which is why the premiums are so high.”

Another patent suit is also a good example. It involved Interdigital Communications (IDC) and Motorola (MOT); we referred to it in the IDC example at the end of the last section.

---

As mentioned in that previous example, IDC rallied from 3 to 13 on the back of a plethora of new contracts being signed. Also, apparently, the stock was rallying partly on some investors’ expectations that it would win its patent lawsuit with Motorola.

Since IDC was a low-priced stock to begin with, its normal daily implied volatilities were very high, in the 100 percent to 110 percent range. However, as the verdict drew near, in March 1995, implied volatility in IDC began to skyrocket. It routinely registered levels of 150 percent to 170 percent at that time.

The stock was trading at 12 when the court decided in favor of Motorola. IDC opened down seven points the next day. Implied volatility followed its normal pattern then, by dropping to 85 percent. Once the news is out, implied volatility returns to a much lower level.

---

This IDC example is a good illustration of how the increase in implied volatility might have been a good warning sign for an investor. If you had bought IDC at a lower price, you were enjoying the ride from 3 to 13. During that time, the company was announcing the signing of new contracts with a great deal of frequency. If you were only interested in the fundamentals of the stock (or the technicals, for that matter), everything appeared to be quite rosy. However, if you noticed the option premium exploding, you were given

advance notice that the stock was in a high-risk mode. It might gap either up or down, but *something* was going to happen. Thus, if you didn't want to risk your accumulated profits, you could have sold, exiting in advance of the court's decision.

Hearings by regulatory bodies can be as important to the future of some stocks as the outcomes of lawsuits are to others. This is especially true of small biotech or drug companies, because not only are FDA decisions not leaked in advance, but they are often so arbitrary that no one can predict the outcome. Thus, the options of a small biotech or drug company will often expand to very expensive levels as the date nears for the FDA to release its findings. Readers are referred to the example of Gensia Pharmaceuticals in Chapter 1. The graph of Gensia and the implied volatility of the options are shown in Figure 4.15. Even though the stock was up 1 to 10 points

**Figure 4.15**  
**GENSIA PHARMACEUTICALS**

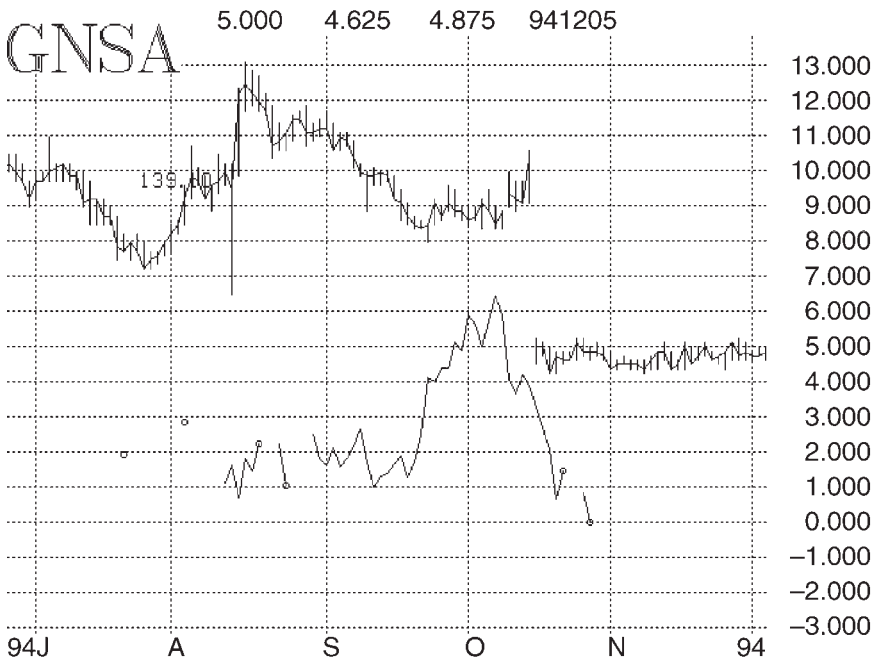

on the day before the FDA announcement, it received an unfavorable ruling and dropped 50 percent, to 5 points. Thus, it was evident that stock traders—at least those who pushed the stock up a point the day before—had no real clue as to the direction that the stock would take after the ruling. Neither did option traders, but at least the option premium was telling you as much. The following example is relevant as well.

---

United Bioscience (UBS) was a fledgling biotech company, trading at about \$7 a share in late 1994 (the stock had been nearly twice that price about a year before, but delays in getting its drug approved by the FDA had weighed upon the stock price). On a normal day, the implied volatility of UBS options was in the 50 percent to 60 percent range.

In November, when traders learned that the FDA hearing was scheduled for early December and that it could potentially decide the fate of the company, option implied volatility rose to 135 percent. By early December, it had reached an astounding 185 percent.

On December 12, the FDA declined approval for the drug, and the stock dropped to 2½. Essentially, the option's implied volatility dropped to 0 because the nearest strike price was 5, which was 100 percent above the stock price. In fact, the options were delisted when the stock didn't recover for several months. If the stock ever recovers, options will probably be relisted.

---

There can be other miscellaneous events that have similar effects on stock options. One that comes to mind occurred in 1995, and it involved Genetech and Roche, the large European drug company that owned warrants to buy all of Genetech. As those warrants neared their expiration date, the implied volatility of Genetech options doubled because if Roche did exercise their warrants, Genetech was going to jump higher in price. However, if Roche decided not to pursue Genetech, the stock could have fallen a great deal. As it turned out, a middle ground was reached when Genetech allowed Roche to extend the expiration date of the warrants for four years, in return for raising the exercise price. In any case, holders of Genetech were alerted to the potential explosiveness of the warrant expiration (something the average stockholder may not have been aware of) by the increasing volatility in the options.

Sometimes, the consequences are less severe but may be very important just the same. In the early fall of 1995, IBM had broken above 100 for the first time in years and was merrily trading up to 115 when it suddenly changed direction and began a fairly steady and rather quick decline to 103. Option implied volatility jumped dramatically (for IBM, that is) from about 30 percent to 40 percent. This was a warning sign that something more severe than a technical correction was happening. A few days later, the company indicated to analysts that sales figures (and, by inference, earnings) should be adjusted lower. The stock quickly dropped to 92 before stabilizing. The volatility and price swings in this example are smaller, but it shows that a sudden increase in implied volatility should be heeded as a possible precursor of important corporate news.

Thus, a sudden increase in implied volatility without an accompanying move by the underlying stock can be a warning sign that a price gap is about to occur. It behooves us to pay attention to the premium level of the options before entering a stock position and even after buying the stock. Whether or not you are an option trader, the options may give you fair warning of a catastrophic event on the horizon. As a stock owner, you may not notice anything unusual from watching the stock trade; but if the options are too excited, then you'd better do a little extra research to find out why.

## **Some Strategies for Trading the Volatility Gap**

In this section, we look at two strategies for trading the volatility gaps described in the previous pages. The first is what we call the *event-driven straddle buy*. The second is merely an attempt to trade the volatility as it is increasing.

The event-driven straddle buy is best used when the date of the event is known. For example, if a company is having an important hearing before the FDA, the date is known. In fact, these FDA hearings are usually quite volatile, particularly if the FDA denies the company's application, which usually causes a very large price drop—often larger than the option market was expecting. A favorable ruling

from the FDA usually causes the stock to move higher, but generally not all at once—it may several weeks. In either case, it can behoove an aggressive trader to buy a straddle on the stock right before the event.

Liposome Technology (LIPO) was trading near a price of 21 in late July 1999 when the company announced that an important FDA hearing would be held on September 16. Implied volatility immediately began to increase—rising from about 70 percent at the time of the initial announcement to about 160 percent on the day before the FDA hearing. Refer to Figure 4.16 for a graph of this information. On the graph, point A is the day of the first announcement, and point B is the day before the hearing.

As you can see, the stock rallied briefly at first; it then went into a decline and closed at almost exactly  $17\frac{1}{2}$  on the day before the FDA hearing. Since the FDA does not leak its decisions in advance, there is no way

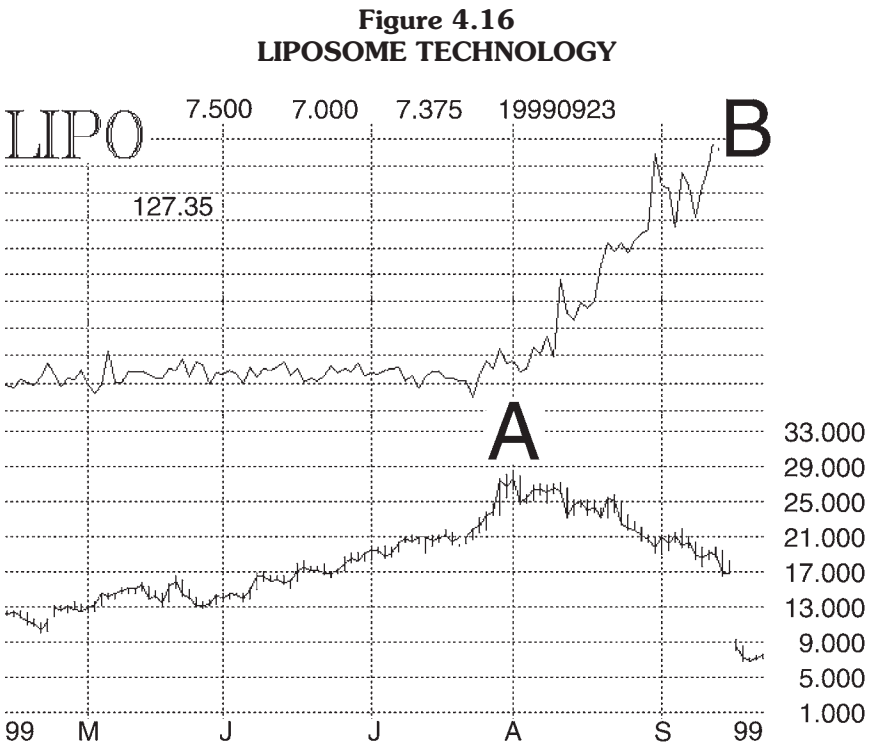

that stock traders can know for sure what the FDA will decide. So, on the day before the hearing—September 15, in this case—we buy a near-term straddle. In this case, the Sept 17.5 straddle, due to expire in just *three* days, cost 4.75. FDA hearings only last for one day, so there was no chance that we'd get stuck in this straddle while the FDA dawdled. In fact, on September 17, the decision was already out, and the answer was “no.” The stock immediately dropped about 10 points, so the straddle buy was nicely profitable.

---

Similar FDA hearings for relatively small biotech companies have produced massive moves over the years. This is a strategy that can be employed perhaps five or six times a year, although, as stated earlier, a *positive* result from the FDA panel will probably produce a loss for the straddle owner—at least initially.

We mentioned that a second strategy was possible. In looking at the graph in Figure 4.16, you might be thinking, “Why not just buy the straddle when the company first announces that it's going to be the subject of an FDA hearing?” That, too, is an acceptable strategy. Then you are owning the straddle while implied volatility increases (between points A and B on the graph). If you choose to employ *this* strategy, however, you must be certain to sell the straddle *before* the FDA makes its announcements. Otherwise, the stock could revert right back to your striking price and cause you to lose. For example, in the LIPO example, if you had originally bought the Sept 25 straddle when the stock was near point A, it would have worked well as the stock fell to 17½. However, you must sell it then, because there is a chance that the FDA could *approve* the product and the stock might trade right back up to 25—a disaster for your straddle holding.

In general, no matter which strategy you are employing, you should realize that the stock might halt for trading on the day of the FDA hearing itself. So establish your event-driven straddle buy; or if you bought straddles early on, sell them out on the day before the FDA hearing. You don't want to get caught by the trading halt.

Sometimes, it is difficult to find out *why* a stock's options are increasing in volatility. Even FDA hearing dates are sometimes buried in news minutia and are hard to find. If you are using the initial strategy, that is not a problem. In fact, studies that we have conducted have shown that if a stock's options are suddenly volatile for at least

four consecutive days, then there is a very large chance that a volatile event lies on the horizon. So, you can buy straddles then, intending to benefit from the increase in volatility until an event is clearly announced or until one occurs.

Trading volatility in this manner is quite speculative because you are buying expensive, short-term options. However, the movement in the underlying stock is often even larger than the option market was expecting, allowing you room to profit. I would *not* use this strategy with index or futures options—only stock options, for stocks are far more chaotic than indices or futures.

## **IMPLIED VOLATILITY CAN PREDICT A CHANGE OF TREND**

In the previous section, implied volatility was increasing while the underlying stock was fairly docile. In this section, we're going to see how the observance of extreme volatility levels—both high and low—might be useful in predicting the end of a trend in the price of the underlying security. In certain cases, this applies not only to stock options, but also to index and futures options.

In general, for both stocks and indices, a declining (bearish) market means increasing volatility, while a bullish market has decreasing volatility. This statement refers to both historical and implied volatility. Sometimes it helps to think in extremes to help visualize general statements like this (mathematicians call this “evaluating the boundary conditions”). In this case, the most extreme bearish case I can think of is the crash of 1987. Volatilities shot through the roof at that time. Other similar events that demonstrated this increasing volatility in down markets were the “crash” of 1989 (the day the United Arab League deal fell apart), the collapse of 1990 (when Iraq invaded Kuwait), the severe double declines in September and October 1998 (Russian debt crisis and the Long-Term Capital Hedge Fund crisis), and the final leg of the market in 2002. As for upside extremes, the bull market of 2003 is a good example: volatilities steadily decreased for the broad market indices as the market continued to push higher.

There are several factors at work in producing these volatility changes. One is that stocks tend to fall faster than they rise. Bull markets take years; bear markets may take only months. The 2000–2002 bear market lasted nearly three years, but that is one of the longest ones in memory. Even large ones like 1969–1970 and 1973–1974 only consumed a little over a year's time. Also contributing to these volatility differences is the fact that a low-priced stock can move by a larger percentage more easily than a high-priced stock can. For example, it's not unusual to see a \$5 stock move by a half point in a day; it doesn't take that much buying or selling pressure to move any stock by a half point. However, that's a 10 percent move; and you rarely see a \$100 stock move by 10 percent (10 points), or even by 5 percent for that matter. Thus, we would *expect* to see volatility increase as prices fall and likewise decrease as prices rise. Finally, since the indices are composed of stocks, they should, and do, display the same characteristics.

Futures, however, are different; and as a result it is difficult to make such a general statement regarding futures prices and volatility. Some futures and futures options behave like stocks do, but many behave in the opposite manner: volatility shrinks as prices fall and may explode if prices rise. Again, it may help to think of how commodity prices move in order to explain this phenomenon. There is an inherent demand for most commodities; and, therefore, prices cannot fall too low (in fact, some commodities, like corn, even have a government price floor under them). However, given the vagaries of droughts and floods and other similar events, commodity prices can, and often do, explode to the upside. Thus, even though commodity markets can move with equal rapidity in both directions, they often move faster to the upside than to the downside.

In reality, futures option volatilities will more often reflect the trend and how fast it is moving. Grain futures tend to fall relatively slowly, while they may rise dramatically (and many grain traders still remember the huge bull markets of 1973 and 1974; so every time prices start up, there is hope of a repeat of those bullish moves). As a result, you will find that implied volatility in grain options increases tremendously during bull moves and decreases during bearish moves. However, another commodity will most likely react differently. For example, oil has had the potential for both big increases and big



decreases over the years. So whenever a trend seems to be accelerating in oil prices, the implied volatility of oil options will increase.

Given this general background, let's examine how these observations can be used to establish positions that might be profitable.

### **Covered Call Writing When Volatility Increases**

We discussed the covered call writing strategy in Chapter 2. The conclusion was that it is best used when prices are stable or rising moderately; it is not such a great strategy in volatile markets. So what would make a covered write a great strategy would be not only stable stock prices but also expensive options that can be sold against that relatively stable stock.

We have just stated that implied volatility increases when stock prices fall. So if we could "catch" a stock right as its downtrend is ending, we would probably find that the options are about as expensive as they are going to get; and while the stock may not reverse into a bullish trend immediately, it will at least be stabilizing as it builds a bottom. If we can find this situation, the covered writing strategy would be most appropriate.

Finally, a bit of contrarian theory can be thrown into this mix as well. If a stock has been falling for some time—perhaps rapidly—eventually put buyers will panic and start paying up to ridiculous levels for those puts. This causes the implied volatility of the options to inflate. Of course, contrarians would recognize everyone's desire to own puts as a sign of a bottom in the stock (if everyone wants to own puts, it must be the wrong thing to do, since the majority is usually wrong; therefore, the stock is nearing a buy zone or at least will stop going down, and the large number of put buyers will lose money).

All of these thoughts can be summed up in this one statement: *when implied volatility reaches an extreme peak during a stock's downtrend, then the stock is ready to at least stabilize and possibly to even move higher.* The same thought applies to index options.

---

A classic example of this occurred in early 1993, involving IBM. IBM's stock had peaked near 180 in 1987 and, after the crash, had never responded as

well as the overall market. It was able to rally back to about 140 in the beginning of the 1991 bull market, but then it began to stumble badly when it was apparent that the company wasn't positioned for the computer boom of the time. It fell slowly but steadily at first, eventually breaking 100 on the downside in early 1992. A short rally brought it back up to 100 in June 1992, and then the decline began to accelerate with a vengeance. Figure 4.17, which shows both the price of IBM and the implied volatility of its options, encompasses the period from August 1992 to October 1994. The sharp decline in price during the last half of 1992 is evident on the left side of the chart. (We mentioned this same time period back in Chapter 2 when we were using IBM as an example of naked put writing.)

During the slow but steady part of the decline (March 1991 to July 1992), IBM's implied volatility had risen only modestly from the 20 percent area to about 25 percent. And, in fact, when the stock rallied back to 100 in June 1992, implied volatility quickly settled back to the 20 percent range

**Figure 4.17**  
**IBM, 8/92-10/94**

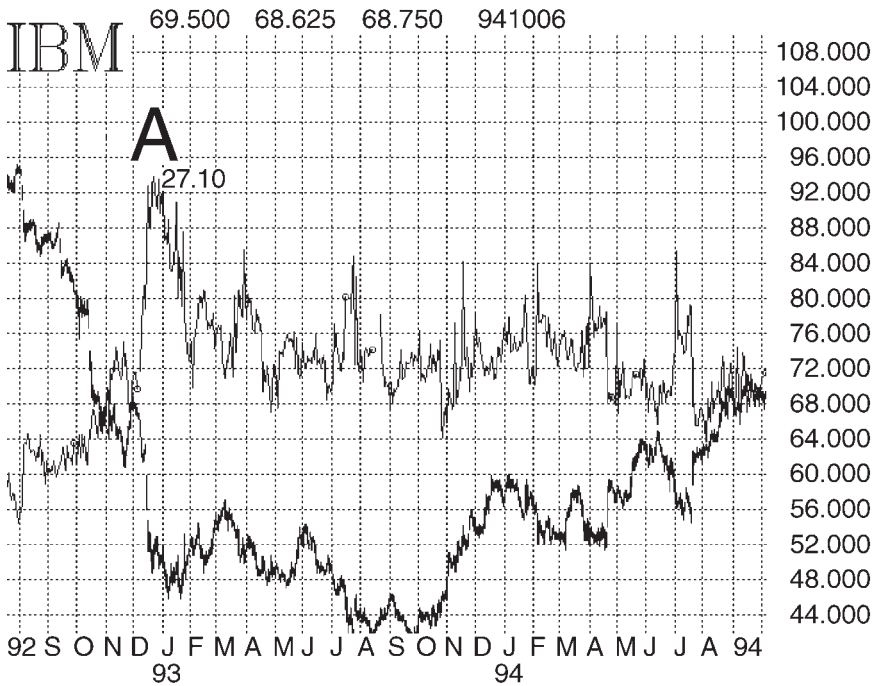

once again. However, when the more rapid decline of late 1992 began to unfold, implied volatility began to skyrocket. You can see from Figure 4.17 that it was increasing from August 1992 through November 1992, and then it literally exploded during December 1992 (point A on the chart). Implied volatility had risen to nearly 50 percent by that time! This occurred with the stock near 50.

By early January, implied volatility was still high—near 40 percent—but it looked as if the peak volatilities had been seen. This then was a signal that the stock was going to stop going down. It was also a signal to begin establishing covered writes in IBM. These covered writes were very profitable, whether the strategy was followed for only a couple of months or if it took a more intermediate-term view. Look at Figure 4.17 again. You can see that IBM stabilized and stayed near 50 through June 1993. Thus a covered write of any (expensive) call with a striking price of 50 would have worked out very well.

If you had taken a longer-term view, things might have worked out even better. You can see from the chart that even though IBM made a slightly lower low in the summer of 1993, it generally moved sideways for the entire year of 1993 and even into early 1994. However, option implied volatility remained relatively high during that time. Notice from the chart that the implied volatility during all of 1993 was higher than the implied volatility on the far left side of the chart (August 1992). Thus, you could have repeatedly written covered calls and taken in expensive premiums while the stock price was more or less unchanged. Eventually, IBM *did* begin to rally, and you would have been called away for a final time, but not before registering some very nice profits along the way. By late 1994, implied volatilities had dropped back into the low 20 percent neighborhood.

The additional advantage that the covered writer had during 1993, of course, was that he was selling options that were expensive and was therefore getting more downside protection than he was theoretically entitled to. This is when the covered write strategy is at its best.

---

Another similar example is found in the trading of Telefonos de Mexico (TMX), or Telmex, as it is commonly called.

---

When the peso was unexpectedly devalued in late 1994, Mexican financial investments collapsed in value. Since Telmex is the largest stock in Mexico (it's the telephone company), it was a focus of attention.

The chart of Telmex is shown as Figure 4.18 and includes the implied volatility of its options. Prior to what is shown on the chart, Telmex had

**Figure 4.18**  
**TELEFONOS DE MEXICO (TELMEX)**

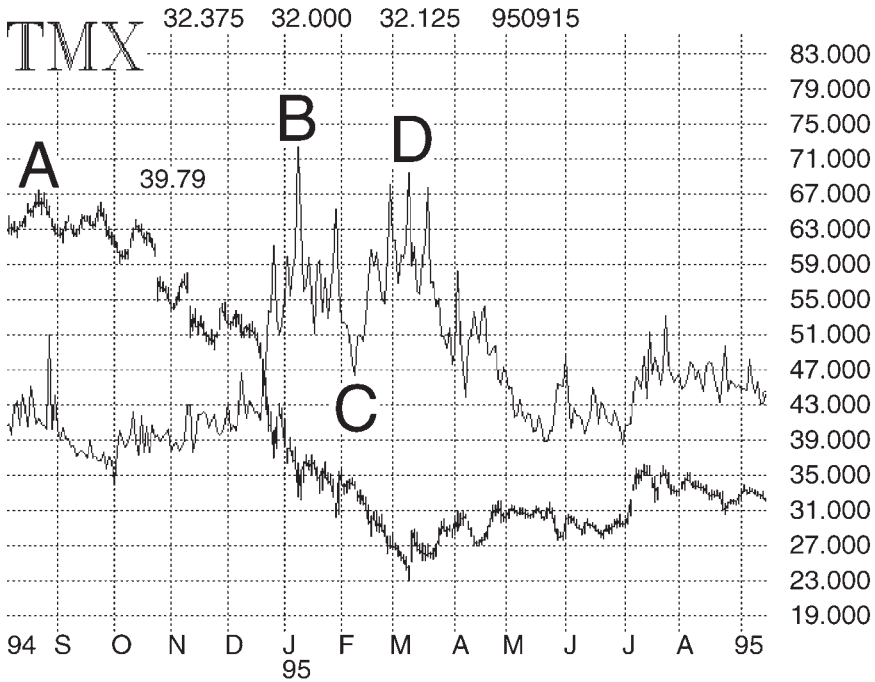

peaked in price at around 75, fallen into the 50s, and then rallied back into the high 60s (point A on the chart). As had been the case with the initial decline in IBM, the implied volatility of Telmex options did not really change much; it was near 30 percent the entire time.

In fact, except for a small spike in volatility in late August 1994, the implied volatility stayed pretty stable even while the stock was falling. In November and December, the stock was falling to a price of 50, and implied volatility was increasing very gradually. Then the peso devaluation came, and the stock began to fall rapidly. Implied volatility jumped, too, and reached an interim peak in January 1995 at over 70 percent (point B on the chart). The stock was trading in the 33-to-35 area by that time.

In February, it appeared that implied volatility had peaked (point C on the chart), and covered writes might have been established at that time. As it turned out, that was premature, as prices dropped to near 25 and implied

volatility shot back up again in March (point D on the chart). By late March, it again appeared that implied volatility had peaked, so covered writes were again warranted. The stock was at or just below 30 then. So, whether you had established the covered writes in February with the stock near 35 or in March with the stock near 30, you still had a good position. As you can see from the chart, the stock stabilized for months, trading sideways through the whole summer of 1995. Eventually, implied volatilities dropped back down into the 35 percent range, and the scenario was finished.

---

The Telmex example again demonstrates the viability of looking for situations where implied volatility is skyrocketing while the stock is falling. Once the volatility peaks, covered writes are a preferred strategy. The example also demonstrates a problem with the strategy, in that volatility may appear to have peaked, only to increase once again. This problem can be at least partially countered by taking only a half position on the first decline in volatility, with plans to add to the position as time passes.

One might think that given the apparent success of looking for *high* implied volatility, there might be a corresponding strategy associated with *low* implied volatility. If there is, it is much less evident for stock options (we'll see shortly that it's better used with index options). Obviously, if you feel that implied volatility is too low and, therefore, that the options are too cheap, you can consider option-buying strategies. These would primarily be straddle purchases; but stock options can get cheap and stay cheap for a long time, causing woe for straddle owners. So, watching for exceedingly low implied volatility in stock options may sometimes be worthwhile, but it is a strategy that has to be used selectively. It is discussed extensively in Chapter 6.

## **Implied Volatility of Index Options**

The same philosophies regarding the use of implied volatility as a predictive tool for stocks can be applied to index options—often with more accurate results than using them on stocks. This is especially true of the broad-based indices, such as the Standard & Poor's (S&P) 100 Index (OEX) or the S&P 500 Index (SPX). When the market is collapsing and implied volatility is exploding, the market is nearing a

bottom. When implied volatility finally peaks and begins to fall, that bottom has often been reached. Conversely, if implied volatility gets too low, we can expect a market explosion (not necessarily a drop in the market), for a large move is possible in either direction.

The Chicago Board Options Exchange (CBOE) publishes two very important volatility indices. One is VIX, which is the implied volatility of SPX options. The other is VXO, which is the implied volatility of OEX options. Of lesser importance, in general, are two others related to Nasdaq indices: QQV, which is the implied volatility of QQQ options, and VXN, which is the implied volatility of the NDX (Nasdaq-100) options.

VIX was the first of these indices to be created, and its inception dates back to 1993. At the time, the CBOE backdated the calculations to January 1, 1986, so that the crash of 1987 was encompassed in the data. This original VIX computed an implied volatility figure using OEX options. Rather than use all of the options, it only used eight of them: puts and calls at the two nearest months and the two nearest strikes to the current OEX price. This was a reliable measure, and many people came to depend on it.

However, in late 2003, the CBOE changed the format of VIX. The “original” VIX was renamed VXO, and a new VIX was created—one that was based on the SPX options traded on the CBOE. Moreover, this new VIX used all of the options and was calculated with an entirely new formula. When this new VIX was created, the CBOE backdated it to the beginning of 1990, which unfortunately means that the crash of 1987 was not included in the calculations. The new VIX’s history was very similar to that of VXO—peaks appeared at similar points in time, although perhaps not at the exact same levels.

At the time of this writing, both VIX and VXO are followed by “volatility watchers.” In the following discussions, the VXO is used to describe the behavior of volatility for two main reasons: (1) it has a longer backdated history and (2) it was actually in use during all of the market movements since 1993, so its history is real (not theoretical). (The reader should understand that any statements made about VXO are also true regarding VIX. They are very similar.)

The entire history of VXO is shown in Figure 4.19. This chart shows the various spike peaks in implied volatility that have occurred

**Figure 4.19**  
**CBOE'S VOLATILITY INDEX (\$VXO)—ENTIRE HISTORY**

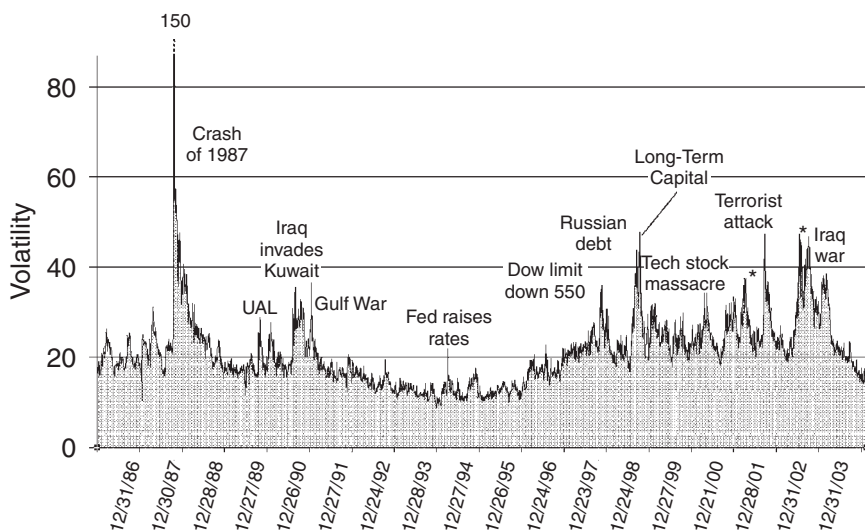

\*Bear market panic bottoms.

over the years, and all were eventually important buy signals. By looking at Figure 4.19, you can see the biggest panic peaks in VXO, from the crash of 1987, through the Gulf War, to the panic bottoms in October 1997 and 1998 and the terrorist attack on 9/11/2001, through the bear market bottoms in 2002 and 2003.

While the OEX chart is not shown in Figure 4.19, one can easily verify that each of these spike peaks in volatility was an excellent intermediate-term buy point. Just when everyone else was panicking and rushing to buy puts—at outrageous prices—the market was bottoming—a classic contrarian situation.

Other things are also apparent from the long-term chart in Figure 4.19. One is that VXO trades at all sorts of different levels—from 10 to 60 and above. Thus, it is *incorrect* to say that a fixed level of VXO is a buy signal (or a sell signal). On the one hand, some of the spike peaks occurred with VXO in the low to mid-20s (Gulf War or when the Federal Reserve System raised rates in 1994). On the other hand, VXO rarely *ever* traded *below* 20 from 1996 through 2002. So, a *dynamic* interpretation is necessary, as it is with most

market indicators. One identifies spike peaks, wherever they might occur, as long as they accompany a swiftly declining OEX.

The long history of VXO in Figure 4.19 shows several distinct periods and trading ranges. First, there was the 1986–1990 time period, when VXO often traded above 20 and large spikes occurred at the 30 level or higher (not to mention the 150 level reached in the crash of 1987—a level never even approached since). But then the market became docile from 1991 through 1995, with VXO trading down its all-time lows below 10 and rarely getting above 20. However, that all began to change in 1996, when VXO increased all year. Then, from 1997 through about the first half of 2003, VXO was consistently volatile—probably averaging near 30. Suddenly, the bull market that sprang up in March 2003 issued in a period of steeply declining volatility, taking VXO down to levels not seen in eight years. So, VXO can change complexion, and it is the job of the strategist to notice these changes and follow along with them—not picking some fixed level of VXO as “expensive” or “cheap” and stubbornly refusing to yield even as VXO makes a new extreme high or low.

What happens when VXO is “too low”? Is this a sell signal? Actually, no, not always—sometimes it is, sometimes it isn’t. In fact, when VXO is “too low,” that means the market is about to explode in one direction or the other, but it is often uncertain as to which direction that will be. We can offer some guidance on this issue, though.

But first, let’s examine *why* a low VIX or VXO reading means that the market could explode in either direction. Remember, when the volatility indices are at extremes, it is sentiment that is pushing them there. When they are very expensive, option traders are panicking and buying puts at any price just as the market bottoms. Conversely, when VXO is very low, what is going on in the option market? Option sellers are aggressive and buyers are timid, and thus premiums decline. Their true expectations are that the market isn’t going to do much of anything. That’s why they’re willing to sell premium at such low prices. Of course, when “everyone” thinks the market is going *nowhere* then—by contrarian analysis—it is destined to go *somewhere*, and fast! Hence it explodes. This concept is true whether the underlying is an index, stock, or futures contract.



In order to illustrate this, it would be a fairly simple matter to mark the low points in volatility on Figure 4.19 and see what happened to OEX or SPX after each low in volatility. In fact, we constructed such a study. Consider Figure 4.20, a long-term (10-year) graph of OEX in lognormal format so that price changes can more easily be seen in the early years. On this graph are a number of boxes. The shaded boxes indicate downdrafts in the market, while the clear boxes indicate short-term uptrends. The left side of these boxes was placed on the graph coincident with lows in volatility. We define a low in VIX as the following: it is not preceded by a lower VIX reading for 60 days nor succeeded by a lower reading for 30 days. Hence, a low defined in that manner is truly a low—not just some temporary thing, but a true low over a three-month period. Those lows don't occur too often, only about once or twice a year. Whenever one of those lows occurred, we started a box on Figure 4.20 and then observed what the market did.

**Figure 4.20**  
**§OEX MOVEMENTS AFTER LOW §VIX READINGS**

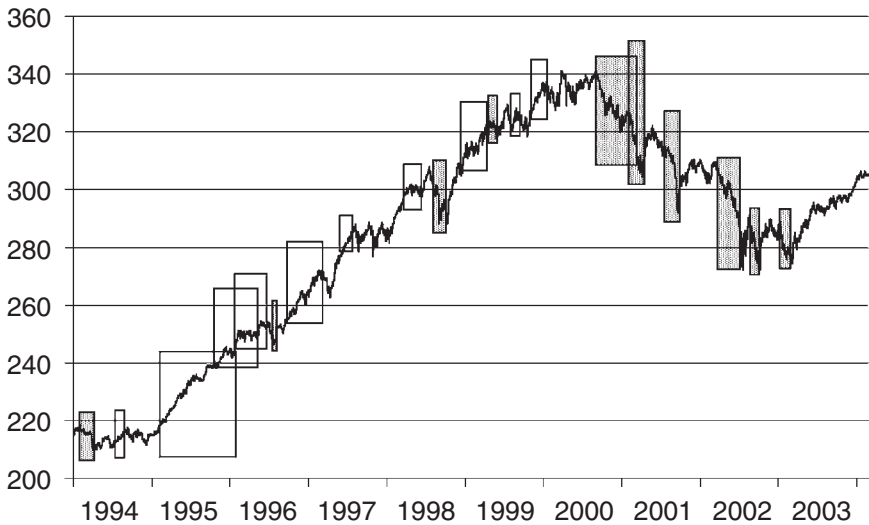

You can see that the shaded boxes (market declines) and the clear boxes (market rallies), are about equal in number. Even more interesting, though, is the fact that most of the clear boxes occurred during the big bull market of the 1990s, while most of the shaded boxes occurred after the bear market began in 2000. So, we might be able to draw an even more refined conclusion: after a true low in VXO, the market makes an explosive move, usually in the direction of the primary trend in the market at the time.

Many traders feel that a low in volatility precedes a declining market—and that was certainly true in 2000 through early 2003. But it was clearly *not* true back in 1995, for example. One of the largest market rallies—a straight up move that lasted about 10 months—was born after one of the lowest VXO readings in history (in February 1995). So, once again, it is important to use a *dynamic* approach and not get locked into adages that are wrong, such as “The market always declines after a bottom in VIX.” It just isn’t true.

Some readers may want to know more about *why* this is true, because it is often stated that as a stock rises, its volatility eventually decreases. That is true, in general, and was discussed earlier when comparing the behavior of a \$5 stock with that of a \$100 stock. But if any market advances in a herky-jerky manner, then volatility will increase for a while. What many traders don’t realize is that volatility is computed as a statistical measure. It is actually the standard deviation of the *percentage daily price changes of the underlying instrument*. This use of *percent changes* is what makes the analysis lognormal, to conform to actual stock market behavior. Now, if the market were to rise by the exact same percentage every day, it turns out that its volatility—according to the mathematical formula—would be zero! This almost defies logic, for any trader can tell you that if he is riding the back of stock that is galloping higher every day—even if it’s by the same percentage each day—it most certainly is volatile. But that’s the way that volatility is calculated.

Relating this to stock market movements, then, can perhaps clarify some of the behavior we see in volatility. During bearish markets, the down days are usually fierce and the decline is swift. However, the market gets “oversold” quickly, and then there is usually a monster rally—just for a day or two—before the decline begins again. This combination of large declines and large advances produces a

high volatility reading via the formula for calculating volatility. However, in rising markets, it is often the case that the market grinds higher—never really “melting up” but rather making a series of new highs, with very subdued declines. In fact, that’s exactly what the market was doing from March 2003 through February 2004; and you can see from Figure 4.19 what happened to VXO during that time: it collapsed from relatively high levels to eight-year lows.

But, as stated earlier, if a rally develops some herky-jerky movements—say, several large up days followed by a sharp, but occasional, setback after the market gets overbought—*then* volatility can actually increase while the market rallies. This is what happened in 1995, for example: the rally was long-lived, but there were short-lived, occasional setbacks that produced the volatile movements needed to make VXO increase over the time period of the rally.

It’s not really important to know how to calculate volatility. The immediately preceding discussion was just presented to give those who want it some insight into the workings of the volatility calculation. One can certainly observe the trend of VXO, determine whether it has made a low that has lasted for a month, say, and then take appropriate action for the expected market explosion. When you’re ready to trade this situation, the best approach—if you’re unsure as to the primary trend of the market—would just be to buy straddles, for they would be cheap when VXO and VIX are making lows. Then sit back and wait for the market to explode—and hopefully for volatility to increase as well. Of course, if you have a good feel for what the primary trend of the market is, then you can gear your option strategy toward the direction of that trend, rather than merely taking the more neutral approach of buying straddles.

### **A Case Study: The 1994 and 1995 Markets**

As noted earlier, volatility was relatively low during this period, but there were enough swings in VIX (which at the time related to OEX options) to produce several good trades over that period. Consider Figure 4.21. The graph shows the last few months of 1993, when

**Figure 4.21**  
**VOLATILITY INDEX—VIX**

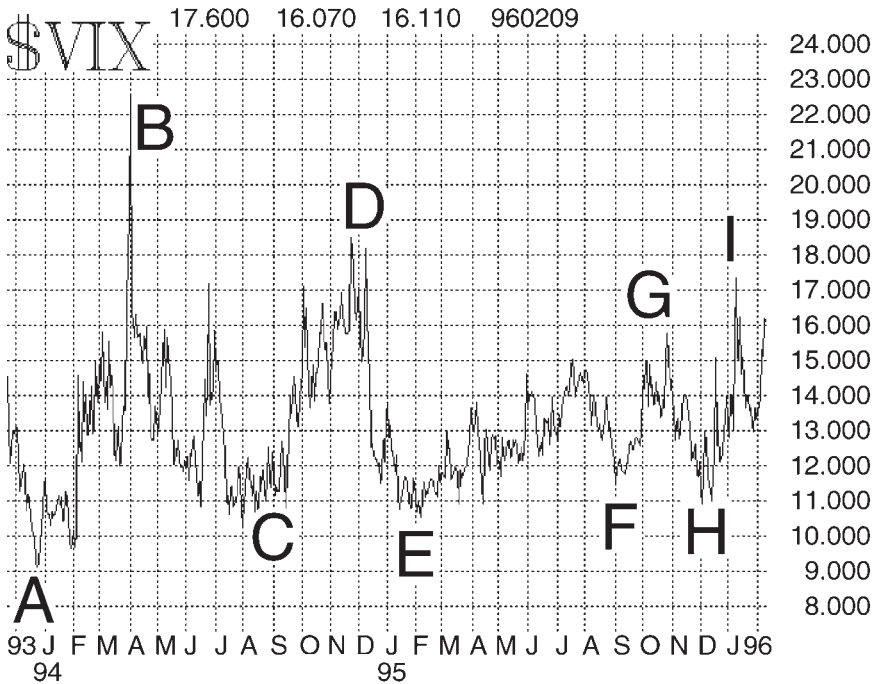

volatility began to trend lower. In fact, it broke below the year range, falling all the way to 9 percent in December 1993 (point A on the chart). In fact, this was the all-time low for VIX and remains the all-time low even now, over 10 years later.

Figure 4.22 shows the chart of OEX for the same time period—1994 and 1995. The market was edging modestly higher and making incremental new highs through January and into the beginning of February 1994. Then the Federal Reserve System (the Fed) raised rates for the first time in years, and OEX quickly fell nearly 50 points in just a couple of months—a sizeable decline of about 11 percent. So the low volatility on the VIX chart in December (point A) was a

**Figure 4.22**  
**OEX**

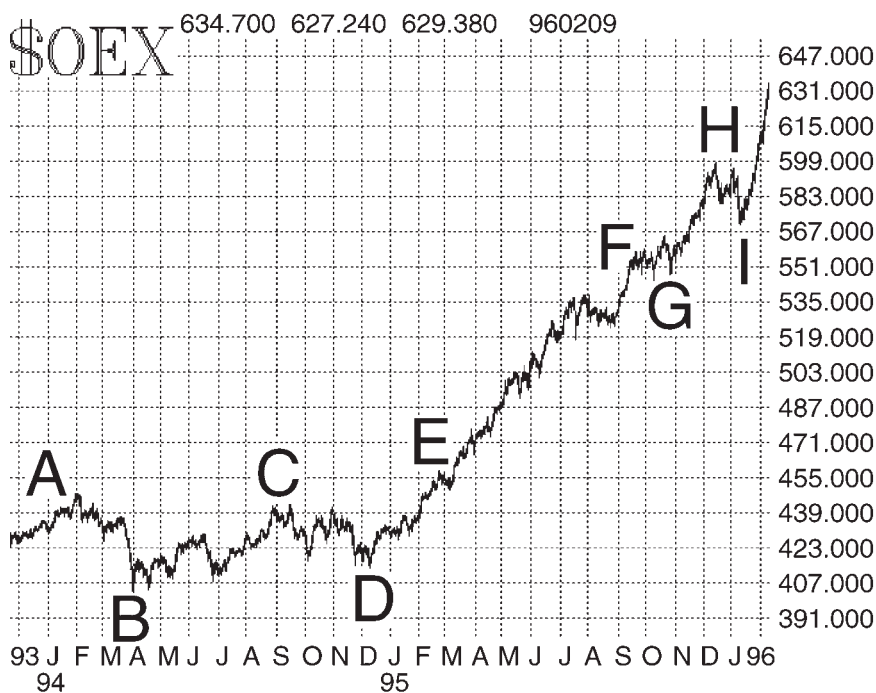

good warning sign for what eventually turned out to be a major market decline.

All the while that this decline was taking place, OEX implied volatilities were rising. As the declines accelerated in late March and especially on the first trading day of April, VIX shot up to nearly 22 percent (point B on Figure 4.21). Implied volatility quickly retreated from those extremely high levels, leaving a spike high on the chart. *An extremely high implied volatility reading, especially if it occurs as a spike, is generally a sign that a short-term bottom is at hand for the broad market.* OEX rallied right after that spike in implied volatility, and the rally carried into the middle of June 1994.

So the spike in implied volatility at the very beginning of April was a good time to buy the “market,” or OEX in particular.

If you look back at the chart of the VIX, you will see that it reacted all the way back down to 11 percent while this market rally, which began in April, was going on. In June, a short, sharp market drop followed. By late June, this decline sent VIX spiking back up to 17 percent. This was a very short-term movement, so many traders may not have caught it. However, with the aid of VIX, you would have at least been aware that a trading high and low were likely.

In the late summer of 1994, the broad market was rallying once again. As is customary during steady rallies, implied volatility remained low, in the 11 percent to 12 percent range (point C in Figure 4.21). At about the same time that VIX broke out to higher volatility numbers over 12 percent, another relatively quick and sharp market decline began (in September). Once again, low volatility had preceded a falling market. Often, the timing of the market move, whether up or down, can be refined by noting when volatility begins to increase.

Even though the broad market rallied a little in October 1994, it eventually made its way to a new low in early December. Implied volatility, as measured by VIX, climbed rather steadily during that whole time, once again reaching levels above 18 percent (point D in Figure 4.21). From there it spiked down, a buy signal. In fact, this turned out to be a very large buy signal, as OEX and the broad market embarked on one of the largest rallies in recent memory. So, during 1994, using VIX as a guide to short-term market movements was very profitable.

As the large rally that started in December 1994 worked its way higher over the next couple of months, VIX fell below 11 percent again (in February 1995; point E in Figure 4.21). As it turned out this time, the market roared even higher. This, then, is an example of low volatility preceding an *upward* move in the market. After that, implied volatility settled into a trading range between 12 percent and 15 percent, neither spiking too high nor reacting to a new low.

In order to have profited from each of the low volatilities during 1944 and 1945, you would have needed to buy straddles each time, for you did not know whether the market was going to move higher

or lower. Since the moves were large, profit would have resulted. Backspreads would have worked as well, as we'll see in Chapter 6.

Prior to the CBOE's initiating the VIX, there were other notable periods of extremely high or low implied volatility in OEX options preceding important market turns. Some of the low volatility examples include both August 1983 and August 1984. Both times, the market exploded higher shortly thereafter. Then, in 1987, OEX implied volatility reached very low levels just after the market peaked, but before the crash. Thus, followers of option premium were long straddles when the crash came.

---

In September 1987, the market had made some attempts to retest the all-time highs made in August, but those attempts were unsuccessful. At about this time, implied volatilities of OEX options and S&P 500 futures options were trading with an extremely low volatility.

The December S&P 500 straddle could be purchased for 15 points, with the index at about 320. That was a very low level of volatility, considering that the market had been rather volatile while rising all during that year. In fact, no three-month trading range had been contained within a 15-point-wide band since the middle of 1985 (i.e., for over two years). Mathematically speaking, statistics indicated that there was a 93 percent chance that the market would move at least 15 points in three months.

As it turned out, the market moved much more than that, of course, falling over 100 S&P points during the crash.

---

### **Another Case Study: 1997–1999**

We will conclude this section with one more example of VIX trading opportunities. Figure 4.23 shows both VIX and OEX over a two-year period: from the fall of 1997 through the fall of 1999. While the market was still in the throes of the bull at this time, there were numerous VIX trading opportunities presented. In Figure 4.23, the spike peaks in VIX—which are buy signals, when accompanied by a rapidly declining market—are marked with “B” for buy. However, the low VIX readings are marked with “X,” for explosion, since we don't know at the time they occur whether they represent buying or selling opportunities in the market.

**Figure 4.23**  
**\$VIX AND \$OEX: 1997-1999**

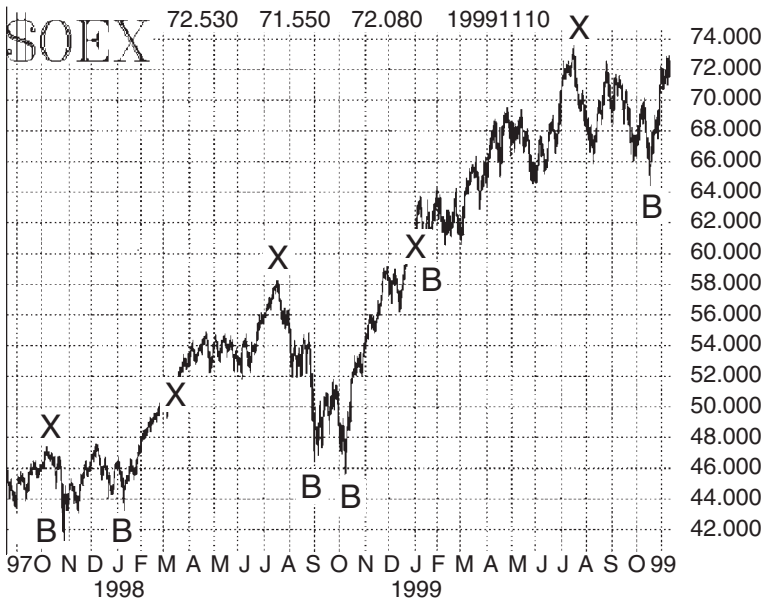
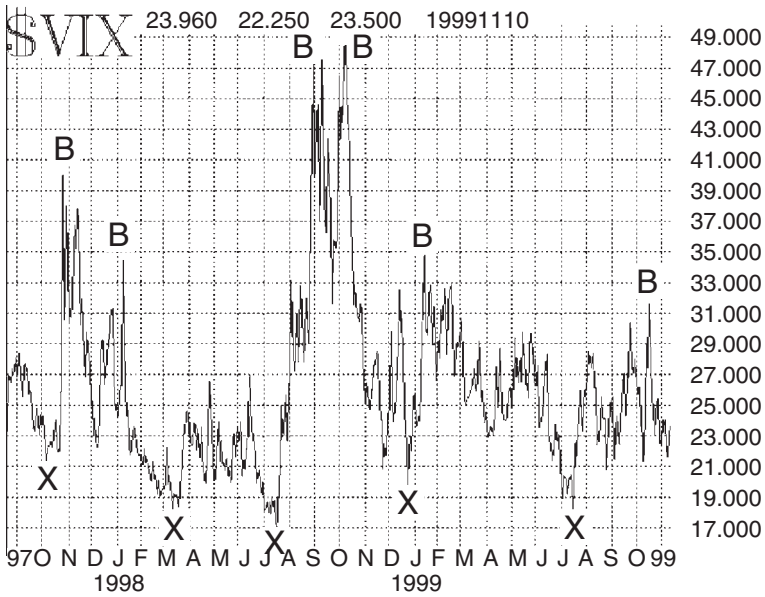



First, let's consider the buy signals. The first one occurred in November 1999 (for the cause, see the next trading story). On Monday, October 27, the Dow Jones Industrial Averages (the Dow) locked "limit down" for the one and only time in its history. The exchanges had installed trading limits in the wake of the crash of 1987, but they had never been tested until this fateful day.\* The limit at the time was 550 Dow points. When the decline reached those proportions in midafternoon, trading halted, and since there was no forthcoming rally, that's where the market closed. In reality, though, traders knew that the market had farther to fall, and thus the prices of puts were bid up rather astronomically (and calls were bashed down). Thus, implied volatility spiked, and VIX reached 40.

The next morning, Tuesday, October 28, the market opened down about 200 points; but then a major rally set in, and the Dow closed *up* over 300 points—a positive intraday reversal of about 550 points, from low to high. Initially, VIX spiked to 55 intraday, before collapsing to 30 on the close. That clearly was a spike peak in volatility. If one had been only an observer, he could still have bought at this point—*after* clearly seeing that VIX had made a spike peak. The Dow rallied another 600 points over the next few weeks. In Figure 4.23, you can see the clear spike peak in VIX (only closing prices are shown), and the subsequent rally in \$OEX—from 407 to 441 intraday on that big "Turnaround Tuesday," and then on to 475 in the next few weeks.

Thus, even if you only observed VIX's close, you could have made good profits over the next few weeks. Moreover, if you were

---

\*Many traders and investors were not happy that the NYSE had to shut down, intraday, because they felt that that only created more-massive selling pressure, which was released the next morning. However, it was clear from the crash of 1987 that allowing selling to continue unabated—without people having a chance to take a breather and assess the true situation—was not a good idea. In the wake of the 1997 "limit down" event, the limits have been raised considerably and are somewhat based on the volatility of the market. If they were to occur now, they would take place in stages: first, a half-hour trading halt; then, if there is more selling, a two-hour trading halt; and then, if that doesn't stem the tide, a full trading halt for the day. At the present time, the first halt (a half hour) would occur if the Dow fell 1,000 points intraday, and the full trading halt would not occur until the Dow fell 2,800 points intraday (the Dow was at about 10,400 when those limits were set). The limits are reset every three months, to keep them in line with current market price and volatility.

watching *intraday*, you would have surely surmised that VIX had made a spike peak when it fell from its high of 55 to, say, 40—unchanged on the day. Purchases made at the time would have profited nicely by the end of that day and could have been held while the ensuing rally unfolded.

---

All through 1997, there had been a massive seller of naked index options. On the trading floor, he was known only as “The Sheikh.” His identity was closely guarded, but his trading was not. It was common knowledge that he would sell hundreds or even thousands of out-of-the-money puts and calls on OEX naked. He was never heard from after October 1997.

One of the fallouts of the Dow locking down the limit in 1997 was the forced liquidation of a large hedge fund run by Victor Niederhoffer, an experienced trader who had been successful as an associate of supertrader George Soros. In short, when the Dow locked limit down on Monday, October 27, Niederhoffer’s fund could not roll their short puts to another month or strike since the market shut down intraday (other markets, such as the CBOE, shut down, too, when the Dow reaches its limit—not just the NYSE). As a result, a massive margin call ensued, and a majority of the positions were liquidated on the opening of trading on October 28. That’s mainly what caused the spike peak in VIX that morning, sending it up to 55. Margin clerks don’t *bid* for things, they just buy them at the market, for if a customer’s margin is completely exhausted, then the brokerage firm at which his positions are kept could be liable for any further losses.

Was Niederhoffer “The Sheikh?” No one is saying for sure, but rumors on the trading floor were rampant that they were one and the same after it became public knowledge that Niederhoffer’s hedge fund was carrying such large naked index put positions and had been forced to liquidate, while at the same time “The Sheikh” had disappeared.

---

As it turns out, this wild action in the market was only preparation for a much more volatile period a year later—in 1998. On the VIX chart in Figure 4.23, you can see two buy signals—one on September 1, 1998, and one just over a month later, in October 1998. The first spike peak was caused by the Russian debt crisis that escalated out of control at about that time. The second was the a general market panic, fueled in good part by the near failure of a massive hedge fund, Long-Term Capital (whose problems were related in no small part to the Russian debt crisis that had occurred the month

before). These events sent the market careening downward twice, with VIX spiking up to very high readings each time. However, both times the subsequent spike peak in volatility was a good buy signal—the first one lasting only a couple of weeks before selling set in again, but the second one being a true intermediate-term buy signal that carried OEX 180 points higher in just three months!

After those two massive VIX readings, the other three spike peaks shown in Figure 4.23 are somewhat subdued, but they were good buy points nonetheless. They occurred in January 1998, January 1999, and October 1999. None were related to anything more than somewhat panicky selling (no major news events). The last one probably occurred for no other reason than that traders were very nervous in October 1999, after the previous two Octobers. The OEX chart in Figure 4.23 shows that all three were good buy points, with OEX gaining substantially after each one.

The *low* volatility readings in Figure 4.23 were nearly as plentiful. There were five of them. Each occurred with VIX somewhere between 17 and 21 at the time. In real time, an investor might have not been sure *when* the bottom in VIX was going to occur; but if one used a gauge of, say, a VIX increase of three points from its bottom (from 17 to 20, for example) as his definition of a “VIX bottom,” he could have profitably purchased straddles.

Three of the five low VIX readings led to declining markets. The first low reading occurred in early October 1997 and led to the nasty decline at the end of the month. A larger decline occurred in July 1998 and marked the top of the market for several months (some even call July to October 1998 a “mini bear market,” since the major indices declined over 20 percent in that time period). Another, shorter-term selloff occurred after another low VIX reading in July 1999.

The other two low VIX readings actually occurred right in the middle of strong market rallies—in March 1998 and in December 1998. In both cases, the market continued on farther (even though VIX began to increase).

Thus, index option implied volatility is not only useful as a market indicator, but also as a *strategy* indicator. That is, when implied volatility is too low, option buying strategies are better, for a market explosion may be at hand. But when implied volatility is high, selling

strategies may be good for strategists, whereas buying the market may be good for speculators.

## The Seasonality of Volatility

*Seasonality*, a method of analysis applied to many aspects of the market, merely describes market tendencies that seem to occur with some regularity at fixed dates. For example, you might observe that the market often rises during the last couple of trading days each month, as institutional “window dressing” takes place. A longer seasonal pattern is the market’s tendency to move in a four-year cycle, where the low point is reached in the year midway between presidential elections (2002, 1998, 1994, etc.).

The point that you should realize is that a *seasonal* pattern is just an *average* of the movements over time of the market being studied. In any *one* year, the market in question might behave in a manner quite contrary to what the annual seasonal chart indicates. Seasonality’s usefulness is often only realized if an investor has the ability to trade the same position or strategy several times in a row; then the average should take effect and eliminate any effects of one particular bad year (or any one particular *good* year for that matter). When the seasonal pattern is *annual*, it takes quite a while for the “average” to be felt. More-frequent seasonal patterns (such as “the market rises near the end of each month”) offer more opportunities for trading.

In the preceding example of VIX trading during the 1997–1999 time period, it was quite clear that VIX peaks occurred in October and low points occurred in July. Was this just a coincidence, or does VIX have some seasonality to it?

Most option traders have a general feeling that volatility is low in the summer and explosive in the fall of the year. It turns out that those are correct observations, but much more can be gleaned from studying the patterns of volatility over the *entire trading year*. Moreover, not every year is the same. Thus, volatility displays *constant* seasonality—it encompasses year-round action. However, much of the time, there isn’t anything untoward about what’s transpiring; there are just a few times each year when the volatility chart is particularly interesting.

This information should be of great use because it can aid not only in timing but also in how aggressive to be in pursuit of the strategy. For example, if an investor knows that options are entering a period in which volatility generally declines, then he would want any straddle buying opportunities to be *especially* solid with respect to mathematical probabilities. This doesn't mean that he would avoid volatility buying altogether just because the seasonal tendencies might indicate that a volatility decline could be expected in the coming months.

For the purposes of studying seasonality in this case, the CBOE's Volatility Index (VXO) is used, since it has the longest history, going back to 1986. Also, the study is arranged by *trading day of the year* rather than by actual date. Since there are about 250 trading days in each year (some years have a couple more), this makes for a nice uniformity in the results; that is, if there were 15 years in the study, then each of those trading days had 15 different volatilities to average. If calendar days were used instead, then, because each day of the year occasionally falls on weekends or holidays, there would be 365 data points, but only about 10 or 11 volatilities averaged for each one.

Figure 4.24 shows the composite implied volatility for all the data that was available—from January 1, 1989, to December 31, 2003. Although VXO data backdates to January 1, 1986, the volatilities from October 1987 through the middle of 1988 were so distorted by what happened in the crash of 1987, that we began this study *after* the effects of that event had subsided from the market.

Figure 4.24 displays the average VXO for each trading day. The y-axis shows the magnitude of those volatilities. Actually, the magnitude is not important. Rather, it is the shape of the graph that is most meaningful (again, a dynamic interpretation). In other words, we want to observe where the peaks and valleys occur. The x-axis is technically the trading days from the beginning of the year (as explained earlier); but to make some sense of it in terms of the calendar, the months of the year have been noted on the x-axis. The months were placed at intervals that represent where they would fall in the year, in terms of trading days.

There are a number of things that are evident from this graph. Volatility tends to *begin* the year with a rather sharp rise to a spike in mid-January. Then it transcends into a rather steady state, with

**Figure 4.24**  
**\$VXO COMPOSITE SPREAD: 1989–2003**  
 ----- (By Trading Day of Year) -----

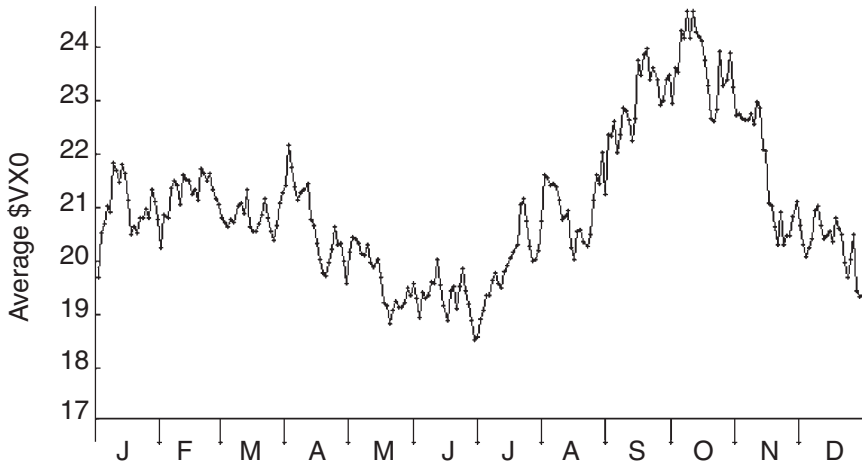

another sharp rise in late March to a peak in early April. After that, volatility then begins to decline rather noticeably to its yearly lows. The annual *low* point in volatility occurs, on average, just about the first of July. There is then a slow, accelerating increase in volatility from July until the October peak. After that, the volatility decline is very sharp, culminating in a bottom in late December.

You might ask, “How reliable is this pattern?” We know with certainty that many Octobers have seen serious increases in volatility—especially years with nasty October market declines (1989, 1990, 1994, 1997, 1998, 1999, 2001, and 2002). But what about the rest of the pattern? Does it really hold up?

Obviously, some years are going follow the pattern more than others. For example, 2003 saw a volatility peak in March and a steady decline for the entire remainder of the year. But 2002, the bottom of the bear market, had a generally high volatility all year, highlighted by two peaks—at the stock market bottoms in July and October. Thus, in 2002, July was a *high* volatility, not the annual low as is usually the case. Thus, some years do not conform to the pattern very well. In order to give some perspective on how the data

in the study conformed to the composite pattern, each year was examined to see if the five major seasonal points occurred that year or not. The data are shown Table 4.11.

The last line shows how many years out of the 18 in the study conformed to that particular one of the five patterns. The July low, the October high, and the November-December decline in volatility were the most reliable, each conforming in 14 or 15 of the 18 years. The least reliable pattern was the April peak (10 out of 18 years).

As mentioned earlier, these seasonal patterns are just guidelines. Individual stocks will behave in their own way much of the time. Hence, it is possible to find straddle buys that work even if established in October. It's just a lot more likely they can be found in July.

**Table 4.11**  
**YEARLY VXO PATTERNS**

Year	Jan Spike	Apr Peak	July Low	Oct Peak	Nov-Dec Decline
1986	Y	Y	Y	Y	Y
1987	N	Y	Y	Y!	Y
1988	Y	N	N	(Nov)	Y
1989	N	N	Y	Y	Y
1990	Y	N	Y	Y	Y
1991	Y	N	Y	N	N
1992	N	N	Y	Y	Y
1993	Y	Y	Y	Y	Y
1994	N	Y	Y	N	Y
1995	N	Y	N	Y	Y
1996	Y	Y	Y	N	N
1997	N	N	Y	Y	Y
1998	Y	Y	Y	Y	Y
1999	Y	N	Y	Y	Y
2000	Y	Y	Y	Y	N
2001	Y	Y	Y	Y	Y
2002	N	N	N	Y	Y
2003	Y	Y	Y	N	Y
<b>Out of 18:</b>	<b>11</b>	<b>10</b>	<b>15</b>	<b>14</b>	<b>15</b>

Straddle buying is best when positions are established in December, late January, and June or July. Conversely, volatility sellers using the composite patterns should look for opportunities very early in January, in April (or late March, some years), and in early November.

While such a simple approach won't produce profitable results each year (no more than the adage "sell stocks at the end of April and buy them back at the end of October" works every year [2003 was a bad year to practice that particular strategy]), it is still a good guideline for volatility traders. Moreover, the composite graph should give all option traders—and perhaps stock traders as well—a feel for how volatility can be expected to behave during a full year of trading. Remember, though, that traders should adhere to expected returns on specific positions more than they should rely on the composite volatility chart.

## Trading Volatility Directly

The forgoing sections used volatility as a guide toward trading the broad market. But it is now possible to trade volatility directly. Volatility *futures* were listed on the CBOE in March 2004. Speculators in those futures might be able to rely on the composite volatility chart in order to initiate intermediate-term trades—looking to buy them in July and reverse to a short position in October, covering in late December.

Another strategy would be to buy VIX when it is low (in the 10-to-15 area) and sell it when it's high (above 40). Refer once again to Figure 4.19 to see that those are the general ranges where \$VIX is low or high.

I have never been too sanguine about plotting oscillators and other fancy technical indicators on the \$VIX chart. There really is no reason that they should work because not only is \$VIX a sentiment indicator, but it is also tied somewhat to the actual volatility of the \$SPX options. For example, if actual (historic) 20-day volatility is 10 percent and \$VIX is trading at 15 percent, are \$VIX futures cheap or expensive? What if we also know that \$VIX futures have rarely traded below 15 percent for years? Does that add any real value to the situation? If you only looked at \$VIX as a chart and applied tech-



nical indicators to it, you might think it was ready to rally, especially if it had spent some time “basing” in the 15 percent area.

But how can it rally very much if actual volatility remains so subdued? In fact, it can't. So the differential between actual and implied volatility is an important factor, too, if you're trying to predict what the \$VIX chart is going to do.

Eventually, the CBOE plans to list options on VX futures. When that happens, there could be some very interesting strategies available, although they will still have the characteristics that any spreads, straddles, or outright option positions always do. When volatility options become available, traders will have to be cognizant of the “volatility of volatility” in order to price them. See Figure 3.2 for a graph of that volatility (at the very end of Chapter 3).

### **Further Observations on Index Volatility**

There are volatility measures besides VIX and VXO. As mentioned previously, there are two companion measures—QQV and VXN, which follow the QQQ Tracking Stock and the Nasdaq-100 Index (NDX), respectively. They could be analyzed as well, although I haven't really found that they offer results much different from those we would obtain by studying VIX and VXO.

In addition, we could also create or find other composite implied volatilities. One that we occasionally look at is the composite implied volatility of the *stock options* on the stocks that comprise the OEX. This sometimes gives a slightly different picture, for equity option implied volatility does not necessarily conform exactly to index option implied volatility, which is what VIX measures. Still, it's often very close; so we only use that composite of stock options as a secondary guide—and even then, only on occasion.

Another question that often arises is, “How does *historical* volatility fit into all of this?” After all, doesn't VIX have to be related to historical volatility to some extent? The answer is, yes, it does—but not as directly as you might think. In fact, it's often the case that VXO trades at a higher level than the actual volatility of OEX. This seems to be mostly due to the fact that traders have high expectations when they buy OEX options and they tend to slightly overpay

for them. Perhaps this is because of the ease of establishing a “market” position with just one trade, rather than having to place 100 orders on individual stock options to accomplish the same thing. Thus, traders are willing to pay up a little for the convenience of getting the whole order done with just one simple trade. This is especially true if one is buying protection for a portfolio. The price of buying an OEX out-of-the-money put is much higher than the equivalent price of buying out-of-the-money puts on each individual stock (in fact, some arbitrageurs actually buy the 100 individual equity puts and sell the OEX puts, establishing what is known as a *dispersion trade*).

Since VIX is related to historical volatility to some extent, it behooves the option strategist to pay attention to both. For example, after the market started to rally in March 2003—a rally that extended for the rest of the year—VIX began to fall and reached very low levels by May. Some market observers were calling for a market correction because VIX was “too low.” However, *actual (historical) volatility* was dropping even more rapidly. So even though VIX was low—about 22 or 23 at the time—the 20-day *historical* volatility of OEX had already dropped to 16 percent. Hence, in *that* context, VIX was not cheap, and traders should *not* have been expecting VIX to rise without some sort of increase in the actual volatility of the market—an increase that was *not* forthcoming, as it turned out.

Conversely, it is relatively rare to see VXO trading much below the 20-day historical volatility of OEX (or to see VIX trading below the historical volatility of SPX). The only times that VXO has dropped below 70 percent of the historical volatility of OEX have been times of extremely severe market volatility—the crash of 1987, the Dow limit down in 1997, the Long-Term Capital hedge fund crisis in 1998, and so on. As you know, each of those were good buy points, so this situation might be used as an additional volatility indicator.

## THE PUT-CALL RATIO

The put-call ratio is simply the number of puts traded in a day divided by the number of calls traded on that same day. Normally,

options are grouped into similar categories when calculating the ratio. For example, an *index* option put–call ratio, or maybe a *gold* option put–call ratio, might be calculated. In order to smooth out the fluctuations of the daily numbers, some moving averages of the put–call ratio are usually tracked. The *dollar-weighted* put–call ratio can be tracked as well, as it is often an even better contrary indicator than the simple put–call ratio itself. To differentiate between the two types of put–call ratios, we will use the terminology “standard” put–call ratio to refer to the typical, volume-only ratio, while “weighted” will refer to the dollar-weighted put–call ratio.

Technicians have been calculating the put–call ratio for a long time, even before the advent of listed options, for it is known to be a valuable *contrary* indicator. When too many people are bullish (when they are buying too many calls), then contrarians short the market because the majority is usually wrong. Similarly, when too many traders are bearish and buying puts, then a contrarian will look to buy the market. The put–call ratio is a measure of how many puts are trading with respect to calls, so that the contrarian can attempt to quantify his measurements.

The general patterns to compare are shown in Figure 4.25. When the put–call ratio is at a high level, a lot of puts are being bought, and that indicates a market buy. Then, the put–call ratio declines while the market is rallying. Eventually, bullish sentiment becomes too strong, and the put–call ratio bottoms just as the market is making a top. After that, the put–call ratio rises while the market is falling, until the whole cycle begins again. Ideally, the put–call ratio and the underlying instrument chart are mirror images of each other. In reality, of course, it’s never that perfect; but that is the ideal pattern one would like to find.

Put–call ratios can be computed on nearly any underlying instrument—stock, index, or futures contract. They are useful contrary indicators on most all of them, but not on every single one. Some guidance will be presented to help the reader in deciding which ones are best to use. Each different type of underlying instrument has its own particular application. Also, the *equity-only* put–call ratios are very important.

Index options, for example, are quite useful—but not all of them. Whenever an index option is heavily traded by hedgers or arbi-

**Figure 4.25**  
**PUT-CALL RATIO**

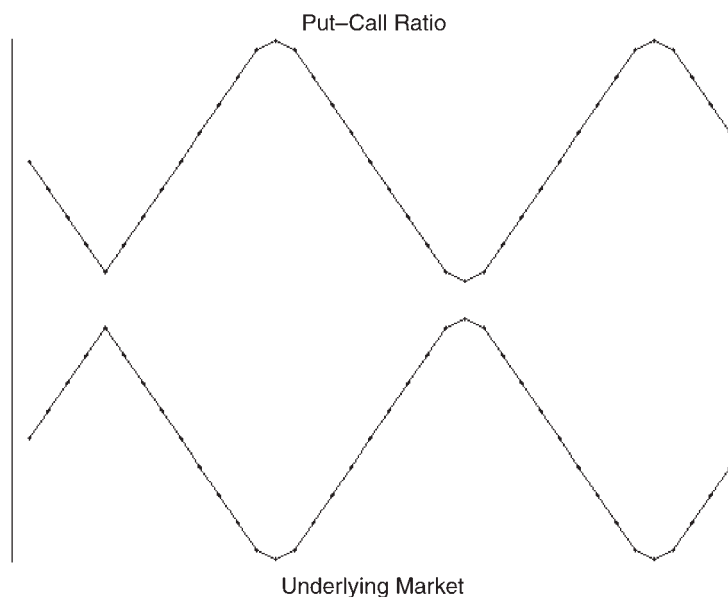

trageurs, its usefulness as a contrary indicator wanes. For this reason, many of the sector indices, such as the Semiconductor Sector Index (\$SOX) or the Gold and Silver Index (\$XAU), are quite useful. But QQQ, SPX, and OEX options are not because many institutions routinely buy the puts as a hedge. We will expand on this concept later, but for now it is sufficient to note that fact. However, the use of the *weighted* put-call ratio on these indices *can* be used—another factor in favor of using weighted ratios.

One of the most useful put-call ratios is the *equity-only* put-call ratio. As the name implies, this ratio is calculated by using *all* stock options that trade. It is used to predict the “market” overall. When it gives a signal, an investor can generally trade the index of his choice—SPX, OEX, Dow-Jones (DJX). The equity-only ratio is useful in both the “standard” and the “weighted” forms.

Stock option put-call ratios can be useful. In the first edition of this book, I doubted that fact; but I have come to the conclusion—

verified in actual practice by a number of successful trades—that, with proper care, put–call ratios *can* be used on stock options. The best situations are liquid stocks—ones with plenty of option volume and ones that are unlikely to be takeover candidates or to be easily influenced by rumors. Stocks with low average option volume, however, may not be as useful; for a large option order—even if only a covered write or a spread—might unduly influence the ratio. This same statement applies to less liquid sector options as well. Furthermore, in stocks, there is sometimes inside information present in the market—as was shown earlier in this chapter. In those cases, option activity is a direct indicator, not a contrary one; so this just stresses the point that investors should be vigilant when using the put–call ratio for stock trading.

As for futures options, they are best utilized where liquidity is great. One sums the volume over all the monthly contracts (February Gold plus April Gold plus June Gold, etc.). However, it makes no sense to calculate a “futures-only” put–call ratio (similar to the *equity-only* ratio) because there is no relationship between grain options, say, and oil options.

In general, we look for liquid option contracts in any of these markets. Furthermore, we would ideally like to see the put–call ratio reach an extreme reading as a precursor to making a trade. All of these concepts will be expanded on within this section.

One other ratio used to be important, but its relevance has waned in recent years. That is the *index* put–call ratio, which in theory is the sum of all index options that trade, but in practice was mostly just the OEX options, since that index dominated option trading for years. However, as institutional hedging has become more and more prevalent, the concept of an index ratio is not as important. Currently, I prefer to look at weighted ratios on a few specific indices, but not the sum of all index options as a whole.

## The Data

The standard put and call volume data is available in the newspaper every day and also from online sources, such as [www.tbasp.com](http://www.tbasp.com) or [www.gfds.com](http://www.gfds.com), which sell raw daily data for a fairly low price. The

equity-only data is more difficult to compile. An investor *could* download all of the individual stock data and then add them up, which is actually what *we* do at McMillan Analysis Corp.; but that would be a major undertaking for most people. An easier way is to utilize the information that is available on the CBOE web site, [www.cboe.com](http://www.cboe.com). The CBOE will even e-mail its statistics to you daily, for free, if you wish, or you can visit the CBOE web site yourself. One of the available statistics at the CBOE site is “equity-only” volume. Now it’s true that the CBOE’s stock option volume is not the same as the volume on all the exchanges (although it is sizeable), but that doesn’t really matter; for the *shape* of the chart of the CBOE’s equity-only ratio is the same as that of the chart of the true equity-only ratio—and it’s the shape that’s important, as you will soon see.

Lest you think that it’s not worth it to bother with the equity-only ratio, be aware that for many years the equity-only ratio has given important signals with far better timing than any other broad market ratio—better than any of the index put–call ratios, for example. In fact, there is evidence that the equity-only ratio is the “purest” ratio because there is so little arbitrage in equity options anymore, and most money managers don’t buy equity puts for protection—they buy index puts. Therefore, equity options may represent a better composite picture for contrarians.

The simple put–call ratio follows this formula:

$$\text{“Standard” put–call ratio} = \text{Total put volume} / \text{Total call volume}$$

For example, consider IBM. At the end of the trading day, one would total up the volume on all the individual puts and then divide that by the sum of the volume of all the individual calls. That would be the “standard” put–call ratio for the day for IBM. Some traders may look at intraday ratios, but I haven’t found them particularly useful unless there is massive volume—and usually that is related to a news event, which may dominate the stock’s movement despite what the put–call ratio might be indicating.

The dollar-weighted put–call ratio follows this formula:

$$\text{“Weighted” put–call ratio} = \frac{\sum (\text{Put volume} \times \text{Put price})}{\sum (\text{Call volume} \times \text{Call price})}$$

You multiply each individual option's volume by its price and find the sum of all the puts, then divide by a similar sum of all the calls. To simplify things, you can use closing volume multiplied by closing price; but if you have the horsepower, you could calculate the weighted ratio all day long by summing the volume multiplied by the price at each tick.

The *weighted* ratio measures the *dollars* being spent on puts versus the *dollars* being spent on calls. This is generally a more meaningful figure than just volume alone. Consider this case. Suppose that 1,000 puts trade at a price of 0.10. That's a lot of volume for most option series, but the actual dollars spent here are just \$10,000. Meanwhile, suppose another trade takes place, using a slightly in-the-money option, the kind that a serious speculator would probably use: 100 contracts at a price of 5. That's \$50,000 worth of speculation. So, the first trade carries 10 times the weight of the second one (1,000 contracts to 100 contracts) in the *standard* ratio; but in the *weighted* ratio, the second one, carries 5 times the weight of the first trade (\$50,000 to \$10,000). This is why the weighted ratio is often a more useful contrary indicator—because it measures where people are putting their money.

The data for *this* ratio are difficult to obtain without calculating them yourself. Our company, McMillan Analysis Corp., *does* calculate the data on a number of stocks, futures, and indices and for the equity-only ratio each day. Those data are available to subscribers of our put-call ratio charting services—either “The Strategy Zone” on our web site, [www.optionstrategist.com](http://www.optionstrategist.com), or weekly “Put-Call Charts” by e-mail.

The weighted ratio tends to give more extreme readings and more timely signals. It is, therefore, a preferable ratio over the standard ratio, although the standard ratio gives many excellent signals, too.

Notice that put volume is in the numerator of the preceding fractions. So, bearish activity makes the put-call ratio rise (presumably while the underlying instrument is falling). Conversely, call volume is in the denominator of the fraction, so bullish activity is reflected in low put-call ratios (presumably while the underlying is rising in price).

The ratios themselves can be expressed as a percent or as the absolute ratio. For example, if an equal number of puts and calls traded, then the daily number would be 1.00 (absolute) or 100 (percent). I prefer to use “percent,” as it is more the accepted norm.

It is customary to use a moving average to smooth the data. I use a 21-day moving average almost exclusively, although sometimes a slightly longer-term average, such as the 55-day moving average, can be helpful. A 21-day moving average gives about six to eight signals per underlying instrument per year. Since I am mainly a position trader, this works out well for me. If you want more trades, you could shorten the ratio, but at the risk that you would be subject to a lot of whipsaws.

## Interpreting the Ratios

The concept of interpreting the put–call ratios is an easy one in theory; but in practice, things become a little more complicated. It is an easy matter to say that when the ratio gets “too high,” you should buy the market. Conversely, if the ratio gets “too low,” you should sell the market. Quantifying “too high” and “too low” is where things get tricky. Past experience has shown that static interpretations of the put–call ratios are an incorrect approach, for investors and traders change their investing patterns. Rather, a dynamic approach is best. A dynamic approach means looking for peaks and valleys—at whatever absolute levels they may occur—in the put–call ratio to indicate buy and sell points.

As noted earlier, the standard equity-only put–call ratio ranged from 30 to 55 during the bull market of the 1990s. This led many casual observers to adopt a static approach, saying that buy signals appeared when the ratio reached 53 or 55. True, many buy signals during the bull market *did* occur at that level. However, such a static interpretation will eventually get you into big trouble. Thus, when the bear market started in earnest—in 2000—the equity-only put–call ratio blew right on through the 55 level, eventually reaching highs near 90. If you had bought that last time when the ratio reached 55, you would have been buried under an avalanche of selling as the market transitioned from bull to bear.

Thus, the proper interpretation is to look for peaks and valleys on the put–call chart. Peaks are extremes in put buying and are buy signals for the underlying. Valleys are extremes in call buying and are sell signals for the underlying. Figure 4.26 illustrates this concept



**Figure 4.26**  
**55-DAY INDEX PUT-CALL RATIO**

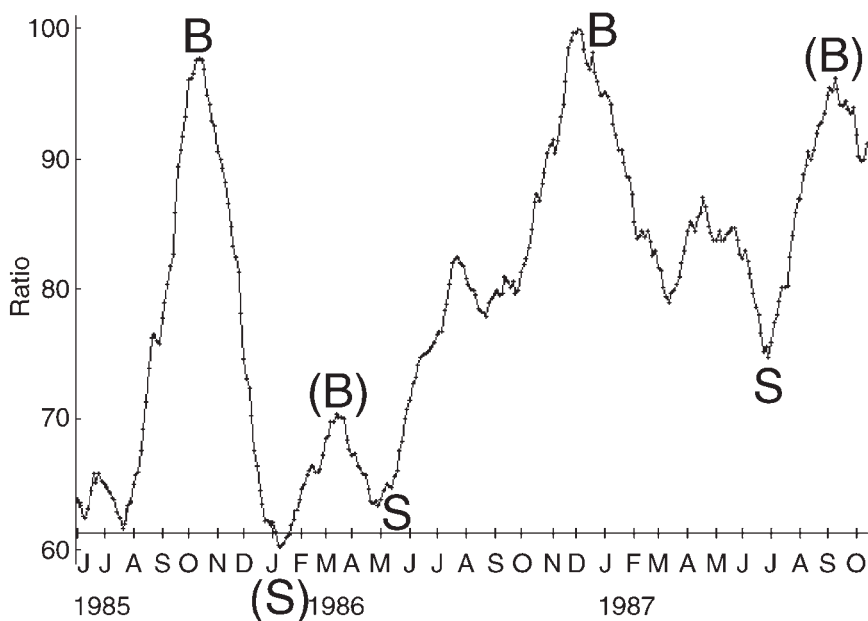

quite clearly. Mathematicians call peaks “local maxima” and valleys “local minima,” but it doesn’t make much difference what you call them as long as you use them properly in your trading. You will see, in all of the put–call charts presented in this chapter, that the dynamic approach is taken in their interpretation. Ideally, the peaks and valleys would occur at extreme levels on the chart, but that is not always possible. It has been my experience that a signal that arises from a severely extreme reading is not necessarily any better than a signal that occurs at a more modest level on the put–call chart.

On a typical day, there are always more equity calls traded than puts, so the equity-only put–call ratio is less than 100. More likely, it is quite a bit below that—more like 50 on most days. However, an *index* put–call ratio will be much higher, if that index’s options are used for hedging, as most of the broad-based indices options are. Typically, one might see the “standard” OEX put–call ratio range as

high as 150. *Weighted* put–call ratios are much harder to pin down and trade in vastly wider ranges that *standard* put–call ratios do. That is one of the advantages of the *weighted* ratio—it registers such violent extremes that it is easier to determine when the public has reached a crescendo of bullish or bearish opinion.

No matter how you state the ratio, its actual level is unimportant. It's much more useful to know its *relative* level. This will become more obvious when actual charts are observed, but consider this. During the bull market of the 1990s, the equity-only put–call ratio ranged, in general, between about 30 and 55. It was as low as 30 at extremely optimistic times, and it was as high as 55 during panic selling times (October 1997 or October 1998, for example). So, sell signals occurred when the public was overly optimistic (at about 30 on the put–call ratio), and buy signals occurred when they were too pessimistic (at a put–call level of about 55). However, when the bear market set in after the turn of the century, there was a lot more put buying on a routine basis. During the 2000–2002 time period, the equity-only put–call ratio generally ranged between about 55 and 90. Thus, *sell* signals occurred at 55, which was the optimistic reading during those years. In other words, the 55 level, which had previously denoted buy signals during the bull market, now was generating *sell* signals during the bear market. The moral of this story is *do not use fixed levels to interpret the ratios*—and avoid the advice of anyone who tells you to do so.

Let's look at some historical examples. Recall that put options didn't start trading until 1977, and index options until 1983. Therefore, it wasn't until after 1983 that traders had the index put–call ratio and the total put–call ratio available to them. Since there was very little use of index puts as protection in those days, the index ratio was considered to be the best source for the speculative pulse of the market. Moreover, there was a lot of arbitrage in equity options, so the equity-only put–call ratios were somewhat distorted by this arbitrage.

In those days, the index put–call ratio ranged between about 60 and 100 at the extremes, much lower than today's average range. When the ratio rose to near 100, the market could be bought, and when it fell to 60, it could be sold.

In October 1985, the index put-call ratio reached 100, and the market embarked on a huge eight-month rally. OEX moved from 175 to 239 by July 1986. Then, in December 1986, the index put-call ratio reached 100 once again; and the market rallied for another eight months, setting many all-time highs along the way. OEX rose over 100 points in that time. The ratio reached very low levels in March 1985 and April 1986, neither of which was a tremendous sell point; but in both cases the market leveled off and went sideways for several months after each occurrence.

These buy (B) and sell (S) signals, using the intermediate-term 55-day moving averages, are shown in Figure 4.26, while the graph of OEX over the same period is in Figure 4.27.

What happened next made many technicians discard the put-call ratio as a useful indicator. The index put-call ratio (coming off the

**Figure 4.27**  
**OEX DURING 1987**

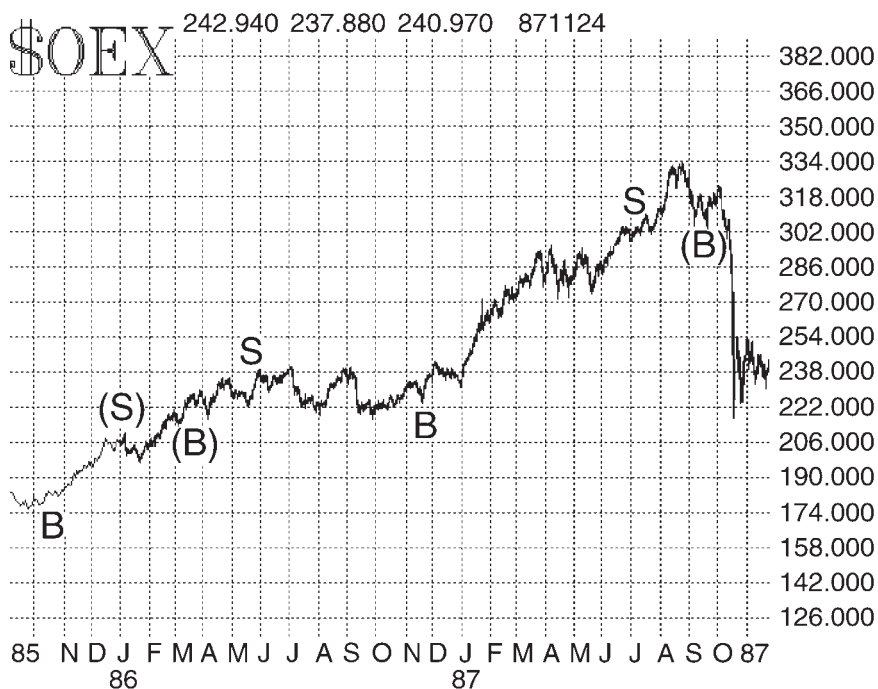

December 1986 buy signal) gave a sell signal in July 1987 (Figure 4.26). You may not think that's so bad, since the market actually peaked in August; but the index ratio began to climb back toward the 100 level by September 1987 and actually gave a buy signal at that point (September 1987). Thus, if you were only paying attention to the *index* put-call ratio, you were long going into the crash of 1987.

The saving grace was that the equity-only put-call ratio also gave a sell in July and remained on that sell signal through the crash and on into early 1988. So even though the equity put-call ratio sell signal was early, it was correct; and it did not reverse before the crash (see Figure 4.28).

Nevertheless, the index signal was a disaster. What had gone wrong? Had the public actually been right? Did they really buy so many puts during the July–September period of 1987 and, therefore, correctly anticipate the crash? I think any one who survived the crash or even read about it knows that the public most certainly did

**Figure 4.28**  
**55-DAY EQUITY PUT-CALL RATIO**

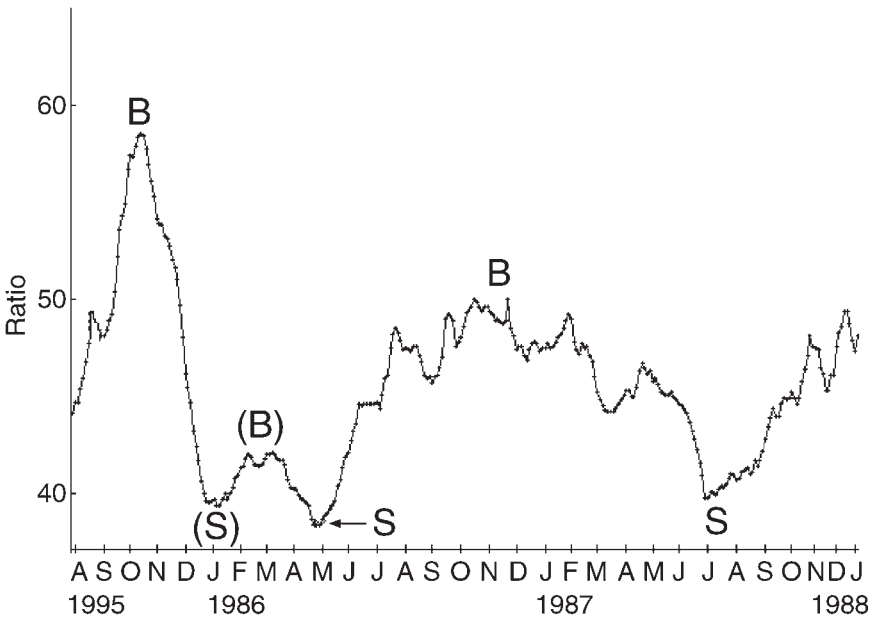

not anticipate it. Therefore, the public was not buying puts before the crash (in fact, you may recall our comments in Chapter 2 concerning how many public customers were actually *selling* naked puts just before the crash).

If you think about it logically, a rising market should always culminate with lots of call buying. The public will always chase a trend, not fight it. That's why contrary indicators work. At the exact top of a market, the public will be displaying its most bullish sentiment. In option terms, that means the public will be buying *calls* heavily at the top of a bull market. By logical extension, then, you would not expect to see *put* buying increase heavily while a market is rising; rather, put buying should increase while a market is falling. Thus, if you do see put buying increasing during a rising market, you should suspect that something besides speculation is behind that increase in put volume.

So why did the put-call ratio shoot up that summer? There is only one plausible answer: institutions were buying puts in order to protect their stock holdings.\* In Chapter 3, we discussed how portfolio insurance played a role in the crash. Those money managers were (theoretically) using futures to hedge their stock positions, but many others were buying index options as protection. So, during the summer of 1987, as the market drove into what was considered by many to be overvalued territory, some institutions took the precaution of buying puts. *This* is what caused the index put-call ratio to accelerate to the upside. Apparently, by late September (see Figure 4.26), the institutional put buying slacked off, and the index put-call ratio began to trend down—a buy signal.

The institutions tend to buy index puts more readily than individual equity puts, because with one large buy order in OEX puts, they can acquire a lot of protection. It would be much more work to buy puts on each stock that they own, to say nothing of the fact that many of the individual equity puts would be so illiquid that the institutions could not even purchase the quantity of puts they need.

---

\*Some analysts may offer another explanation: that the public was selling naked index puts and thus inflating the volume. True, there was some of that going on, and the losses subsequently suffered by those put sellers made front-page news in the financial section. But, in reality, there wasn't enough naked put selling to make a real dent in the overall volume figures. Institutional put buying, however, was significant in terms of volume.

We will never know what happened to all those puts that were bought, of course, but it wouldn't be too shocking to discover that they were puts expiring in October or earlier. Of course, those puts, while useful, expired on October 16, 1987, just before the actual crash on October 19. A less cynical view, of course, would allow that the institutions bought puts expiring in November or December.

As a further example of a put–call ratio giving an erroneous signal to the unseasoned observer, consider what happened in QQQ options in February 2000—at the top of the biggest technology bubble in history. Nothing symbolized the bubble more than QQQ and its options. They were the object of all kinds of speculators. The put–call ratio chart overlaid with the QQQ chart is shown in Figure 4.29. Refer to this during this example.

QQQ was trading up rapidly during the first two months of 2000 and had reached a price of 114 by early March. At the same time, the QQQ *standard* put–call ratios had risen to an astounding level: it was at 750, which means 750 puts were trading for every 100 calls. To some observers, this was a wildly bullish sign—that *that* many puts were trading in comparison to calls. However, to the experienced put–call ratio analyst, this was a signal *not* to be believed; for when the put–call ratio and the underlying instrument are *both* rising rapidly, something is wrong. What was happening here was that the institutions were very worried about the lofty levels of the Nasdaq stocks they owned, and so *they bought QQQ puts as a hedge*.

If any institution is buying puts and buying stocks and buying puts, are they bullish or bearish? No one knows, but we *do* know that such hedging distorts any true contrarian signal we might discern; and so the put–call ratio should be ignored in that case.

To this day, QQQ options remain a favorite hedging vehicle, and so the *standard* QQQ put–call ratio is *not* a useful indicator. However, the *weighted* ratio is useful.

Earlier, we stated that, during the early days of listed index options, the index put–call ratio was considered to be the best measure of speculative activity because there was very little use of puts for protection. Obviously, that situation changed during the summer of 1987. Index puts suddenly became a very popular item among institutions, which tend to have a herd mentality about such things.

**Figure 4.29**  
**21-DAY QQQ PUT-CALL RATIO WITH QQQ OVERLAY**

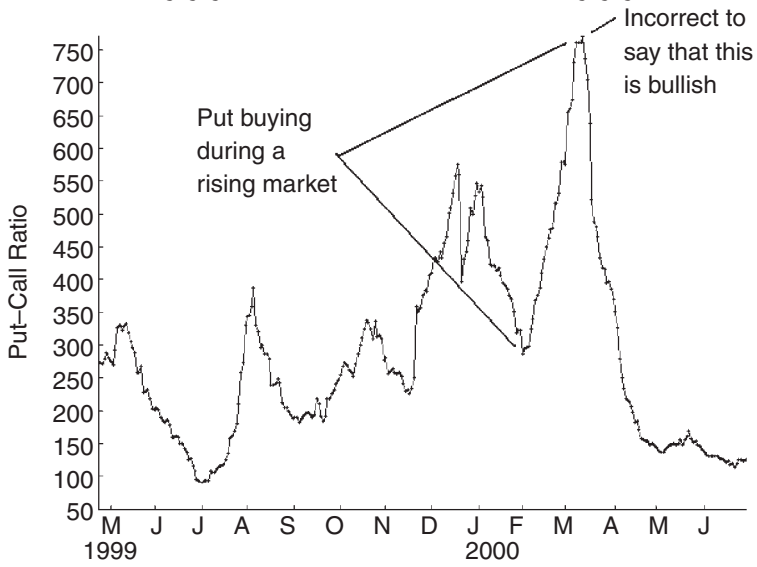

As the theoreticians were convincing some money managers of the viability of using puts, the word was spreading; and many managers rushed in to buy these puts. During the years since then, even more money managers routinely use index puts as a form of protection. This is why the average put-call ratio readings of index options have moved from the 60–100 range in the 1980s up to the 100–130 range in the 1990s and beyond.

Interpreting the put-call ratio as strictly a contrary indicator results from the tacit assumption that most option buying is speculative and can therefore be interpreted by the contrary-opinion theory. In reality, there are other factors at work besides speculation. Index options at first *were* mostly pure speculation, but then they became speculation mixed with protective put buying. Ironically, *equity* option volume in the early 1980s contained a lot of arbitrage activity. That arbitrage activity was so prevalent that it even distorted the NYSE short-interest figures, and technicians had to basically give up on short interest as a means of measuring market sentiment. The equity arbitrage that was so prevalent in the early 1980s has disappeared (because of competitive pressures). Equity-only put-call ratios today are clearly a superior measure of sentiment. In fact, the index (OEX) ratio is not reliable at all in today's environment where institutional hedging with index puts is so prevalent.

Consider the quandary that arises when hedging enters the picture. When we see a lot of index puts being bought while the market is rising, are we to interpret this as bullish because the public is looking for a top in a rising market; or should we figure that the put volume is due to institutional put buying? Almost certainly, it's the latter, for reasons already discussed—the public doesn't get bearish at tops, they get bullish. But, even though he knows the put volume is increasing from institutional activity, the contrarian is still in a difficult situation. What is the institutional manager's true bias? Is he bullish because he still owns stocks, or is he bearish because he is buying puts? This is the bane of contrary analysis—attempting to accurately interpret the data being received.

Before getting to more recent examples, one more historical footnote might be helpful. In the 1980s, the put-call ratios were more or less static, ranging between the same highs and lows. How-



ever, as noted earlier, with the more prominent use of puts for protection, the ratios have crept higher over the ensuing years. This means that a static interpretation (such as “buy when the index ratio gets to 100, and sell when it falls to 60”) is irrelevant. In the late 1980s and early 1990s, however, some technicians were still trying to stick with their old, static measures and were especially hurt by the minibear market of 1990. In that year, the ratios were trending higher, so static interpreters bought the market when the ratios reached their old, (un)reliable buy zones. This got them long too early and created even more bad publicity for the put–call ratio as a technical indicator. Feature articles were written about the fact that the put–call ratios just didn’t work anymore.

They still work, but you must interpret them dynamically—looking for local maxima and minima as buy and sell points—and not rely on fixed numbers. In fact, a true contrarian likes to see a poor signal publicized from time to time. It keeps the average “Joe” away from contrary analysis. If everyone became contrarians, then what would happen? Contrary analysis would cease to work, of course. By the very nature of the market, what the majority is doing at extremes is wrong. If the majority is behaving as contrarians, then the market will adjust for that and make *them* wrong. So I like it when people try to point out that contrary analysis doesn’t work (it does, of course, but don’t tell too many people).

You will never again see the 50-day moving average of the index put–call ratio down to 60, even if the market goes straight to the moon. The following charts contain several examples of buys and sells occurring at differing levels; however, each of those buys and sells is a turning point in the trend of the ratio (a peak or a valley). This, then, is the *proper* way to interpret the put–call ratios.

In the next few pages, we will look at two detailed examples of using the equity-only put–call ratios—both standard and weighted—to predict intermediate-term trends in the broad market. The first example begins in the summer of 1999. Figure 4.31 shows the OEX during this time period. At that time, the broad market had rallied to new highs in July, fell back during a rather sharp decline into October, then rallied in two stages to the market’s all-time high in March 2000 before succumbing to ferocious selling in April, which led to a bottom in May 2000.

We will examine how the equity-only put-call ratios performed as broad market indicators during this time. On each of these charts, the letters “a” through “e” represent buy signals, while the numbers “1” through “4” are sell signals.

First, consider the *standard* ratio, shown in Figure 4.30. The first marked signal is denoted by the letter “a” in the middle of June 1999. This is a buy signal because the put-call ratio formed a *peak* at that time. Even though it comes at a fairly low level on the chart—about 44 (meaning 44 puts traded for every 100 calls)—it is still a valid signal. Prior to that, the *trend* of the put-call ratio had been upward. Then the trend reversed—to downward. That is the dynamic definition of a buy signal. At the end of this chapter, we will discuss how to spot these trend changes at the time they are occurring. From Figure 4.31, you can see that the buy signal, “a,” occurred at approximately the 660 level on OEX. A substantial 70-point rally followed in OEX, taking it up to 730. So even though the signal came from a level that was not extreme, it was still a powerful signal.

**Figure 4.30**  
**STANDARD PUT-CALL RATIO**

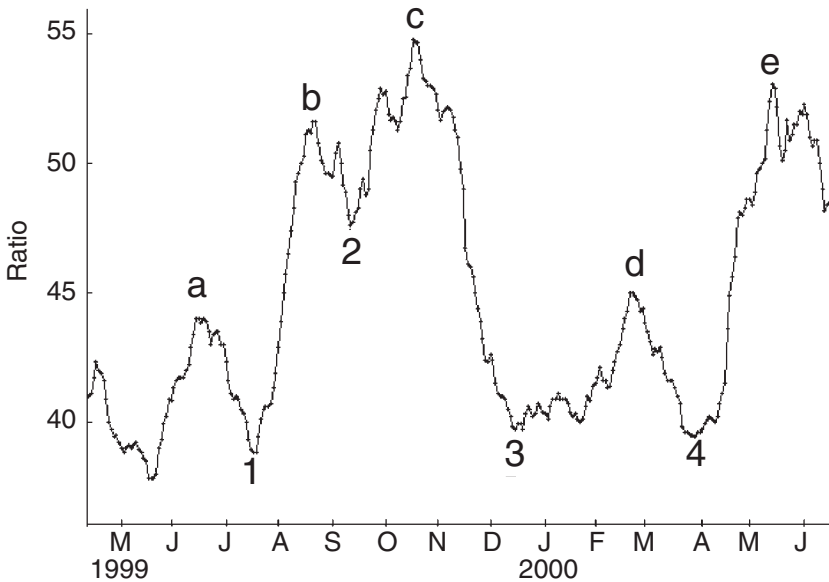

**Figure 4.31**  
**\$OEX: 1999-2000**



As the market moved higher, call buying followed, driving the standard put-call ratio down to point “1” (Figure 4.30) in July 1999. At that point, the call buyers ran out of steam, and the ratio reversed upward. This is the definition of a sell signal. You can see from the OEX chart (Figure 4.31) that it was well-timed and identified a decline in OEX from about 730 to 670—another worthwhile trade.

During *that* decline, put buying started to accelerate, and the standard put-call ratio rose all the way to about the 52 level before peaking in late August 1999—another buy signal (“b” on the charts). This signal was a little late, and the ensuing OEX rally was rather modest but still tradeable.

After this buy signal occurred, the put-call ratio began to decline, as it should. However, it wasn’t long before the put-call ratio reversed again and gave a sell signal (point “2” on the charts). Once

again, this was a signal that did *not* come from an extreme level on the chart (extreme-level sell signals would occur at the *bottom* of the chart). Yet once again, it was an excellent signal, as it foreshadowed a decline all the way down to the 650 level of OEX.

This steeper decline came during October 1999—and traders were mindful of the disastrous Octobers of the two previous years—so a put buying panic of sorts set in, driving the standard put-call ratio all the way up to point “c” at the 55 level (Figure 4.30). Careful observers will notice that there was a little “wobble” in the put-call ratio in early October. That might have been considered a buy signal in real time, although it was quickly reversed. This is a good time, then, to discuss what is the equivalent of a “stop” for the put-call ratio trader. If you take a signal and then the ratio subsequently reverses direction, you should stop yourself out of any position you have taken. In this case, if you had bought calls when the put-call ratio appeared to be turning down in early October, you would stop yourself out when it turned back up in mid-October. The ultimate buy signal came later, at point “c.”

The buy signal generated at point “c” was a tremendous one, as OEX rallied nearly 150 points by December. While that was occurring, note that the *standard* put-call chart was declining rapidly all along, as traders bought calls more and more heavily. During this time, call buying was very extreme, but that does not matter to the interpretation of the put-call ratio. One must wait for the call buying to exhaust itself—for the trend to change. That finally occurred at point “3” after the ratio had fallen dramatically from 55 to 38.

At that point (“3”) it reversed into another sell signal. This was another decent signal, as OEX fell about 80 points to 720 during January and February 2000 (Figure 4.31). Put buying didn’t really accelerate much during that decline, though; and the ratio had only reached the 45 level (point “d”) before it reversed downward, generating another buy signal.

Once again, it was important to trade this signal, even though it didn’t occur at an extreme level. The buy signal at point “d” preceded the final, volatile run to all-time highs, with OEX exceeding the 840 level in March. While that was occurring, the put-call ratio fell once again to the 39 level and reversed, generating a sell signal (point “4”).

At the time, of course, no one knew that this would be the top of the market for years to come. It is worth noting that the put–call ratio didn’t fall to some ridiculous level, such as 10, at this important top. It *did* give a sell signal, of course, and that’s what’s important—not the absolute level.

No one really knew that the market was transitioning into a bear market at this point, but that’s what was happening. OEX began to decline modestly, and then disaster struck in mid-April as the Dow fell 700 points in one day and Nasdaq was down 500. It turns out that George Soros had decided to dump his tech stocks, and that’s what caused the massive decline. That was a prescient sell by Soros, of course, and it had a lot to do with changing the complexion of the marketplace. After that panic selling, the market rebounded somewhat, but traders continued to load up on puts. This heavy buying of puts forced the put–call ratio all the way back up to 54, before a buy signal occurred at point “e” in late May.

In the wake of the severe bear market that followed, most traders don’t remember that there was a substantial rally in the summer of 2000—one that began at that May bottom and carried OEX all the way back up to 830, nearly back to its all-time highs.

Thus, there were nine signals generated during this time period by the standard equity-only put–call ratio, and all were well-timed and preceded good-sized moves by OEX. Even if one didn’t pick up on the signals at the exact time they occurred, OEX moved far enough to allow for good profits anyway, since they were of intermediate-term length.

The weighted equity-only put–call ratio is shown in Figure 4.32. Let’s now examine how *this* ratio behaved over the same time period. Without going into as much detail, one can see that the first four signals—a, b, 1, and 2—all occurred at virtually the same time as the standard ratio’s signals. When one is using these put–call ratios as a trading guide, this is important confirmation—that both the standard and weighted ratios agree.

The next signal in Figure 4.32, “c,” occurred in early October on the weighted chart. This was a little early, but it eventually worked out. The next signal, the sell signal at point “3,” was better timed than the standard ratio’s signal; it came at virtually the end of the

**Figure 4.32**  
**WEIGHTED EQUITY-ONLY PUT-CALL RATIO: 1999-2000**

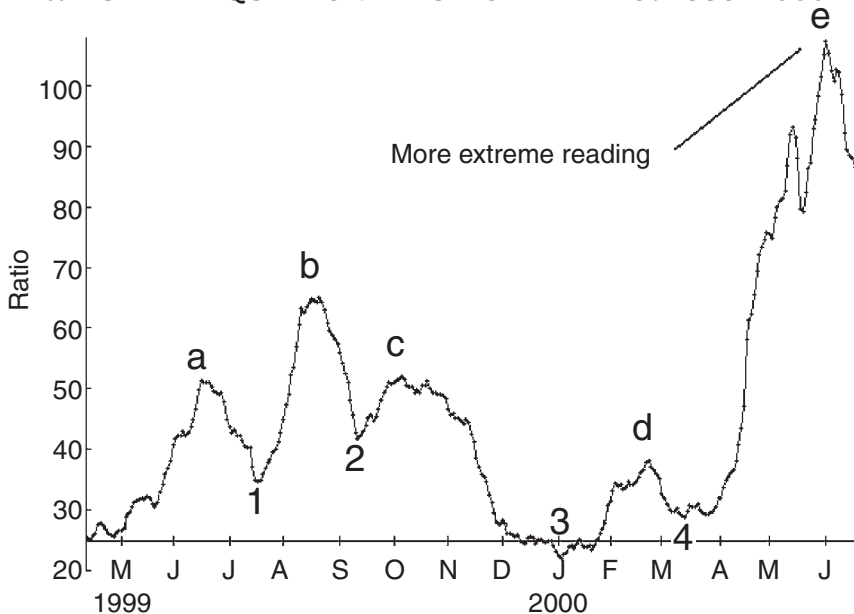

year, coincident with OEX topping out. Signals “d” and “4” were timed about the same as the standard ratio.

However, the next signal, “e,” shows the true worth of the weighted ratio. As was mentioned earlier, the weighted ratio often moves to more extreme levels than the standard ratio does. This is what occurred in April and May of 2000. After Soros dumped his stocks and panic set in, traders were not only buying a lot of puts (volume) but spending a lot of dollars on them, as they evidently were no longer just buying deeply out-of-the-money puts as protection, but had started buying more at-the-money puts as downside speculation. This heavy spending on puts drove the *weighted* ratio up to its highs in Figure 4.32—over the 100 level (which means more money was being spent on puts than on calls). This extreme point on the weighted chart is definitely a wake-up call to make the trade.

Not only that, but if one compares Figures 4.30 and 4.32 closely, one can see that the weighted ratio’s buy signal at point “e”

arrived in late May, whereas the standard ratio's signal came earlier in May. The weighted signal was better timed. This is typical of the weighted ratio's signals—often coming from more extreme signals and often being better timed.

It was briefly mentioned before that an at-the-money option is probably the best choice for trading these signals. Of course, that is a general statement and could be refined in many ways. But it is essentially correct. Since put–call ratios are sentiment-based signals, they can be wrong (as can any indicator), and they may not be perfectly timed. We saw in the previous examples that sometimes the signal occurred a couple of weeks early. So the best approach when trading these equity-only put–call ratio signals is to buy a broad-based index option that is at- or maybe just slightly in-the-money. It could be a call on OEX, SPX, or DJX. I wouldn't recommend using any other indices to trade these equity-only signals. Of course, now that Exchange Traded Funds (ETFs) are available,\* one could trade those as well: SPY (S&P SPDRS), OEF (the ETF that mirrors OEX), or DIA (Diamonds, which mirror the Dow Jones industrials), or even the S&P or e-mini futures. The important point is to stick with those major indices.

I would like to include one more example—one that shows how the put–call ratios behaved as the bear market of major proportions set in. Figures 4.33 and 4.34 show the standard and weighted equity-only ratios, respectively, from about the middle of 2001 through the middle of 2002. In both figures, an unscaled chart of OEX is shown *above* the put–call ratio. This allows one to see how the market was behaving at the time of the signals.

This example won't be discussed in much detail, but it will be used to make two very important points: (1) that the put–call ratios can rise to extremely high levels during a bear market and (2) that a trader sometimes has to use some logic when interpreting the ratios.

---

\*Exchange Traded Funds are created by holding in trust the actual shares of stock that comprise an index or a sector index, thus creating a "fund." Shares of the fund are listed on a major exchange—usually the NYSE or the American Stock Exchange (AMEX)—and the index can be traded in the same way that shares of individual stocks can be traded.

**Figure 4.33**  
**STANDARD EQUITY-ONLY PUT-CALL RATIO**

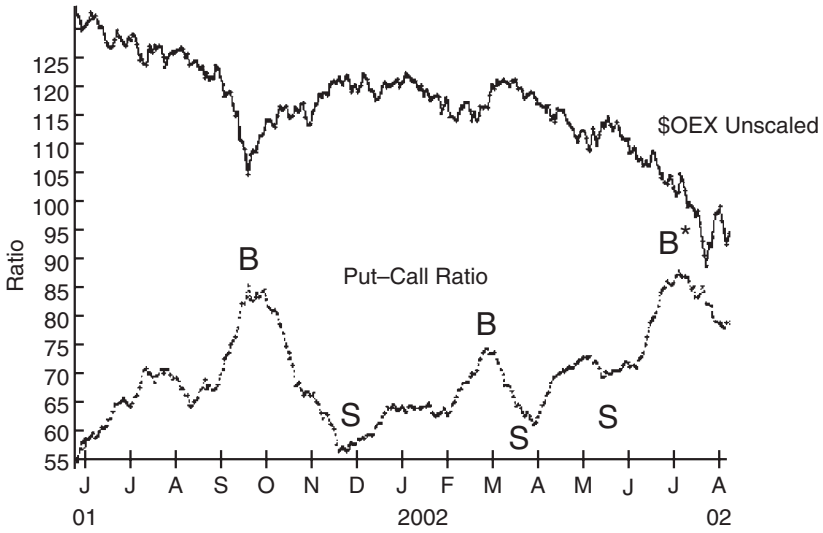

\* Put volume still rising.

**Figure 4.34**  
**WEIGHTED EQUITY-ONLY PUT-CALL RATIO**

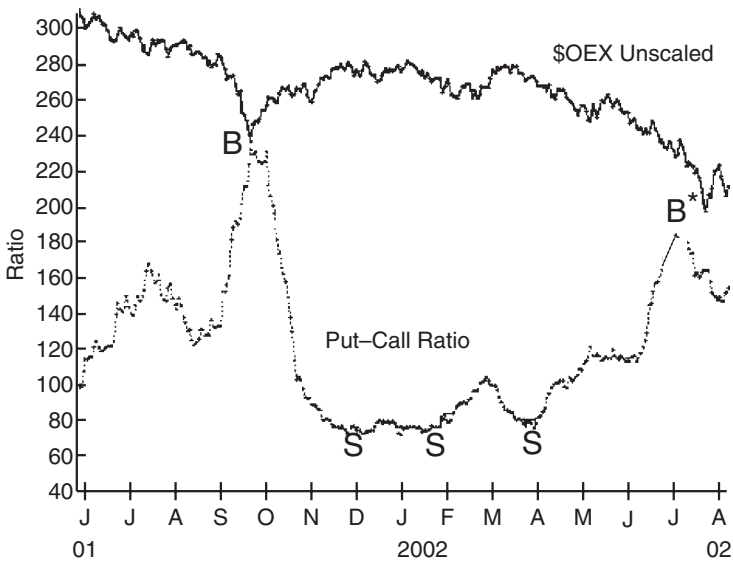

\* Put volume still rising.



Both figures begin with the summer of 2001. The market (OEX) declined slowly in June and was rather flat in July. Bullish analysts thought that this dull period was positive—that the market would soon turn upward. However, as you can see, the put–call ratios were moving higher during this time. The standard ratio finally blasted through the bull market highs at 55 and reached 70 by mid-July. At that point, around July 1, there was actually a short-lived buy signal, but it turned back to a sell signal in early August. About that time, the market began to fall steadily, and the put–call ratios resumed their upward march. By September 1, the standard ratio was up to 75, and both ratios were seeing heavy increases—heavy put volume and dollar volume.

A week and half later, the terrorist attack occurred on September 11. In the aftermath, the market collapsed, and the put–call ratio ballooned to all-time highs (the standard ratio eventually exceeded those highs later in 2002 and again in 2003, but the weighted ratio never has been that high again). The put–call ratios gave accurate buy signals right near the bottom of one of the most panic-filled declines in history.

After that, there were repeated sell signals during the fall of 2001 and spring of 2002. But skip forward to July 2002, for that is where something very unusual occurred—but it is something that we were able to discern while it was happening, and it could happen again. In Figures 4.33 and 4.34, you can see that *both* equity-only put–call ratios gave buy signals right about July 1, 2002. These were woefully premature, as the market plunged that July, in one of the largest selling waves in memory. What had happened? Why were these signals so wrong?

First, let me point out a general rule that will always serve you well when interpreting put–call ratio charts of any type: don't fight a price trend just because the put–call ratio gives a signal. Wait for some technical confirmation from the underlying: perhaps just a higher-high, lower-low sort of pattern or an upward penetration of the 20-day moving average—anything to indicate that a steep downtrend might be ended. In *this* case, since the market was virtually collapsing in July 2002, we did not actually buy anything, even though the put–call ratios gave buy signals.

But the bigger of the two questions is, “Why?” To answer that question, think about what causes a put-call ratio to decline—and, thus, give a buy signal. Typically, the ratio is high because put buying is rampant; and then when the put buying wanes, the ratio begins to fall and a buy signal is issued. However, since the put-call ratio is a fraction, there is another way that the put-call ratio could decline: call volume could increase (call volume is in the denominator of the fraction and would thus cause the ratio to decline). It is rare for this to happen because the public would not be thinking about buying calls as the market was in the midst of a major panic decline, as it was in July 2002.

So what did happen? As it turns out, option premiums were sky-high at the time, which—as we’ve already seen earlier in this chapter—is what happens when the market declines rapidly. However, the decline in the summer of 2002, coming after more than two years of bear market, had changed the fabric of investors. Several large investment houses began telling their clients to sell covered calls because the calls were so expensive. And so they did. Thus, call volume increased and made the put-call ratio fall. Hence, the premature buy signals occurred.

We were able to discern what was happening within a week or so. On detailed examination, we saw that both put volume and call volume were increasing during early July 2002—put volume because traders were panicking and buying puts; call volume because stock owners were selling expensive calls against their stock. Armed with that information, we decided to watch put volume only as a criterion for the buy signal. Sure enough, put volume itself peaked near the end of July, which was the actual market bottom. So, in the future, when you have a rapidly declining market and an apparent buy signal emanates from the put-call ratios while the market is still plummeting, use put volume as an aid in selecting the actual buy point. When put volume decreases, that should mark the bottom.

Finally, in concluding this section on index put-call ratios, it should be noted that there are other broad-based index put-call ratios that can be useful in trading the market—although they are not as reliable nor as important as the equity-only ratios. These include the OEX weighted ratio (*not* the standard), the QQQ weighted ratio

(again, *not* the standard), and the S&P 500 futures put–call ratios (*both* standard and weighted are good in this market). Occasionally, I will also look at things like the NDX weighted ratio, the SPX ratio, the DJX ratio, the DIA ratio, and so forth; but those are very minor ratios, and I would not use those as primary indicators.

## Sector Index Options Put–Call Ratios

Put–call ratios can be used in a similar manner for the more liquid sector options. Since sector options are quite a bit less liquid than OEX options, you would expect the signals to be less accurate—and they are—but they are still quite useful most of the time. At the time this book was written, the following sectors were responding best to put–call ratio signals. The index symbol is given in parentheses (we use a dollar sign to denote that it’s an index):

Banking (\$BKX)	Russell 2000 (\$RUT)
Japan (\$JPN)	Semiconductor (\$SOX)
Morgan Stanley High Tech (\$MSH)	Utility (\$UTY)
Nasdaq-100 (\$NDX)	Gold & Silver (\$XAU)
Oil Service (\$OSX)	Natural Gas (\$XNG)
Pharmaceutical (\$DRG)	Oil & Gas (\$XOI)

The categories represented in the preceding list are fairly self-explanatory. Specific details of the components of each sector index can be obtained from the web site of the exchange where they are traded—generally the CBOE ([www.cboe.com](http://www.cboe.com)) or the AMEX ([www.amex.com](http://www.amex.com)). These sector indices are similar to the broad market indices in that they don’t actually exist—an investor can’t buy shares of \$SPX any more than he can buy shares of \$SOX. However, he can buy options on these indices. He can also, in many cases, buy ETFs, which mirror the performance of the index.

Exchange-traded funds, in fact, may have listed options of their own. This is particularly true of HOLDRS (which trade on the AMEX and are unit trusts comprised of shares of stocks in a similar sector) and many iShares (ETFs listed by Barclay’s Global Investors ([www.ishares.com](http://www.ishares.com)), which can be found on a large variety of indices and sectors. For example, many of the Russell or Wilshire indices

(Russell 2000 Growth or Value, for example) are exchange-listed in the form of iShares, and many have listed options. While the liquidity of the options on most of these ETFs is small, they are useful in trading signals from the index options themselves.

Let's say that you spot a put-call ratio buy signal on the Morgan Stanley High-Tech Index (\$MSH). The index itself might be traded at 500, and an at-the-money option might cost 20 points (\$2,000) or more. For more volatile indices, like the \$SOX, at-the-money options have sometimes cost 50 or 60 points during highly volatile times. For most ordinary investors, these options are too expensive—in terms of price, not necessarily in terms of implied volatility—to be useful trading vehicles. The bid-asked spreads are wide on them, and it's hard to buy a large enough quantity to be able to manage the position properly (by taking partial profits, for example).

However, the sector options *do* give good signals. Consider Figure 4.35, the graph of the \$MSH put-call ratio overlaid with an

**Figure 4.35**  
**\$MSH PUT-CALL RATIO**

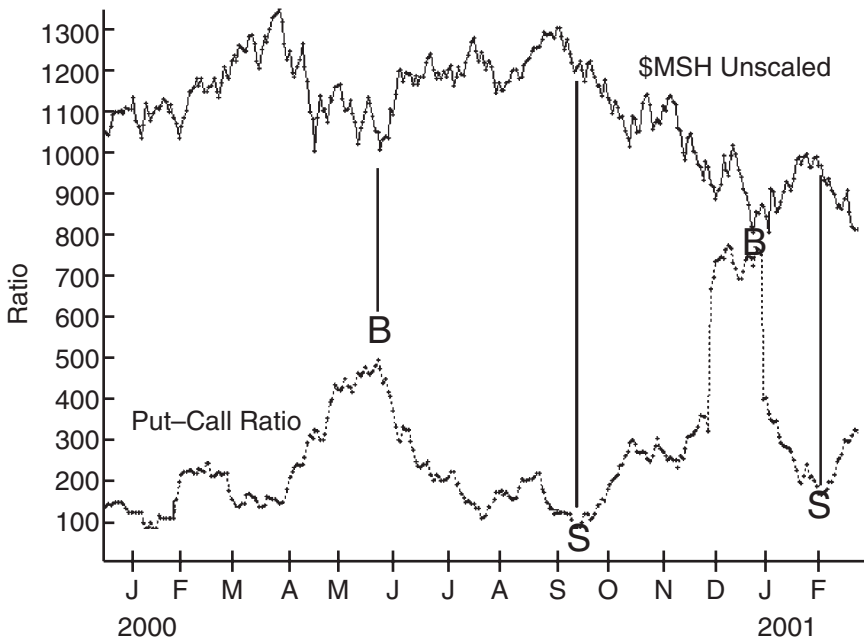

unscaled chart of the \$MSH itself. You can see that the put–call chart is interpreted in the same way—peaks in the put–call ratio are buy signals for the underlying index, while valleys in the put–call chart are sell signals for \$MSH. Two of each are marked on the chart in Figure 4.35.

But how shall we trade these signals if we don't have the kind of money required to buy such high-priced at-the-money options? Usually, we can find an ETF that mirrors the behavior of the index and trades at a much lower price, and that ETF may well have options, too. In this case, the Nasdaq-100 Tracking Stock (QQQ) behaves much like \$MSH. Consider Figures 4.36 and 4.37 to verify that the two graphs have almost identical shapes.

In fact, there is a companion ETF for any of the indices listed earlier and for many more as well. Following are the companions for the ones we listed as the “best” sector put–call ratios to trade. We prefer to use the weighted ratios when trading these, but the standard ratios have been fairly successful as well.

<i>Sector/Index</i>	<i>Companion ETF</i>
Banking (\$BKX)	Regional Bank HOLDERS (RKH)
Japan (\$JPN)	(None)
Morgan Stanley High Tech (\$MSH)	Nasdaq-100 Tracking Stock (QQQ)
Nasdaq-100 (\$NDX)	Nasdaq-100 Tracking Stock (QQQ)
Oil Service (\$OSX)	Oil Service HOLDERS (OIH)
Pharmaceutical (\$DRG)	Pharmaceutical HOLDERS (PPH)
Russell 2000 (\$RUT)	Russell 2000 iShares (IWM)
Semiconductor (\$SOX)	Semiconductor HOLDERS (SMH)
Utility (\$UTY)	Utility HOLDERS (UTH)
Gold & Silver (\$XAU)	(None necessary—\$XAU is low-priced)
Natural Gas (\$XNG)	(None)
Oil & Gas (\$XOI)	Oil iShares (IYE)

**Figure 4.36**  
**\$MSH WEIGHTED PUT-CALL RATIO**



**Figure 4.37**  
**NASDAQ-100 TRADING STOCK (QQQ)**



## Using Put-Call Ratios to Trade Individual Stocks

Put-call ratios can be used on individual stocks. This is a change in my thinking since the first edition of this book was published; but I have come to the conclusion that as long as the stock is highly liquid and there are no takeover rumors (or other fundamental reasons that would influence the option volume), then the ratios can be used for profitable sentiment-based trading. If weighted ratios are available, that would be even more preferable.

Let's begin by looking at one of the most liquid stocks, Microsoft (MSFT). In the spring of 2000, the Justice Department's antitrust case was being tried, and high-tech stocks were under great pressure from heavy selling by Soros and others. This action led to some good trades based on put-call ratios.

Figure 4.38 shows the chart of MSFT stock from the summer of 1999 to the summer of 2000. Figure 4.39 shows the standard put-call ratio at that same time. There are several buy and sell signals marked on the charts. The first two signals—a buy in June 1999 and a sell about a month later—weren't particularly good signals. This is par for the course where stock option put-call ratios are concerned: they have a lower winning percentage than, say, the equity-only put-call ratio does for predicting the broad market. However, a double or triple buy signal was generated at about the 80 level in the October–December 1999 time period. While it took the stock a while to get moving, it did finally explode to the upside in December—making those most recent buy signals nicely profitable as MSFT moved from 90 to 118.

That December 1999 rally brought all the speculators back in, and the put-call ratio plummeted as they bought calls. Finally, right around the new year, the put-call ratio bottomed and generated a sell signal. It was a profitable signal, too, as MSFT fell from 118 back to the low 90s. One would have probably been stopped out by a trailing stop or by the next buy signal that occurred on about February 1, 2000. This buy signal came from a low level on the chart (about 50); but it was eventually a good one, as MSFT rallied once again—from the low 90s back up to 114. Note that this particular buy signal was premature, as the stock really didn't rally until March 1.

**Figure 4.38**  
**MSFT: 1999-2000**

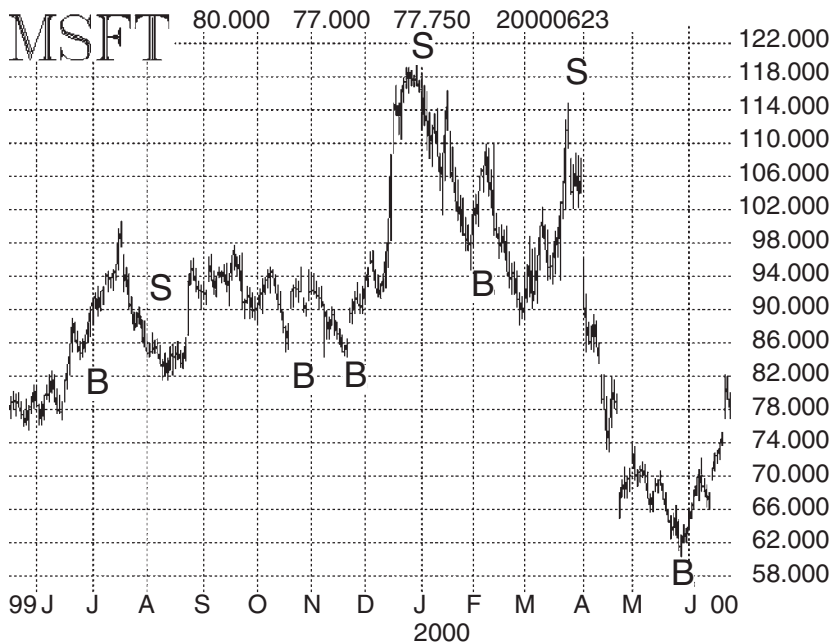

In any case, the most important signals were about to occur. That March rally (while the Nasdaq Composite was making all-time highs) brought in massive call buying; and the put-call ratio fell below 30 in late March, before generating a sell signal. Actually, the sell signal missed the actual top by a little ways, but it did arrive when the stock was still at about 104. At that point, the freefall began, and the stock collapsed to 62.

All the while, puts were being heavily bought, and the put-call ratio rushed back up to the highest level on the chart, 90, in early June 2000. So in just a matter of a couple of months, the public had gone from being the most bullish they had ever been regarding MSFT to the most bearish. This is ideal action for contrarians, and it was accurately reflected in the put-call ratios. At that point (June 2000), the put-call ratio suddenly topped out, as wrong-way specu-



**Figure 4.39**  
**STANDARD MSFT PUT-CALL RATIO**

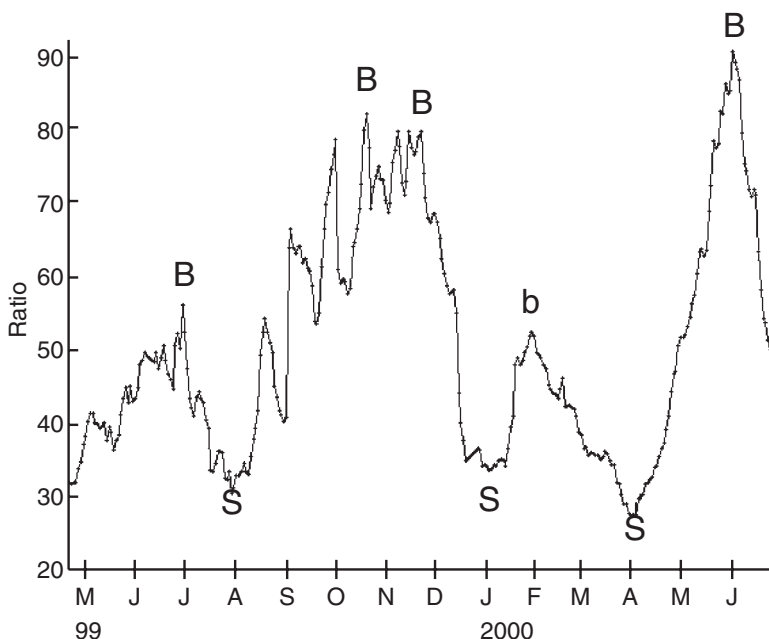

lators had their fill of puts and a buy signal ensued—a buy signal that subsequently saw the stock jump from 62 to 82.

Thus, the standard put-call ratio had delivered four excellent signals, one marginally profitable signal, and two that were probably insignificant (the first two). This is an excellent track record for a stock's put-call ratio. Now, let's look at the same time frame for the weighted put-call ratio (Figure 4.39A).

The one outstanding feature on the weighted chart is the buy signal near June 1, 2000. Bearish sentiment had grown so rampant that the dollar-weighted ratio rose to 320—meaning \$320 were being spent on puts for every \$100 being spent on calls. This was tremendously pessimistic, and it was an alert to traders who follow these sentiment indicators that they should, indeed, pay attention to the next buy signal. As we already know, that rally took MSFT from about 62 to 82.

**Figure 4.39A**  
**WEIGHTED MSFT PUT-CALL RATIO**

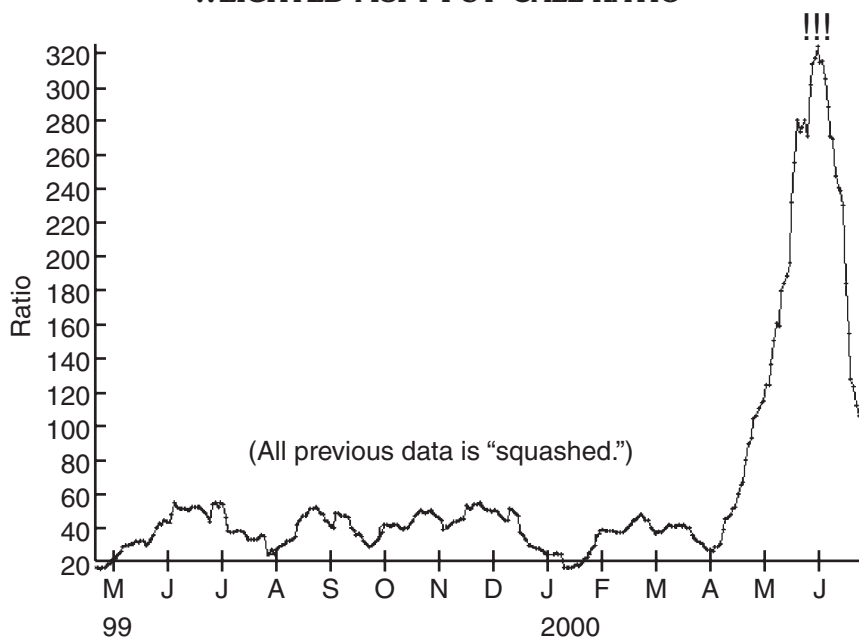

The huge spike in the weighted ratio reduced the previous signals on its chart to nearly meaningless gibberish, since they are all squashed down near the bottom of the graph. In real time, several of them had been excellent signals in their own right; but from this view of the situation, only the extreme nature of the last buy signal stands out. This is another excellent example of how weighted ratios can give more extreme readings and, thus, highlight a tradeable situation more clearly.

These are the stocks that, as of the time of this writing, were the best on which to utilize the put-call ratios for trading:

- America Online (AOL)
- Alliant Technology (ATK)
- American Express (AXP)
- Boeing (BA)
- Citigroup (C)

Cigna (CI)  
Chevron-Texaco (CVX)  
Cisco (CSCO)  
Dell Computer (DELL)  
Walt Disney (DIS)  
Eastman Kodak (EK)  
General Electric (GE)  
General Motors (GM)  
Hewlett-Packard (HPQ)  
IBM (IBM)  
Intel (INTC)  
Johnson & Johnson (JNJ)  
Coca-Cola (KO)  
Lockheed-Martin (LMT)  
McDonald's (MCD)  
3M Company (MMM)  
Merck (MRK)  
Microsoft (MSFT)  
Pfizer (PFE)  
United Technologies (UTX)  
Wal-Mart (WMT)

Of course, other stocks respond well to signals from time to time, but these are the ones that have consistently seen a good track record of signals, especially from the weighted ratios.

One good rule of thumb to follow before making any put-call trade is to look at the signals over the past year and see how many have been profitable. If most have, then that's a good sign to go ahead and trade the next signal. However, there will sometimes be occasions when most of the signals have not been good at all. In that case, I would avoid taking a trade in that issue. Poor signals are often caused by hedging or arbitrage, but they might also be caused by occasional heavy option volume in an issue whose options are normally lightly traded. Any of these can produce bad signals, and they should be readily available when you look at the past year's action.

Let's conclude this section on stock option put-call ratios by looking at another chart to illustrate how the weighted ratio can

sometimes clear up a murky picture by eliminating a lot of “noise” (i.e., bad signals). For this purpose, let’s look at some Intel (INTC) charts from the 1999–2000 period. Figure 4.40 shows the standard INTC put-call chart. Note how many signals there are—too many to trade, really, because one would be lagging each signal slightly. And when there are that many signals grouped so close together, it is apparent that whipsaws and losses would result.

Figure 4.41 is the weighted put-call chart of INTC over the exact same time period. Note how much smoother the graph is. There are only a few signals, as opposed to the helter-skelter nature of the standard ratio. As might be expected, these signals were clearer and produced much better results.

**Figure 4.40**  
**STANDARD INTC PUT-CALL RATIO**

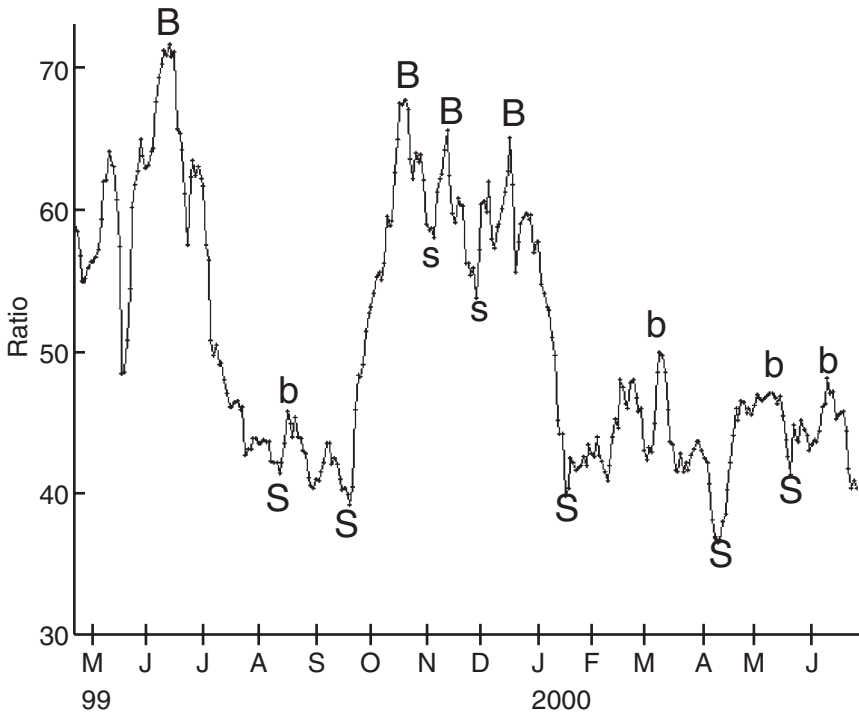

**Figure 4.41**  
**WEIGHTED INTC PUT-CALL RATIO**

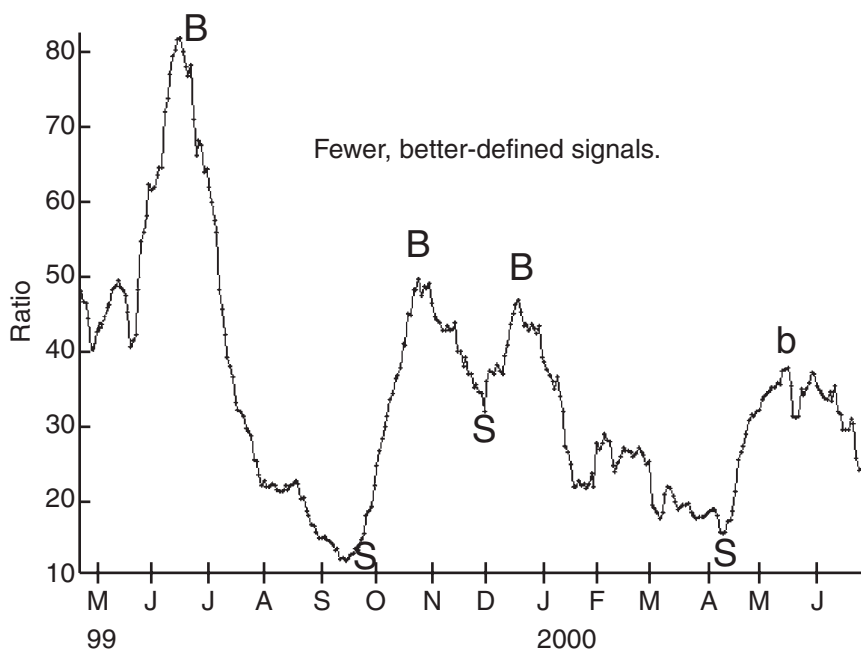

To summarize, put-call ratios can be profitably used on stocks, but you should be mindful of the fact that extraneous factors can cause large volume to occur in stock options and that volume is generally not conducive to contrarian analysis. It is hedging or arbitrage, but is not sentiment-based. Ideally, it would be good to be able to isolate the trading activities of small speculators alone, but that data is not forthcoming; so it is necessary to make adjustments, to see how previous signals have done, and to generally scrutinize the signals before acting on them.

### **Futures Options Put-Call Ratios**

Put-call ratios can also be calculated for futures options. As stated previously, though, it only makes sense to compute such a ratio for

one commodity or set of futures contracts at a time. Thus, to compute the gold futures options put-call ratio, add the put volume for all of the existing gold contracts (February gold futures puts, April, June, August, October, and December, for example). That total would then be divided by the call option volume totaled over the same contracts. The result would be the gold put-call ratio for the day. The number of puts and calls traded is reported, subtotaled by commodity, in the daily newspaper listing of futures option prices.

Since the total volume of gold options traded in a given day is a very small number compared to OEX options or total equity options, you must be a little careful in interpreting the indicator. One or two large orders can distort the gold put-call ratio daily because volume is relatively thin. Thus, rather than interpreting each local maximum and local minimum as a sell or a buy signal, respectively, you may be better served by looking for *extreme* maxima and minima as signals.

Figure 4.42 is a chart of gold's put-call ratio extending from January 1994 through August 1995. You can see that the ratio had an

**Figure 4.42**  
**21-DAY GOLD PUT-CALL RATIO**

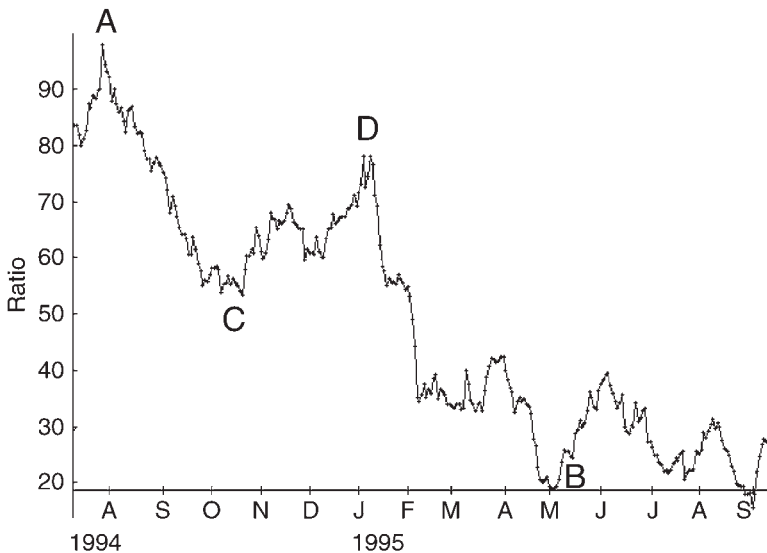

extreme peak near 100 (point A) in August 1994. That was a good buy signal, as gold rallied from about 385 to 410 over the next two months. See the chart of continuous gold futures, Figure 4.43, to verify this.

The continuous charts shown in the remainder of this chapter are constructed by sequentially linking futures contracts and eliminating the gap that occurs between them. For this gold chart, for example, during April and May, the price is that of the nearest June futures. Then during June and July, the continuous price uses the nearest August futures, and so forth. However, the price of each sequential contract is adjusted to eliminate the gap that exists (between June and August futures, for example). Essentially, this chart represents the actual results a trader would have experienced had he bought gold futures in August 1993 and continually rolled to the nearest contract about a month before expiration. The October

**Figure 4.43**  
**CONTINUOUS GOLD FUTURES**



1995 prices (on the right side of the chart) are *lower* than the actual December 1995 gold futures prices. This is reflective of the fact that a trader would have *lost* some ground each time he rolled forward, since the longer-term contracts trade at a premium to the current contract. In a situation where the longer-term contracts trade at a discount to current contracts (T-bonds, for example), the continuous price chart would have a *higher* price in October 1995 than the actual December T-bond futures. We use this continuous price chart to evaluate the signals because it reflects how a trader would have done at any time by trading the most liquid contract over the length of the chart, without artificial gaps in prices.

Back to our example. In May 1995, the put-call ratio reached an extreme low, getting all the way down to 20 (point B). That means that there were five calls traded for every put that traded, on average. That low level is certainly reflective of an extreme bullish opinion on gold. Therefore, by contrary-opinion theory, a sell signal was issued. Gold was much less volatile at that time, but it did manage to decline about \$20.

So, using the extremes seems to work fairly well. But what about the other two significant turning points in the gold put-call ratio (points C and D on the chart in Figure 4.42)? It turns out that these were good signals, also. Point C identifies a sell signal in October 1994. Look again at the chart of continuous gold (Figure 4.43), and you can see that it declined from about 390 to about 355 in January.

Point D on the put-call ratio chart in Figure 4.42 is a local maximum—a buy signal. It worked pretty well, also. Gold rallied from that January buy signal to a high in April (355 to 378, approximately). Then, shortly thereafter, the extreme sell signal of May 1995 occurred.

Gold options trade between about 5,000 and 20,000 contracts a day normally, but occasionally volume is above that range. As options go, that's not a lot of contracts. In fact, a large wholesaler or institutional account could probably dominate the volume on any given day. Whether they would be active enough to dominate it for 21 days (the length of the moving average that we are using) is unlikely, but still possible. That's why we usually prefer to stick with only extreme readings as signals. However, you can see from the preceding charts that even the intermediate readings (points C and D) can also present



good trading opportunities. However, I would still caution you to be a little more careful with the intermediate readings.

Since each futures option market is more or less a separate entity, we have taken extensive looks at each one over time in order to determine whether the put-call ratio is a useful indicator. The low-volume markets are the easiest to eliminate. These include cocoa, the U.S. Dollar Index, copper, orange juice, the CRB Index, and T-bills. *Avoid these contracts, as far as the put-call ratio indicator goes, because the volume is just too low to give meaningful signals.* If volume should increase in any of these contracts in the coming years, then that assessment may change.

There are other contracts where the put-call ratio seems to have no correlation to the price movement of the underlying futures. These should be avoided as well. Avoid corn, soybeans, wheat, crude oil, heating oil, and unleaded gas. For whatever reason, the maxima and minima on the put-call ratio—even at the extremes—do not correspond very well at all with buy and sell points for these futures. Perhaps the option volume is dominated by true hedgers; that's usually what distorts the put-call ratio. In any case, we would *not* recommend trading these contracts with put-call ratio signals.

Now that we've eliminated those, let's discuss more profitable ones. As noted earlier, gold futures can be profitably traded with the put-call ratio. Another of the best is live cattle. Figures 4.44 and 4.45, respectively, show a composite chart of live-cattle futures over that same time and the put-call ratio for live cattle over the past couple of years.

Note how well the local maxima and minima—marked as buys (B) and sells (S)—correspond with the similar points marked on the price chart. At least over this time period, the put-call ratios seem to remain fairly stable. Buys have originated with the ratio in the 110-to-130 area, and sells in the 75-to-85 neighborhood.

Another very good futures contract to watch for put-call ratio signals is T-bonds. The charts of T-bond (continuous) futures prices and put-call ratio are shown in Figures 4.46 and 4.47. The buys and sells are marked on both charts, so that you can see how they correspond. Note that this is another futures contract where *all* the local maxima and minima can be used as sell and buy signals.

**Figure 4.44**  
**CONTINUOUS LIVE-CATTLE FUTURES**

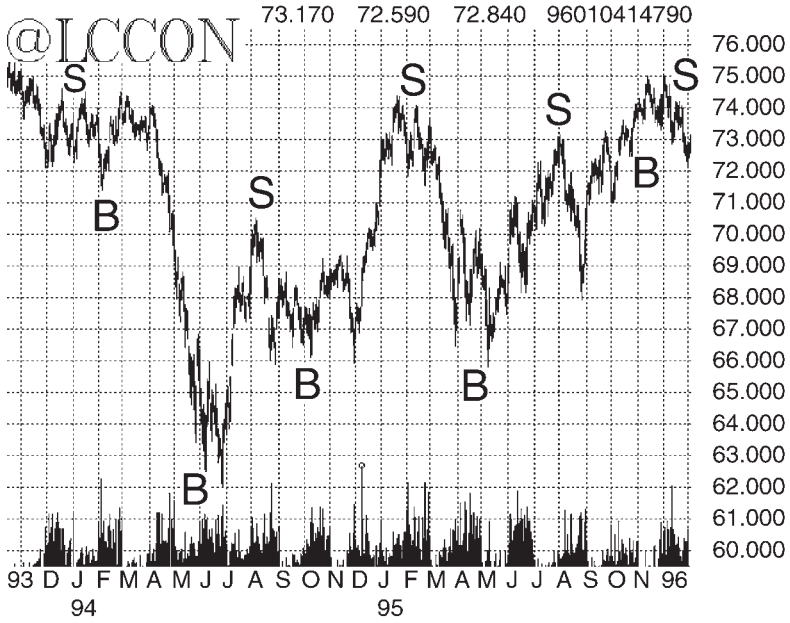

**Figure 4.45**  
**21-DAY LIVE-CATTLE PUT-CALL RATIO**

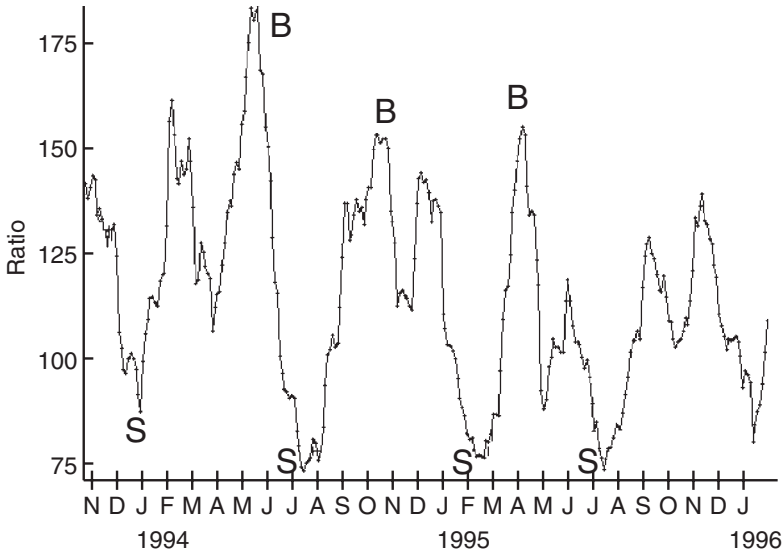

**Figure 4.46**  
**CONTINUOUS T-BOND FUTURES**

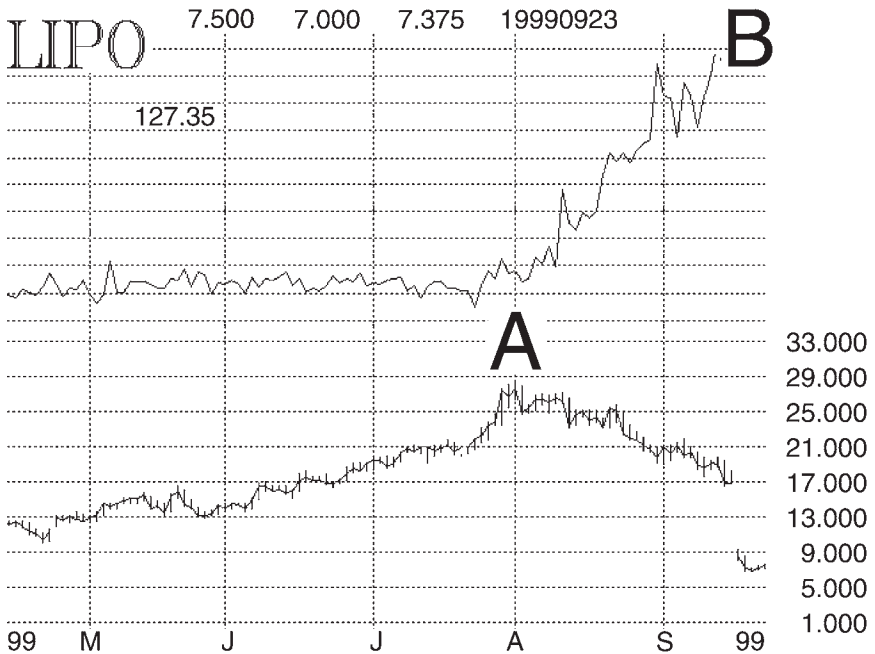

Over the time period shown, the sell signals generally originated with the put-call ratio in the 110-to-130 area, and the buy signals in the 70-to-80 area. Not every signal was a winning trade, but the vast majority of them were winners.

Another contract that can be traded well using the put-call ratios is the S&P 500 futures contract (see Figure 4.48). This is something of a duplication of the index put-call ratio signals given by OEX options, but the two can be used as a confirmation of each other. The put-call ratios for S&P 500 futures options are much higher than the ratios for OEX options, indicating that more puts routinely trade in this market. Nevertheless, the signals have been reliable.

The next group of futures contracts that we look at have less reliable signals than those just presented. These include sugar, coffee, cotton, live hogs, and natural gas. In general, the put-call ratios on

**Figure 4.47**  
**21-DAY T-BOND PUT-CALL RATIO**

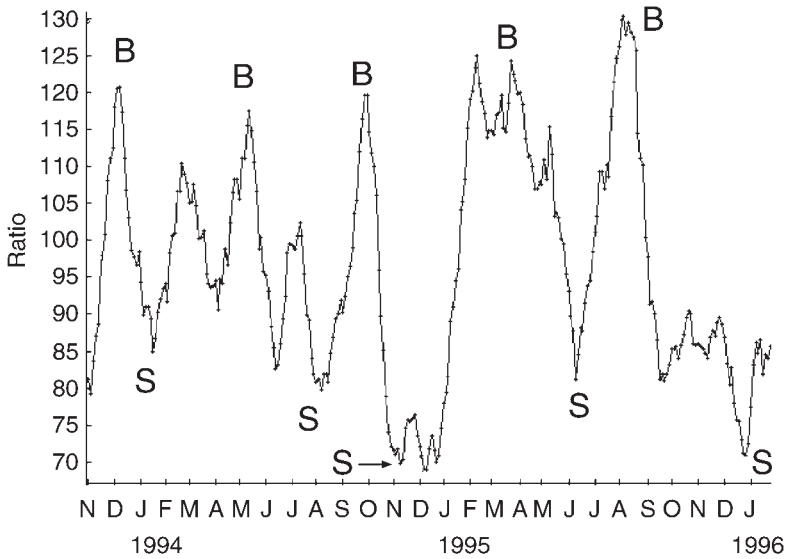

**Figure 4.48**  
**21-DAY S&P PUT-CALL RATIO**

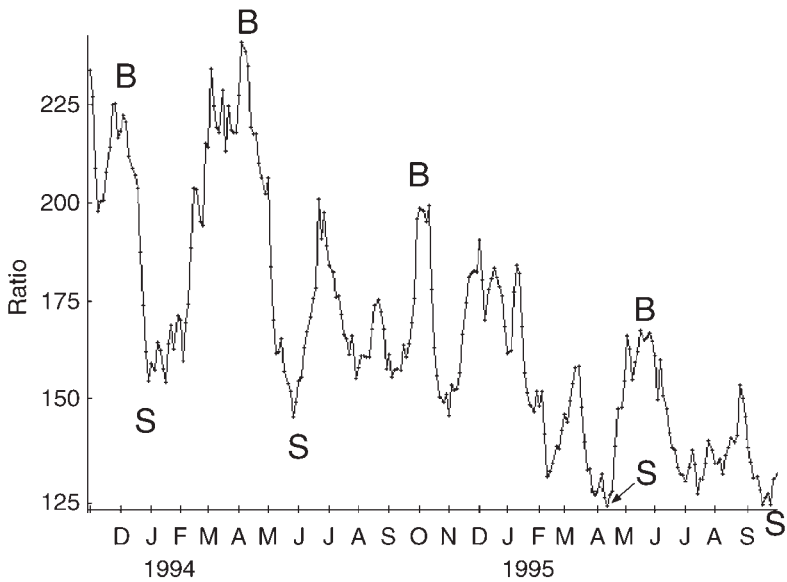

these five give pretty reliable signals. But the percent of winning signals is lower than gold, cattle, S&Ps, or T-bonds.

The only signals in sugar that are worth using are the extremes: either buys with the ratio well over 100 or sells with the ratio under 50. Local maxima and minima at intermediate levels have not proved to be reliable in sugar over the length of time shown in Figures 4.49 and 4.50. The best signal was the buy signal in October 1994, when the put-call ratio had risen to its highest point on the chart—110. Anytime the sugar put-call ratio exceeds 100, you should be looking for it to roll over and give a buy signal. The varying sell signals were much more modest in nature, but each was somewhat profitable.

Coffee is another commodity that has had some very profitable moves on the back of put-call ratio signals. The put-call ratios

**Figure 4.49**  
**CONTINUOUS SUGAR FUTURES**

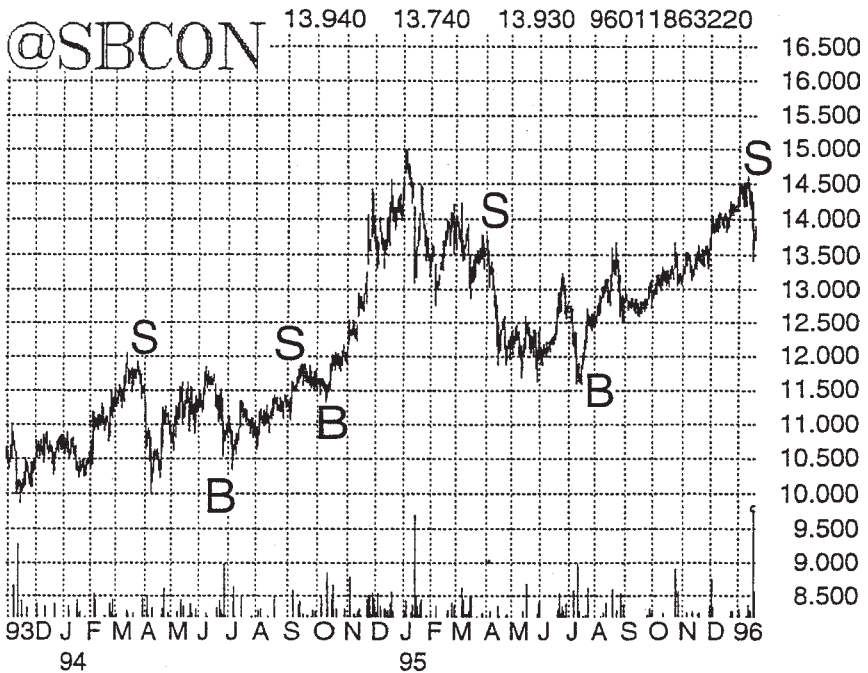

**Figure 4.50**  
**21-DAY SUGAR PUT-CALL RATIO**

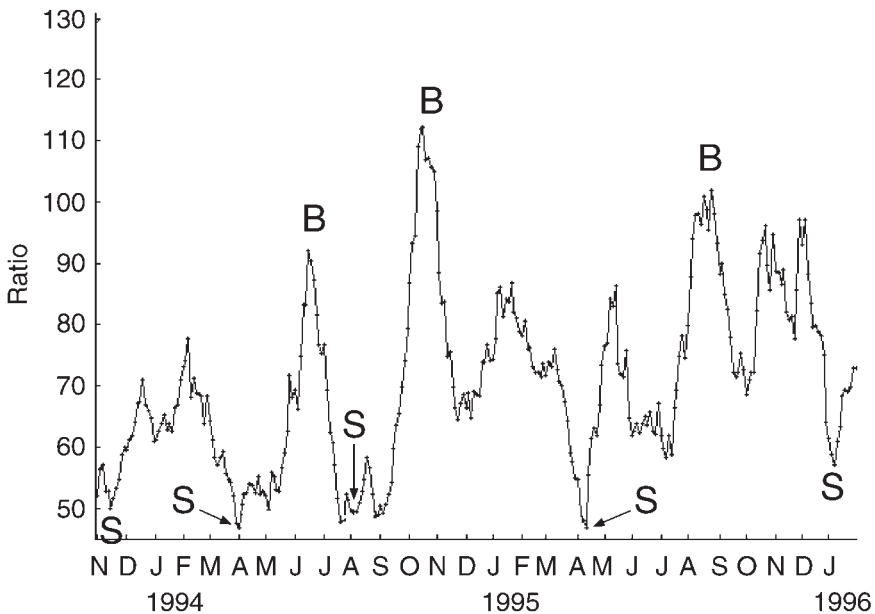

reached a peak in March 1994. That was an excellent buy point, as coffee exploded over the next few months (Figures 4.51 and 4.52). A sell signal then followed in July 1994, and it was a good one, too. The other buy signal—near November 1, 1994—wasn't quite so successful. The only other extreme in the put-call ratio came as a sell signal near September 1, 1995; and that was a very profitable signal as well. Clearly, not all the moves in coffee are captured by the put-call ratio; but some very good ones are—enough to make it worth your while to keep track of the ratio.

Cotton has also been very tradeable using the put-call ratios. The first signal shown in Figures 4.53 and 4.54—a sell occurring in mid-February 1994—wasn't all that good. However, the next one was: the buy of October 1994 (Figure 4.54), which came with the put-call ratio at nearly 200, was a spectacular buy and caught the beginning of the huge bull market. This buy signal is an extremely illustrative one for another reason: it clearly shows the benefit of the dynamic

**Figure 4.51**  
**CONTINUOUS COFFEE FUTURES**

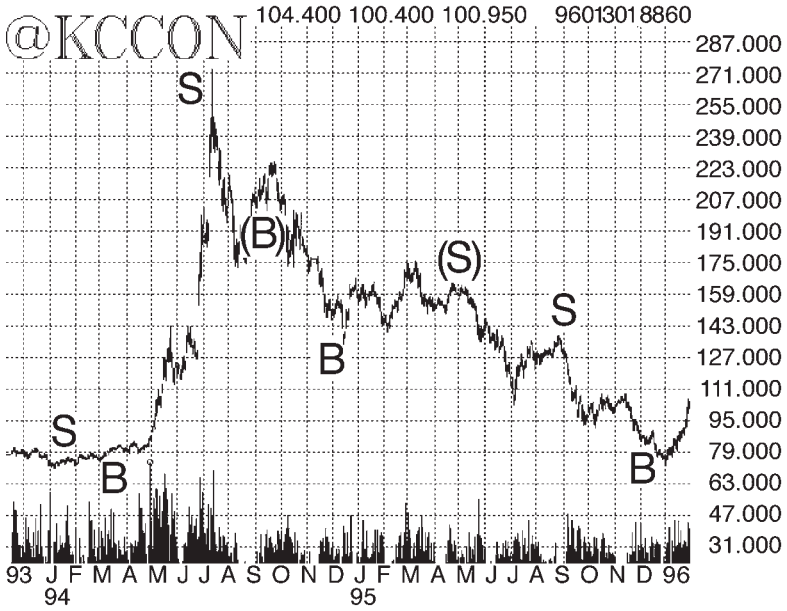

**Figure 4.52**  
**21-DAY COFFEE PUT-CALL RATIO**

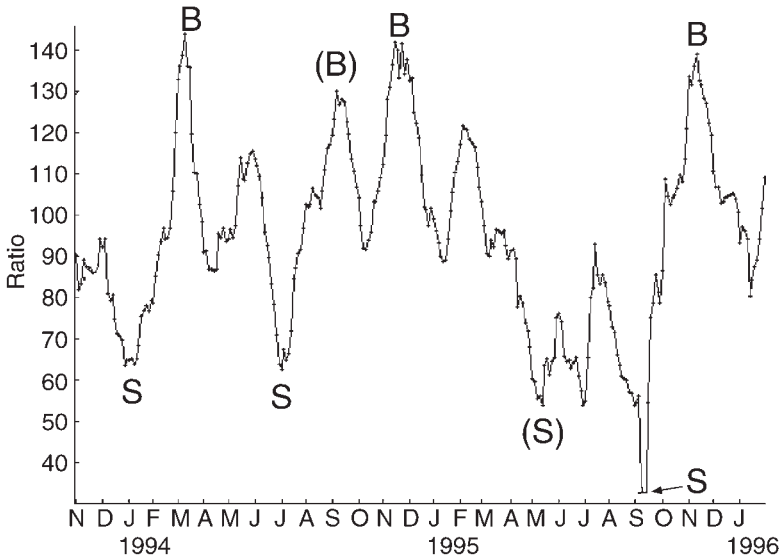

**Figure 4.53**  
**CONTINUOUS COTTON FUTURES**

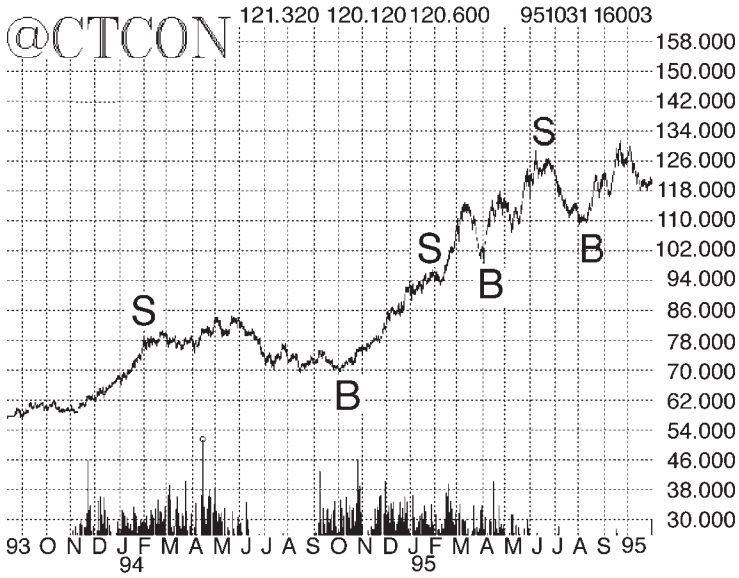

**Figure 4.54**  
**21-DAY COTTON PUT-CALL RATIO**

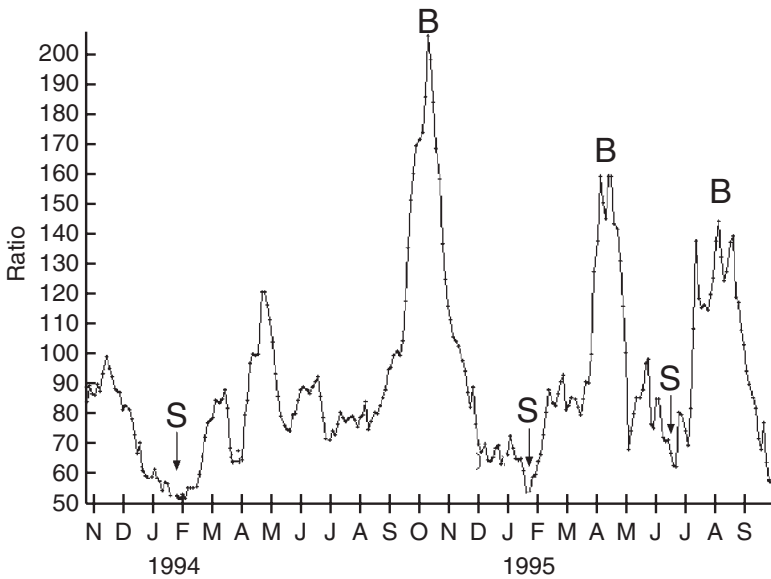



approach. By waiting until the put–call ratio rolled over and headed down, a trader would have avoided getting in too early. The put–call ratio was not anywhere near that extreme level at any other time in the two years of data; and it may not be again for a long time.

A poor sell signal occurred in February 1995, but the following buy signal in April 1995 was another excellent signal. Note that this buy signal came at a much lower level—160. Then, just to show that the cotton put–call ratio *can* issue a good sell signal, the sell of late June 1995 was a nice signal. Finally, the last buy signal—which came from a lower extreme when compared with the other two buy signals—near September 1, 1995, was a good one as well. Note that the sells generally emanate from the 50-to-60 range on the put–call chart. However, the buys all came from different levels; so while the static approach might have worked for the sells (which signals, by the way, were not as good as the buys), the dynamic approach is the only one that would have gotten you in at the right time on the buy side.

Sugar, coffee, and cotton are somewhat related. Futures traders who trade one of these markets often trade all three. However, the fourth member of the group of “pretty good” put–call ratio signals is live hogs. Since live-cattle options have a useful put–call ratio, it is not unusual to find that live hogs do as well.

The first signal that we see in Figure 4.55 is in February 1994, when an extremely good sell signal was issued. Eventually, option traders switched sides, and the put–call ratio peaked, issuing a short-lived buy signal in June 1994. As you can see from Figure 4.55, the chart of continuous prices, a quick rally ensued, but only lasted a couple of weeks. This signal once again reconfirms an important point: *the strength of a signal is not necessarily related to the level at which the signal occurred.* As you can see, the put–call ratio (Figure 4.56) was almost up to 200 when this buy signal occurred. However, the ensuing rally, while profitable, was only a small bounce in an overall bear market.

After that, the market began falling in earnest once again. In August 1994, another sell signal was issued; and while it was rather late in the overall downtrend, it did manage to capture about 10 points of the decline, from 39 cents down to 29 cents, which is a very good trade. At that point, the put–call ratio stayed very low for several months, issuing repeated sell signals. These didn’t really pan

**Figure 4.55**  
**CONTINUOUS LIVE-HOG FUTURES**

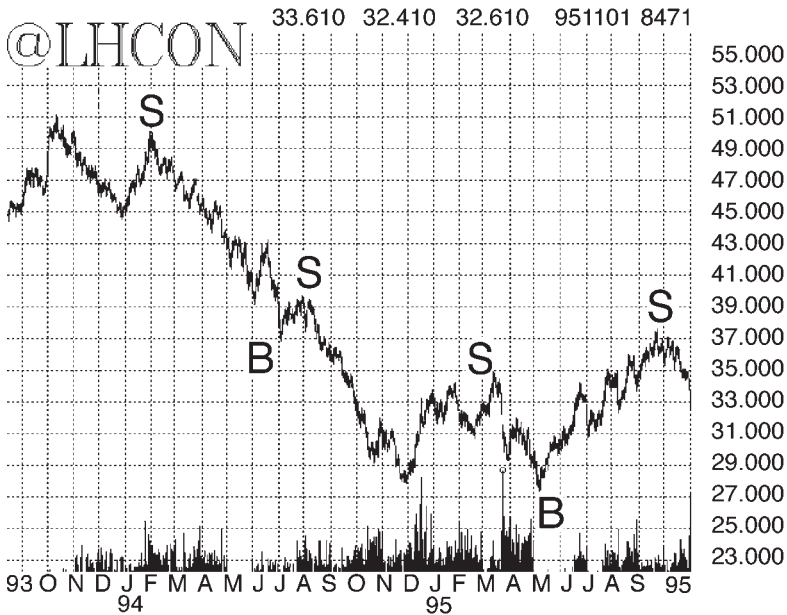

out, although the market didn't rally a great deal during that time, either. It appears that a large number of call speculators were trying to pick the bottom during the period from November 1994 to February 1995. And for a period they were right. However, the market collapse to new lows in April 1995 attracted massive put buying, eventually culminating in a buy signal in June 1995 (Figure 4.56). The market then rallied into a sell signal in early October, which was a successful signal as well.

Overall, it appears that most of the sell signals for live hogs arrive with the put-call ratio in the 40-to-50 neighborhood, while the buy signals are in the 130-to-150 neighborhood, except for the one big spike in June 1994.

The fifth member of the group of "pretty good" put-call ratio signals is natural gas. This is normally thought of as a contract that is related to the oil and oil-product contracts. However, natural

**Figure 4.56**  
**21-DAY LIVE-HOG PUT-CALL RATIO**

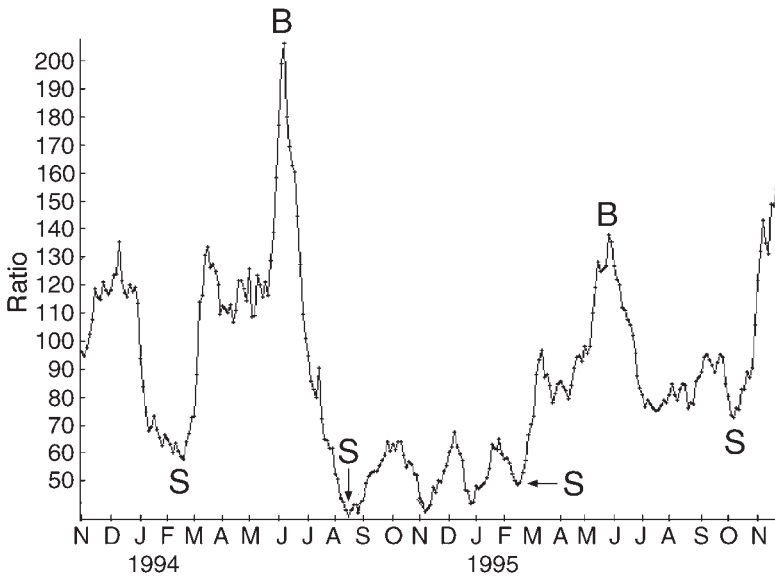

gas options give much better signals than do the oil and oil-product options.

Figures 4.57 and 4.58 are those of natural gas, both the continuous futures chart and the put-call ratio. One thing that immediately stands out from the put-call ratio chart (Figure 4.58) is that the numbers are quite high. Apparently, there is a fair amount of put trading in natural gas options at all times. This is just an observation, for with the dynamic approach, we really don't care at what absolute levels the signals occur. The first signal—a buy in December 1993—was an excellent signal. Then, a local minimum (sell signal) occurred with the ratio near 60 in March. It was also a good signal. The next signal was also a sell—the 70 level in August 1994—and it was a tremendous one, as natural gas futures went into a prolonged decline.

However, the next few signals were not as good, assuming you are just trading the extremes. A sell signal at the 80 level in January 1995 and buy signals in October 1994 (at the 160 level) and in April 1995 (at the 180 level) were either poor or just barely profitable.

**Figure 4.57**  
**CONTINUOUS NATURAL GAS FUTURES**



**Figure 4.58**  
**21-DAY NATURAL GAS PUT-CALL RATIO**

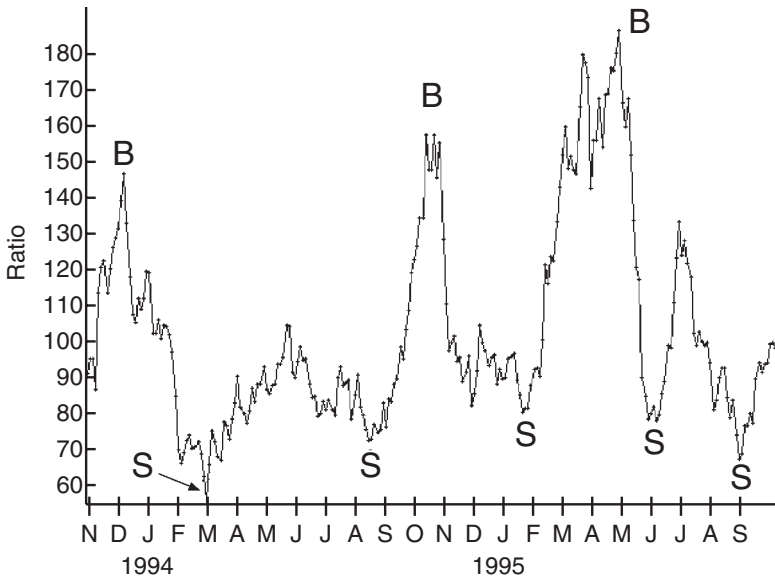

However, the May 1995 sell signal, also from the 80 level, was another good one.

So, natural gas options' put-call ratio can be traded from the extremes. In the past, this has meant sells occurring in the 60-to-80 range, and buys in the 150-to-180 range. However, don't rely on those static numbers—use a dynamic approach.

The remaining charts in this section of futures have some good signals and some poor ones. However, since futures tend to trend so strongly, I think it is worthwhile following these signals because there have been some tremendous ones. Remember, it is best to see the signal come from an extreme level and to use some technical analysis to support the put-call ratio signal. Also, the introduction of weighted ratios has aided in the trading of futures and futures options via the put-call ratios.

Figures 4.59 and 4.60 concern the put-call ratios for the British pound (BP) currency. Figure 4.59 is the standard ratio and Figure

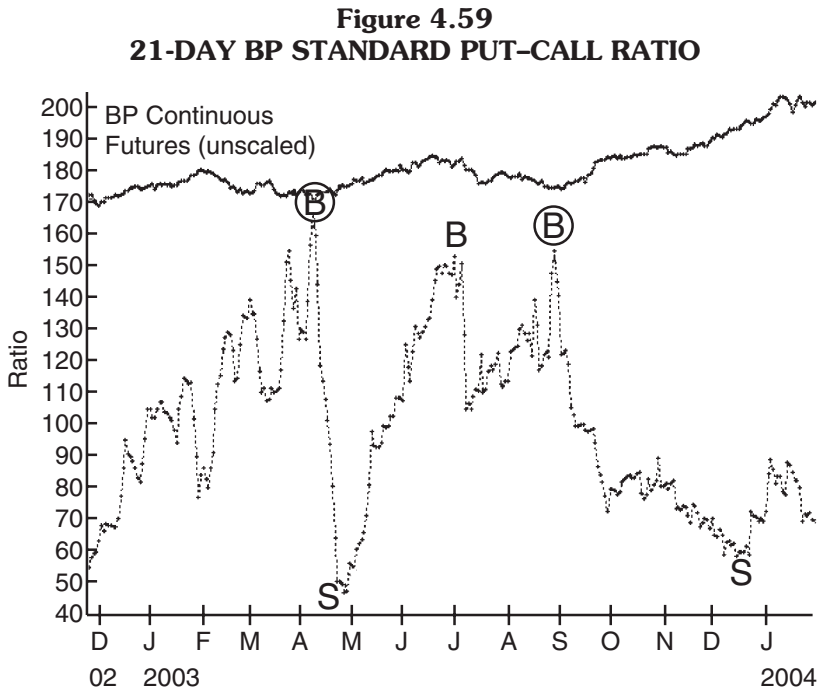

**Figure 4.60**  
**21-DAY BP WEIGHTED PUT-CALL RATIO**

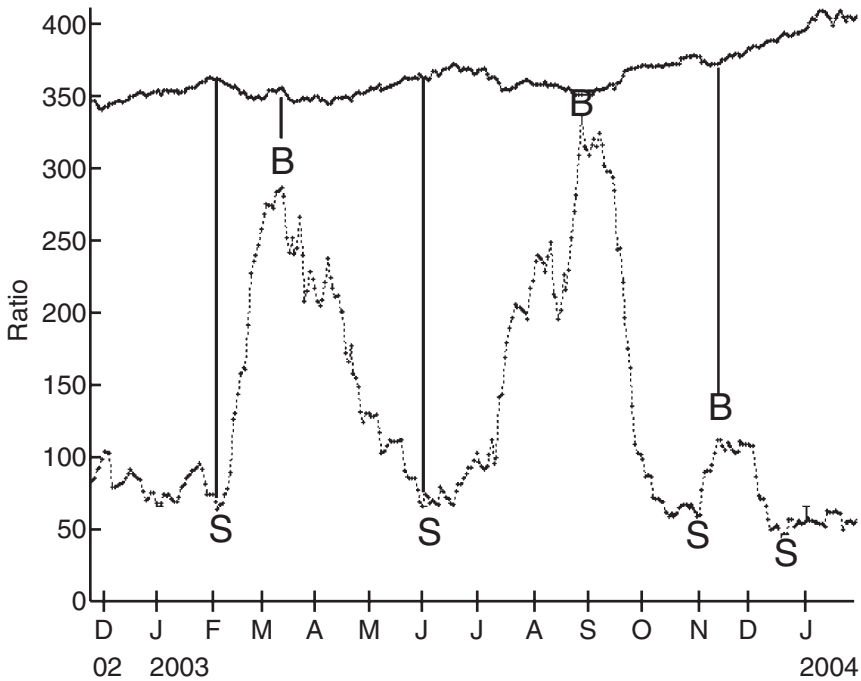

4.60 is the weighted ratio. First, consider the standard ratio. There are two excellent buy signals, both circled on the chart. You might have been prematurely stopped out of the first one, though, because a sell signal followed almost immediately. Assuming you stayed with your long position as long as the futures were trending upward (a logical approach), just trading those two signals alone would be quite profitable because losses would be limited in the other situations.

However, now consider the weighted British pound chart in Figure 4.60. There are three buys and three sells. All three buys are profitable, and certainly the first sell is. The other two sells might be marginally profitable as well. It's quite clear from comparing these charts that the weighted ratio does a better job of generating signals for the British pound futures than the standard ratio does. This is true for many of the futures, especially the currencies.

**Figure 4.61**  
**21-DAY JY WEIGHTED PUT-CALL RATIO**

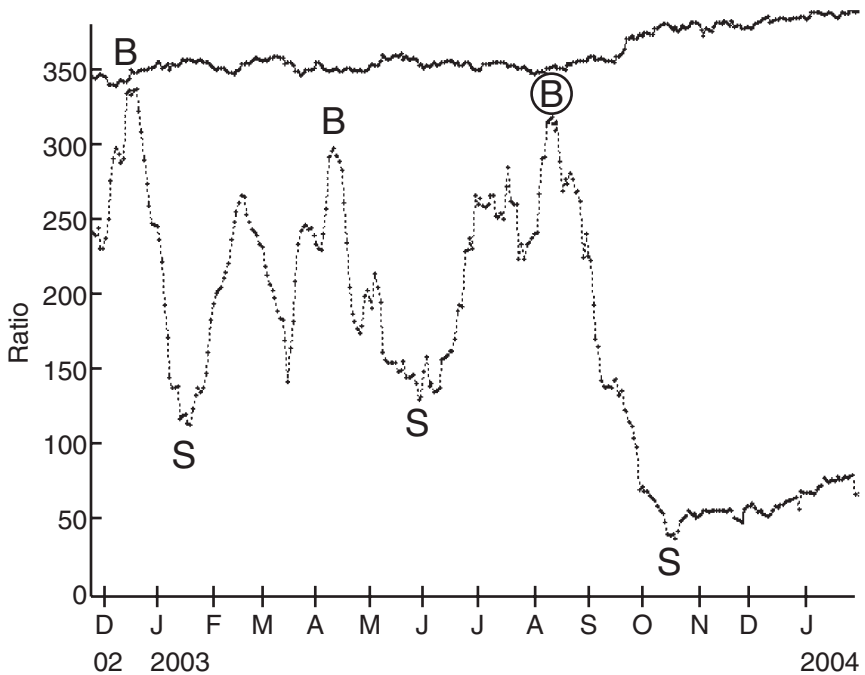

The Japanese yen (JY) continuous futures chart and the weighted put-call chart are shown in Figure 4.61. These signals are not as profitable as the ones for the British pound were, although the buy signal (circled) in August 2003 was a good one. Actually, if the continuous chart were expanded, you could see that some of the other signals were marginally profitable; but overall the yen futures is not one of the best contracts in responding well to put-call ratio signals.

Continuing with the theme of currency futures, we next examine the potential of the put-call ratios in the Swiss franc (SF) futures. The signals are actually quite good here (Figure 4.62). There are nine signals marked on Figure 4.62, and all but two of them are circled. The circled ones could easily have been traded profitably—particularly the buy signals. This was much better performance than was available from the standard ratio (chart not shown).

**Figure 4.62**  
**21-DAY SF WEIGHTED PUT-CALL RATIO**

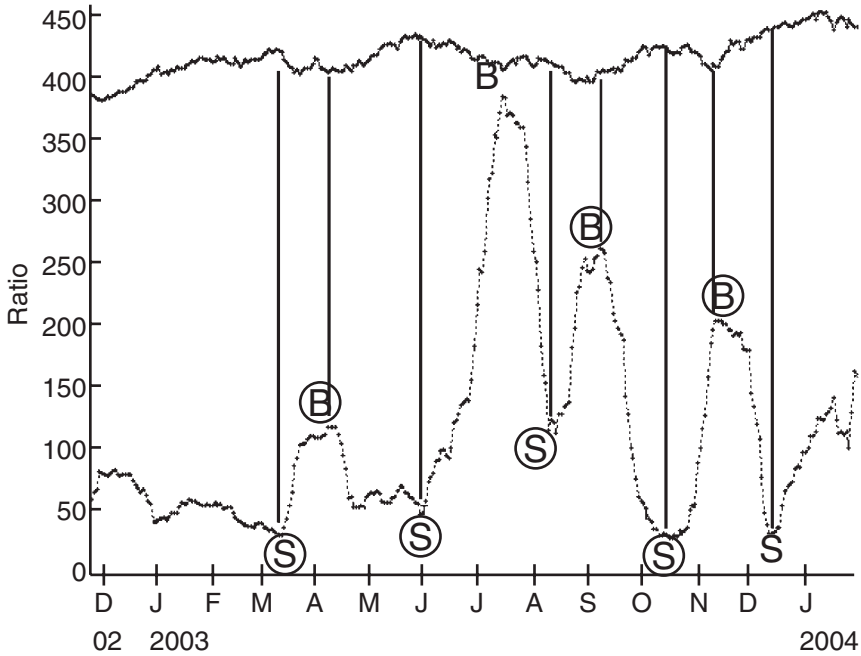

The final currency chart is shown in Figure 4.63. It is that of the Euro currency (EC). Its signals are quite accurate, too. About half the signals were accurate, and they caught all of the major moves. That is the object—especially with futures—to be on the right side of a major, trending move.

What causes the weighted ratio to be so much better in the currencies? It's not completely clear, but it certainly seems that activity in the out-of-the-money options is what's causing the problem for the standard ratio signals. Generally, such activity—as least in considerable volume—comes from institutional traders. There could be another explanation, though. The listed currency options trade on the Chicago Mercantile Exchange (Merc), but there is a much bigger market in currency futures, forwards, and options over the counter. Those traders and market makers could be using the Merc options to



**Figure 4.63**  
**21-DAY EC WEIGHTED PUT-CALL RATIO**

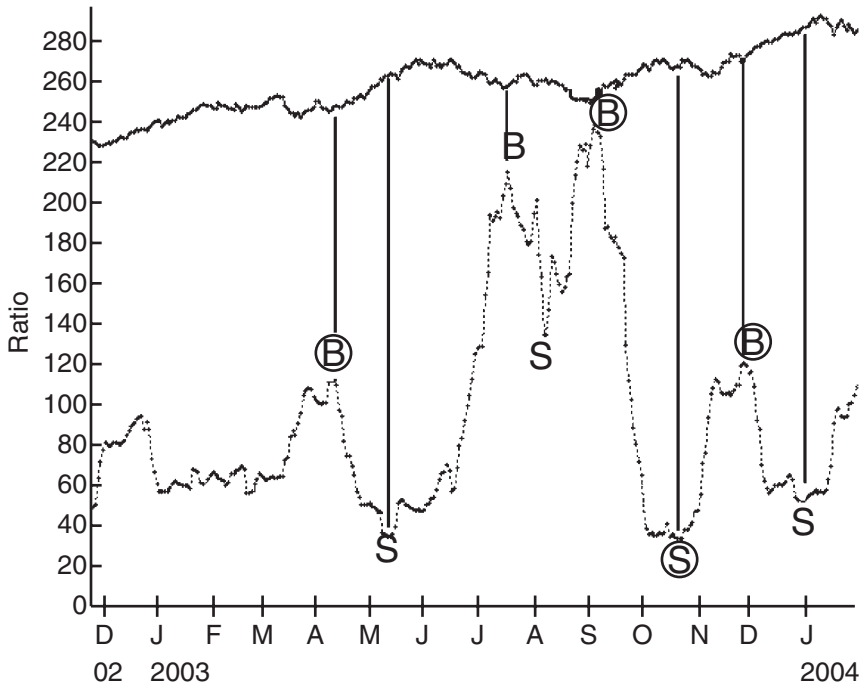

hedge or to lay off risk; and that activity would occasionally cause a signal to be generated when, in fact, there was *not* a contrary opinion to be had. In fact, this laying off of risk in the listed futures market happens in other futures and commodities as well. Yet, it doesn't seem to seriously affect the worth of the signals.

We'll finish the examples in this chapter with silver (SI) futures. The standard ratio has a poor track record for silver, and so we had thought that the put-call ratios didn't really work too well. But, when we applied the *weighted* ratio, we found some excellent signals. Figure 4.64 shows the continuous silver futures and the *weighted* put-call ratio. Three of the four successful signals were buy signals, which probably doesn't mean anything significant. The best feature of this graph is that the buy signal in October 2003 caught the start of the big, bullish move that followed.

**Figure 4.64**  
**21-DAY SI WEIGHTED PUT-CALL RATIO**

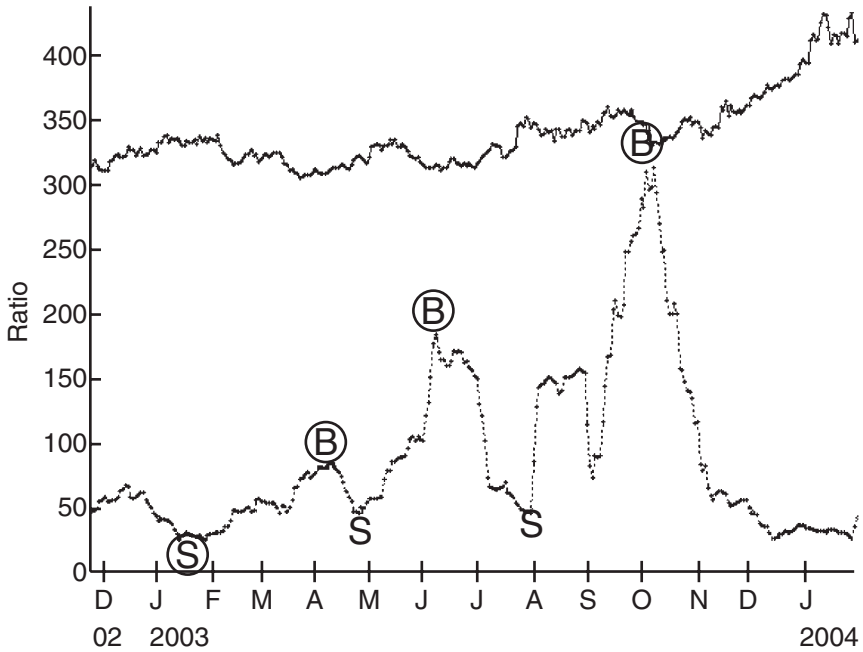

Finally, the following contracts are the ones that seem to have the best track records for put-call signals:

- British pound
- Cocoa
- Coffee
- Cotton
- Crude oil
- Deutsche mark
- Euro currency
- Eurodollar
- Gold
- Japanese yen
- Lean hogs
- Live cattle

Natural gas  
 Orange juice  
 S&P 500  
 Silver  
 Sugar  
 Swiss franc  
 T-bonds  
 10-year notes

In addition, the grains are sometimes worth watching as well—at least corn, soybeans, and wheat. I would recommend using only the weighted put–call ratios for the grains.

## FUTURES OPTIONS VOLUME

Since we are discussing futures options in some detail, this may be an appropriate place to insert a brief item about the liquidity of futures options. This liquidity is not a predictive quality, like the features we have discussed previously in this chapter. Rather, this is more for information purposes. The various futures options are divided into four broad categories.

<i>Very Liquid</i>	<i>Liquid</i>	<i>Somewhat Illiquid</i>	<i>Very Illiquid</i>
Crude oil	Corn	Heating oil	Cocoa
Eurodollar	Cotton	Unleaded gas	Dollar index
S&P 500	Gold	Live cattle	Copper
T-bonds	Coffee	Natural gas	Orange juice
Euro currency	Soybeans	Sugar	CRB index
10-year notes	Silver	Swiss franc	
	British pound		
	Wheat		
	Japanese yen		

As time goes by, some of the futures options in this list may change positions. In general, I would expect them to become more liquid. It is unlikely that any of the “very liquid” contracts would lose their status. They have been very liquid for a long time and represent a true hedging market as well as a speculative market; so continued

volume is likely in Eurodollars, T-bonds, crude oil, and S&P 500 options.

### **Put-Call Ratio Trading Summary**

Put-call ratio charts can be a very good measure of contrarian sentiment. However, they should not be used in a vacuum. They are best used when the put-call ratio signal corresponds well with a technical formation in the underlying instrument. For example, if a buy signal is generated by the put-call ratio, then the underlying should be breaking out over resistance or at least should be trading up above a short-term moving average—making higher highs and higher lows. Once positions are established, stay with the trend, using a trailing stop to lock in profits and perhaps taking partial profits. If the put-call ratio should reverse signals, that could be a reason to stop yourself out, but not if the underlying has already established a good trend; stay with the trend, using the trailing stop.

Finally, from the previous charts, you can see that the weighted charts are more useful, in general, than standard charts—although both have their successes. Hence, it is necessary to have put-call charts and data in order to view the signals; but a history (at least one year) of such put-call signals is needed in order to determine how successful the past signals have been. We provide a large amount of data on our web site, located at [www.optionstrategist.com](http://www.optionstrategist.com), in the subscriber area called The Strategy Zone. In that section, the put-call ratio charts—both standard and weighted—are presented every day for every underlying instrument that was identified in this chapter as having the best history of put-call ratio signals. In addition, any stock whose options average considerable volume on a daily basis are included. This criterion keeps the active stock options on the list. A free one-week trial to The Strategy Zone is available to anyone who signs up for it.

## **ON MOVING AVERAGES**

This section ideally belongs in a chapter on technical analysis, but since I don't have one of those in this book, this seems the best place

for it. You have noticed that our use of the put–call ratio necessitates locating the local maxima and local minima of a moving average in order to identify buy and sell signals. There are many other technical indicators in use that require similar identifications. So, just how *do* you go about deciding whether a local maximum or minimum has been reached? It’s easy to look at a historical chart, such as those shown throughout the second part of this chapter, and see where the tops and the bottoms were in retrospect. But can they be identified in a timely manner while they are being formed? The answer to that question is a qualified “yes,” and we demonstrate why in this section.

You may have judged by now that I am not a fan of using *absolute* levels to identify trading opportunities with moving averages. The whole discussion of the index put–call ratio pointed out that the market is dynamic, and it is often the *direction* of a moving average, and not its actual value, that is important. This analysis can be applied to many other moving averages. For example, I have found that it applies quite well to the TRIN, or Arms Index, also. Advocates of the Arms Index use a 10-day, 50-day, or other moving average to judge whether the market is overbought or oversold.

The Arms Index is computed daily as follows:

$$\frac{\text{Number of advancing issues}}{\text{Number of declining issues}} \times \frac{\text{Volume of declining issues}}{\text{Volume of advancing issues}}$$

In theory, the number would be 1.00 in a balanced market. What really happens is that volume is generally dominant; so small numbers occur on bullish days (the smallest I recall is about 0.25), and large numbers occur on bearish days (large selloffs can generate numbers higher than 3.00). If the numbers are too high for too long, as identified by a moving average of the daily numbers, the market is getting oversold and we look to buy the market. If the moving average gets too low, the market is overbought, and we look for a sell signal.

I have found that absolute levels might work okay for the short-term averages (1.20 is oversold for the 10-day Arms Index, while 0.80 is overbought). However, the longer-term averages don’t adhere to such rigid interpretation. Buy and sell signals come at various absolute levels. But when the longer-term Arms Index moving

averages peak, a market buy signal is at hand; when they bottom out, a market sell signal is generated. So, the following discussion is applicable to those moving averages as well; and, in fact, it was the observation of the Arms Index signals that led me to explore the following concepts originally, back in 1977.

Any trader who uses moving averages to generate buy and sell signals knows that he can tell what level is needed on the next trading day in order to generate the given signal. A typical moving average trading system, employed especially by commodity technical traders, is the *moving average crossover system*. You keep two moving averages, with differing number of days in each moving average; and when they cross each other, you have a buy or a sell signal. Typically, the shorter-term average is used as the directional signal.

Thus, if we were keeping a 10-day moving average and a 20-day moving average, we would have a buy signal when the 10-day average crossed the 20-day one from below to above. Conversely, we would have a sell signal when the 10-day average crossed the 20-day one from above to below. This would generally be identified as a trend-following system. It would generate big profits when a long trend emerged but would do poorly in a trading range market that oscillated back and forth.

---

*Example:* Any trader using a crossover system should know at what levels he will get a signal on the following day. Suppose we know the following information:

Closing price 20 days ago: 80

Closing price 10 days ago: 60

Current 10-day moving average: 62.0

Current 20-day moving average: 63.5

At the current time, the 10-day average is lower than the 20-day average; so we must assume that we are in the midst of a sell signal. However, we also want to be alert for a possible buy signal, since the two averages are relatively near each other.

The pertinent question is, "What closing price today would cause the 10-day average to cross over the 20-day average and generate a buy signal?" This is an easy matter to figure out. We merely need to compute the sum of

the intervening closes and see what close today would cause the desired result.

Sum of 10 closes in current 10-day moving average: 620  
 Sum of 20 closes in current 20-day moving average: 1,270

The 10-day sum is merely the moving average, 62.0, times 10. The 20-day sum is that moving average, 63.5, times 20.

Now we know for sure that the closing price of 10 days ago will not be part of the 10-day moving average after today's close. So the 10-day sum *after* today's trading will be the current sum, minus the close from 10 days ago, plus today's close:

$$\text{New 10-day sum} = 620 - 60 + \text{today's close} = 560 + \text{today's close}$$

Similarly, we can compute the new 20-day sum:

$$\begin{aligned} \text{New 20-day sum} &= 1,270 - 80 + \text{today's close} \\ &= 1,190 + \text{today's close} \end{aligned}$$

So now we have a simple arithmetic equation to solve to see what level for today's close would make the 10-day moving average be greater than the 20-day moving average. Let  $t$  stand for "today's close," so that the formulas are shorter. When will the 10-day average be greater than the 20-day moving average?

$$\frac{(560 + t)}{10} > \frac{(1,190 + t)}{20}$$

Solving, we get  $t > 70$ . Thus, if the stock (or commodity, or whatever) closes above 70 today, we will get a buy signal. Futures traders, whose brokers take such stop orders, could enter an order such as "buy at  $70\frac{1}{4}$ , stop close only." Then they could go fishing or play golf.

This simple method can be used to decide what level of trading is needed on the next trading day in order to make the moving average be at a specific level—presumably a level that would generate some sort of signal for whatever trading system you are using.

Now, let's look at a put-call ratio signal. Suppose, for example, that we define *local maximum* for a put-call ratio moving average as occurring when "the average forms a top that is not exceeded for 10 trading days." If that happens, we will call the point a local maximum. Using the method from the preceding example, we could always tell, after 9 days had passed, what closing price for the 10th day's trading would keep the moving average below that peak level of 9 days ago, thus ensuring that 10 days had passed since the peak was seen. Hence, we would have our local maximum, by the 10-day definition.

That is interesting, but hardly useful enough for our purposes. It would only alert us to a buy or a sell signal after 9 days had passed. We could miss a lot of market movement in that time period. What we'd like to know, if possible, is if a local maximum or local minimum is forming on the first or second day of the 10-day period. Now *that* would be something truly useful. In the context of the previous example, that would be tantamount to predicting where the sums will be in 10 days. We know what numbers are coming "off" the moving average in that time (the closes for the previous 10 days), but we have no idea what the closing prices will be for the next 10 days, in order to add back onto the sums. Thus, it seems as though we have no chance of predicting where a moving average might be 10 trading days from now.

Unfortunately, unless you're clairvoyant, you can't predict with certainty what tomorrow's trading will bring—much less the next 10 days—but you can often come up with a good guess, based on the probability of what's happened in the past. This is especially true if you're dealing with items that are confined to a range, such as the daily Arms Index readings or the put-call ratio (rather than stock) index, or futures prices themselves.

The first thing that you must do, if you hope to predict where a moving average will be some days hence, is to define the distribution of the closing values that will be added to the moving average during that time. The *equity put-call ratio* is defined as the number of equity puts that trade on a given day, divided by the number of equity calls that traded on that same day. Typically, this number is between 0.30 and 0.50. Occasionally, it falls outside of that range; but if we summarized the daily numbers for a long period of time, we would find that almost all of them fall within this range.



For simplicity's sake, let's assume that on any given day the equity put–call ratio can only be equal to 0.30, 0.35, 0.40, 0.45, or 0.50. Furthermore, let's assume that these five results all occur randomly, with equal probability. Now, these assumptions are not completely correct, but they are reasonable and are simple enough to allow us to demonstrate the technique needed to predict a moving average some days hence.

Once this step—defining the distribution—is accomplished, the technician is well on his way to achieving the desired result of being able to predict the moving average forward in time. Let's start real simple, and see how a two-day prediction would be accomplished.

---

*Example:* We continue with the previous equity put–call ratio moving average example. However, in order to eliminate the use of decimal points as much as possible, we use 30, 35, 40, 45, and 50 as the possible daily closing values.

Suppose that we know the following information:

Current 10-day moving average: 40

Daily ratio reading of 10 days ago: 50

Daily ratio reading of 9 days ago: 45

We also know that the sum of the 10-day moving average is 400 (10 times 40).

Given this information, we can now compute with some certainty where the moving average might be in two days. There are five possible daily values for the first day—30, 35, 40, 45, and 50. And likewise there are the same five values for the second day, for *each* of the possible values on the first day. Thus, in all, there are 25 possible outcomes of two days' worth of equity put–call readings (five on day one times five on day two).

We know that the current sum of the last 10 days' worth of data is 400. In addition, we know what numbers are coming “off” the sum (50 and 45, as given earlier). Thus, the sum will be reduced by 95 over the next two days and then will be increased by whatever actual daily numbers are added on. The top line's moving average of 36.5 is computed as follows:  $400 - 95 + 30 + 30 = 365$ ;  $365/10 = 36.5$ . Hence, we can then calculate all the possible values for the moving average over the next two days (all the while remembering that we have made the assumption that only five values are possible for any trading day).

<i>Day 1 Possible Values</i>	<i>Day 2 Possible Values</i>	<i>10-Day Moving Average</i>
30	30	36.5
	35	37.0
	40	37.5
	45	38.0
	50	38.5
35	30	37.0
	35	37.5
	40	38.0
	45	38.5
	50	39.0
40	30	37.5
	35	38.0
	40	38.5
	45	39.0
	50	39.5
45	30	38.0
	35	38.5
	40	39.0
	45	39.5
	50	40.0
50	30	38.5
	35	39.0
	40	39.5
	45	40.0
	50	40.5

This list of 25 outcomes is the total spectrum of possible 10-day moving averages after the next two trading days, under our assumptions.

Now that we have calculated this list, here's how to use it. Suppose that we want to know if the current 10-day moving average is going to be a local maximum. From the list, we see that only 3 of the 25 outcomes result in a moving average that is equal to or greater than the current value, 40. Conversely stated, 22 of 25 possible outcomes result in a lower moving average after two days. Therefore, there is an 88 percent chance (22 divided by 25) that the current value of the moving average is going to be a local maximum for two days. If we were using that as a trading signal, we would probably go ahead and buy the market, based on the knowledge that there is such a high

probability of the current value becoming an actual local maximum (a local maximum in the put–call ratio identifies a buy point).

---

This technique is a very useful one. We can extrapolate it for longer time periods. As stated earlier, I prefer to define a local maximum or minimum as a point, usually on the 21-day moving average, that is not exceeded for 10 trading days. Therefore, we could extend the “trees” in the preceding example out to 10 nodes (using a computer, of course) and calculate all the possible 21-day moving averages after that time. Then, we can see how many of those possible outcomes exceed the current maximum, in order to predict the probability of that maximum actually holding for the entire 10-day period.

The technique can be used for predicting moving averages in any sort of market as long as the daily values are numbers that generally lie within a range. It is therefore applicable to moving averages of the Arms Index (where daily values normally lie between 0.60 and 1.40), or equity put–call ratios (values between 0.30 and 0.55), or index put–call ratios (values between 0.90 and 1.50). There are many others that would fit the pattern as well—you can see from the put–call ratio charts in this chapter that the daily ratios fall within very well-defined ranges. A lot of technical indicators are based on oscillators that generate signals on crossovers or on exceeding a certain level. Any of those could be estimated with this system also.

You must remember, of course, that real market conditions can bring unexpected results. For example, on the day of the crash of 1987, the Arms Index was 14.07! You certainly wouldn’t allow for *that* in your distribution of possible values when making predictions, but it did actually occur. Therefore, the result of your calculations can define a highly probable maximum or minimum, or buy or sell, or whatever; but there is always a chance that over the ensuing days, the actual values for the daily readings may be outliers. If that happens, it’s possible that you won’t get the signal you were anticipating; and if you had taken a trade in advance of the signal, you will probably have to take a loss to extricate yourself.

---

When I first completed the research for this system, I was using local maxima and minima in the 50-day Arms Index to predict intermediate-term buy

(maxima) and sell (minima) points in the broad market. At the time (1977), I was working for Thomson McKinnon as the retail option strategist, and the head of the department and his superior—an executive vice president—both scrutinized the system. They thought it looked workable, and we waited for a signal to occur.

At the time, I was using 90 percent probability as evidence of a signal. I have since tightened that to 95 percent. In any case, in August 1977, the system said that there was a 90 percent chance of a “market” buy signal occurring. There were no index options trading in 1977, so we had to buy stock options—or a set of several different stock options—in order to trade “the market.” We put together a package of three recommended options—IBM, Kodak, and General Motors—and called some of the firm’s larger option brokers to give them this research.

As it turned out, the signal *did* actually occur (that is, 10 days later, we had a local maximum in the 50-day moving average of the Arms Index). However, the market was very dull, mostly trading sideways; and we eventually had to advise the brokers to sell out their positions at a loss. No one was particularly upset—an honest effort had been made to identify a profitable trade. But the executive vice president jokingly said that I must have made a mistake, accidentally calculating that there was a “90 percent chance of rain” instead of a “90 percent chance of a rising market.” From that time on, the system became known as the “probability of rain” indicator.

---

For those readers who are intending to program this type of system on their computer or are going to hire someone to do it, I should point out that you can reduce the number of calculations greatly when you are constructing the trees. For example, if you are looking for a local maximum over the next 10 days and you calculate a node of a tree only three days out that exceeds the current moving average value, then you don’t need to calculate any more nodes on that branch of the tree. They are irrelevant, since the current value was already exceeded. All you need to do is count all the possible outcomes that *would* have emanated from that node as outcomes that exceed the current value. You don’t actually need to evaluate the outcomes, you just need to count how many there would be; and that is a simple matter (for example, if we are three days out, then there are seven days to go, and if there are nine possible values each day, then there would be 63 outcomes that would be considered to have exceeded the current value). However, with today’s very fast comput-

ers, you may not want to get so esoteric—the computer can blast its way with brute force through the entire array of calculations.

The advantage of knowing the probability—in advance—of a signal occurring is very useful. It allows you to get into a position much closer to the actual local maximum or minimum, if you are using that type of system. Also, it can assign a probability that two moving averages will cross over each other in the next few days (in order to calculate this type of system, you need to apply the technique to both moving averages and then see how many of the possible outcomes result in a crossover).

## **SUMMARY**

This chapter has demonstrated that options can be used in various ways to predict markets. Unusually heavy stock-option trading is often a tipoff that the underlying stock is about to experience a significant move. Also, option premium levels can be an important indicator in several situations. In some cases, it is a warning of a large move by the underlying stock. In others, it may indicate the end of a downtrend when options are expensive. Similar conclusions can be drawn from index-option premiums; when they are extremely expensive, the market may be reaching a bottom, and when they are very cheap, a market explosion may occur (often to the downside). Finally, the put-call ratio is a valuable indicator for the broad market as well as for certain futures contracts.

We also presented you with a method for predicting whether a moving average is making a local maximum or minimum. This is extremely useful in conjunction with the put-call ratios, since that is how we identify buy and sell points.

# 5      **Trading Systems and Strategies**

In this chapter, we describe a number of trading strategies that have profitable track records. These include day-trading systems, intermediate-term market-timing systems, intermarket spreads, and a number of seasonable strategies. It is not necessary to trade options to employ most of these strategies, although, as with any trading decision, it may behoove the trader to use options in many circumstances.

We have already discussed one very profitable set of strategies—those having to do with trading at the time of option expiration, especially during the week of expiration and the week after. Several strategies for expiration trading were presented in Chapter 3. These included a hedged strategy for expiration Friday itself, a way to determine if there was a possibility of expiration-related buying in the days prior to expiration Friday, and finally a strategy for trading the week after expiration (the postexpiration effect).

## **INCORPORATING FUTURES FAIR VALUE INTO YOUR TRADING**

In Chapter 3, the concept of fair value for Standard & Poor's (S&P) futures was presented. This is an important concept—especially for day-trading of S&P futures, S&P 100 Index (OEX) options, or other index options—and the reader should review it if he is not familiar with “fair value of futures.” When the S&P futures are overvalued, OEX calls will also be overly expensive, and OEX puts will be cheap. Therefore, that is not normally an appropriate time to buy either the futures or the calls, for you will almost immediately suffer the aftereffect of overpaying when the futures return to fair value. But if you

happen to be buying puts, it is a most opportune time to do so. Similarly, if the S&P futures are undervalued, then OEX calls will be cheap, and puts will be expensive. In that situation, if you are bearish, you would be hurt by selling the futures or buying the puts; but if you are bullish, the calls are a good buy.

Thus, if you have a broad market-trading system that has given a signal, it doesn't always pay to rush right in and take a position. You should first look at the relationship of the S&P futures to fair value. If they are expensive and you are looking to buy the market, you may want to wait until the futures return toward fair value before making your purchase.

This statement makes the tacit assumption that the futures *will*, in fact, return to fair value rather quickly. Normally, they do, especially in this day of efficient arbitrage. However, they don't always spring back to fair value if there is an extenuating influence on the market, particularly on the downside. Recall the description of how futures traded at huge discounts to fair value during the crash of 1987. While that is an extreme example, more common ones might involve some piece of bad news that affects the entire market—an unexpected government unemployment figure, for example. This might cause the futures to trade at discounts for more than a brief period of time.

A trader should use judgment in deciding when to trade even though futures are not “fairly priced.” Typically, if the market is relatively stable and is not reacting to some sort of extreme news, then you can be choosy, refusing to buy when the futures are overpriced or to sell when the futures are underpriced. However, in a fast-moving market where news is a factor and, perhaps, T-bond futures are moving fast in the same direction as well, discretion may dictate that you trade without consideration of fair value. For example, when these fast market conditions exist and you are already long, if the market drops down through your mental stop price, you probably should be more willing to sell at the market rather than wait for the futures to return to fair value.

So, in the discussion of trading strategies in this chapter, you should realize that you may sometimes be able to improve your overall profitability by paying attention to premium levels at which the S&P futures are trading before actually entering your order.

## DAY-TRADING VEHICLES

In many of the systems to be presented in this chapter, we are going to be trading “the market,” often over a fairly short-term time horizon. The question inevitably arises as to what trading vehicle to use—futures or options. In some of these systems, there will be specific comments on when to use options (in intermarket spreads, for example). However, in others, the choice is the trader’s.

*In general, I prefer to use the S&P 500 futures to day-trade, but I prefer the OEX options for a trade with a longer time horizon (3 to 15 days, for example). There are a couple of reasons behind my choice, and I will attempt to explain them.*

The S&P 500 futures are the “truest” trading vehicle that there is, as long as you are aware of the fair value. There is no implied volatility that can collapse your value as it can with an OEX option. It has been my experience over the course of the 22 years that the S&P 500 futures have been trading that they more accurately mirror the movement of the underlying cash index than OEX options do, by a wide margin.

---

Here is an actual story from a trading day in 1995, December 1, to be exact. The market gapped open, higher, on a good economic report. This triggered a sell signal from the TICKI System (to be discussed shortly). The S&P 500 futures were trading at 608.50, and the OEX was almost exactly at 581. The following prices sum up the position that I, or any trader, was facing at the time:

S&P 500 Cash Index: 607.60  
 S&P 500 Futures: 608.50  
 Futures Premium: 0.90  
 Fair Value: 1.25  
 OEX: 580.98  
 OEX Dec 580 put: 4<sup>5</sup>/<sub>8</sub>  
 Implied Volatility of the put: 12.5%  
 CBOE Volatility Index: 11.5%

The controlling factor in all of this was the premium on the S&P futures. It was then at 0.90, which was below fair value. This means that



OEX puts were going to be on the expensive side, since OEX market makers are quite diligent about watching the S&P futures premium.

You can often get a quick idea of how expensive an OEX at-the-money option is, by comparing its implied volatility with the Chicago Board Options Exchange (CBOE) Volatility Index (symbol: \$VIX at that time, but currently \$VXO), which can be quoted on any quote machine. You can see that this particular Dec 570 put was “overpriced” in that its implied volatility of 12.5 percent was a full point over the VIX level of 11.5 percent. In the case of this option, that one point of implied volatility was worth 0.45 to the price of the option. That is, if the implied volatility fell to 11.5 percent and OEX were at 580.98, the option would sell for about  $4\frac{1}{8}$ . That’s a huge amount of the price of this option.

As it turned out, I shorted the futures and the market *did* top out, but only lazily; and it slid slightly lower, so that by 3:45 P.M. Eastern time, 15 minutes before the close, the following prices existed (the net change of each price from the earlier prices in this example is included in parentheses):

S&P 500 Cash Index: 606.20 (−1.40)\  
 S&P 500 Futures: 607.40 (−1.10)  
 Futures Premium: 1.20 (+0.30)  
 Fair Value: 1.25  
 OEX: 579.60 (−1.38)  
 OEX Dec 580 put:  $4\frac{3}{4}$  (+ $\frac{1}{8}$ )  
 Implied Volatility of the put: 11.5 percent (−1.0%)  
 CBOE Volatility Index: 11.2% (−0.3%)

The futures had dropped 1.10, and I was able to cover and make \$550, less commissions. But look at the OEX Dec 580 put—it only advanced an eighth of a point! Moreover, if you went to sell it, you’d probably have to take an eighth less to hit the bid. What happened here?

Well, let’s analyze it. The implied volatility of the put dropped back to be much more in line with the Volatility Index (11.5 percent versus 11.2 percent). As was pointed out, that drop in volatility cost the option 45 cents. Moreover, the delta of the put option was only about 0.43 to begin with, meaning that if OEX fell by a point, the option was only going to increase in value by 43 cents. As it turned out, OEX fell by about the same distance as SPX, but the loss of implied volatility in the option essentially wiped out all the profit potential. Thus, the futures were the much better buy; they closely mirrored the 1.40-point drop in the SPX, except for the amount lost when they returned to fair value (30 cents).

---

This is a fairly typical occurrence. The OEX options are over-priced because of the discount premium on the futures contract. If you get only a small market move, the futures are going to be the better choice as a trading vehicle. Of course, if the market move is larger, then you probably won't notice much difference. Also, this example indicated that implied volatility fell; that doesn't always happen, either, although it often does when the ensuing market move is a small one.

Thus, for day-trading purposes, I prefer the S&P 500 futures because they more closely mirror the performance of the SPX itself. However, for longer-term speculative positions that I might be carrying for a couple of days or even a couple of weeks, I will often use the OEX in-the-money options because of their limited risk nature and the smaller capital outlay required. However, if implied volatility were too high, I would be leery of buying OEX options, even in those longer-term situations.

## **THE TICKI DAY-TRADING SYSTEM**

I devised the TICKI system a number of years ago for day-trading S&P 500 futures. It is based on the following basic concept: if an artificial buy or sell program (see Chapter 3 for definitions) is executed in a stable market, the market has a tendency to return to its previous price once the artificial buying or selling is over with. Over the years, this has been a correct observation much of the time. Of course, there is the aberrant case where wave after wave of programs hit the market; but those are the exception, not the rule.

So, in order to create a system to take advantage of this concept, we need a way to identify when a program trade is taking place, and we also need a way to identify when it is over. I have found a very simple way to determine both of these things. It is called the TICKI, and it is something that you can quote on any quote machine, including at-home systems such as Signal or Bonneville.

TICKI is the net plus or minus ticks of the stocks in the 30 Dow Jones Industrials. For example, if at the current time, 20 Dow stocks are trading on plus ticks (or zero-plus tick) and 10 are trading on minus ticks (or zero-minus ticks), then the value of TICKI would be

10 (20 minus 10). A brief example will define the terms plus tick, zero-plus tick, minus tick, and zero-minus tick.

---

*Example:* Suppose that XYZ stock trades at the following prices over a short time period during a trading day. Each trade is identified as the appropriate type of tick.

<i>Price</i>	<i>Type of Tick</i>
50	
50.05	Plus tick
50	Minus tick
50	Zero-minus tick (same price as last trade, which was a minus tick)
50.05	Plus tick
50.10	Plus tick
50.10	Zero plus tick (same price as last trade, which was a plus tick)

---

TICKI shows where the 30 Dow Jones Industrials' last ticks are at any point. Since there are 30 stocks in TICKI, the highest that it can get is +30, and the lowest it can become is -30. *If TICKI gets to +22 or higher, buy programs are being executed in the marketplace; if TICKI drops to -22 or lower, sell programs are being executed.* Note that for TICKI to be +22, 26 stocks have to be on plus ticks and 4 on minus ticks. Thus, nearly all of the 30 Dow Jones Industrial stocks have to be on plus ticks for TICKI to get to +22. The downside is similar: 26 of the 30 stocks would have to be trading on minus ticks in order for TICKI to be -22.

Since nearly all program trades that are large enough to move the market noticeably involve the 30 Dow Jones Industrials, TICKI is a good way to identify program trading. There is a similar measure called the TICK—the net of plus and minus ticks on all New York Stock Exchange (NYSE)-listed issues. TICK is too broad-based to quickly and accurately detect when a buy or sell program is hitting the market. Thus, TICKI is our choice for making that identification.

Having quantified the first half of what we need to know—when a program is being executed—we now need to address the other

half—how to identify when the program is over. No matter how large a buy program is, it has an end. During the program, TICKI may rise to +22 and stay at or above that level for some time. When the program ends, TICKI will begin to fall, reflecting the fact that some of the stocks are beginning to trade on minus ticks. *When TICKI drops back to +12 after having been at +22 or higher, the buy program is over; conversely, when TICKI rises to -12 after having been at -22 or lower, the sell program is done.*

Obviously, some buy or sell programs may be executed in a more discrete manner, but a lot of them are executed just by pushing a computer key and letting a flood of orders race into the marketplace. This type of program trading causes the TICKI behavior just described. Moreover, it is this type of program trading that draws out traders with opposite opinions. A trader who sees a stock that he owns jump up in price may often sell his stock into the program, thereby obtaining a better price than he would have in a stable market.

Having established the criteria for determining when the programs begin and end, we can now lay out a trading system that is geared toward making money when the market reverses direction after a program is finished:

- When TICKI rises to +22 and then falls back to +12, sell the S&P futures. Hold the position until one of the following occurs:
  - a. The trading day ends.
  - b. TICKI trades back up to +22.
  - c. The S&Ps exceed the highest price reached during the buy program by 0.20.
  
- When TICKI falls to -22 and then rises back to -12, buy the S&P futures. Hold the position until one of the following occurs:
  - a. The trading day ends.
  - b. TICKI trades back down to -22.
  - c. The S&Ps fall 0.20 below the lowest price reached during the sell program.

- Don't enter into any trades after 3:30 P.M. Eastern time, for programs near the close of trading may not have enough time to reverse direction.
- If you take two consecutive losses on one trading day, cease trading the system for the remainder of that day.

Note that this system often has a built-in advantage: since you are selling right on the heels of a buy program, the futures may be inflated (trading above fair value), which is an additional benefit. Conversely, when you buy immediately after a sell program, you may find that you purchase the futures below fair value.

Some comments on the system are in order, for I don't believe in totally ironclad adherence to rules. It's a day-trading system, so we generally don't hold any positions overnight; positions are closed out at the end of the trading day if they haven't been stopped out by then. However, some well-known traders have modified their stance on day trades: if you are holding a profit at the close and the market accelerated in your direction, then close out the trade the next morning. Of course, since S&Ps trade all night on Globex, you can literally close out your position at any time.

You should note that *when* you close out your position will affect your margin requirement. Most brokerage firms require less margin for a day trade than they do for a position held overnight. For S&P futures, a "day" begins at 4:45 P.M., when the Globex market opens and continues through 4:15 P.M. the next day, when trading ceases on the Chicago Mercantile Exchange (Merc). Thus if you don't close out your position by 4:15, you will be required to margin the position as an overnight position.

Back to the system. Note that if you are stopped out by rule (b), you will be reentering another trade as soon as *that* program ends. Thus, rule (b) is sort of a temporary stop—it momentarily takes you out of the market since there is another program being executed, but you will reenter your trade shortly.

Finally, the stop loss defined as rule (c) may take a little explaining. This is a rule that I have instituted after years of observing the market's behavior in line with program trading. Generally, if

prices exceed the highest point reached during a buy program, then there isn't much hope of the program's effect being reversed, so you should close out your position. Similar thinking applies to the downside.

---

*Example:* Suppose the following prices are observed during a buy program:

S&P Price	TICKI	Comments
550.00	+22	Buy program is taking place
550.50	+26	Buy program is accelerating
551.00	+26	Program still going on
550.75	+20	Program winding down
550.50	+12	Sell signal

In this example, the S&Ps reached a peak price of 551.00 during the height of the buy program. Then, typically, they backed off a little bit before the system issued a sell signal. That sell signal came with the S&Ps at 550.50. You would set your stop at 551.20, just above the highest price reached during the program.

---

Since traders are allowed to *think* when trading, the setting of the stop in rule (c) is one of those places where thinking may come in handy. I typically adjust my stop based on the level of premium in the futures. If the premium is large—in excess of fair value—then I use the tightest stop because I fear that another buy program may be lurking just around the corner. However, if the premium on the futures is at or especially if it's below fair value, then I may give the position a little more room than just 0.20 over the high price reached during the program.

I generally trade only with *mental* stops, which forces me to think every time I reach a stop. I do this because I want a chance to evaluate the premium on the futures before I buy or sell them. I do *not* try to outguess the market; any system depends on adherence to a stop-loss point. It's just that I've found, through experience, that

there is something to be gained from observing the level of the futures' premium before I make a trade.

Once the position is in place, if unrealized profits begin to build up, I recommend using a trailing stop to lock in some of those profits. Generally, you should use a trailing stop of 1.70 or 1.80 S&P points. So, if you sell the futures and they subsequently drop by 1.80, begin to use a trailing stop of 1.80 from any subsequent low price for the rest of the day. In this manner, if you get a large move in your favor and it is later reversed, you will take some profits out of the position.

I would call someone a real-time trader if he is trading this system, since he should be able to watch the market and make these real-time decisions. However, if you would rather use a fixed level and not risk getting too emotional over the choice forced on you by a mental stop, then use the fixed 20 cents as specified in rule (c).

---

Here is the chronology of some actual trading that took place during a typical week in the summer of 1995. It will help to explain how the system actually works.

---

Date	Time	Sep S&P		TICKI	Action
		Futures	Premium		
Aug 24	12:20 P.M.	560.10	1.80	+22	On alert for a sell
	12:27 P.M.	559.70	1.20	+12	SELL
	4:15 P.M.	559.10 (never stopped)			Buy @ close (+0.60)

---

At the time of this example, fair value premium of the September S&P futures was about 1.10 points. Just after noon on this day (a Thursday, although that's not really important), a buy program entered the market. This program ballooned the premium to 1.80—well above the 1.10 fair value—and got TICKI up to +22, which put us on alert for a sell signal. A few minutes later, at 12:27 P.M., the buy program had abated, and TICKI was back down slightly to +12. That gave us our sell signal, and we sold the S&P futures at 559.70. Notice that the premium had shrunk back to 1.20 by that time, only slightly above fair value. As it turned out, this was a rather mediocre signal, as the market drifted quietly lower in the afternoon, and the trade resulted in a 60-cent profit when it was closed out at the end of the day.

That was the only trade of the day. However, over the next few days the system was active; and when it is active, that is generally when the best profits occur. The trading history for the next four days is:

Date	Time	Sep S&P		TICKI	Action
		Futures	Premium		
Aug 25	9:40 A.M.	560.60	2.00	+22	On alert for sell
	9:45 A.M.	560.40	1.20	+12	SELL
	3:18 P.M.	561.60			Stopped (-1.20)

The highest point that the futures had reached during the buy program of the early morning was 561.40. So when the futures eventually exceeded that point in the last hour of trading, the trade was stopped for a loss.

Date	Time	Sep S&P		TICKI	Action
		Futures	Premium		
Aug 28	9:35 A.M.	563.00	1.65	+22	On alert for sell
	9:40 A.M.	563.10	1.20	+12	SELL
	4:15 P.M.	559.40 (never stopped)			Buy @ close (+3.70)

Early buy programs produced a nice sell signal point early in the day, and the market traded down all day, resulting in a very good profit.

Date	Time	Sep S&P		TICKI	Action
		Futures	Premium		
Aug 29	9:40 A.M.	559.50	1.30	+22	On alert for sell
	9:44 A.M.	559.00	0.90	+12	SELL
	12:07 P.M.	556.50	0.40	-22	On alert for buy
	12:13 P.M.	557.20	1.20	-12	BUY <i>two</i> (profit +1.80)
	12:24 P.M.	556.40	0.50	-22	Stopped: rule (b) (-0.80)
	12:30 P.M.	557.00	1.15	-12	BUY
	4:15 P.M.	560.55 (never stopped)			Sell @ close (+3.55)

The action was interesting on this day, as the system generated profits in both directions. Initially, another early buy program resulted in a sell signal, which was closed out when sell programs came into the market just after noon. These sell programs resulted in a buy signal, and we bought *two*



futures: one to close out the short sale, and one to go long on the buy signal. This buy signal was aborted, however, at 12:24 P.M. when another sell program hit the market; we were stopped out of our long position because TICKI fell back down to -22 at that time. Finally, the second buy signal was generated at 12:30 P.M., and the market spent the rest of the day rallying, resulting in a very profitable trading day.

---

Date	Time	Sep S&P		TICKI	Action
		Futures	Premium		
Aug 30	9:42 A.M.	561.50	1.75	+22	On alert for sell
	9:51 A.M.	562.00	1.30	+12	SELL
	4:15 P.M.	561.15 (never stopped)			Buy @ close (+0.85)

---

Again, the market traded higher early, and those buy programs generated a sell signal. This was a moderate profit by the day's end.

---

When the market is in a trading range, the system is particularly effective. I'm sure everyone remembers days when a bit of news that was released before the market opened caused a gap opening, which was then reversed as the market spent most of the day trading in the other direction. This system is excellent at getting you into a profitable trade on days like that. Such news items are often the release of government figures such as unemployment, the consumer price index, or some similar item that affects both the bond and the stock markets. The preceding examples occurred during such a period. You can see the number of signals that occurred right after the opening of trading on five successive trading days: August 25 through August 30.

When the market is moving steadily in one direction during a trading day, the system is least effective. That's why we recommend ceasing trading on any particular day in which you are forced to take losses on two consecutive trades. Note that to take two consecutive losses, there have to either be three programs in the same direction or two programs followed by prices moving against you. The following examples demonstrate this fact.

---

Two consecutive losses could be created by three successive sell programs; for example:

1. Sell program #1: you buy the S&Ps when it's done.
2. Sell program #2: you stop yourself (presumably at a loss) when TICKI goes to -22 during program #2; when program #2 ends, you again buy the S&Ps.
3. Sell program #3: you stop yourself when TICKI goes to -22.

Two consecutive losses could also be created in this way:

1. Sell program #1: you buy the S&Ps when it's done.
  - 1a. The S&Ps trade lower anyway, and you are stopped out.
2. Sell program #2: you buy the S&Ps when it's done, again.
  - 2a. Again, the S&Ps trade to new lows, stopping you out.

There are a couple of other scenarios—combinations of the ones in the preceding example—that could cause two consecutive losses also. In all cases, however, there are two or three programs in the same direction consecutively that caused the losses. It is my experience that on days like that there are more programs to come, and it is best to stand aside rather than get run over. Fortunately, such days are rare, and the damage is limited by retreating to the sidelines after two consecutive losses are taken.

### **The Intraday Market-Reversal Corollary**

The market has made some very impressive intraday reversals over the years, on both the upside and the downside. Every day trader would like to be a participant during these times.

On Monday, October 5, 1992, the market was in a tenuous state. The market had dropped 75 points on the previous Thursday and Friday, including down 54 on Friday. To make matters worse, there had been selling overseas on Sunday night, so the market opened on the downside and began to melt down. By noon it was down 115 Dow points and over 13 OEX points. The premium in the S&P futures can be used to illustrate the level of panic in the market: at the low of the day, the S&P Index (cash) was down 13.67 points; but the futures were down 19.90 and trading at a discount of 6.80! In early afternoon, however, the market began to stabilize, and then it rallied heavily. Eventually, the Dow closed down 21 points on the day, while OEX was down only 2.42, and the S&P futures only lost 1.70 by day's end.

Another violent reversal day occurred on July 19, 1995, when technology stocks sold off heavily. The Dow dropped 134 points at its nadir, and OEX was down almost 16 points. There wasn't the same level of panic in the 1995 sell-off as there had been in the 1992 sell-off, however, as the S&P futures never even came close to trading at a discount all day. Once again, the market was able to stabilize and rally. On this day, it didn't come all the way back, but the Dow did manage to regain over 70 points from its lows by day's end. OEX, SPX, and the S&P futures all managed to rally between eight and nine points from their intraday lows.

---

The TICKI system will get you "in" on these reversals if they occur or the first on second TICKI signal. But you might be concerned about missing out on a good trade on days that reverse direction after more than two or three programs in one direction. By the rule for limiting losses on the TICKI system in one day, you would be standing aside and would miss the reversal. On the two major reversal days described just previously, there were repeated sell programs before the market eventually stabilized and rallied. Anyone trading the TICKI system would have taken two small losses during the morning and then would have been idle for the remainder of the day.

In order to be able to trade reversals after a large move, I have defined the following corollary to the TICKI system and used it with good success throughout the years: *after having sustained two consecutive losses with the TICKI system, reenter the market if it reverses by 1.75 off its extreme point.*

---

*Example:* The market has been selling off, and you have attempted to buy it twice after sell programs. However, both attempts were unsuccessful. The market then continues to sell off even more, perhaps under the influence of more sell programs.

However, by early afternoon, the market stops going down and begins to rally. Suppose that the low on the S&P futures at that time was 551.00. If the S&Ps then rise to 552.80, you would buy the market under this reversal corollary.

---

Similarly, to the upside, if you were forced to take two consecutive losses by the TICKI system as buy programs repeatedly entered

the market, then you would use the reversal corollary if the S&Ps fell by 1.80 from their ultimate daily high.

- Once a position is taken under the reversal corollary, you should stop yourself out if the futures subsequently move to new highs (if you are short) or new lows (if you are long).
- If you are not stopped out, close the position at the end of the day.

I have also found the 1.80-point reversal to be useful in taking profits on a TICKI trade. For example, if you are short the S&Ps because of a TICKI signal and they then trade down substantially, you have a nice unrealized profit. If the futures then rally 1.80 points from their low, you would cover your short futures and take your profit. I wouldn't use this type of reversal to go long also, just to cover the short as a sort of trailing stop.

*Note:* A 1.80-point reversal worked well when S&P futures were trading somewhere near 500, but it needed to be changed when the futures rallied to 1000. There are two ways you can make this adjustment. One is by trial and error: if you notice that you are trading many more reversals than you used to, or if you are missing out on almost all reversals, your reversal point needs to be changed. The other approach would be to use a reversal of about one-third of one percent of the S&P's value. The second approach is more dynamic and is the preferred approach.

There are a few other pertinent facts about the TICKI system. It will generally give you about one trade a day, on average, although the trades tend to come somewhat in bunches. Some weeks may be very dull, with only a little program activity; in those weeks, you would only have perhaps two or three trades. However, in a more volatile, trading-oriented market, you may get more trades, perhaps as many as 8 to 10 in a week.

As for profitability, I can only relate my personal experience, since I don't know of any database that contains historic intraday values of TICKI. The system generates slightly over 50 percent winners, where the average winning trade is about 70 percent more than the average losing trade. Finally, it should be noted that it is very time-

consuming to trade this system, since you virtually have to be “glued” to your quote machine when the system is trading. For that reason, it is not feasible for many traders.

## A SHORT-TERM TRADING SYSTEM

A short-term trading system has a slightly longer time horizon—usually a matter of at least several days to as much as several weeks—as compared to the intraday nature of the TICKI System described in the preceding section. This short-term system is based on detecting extremely overbought and oversold levels in the stock market, by using the number of advancing issues and the number of declining issues on a daily basis. When there is too large a preponderance of advancing issues over declines, the market becomes overbought, and this system looks to go short (or buy puts). Similarly, when there are too many declines, the market becomes oversold, and the system looks to go long.

There are many ways to view the advance–decline line, but generally most of them use the *net* of daily advances minus daily declines as the starting point. This system does, as well. The crux of the system depends on calculating a momentum oscillator each day. The oscillator itself is rather simple to compute and can be done at home by any reader, as long as he has a starting point.

Here are the specifics:

1. Subtract NYSE declines from advances = *net advances*.
2. Multiply yesterday’s exponential moving average by 0.9, and add it to 0.10 times today’s *net advances*.

Stated as a formula, the daily oscillator value is

$$M_1 = 0.9 * M_0 + 0.1 * (\text{Advances} - \text{Declines})$$

where  $M_0$  = yesterday’s oscillator value

Advances = number of advancing issues on the NYSE today

Declines = number of NYSE declining issues today

For example, if the oscillator closed with a value of 100 yesterday, and today there were 1,200 advances and 900 declines, then the new oscillator value would be 120:

$$M_1 = 0.9 * 100 + 0.1 * (1,200 - 900) = 120$$

because  $M_0 = 100$ ; Advances = 1,200; Declines = 900.

This type of computation is called an *exponential moving average*. In calculating an exponential moving average, we take a certain percentage of “yesterday’s number” and add 1.0 minus that percentage of today’s values. In the preceding example, we are using 90 percent and 10 percent, which gives a heavier weight to past data and only a 10 percent weight to today’s data. We can change the mixture by using 80 percent and 20 percent, or 75 percent and 25 percent, and so forth.

All that is required to begin calculating this oscillator for yourself is to know the value of  $M_1$  on any day and use the formula. McMillan Analysis Corp. will freely give the value of  $M_1$  to anyone who requests it via e-mail to [info@Optionstrategist.com](mailto:info@Optionstrategist.com).

The oscillator, as just defined, generally ranges between about +200 and -200. These are considered to be the “normal” values. Whenever the oscillator exceeds that range, however, you should take notice, for the market has become overbought or oversold.

The actual rules for entering a trade are very simple:

1. If the oscillator is less than -200, the market is oversold.
  - Once it is oversold, buy the market at the close on the day that the oscillator climbs back above -180.
2. If the oscillator is greater than +200, then the market is overbought.
  - Once it is overbought, sell the market at the close on the day that the oscillator falls back below +180.

This is a very reliable way of determining overbought and oversold conditions in the stock market. It has worked well for many years. It usually marks an intermediate-term turning point in the market. However, in some cases, it only identifies short-term movements.

In the ferocious rally that consumed the first half of 1995, the oscillator became overbought by exceeding the +200 level in May. At that time, the Dow had rallied 220 points in under a month. The oscillator remained overbought for eight consecutive trading days, while the market pushed another 40 points higher. Finally, the oscillator fell back below +180 and the Dow dropped 81 points in one day. However, that was the end of the decline, and the Dow went on to much higher highs over the course of the year.

---

On the other hand, the oscillator signals can also sometimes identify major turning points that last for months.

---

In late 1994, the market had been selling off rather steadily between September expiration and late October. At the time that the oscillator fell below -200, the Dow was down about 100 points from its September high. However, a succession of negative days followed, as there were consistently more declines than advances on most days. Over the next 35 trading days, the oscillator remained below -200 on 26 of those days. At its worst, it fell to -454. During those 35 days, the Dow lost another 180 points. Eventually, when the oversold condition subsided, the buy signal was generated in mid-December 1994, and the Dow rallied 1,200 points over the next nine months.

---

So this oscillator is useful in getting into a market that has short-term trading potential and may have even intermediate-term prospects. We have given the entry criteria but have not specified how to exit the trade. Obviously, if we use too close a stop, we will not be able to capitalize on the intermediate-term moves. Conversely, if we use too wide a stop, we will not profit when the market moves only a short distance in our favor and then reverses.

We ran a number of scenarios through the computer in order to optimize the results. The general scenario was that we wanted to trade the OEX with these signals. The system was to have a stop-loss point to begin with; but if OEX went in our favor, we would use a trailing stop to lock in profits. Furthermore, partial profits would be taken at two fixed points—one-third of the position being sold at each partial profit point. With these criteria, the system was further refined by setting the size of the stops and the partial profit points. It

turns out that these points were best set in terms of percent of OEX, rather than fixed distances.

This is the system that tested best in the computer simulation, although individual traders may want to modify it to their own tastes:

1. Set the initial stop to be 2 percent of the value of OEX at the time the trade is entered. For example, if OEX was 500 and a buy signal was generated, the initial stop-loss sell point would be at 490 (500 minus 2 percent of 500).
2. Sell one-third of your position to take partial profits if OEX moves 2 percent in your favor.
3. Sell another one-third of your position to take partial profits if OEX moves another 2 percent in your favor. Thus, if OEX was at 500 to begin with, you would take partial profits at 510 and again at 520.
4. Whenever you begin to take partial profits, from then on use a trailing stop of 2 percent of the value of OEX at that time. Raise the trailing stop each time OEX closes higher. Thus, if OEX was initially bought at 500, and then rose to 510, partial profits would be taken and the stop would be raised to 499.80 (98 percent of 510).

Using these criteria, the results shown in Table 5.1 were achieved, by year. The maximum gain was 38.6 points, while the maximum loss was 18.3 points. The median trade was a gain of 5.30 OEX points. The longest time any trade lasted was 155 calendar days, while there were six trades that were stopped out after one day. The median holding period was 23 days.

The reason that we used OEX for the purposes of the simulation was the limited risk of owning options. We could trade either S&P 500 futures or OEX options. The median gain of about three OEX points is enough to produce profits using either vehicle, assuming that if we're trading options, we buy at- or slightly in-the-money options.

### **Monitoring the Oscillator Intraday**

In certain cases, you can improve the entry point by anticipating the signals. In order to anticipate the signal, you need to observe the



**Table 5.1**  
**RESULTS ACHIEVED BY THE SHORT-TERM**  
**TRADING SYSTEM**

Year	Signals Profitable	Net Result in OEX Points
1984	5 of 6	+15.7
1985	6 of 7	+35.4
1986	5 of 5	+35.5
1987	5 of 9	+8.8
1988	4 of 8	-2.8
1989	2 of 5	-4.3
1990	4 of 7	+15.0
1991	5 of 5	+58.3
1992	4 of 4	+41.7
1993	4 of 5	+28.3
1994	6 of 12	+56.3
1995	3 of 9	-15.7
1996	7 of 11	+34.7
1997	9 of 12	+160.7
1998	10 of 15	+85.2
1999	5 of 10	+40.0
2000	5 of 10	+72.8
2001	6 of 10	+110.2
2002	9 of 14	+94.8
2003	5 of 12	+27.0
Totals	109 of 176 (62%)	+896.6

relationship between advances and declines in the afternoon of the pertinent trading day. Even if the broad market moves late in the day, it is often unable to effect much change on the relationship of advances and declines. This is true because many smaller and less liquid stocks make their initial moves in morning trading and won't follow a large market reversal much in the afternoon. As an example, assume that the Dow is down 30 and that declines outnumber advances by 800 issues in late afternoon. Even if the Dow rallies to unchanged or maybe even slightly positive levels, declines will still dominate at the end of the day—not by 800 issues certainly, but

probably by several hundred anyway. Obviously, the *depth* of some of the declines will not be as great at the close as when the Dow was down 30, but most of the stocks will still wind up losing ground on the day. This fact can be useful in anticipating signals from this oscillator.

Going into any trading day, you know what level of advances and declines will produce a signal. For example, if the oscillator is at +220 the end of a trading day, then you know what level of advances and declines will produce a sell signal on the next trading day. The next day's oscillator will be the *net* advances plus  $0.90 * 200$  (= net advances + 198). It is obvious that if there are 180 more declines than advances, you will subtract at least 18 (10 percent of -180) from 198, and you will get the desired 180 to trigger the signal. So when the next trading day begins, you can look for that level. For example, if declines are outnumbering advances by 500 issues or more, and it is midafternoon, it is likely that the sell signal will be confirmed. Thus, you might decide to establish your position at that time—a few hours early.

The 81-point one-day decline in the Dow, mentioned in a previous example, is a classic case in favor of anticipating the signal. The oscillator had closed at 201 the previous night. Ninety percent of 201 is 180.90. So, on the next day, if declines outnumbered advances by *any* amount, a sell signal was going to ensue. By 1:00 P.M., the Dow was down about 35 points, and declines were swamping advances by about 800 issues. It was fairly apparent that the advancing issues would not be able to recover. I bought puts at that time. The subsequent late-afternoon rout drove the Dow to its 81-point loss, making the put purchase very profitable. As was often the case that year (1995), market declines were fierce but short-lived. The entire down move had taken place in that one day.

Another use of monitoring the signal, intraday, is illustrated by the following example. In this particular situation, which can occur in extremely fast-moving markets, the oscillator becomes overbought or oversold intraday but doesn't hold those levels for the close of trading. Technically, then, you do not have a trading signal. However, as a practical matter, a short-term trade may be at hand, even though it doesn't conform to the system in the strict sense.

In October 1995 the market was selling off rather swiftly (that sell-off, by the way, *had* been correctly signaled by an oscillator signal in mid-September). On October 9, the Dow closed down 43 points, and the oscillator stood at  $-147.18$ . The next day, the market was under tremendous pressure and was down 67 points at midday. Declines outnumbered advances by about 1,300 issues at that time, so the intraday calculation of the oscillator would have shown it to be well into oversold territory with a reading of about  $-262$  ( $0.9 \times -147.18 + 0.1 [-1,300] = -262.46$ ).

At that point, the market began to rally as tech stocks recovered rapidly from their lows; the tech stocks had been the market leaders for most of 1995, so their movements were important to the market as a whole. As the rally progressed, shorts began to cover, and the Dow nearly recovered all of its lost ground. It closed down only five points on the day. Meanwhile, the differential between advances and declines shrank also, although, as was pointed out earlier, it is virtually impossible for that many declines to turn into advances in the afternoon of any trading day. In any case, at the close, declines only outnumbered advances by about 500 issues. Therefore, the oscillator value at the close of trading was about  $-182.46$ , *not* in oversold territory.

So, even though a buy signal was not generated by our rules (the oscillator never closed below  $-200$ , which is the first criterion), it was fairly obvious that the market had been deeply oversold at midday. Moreover, the large reversal rally was obviously impressive, bringing the Dow 62 points up off the lows. So, was a buy signal generated by the intraday action, or was more selling due because the oscillator closed just above the oversold  $-200$  level? In this particular case, the Dow rallied another 73 points over the next three days. Thus, the intraday buy signal was correct.

---

The point that can be drawn from this example is that the oscillator can be used for confirmation of an intraday move. You might have been tempted to buy the market anyway, based on the large reversal move in the Dow (62 points from the low). However, the fact that the oscillator had penetrated so deeply into oversold territory during the day, and had then risen out of oversold territory by the end of the day, was good confirmation that the selling pressure was over and that a short-term upward move was probable.

This is not to say that you have a buy signal every time the oscillator penetrates the oversold level intraday and then closes outside of it. However, when you have a concomitant market reversal, as in

the preceding example, then the intraday oscillator acts as a confirming indicator. Obviously, similar scenarios can be constructed for intraday overbought situations when the oscillator is near the +200 level.

The oscillator has had some very wide swings in recent years. Figure 5.1 shows the history of the oscillator from late 1998 through early 2004. It is interesting that this time period encompasses not only the all-time low reading for the oscillator (during the October “massacre” of 1998) but also the all-time high reading (during the spring of 2003, when the market just continued to rally day after day on very positive breadth).

There are some other interesting points that stand out. There were two extremely oversold conditions in 2001 and 2002. The first occurred in the selling that took place after the terrorists attacks on 9/11/2001. The second was in July, as the bear market was ending its steep decline during that month. Neither was quite as negative as October 1998, but they were certainly close.

**Figure 5.1**  
**OSCILLATOR: 1998–2004**

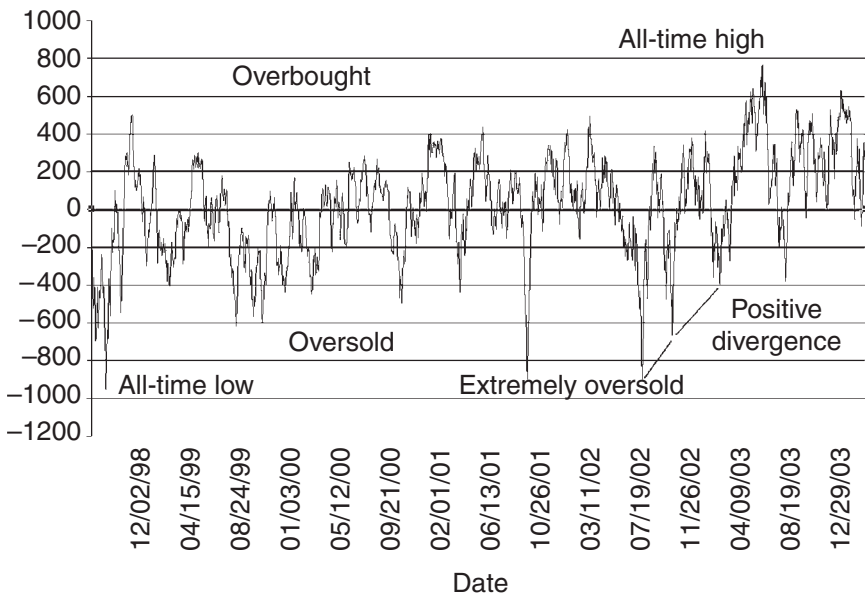

Also look closely at what happened after that, in 2002. The market actually made a slightly lower low in October 2002 (not shown on chart), but the oscillator did not. It reached deeply oversold levels, but it did not exceed the July low. Hence, that was a positive divergence—the market made a new low, but the oscillator registered a higher reading. This can be interpreted as a long-term buy signal—and indeed it was, eventually. Furthermore, the broad market returned to the same levels in March 2003, as the war in Iraq loomed. Yet, the oscillator made still another higher reading. So there was a sequence of three points that showed the oscillator making a positive divergence. The bull market that followed was a very strong one.

Finally, one other longer-term view can be obtained from the oscillator: if the oscillator gets *extremely* overbought, it is very positive for the market (and if it gets *extremely* oversold, that's negative). Consider the action in 2003, from April onward. The oscillator spent the better part of a year above +200—actually exceeding +600 on many days. Those readings broke the old records quite easily. Yet the market continued to climb higher and higher. There is an old adage that a bull market is very overbought at its inception—and that's a good thing. This oscillator picture certainly confirms that.

Furthermore, the oscillator was below -200 for a long time in June and July of 2002, yet it was no time to be a hero and jump in just because the market was oversold. The market continued to decline, day after day, getting more and more oversold. It was necessary to wait for the buy signal to actually occur before one could buy.

In fact, a good rule of thumb for all traders is this: "Overbought does not mean 'sell,' nor does oversold mean 'buy.'" Remembering that one rule will keep you out of trouble in strongly trending markets. Don't fight the trend even if it is clearly overdone. As John Maynard Keynes said, "The market can remain irrational longer than you can remain solvent."

## **Problems with the Advance–Decline Line**

In July 2001, we began to notice a discrepancy between the market's behavior and the NYSE advance–decline line. Specifically, the

advance–decline line was making new highs, yet the market was languishing. In fact, we had sell signals from several of our indicators, and it was obvious that the market was struggling. Yet, bullish commentators repeatedly invoked the positive nature of the advance–decline line as a harbinger of a bull market to come. This seemed strange to us, but they were right—the advance–decline line *was* making new highs. About the same time, Richard Russell, publisher of the *Dow Theory Letter*, noted that nearly half of the issues trading on the NYSE were not stocks—they were warrants, preferreds, funds, and so on. Moreover, a large number of these were interest-rate related and were thus distorting the NYSE advance–decline figures.

Why should interest-rate-related issues distort the figures? Because interest rates were falling all during 2001 and were making those issues advance, thereby creating more advances on the NYSE than a “stocks only” measure would have shown. The NYSE *does* actually publish an “operating companies” advance–decline figure on their web site, but it is not disseminated to the news media or to data suppliers. At this point, we decided to do our own research. Realizing that we have a ready-made database of stock data—all the stocks on which listed options are traded (over 3,000 of them)—we decided to use *that* data to construct our own “stocks only” advance–decline figures.

At the time (July 2001) the contrast was startling. It is shown in Figure 5.2. The upper line on that graph is the common NYSE advance–decline line. You can see that it *was* trading at new yearly highs. However, the bottom line is the one constructed by using only the optionable stocks to create an advance–decline (the “stocks only” advance–decline line). It is moving *downward!* Hence, there *was* a huge discrepancy between the two.

We were sure that the “stocks only” line was more reflective of the true state of the market. So we endeavored to find out why this discrepancy was occurring. One reason was that the Federal Reserve System (Fed) had been lowering interest rates since early 2000 (point A on the chart, Figure 5.2). However, that alone could not explain things. Moreover, the fact that 48 percent of the issues on the NYSE are not stocks isn’t the real reason, either.

A little history might be appropriate. Apparently, about half the issues on the NYSE have not been stocks since the late 1940s

**Figure 5.2**  
**NYSE ADVANCE-DECLINE LINE**

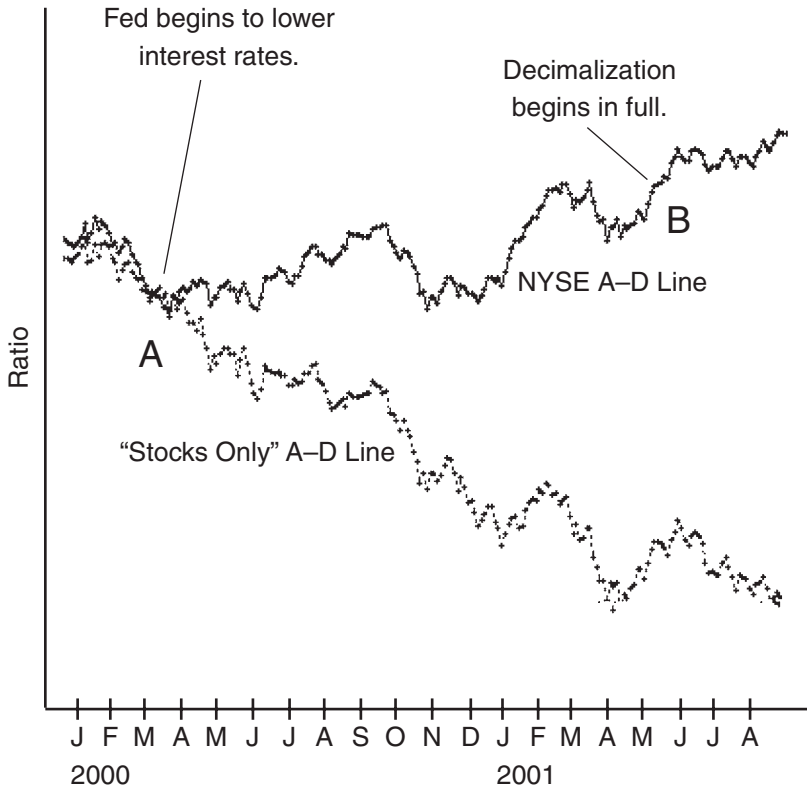

(preferreds account for most of the difference). Moreover, the Fed had certainly lowered interest rates at times in the past, and yet the advance–decline line had not behaved in such an opposite manner to the truth. Thus, there was no reason why those two factors would be causing this discrepancy in July and August of 2001.

It turns out that they were contributing factors, of course; but the *real* culprit was decimalization, which had been phased in early in 2001 and completed by the spring of 2001. Consider this scenario as to why decimalization was (and still is) a problem. Suppose that a

preferred stock is trading at \$40 per share. Moreover, suppose that the bond market is up 12 ticks today (that's  $12/32$ , or  $3/8$ —less than half a point). While that's a nice little rally in bonds, in the days before decimalization, it wouldn't entice anyone to pay up to  $40\frac{1}{8}$  for that preferred stock. That would have been too large a yield adjustment. However, in the days of decimalization, someone might pay up to 40.01 or 40.02 for the preferred stock, thus qualifying it as an advancing issue. While we addressed this issue early on, traders are still grappling with it. For example, some have suggested eliminating issues that only advance or decline by a few cents. They claim that produces a "truer" figure.

To date, interest rates have not really risen, and so the positive bias of the NYSE advance–decline line persists. However, when interest rates finally start to rise, the opposite will happen: the NYSE advance–decline line will underperform the "stocks only" line, for *then* the interest-rate-related issues will be declining.

This problem with the advance–decline line affects every technical indicator that uses market breadth as a factor. This include the Arms Index (named after its inventor, Richard Arms), for example, which certainly had its share of seemingly "strange" readings during the 2001–2002 period. We are concerned, of course, with how the problem affects our oscillator. It is a simple matter to compute the oscillator using "stocks only" advances and declines, rather than NYSE advances and declines. In fact, we constructed a trading system based on the "stocks only" oscillator—one similar to the system presented earlier in this chapter. As one might suspect, a similar system using the "stocks only" data produced better results, because the distortions caused by the NYSE advances and declines were not present.

I don't think you should ignore the NYSE figures completely, but you should be aware that they may be suspect on days when interest rates have a big move. In fact, we currently keep both oscillators on a routine basis, and we supply the "stocks only" data in all of the newsletters that we publish.

There has been a request by technicians for the NYSE to publish advance–decline numbers based only on "operating companies." But they have ignored that request (or the media have) for quite some time, so I wouldn't expect to see it anytime soon.



## INTERMARKET SPREADS

In option terminology, we usually think of a spread as being long one option and short another option, with both options having the same underlying security. However, in a broader sense, whenever we are long one security and short another related security, we have a spread in place. Such a spread might be established with stock, futures, or options. Stock traders often call these positions "pairs trades" rather than spreads.

Within this broad concept of spreads, we can divide all spreads into two broad categories: *intermarket* spreads and *intramarket* spreads. Intramarket spreads involve spreading futures or options that have the same underlying stock or commodity. For example, going long December corn and simultaneously shorting September corn would be an intramarket spread using futures. An intramarket spread using options would be any of the normal options spreads, for example, buying the IBM Jan 100 call and selling the IBM Jan 110 call. This is an intramarket spread because both sides of the spread are options on the same underlying security, IBM.

Intermarket spreads are spreads that, as the name implies, involve one market spread against another. They may be closely related markets, such as T-bonds and municipal bonds, or they may be more loosely related, such as T-bonds and utility stocks. An intermarket spread may even be a spread between two stocks that have a tendency to move somewhat in unison, a strategy called *pairs trading*. In any case, there is normally a well-defined historical relationship between the two markets. Within that relationship, however, swings can occur. When the swings are wide enough, there are opportunities to profit by trading the two markets against each other.

There are general relationships between many markets. The idea behind interindex spreading is often to capitalize on your view of the relationships between the two indices without having to actually predict the direction of the stock market. Note that this is often the philosophy behind many option spreads as well. For example, have you ever heard some analyst say that he expects small-cap stocks to outperform large-cap stocks? This analyst should consider using an interindex spread between the S&P 500 Index and the Value Line

Index (which contains many small stocks) or perhaps between the S&P and an over-the-counter index. If he buys the index that comprises smaller stocks and sells the S&P 500 Index, he will make money if his analysis is right, regardless of whether the stock market goes up or down. All he wants is for the index he is long to outperform the index he is short.

Before getting into specific markets that have proven to be tradeable over time, we describe the two main strategies for implementing the spreads: using futures or using options. The simplest way to implement a spread is to use futures, or the equivalent position. For example, if we were spreading T-bonds against muni bonds, we could use futures in both markets. However, if we were spreading T-bonds against the Utility Index, we would have to use the *equivalent* of futures.

---

When you are trading an index—particularly a sector index—as part of an intermarket spread, you can't actually buy or sell the index itself; and you can't normally buy or sell a futures contract on the sector, either. However, by using options and a knowledge of equivalent positions, you can establish a "futures equivalent" or "index equivalent" position. For example, if you are attempting to buy the index as part of an intermarket spread, then you would merely buy a call and sell a put with the same terms. As you know, this is the equivalent of going long the index. Since the call and the put have time value premium, what you actually establish is the equivalent of a futures contract on the index. Conversely, if you want to short the index, you buy a put and sell a call.

---

So, whether you use futures or the equivalent thereof, you establish the intermarket or intramarket spread in its simplest form. With this type of position, your profit potential is straightforward—if the two futures move in the correct direction, you will profit; if they don't, you will lose money.

There is, however, another way to establish these spread positions: with options. If, instead of buying (equivalent) futures on one side of the spread, you buy an in-the-money call, you have similar profit potential. You can make unlimited profits just as the futures can, but you give up whatever time value premium you spent to buy the call. If the call is far enough in-the-money, that time value

expense will be small. Thus, the profit potential between owning the future and owning the in-the-money call is similar. There is one major difference: the call can only lose a fixed amount, while the (equivalent) futures position has virtually unlimited downside risk. Similarly, if you buy an in-the-money put instead of shorting the (equivalent) futures contract, you have similar characteristics. Thus, the option intermarket spread would be constructed by buying an in-the-money call and an in-the-money put.

What this means is that the option intermarket spread has an additional chance to make money that the (equivalent) futures position does not: it can make money if prices are volatile, even if the spread between the two markets does not converge as expected. For example, suppose that prices fall by a great deal (in both markets), but the spread between the two markets does not converge. Then the intermarket spread using (equivalent) futures would not make money. However, the option intermarket spread *would*, because the call would only lose a limited amount to the downside, whereas the put would keep making profits. Thus, with the option intermarket spread, you can make money if either (1) the markets converge as expected, or (2) prices are volatile and move a good deal in either direction. The option trader must pay time value premium for this privilege; but if he uses in-the-money options, he can keep the time value expense to a minimum.

Later in this chapter, we specifically discuss intermarket spreads using gold futures and gold stocks, but for now we present a true-life example from those markets in order to demonstrate the advantage of using options in these spreads.

---

In late 1995, gold stocks had rallied quite a bit, while the price of gold had not. Thus, we thought that the two markets would converge, and we recommended that our customers buy puts on gold stocks and calls on gold futures. The recommended prices were:

Gold Stock Index (\$XAU): 120	XAU Feb 125 put: 8
April gold futures: 389	Gold April 380 call: 10.50

An equal number of calls and puts were purchased, with each put-and-call combo costing 18½ points (\$1,850).

Things didn't work out as forecast, for gold stocks continued to outperform gold futures. However, both markets started to move higher quickly. This was the saving grace. A couple of months later, these prices existed:

\$XAU: 138

April gold futures: 407

XAU Feb 125 put: 1

Gold April 380 call: 27.00

The combo was now worth \$2,800. The call's price had increased in value by quite a bit (\$1,650), but the put could only lose a limited amount. Thus, the option strategy made a profit, whereas a straight intermarket index hedge would not have.

---

## European Options

Before discussing the intermarket spreads, it is necessary to spend a moment or two talking about some of the more intricate properties of European options. Most index options and sector options are European-style. As you probably recall, this means that they can't be exercised until the end of their life. As a result, their price behavior is somewhat different from the American-style option that most people are accustomed to.

The main difference is that *European options can and do trade at discounts to parity prior to expiration*. This is true for both puts and calls, although it is more prevalent with puts. This discount is strictly a function of the mathematics of arbitrage and option pricing, and has nothing to do with how markets are made or with any type of supply/demand situation.

To understand why this is true, you need to look at the situation from the viewpoint of an arbitrageur. First, let's understand why American-style options do not trade below parity. Suppose that a trader has been fortunate enough to have bought an American-style put and then sees the underlying stock decline substantially in price, to the point where the put is 20 points in-the-money. The trader now decides he wants to sell his put, and he can be certain that he will obtain 20 (or maybe a small fraction of a point less) for it. Why? Because an arbitrageur or market maker can:

1. Buy the put from the trader, and
2. Buy the underlying stock, and then
3. Exercise the put to remove the arbitrage position.

In order to provide this “service,” the market maker will generally not pay the full 20 points for the put but will discount it by a fraction of a point so he (the market maker) can make some money on this transaction also. Notice that the market maker never has any risk, for he is hedged at all times (the stock and option trades—steps 1 and 2—will be executed simultaneously). The following illustrates such a trade.

---

*Example:* Assume that the trader owns an XYZ Dec 100 put and that the stock is trading at 80 in November. He wants to sell the put. The market maker sees that he can buy stock at 80, so he tells the trader that he will pay him  $19\frac{7}{8}$  for his put. The trader agrees, and the trade is done. The market maker paid a total of  $99\frac{7}{8}$  (80 for the stock and  $19\frac{7}{8}$  for the put) and got back 100 when he exercised the Dec 100 put (to sell stock at 100). Thus, the market maker made an eighth, without risk, and the trader got out of his put at virtually parity.

The following sums up the transaction from the market maker’s point of view:

Buy Dec 100 put @ $19\frac{7}{8}$	\$1,987.50 debit
Buy 100 shares of XYZ at 80	\$8,000.00 debit
Exercise the put to sell 100 shares of XYZ at 100	\$10,000 credit
Net credit:	\$12.50 credit

Since the market maker pays virtually no commissions, he has a profit on this arbitrage.

---

Thus, any American-style put can be sold for nearly parity at any time during its life because of the arbitrage that can be constructed by the market maker to whom the put is sold. The same sort of thing is true for an American-style, in-the-money call. The trader who owns an in-the-money call that is American-style can be certain that he can

sell that call at any time for nearly parity. In the case of the call, the market maker simultaneously (1) buys the call and (2) sells the stock (short exempt), and then (3) exercises the call to completely close out the position. Again, the market maker may try to make an eighth of a point by buying the call at a slight, fractional discount to parity.

When European-style, in-the-money options are owned by traders who want to sell them prior to expiration, the market makers are generally the ones who are going to buy them. However, the arbitrage takes on a slightly different character because the market maker can't exercise the option as he could in step 3 to close out the position. Rather the market maker, after he (1) buys the in-the-money option from the trader and (2) hedges his risk with the underlying stock, then must *hold the position until expiration*. This ties up the market maker's money for what may be a considerable amount of time, so he must make allowances for this fact by adjusting the price that he is willing to pay the trader for that in-the-money option. Again, an example will clarify this concept.

---

*Example:* A trader owns a Dec 100 put on a stock that is trading at 80, and the trader wants to sell the put a month before expiration. Assume, however, that now the option is European-style. The market maker of this option now faces the following situation. He would still like to make a riskless eighth of a point for his trouble. However, when he now (1) buys the put from the trader and (2) buys the underlying stock, he has to wait a month until expiration arrives before he can complete step 3: exercising the put and removing the position. Thus, the market maker will adjust his bid for the put to reflect his "carrying cost" of the position until expiration. He usually does this by figuring how much it would cost him to carry the striking price, \$100 in this case, for the required time—a month, in this example. If his annual rate for borrowing short-term money is 12 percent, then that means that the market maker would have a cost of 1 percent to carry the position for one month. That is exactly \$1. Therefore, the put will trade at a discount to parity of 1 point.

The whole transaction would go like this, from the market maker's viewpoint:

- A month before expiration:
  1. Buy the put from the trader for  $18\frac{7}{8}$  (1 point less than he would have paid for an American-style put): \$1,887.50 debit.

2. Buy the stock for 80 (\$8,000 debit).

Thus, his cost is  $98\frac{7}{8}$  (\$9,887.50) so far, which we will assume he borrows from his clearing house or his bank.

- At expiration (a month later):
  3. Pay his bank \$100 for the interest on the loan (\$100 debit).
  4. Exercise the put and receive the strike price: 100 points (\$10,000 credit).

His net profit is the same eighth of a point: \$10,000 less \$9,887.50 paid for the position initially, less the \$100 in interest, equals \$12.50 profit.

Disregarding the eighth of a point that the market maker takes as profit, the European-style put sells for 19, while its American-style counterpart sells for 20 (parity). You may be thinking, "What if the market maker doesn't have to borrow the money from the bank. Wouldn't that lower the cost?" Actually, that would change nothing, because if he uses his own money, then he will still "charge" for the lost opportunity cost of not being able to use his money to earn interest until expiration.

The preceding example was overly simplistic in that it ignored two factors that could help *increase* the price of the European put: (1) dividends and (2) the price of the call with the same striking price and expiration date. The reason that dividends are important is that they increase the price of any put, European or American. For example, if the stock in the preceding example were going to pay a 25-cent dividend during the remaining month of the put's life, then the put would be worth about a quarter of a point more than the prices in the example.

The call price figures into the equation as well, for the market maker or arbitrageur can reduce *his* overall expense by selling that call at the same time that he buys the trader's put. This reduces the market maker's overall expense, which he can pass along to the trader in the form of an increased put price.

Let's continue with the previous example.

*Example:* Suppose, again, that a trader wants to sell a Dec 100 put when the underlying stock is at 80, about a month before expiration. However, now we are going to incorporate one other piece of information: there is a Dec 100 call selling for a half point. The arbitrageur's actions can now be summarized as follows:

<i>Action</i>	<i>Cost</i>
Buy the Dec 100 put at $19\frac{3}{8}$ from the trader	\$1,937.50 DB
Buy the stock at 80	\$8,000 DB
Sell the Dec 100 call at $\frac{1}{2}$	(\$50 CR)
Total Debit	\$9,875.50 DB

As you can see, this is the same initial debit as in the preceding example. The market maker will then pay the \$100 in interest to his banker and eventually exercise the put *or be assigned on the call*—collecting 100 points, or \$10,000, and closing out the position in either case.

The difference here, though, is that the trader was paid  $19\frac{3}{8}$  for his put, not  $18\frac{7}{8}$  as in the previous example. Thus, the price of the call is important in determining the amount of discount (if there is any discount at all) of the in-the-money European-style put.

The more time that remains in the life of an in-the-money European option, the deeper will be the discount, because the market maker's borrowing costs will be larger. In the preceding example, we were talking about the discount on a relatively short-term option—it had only one month of life remaining. However, there are LEAPS options on indices that extend out two years or more. The discounts on these longer-term European-style puts can be very significant.

These deep discounts on longer-term European-style put options are something that traders should factor into their projections.

The first rather widespread encounter between the reality of European-style option discounts and put owners occurred in the American Stock Exchange (AMEX)-based Japanese Index puts (symbol: \$JPN) in the early 1990s. The Japanese stock market, as measured by that country's Nikkei 225 Index, had peaked out at about ¥40,000 and was in the process of falling to nearly ¥15,000 in the course of the next couple of years. The Japan Index is a



surrogate for the Japanese stock market, and it has a value that is about one-hundredth of the value of the Nikkei. So, roughly, the JPN Index fell to nearly 150 (the JPN index didn't exist when the Nikkei was at ¥40,000, but it would probably have been near 400 if it had).

There were European-style LEAPS puts listed on the JPN Index; and some had strikes as high as 280, which meant they were over 100 points in-the-money with over a year of life remaining when the JPN Index neared the bottom of that bear market. Consider a Jan 280 put with a year of life remaining and the JPN Index at 180. You can safely assume that the Jan 280 call was essentially worthless, so it was of no help in increasing the price of the put. Even at 5 percent interest, the cost of carrying \$28,000 (the strike price) for one year is \$1,400. In option terms, that's 14 points. So the Jan 280 put was theoretically selling for 86, when parity was 100.

In reality, with index options, the discount bid by the market makers may be even slightly deeper because it is more difficult for them to hedge an entire index—they have to buy all the stocks in the index, rather than just one stock, as in the previous examples. This increases their clearing costs, to say nothing of their having to buy lots of stocks, each one on the offering price. These factors caused the actual bid for that put to be about 84.

There were even some minor lawsuits by investors who felt that the discount on the puts was arbitrary and unfair. Of course, it wasn't—the puts were properly priced—but in those days, many public traders didn't understand the concept of European options well, and so some felt that the market makers simply lowered their bids to extreme levels because they knew that these traders were long and wanted to sell. Trader paranoia? Yes. Incorrect pricing? No.

---

Of course, if you were bearish when the market was much higher and bought that put for, say, 10 points, you are probably not so concerned with whether you sell it for 84 or 86, since you have a phenomenal profit in either case. However, it is important to understand that you are not going to be able to sell it for 100 if expiration is a long way off.

This concept of discounts on European-style puts could also be important if you are buying the puts as protection for a market decline, since the discounted puts will not provide as much protection if the market falls quickly and there is still a great deal of time until expiration.

Do European-style calls suffer the same fate? The answer is no, unless the underlying pays a large dividend. To understand why, it is again necessary to view things from the arbitrageur's viewpoint. When a trader who owns a European-style, in-the-money call wants to sell it, the market maker buys it and immediately hedges himself by *selling (short)* the underlying stock. This transaction creates a credit in the arbitrageur's account, on which he can collect interest. So, he is perfectly willing to hold the position until expiration and earn interest. Thus, he will pay the trader full parity (or maybe even a little more) for the call.

The exception would be if the underlying pays a lot of dividends during the remaining life of the option. Since the arbitrageur is short the underlying stock, he will be paying out those dividends as time passes. Therefore, he will discount the original price that he pays the trader for the call by the present value of all the remaining dividends. Note that in the case of an American-style option, a market maker who is both long an in-the-money call and short the underlying stock will merely exercise his call on the day before the stock goes ex-dividend, thereby saving himself the dividend expense. However, with the European-style option, the market maker cannot exercise prior to expiration, so he is forced to pay out those dividends.

---

A trader buys a July 60 long-term, European-style call option and subsequently has the good fortune to see the stock rise to 90. At this point, assume there is still a year of life remaining in the call, but the trader wants to sell. Furthermore, assume that the stock pays a quarterly dividend of 50 cents, or a total of \$2.00 over the next year. The market maker will bid 28 for the call: that is parity (30) less the 2 points for dividends that he will have to pay out from being short the stock over the course of the next year.

---

In reality, the present worth of the dividend is not the full \$2.00, but it's probably more like \$1.80 or something, depending on interest rates. So the *exact* price that the market maker pays might be slightly more than 28, but the concept is illustrated correctly in this example. Also, if the July 60 put is worth anything, its value may increase the value of the call as well.

This feature of European-style calls can be significant if you are dealing with a high-yielding stock or index, such as the Utility Index (\$UTY), especially if a significant number of stocks that compose the index are about to go ex-dividend. Many stocks go ex-dividend in early February, May, August, and November. So in-the-money, European-style call options expiring in those months may trade at discounts even though expiration is nigh.

---

One firsthand experience of the dividend affecting a European-style call option occurred in a 1993 trade of the Philadelphia Stock Exchange's (PHLX's) Utility Index (\$UTY). I was long the Dec 210 calls, with the index at about 214. The index made a nice move in my favor, rising quickly to 233, by late November. Thus, the calls were 23 points in-the-money. However, when I checked the market, it was only bid at 21¼. The reason was that many of the stocks that made up the Utility Index were about to go ex-dividend; the total of these dividends was about two points, in UTY terms. Moreover, since there was so little time remaining until expiration, the market maker couldn't really earn any substantial interest from being short the stocks in the index for only three weeks until expiration. However, he was going to have to pay out the dividends against the short sales that hedged his position. Thus, his bid for the calls reflected a discount equal to the \$2 in dividends, less a small amount for interest that he could earn over the course of the three weeks.

---

If you find yourself wanting to sell a European-style option, but you're dubious because it's trading at discount because of dividends, my advice would be to sell it anyway. It's not mispriced—it's supposed to be trading at a discount. You may be tempted to wait until the ex-dividend date is past before selling. First, that will gain you nothing theoretically, because the underlying stock or index will drop in price by the amount of the dividends. Thus, even if the call is *then* selling at parity, it will theoretically be selling at the price you are currently seeing. Second, it is generally a mistake to delay a sale for the pure reason of something like this. Taxes are another common example; many people want to sell a stock, but decide not to for tax reasons, only to see it drop substantially in price, thereby costing them much more than they would have had to pay in capital gains taxes.

This concludes the discussion of European-style options. We have included it here because many of the intermarket spreads that we discuss in the remainder of this chapter involve using European-style index or sector options. If you are trading those options, you should have a thorough understanding of the concepts just described, or you will find yourself at a disadvantage.

Now, let's turn our attention once again to the intermarket spread using options. Recall that the option spread gives the trader a possible advantage over the (equivalent) futures spread when markets are volatile. Let's look at some of my favorite intermarket spreads. Some of these have longer time horizons than others, but most are held for several weeks.

### **The HUG/HOG Spread**

No, this doesn't have anything to do with giving a loveable squeeze to a farm animal, even though the name might seem like it. Rather, it's a spread between the February heating oil futures contract (symbol: HOG) and the February unleaded gas futures contract (symbol: HUG).

It is a rather well-established fact that in the fall of the year, unleaded gasoline futures outperform heating oil futures. Now, this might seem illogical at first, unless you have an understanding of the way that markets work. After Labor Day, families are no longer vacationing or traveling as much, so the demand for gasoline should slack off, right? Right. Also, as the winter approaches, the demand for heating oil should increase, right? Right. So how in the world can unleaded gasoline futures outperform heating oil futures during that time period? Because it is the job of the marketplace to discount future events.

Historic price charts tell us that the futures market tends to have done most of the discounting for these February futures contracts by September of the preceding year. Moreover, a sort of worst-case scenario is often built into the discounting mechanism. So, if things are "bad" as the fall unfolds and winter develops, then the spread between heating oil futures and unleaded gas futures will remain about steady. However, if things aren't as bad as the discounting

allowed for—as is often the case—the unleaded gas futures will outperform heating oil futures. Thus, it is a low-risk spread to buy February unleaded gas futures and sell February heating oil futures against them; the spread is usually established in September or early October and held into December.

---

You may be saying, “Wait a minute. I hear radio ads all during the fall saying that I should buy heating oil options because winter is approaching. What’s going on here?” I would respond to that question in two ways. First, are you the only trader who knows that winter is approaching? If you are trading based on obvious information or on information that has already been made widely public, then you can be assured that that information is already factored into the price of whatever you are trading, and you have no edge because of that information. Second, if you are buying options because of what you hear in a media ad, then you deserve what you get as a result. Also, check out the commissions those radio guys are charging, and you’ll see who stands to make money from buying those options.

---

It should be pointed out that the price of heating oil may go up as the winter approaches (or it may not), but we have no directional bias in this spread other than to want unleaded gas to outperform heating oil. So, the spread can move favorably for us if prices of both products move higher or if prices of both products move lower. We don’t care.

In order to see how this spread behaves in general, let’s start out with a composite graph of the spread, covering the years 1992 through 2003, which is shown in Figure 5.3. Specifically, we used the futures expiring in February 1992 through the futures expiring in February 2003 to construct this graph. Recall that a *composite* graph is constructed by averaging the data points at each day over the 12-year period. It is possible that no one year actually behaved as the composite graph depicts, but the graph is a good guide as to the tendencies of the futures during this time period.

In this spread, we sell heating oil futures and buy unleaded gas futures. The composite graph shows it that way—heating oil minus unleaded gas. So, when the graph is declining, profits result. The composite graph only shows the spread over a five-month period—from September 1 through the end of the following January, when the futures expire. You can see from Figure 5.3 that the spread is

**Figure 5.3**  
**HEATING OIL/UNLEADED GAS COMPOSITE SPREAD:**  
**1992-2003**

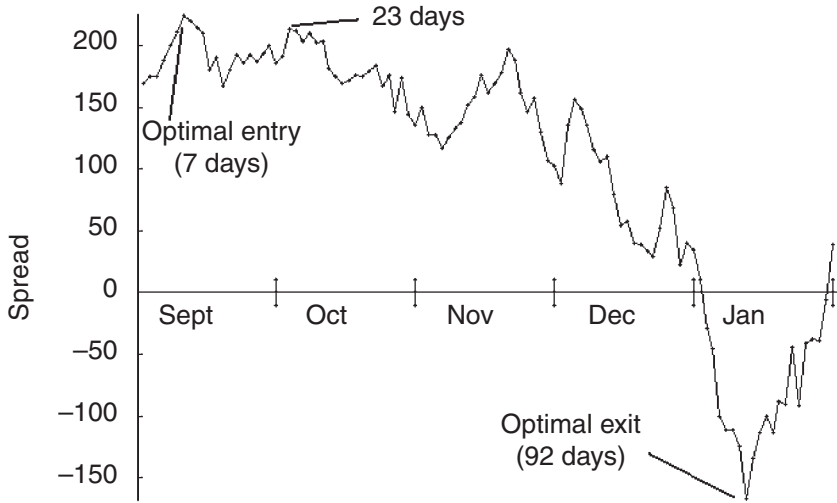

rather flat in September and early October. Then it declines for most of November before rallying again in mid-November. Once that rally tops out, the spread declines in earnest, to a low in mid-January.

With Figure 5.3 as a guide, we'd want to enter the spread in September, 7 trading days into the month and exit it 92 trading days later, in mid-January. Realistically, though, not much happens during September, so the entry point in early October—23 trading days after the end of August—is nearly as good as the one in early September. Using these procedures, the position is only open for about three months—from early October through mid-January of each year.

Both heating oil and unleaded gas futures are worth \$420 per point of movement. The composite graph shows the spread declining from about the +2.00 area to -1.50—a distance of 3.50 points, or \$1,470 at \$420 per point. I usually recommend using a stop about 2.00 points from entry, although in volatile years I may raise that to 3.00 points. Margin requirements vary, but the N.Y. Mercantile Exchange recognizes this as a spread, and the margin is generally less than \$2,000 per contract. Check with your broker for exact margin requirements before establishing the spread.

Figures 5.4 through 5.8 show specifically how the spread performed in various years. We'll comment on these, individually. Figure 5.4 shows the February 1993 contracts, so the trading took place in October 1992 through January 1993. This was a fairly classic year, as the spread declined (i.e., made profits) from October through a low in December. I would recommend using a trailing stop of perhaps 2.00 points or so after profits begin to develop, so that would have led you to exit the spread in December 1992.

Figure 5.5 shows the spread the previous year—contracts expiring in February 1991. This time, the spread remained flat, or even rose slightly (but not far enough to stop it out) until November 1. Then it began to work fabulously, plunging to a low by the end of the year. In all, the spread made about seven points that year.

Figure 5.6 shows a losing year, using the February 2000 contracts. The spread traded sideways for a long time, finally registering a modest gain in December; but then it turned and reversed higher

**Figure 5.4**  
**HOG/HUG 1993 CONTRACTS**

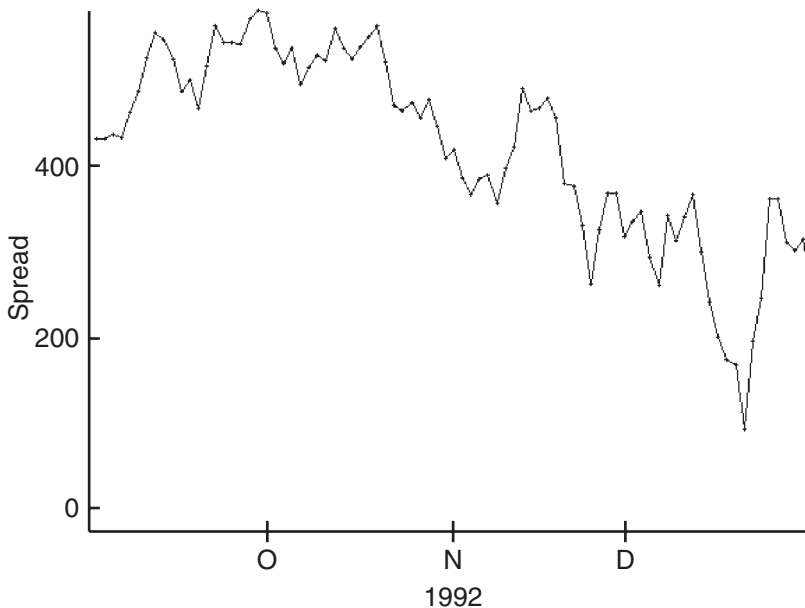

**Figure 5.5**  
**HOG/HUG 1992 CONTRACTS**



**Figure 5.6**  
**HOG/HUG 2000 CONTRACTS**

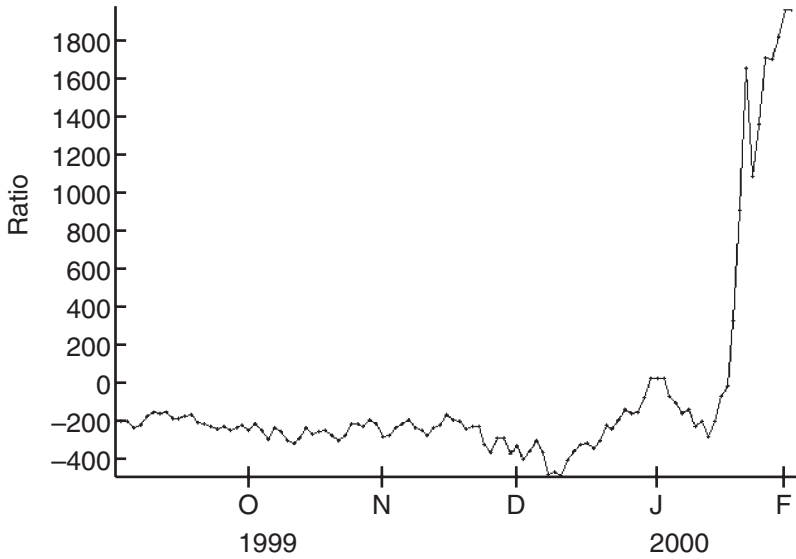



for the rest of the month. That move in December should have stopped the spread out for a loss. If you held on, though, you might have been lulled by another positive move in early January before things fell completely apart as the spread blasted higher in late January. There was almost certainly no profit that year.

The 2001 contracts weren't much better, as shown in Figure 5.7. This was perhaps the most volatile year in the history of this spread. Volatility typically takes place when the winter is much worse than expected and the heating oil contracts rise much faster than unleaded gas contracts do. In this case, the spread traded back and forth between 6.00 and 10.00 from September 1 through early November. The "optimal" entry point, in early October, was a good entry; and perhaps you might have taken partial profits by early November. However, it's unlikely that you would have entirely exited the spread before it moved decisively in the wrong direction in December. That move would certainly have stopped you out. Ironically, the spread then turned and fell by nearly 25.00 points. I

**Figure 5.7**  
**HOG/HUG 2001 CONTRACTS**

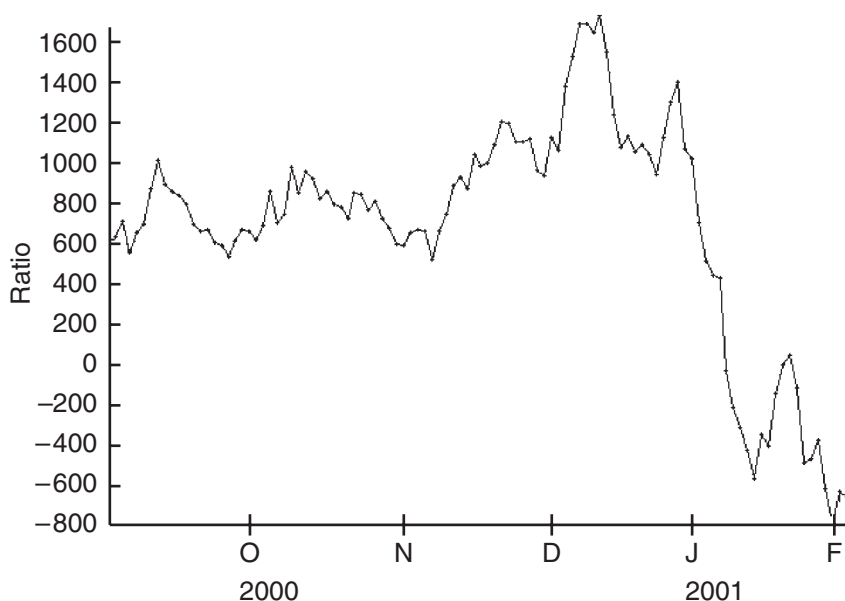

suppose an astute trader could have reentered the spread when its direction turned south, but we don't really have a systematic provision for that.

Things have improved since then, as 2002 and 2003 contracts have all generated profits. The 2002 contracts are shown in Figure 5.8. It was a “classic” year, as the spread never seriously marked down from an early October entry point. Eventually, the spread began to collapse in November, and it fell all the way into early January—declining by 8.00 points or more.

Of the 12 contract years that comprise the composite chart, 8 years produced a solid profit, while 2 years showed modest losses and 2 showed larger losses (hitting the stop of 3.00 points). In years when the spread works, you get moves of 3.00 or 4.00 points in your favor (occasionally, more), which is \$1,260 to \$1,680 on an investment that is \$2,000 or less. That is a phenomenal return, of course. In years where you're stopped out, the loss is limited; and we

**Figure 5.8**  
**HOG/HUG 2002 CONTRACTS**

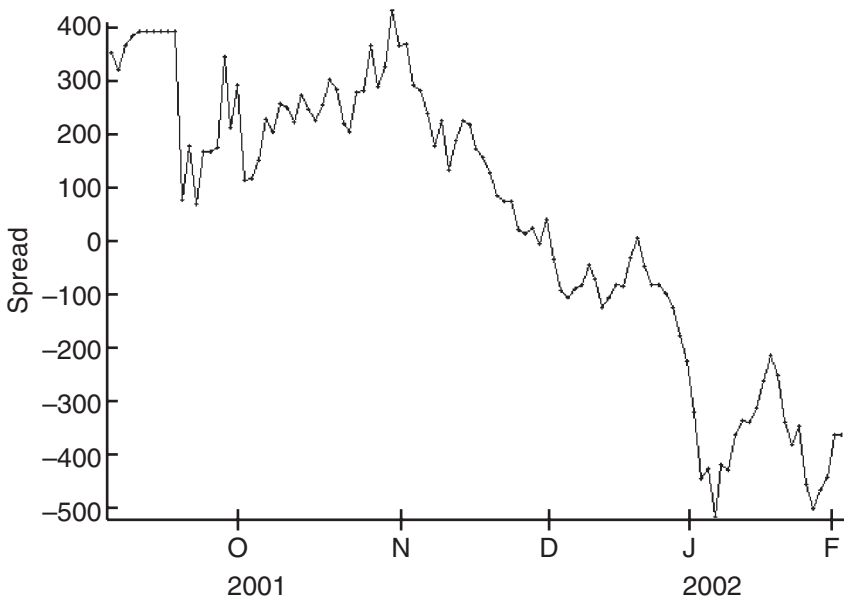

generally don't reenter that year—preferring to wait until the next year to try again.

You have probably noticed that we haven't mentioned options yet in this analysis. Options can be used in this spread strategy. Simplistically, you would buy a February unleaded gas call that was fairly deep in-the-money, so as to minimize time value expense, and would also buy a February heating oil put that was deep in-the-money.

These options would be bought *instead* of the futures spread, so the option position would be established in late September or early October of the preceding year. That brings us to our first problem: liquidity. These futures options are not that liquid four or five months prior to expiration. So, you may have trouble finding a striking price that is deep enough in-the-money to allow you to minimize your time value expense. Also, you may not be able to trade enough options to establish the spread in the size that you want.

Remember that the profit potential of the spread is three to four points at best. So if you are spending nearly that much for time value premium when you buy options, then perhaps you should use futures instead. Admittedly, if you are going to remove the spread in December, then there will still be some time value premium left in the options when you sell them—so you might not lose all of the time value premium that you originally bought—but you can't count on that. Moreover, the options expire in January, so they will have only a few weeks of life remaining when you try to sell them in December.

Having stated all the caveats, let's look at the positive side of the option buy combination (we are buying a put and a call) as compared to the futures spread. The advantage of the option position is that it can make money when prices are volatile. The following example, from 1991 prices, shows how this might work.

---

In mid-September 1991, the following prices existed:

Feb unleaded gas: 62.50	HU Feb 56 call: 6.80
Feb heating oil: 68.00	HO Feb 74 put: 7.50
Futures spread: 5.50	Option combo: 14.30

The futures spread (5.50) is just the difference between the two futures contracts, and the option combo price is the sum of the two option prices.

Note that the time value premium in the Feb 56 call is 0.30 and is 1.50 on the HO Feb 70 put. Thus, the option combo requires an expenditure of 1.80 for time value premium. This might represent almost the entire profit of the spread if prices remain unchanged. However, the benefit of owning the option combo was seen when prices became volatile.

As the fall of 1991 unfolded, the futures spread was fairly flat, ranging up to nearly 6.00 in November and down to 4.00 in the first week of December. From the original price of the spread, this would have been a profit of 1.50, basis of the futures contracts.

However, what you can't tell from the spread price is that the absolute level of oil and oil product prices was in a very bearish market in November and December of 1991. Figure 5.9 is a chart of heating oil during this time period. You can deduce that the unleaded gas chart was quite similar, since the spread between the two was remaining relatively stable.

By early December, Feb heating oil fell to 56.00. That means the Feb 74 put had to be worth at least 18.00, which is parity. The Feb unleaded 56

**Figure 5.9**  
**HOG**



call could only fall to zero (in reality, it was worth 0.20). Thus, the option combo was worth at least 18 points in early December. Since the initial cost of that combo was 14.30, the profit on the option combo was 3.70 points, substantially better than the 1.50 profit available solely from the futures spread.

As it turned out, prices fell even farther during December, which means that the long put generated even more profits.

---

This example also can be used to illustrate an even more important point in favor of the option combo. Suppose, just suppose, that when Feb heating oil fell to 56.00 in early December, unleaded gas had fallen even more. Thus, the futures spread would have actually lost money if that had happened. Despite that, the option combo would have had to make money because the option prices would still be the same: 18.00 for the heating oil Feb 74 put and zero for the unleaded gas Feb 56 call. Thus, the option combo can actually make money if prices are volatile (e.g., prices fell dramatically in this example) even though the futures spread might be losing money.

The counterargument, of course, is that if prices remain stable and the futures spread widens by two points or so, you will make all of that two points if you have the futures spread in position, while you would lose time value premium in the same situation if you have the option combo in place. In the preceding example, the time value paid was 1.80, so you wouldn't really make anything from the option combo in that case.

So, which is better, the futures spread or the option combo? I would use the time value premium of the options as the major factor in making that decision. In early September, if the options are trading with an inflated implied volatility or if the time value premium is just plain "too big," then start out by spreading the futures. You can always roll over into an option position if implied volatilities decrease (i.e., if time value premium shrinks). This might happen in October or early November. So, if you have the futures spread in place, I would always keep an eye on the options for an opportune time to switch into the option combo. Thus, *I favor the option combo, but only if time value premium is small enough.*

So get out your calendar right now, and make a note for next September to evaluate the spread between the following February's

heating oil and unleaded gas contracts. This is a spread with a good track record.

## The January Effect

This is another seasonal spread that can actually be played in *two* directions (not simultaneously, of course). The *January effect* is a term that describes the phenomenon whereby small-cap stocks generally outperform large-cap stocks in the month of January. The reason that this effect takes place is that when the end of the year approaches, people are more apt to sell off their small stocks to take losses (known as tax selling). This depresses the small-cap stocks, and then they bounce back in January after the selling abates. However, when January arrives, you would not just want to buy the small-cap stocks (Value Line Index, e.g.) because the overall market might decline. So the preferred strategy is a hedged one: buy a small-cap index and simultaneously sell a big-cap index (S&P 500, for example). Then if the small-caps outperform the large caps in January, you will have a profit.

That seems simple enough, doesn't it? Unfortunately, when everyone becomes aware of something, the market has a way of making it more difficult to make money. For example, the "conventional" wisdom is that the January effect takes place earlier now because so many people are anticipating it.

In order to discern how this spread truly behaves, we decided to do some research on how it has really played itself out in recent years. We didn't want to go back *too* far because spreads such as this tend to implement themselves in different ways as the years go by. We felt that looking at the postcrash (i.e., post-1987) years might be best, since that was sort of a turning point for many investment philosophies. This means that we are looking at data from November 1988 through January 2003—15 examples of the January effect

In the following analyses, we are going to refer to the Value Line Index as representing small caps and the S&P 500 Index as representing large caps. In the 1990s, this spread was easily established using the Value Line futures versus the S&P 500 futures. Later, the "big" Value Line futures were delisted, and the mini-Value Line

futures became very illiquid. Hence, there are a number of ways this spread can be traded. They will be discussed shortly (in the section entitled “Implementing the Spread”); but for now, we will explain the strategy using the Value Line and the S&P 500 indices.

The specific prices are listed below, but two broad conclusions can be drawn, and they are very important ones:

**Conclusion 1:** *Big-cap stocks distinctly outperform small-cap stocks from about mid-November to the end of the month and all the way to year-end, in many years.* Thus, you should buy the S&P Index and sell the Value Line Index (or equivalent) in November and unwind it three to six weeks later.

**Conclusion 2:** *The optimal time to play the January effect in recent years has been from about December 19 to January 5.* You would buy the Value Line Index (or equivalent) and sell the S&P Index on the December date, unwinding it in early January.

Figure 5.10 shows the composite spread for the years 1989 through 2003. Once again, recall that a composite chart is constructed by averaging the price for each year included. Thus, any one

**Figure 5.10**  
**VALUE LINE/S&P 500 COMPOSITE: 1989–2003**

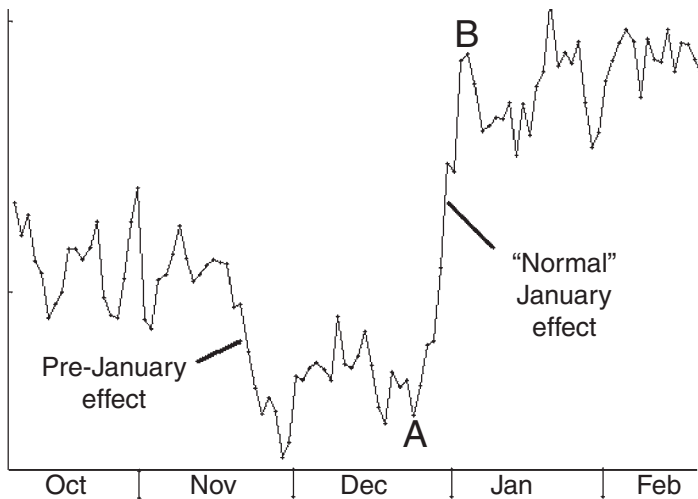

year might differ from the chart, but the usefulness of the composite chart is that it shows trends and tendencies that might not be obvious by looking at all 15 years individually. Figure 5.10 begins with the first trading day of October and continues forward *by trading day*. Thus, the monthly markings on the axis (October, November, December, etc.) are only estimates. In reality, one would count the number of trading days and determine the date from that number; but since there are approximately the same number of trading days in each month each year, it is acceptable to put the month delimitations on the lower axis.

From the chart, you can see that the spread between Value Line (representing small-caps) and the S&P 500 (representing large-caps) shrinks, or declines, during November—certainly during the last half of November, anyway—and remains low until late December (point A on the chart). Thus, Conclusion 1 is verified by this chart: one can buy the large-caps and sell the small-caps in early to mid-November, planning to unwind that trade anywhere from late November through mid-December. In some years, the differential didn't bottom out until nearly December 20 or so; but in other years, it bottomed shortly after Thanksgiving.

Sometimes analysts in the financial media say that investors should begin establishing the January effect in November, because it occurs earlier each year. They are wrong. Conclusion 1 and Figure 5.10 clearly show that large-caps outperform small-caps during November and possibly even December. This conclusion makes logical sense, since the original premise is that these small-cap stocks are sold heavily during tax-selling time in November and December. Unfortunately, some proponents of the January effect are in too much of a rush to establish their positions. Getting in too early can and will cost you.

The proper time to actually enter the traditional January-effect spread is much nearer to the end of the year, when tax selling abates. This usually occurs around December 18 to 20; but in a couple of the years in the study, tax selling continued all the way until the end of the year.

In Figure 5.10, you can see that the major portion of the January effect—when small-cap stocks outperform large-cap stocks—occurs from point A (late December) to point B (early January). In fact, the



time between the two points is rather short—about eight or nine days. Actually, point A occurs 59 trading days after the end of September, and point B occurs 67 trading days after the end of September (remember, that Figure 5.10 is constructed by using *trading days*, not the actual calendar). Typically, 59 trading days after the end of September is December 18 or 19, and the exit date is typically January 5 or 6. Depending on when weekends and holidays fall, of course, the dates can be slightly different than that.

Over the years, the length of the January effect has compressed greatly. When the effect was first gaining publicity—in the late 1980s and early 1990s—it used to begin just after the first of the year and last until much later in January. But the starting date has moved forward into late December because traders want to get “a jump” on the rest of the crowd. As for the end date, even now one can see from the composite chart (Figure 5.10) that the actual peak occurs more toward the end of January; but the bulk of the gains are over by early January. So perhaps a good tactic would be to take some of the position off in early January and hold the balance with some sort of trailing stop until later in January. These concepts are expanded in the next section.

**Implementing the Spread.** The reason that we *spread* the effect, rather than just buying a small-cap index, is that there is no guarantee that the market will rise in January; but whether it rises or falls, the January effect has a good track record going back over 60 years, because small-caps outperform large-caps during the time period stated, even in a falling market.

In years past, we implemented the spread in a very simple manner, by trading Value Line March futures against S&P 500 March futures. Today, that is not necessarily the best choice, since the Value Line futures are quite illiquid. However, let’s look at an example using futures, and then we’ll discuss alternatives.

Currently, the only Value Line futures contract is the mini-Value Line (base symbol: MV), which is worth \$100 per point of movement in the Value Line index (VLE). So, the simplest thing to use as a reasonable spread against the mini-Value Line would be the S&P e-mini futures (base symbol: ES). On the surface, then, one MV con-

tract would be spread against two ES contracts, which would give both sides of the spread \$100 of value per point of movement. We will later show that this ratio might have to be refined somewhat.

When trading the spread with futures, one must be aware of the fact that because futures are a derivative product, they may anticipate the January effect and, thus, have a large spread on them. I have seen the Value Line futures have as much as nine points of premium built into them in late December (where fair value might be two points, say). That is because the marketplace is already anticipating the January effect. If that is actually the case (overly large premium in Value Line futures), then one might want to use an alternative method of trading the spreads—Exchange-Traded Funds (ETFs), to be discussed shortly.

---

In late December, a trader is thinking of establishing the January effect spread—buy the mini-Value Line futures and sell the S&P e-mini futures. He would use the March contract in both cases since that is the “front month” (most active) contract. The following prices exist:

VLE: 1351.13	SPX: 1082.07
March mini-Value Line futures: 1358.00	March e-mini futures: 1084.00

The spread between the cash indices is 269.06 (VLE minus SPX), but the spread between the futures is only 264.00. This difference is due to the fact that the Value Line futures, which you are going to buy, are trading with a premium of nearly seven points. Meanwhile, the S&P futures that are being sold have only a two-point spread (roughly). Thus, the trader is paying five points of extra premium for the futures spread. Alternatively stated, the futures marketplace has already discounted a widening of the differential between the two indices (the January effect) and has built in a five-point premium because of it. This extra premium is a theoretical disadvantage for the trader. If he expects the spread to widen more than that, he may go ahead; but if he feels this has already robbed the spread of most of its potential, then he should look for other instruments with which to establish the spread.

Let's suppose that he goes ahead. To keep things simple, suppose the trader:

    Buys one March mini-Value Line future @ 1358  
    Sells two March e-mini S&P futures @ 1084



loses a predetermined amount of money). A money stop should probably be at least 5.00 points in spread value (or \$500 in the one-by-two MV versus ES spread shown in the example).

Now, let's take a look at other ways the spread might be implemented. For the large-cap side, I would still use the SPX. However, there are at least three other ways one could establish a position in the SPX besides futures: (1) futures options, (2) SPX options traded on the CBOE, and (3) S&P depository receipts (SPDRs, symbol: SPY), which everyone calls "spiders." SPY is an exchange-traded fund that mimics the SPX, but trades at one-tenth the price.

Spiders are very liquid and are a favorite of institutions. They can be shorted on minus ticks, which makes them very similar to futures. Their biggest detriment is that they are margined like stock (at 50 percent margin), which is considerably more than the 10 percent margin required for S&P 500 futures contracts. The only other acceptable alternatives for large-caps would be the iShares S&P 500 Index (symbol: IVV), the OEX, and its accompanying ETF (symbol OEF), and their options.

There are several alternative choices for small-caps. There are a number of small-cap indices that trade options, and there are several iShares (ETFs issued by Barclays, if you will recall) that represent small-cap indices. To verify which iShares are available at any point in time, visit the site [www.ishares.com](http://www.ishares.com) and click on the Market Cap, Small Cap tabs on the left of the home page. Table 5.2 shows a list of the currently available products that you might consider as a way to trade a small-cap index during the January effect.

**Table 5.2**  
**SMALL-CAP INDEX PRODUCTS**

---

Russell 2000 Index Fund (IWM)*
S&P 600 Small Cap Index fund (IJR)*
S&P Small Cap Index (\$SML) options
Russell 2000 Index (\$RUT) options
Russell 2000 Index futures (base symbol: RU)

---

\*Both are iShares; both have listed options.

In late December 2003, the following prices existed:

VLE: 1460.2      SPX: 1075.1      Difference: 398.1

A trader wants to trade the January effect, but he wants to use listed options to do so. At the time, the Russell 2000 Index (\$RUT) was tracking quite well with the Value Line Index and, therefore, was a reasonably good proxy for the small-caps in general. The iShares (IWM) had modestly priced options. Meanwhile, the OEF exchange-traded fund was chosen as a proxy for the large-caps because it tracks the SPX almost exactly and has listed options as well. As with any intermarket spread, we use in-the-money options to trade this position. These were the relevant prices:

RUT: 537.70	OEX: 534.70
IWM: 107.12	OEF: 53.51
IWM Feb 105 call: 5.60	Feb 55 put: 2.20

Let's make the assumption that we'll buy two OEF puts for each IWM call we buy, even though that might not be completely correct (a formula for incorporating volatility into an intermarket spread is presented later in this chapter). So, we buy two OEF Feb 55 puts at 2.20 and buy one IWM Feb 105 call at 5.60—a total outlay of \$1,000, plus commissions.

In early 2004, the January effect worked very well, and the spread between VLE and SPX widened to 445 points by January 8. Moreover, the spread was expanding at the time, so if a trader merely stayed with it until it narrowed one day, he would have remained in until January 21, 2004, when it stood at 471.70. At that time, the relevant prices were:

VLE: 1619.3	SPX: 1147.6	Difference: 471.7
RUT: 598.00	OEX: 563.70	
IWM: 118.91	OEF: 56.56	
IWM Feb 105 call: 14.1	Feb 55 put: 0.35	

So, the combined value of the two OEF puts plus the one IWM call is now \$1,480, less commissions. Thus, the spread profited by \$480, or 48 percent in this case. One of the reasons that the profit was so large was that not only did the spread between small-caps and large-caps widen (which was profitable for our trade), but OEF also rose through the striking price, which means that the put stops losing money (it can't trade below zero, of course)—an added advantage.

---

It should be noted that the large movement in the indices made the option spread especially profitable. If the prices had remained relatively unchanged, then the time value spent for the options plus the relatively wide bid-asked spread in the options would probably have produced a loss, whereas a January-effect spread utilizing futures would have done much better. So it's not always optimal to use options; but if the time value is relatively small, that's the way I would generally lean—toward using options to establish the spread.

Before leaving this subject, observe Figure 5.11. It is a long-term graph of the differential between the Value Line Index (VLE) and the S&P 500 Index (SPX). Note that the spread remained very stable from 1990 into 1998—with SPX generally being less than 100 points higher than VLE. Actually, the two were about equal in 1995. From that point forward, during the rest of the huge bull market of the late 1990s, SPX dominated. Eventually, SPX was over 400 points higher than VLE by the year 2000. Then, the bear market took over, and small-caps reasserted themselves—and have continued to do so ever since, even after the bear market ended in 2002.

**Figure 5.11**  
**VALUE LINE INDEX MINUS S&P 500**

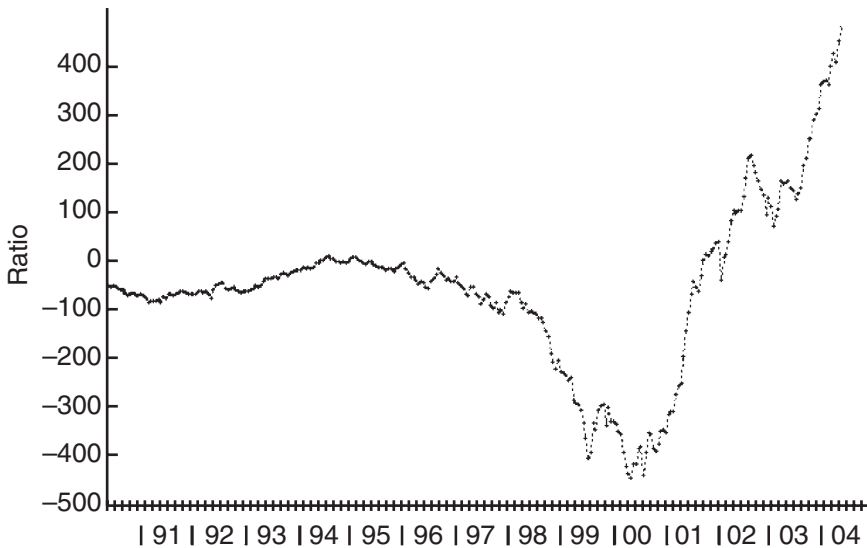

Since then, small-caps have outperformed large-caps by such a wide margin that most small-cap indices have made new *all-time* highs—exceeding their bull market tops of 2000, even though SPX, the Nasdaq, and the Dow are all well below their respective bull market highs.

This resurgence of the small-cap indices has biased the spread in recent years. The pre-January effect (where one buys large-caps and sells small-caps, beginning in November of each year) has done poorly, whereas the “normal” January effect (traded in the reverse manner) has been much more profitable than its historical norm. Hence, as long as small-caps continue to be such a large outperformer during the entire year, one might be leery of the November portion of this spread (perhaps trading a lighter position or using technical entry points, such as a decline in the spread, as entry points—if there is no decline around the optimal entry date, then don’t enter the spread). Conversely, one might pursue the regular January effect spread more aggressively as long as this longer-term trend persists, as shown in Figure 5.11. In other words, enter the regular spread on the appropriate date near the end of December without regard to the short-term technical pattern in the differential of the two indices at that time; but when it comes to the November portion of the spread, only enter it when it begins to look like SPX is starting to outperform VLE. If it doesn’t look that way around the entry date, then don’t enter that portion of the spread that year.

In summary, the spread can be traded with either futures or options and can be traded in both directions (long large-caps and short small-caps in November, and the other way around over the end of the year). I feel that both portions of the spread can be traded each year, for both have a generally successful track record. Just be mindful of the overall trend; and if the small-caps continue to dominate, factor that into your approach to the two portions of the January-effect spread.

## **Gold Stocks versus the Price of Gold**

There are some stocks whose price is related to a raw material that is extremely important to the company’s financial fortunes. Among the

raw materials that fall into this category are gold, oil, copper, and fertilizer. In certain cases, an intermarket spread strategy can be devised wherein the stock(s) are traded against futures on the pertinent commodity. The intermarket strategy could be as simple as trading copper futures against Phelps Dodge stock (Phelps Dodge is a major copper producer); or it could be a little more complicated, such as trading an index of stocks—if a sector index, in fact, exists—against the futures contract. This latter strategy is a useful one; and since the index provides some measure of diversification, it is probably a more reliable strategy than merely trading one stock against the futures.

In order to trade the index, you could either buy the appropriate number of shares of each stock in the index or use options on the index, if there are listed options trading. Usually, using options is much simpler because you can get “long” or “short” the index very quickly and easily, as opposed to executing trades in all the stocks that compose the sector index. Moreover, the capital required for the option transaction would be much smaller than that required to buy all of the stocks in the index.

Furthermore, when trading options on the index, there are two approaches that you could take as well. The first would be to use the *equivalent strategy* described at the beginning of Chapter 3. For example, if you wanted to be long the sector index, you could buy a call and sell a put—both with the same striking price and expiration date—as a total substitute for owning the index. When using this approach, you have the full upside potential *and* downside risk of the index. The second would be to merely buy a call on the index; this means that you would have limited downside risk, but you would have risk of time value eroding your option.

Now that we have discussed all those possibilities, it's time to look at one of these intermarket spreads. It is the one between the price of gold (futures) and the price of the PHLX Gold and Silver Index (symbol: \$XAU). Figure 5.12 is an approximation of how this spread has looked over a thirteen-year period, from 1991 through 2003. The purpose of this chart is to demonstrate that the relationship between the price of gold stocks and the price of gold itself can change dramatically over time. When you are actually trading the intermarket spread itself, you usually are interested in shorter-term movements than those shown on this broad chart.



Nevertheless, the chart is useful. Note that, as the 1990s began, the price of gold stocks (XAU) was about 30 percent of the price of Dec gold futures (30 on the chart). At the time, that was historically expensive. Then, both gold and gold stocks went into a prolonged decline in 1990, and the ratio plunged. In fact, gold stocks went down farther than gold itself, as the XAU index dropped over 50 percent from its early 1990 levels, while gold declined about 20 percent. This caused the ratio to eventually drop to levels near 20 on the chart in Figure 5.12.

An opposite move occurred in 1993, as both gold and gold stocks blasted off to the upside, with the XAU doubling in price, but gold only gaining about 25 percent. Thus, the ratio moved higher once again, peaking near 35 at the beginning of 1994. As you can see, when major moves occur, XAU moves farther than gold because it is a more volatile item. So, when both the XAU Index and gold are

**Figure 5.12**  
**\$XAU DIVIDED BY DEC GOLD FUTURES**

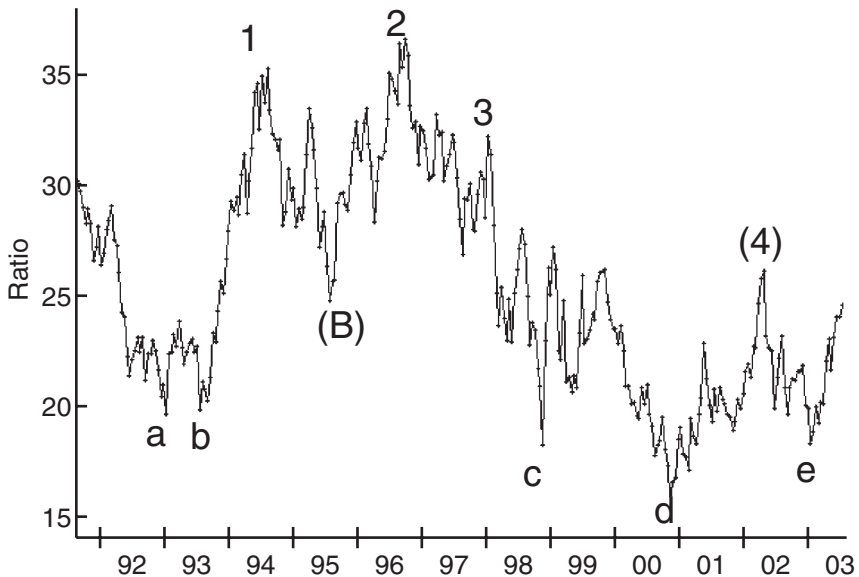

moving together, we generally would not be looking to establish an intermarket spread. However, when *one* of them is moving and the other is not, we may have an interesting opportunity to establish a position.

The 1993–1995 period is a classic case in point. During that time, gold itself was quite stable, remaining in a very narrow range between about 375 and 410. However, gold stocks, which apparently are more subject to investors' emotions, had some fairly big moves. This caused the action on the chart in Figure 5.12 whereby the ratio peaked in the 33-to-35 area three times, only to decline each time and bottom below 30. These ranges are tradeable via an intermarket spread.

---

Beginning in February 1995, many institutional investors, money managers, and advisors began to espouse gold stocks as an investment. As a result, the XAU Index rose from just under 100 to over 130. During that same period, gold futures rose about \$10, from 380 to 390. This caused the ratio to move from about 24 to 33. Clearly, this was a sign that the two were out of line, because there was not a real direction apparent in the price of gold—the gold stocks were moving on their own. When this type of action occurs, the intermarket spread is attractive.

Since it was the XAU that was “ahead” of gold, the proper intermarket spread was to buy gold futures and short the XAU (or buy puts on XAU). The strategy worked quite well, as gold remained quite stable; but gold stocks eventually gave up much of their gains, with the XAU falling back to below 110. The ratio simultaneously fell back toward 28, and the spread produced nice gains.

---

What made this situation an ideal one for establishing an intermarket spread was that only one of the two components was moving—the XAU, which was rising—while the other was relatively stable. When you see that situation in these related markets, then you have to figure that either (1) the gold stocks will fall back to get more in line with the price of gold (and that's what eventually happened in our example), or (2) the price of gold will rally to catch up with the move in gold stocks.

As a means of describing the details behind setting up one of these types of intermarket spreads, we'll use the same example. Before looking at specific prices, however, we must introduce the formula necessary for equalizing two different trading vehicles on two different markets. This formula gives us the ratio of contracts that we need to trade to have a market neutral spread, one that will capture the true movement of the two indices. It was not necessary to use such a formula for the previously discussed intermarket spread (unleaded gas versus heating oil, and Value Line versus S&P 500) because those markets were very closely related; in fact, they are almost identical. However, when the relationship is looser, then the formula is necessary for determining how many contracts to buy and sell.

$$\text{Intermarket quotient} = \frac{\text{Price}_1}{\text{Price}_2} \times \frac{\text{Unit}_1}{\text{Unit}_2} \times \frac{\text{Volatility}_1}{\text{Volatility}_2} \times \frac{\text{Delta}_1}{\text{Delta}_2}$$

where  $\text{Price}_i$  = the price of the contract

$\text{Unit}_i$  = the trading unit of the contract (for example, \$100 per point, or \$500 per point, etc.)

$\text{Volatility}_i$  = the actual (historical) volatility of the contract

$\text{Delta}_i$  = the delta of the options being used in the spread, if options are in fact being used

Once you plug the various variables into this formula, the quotient will tell you quite simply how many of one contract to buy for each one you sell. Thus, it is the basis for every intermarket spread.

---

Continuing with the situation in Figure 5.12, the following prices existed in mid-September 1995:

XAU Index: 126.62  
Dec gold futures: 389.70

In keeping with the overall philosophy of trying to use options in these intermarket spreads, unless the options have too much time value premium in them, the following option contracts looked attractive at the time:

Option	Price	Delta
XAU Dec 135 put:	12	0.71
Gold Dec 380 call:	11.50	0.78

The time value premium of the put is 3.62, while the time value premium of the call is 1.80. Thus, the total time value expenditure is 5.42, somewhat hefty, but not unreasonable considering the rapidity with which this ratio can move. Also, remember that using the options gives you the extra chance to make money if prices move a great deal in one direction or the other, even if the intermarket spread itself doesn't converge.

At the time (mid-September 1995) the 20-day historical volatility of the XAU Index was 27 percent and the same volatility for Dec gold futures was 7 percent (that was an extremely low reading for gold, but it had been very quiet for a long time). Finally, the trading units of both options were the same: a one-point move was worth \$100. So, we now have everything we need in order to compute the quotient, using the previous formula.

$$\text{Intermarket quotient} = \frac{126.62}{389.70} \times \frac{100}{100} \times \frac{27\%}{7\%} \times \frac{0.71}{0.78} = 1.14$$

This means that you should trade 1.14 Dec gold contracts for each XAU contract that you trade. Ironically, this quotient is very nearly equal to one, when small quantities are involved, so most traders would just buy one gold Dec 380 call for each XAU Dec 135 put that they buy. However, if larger quantities are involved, you should adhere to the ratio (for example, buy 114 Dec gold calls and buy 100 XAU puts).

Finally, about five weeks later, the price of gold stocks had retreated substantially, as there was no confirmation from the price of gold itself, and holders of those stocks were getting nervous. The price of gold had fallen slightly, but the price of the XAU had declined rather dramatically. Thus, the spread had performed as expected—the price of XAU had moved back “into line” with the price of gold:

<i>Index</i>	<i>Option</i>
XAU Index: 108.08	Dec 135 put: 27
Dec gold: 383.80	Dec 380 call: 5.00

The option combination was now worth a total of 32 points, as compared to the initial price of 23.50 points—a profit of \$850 per combo.

In the preceding discussion, the prices of the underlying items being spread were *not* volatile during the time the position was held, yet the option strategy made money anyway when the prices converged. This demonstrates that by using the option strategy, you can profit if the two markets converge, as long as the time value expense of the options is reasonable when the spread is established. As for entry points, I would look for peaks or valleys in the ratio between the XAU and the price of gold futures. The peaks are most significant above 30 percent and the valleys below 25 percent.

These points can be seen in Figure 5.12. The numbers 1, 2, and 3 are all areas where one would sell gold stocks and buy gold futures. Number 4 might be as well, since it is the highest point in recent years, but it is quite a ways below the 1993–1997 peaks. This shows the dynamic nature of the spread—once again, it's not necessarily the absolute level of the ratio that's important, but where the ratio peaks. Points A through E are local minima on the chart and are good entry points for the opposite hedge: buying the XAU stocks and selling the gold futures. These all occurred below the 20 level on the chart; but point B was a local minimum at a higher level, and it was also a good entry point for such a spread.

These examples demonstrate that the spread between the XAU Index and the price of gold (futures) is a viable one to trade. The best opportunities arise when one market is relatively stable and the other market makes a substantial move. I would avoid the spread when both markets are trending strongly, for that is when the movements in XAU are more pronounced than those of gold.

## **Oil Stocks versus the Price of Oil**

Given that you can trade the gold stock index versus gold futures, it should come as no surprise that a similar situation might arise with respect to oil stocks and oil futures. The AMEX trades listed options on the Oil and Gas Sector Index (symbol: \$XOI), and, of course, there are futures that trade on crude oil. Once again, the relationship between these two markets is not exact, and the best opportunities

arise when one market makes a move that is not matched by the other one.

In 1990, the ratio had dipped due to the price of oil skyrocketing during Iraq's occupation of Kuwait. Oil stocks did not follow suit at that time. Actually, as it turned out, that was a tremendously good time to buy the oil stocks and short crude oil futures. Of course, had Iraq destroyed the Mideast oil fields and thereby sent the price of oil skyrocketing, I'm not sure that oil stocks would have followed.

Figure 5.13 is the chart of the XOI Index divided by the price of crude oil futures over several years. It shows that oil stocks had generally been rising while the price of oil remained fairly constant—especially in 1993. If you had attempted to establish the intermarket spread during this time period, you would probably not have been successful *unless you used options*. In 1994 and 1995, the spread had established a new trading range between 150 and 175 on the chart. Thus, at this time it was possible to trade the spread itself and make a profit, without necessarily having to rely on price volatility.

**Figure 5.13**  
**\$XOI DIVIDED BY DEC CRUDE OIL FUTURES: 1992-1995**

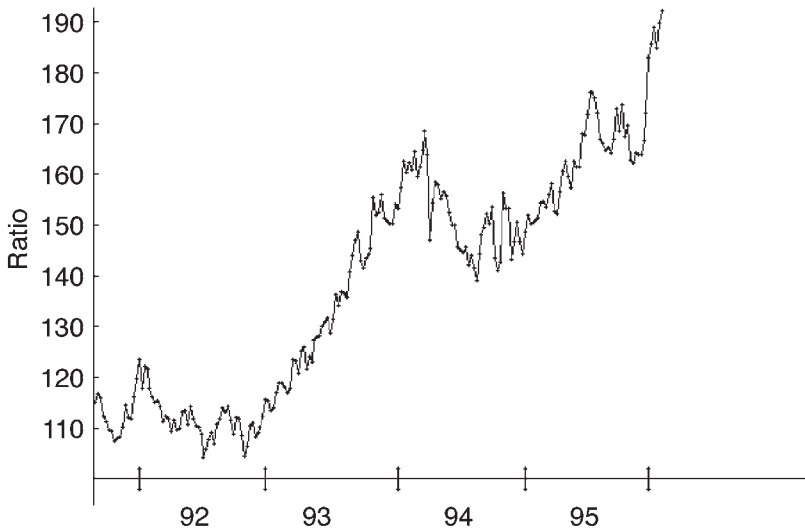

In September 1993, there was a period when oil stocks advanced and crude oil actually declined. On the chart in Figure 5.13, this is just a part of the overall advance that you see in 1993. However, in Figure 5.14, you can see how there was an upward “bubble” in September, even while the graph was generally trending higher. At the time, it seemed like an illogical market move, so I established the intermarket spread at the following prices:

XOI Index: 260	Nov crude oil futures: 17.38
XOI Oct 265 put: 8	Crude Nov 17 call: 0.84

The anomaly between the two markets was receiving some attention in the press, and several analysts said that they felt that oil stocks were probably ahead of themselves and should be sold. Option traders might logically translate that kind of statement into an opportunity to buy puts on the XOI. However, knowing that these things have a tendency to move in ways that you don't read about in the newspaper, I felt the intermarket spread was better. So I not only bought the XOI puts, but I also bought an equal number of the crude calls.

**Figure 5.14**  
**\$XOI DIVIDED BY DEC CRUDE OIL FUTURES: 1993**

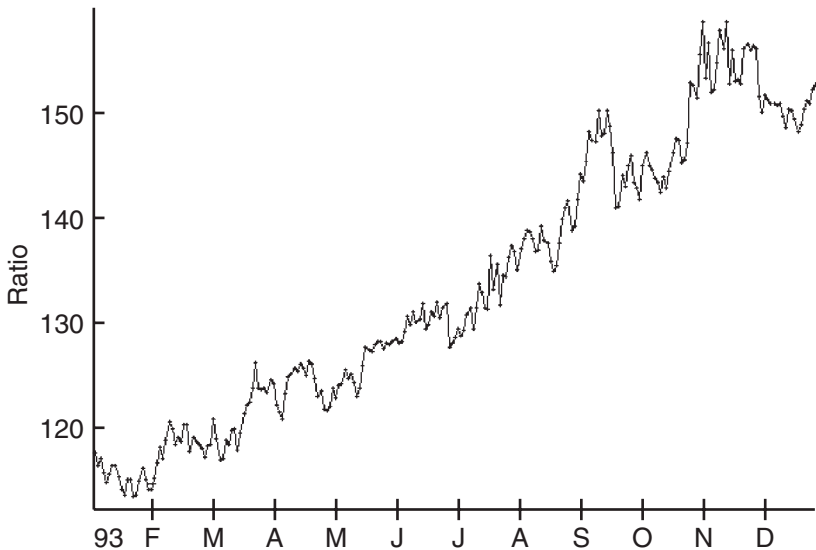

At first, oil stocks *did* decline. And to make matters even better, crude oil began to rally as well. However, the rally by crude oil eventually caused the oil stocks to rise as well, and they rallied even more than crude oil did. So, whatever factors had made investors buy oil stocks in the first place were only exacerbated by the rally in crude oil.

By early October, the following prices existed:

XOI Index: 273	Nov crude oil futures: 18.90
XOI Oct 265 put: 2	Crude Nov 17 call: 2.13

Fortunately, the rallies in both markets were rather substantial, so that the crude oil Nov 17 calls rose quite a bit and made the whole position profitable, even though the XOI puts lost most of their value. The crude calls made 1.19 (\$1,190), while the XOI puts only lost six points (\$600).

---

This example is a good illustration of how the use of options in the spread can produce a profit where one would otherwise not have existed. Not only did the intermarket spread not converge (except for the initial move), but the “conventional wisdom” of buying XOI puts was wrong also. Thus, while it is probably safer to trade these spreads in nontrending markets (such as the 1994–1995 time period as shown in Figure 5.13), it is still possible to trade them profitably if you use the option strategy as an integral part of your intermarket spreads.

Now, consider Figure 5.15, which shows the ratio over a much longer period—12 years. What had appeared to be a strong upward move in the 1992–1995 time frame (Figure 5.13) was completely dwarfed by what happened from about 1996 through 2000—oil stocks (being *stocks*, and that time frame being one of the biggest bull markets of all time) drove to a spike peak on the chart at the 360 level. Once again, had you tried to establish the spread between oil stocks and crude oil futures, you would have been best served by using options, as shown in the previous example.

From there, the ratio collapsed during the bear market as oil stocks fell into late 2002. Another rally on the chart ensued as stocks rallied, but then the ratio dropped back to the lows as crude oil rallied during the last half of 2003.

The end result is that the 150 level appears to be a tradeable spot on the chart in Figure 5.15 (the trend line shows this). At those



**Figure 5.15**  
**\$XOI DIVIDED BY DEC CRUDE OIL FUTURES: 1992-2003**

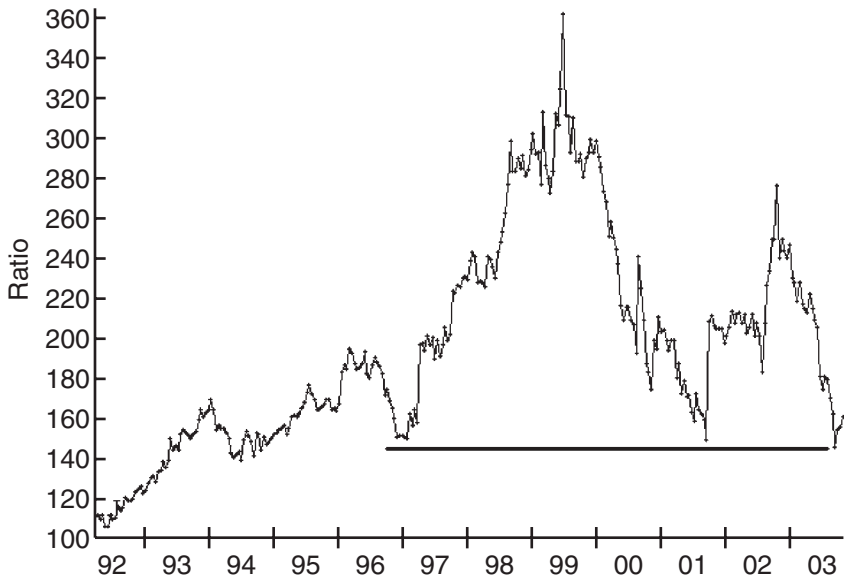

times, you'd want to buy \$XOI (oil stocks) and sell crude oil futures—or buy calls on \$XOI and puts on crude oil. Furthermore, with the introduction of ETFs in recent years, there are a couple of oil-related ones that might be used instead of \$XOI, for its options are rather illiquid. One is the Oil Service HOLDERS (symbol: OIH), which is acceptable; but Oil Service stocks are not really the same stocks that are in \$XOI. However, there is also an iShares that *does* have oils stocks in it—the iShares Dow Jones U.S. Energy (symbol: IYE).

---

In late 2003, with the ratio near the low point seen on the chart in Figure 5.15, we wanted to buy oil stocks, or the equivalent, and sell crude oil futures. We decided to use the iShares for this trade since the options were cheap (in a low percentile of implied volatility). The following prices existed:

XOI Index: 470.55

Dec crude oil: 29.17

Ratio: 16.13

IYE: 44.7

Feb crude oil: 28.30

IYE Feb 40 calls: 5.00

Feb crude 30 puts: 3.54

Since it is not intuitive as to what the ratio of IYE calls to crude oil puts should be, it is necessary to use the formula stated earlier:

IYE calls:  $43.0 \times 100$  (shares per option)  $\times$  16.5 percent (volatility)  $\times$  delta (0.80)

Crude puts:  $28.30 \times 1000$  (dollars per point)  $\times$  32 percent (volatility)  $\times$  delta (0.75)

Multiplying the crude oil factors and dividing by the multiple of the IYE factors, we compute a ratio of about 12—12 IYE calls should be bought for every crude oil put purchased.

As it turned out, both markets rallied to the point that the crude oil puts expired worthless; but the IYE calls made 5.26 points, and the profit was worthwhile:

IYE calls:  $+5.26 \times \$12 = +\$6,312$

Crude oil puts:  $-3.54 \times \$1000 = -\$3,750$

Note that, by mid-January (when the Feb crude oil puts expired), the ratio between the XOI Index and December crude oil was 19.1. So, not only did the ratio between the two markets expand, but the volatile, upward price movement helped as well. Both factors thus combined to produce about a \$2,500 profit on an initial investment of a little over \$19,000 in about three months—not a bad return at all for a hedged strategy.

---

## Utility Stocks and 30-Year T-Bonds

Two other markets that are related are the utility stocks and the long bond futures. Since the utility stocks generally pay rather large dividends, they are interest-rate-sensitive stocks. Obviously, bonds are interest-rate sensitive also. Moreover, since buyers of the utilities are generally investors with a long-term view, these stocks are most sensitive to longer-term interest rates. The bellwether of long-term interest rates is the U.S. 30-year Treasury bond (T-bond). One of the most active futures contracts is the Chicago Board of Trade's (CBOT's) 30-year bond future, typically called the "long bond future."

Figure 5.16 shows the relationship between these two markets over the years. It is an interesting chart in that it trades in ranges for several years at a time, and then the range changes. This has been particularly true of the upside of the range, which moved three distinct times over the years (trend lines are drawn to show the ranges). But the bottom of the range was inviolate until 2002, when utility stocks plunged (spurred by some concerns about the market making in energy derivatives in which many companies were participating) coupled with a rising bond market because interest rates were falling. This combination of events plunged that ratio to depths never seen before. The ratio has since recovered somewhat, but only to barely above what *used to be* the bottom of the range—near the 2.7 level. In early 2004, the ratio stood at 2.83.

Another thing that can be noted from Figure 5.16 is that the spread has behaved in a much more volatile pattern since late 1999. What has happened since then? Deflation reared its head, and there was a general uncoupling of stocks and bonds—even between interest-rate-related stocks and bonds, to some extent. So the ratio has bounced back and forth in a much more violent manner since then.

**Figure 5.16**  
**\$UTY DIVIDED BY DEC T-BOND FUTURES**

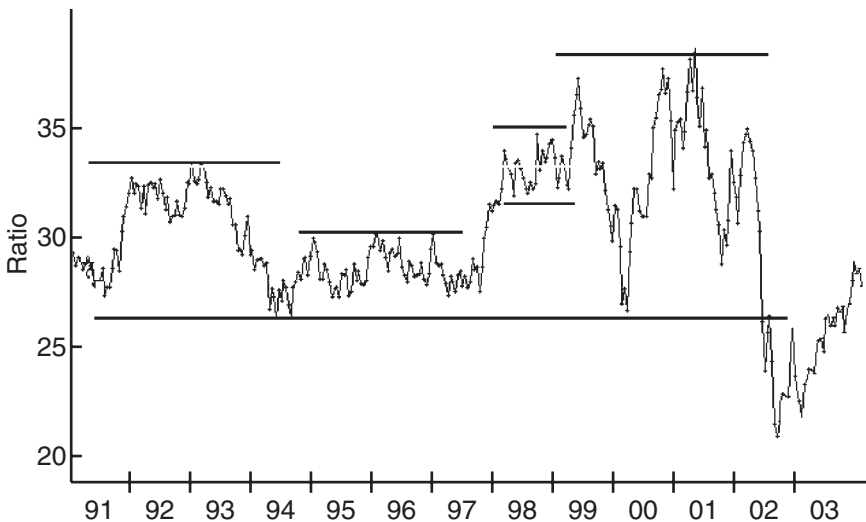

But that's okay, for the intermarket spread trader *wants* volatility in the spread—especially if the markets are going to be volatile as well. Hence, the best strategy seems to be to establish the spread at extremes in the ratio and capitalize when it lurches back in the other direction. Of course, if it blasts on through the old level, then you should probably stop yourself out (unless the underlying prices are moving very swiftly as well) and wait for a new extreme reading to be established.

To that end, let's look at how you might have treated a position in late 2002, when the ratio smashed down through what had previously been the low end of the range for 10 years. By the way, the behavior of this spread is an excellent reason why we establish these positions with options when we can, and not with the underlying themselves—because we can still make money if the underlyings make violent moves, even if the spread itself does not move in our favor.

Table 5.3 shows a snapshot of prices of both the Utility Index and Dec T-bond futures (symbol: @USZ) during this volatile period. From the prices shown, one can see that the Utility Index was plummeting, due to the aforementioned problems, while the T-bond futures were rallying strongly, both as a flight to quality from the bear market in stocks and as a response to the Fed's continued lowering of interest rates (also a response to the bear market in stocks).

About July 10 was the date when the ratio reached its old, historic lows near 2.6. The intermarket spreader might have bought calls on UTY and bought puts on USZ at that time, figuring the spread was about to go the other way. However, the ratio smashed

**Table 5.3**  
**UTILITY INDEX (UTY) VS. DEC T-BOND**  
**FUTURES (@USZ)**

Date	UTY	@USZ	Ratio
7/1/02	310	102.0	3.04
7/10/02	270	103.5	2.61
7/20/02	220	105.0	2.10
8/25/02	295	107.0	2.71
10/10/02	225	115.0	1.96

on down through that level, reaching a temporary low at 2.1—but just 10 days later! In reality, a trader might have stopped himself out of the spread as soon as he saw it drop through the old lows—perhaps at 2.5 or 2.4. But in any case, *both* sides of the spread were losers: the calls lost because UTY was falling, and the puts lost because USZ was rising. In other words, the relationship between the two entities had become completely unhinged during this time. At least with options, the loss is limited; and assuming that the trader had bought, say, three- or four-month options to begin with, the loss was not total. If he had established the spread with futures and EFTs, the loss would have been just as bad as the widening of the spread—much worse in terms of points lost in comparison to the option trade.

The trader would probably not have entertained reentering a spread between these two entities until they resumed more normal consistency—in early 2003. Look once again at the chart in Figure 5.16. In early 2003, the ratio made a slightly higher low and then began to rise. Hence, it appeared that as bonds continued to rise in price, utility stocks were once again rising with them; and the spread could be established once again.

Finally, it should be noted that the U.S. government intends to stop issuing 30-year bonds. But the 10-year note futures (base symbol: TY) will work equally as well. In fact, any strategy using the long bond futures can still be effectively implemented using the 10-year note futures, since the two contracts move very much in concert.

In summary, this relationship is not as consistent as the ones previously shown using oil or gold, but it does have some tradeable periods and should be in the arsenal of the intermarket spread trader.

### **Similar-Sector Index versus Futures Intermarket Spreads**

There are a few other sector indices that have correlation to the futures markets. As such, they may be practical for intermarket spreads. One is the Natural Gas Sector Index (symbol: \$NGX) and natural gas futures. This one is a “natural”; but since the index was only listed in late 1994, there is not enough of a trading history to conclude what the range of the ratio between the two markets might

be. Any strong move by one market that is not matched by the other would be an ideal situation for establishing an intermarket spread between the XNG Index and natural gas futures.

Since new sector index options are constantly being listed, you should keep an eye out for ones that align rather well with listed futures contracts. Intermarket spreads will probably be viable between such markets. This would include ETFs and their options. Many of the sectors covered by iShares or HOLDRS have relationships to futures markets and also have listed options.

Moreover, you might watch for relationships between the price of a commodity and the price of a major stock in that field, if there is not a sector index or ETF available. For example, take copper. There are copper futures and Phelps Dodge (PD) is the major copper stock—a stock that often moves in relationship with the price of the commodity. Consider Figure 5.17, which shows the relationship between the two. Clearly, you could consider establishing a spread of “long PD calls, long copper futures puts” when the ratio was near the line drawn on the chart—near the 3.0 level. The last time prices were near that level, in October 2002, PD ran from 26 to above 80,

**Figure 5.17**  
**PD DIVIDED BY DEC COPPER FUTURES**



**Table 5.4**  
**COMPONENTS OF THE MORGAN STANLEY COMMODITY  
 RELATED EQUITY INDEX (CRX)**

Symbol	Name	Symbol	Name
AA	Alcoa Inc.	IP	International Paper Co.
ABX	Barrick Gold	MRO	Marathon Oil
ADM	Archer-Daniels	NEM	Newmont Mining
AHC	Amerada Hess	PD	Phelps Dodge CP
AL	Alcan Inc.	PDG	Placer Dome Inc.
APA	Apache Corp.	POT	Potash Corp.
APC	Anadarko Pete	SLB	Schlumberger Ltd.
BHI	Baker Hughes Inc.	TSN	Tyson Foods
BR	Burlington Res.	WY	Weyerhaeuser Co.
CAG	Conagra Foods	X	U.S. Steel Corp.

eventually. Meanwhile copper futures doubled in price, moving from 65 to 130. This is what one likes to see—prices moving in the same direction *and* the ratio widening. But even if the ratio hadn't widened, an option trader would have still made money since prices moved strongly in the same direction. In this case, the calls on PD would have kept making money, while the puts on copper would have eventually gone to zero and thus stopped losing money. Overall, this spread would have been very successful.

In fact, if a trader wanted a list of which stocks respond well to individual commodity prices, he might look at the stocks comprising the CRX Index. This is an index designed by Morgan Stanley to be a basket of stocks that tracks commodity prices well. In fact, there is even a spread between the CRX Index and CRB futures that can be traded. The individual components of CRX at this time are shown in Table 5.4.

## Pairs Trading

Other relationships that you might consider are between sectors themselves (particularly if they have listed ETFs) or between stocks that are related to each other. The original concept of “pairs trading” was applied only to stocks. Statisticians found correlations between

one stock and another that had a reliable relationship over time (General Motors versus Ford, as one simple example). In recent years, that concept has been applied to sector trading as well (semiconductors versus pharmaceuticals, for example). And now, the concept of what we call “intermarket spreads” is also considered a “pairs trade” by some in the field. So the concept of pairs trading has evolved to the point where it is used to define any strategy in which a trader buys one entity and sells another against it, where the trade is based on historical relationships between the two.

The point with which I want to conclude is that anything that is considered a pairs trade—any hedge between two instruments that have some relationship to each other—can best be constructed with options instead of using the underlying instruments themselves because you then have two ways to profit: (1) if the relationship improves or (2) if the prices are volatile and both markets move in the same direction. Only an option spread will produce profits under the second condition. Isn't it better to have two ways to make money rather than one?

## **OTHER SEASONAL TENDENCIES**

I'd like to conclude this chapter with a discussion of three strong seasonal tendencies regarding the broad stock market. Ironically, they all occur in the last third of the year; and if you include the Value Line/S&P spread—which sets up in November—you would have three seasonal trades that you can watch for from August through the end of the year. These don't necessarily overlap, although they could at times. We will discuss the three in chronological order, beginning with the one for August, followed by the September-October one, and finally—our favorite—a very short-term seasonal tendency at the end of October and beginning of November.

### **August: The Dull Month—Or Is It?**

There is a common perception that August is a dull month for the stock market because many traders go on vacation. As a result, implied volatility of options, especially index options, tends to decrease in late July and on into August. However, there have been



a surprisingly large number of market explosions that have started in August. In fact, the fall of the year is the most volatile period in general, primarily for the stock and the bond markets. Volatile markets make straddle buying—the purchase of both a put and a call with the same terms—attractive. The fact that some of that volatility in the stock market comes as prices fall (sometimes suddenly) only enhances the strategy, because implied volatility increases and inflates the price of the straddle that is owned.

The August–September time period is a pretty volatile one if you consider the data for the 23-year period from 1981 through 2003 as shown in Table 5.5. You can see that August has been the start of serious market movement in most years. In some years, the Dow Jones Industrials made a sizable move that was self-contained in the month of August. In other years, August was the beginning of a move that lasted through September or October (we'll discuss September and October in the next section). Only in 1990 was the move already underway when August began. That was the year Iraq invaded Kuwait in late July. August was still a volatile month that year, but the move actually began in July. Table 5.5 doesn't even include the fact that a crash occurred in October 1987, further extending the 8 percent loss shown in the table for that year.

The movements have continued almost every year since. In August 2001, the period from August 1 to September 30 included the terrorist attacks, but the market was already down about 600 points (5.7 percent) *before* the attacks occurred. In August 2002, the market rallied (as it was coming off a July oversold condition); but then it peaked and fell sharply through the end of September, so *both* moves are shown in Table 5.5 for 2002. Ironically, by 2003, I noticed for the first time that the media, in late July, was saying that August can sometimes lead into volatile movements by the market. So, adopting a contrarian attitude, perhaps this strategy will not work as well for the next couple of years, until the masses once again decide that August is a dull month.

What makes the data in Table 5.5 extremely interesting is that the implied volatility of index options—particularly OEX options—traditionally drops in July and August. Since volatility is low entering what has proved to be a rather volatile time period, option buying strategies (such as straddle purchases or backspreads) are favored

**Table 5.5**  
**AUGUST–SEPTEMBER VOLATILITY DURING**  
**1981–2003**

Date	General Dow Level	Movement	Percent Level
Aug 2003	8300	+600	+7.2%
Aug 2002	8600	+400, then -1700	+4.7%, then -18.9%
Aug 2001	10500	-2400	-22.9%
Aug 2000	10600	+700	+6.6%
Aug 1999	10700	+600	+5.6%
Aug 1998	8600	-1100	-12.7%
Aug 1997	8200	-600	-7.3%
Aug 1996	5600	+280	+5.0%
Aug 1995	4700	-160	-3.4
Aug 1994	3300	+200	+6.1
Aug 1993	3500	+80	+2.3
Aug 1992	3300	+140	+4.2
Aug–Sep 1991	3000	-90	-3.0
July–Oct 1990	3000	-640	-21.3
Aug–Sep 1989	2700	+130	+4.8
Aug–Sep 1988	2100	+120	+5.7
Aug–Sep 1987	2700	-220	-8.1
Aug 1986	1800	+160	+8.9
Aug–Sep 1985	1600	-60	-3.8
Aug 1984	1100	+150	+13.6
Aug–Oct 1983	1200	+125	+10.4
Aug 1982	800	+160	+20.0
Aug 1981	950	-130	-13.7

strategies for this time of the year. Traders often speak about volatility, since it is the most important influence on an option's price. If you own options and volatility increases, it works very heavily in your favor.

Even if implied volatility doesn't increase, the market movements as shown in Table 5.5 are large enough in most years to generate profits on their own. In a rising market, you may not get much of an increase in implied volatility in OEX options, so you are going to be

heavily dependent on the market rising far enough to make your straddle purchases profitable. However, in a declining market, implied volatility will normally increase; so you may get a double benefit in that case—increasing implied volatility as well as a falling market—that makes your straddle purchases profitable by falling a distance greater than you paid for your straddle.

In Chapter 1, we related the story of how an OEX call barely lost any money during the crash. The following example is a more everyday one.

---

*Example:* You might be wondering just how much of an influence an increase in implied volatility can have on the price of a long straddle. Suppose that a stock is trading at 100 and a three-month straddle is selling for 8, which is a 20 percent implied volatility. If the stock is still at 100 in a month and implied volatility is still 20 percent, then the straddle will have lost 1.25 points to time decay, and it will then be selling at 6.75. However, if the implied volatility increases to 24 percent at the end of that month, then the straddle will still be selling for 8. Thus, an increase in implied volatility from 20 percent to 24 percent completely offsets the time decay that occurs in that one month.

If the straddle has a shorter life span to begin with, time decay will be more rapid. During the next month, if volatility remains at 20 percent and the stock is still at 100, the straddle will decay to  $4\frac{1}{2}$ . Thus, it would have lost  $3\frac{1}{2}$  points of its original value due to two months of time decay. An increase in implied volatility can offset this loss as well, but it now takes a more dramatic increase to overcome the time decay that occurs during two-thirds of this straddle's life. In fact, implied volatility would have to increase to 36 percent in order for the straddle to again be selling at 8 with one month of life remaining.

Obviously, it's a lot easier for volatility to increase from 20 percent to 24 percent in one month than it is for implied to increase from 20 percent to 36 percent in two months. Still, these examples show that implied volatility is indeed a powerful factor on the price of an option.

---

In the next chapter, we discuss methods of identifying when volatility is "too low" and how to trade it. However, in this seasonal example, you can generally figure that OEX implied volatility is going to be low on August 1. Refer once again to Figure 4.24, which shows the composite level of S&P (or OEX) options implied volatility during the year; and note that it is relatively low on August 1 (not as

low as on July 1, however) and then increases during the ensuing months. You can easily tell how expensive or cheap OEX implied volatility is, merely by looking at a chart of the CBOE's Volatility Index (symbol: \$VIX). If volatility is indeed low when the beginning of August rolls around, you should buy three-month, at-the-money OEX straddles and hold them for the course of the month. Actually you might want to hold for two months, since September is a volatile month as well. Furthermore, since the composite volatility chart (Figure 4.24) shows that index option implied volatility typically is lowest in early July, you might even want to consider buying your straddles then—before the market heats up—since even if the market goes nowhere during July, we have seen that modest increase in implied volatility can raise the price of a straddle quickly.

Other markets often display similar characteristics: implied volatility is low in the late summer, but prices can be volatile in the fall of the year. In particular, these three are also good candidates for straddle purchases of other option buying strategies, beginning near August 1: (1) gold, (2) the CRB Index, and (3) T-bonds (or 10-year notes). Not every one of these three markets has a major move in the fall of every year, but moves do occur with frequency. Gold has often moved \$40 or more in the August-September time frame. Similarly, the CRB Index has moved 10 points (and as much as 25 points in certain years), and T-bonds routinely move 5 points and generally more—a substantial move for that market. In fact, a \$50 move in gold, a 10-point move in CRB futures, and a 5-point move in T-bond futures are each worth \$5,000 per contract.

**Determining the History of Implied Volatility.** Thus, there is plenty of profit potential in looking for low-cost straddles in these markets. The optimum way to analyze the situation would be to evaluate the implied volatility of each market in July, up to August 1. If it is low or at least not above normal, you can buy December futures option straddles. By owning the intermediate-term straddle, you won't be so subject to time decay during the early portion of your holding period. If the underlying market makes a quick move, you will benefit; and you might even get an extra boost if the implied volatility of the options you own increases as well.

In order to determine what is “normal” volatility, you need to know where the implied volatility has been trading over at least the past few months. This information is available in a number of places. It is available for free on our web site, [www.optionstrategist.com](http://www.optionstrategist.com), where we list the percentile of implied volatility for every stock, index, and futures contracts that last listed options. This free data is updated weekly. For a more complete picture, we also offer volatility charts of these markets and many others, as well as a lot of additional option-oriented data, on the subscriber section of our web site, called The Strategy Zone.

As we said, these sources allow you to look at where the implied volatility has been trading. This is important, and it is different from the historical volatility. As we have noted before, implied volatility in some markets continually trades at higher levels than actual volatility. So what you want to do at the beginning of August is to see if implied volatility is at or below average with respect to where it has been trading over the past few months. The data on our web site also shows historical volatility over several time periods (20-day, 50-day, and 100-day) so that you can easily compare its implied volatility levels at the time.

### **September–October: A Very Tradeable Time Period for the Stock Market**

We now take a look at another seasonal trading pattern during the period from Labor Day through mid-October. Some of the biggest moves have come during this time, and there are some patterns that stand out. This information does not conflict with what we just discussed regarding the August time period. In fact, it may help to fine-tune your exit points for positions that you already have in place when Labor Day arrives.

As many analysts and media types have observed, September is often a month of decline for the stock market. The period of time surrounding the Labor Day holiday often marks a short-term market top. However, “often” is too vague a term, for there have also been some good rallies in September. Thus, you need to analyze the data more carefully in order to be able to construct a trade.

There is normally a rather substantial broad-market correction of about 5 percent or more that begins in either September or October. The market *usually* begins a correction on or about Labor Day, but not every September is a down month. What we did find, however, is that even if September is a rising month, a correction will often occur in October.

There are three main scenarios that the market has followed for the past 30-some years: (1) a top is formed near Labor Day, and the ensuing bottom occurs in September (occasionally, the bottom does not come until October); (2) a top is formed in mid-to-late September, with the ensuing bottom occurring in the first week or two of October; (3) a top is formed in early-to-mid-October, with the bottom coming in early November. The data are summarized in Table 5.6.

**Table 5.6**  
**SUMMARY OF MARKET DECLINES,**  
**SEPTEMBER/OCTOBER 1973-2003<sup>1</sup>**

Year	High Date	Maximum Correction (%)	Year	High Date	Maximum Correction (%)
1973	Oct 12 <sup>3</sup>	-14.4	1989	Sep 1	-7.9
1974	Aug 30	-12.5	1990	Aug 29	-9.1
1975	Aug 25	-3.5	1991	Aug 28	-5.3
1976	Sep 21 <sup>2</sup>	-7.4	1992	Sep 4	-5.3
1977	Sep 7	-7.1	1993	Sep 2	-3.3
1978	Sep 6	-11.4	1994	Aug 29	-5.7
1979	Oct 5 <sup>3</sup>	-10.0	1995	Sep 29 <sup>2</sup>	-2.3
1980	Sep 22 <sup>2</sup>	-5.4	1996	(No correction at all)	
1981	Aug 26	-9.6	1997	Oct 7 <sup>3</sup>	-9.7
1982	Sep 15 <sup>2</sup>	-5.5	1998	Sept 23 <sup>2</sup>	-6.4
1983	Oct 16 <sup>3</sup>	-6.8	1999	Sept 9	-9.6
1984	Aug 29	-4.2	2000	Sept 6	-11.8
1985	Aug 28	-4.9	2001	Sept 5	-14.6
1986	Aug 27	-8.8	2002	Sept 10	-15.3
1987	Sep 2	-35.3	2003	Sept 18 <sup>2</sup>	-4.0
1988	Oct 20 <sup>3</sup>	-7.1			

<sup>1</sup> Entries are scenario 1 except for the following:

<sup>2</sup> Scenario 2.

<sup>3</sup> Scenario 3.

Of the 31 years worth of data, scenario 1 (top near Labor Day) has occurred 19 times; scenario 2 (top in mid-to-late September) has occurred 6 times; and the final scenario (top in October) has occurred 5 times. That leaves one left over: in 1996, there was no correction at all to speak of, as the Dow rose about 300 points (from 5600 to 5900) in more or less a straight line. Note how severe the downdrafts were during the bear market (2000–2002).

So now that it has been established that a correction typically takes place, beginning at one of these three times, we must decide on how the beginning of that correction can be identified. Either that, or utilize a strategy that will make money when the correction finally occurs. Obviously, we don't just want to rush in and buy puts on the trading day before Labor Day. That might be a losing trade in any year that followed scenario 2 or 3.

The put-call ratios that were described in Chapter 4—both the index and the equity-only—and the short-term oscillator that we described early in this chapter are useful in making timing decisions of this sort, especially when you have an inkling of which way you expect the market to go. You only need confirmation from these indicators.

---

A good case in point is 1995 because the market rallied quite strongly through the first half of September, eventually topping out for a small correction on September 29. This fits into scenario 2. When Labor Day arrived, the put-call ratios were all on buy signals; that is, the *trend* of the ratios was down, from a previous peak. In addition, there was no particular reading one way or the other on the oscillator. Thus, no bearish positions were taken at that time.

As the market rose dramatically in the two weeks after Labor Day, the oscillator became overbought, and a sell signal was generated on September 22. This was a bit premature; and since there was not yet a confirmation from the put-call ratios, I bought bear put spreads: with OEX near 551, the Nov 550 puts were bought and the Oct 540 puts were sold (the reason that Octobers were sold was that they were very expensive in terms of implied volatility and were therefore a better sale than the Nov 540 puts at the time).

The market sputtered a little at that point but eventually worked higher into September 29. The put-call ratios finally gave sell signals at that time—

on September 28 actually. So we then had the confirmation we wanted. More put spreads were bought, this time using a wider difference in the striking prices and also using higher striking prices: the Nov 560 puts were bought and the Nov 545 puts were sold.

Finally, the market broke—swiftly, but briefly—and OEX traded down to 544 in a matter of a few days. At that time, the oscillator actually became oversold and generated a buy signal. That buy signal was used to take some profits, although the positions weren't completely closed out until the put-call ratios also issued buy signals with OEX near 553 in the final week of October.

---

There is an additional corollary to this seasonal pattern: there is usually a good trading *bottom* in late September or October. Conventional wisdom holds that the best buying opportunities occur at the October bottoms. That may be true, when the bottom indeed occurs in October. What is, in fact, more correct to observe is that there is often a good bottom at the end of the declines that are part of this seasonal trading pattern. Under scenario 1, when the top is near Labor Day, the eventual bottom is often reached in mid-to-late September—although the decline sometimes stretches into October—whereas under scenarios 2 and 3, the bottom is indeed in October. Some of the most spectacular bottoms have come in October—1974, 1978, 1979, 1985, 1989, 1990, 1992, 1997, 1998, and 2000. In 2001, the bottom came in late September; and in several other years, October was a trading bottom, just not a "spectacular" one.

In sum, then, you should be alert for an opportunity to buy puts or short the futures in the time period near Labor Day. If a top does not develop at that time, then a trading top should develop in late September or early October. However, these tops are generally *not* major tops, just good trading opportunities. Eventually, they give way to good buying opportunities in late September or October. This information confirms the observations made in the previous section: sectors of the market are volatile in the fall of the year. In the next section, a short-term seasonal buying opportunity is described, and it meshes well with these other seasonal patterns also.



## Late-October Buy Point

In 1994, the magazine *Technical Analysis of Stocks and Commodities* printed an article that pointed out a peculiar phenomenon: if you buy the S&P futures on the close of trading on October 27 and sell them on November 2, you would have made money every year since 1982, except for one in which you would have lost 0.45 point. The article detailed the years 1982 through 1993, when profits mostly were in the range of two to four points, although two years had much larger profits. The article pointed out that you may want to use your own judgment in exiting the trade, as a rather large move occurred in only one or two days in some years.

I liked this concept and have kept up the data on this spread over the years. It is by far the most important short-term seasonal time of the year that I have found—better than a similar one at the end of January and better than the “Santa Claus rally” near the end of the year.

Using this as a guideline, we decided to go back farther than 1982 (that’s the year the S&P 500 futures were first listed, so there is no historical data prior to that time for those futures). In order to go back in time, we used the S&P 500 cash index. What we found was that the S&P 500 cash index has advanced between October 27 and November 2 in every year between 1978 and 2001—an extraordinary streak of 24 years—except one in which it was unchanged. The data in Table 5.7 show this remarkable phenomenon. It should be noted that if October 27 falls on a weekend, you buy the S&Ps at close of trading on the Friday *before* October 27. However, if November 2 falls on a weekend, you don’t sell until the close of trading on the Monday *after* that weekend.

Why does it work? There is no good reason, except the ubiquitous one: “seasonality.” It reminds me of the best football “system” I ever saw: it was merely to bet on Syracuse the week *after* they played Penn State. The system worked for 19 years in a row (unfortunately, Penn State terminated their series with Syracuse when they joined the Big Ten).

Actually, there is some logic behind this trade. First of all, as we have recently shown, the market often bottoms out in October and has staged a strong rally by the end of the month. This system seems

**Table 5.7**  
**BEHAVIOR OF THE S&P 500 CASH INDEX FOR**  
**OCTOBER 27 TO NOVEMBER 2, 1978–2003**

Year	S&P Advance (Oct 27–Nov 2)	Year	S&P Advance (Oct 27–Nov 2)
1978	+1.53	1991	+7.12
1979	+1.95	1992	+4.26
1980	+1.16	1993	+3.83
1981	+4.90	1994	+0.66
1982	+2.22	1995	+10.02
1983	0.00	1996	+5.81
1984	+2.13	1997	+62.01
1985	+4.00	1998	+46.26
1986	+7.03	1999	+51.03
1987	+22.56	2000	+48.74
1988	+1.78	2001	-17.41
1989	+3.43	2002	+10.70
1990	+7.15	2003	+18.90

Average profit: 11.95 S&P points, or 1.84 percent.

to work especially well in those years. Institutions, who have a herd mentality, generally were sellers during the September-October decline; but when they see that the market has rallied strong by the end of October, they buy stocks to get something “on the books” for the end of the month. That’s called “window dressing,” and it’s very common near month-end—obviously and especially in October. As a corollary, note that the one year that the system lost—2001—the market actually bottomed in September, shortly after the terrorist attacks. The institutions that year bought near the end of September, and by the time the end of October rolled around, they didn’t feel the need to window dress nearly as much. Another reason that this system works is that the end of October is the fiscal year-end for many mutual funds, and they might want to buy stocks on the strong rally to window dress their year-end portfolios even more than at a typical month-end.

I would use a trailing stop if you get a move in your favor right away—in order to lock in profits, and you might want to take partial

profits if the S&P moves three or more points in your favor. As far as a trading vehicle goes, if you don't want to use the futures, I would suggest buying the nearest in-the-money November OEX or SPX call, since you will be exiting the position on November 2, at the latest. By using the in-the-money call, time decay shouldn't be too much of a problem for a five-day trade. As always, though, you should check the implied volatility of the OEX options before you buy them, since that is what can have the greatest effect on option prices in such a short time. If the options are overly expensive in terms of implied volatility, I would stress using the futures instead as your trading vehicle. I don't think I would use a bullish call spread for this system, since the movements were quite large in several of the years and you might be unnecessarily limiting your profit potential with the bull spread.

So, there you have three good seasonal patterns to trade with during the late summer and early fall of the year. Those, coupled with the January effect, should keep you busy and profitable right on into the new year.

### **Late-January Buy Point**

In the preceding discussion, a reference was made to a late-January buy point. The theory is similar in this case: buy "the market" on the eighteenth trading day of January, and sell your position out at the close of trading, five days later. The reasoning behind this system was solid: institutions generally receive heavy cash inflows at the beginning of a new calendar year. Typically, they don't invest all that money right away; but as the end of the month rolls around, they don't want to have a lot of cash showing on their balance sheets, so they buy stock heavily at the end of the month to use up the excess cash. While that reasoning seems sound, this system has a much spottier track record than the late-October buy system discussed in the previous section.

Perhaps that's because institutions are a little more aggressive now and have been putting the money to work as soon as possible in recent years. That was certainly the case in 2004, but it's doubtful in the bear-market years that they were rushing to buy stocks

early. In any case, the track record for the system is shown in Table 5.8.

You can see from the table that the system had an exceptional track record from 1986 through 1998. There was one losing year (1992), but in general there was not even any drawdown from the entry price on closing basis (the far right column in Table 5.8 shows zero drawdown in nearly every year through 1998). In fact, in some years, there was not even an *intraday* drawdown from the entry price, that is, on the first day, the market opened higher the next morning and just kept going up from there.

But in recent years, this system has run into problems. Most of them, though, are related to the fact that you can't hold for five days

**Table 5.8**  
**JANUARY SEASONAL TRADE HISTORY**

Year	Buy	Five Days Later	Gain	Drawdown	
				Intraday	Close
1986	207.4	214.0	+6.6	0.0	0.0
1987	273.8	276.0	+2.2	-2.4	0.0
1988	249.4	257.2	+7.8	0.0	0.0
1989	291.7	296.8	+5.1	-0.7	0.0
1990	326.1	328.8	+2.7	-0.7	0.0
1991	336.1	343.0	+6.9	-1.8	-0.3
1992	415.0	409.5	-5.5	-7.5	-5.5
1993	438.1	447.2	+9.1	-1.2	0.0
1994	473.2	482.0	+8.8	0.0	0.0
1995	468.3	472.8	+4.5	-0.8	0.0
1996	617.0	638.5	+21.5	-1.7	0.0
1997	765.0	786.7	+21.7	0.0	0.0
1998	977.4	1006.9	+29.5	-2.2	0.0
1999	1265.4	1248.4	-16.9*	-17.7*	-16.9*
2000	1398.6	1425.0	+26.4	-42.4	-38.4
2001	1354.9	1349.4	-5.5*	-6.2*	-5.5*
2002	1133.1	1094.4	-38.7	-40.9*	-38.7*
2003	858.5	848.2	-10.3*	-18.4	-13.9
2004	1128.4	1126.5	-1.9*	-3.7*	-1.9*

\*Most of loss occurred on the last day.

any more—four seems to be optimum, and even three days in some cases. Take 2004 as an example: the buy point was 1128.4 (SPX price) on January 28, the close of the eighteenth trading day of January. Over the next four trading days, SPX rallied about 8 points, closing at 1136 on February 3, 2004, the fourth day. But then on the fifth day, it fell nearly 10 points and caused the system to record another losing year (bottom line of Table 5.8). Also, the year 2000 is worth mentioning, in that a big profit was registered, but the drawdown was huge. Someone trading this with options might have done okay, but anyone trading it with futures would probably have stopped himself out when the loss loomed large during the drawdown (which, by the way, occurred *entirely* on the first trading day of the system in 2000).

Here are the adjusted figures for 1999 through 2004, showing that, in general, there was a market rally during the time frame, but it didn't last all five days.

<i>Year</i>	<i>Observations</i>
2003	Profit existed after day 1 <i>and</i> after day 4.
2002	A profit <i>never</i> existed; but loss was minimal after day 3, and SPX collapsed 28 points on day 5.
2001	System +19 points after day 4; fell 24 points on day 5.
2000	Big drop on day 1, but recovered to a big profit by day 5.
1999	+14 on day 1; still had +7 after day 4; but day 5 was -24.

So, you can see that in recent years, day 5 has often been a disaster. (In fact, is there are a corollary system that we short the market on day 5 now?)

Incorporating this recent data, the way to trade this system is (1) to use options and (2) to take most, if not all, of your money off the table at by the end of day 4. The use of options will allow you to know your maximum risk going into the trade and will allow you to wait out drawdowns (as in the year 2000) without panicking out of your position. Your results would be much better than those shown in Table 5.8 if you merely exited at the end of day 4 (true, you would have missed that last 15 points profit in 2000, but you would have still shown a profit). Table 5.9 shows what exiting at the end of day 4 would have done since 1999. This is clearly an improvement, as five

**Table 5.9**  
**LATE-JANUARY SEASONAL TRADE**  
**WITH EXIT AT END OF DAY 4**

Year	Result at End of Day 4	Result at End of Day 5
1999	+6.7	-16.9
2000	+10.6	+26.4
2001	+18.1	-5.5
2002	-10.8	-38.7
2003	+1.8	-10.3
2004	+7.6	-1.9

of six years now *make* money instead *losing* money. So, the preferred system is now to be adjusted to exit after four days. If you feel that day 5 will be good also, you could retain a portion of the position and see how that day develops, using some sort of tight intraday stop in case it's another down day 5.

## SUMMARY

In this chapter, we have presented a series of trading strategies that have good track records. Some are very short-term oriented—day-trading—while others are longer-term in nature. You may not follow all of them, but at least you can choose the ones that are amenable to your philosophy of trading. When the time is right, whether that be daily, or less frequently as with the momentum oscillator, or only once a year as with some of the seasonal trades, analyze the futures and the options before actually trading. Be aware of fair value of the futures and of implied volatility on the options. With careful analysis, you should be able to turn profits with the strategies introduced herein.



# 6 Trading Volatility and Other Theoretical Approaches

In this chapter, we look at another approach to trading, one based on mathematical evaluations. It is sometimes called *neutral trading* because the price movement of the underlying security doesn't have to be predicted in order to make money. That may be true, but you must understand one thing: *it is certain that you will have to predict something in order to profit, for only market makers and arbitrageurs can construct totally risk-free positions that exceed the risk-free rate of return, after commissions.* Moreover, even if a position is neutral initially, it is likely that the passage of time or a significant change in the price of the underlying will introduce some price risk into the position.

In Chapters 3, 4, and 5, we have looked at various trading strategies that rely on pricing projections, many of them based on past history or technical analysis. These methods are successful and rational. What they all have in common is that in order for these strategies to profit, the underlying security generally needs to move in a favorable direction. There were some exceptions, such as using options in intermarket spreads in order to give yourself an extra chance to make money if prices are merely volatile; but normally the preceding strategies were price-dependent. Each strategy, whether it was based on option volume or on the historical relationship of two markets, had its own particular "edge." That edge will often be good enough to generate superior returns.



However, some traders prefer an approach that relies less on predicting prices, which many mathematicians claim cannot be done, and more on the mathematics of options. This, in essence, is the theoretical approach. With the *theoretical* approach, you attempt to construct strategies that will make money based on factors other than price changes. Moreover, since options are a derivative security, there are definite relationships between the option and the underlying security—and between the properties of both of them—that can be exploited without predicting price movements.

This chapter is divided into four broad segments: the introductory material; the basic strategies used for trading volatility within a range; more-advanced strategies for trading volatility within a range; and, finally, trading a volatility skew, a situation where individual options on the same underlying security have distinctly different implied volatilities.

Before getting into the actual strategies, we define some more terms and properties that are needed for these discussions.

## VOLATILITY

In Chapter 1, it was stated that the value of an option is a function of six variables: stock price, strike price, time, interest rates, volatility, and dividends (for equity and index options). All of these are known quantities, except for volatility. As also noted in Chapter 1, there are two types of volatility: *historical volatility*, which tells how fast prices have been changing; and *implied volatility*, which is the option market's perception of future volatility.

In order to calculate implied volatility, all you need to do is to determine what volatility it is necessary to use in your evaluation model, so that the model's theoretical value agrees with the actual market price of the option. The model's general equation can be written as

$$\text{Option value} = f(\text{stock price, strike, time, rate, volatility})$$

We know the stock price, the strike price, the time remaining to expiration, and the interest rate. We also know at what price the op-

tion is actually trading in the marketplace. Therefore, what volatility must we use in the model—along with these other four known values—in order for the model to yield the current option price as the option value? That volatility is the implied volatility.

Most option software will quickly give you the implied volatility of an option or a list of options. The implied volatility is actually determined by an iterative process, which can require a rather large number of calculations; but today's computers are so fast that you don't really notice the amount of calculating that's going on.

When trying to evaluate whether an option is expensive or cheap, we usually state that quality in terms of *implied volatility*. For example, rather than saying, "That option is overvalued," it is more common to say, "That option is trading with a high implied volatility." In this statement, the term "high" would presumably be with reference to the levels of historical volatility or to past measures of implied volatility on this particular underlying security.

Many theoretical traders feel that volatility is not only the most crucial element of understanding and profiting from option trading, but it is the easiest thing to predict. Therefore, if we could shift our emphasis away from trying to predict the price movement of the underlying security and toward trying to predict the volatility of the underlying security, we could profit with more regularity and less uncertainty.

---

In January 1994, the implied volatility of Standard & Poor's 100 Index (OEX) options dropped to its lowest level ever. A compilation of past readings of OEX volatility showed that it had rarely been measured at a level below 10 percent. In fact, it had only dipped to that level two other times. Most of the time, OEX implied volatility had traded higher—normally in the 11 percent to 14 percent range in the previous few years—and even at higher levels in the 1980s.

Not only that, but *historical* volatility was low as well, as it stood at about 7 percent. It had occasionally been as low as 6 percent briefly in its 10-year history, and normally ranged in the 9 percent to 12 percent neighborhood, or higher.

Meanwhile, the stock market was making all-time highs after a long round of interest-rate cuts by the Federal Reserve System (although there hadn't been any cuts recently), and bond futures were trading near all-time

highs as well. Earnings projections seemed to be quite bullish, and economic activity was positive, although not overheated. There were some troubling items out there—utility stocks had made a peak and turned down about four months earlier; and some fundamental valuations of stocks showed them to be rather high priced, especially in light of the fact that there had not been substantial stock market correction for three years.

Given these data, which would you feel more comfortable predicting: future volatility levels or the direction of the stock market? If you said volatility, then this chapter is for you. If you said the stock market, then you should read this chapter also—and I'll try to change your mind.

The fact is that volatility was rarely this low, so you would have to suspect that it was going to increase to more normal levels. Sometimes, such an increase doesn't occur right away; although with a market as large as the U.S. stock market, you wouldn't expect it to take too long. On the other hand, which way the stock market was headed seemed to be anyone's guess—as it often is—because there were arguments to justify both a bearish and a bullish scenario. Thus, to me, it seems as if a prediction that volatility would increase was much more certain to come true than a prediction of whether the stock market would rise or fall. A simple strategy to take advantage of this analysis would be the purchase of a straddle, which could make money if prices either rose or fell and would be benefited by an increase in implied volatility.

As it turned out, the Federal Reserve System (the Fed) raised interest rates in early February, touching off a nasty correction in the stock market. Implied volatility exploded to 22 percent by the end of March, and the price of OEX fell over 9 percent. Straddle buyers profited handsomely.

---

This example may admittedly be an extreme one: OEX implied and historical volatilities were at all-time lows, so it was a pretty safe bet that they were going to rise. But, in more normal situations, you might remain skeptical of anyone's ability to predict future volatility. In the next few sections, we look at two ways of trading volatility and some simple, as well as complex, ways in which to structure strategies for that purpose.

So now the emphasis of our strategy will be on predicting volatility and trading its movements, if possible, rather than on predicting the price of the underlying security. In fact, we would just as soon be neutral with respect to the price of the underlying, for we don't care

if it rises or falls, as long as our prediction of volatility is correct. Thus, we need to discuss how to make a strategy price neutral.

## DELTA NEUTRAL TRADING

When most people talk about trading neutral strategies, they mean *delta neutral*. Recall that *delta* is the measure of how much an option moves when the underlying instrument moves one point. If we calculate the deltas of all the options in a strategic position and add them together, we can arrive at a *position delta*, which tells us how much money we can expect to make or lose if the underlying instrument moves one point.

---

*Example:* Suppose that a trader has a bull spread in place—long the Jan 100 calls and short the Jan 110 calls. He can calculate his position delta by using the deltas of the options in the spread. The pertinent statistics are:

### Stock Price: 98

Option	Position	Price	Delta
Jan 100 call	Long 10	5	0.50
Jan 110 call	Short 10	2	0.20

If the stock moves up one point, each of his long calls will increase in value by a half point, since the delta is 0.50. Thus, since he owns 10 of them, the long side of his spread will appreciate by five points when the underlying stock moves up one point.

Meanwhile, the Jan 110 call that he is short will increase in value by 20 cents if the stock moves up one point. So, the 10 of them that he is short will increase in value by a total of two points.

Therefore, his position delta is long three points (the longs will increase by a total of five points, while the shorts will increase in value by two points, hence the net of these is five minus two, or three). This means that his position will increase in value by \$300 if the underlying moves up one point; it also means that his position will lose \$300 if the stock falls by one point.

---

The position delta is also called the *equivalent stock position* (ESP), or if futures and futures options are being evaluated, the position delta can also be referred to as an *equivalent futures position* (EFP). The position delta can be calculated for any complex portfolio merely by calculating each option's equivalent stock position and summing them all together. The simple formula for calculating an equivalent position in an individual option is:

$$\text{ESP or EFP} = \text{quantity} \times \text{trading unit} \times \text{delta of option}$$

Again, using the data from the preceding example, we can calculate the equivalent stock position of the two options in the spread. In both cases, the "trading unit" is 100 (for 100 shares per option).

$$\text{ESP of Jan 100 call} = 10 \times 100 \times 0.50 = 500 \text{ shares}$$

$$\text{ESP of Jan 110 call} = -10 \times 100 \times 0.20 = -200 \text{ shares}$$

$$\text{Total ESP} = \text{position delta} = 500 - 200 = +300 \text{ shares}$$

Thus, owning this spread is "equivalent" to owning 300 shares of the underlying stock. Of course, as the underlying stock moves up or down, the deltas of the options will change (they will also change as time passes). When the deltas change, the ESP will change as well. But for this moment, the position is equivalent to owning 300 shares of the stock.

So, it is a simple matter to compute the position delta on even a complex option strategy and "reduce" the position to an equivalent number of shares of the underlying stock. If this position delta is very near to zero, then we have a neutral position that won't make or lose money if the underlying stock moves one point. This is extremely useful information because, if you want to hedge the risk of your position, you merely have to use that information to take an equal but opposite position in the underlying stock. In the preceding example, you would sell short 300 shares of the underlying stock in order to neutralize your price risk (at least for the moment).

Such a position is considered to be a *delta neutral position* because it is neutral with respect to the variable, delta. The neutral position has always held attraction to investors, especially those who

(1) are mathematically inclined, (2) believe prices move in a random manner, or (3) are just tired of trying to predict the market and being incorrect. In theory, if you were able to sell an “expensive” option and hedge its sale with the purchase of a “fairly” priced option, you could capture the differential in price by a neutral position. Mathematics bears out this philosophy, but the reality of trading such a position is more difficult than you might expect. In reality, neutral trading can be very dangerous if you aren’t careful.

In a delta neutral position, the other variables that affect the profitability of a position are not necessarily neutral, but at least delta is. When you have a delta neutral position, you have no risk of loss or potential for gain for *small, short-term moves* by the underlying instrument. However, if the stock rises or falls too much, or if time passes, or even if the implied volatility changes, the delta of each option will change. Once these deltas change, the position will generally no longer be delta neutral. In fact, it might acquire quite a bit of risk.

---

In July 1993, soybeans had rallied quite a bit because of heavy rains and flood conditions in the Midwest. Options had gotten quite expensive, and a strategist might have considered a ratio spread as a way of establishing a delta neutral position. The following statistics describe the position on July 2, 1993:

#### August Soybeans: 665

Quantity/Option	Price	Delta	Position Delta (EFP)
Long 50 Aug 650 calls	30½	0.63	Long 31.5 contracts
Short 100 Aug 700 calls	12	0.31	Short 31.0 contracts
		Total:	Long 0.5 contracts

This position is very nearly delta neutral, since the EFP of the long options is just about completely offset by the EFP of the short options. Since these options were due to expire on July 24, 1993, they were quite short-term options. This led to the appeal of a neutral position.

A three-day weekend including the Fourth of July followed, so the next trading day was July 6. The floods had worsened, so beans opened up the limit and remained there. The following prices existed at that point:

**August Soybeans: 695**

Quantity/Option	Price	Delta	Position Delta (EFP)
Long 50 Aug 650 calls	59	0.74	Long 37 contracts
Short 100 Aug 700 calls	32½	0.50	Short 50 contracts
		Total:	Short 13 contracts

At this time, the position had become seriously delta short. Not only that, the position was losing significant money. The 50 longs had appreciated by 28½ points, or \$71,250. However, the 100 short options had lost 20½ points, or \$102,500. The overall unrealized loss was \$31,250.

Even though the position was delta neutral initially, it had destabilized significantly in just one trading day, quickly becoming delta short and losing considerable money.

This example demonstrates just how deceiving a delta neutral position can be; such a position is only delta neutral for *small* moves by the underlying security (soybean futures, in this case). Notice that the losses could be significant even for the smaller trader. Using the same example, if you were long 5 of the Aug 650 calls and short 10 of the Aug 700 calls, you would still be losing \$3,125 on that small position in just one trading day.

The preceding example demonstrates the importance of the relationship between price and delta. However, delta can also be significantly affected by volatility, or, more appropriately, implied volatility—that is, if the options get more expensive or become much cheaper in terms of implied volatility, the deltas of the options can change. Any such change would distort the neutrality of a delta neutral position.

Federal Paperboard (FBO) was trading just under \$40 a share in late October 1995 when a vague takeover rumor surfaced. Initially, the rumor was more evident in the price of the options than it was in the price of the stock—that is, the options gained considerable implied volatility, but the stock only rose slightly. The following statistics show how such an event affected a delta neutral position. On October 30, 1995, the following prices existed, and a trader might have established a delta neutral spread, not knowing that there was a takeover rumor:

**FBO: 39<sup>5</sup>/<sub>8</sub>; Implied Volatility of the Options: 54%**

Quantity/Option	Price	Delta	Position Delta (ESP)
Long 10 Jan 40 calls	3	0.52	Long 520 shares
Short 30 Jan 45 calls	1/2	0.16	Short 480 shares
Total ESP:			Long 40 shares

This initial position has an ESP very nearly zero, so it is considered to be delta neutral. Within three days, the stock had edged up to 41—not a large move. However, option buyers obviously had some information regarding the takeover rumors and were bidding up the options, which had increased to an 89 percent implied volatility just three days later. This is a significant increase in implied volatility, and the position had thus acquired the following look:

**FBO: 41; Implied Volatility of the Options: 89%**

Quantity/Option	Price	Delta	Position Delta (ESP)
Long 10 Jan 40 calls	5 1/2	0.60	Long 600 shares
Short 30 Jan 45 calls	2 1/4	0.32	Short 960 shares
Total ESP:			Short 360 shares

So this position had now acquired the look of a short position, equivalent to being short 360 shares of FBO. Part of that change in the delta was due to the stock's increase in price from 39<sup>5</sup>/<sub>8</sub> to 41, but the majority of it was due to the explosion in implied volatility. Also notice that this relatively small position was showing an unrealized loss of \$2,750 after this change in implied volatility.

The general relationships between delta and time and between delta and volatility are discussed in more detail later in this chapter.

The previous two examples involved selling naked options. Neutral positions don't always require you to have naked options in them. In fact, you can construct delta neutral positions with long options in them (backspreads, for example). However, that doesn't mitigate the fact that a price change or a change in implied volatility can severely alter the neutrality of the position.



## Keeping a Position Neutral

Sometimes, when the neutrality changes, losses result. Even if losses don't accrue, the position acquires market risk as it becomes either delta long or delta short. The position might eventually become profitable, but it is important to understand that merely establishing a delta neutral position doesn't mean that you can just walk away from it and make a profit. Since price changes by the underlying security affect the neutrality of the position, it is necessary to readjust the delta to keep the position neutral.

The easiest way to adjust a position back into a delta neutral status is to use the underlying security. In the most recent example, the position had become delta short 360 shares of FBO after the implied volatility increased. Obviously, that delta could easily be neutralized by buying 360 (or, more likely, 400) shares of FBO. Then the position would once again be delta neutral. Of course, it would still be susceptible to further swings in position delta, each of which would require another adjustment.

---

Another way to adjust the FBO spread back to neutrality would be to buy some more of the Jan 40 calls, which were already long in the position. After the stock rose to 41 and implied volatility ballooned to 89 percent, the position was delta short 360 shares of FBO. Moreover, the delta of the Jan 40 calls was 0.60 (see the preceding example for these details).

Notice that the ESP of *one* Jan 40 call is 60 shares:

$$\text{ESP} = 1 \times 100 \times 0.60 = 60 \text{ shares}$$

So, if you were to buy six more of these Jan 40 calls, you would be adding  $6 \times 60$ , or 360, delta long into the position. This would completely and exactly neutralize the existing delta short position. Thus the new position would be:

Quantity/Option	Delta	Position Delta (ESP)
Long 16 Jan 40 calls	0.60	Long 960 shares
Short 30 Jan 45 calls	0.32	Short 960 shares
Total ESP:		0 shares

---

So, you could either buy stock or buy more of the calls that you are already long in order to adjust. These are the most common tactics used, although you may also buy in some of your short calls. In fact, you could buy *any* calls in the proper amount in order to neutralize the position. Usually, small traders will buy one or the other of the calls that are already in the position. However, a market maker or a trader with a large position may be forced to buy whatever is being offered. Thus, he might wind up with a rather complex position. It is no problem to evaluate the neutrality of the larger, more complex positions, though, since the same ESP formula can be applied to each option in the position, no matter how many of them there are, and the result totaled.

Market makers attempt to keep their positions neutral. They prefer to make their money by buying on the bid and selling on the offer. If they have to carry a position, they would just as soon that it not have any price risk. Market makers of listed options can usually extricate themselves from their positions fairly quickly, especially if the options are liquid. However, over-the-counter option market makers (which include several of the largest banks and brokerage houses) and market makers in illiquid options may be forced to carry their positions for quite a while before they can hedge them off completely or before the options expire. These are the market makers who keep their positions neutral and make adjustments as time goes by.

---

The necessity of these market makers to adjust positions raises the specter of something similar to what caused the crash. Recall from the example in Chapter 3 that practitioners of portfolio insurance had to sell futures in huge quantities in order to protect their stock positions. That practice is no longer being followed. However, what is being done by some of these same institutions for protection is that they are buying puts as insurance against a large market decline. Many of these puts are of the over-the-counter variety, being transacted directly between buyer and seller and tailored in specific ways as to expiration dates, striking prices, and underlying “security.” In fact, the underlying security may be a very specific basket of stocks that resemble the stocks in the institution’s portfolio.

Someone, of course, is selling these puts to the institutions that are buying them. That “someone” is the over-the-counter market makers—large firms such as Salomon Brothers, Goldman Sachs, Morgan Stanley, Swiss-

bank, or Banker's Trust. The puts are generally overpriced when the institution buys them—that's why the trading houses are willing and eager to sell them. So all the market maker has to do is hedge his portfolio properly, and he will profit to the tune of the "overpriced" portion of these puts. If he is short puts, that makes him delta long. Since most of these puts are on baskets of stock or on broad-based stock indices, the market maker is thus delta long "the market." He can easily hedge this long by selling S&P 500 futures.

What worries some regulators is that if the market were to head down in earnest, as it did in 1987, these market makers might have to sell a lot of futures in order to hedge their short put positions. Since these puts were created in over-the-counter transactions, no one really knows how many of them are in existence, in total. Moreover, no one knows the extent of the hedges at any time. So there is some chance that what happened in 1987 to worsen the market decline on the day of the crash could happen again.

---

These over-the-counter market makers are smart traders. So they understand the ramifications of a portfolio that is too delta long or that has the potential to become too delta long if the market declines. Thus, they have attempted to balance out their portfolios wherever possible by encouraging institutions or other traders to *sell* puts. This, of course, would transfer the potential of downside liability from the market makers to other traders. Overall, however, it seems to me that most institutions are overall net *buyers* of puts for their insurance value. Thus, whoever sold those puts, be it market makers or other institutions, have potential downside liability. Perhaps the market won't ever decline so severely or so far that it would force those who are delta long to take drastic measures, but you can't be sure.

### **Other Forms of Neutrality**

We have already shown that delta neutral trading is only neutral for a short period of time and within a fairly short price range of the underlying. As long as you understand this fact, you can devise strategies that will compensate and adjust for the changing delta. However, if there is too great a change in price or in implied volatility, there may not be any adjustments that can "save" the position. Throughout history, we have seen such gaps and they have been

costly to delta neutral traders. Earlier in this book, we gave several examples of this: the crash of 1987, the large rally in April 1978, or the Barings Bank problem that began with straddle selling.

When neutral trading first became possible shortly after the introduction of listed options in 1973, there were only a few practitioners. Option premiums were extremely expensive in those times, and the neutral strategies worked fairly well, although even at that time there were problems caused for ratio writers by large rallies in October 1974, January 1975, and January 1976. Then listed puts became available, and straddle selling seemed extremely profitable; so even more “delta neutral” adherents began to surface.

Note that straddle selling is less “neutral” than is the type of call ratio spread that we used in the earlier examples in this chapter. True, you may be able to initialize a position that has no delta to begin with. However, almost *any* movement at all by the underlying will cause a straddle position to lose its neutrality.

---

*Example:* XYZ is 50.

Quantity/Option	Delta	ESP
Short 9 XYZ Jan 50 calls	0.55	Short 495 shares of XYZ
Short 11 XYZ Jan 50 puts	-0.45	Long 495 shares of XYZ
		Total ESP: 0 shares

This is a typical, delta neutral, short straddle position, established when the underlying is near the striking price of the short straddle. You sell a few more puts than calls in order to make the position delta neutral. Now, if the stock moves a little higher, the delta of the call might increase to  $-0.65$ , and that of the put would fall to  $-0.35$ . This slight movement exacts a rather large toll on the neutrality of the position; the position delta now becomes *short 200 shares*.

What has happened is that when the stock moves, the deltas of both options in the straddle are changing in the same direction—that is, if the stock moves up, the calls are being *more* delta short, while the puts are simultaneously becoming *less* delta long.

At least with the call ratio spread, this is not the case; there, when the stock moves up, the short calls become more delta short, but that is miti-

gated somewhat by the fact that the long calls in that spread become more delta long.

---

**The Gamma.** The more serious disciples of neutral trading realized that merely being delta neutral was not enough. There was still too much risk to price movements by the underlying security. What was needed was something that helped them reduce their exposure to price risk by the underlying security. If they could have something that would allow them to keep the *delta* constant—presumably, neutral—then they could have a more truly neutral position. It turns out that there is indeed just such a measure. It is called the *gamma*, and it is a measure of how fast delta changes. Thus, if you were to construct a *gamma neutral* position, delta wouldn't change at all! And, if delta didn't change, then the position would remain delta neutral. Voila! We discuss gamma neutral trading later in this chapter, after we have laid some more groundwork.

Mathematicians quickly determined that they could, in fact, quantify any position's or portfolio's exposure to any of the variables that go into making up the option price. We already know that exposure to price change is called delta. But you can also calculate, if you desire, the exposure of a position with respect to time, volatility, and even interest rates (there is no need to calculate the change with respect to the striking price, since the striking price cannot change over the life of the option). The names given to these measures are as follows:

<i>Variable Affecting Option Price</i>	<i>Measure of Exposure</i>
Underlying price	Delta
Striking price	Not applicable
Time to expiration	Theta
Short-term interest rates	Rho
Volatility	Vega

As you can see, the mathematicians gave these “measures of exposure” the names of Greek letters or names that sound like

they're Greek letters (vega is not in the Greek alphabet, but it sounds like it might be).

Moreover, as we saw in the description of gamma, you could get really carried away with this and determine how much exposure each *measure of exposure* has. This information is useful to neutral traders because they can then establish positions that are indeed quite neutral with respect to many of the things that can go wrong—specifically, sudden price changes by the underlying and sudden swings in implied volatility.

It should be understood that any of these measures of exposure will change as market conditions change. We know that the delta changes when the stock moves, or when implied volatility changes, or when time passes. In a similar manner, these other measures change under those conditions as well. However, the profitability of an option position or portfolio will be much more stable when it is neutral with respect to several of these measures of exposure.

It is sufficient to understand that we *can* use these other measures of neutrality. We return to them, in more specific terms, later in the chapter. For now, we return to the concept of attempting to predict volatility, as opposed to predicting price, the latter being what most of us are accustomed to.

## PREDICTING VOLATILITY

If you are able to predict volatility, then you can construct a position that is neutral with respect to price movements and just concentrate on making money from your volatility prediction. While this is theoretically possible, it's not easy. So, over the bulk of the remainder of this chapter, we address how this can be accomplished. Initially, we use delta neutral examples to illustrate our points. However, you, the reader, know from the preceding sections that delta neutral has its own set of problems. Eventually, we will resolve all of these problems, when we get to the sections on advanced concepts.

Imagine, if you will, that you have found a stock that routinely traded in a fixed range. It would then be a fairly simple matter to buy it when it was near the low end of that range and to then sell it when

it was at the top of the range. In fact, you might even decide to sell it short near the top of the range, figuring you could cover it when it got back to the bottom of the range. Occasionally, you are able to find a stock like this, although they are rather few and far between.

However, in many, many instances, volatility exhibits this exact type of behavior. If you look at the history of volatility in many issues, you will find that it trades in a range. This is true for futures contracts, indices, and stocks. Even something as seemingly volatile as Microsoft, whose stock rose from about 12 to 106 during the 1990s, fits this pattern. Its implied volatility never deviated outside of range between 26 percent and 50 percent, and most of the time it was in a much tighter range: 30 percent to 45 percent.

Of course, there are times when the volatility of anything can break out to previously unheard-of levels. The stock market in 1987 was a classic example. Also, volatility can go into a slumber as well, trading below historic norms. Gold in 1994 and 1995 was an example of this, as historic volatility fell to the 6 percent level, when it normally traded above 12 percent.

Despite these occasional anomalies, volatility seems to have more predictability than prices do. Mathematical and statistical measures bear this out as well—the deviation of volatilities is much smaller than the deviation of prices, in general.

You should recall that there are two types of volatility: implied and historical. Historical is a strict statistical measure of how fast prices have been changing. The historical volatility can be looked at over any set of past data that you desire, with 10-day, 20-day, 50-day, and 100-day being very common measures. Implied volatility, on the other hand, is the volatility that the options are displaying. Implied volatility is an attempt by traders and market makers to assess the *future* volatility of the underlying instrument. Thus, implied volatility and historical volatility may differ at times. Which one should you use if you are going to trade volatility?

My answer to that question is this: use a comparison of historical and implied volatility, but only if implied volatility is *not* predicting an usual occurrence for future volatility. Thus, if implied volatility is low with respect to historical volatility, then we would expect implied volatility to increase. In that case, option buying strategies, such as straddle purchases, would be appropriate. However, if implied volatil-

ity is high with respect to historical volatility, then we would normally expect implied volatility to decrease and move back in line with historical volatility, so option selling strategies would be appropriate. However, if you have reason to suspect that implied volatility is out of line for a specific reason, then you should avoid trading volatility in that issue. That reason could be impending corporate news.

In Chapter 4, when we discussed the predictive power of options, we noted that it is sometimes the case that expensive options are a harbinger of corporate news. In particular, if the options get very expensive, and particularly if they get active at the same time, then an event may be just around the corner that indicates that a large change in price by the underlying security is about to take place—a takeover, a lawsuit verdict, a ruling by a government agency, or an unexpected earnings report might fall into this category. You would want to avoid selling this type of high implied volatility.

## COMPARING HISTORICAL AND IMPLIED VOLATILITY

The situations that are often attractive for trading volatility are when there is a differential between implied and historical volatility. These situations occur with relative frequency. However, it is not enough that there is a big discrepancy between them. We also need to know where both implied and historical volatilities have been over the past months or maybe even a year; that is, we want to know what range they have been trading in. Even if implied volatility is much higher than historical volatility, we should not automatically sell the volatility unless the trading range of implied volatility confirms that it is high.

---

If you were to notice that the implied volatility of OEX was 11 percent and the historical volatility was 6 percent, you might think that you should sell options because of the differential between historical and implied volatilities. From this limited bit of information, that *does* seem like a logical conclusion. However, when you investigate more, you will see that it is an incorrect conclusion.

OEX options traditionally trade with a higher implied volatility than the actual (historical) volatility of the OEX Index. There is probably not a logical



explanation for this fact, but it is a fact. Thus, it is not sufficient for you to base your analysis on the fact that OEX implied volatility is currently 11 percent and historical volatility is 6 percent. Rather, you should look at past levels of both implied and historical volatility.

In fact, over the past year or even several years, OEX implied volatility has ranged from a low of 10 percent to a high of 22 percent. So you can see that the current reading of 11 percent is actually quite low. In a similar fashion, historical volatility has ranged from a low of 6 percent to a high of about 15 percent over that same period. Hence, the current reading of 6 percent is at the absolute low end of the range. Given this information, it seems that strategies oriented toward *buying* options would be more prudent because volatility is currently low by both measures, historical and implied.

These were actual readings of OEX volatility, taken from February 1995, just before the market embarked on an upside explosion of historic proportions. Clearly, it was a good time to be buying volatility, not selling it.

---

This example demonstrates that knowing the previous range of volatility is much more important than merely comparing current values of implied and historical volatility. Using only the latter can lead to incorrect conclusions and losing trades. Moreover, since strategies in which you are selling volatility often involve the use of naked options, you should be extremely careful in your analyses before establishing positions.

An approach that works well is to represent the implied volatility data in percentiles. It is, thus, easy to speak about cheap or expensive options in this manner. To make it easier to scan a spectrum of implied volatility history, though, we use *deciles*. To break a set of data into deciles, if the current implied volatility is in the first or second decile, then option buying strategies may be appropriate, for implied volatility is near the low end of its range. Conversely, if implied volatility is currently in decile 9 or 10, then option selling strategies should be considered. Alternatively stated, if implied volatility is in the twentieth percentile or lower, then favor buying strategies; if it's in the eightieth percentile or higher, then selling strategies should be favored.

In addition, you would want some confirmation from historical volatility, using the same decile method. Historical volatility should be in the same decile or in a more favorable one: if implied volatility is in

decile 2 and you are considering option buying strategies, then you would want historical volatility to be in decile 2 or higher. On the other hand, if implied volatility is high (in decile 9 or 10), then you would want historical volatility to be in the same or in a lower decile in order for it to confirm the location of the implied volatility. Moreover, you should use several measures of historical volatility in these comparisons.

The following is an OEX example where volatility was low:

	Decile										
	1	2	3	4	5	6	7	8	9	10	
Implied	10.3>	11.4	11.8	12.3	13.0	13.7	14.5	15.3	16.0	16.7	17.7
10-day	4.3	5.2	6.2	6.6	7.0	7.7	8.6>	9.4	10.1	10.8	16.5
20-day	5.4	5.8	6.2	6.6	6.8	7.9>	8.6	9.1	9.8	11.1	12.9
50-day	6.3	6.6	7.2>	7.5	7.7	8.0	8.6	9.1	9.9	10.3	11.1
100-day	7.4>	7.7	7.8	8.0	8.5	8.9	8.9	8.9	9.0	9.1	9.1

The implied volatility numbers are the 20-day moving average of implieds. These go back one year, and there are about 250 trading days in a year. So there would be 231 20-day observations in that time period. The “>” character indicates that the current reading is in that decile (the first decile for implied, the seventh decile for the 10-day, and so forth).

The other four lines refer to historical volatility. There are four separate measures of historical. You can see that the 10-, 20-, and 50-day historical averages are all in higher deciles than the implied volatility is. The 100-day is in the same first decile as implied volatility.

Overall, this is an attractive picture of volatility for option buying strategies: implied volatility is at its lowest point, and historical volatility is more “normal” with the 10- and 20-day actually being in deciles slightly above average (the sixth and seventh deciles, respectively). Thus, if implied volatility were to return to the middle deciles as well, it would increase, and option buying strategies would benefit.

A similar situation holds for determining when implied volatility is too high. You would compare its percentile with the historical volatil-

ity's percentile. There is one exception about high implied volatility that should always be taken into consideration: very expensive options on a moderately volatile stock may signal an impending corporate news event such as a takeover or earnings surprise. A good rule of thumb is to only sell implied volatility if it is at the high end of a previously determined range. But should the volatility break out of that range and rise to new highs, you should probably be very cautious about selling it and should even consider removing existing positions.

---

We previously mentioned Federal Paperboard (FBO) as an example. It is a classic for demonstrating our point in this case. Traditionally, FBO options traded with implied volatilities ranging from the low 20 percents to about 40 percent. Not only that, but the price of the stock had behaved in such a manner as to make trading the volatility quite profitable.

Then, in October 1995, the stock ended a small correction at a price of about 35 and began to trade higher. Implied volatility rose above 40 to 41 percent on one day and 44 percent on another, before exploding to readings of 48, 54, 60, 81, and 89 percent over the next five days! This kind of increase in implied volatility above the normal trading range is a warning sign for sellers of volatility to stay away. By this time, the stock had increased in price to 42½—not much of a rise—so volatility sellers could have gotten out or adjusted at a small loss.

As it turned out, FBO was taken over the next week, and it jumped to about 53.

---

Thus, you should generally not engage in volatility selling strategies when the implied volatility exceeds the previous range, especially if the stock is on the rise. The one exception would be if a stock were dropping rapidly in price, and you felt that that was the reason for the increase in implied volatility. In this situation—as we saw in Chapter 4 with IBM and Telefonos de Mexico—covered writes or naked put sales can often be very effective.

As mentioned previously, free weekly volatility snapshots are presented on our web site, [www.optionstrategist.com](http://www.optionstrategist.com); and for a modest fee, subscribers of The Strategy Zone on our web site have access to daily volatility updates and implied volatility charts as well.

## TRADING IMPLIED VOLATILITY

So, now that we have outlined the scenarios under which we would buy or sell volatility, let's take a look at what strategies might be appropriate. In this section, we use elementary strategies. Later, we see how more advanced strategies can be used. Recall that as a volatility trader, we don't really want to have to predict where the price of the underlying is going to be. We merely want to predict where the volatility will be. In light of these facts, we normally establish a neutral position to begin with.

With simple strategies, we usually begin with a delta neutral position. We explore those in this section. Remember, though, that a delta neutral position can quickly turn into a position with price risk; so these strategies, while useful, may not be enough to keep us from having to get "involved" with the price movements by the underlying.

### Selling Volatility

When the implied volatility is "too high," the strategist wants to sell volatility, intending to capitalize when it returns to more normal levels. *When I want to sell volatility, I favor one of two strategies: (1) the sale of a naked strangle or (2) a ratio spread.* Since both strategies involve the sale of naked options, some traders prefer to purchase deeply out-of-the-money options as disaster protection. That may or may not be a good idea. On the one hand, it allows them to be worry-free about large gap openings; but on the other hand, it costs money. And if these traders have done their analysis correctly, they should be selling inflated volatility, not buying it. I also tend to keep the options relatively short-term in nature when selling volatility.

Before getting into the strategy of volatility trading, which is main focus of this chapter, let's spend just a minute on mechanics. You must have approval from your broker in order to sell naked options. Your broker will want a larger minimum equity in your account if you're going to sell naked options—\$20,000 at some firms and as much as \$100,000 at others. If you have that plus some trading

experience, you will probably be granted the broker's approval. However, you should also ascertain whether your personality is capable of handling a naked option strategy. The following are *my* three suitability criteria for naked option writing:

1. Do you have the personality to handle the risk?
2. Can you margin the position as it should properly be margined?
3. Do you have the trading experience to adhere to stops and the time to constantly monitor your positions?

Let's expand on these criteria. If you are going to lie awake at night worrying about what might happen to your naked options, then you cannot honestly answer yes to the first question. If you only have the margin available for the exchange minimum, then you can't answer yes to the second question (since margin requirements increase when the underlying makes an adverse move, you really have to have enough margin to handle a move all the way to your break-even point—where you would make an adjustment or close out your position). Finally, you don't have to have *option* trading experience, but you must be prepared to handle stops and monitor positions as if this were a full-time job. If you can't, then you can't answer yes to the third question. However, if you can answer yes to all three of these questions, then you are prepared to sell naked options.

In a naked strangle sale, an out-of-the-money call is sold, as well as an out-of-the-money put. I favor this over a straddle sale because of the wider price range of profitability that is attained.

Figure 6.1 compares the profit potential of a naked straddle sale with the sale of a naked strangle at expiration. Note that the straddle sale can make more money if the underlying is near the striking price at expiration, but that the strangle sale makes money over a wider range. Since you are often forced to make adjustments to naked positions when the underlying makes adverse price movements, the use of the strangle sale lessens the odds of having to adjust so often.

Before getting into an actual example, there is one other important concept that can be presented visually—the statistical advantage that the position presents. When you are selling high volatility, you

**Figure 6.1**  
**NAKED STRADDLE SALE VERSUS NAKED STRANGLE**

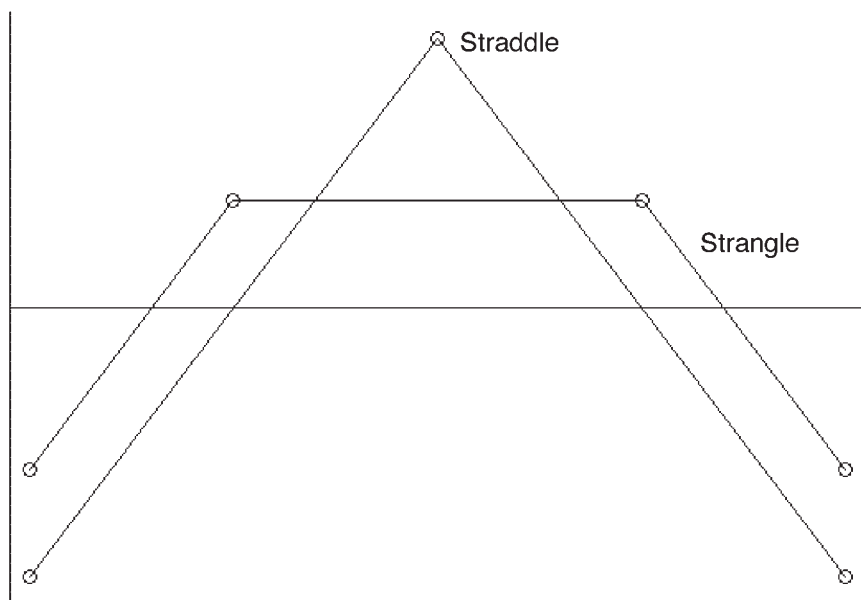

expect that volatility will return to more normal levels. In most cases, when this happens, you will make money, and you can then exit the position. This return to “normal” volatility may occur quickly, or it may take a while (or may never happen at all). The trader’s statistical “edge” is that he is selling inflated volatility; and his profit potential, as represented by that edge, is the amount of money that he could make if volatility returned to normal levels.

Figure 6.2 shows the general shape of a strangle sale, with two curved lines inside of it. The straight lines are where the profits or losses would lie if the position were carried all the way to expiration. The curved lines are profit projections if the position were held only halfway to expiration. The reason that there are two curved lines is that one represents the results with volatility remaining at high levels (the lower curved line), while the other depicts the results if volatility were to return to normal levels (the higher curved line).

You can see that there are profits under both curved lines if the underlying is near the center of the graph. Likewise, there can be

**Figure 6.2**  
**STRANGLE SALE**

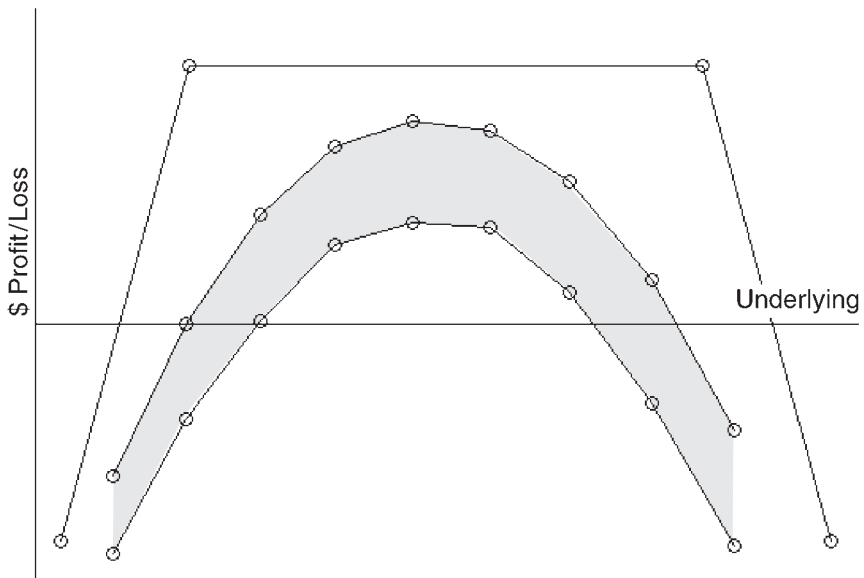

losses as well, as both curved lines penetrate below the zero profit line if the underlying rises or falls too far. What is most important, however, is that there is a definite space between the two curved lines—the shaded area on the graph. This shaded area is a picture of the statistical advantage that the seller of high implied volatility has; for if volatility returns to its normal level, he will profit by the amount of the shaded area.

A similar picture regarding the ratio spread strategy can be observed in Figure 6.3. It is the graph of a call ratio spread. Simplistically, a call ratio spread involves buying one call at a lower strike and selling more calls at a higher strike. Notice that the maximum profit area of all three scenarios—expiration, halfway to expiration with the same volatility, and halfway to expiration with decreased volatility—is at the higher striking price (i.e., the striking price of the short options in the spread). It is at that point where the statistical edge is the largest; the area between the two curved lines is widest at that point.

**Figure 6.3**  
**CALL RATIO SPREAD**

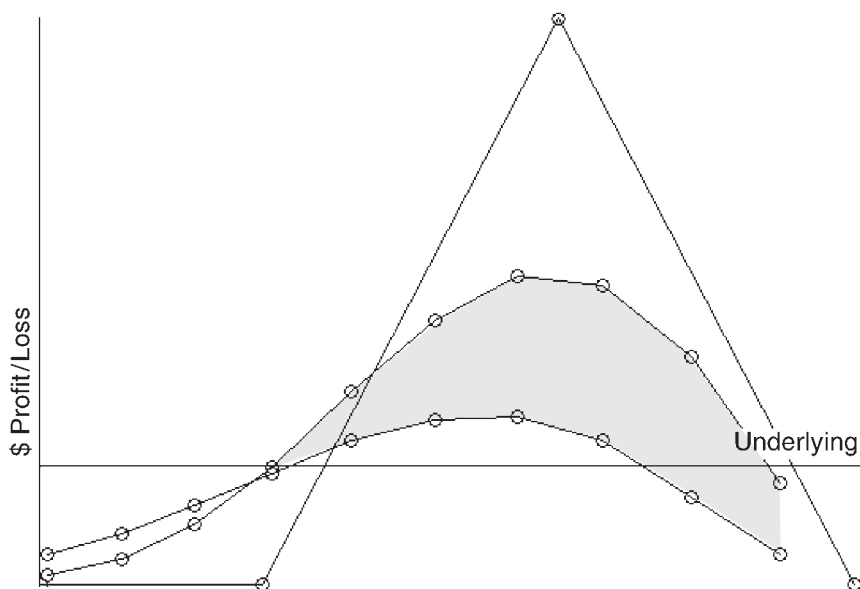

Now, having established the general theory of trading high implied volatility, some actual examples may prove to be beneficial. Admittedly, this first one is a favorable example; but it is one taken from real-life trading, and the decisions made at the time reflected the philosophies that we have discussed thus far.

---

The American Stock Exchange (AMEX) listed options on the Hong Kong Option Index (symbol: HKO) in 1993. The index was designed to perform similarly to the Hang Seng Index, the main market measure of the Hong Kong Stock Exchange.

The HKO is computed just once a day, before the opening of trading in the United States, as the actual Hong Kong market is closed at that time. Closing prices of the stocks used to compute the HKO are taken from actual closing prices in Hong Kong, converted to dollars. Thus, the HKO gaps *every* trading day. Think of it as akin to being able to trade the Dow Jones Industrial Averages only at night, where the only price you had to go from was each day's Dow closing price. This feature raises the implied volatility somewhat.



In late June 1994, the following situation existed with respect to the various implied and historical volatilities of the Hong Kong Option Index:

	Actual (%)	Decile
Implied volatility	34	10th
10-day historical	16	7th
20-day historical	18	7th
50-day historical	19	7th
100-day historical	21	8th

The previous range of the *implied* volatility of the HKO had been from about 21 percent to 38 percent. Thus, this situation fit both of the stated criteria: (1) implied volatility was significantly higher than historical volatility, and (2) the implied volatility was in the 10th decile, while historical volatilities were high, but not quite as high. What's more, an index is unlikely to acquire a sudden burst of volatility, as a stock might from an impending takeover offer.

The HKO itself was trading at about 180 at the time, and the July options, which were due to expire in three weeks, were trading at the following prices:

Date: June 23, 1994  
 HKO: 180.79  
 HKO July 190 call:  $1\frac{3}{4}$   
 HKO July 170 put: 2

The fact that short-term (three-week) options were available at reasonably large prices was another added benefit. The combination—an equal amount of July 190 calls and July 170 puts—was sold; and as it turned out, implied volatilities remained high throughout the fairly short life of the options, so there was never a return to “normal” volatility. However, the HKO never moved much in price, trading in a range between about 170 and 182 during the next three weeks. The combo expired worthless, and the maximum profit was attained.

---

Some additional commentary may be beneficial here. First, the naked combo was chosen as the vehicle of choice, because the HKO

had been trading in a range around 180 for several weeks prior to establishing this position. Therefore, a position with break-even points centered about the current price (180.79) seemed to be the best choice of a neutral position.

Second, when the HKO dropped to 170, the position had obviously become delta long. Should an adjustment have been made? That is a matter of conjecture, and I always feel it has to do with the size of the position itself. When using an elementary neutral strategy such as a short strangle, you are obviously going to have to assume some delta risk eventually (or else you will be making numerous adjustments, and commissions and bid-asked spreads will eat you alive). With these short-term strangles, I generally feel that I will leave them room to move and will remove them if (1) volatility drops and I have a profit equal to the statistical edge, as shown in the preceding chart, (2) they expire, or (3) they violate their break-even points.

Obviously, no one wants to take large losses—especially in a naked writing situation—so the third criterion is mandatory. Therefore, when the position was established, I was prepared to close out the strangle if HKO traded at 167 on the downside or at 193 on the upside. In either case, only a small loss would have resulted.

The preceding example can be continued because, in a way, no convergence had been reached between historical and implied volatilities. Notice that we said that implied volatility never returned to normal by the time expiration arrived. Therefore, the same situation essentially was available for the next expiration.

---

At July expiration, the situation had not changed much as far as the Hong Kong Option Index volatilities were concerned:

	Actual (%)	Decile
Implied volatility	33	10th
10-day historical	24	10th
20-day historical	22	9th
50-day historical	20	9th
100-day historical	21	8th

This was still an attractive situation, although perhaps not quite as attractive as in the previous example. Implied volatility was still at the top end of the range, which was good; but it wasn't that much higher than historical volatility when measured by the deciles. This could indicate that *all* the volatilities were embarking on a higher move. Still, it seemed attractive enough to repeat the strategy, using the following prices:

Date: July 15, 1994  
 HKO: 176.20  
 Aug 190 call:  $3\frac{1}{4}$   
 Aug 165 put: 2

You can see from these prices that the calls were more expensive than the puts, so a neutral position required the sale of five puts and three calls. Such a position took in a credit of  $(5 \times 2) + (3 \times 3\frac{1}{4}) = 19\frac{3}{4}$  points. This makes the break-even points 196.58 ( $190 + 19.75/3$ ) on the upside and 161.05 ( $165 - 19.75/5$ ) on the downside.

During the ensuing four weeks to expiration, the implied volatility once again failed to move below the ninth percentile, and HKO traded in a range from 176 up to about 194, before finishing at 188 at expiration. Since the break-even points weren't violated, no defensive action was taken, and the combo expired worthless once again.

At this point, I was admittedly feeling fairly fortunate to have had two consecutive strangles expire worthless. Even more so, considering the fact that the first one had seen the HKO mostly trade lower, even threatening the downside break-even point; then the second one had the opposite action—the HKO traded up and almost went through the upside break-even point. However, the fact that implied volatility was high when these positions were established made the break-even points sufficiently far away from the initial index price that it contributed to the eventual inability of the index to exceed those break-even points.

It surely seemed that this situation couldn't go on forever; but since the implied volatility was still high after even the second strangle expired worthless, it seemed worthwhile to attempt a third one.

After the second HKO combo expired worthless, the following situation existed at August 1994 expiration:

	Actual (%)	Decile
Implied volatility	31	10th
10-day historical	22	9th
20-day historical	21	9th
50-day historical	20	9th
100-day historical	21	8th

The following prices existed at the time:

Date: August 12, 1994  
 HKO: 189.85  
 Sep 205 call:  $1\frac{3}{4}$   
 Sep 175 put:  $2\frac{1}{4}$

The deltas of these two options were about the same, so this time the combo consisted of selling an equal amount of Sep 205 calls and Sep 175 puts. Over the next two weeks, HKO traded in a very tight range, between 188 and 193. This had the effect, finally, of causing the implied volatility to contract to 23 percent. At this time, the statistical advantage had finally been realized, and the strangles were covered.

Thus ended the profitable saga of the Hong Kong Index inflated volatility. Ironically, the volatility of the index did not return to the 10th decile for over a year and a half after the summer of 1994. Perhaps the market makers and other traders decided that the somewhat disconcerting gap-every-night feature of the HKO did not merit such a large implied volatility on a routine basis.

Selling volatility in this manner is somewhat nerve-racking because naked options are involved. There are always the disasters from naked option writing that you routinely read about and that we have recounted as well—takeovers, crashes, and so on—but with the guidelines that we have set forth, you should be able to avoid those. For example, implied volatility was actually very *low* just before the crash; thus, by our “rule” of requiring it to be in the 9th or 10th decile, you wouldn’t have sold it. Also, as was described earlier, implied volatility usually skyrockets before a takeover; so if implied volatility suddenly blasts much higher than the previous 10th decile readings, you shouldn’t sell that volatility either. Rather, with these

guidelines, losses would generally be more modest, but that doesn't mean that they don't occur. Lest you think that selling naked options when implied volatility reaches the 10th decile is a lock, the following example is provided.

---

Also in the summer of 1994, UAL Corp's (UAL) options had reached expensive levels, by all measurements.

	Actual (%)	Decile
Implied volatility	36	10th
10-day historical	28	8th
20-day historical	26	7th
50-day historical	28	7th
100-day historical	25	6th

Thus, implied volatility was not only higher than historical volatility in absolute terms, but it was in a higher decile as well. Note that the *absolute* differential in volatilities is not as large here as it was in the HKO examples, but a 36 percent implied versus historicals in the 25–28 percent range is still a significant difference.

The pertinent prices at the time were:

Date: June 10, 1994  
 UAL: 116  
 UAL July 125 call:  $1\frac{3}{4}$   
 UAL July 110 put:  $2\frac{1}{2}$

The deltas of these two options were about equal, so an equal number of puts and calls were sold naked. The break-even points were  $129\frac{1}{4}$  on the upside and  $105\frac{3}{4}$  on the downside. In line with the philosophy stated earlier, the position was to be given room to “roam” until it hit the break-even points. With about five weeks until expiration, this seemed like a reasonable amount of room—about 14 points on the upside and 11 points on the downside.

This position didn't have the good fortune of the Hong Kong Index puts. UAL immediately started to move higher and closed at 130 on July 1. At that time, July 125 calls were offered at  $5\frac{3}{4}$  and were covered. The puts were trading at a small fraction and were covered as well.

Moreover, implied volatility had fallen to 23 percent, so it was no longer expensive. Thus, no other position was established in UAL.

---

The preceding example shows how using the simple neutral position was insufficient to capture the intended volatility decline. In fact, volatility *did* decline—from 34 percent to 23 percent—and that was what we were trying to predict. Unfortunately, with such a simple neutral position, we were left too exposed to price movement by UAL. That price movement overrode the benefits of declining volatility, and the overall position became a loss. It is for reasons such as this that a more sophisticated approach is generally necessary in order to isolate volatility as the important variable. However, for the time being, we want to continue with the simpler strategies so that we can further lay the groundwork for the more complex material later.

## Buying Volatility

The strategist who is attempting to trade volatility will buy it when it is “too low.” In such cases, there are three applicable strategies: (1) long straddles, (2) backspreads, or (3) calendar spreads. Note that the first two simple strategies are merely the opposites of the ones used for selling volatility. The introduction of this third strategy, the calendar spread, into the mix gives us a slightly wider range of alternatives.

The simple strategy for selling volatility discussed earlier was somewhat heavily dependent on price movement of the underlying, which was a negative, and time decay, which was a positive. As might be expected, the first two strategies for buying volatility—long straddles and backspreads—are affected in the opposite way: extreme price movement by the underlying is beneficial to these strategies, while time decay is an enemy. The ability to use calendar spreads for buying volatility gives the strategist an important alternative: time decay once again becomes a positive factor. The following graphs show these strategies’ profitability, both at expiration and at the perhaps more important earlier times.

Figure 6.4 is a graph of owning a straddle. If I am going to use this strategy for buying volatility, I prefer to buy the straddle (both the

**Figure 6.4**  
**STRADDLE BUY**

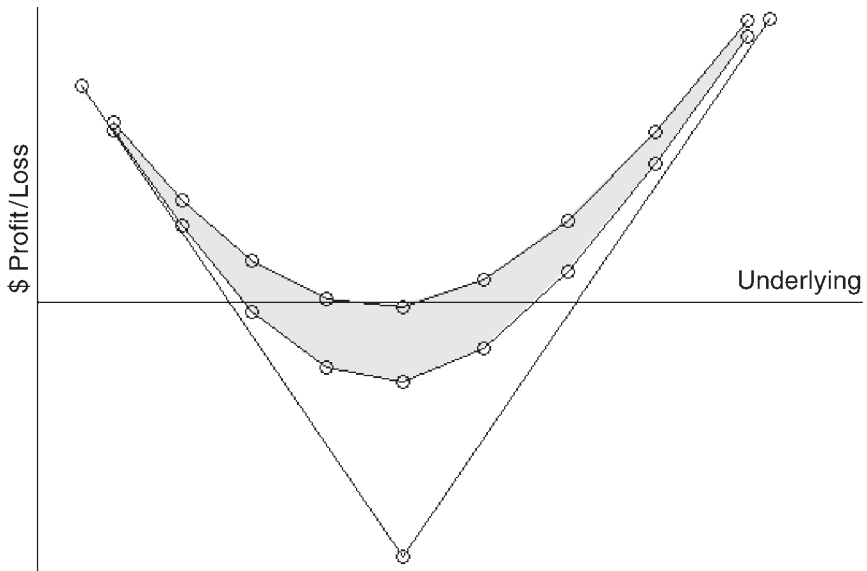

put and the call have the same strike, which is initially quite near the price of the underlying) rather than buying a strangle (out-of-the-money put and out-of-the-money call). The curved lines on the graph depict the same sort of things that we saw in the last section: they are the profits or losses halfway to expiration. If volatility remains low, then the profitability will fall on the lower curved line; however, if volatility increases, then profits will be on the higher curved line. The space between the two of them is the amount of profit that can be attributed to volatility returning to “normal” levels.

Trading long straddles can be a somewhat depressing occupation because of the constant drag of time decay on the position. However, if volatility *does* explode or if the price explodes, profits come quickly and can be quite large. The position needs to be handled in a way that is significantly different from the short strangle strategy that was previously discussed. For one thing, when you are *long* the straddle, if the stock reaches your break-even point, you are most likely only just beginning to make money. Therefore, you must hold

onto the position—even though it is in no way delta neutral any longer—if you expect to maximize profits. Another thing that is important is to decide when to take losses. The following examples, again from actual trades, address these points.

---

In late September 1995, retail stocks were beginning to come under some pressure. They had had a strong run in the bull market of that year but had peaked out in late July. There is a sector index that is composed of the retail stocks, and it trades with the symbol \$RLX. The index had peaked out at 342 that summer and had pulled back slightly to 330 by September. At the time, the pertinent volatilities were:

	Actual (%)	Decile
Implied volatility	12	1st
10-day historical	10	2nd
20-day historical	9	1st
50-day historical	10	1st
100-day historical	13	4th

It is fairly obvious from this data that the Retail Index was at a low ebb, both in implied and in historical volatility. The fact that the 100-day historical volatility was somewhat higher was evidence that the index had been more volatile in the past.

With the index near 330, the December 330 straddle was purchased for 15 points.

---

There are two ways that a straddle owner can make money: (1) if the implied volatility increases or (2) if the underlying rises or falls far enough in price. The first condition will boost the price of any straddle, whether it be a short-term one or a longer-term one. However, if volatility remains at low levels, the straddle purchase relies on price movement by the underlying in order to make money. You will find that at low-volatility conditions the underlying needs to move nearly all the way to the break-even point in order for the straddle to become profitable.

I usually attempt to buy straddles with about three or four months of time remaining when I am buying volatility. This length of time is



selected for two reasons. First, the time decay isn't too rapid for a three-month straddle, although time will definitely be working against the straddle owner to a certain extent. Second, the straddle has a good chance to respond if the underlying rises or falls by a reasonable distance. If you go too far out in time, you will be paying too much time value and may find that it is too difficult to make money from price movement by the underlying; you will be overly relying on a volatility increase.

---

Continuing with the previous example, the retail stocks began to announce poor earnings and earnings forecasts shortly after the straddle was purchased, and the Retail Index fell to 319 in just about two weeks. However, the straddle was still selling for about 15 because implied volatility had only picked up modestly—to 13 percent—and with the put being the in-the-money option, there wasn't much time value premium in the straddle's price.

---

Options lose time value premium as they become in-the-money options, and in-the-money puts lose their time value faster than in-the-money calls do. This is a fairly typical occurrence, and not a totally unpleasant one: the underlying moves toward the break-even point, but the straddle price doesn't really respond much because volatility remains at low levels. With the underlying near one of the break-even points, a long straddle position is by no means delta neutral.

When that occurs, the straddle owner, who, it must be remembered, is really a volatility buyer, must make a decision. He could (1) close out the straddle, (2) readjust it so it becomes delta neutral once more, or (3) go with the flow and try to ride the existing trend. This is not an easy choice, but some guidelines can be given. If volatility has increased, the first choice—to close the straddle—is probably appropriate. The second choice—readjusting—would be more appropriate if the implied and historical volatilities are still in the first or second percentile; that is not normally the case after the underlying has moved far enough to reach a break-even point. In essence, I only favor the adjustment choice if the position is one that I would initialize if I had no position at all. The third choice—riding the trend—might be appropriate if volatility is still at low levels and if there is a good technical reason to expect that the trend in prices will continue.

In this same example, after the drop to 319, this Retail Index straddle was quite delta short, as the Dec 330 put had a large negative delta, being 11 points in-the-money, while the Dec 330 call didn't have much of a delta at all, since it was out-of-the-money by an equal amount. Implied volatility had risen only slightly to 13 percent, so the first choice—closing the position—wasn't overwhelmingly the best choice.

In order to assess the second choice—readjusting—it was necessary to compare the implied and historical volatilities once again. The overall volatility picture at this time had become the following:

	Actual (%)	Decile
Implied volatility	13	2nd
10-day historical	13	4th
20-day historical	11	3rd
50-day historical	11	2nd
100-day historical	12	3rd

This is a picture of low volatilities, but not extremely low ones. I would not normally initiate a position with this volatility picture, so readjusting was therefore not attractive.

The third choice—riding the trend—is sometimes the most risky choice, but it can produce the best profits as well. Figure 6.5 shows the Retail Index at the time it had reached the 319 level in early October. There was previous support there from the bottom that had been made on September 1. However, should that support give way, it appeared that a much larger drop was possible.

Therefore, I decided to ride the trend, figuring that if I was wrong and RLX rallied instead, I could remove the straddle without too much harm, since volatilities might still increase. As it turned out, the support *did* give way, and the index collapsed to 297. By this time, I was using a trailing stop and closed the position out on a reflex rally to 304. Thus, the straddle that was purchased for 15 was sold for 27½ (the calls were sold for 1½ on the day the index broke the 319 support level, and the puts were sold via the trailing stop). This entire scenario occurred by November 2, so it did not take long to unfold.

Once you have decided on the “go with the flow” choice, you should sell out the unprofitable half of the straddle as soon as the

**Figure 6.5**  
**RETAIL INDEX (RLX)**

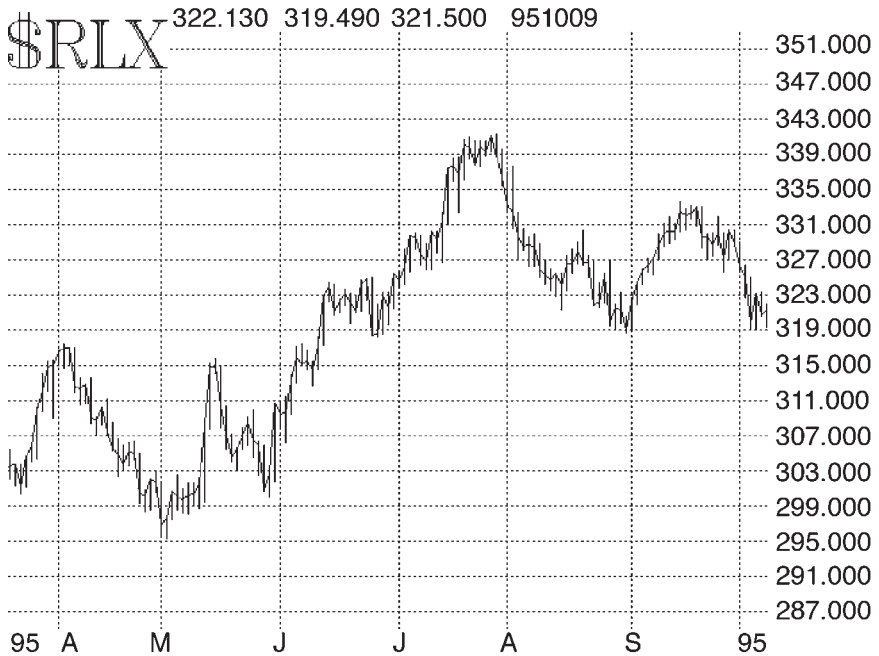

trend is technically confirmed. In the preceding example, that came with the breaking of support at the 319 level, when the calls were sold for  $1\frac{1}{2}$ . Ironically, the Retail Index rallied all the way back to 328 in late November, so the calls could probably have been sold for more. However, in most cases, when a technical level is broken and you have decided to ride the trend, you should sell out the losing side, for it is probably headed toward zero.

Handling losing straddle positions is actually a much easier proposition. All you have to do is set a mental stop in terms of the straddle price and adhere to it. If the straddle declines in price to your stop, you take your loss. After that, you may want to reestablish a new, longer-term straddle on the same underlying security, although in many cases, it may not be as attractive as the initial straddle was.

---

We mentioned earlier that the volatility of gold declined to previously unheard of levels in 1994 and 1995. The decline in volatility began in late 1993, from levels around 20 percent, and had reached low levels by June 1994. At the time, the following statistics regarding volatility were observed:

	Actual (%)	Decile
Implied volatility	10.7	1st
10-day historical	6.0	1st
20-day historical	6.4	1st
50-day historical	10.0	1st
100-day historical	11.3	2nd

With deciles like that, the straddles seemed like a very attractive purchase. So the Dec 390 straddles were purchased (Dec gold was trading at 391 at the time) at a price of 18. These straddles had about 4½ months of life at the time, so that is why they were chosen.

I usually use a stop loss of about 40 percent to 50 percent of the value of the straddle, so I set a mental stop at a price of 10 for this long straddle. If the straddle settled at 10 or less on any trading day, the straddle would be sold.

As it turned out, gold remained in a tight range and volatilities fell even farther. Gold traded between 380 and 400, never enough price movement to even approach the break-even points of 372 on the downside and 408 on the upside. To make matters worse, implied volatility continued to fall as well. Finally, by early October, the straddle had fallen to 10, and it was sold and the loss was taken.

---

When you take a loss on a long straddle position, you are usually feeling somewhat frustrated, especially if you did your homework correctly and bought the straddle when volatility was extremely low. Your initial reaction is usually to delve into another straddle on the same underlying security, figuring that *this time*, the volatility will have to increase. This may be an emotional decision. To remove the emotion, you should analyze the volatility comparison and demand the same or better volatility picture before repeating the position.

---

Shortly after taking the loss on the preceding gold straddle, with April gold near the 390 level and volatilities all in the 1st deciles (albeit at lower actual

levels than shown in the previous example), the April 390 straddle was bought for a price of 11. This one had just over four months of life remaining. Note the lower absolute price of the straddle, reflecting the diminished implied volatility.

Without getting overly involved in the details, this time things worked better, as gold immediately fell below 380, the technical support level that had been established earlier that summer.

Even if the second straddle purchase had been a loser as well, it was still well-founded on the basis of low implied volatility. I don't think you can repeat such purchases over and over if losses continue to occur and implied volatility continues to decline. For example, the implied volatility of gold continued to drift lower into 1995 and then remained at very low levels before finally beginning to climb in early 1996. Our philosophy of trading volatility was based on identifying the *range* of past volatilities; implicit in that philosophy is that volatility is going to *remain* within that range. When it breaks outside of the previous range, you should probably avoid positions in that security until you are confident that a new and relatively stable range has been identified. As a result, no further gold straddles were bought during the subsequent decline in volatility.

The second strategy that we described for buying volatility is the backspread. Figure 6.6 is that of a call backspread—selling one in-the-money call and buying two at-the-money calls, for example. You can see by the straight lines on the graph that the call backspread is very similar to the long straddle, except that the profit potential is truncated on the downside. The curved lines show the profit potential halfway to expiration. The higher curved line is the projected profit if implied volatility increases—returning to normal levels. The lower one is the profit if implied volatility remains where it was initially. The space between the two lines graphically represents the statistical advantage that can be had by capturing the volatility if it should increase to previously normal levels.

As you can see from the graph, the call backspread has unlimited profit potential to the upside. A put backspread, however, has unlimited *downside* profit potential. In either case, the maximum loss of the backspread is *less* than that of a corresponding long straddle

**Figure 6.6**  
**CALL BACKSPREAD**

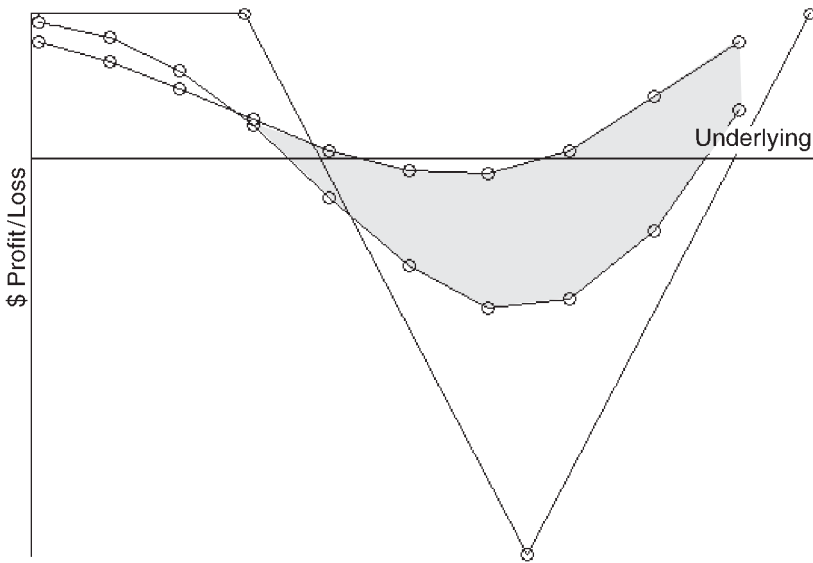

because of the profit potential that is forsaken on one side of the backspread.

You might utilize a backspread instead of a long straddle if you think the particular market is more likely to move in one direction or the other. But the neutral strategist is not normally interested in price projection initially. Rather, the strategist would use the backspread when the implied volatilities of the *individual* options in the spread differ. This situation is called *volatility skewing* and is addressed later in this chapter, so examples of backspread positions will be deferred until that time.

The calendar spread is a strategy that benefits from increased implied volatility, but not from volatility of actual prices. A calendar spread involves buying a midterm option and selling a shorter-term option, both with the same striking price. A strategist will normally treat the calendar spread as just that—a spread—and remove it when the near-term option expires. Holding onto the longer-term option

after the shorter-term one expires makes you a speculator instead of a spreader.

Figure 6.7 shows the profitability of a calendar spread at expiration of the near-term option. Notice that the maximum profit potential is realized if the underlying's price is right at the striking price. If the underlying moves too far away from the strike in either direction, then losses will occur. However, losses are limited to the initial debit spent for the spread. There are two curves on the graph—the higher one shows what would happen if volatility increased, while the lower one shows profits if volatility remains low. The space between the two is, once again, the statistical edge attributable to an increase in volatility.

Most option traders are familiar with calendar spreads, but they don't often think of them as being so affected by volatility. As a result, novice traders often establish calendar spreads when volatility is high because the spread seems attractive, when, in fact, it is not. Ordinarily, we use examples to show how to use a strategy, but the

**Figure 6.7**  
**CALL CALENDAR SPREAD**

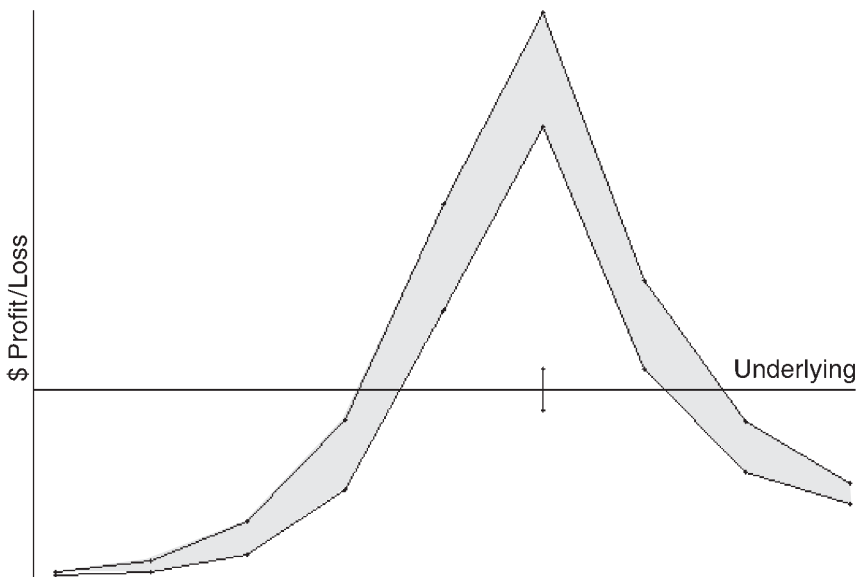

following is an example of how not to use one. The reason that we are including it is because of the propensity of people to use calendar spreads when they shouldn't, that is, when implied volatility is high. This is a theoretical example using actual prices.

---

*Example:* In the late summer and fall of 1994, Quaker Oats (OAT) was a rumored takeover for several months. The stock's price had risen from 60 to the 75-to-80 area, and the implied volatility had risen even more: from 20 percent to extremely high levels, ranging up to and even above 60 percent.

When implied volatility increases by this much, it distorts the option prices so that the near-term option seems ridiculously expensive in comparison to the longer-term options. In the first week of October, the following prices existed:

**OAT Common: 75**

	Price	Implied Volatility (%)
Nov 75 call	6½	60
Dec 75 call	8⅛	57

A calendar spread—buying the Dec 75 call and selling the Nov 75 call—could be established for a seemingly low debit of 1⅝. This calendar spread looks extremely attractive. The near-term November option is selling for a whopping 80 percent of the price of the December option, when both are at-the-money. You don't see that situation too often. Moreover, the November call has a slightly higher implied volatility than does the December call, so a calendar spread would have a slight theoretical edge in terms of the implied volatility, also.

Furthermore, using a pricing model, you are able to determine that if the December option holds its 57 percent implied volatility, then the spread will make a profit if OAT is anywhere between 67 and 85 at November expiration (about six weeks away)—a very wide range.

All of those things are true, as far as they go. What has not been investigated is what a contraction in volatility would do to the spread. In fact, it would have a devastating effect. Nothing could prove this more conclusively than what actually happened in real life: on November 9, Quaker Oats indicated that it would buy Snapple, thereby quashing takeover rumors (most rumored suitors would not be interested in a money-losing venture like Snapple). The stock only dropped about 10 percent—to 67



percent—but the implied volatility collapsed to 37 percent. The prices then looked like this:

**OAT Common: 67**

	Price	Implied Volatility (%)
Nov 75 call	$\frac{1}{16}$	n/a
Dec 75 call	$\frac{7}{8}$	37

By expiration day itself (November 18), the common had fallen to 65, and the Dec 75 call was trading at a mere half point.

Thus, the calendar spread, which was purchased for  $1\frac{5}{8}$ , was a large percentage loser after volatility collapsed.

---

This example shows the importance of factoring volatility into your decision when trading calendar spreads. When volatility is already pumped up, as in the Quaker Oats example, it is a potential roadblock to profits for the calendar spread. At the end of this chapter, we present an aggressive strategy for using calendar spreads in inflated volatility situations; but statistically speaking, you should avoid the strategy when implied volatility is too high. It is more advantageous to use the calendar spread strategy when implied volatility is low, thereby reducing the possibility for decreasing volatility to harm the spread and enhancing the probability that increasing volatility will help the spread.

Overall, when trading volatility, the five delta neutral strategies just discussed are generally the preferred ones that you would want to use. To summarize, if you are selling volatility, the two appropriate strategies are the ratio spread (which could be established with either puts or calls) and the naked short combo. If you are buying volatility, backspreads (with either puts or calls), long straddles, or calendar spreads are germane. In addition, the spread strategies—ratio spread, backspread, and calendar spread—may be best utilized when there is a skew in the options implied volatilities. For example, if the near-term options are trading with clearly higher implied volatility

than the intermediate-term or longer-term options, then a calendar spread may be preferable (again assuming that the percentile of implied volatility is not too high). Also, it is sometimes the case that options with lower striking prices have higher implied volatilities than options with higher striking prices. In that case, a put ratio spread (if implied volatility is high, in general) or a call backspread (if implied volatility is low) might be attractive.

## THE “GREEKS”

The preceding strategies and examples show the attractiveness of attempting to trade volatility, as opposed to predicting prices. However, since they are such simple strategies, you are often forced to form opinions on prices as the strategies evolve. It is now time to discuss ways in which you can more easily isolate volatility and rely less heavily on price in your strategies.

In order to do that, we must approach things in a more theoretical manner. Thus, this section may seem a little complicated. However, the concepts are not all that difficult. I’ve often said that statistics on Wall Street is treated like rocket science—math that an undergraduate college math major would routinely understand is imbued with Einstein-like qualities by many traders. Moreover, many traders feel that if the computer says it’s so, then it must be the absolute truth. You must not be so awed by what we are about to present. It’s not the Holy Grail, nor is it the absolute secret to success. If it were, everybody would be using it. However, it is a step above what you normally see in terms of option strategies and could lead you to more consistent, less risky, investments.

In order to isolate volatility, we need to understand how to isolate *each* of the variables that affect an option’s price. Earlier in this chapter, we defined the names of the terms that describe the measure of exposure of an option or a portfolio for each variable that affects the option price. Since these exposure measures have Greek (or Greek-sounding) names, we refer to them collectively as “the Greeks.”

<i>Variable Affecting Option Price</i>	<i>Measure of Exposure</i>
Underlying price	Delta
Time to expiration	Theta
Short-term interest rates	Rho
Volatility	Vega

In addition, we also stated that “gamma,” which is the measure of exposure of “delta,” is also observed by sophisticated traders who use this approach to neutral trading.

## **The Model**

The basis for calculating all of the preceding measures, as well as for calculating implied volatility and also the theoretical value of an option, is the option model. There are several models that are available to the general public: their formulas have been published and are in the public domain. The earliest and simplest of these was the Black–Scholes model, derived in 1973 by two professors. Since then, many others have attempted to make adjustments and improvements, and many of them purport to give more accurate answers to the question of theoretical value.

One of the more popular alternatives is the Binomial model (the formula for the model and some examples are given in Appendix C). It involves a lot more calculations than the Black–Scholes model; but in today’s world of very fast computers, those calculations can be done rather quickly, although not nearly as quickly as the few calculations required for the Black–Scholes model. What’s ironic is that after all these “improvements” over the years, the newer models rarely give “answers”—that is, option values—that differ from the results of the Black–Scholes model by more than a few pennies. In essence, the difference between the results of the Black–Scholes model and the Binomial model is less than the bid–asked spread between the option in the marketplace. Consequently, we see no reason to get more complicated than the Black–Scholes model, especially for a commission-paying, non–market maker.

It is necessary to have a model, because "the Greeks" cannot be computed without one. Recall that the model is a function that is based on the five variables that control the price of an option (stock price, striking price, time remaining, volatility, and interest rates). Of these five, only the striking price never changes for an individual option. The others all change as the market trades, day after day. The Greeks measure the effect of one variable if all the others remain constant. To conceptualize what the Greeks actually are, a simple example may suffice.

---

*Example:* Suppose that we are attempting to evaluate an option where the following data apply:

Stock price: 50  
 Strike price: 55  
 Time remaining: 3 months  
 Volatility: 25%  
 Interest rate: 6%

Under these assumptions, the Black–Scholes model returns a theoretical value of 1.02. Now suppose that we keep all the data the same, except that we recompute the theoretical value with the stock price set to 51. These, then, are the new assumptions:

Stock price: 51  
 Strike price: 55  
 Time remaining: 3 months  
 Volatility: 25%  
 Interest rate: 6%

With this set of variables, the Black–Scholes model yields a theoretical value of 1.33.

What we have just done here is calculate the delta of this option. The theoretical value of this option increased by 31 cents when the stock price increased by one point, with all other variables remaining the same. Thus, the delta is 0.31.

In reality, there is a mathematical equation for computing delta. That equation specifies that the delta of this option is 0.28 when the stock is 50

and is 0.34 when the stock is 51. Thus, the first (less theoretical) method yielded a result that was the average of the two mathematically computed deltas. This example also points out that the delta changes all the time, even as the stock is moving only one point. In any case, you can see that the two ways of computing delta yield very similar results.

---

You can extrapolate from the preceding example that a Greek is computed by changing one of the four variables that are subject to fluctuation during any trading day, while leaving the others unchanged. In this manner, you can measure the isolated effect of the change in any one variable on the price of an option. Almost all option software programs give you all of the Greeks for any option. Mathematically, each of the Greeks is the partial derivative of the model with respect to one of the four variables. Don't worry if you don't know what a partial derivative is. As a strategist, you only need to know how to interpret the results of the mathematics, not how to compute the math itself. This is important information, for we can use it to establish positions that are neutral with respect to any or several of the variables. However, before getting into position analysis, let's describe the Greek terms themselves.

## **Delta**

As you should know by now, the delta of an option is a measure of how much the option changes in price when the underlying changes in price by one point. The delta of a call is a positive number, ranging between 0 and 1; the delta of a put is a negative number, ranging between -1 and 0.

The delta of an option has been discussed somewhat already, both earlier in this chapter and in Chapter 1. In the context of the previous example, suppose that in addition to allowing the stock price to increase by one point, we allowed the other three variables—time remaining, volatility, and interest rate—to change as well. The theoretical value of the option will certainly change, but how much of it is attributable to the change in stock price? It's difficult to say, but it is obvious that these other variables affect the delta, too.

Figure 6.8 shows the relationship of delta and time. Note that the option with a lot of time remaining has a delta that changes rather moderately as the underlying moves from far out-of-the-money (left-hand side of graph) to far in-the-money (right-hand side of graph). However, for a short-term option, the change is much more dramatic, as the call delta rises to nearly 1.00 rather quickly when the option is in-the-money (right-hand side; higher line on graph), and the delta falls to nearly zero rather quickly when the option is out-of-the-money (left-hand side; lower line on graph).

In February 1995, just a few days before February expiration, Motorola announced a slowdown in sales of cellular telephones, their most important product. The stock fell over six points, from 64 to 58, and was down even more intraday. This came one day before expiration of the February options.

Holders of out-of-the-money puts registered varying degrees of success, but nothing shows it more dramatically than the comparison of the Feb 55 puts and the March 55 puts. On the day before the announcement, with the

**Figure 6.8**  
**COMPARISON OF DELTA AND TIME REMAINING**

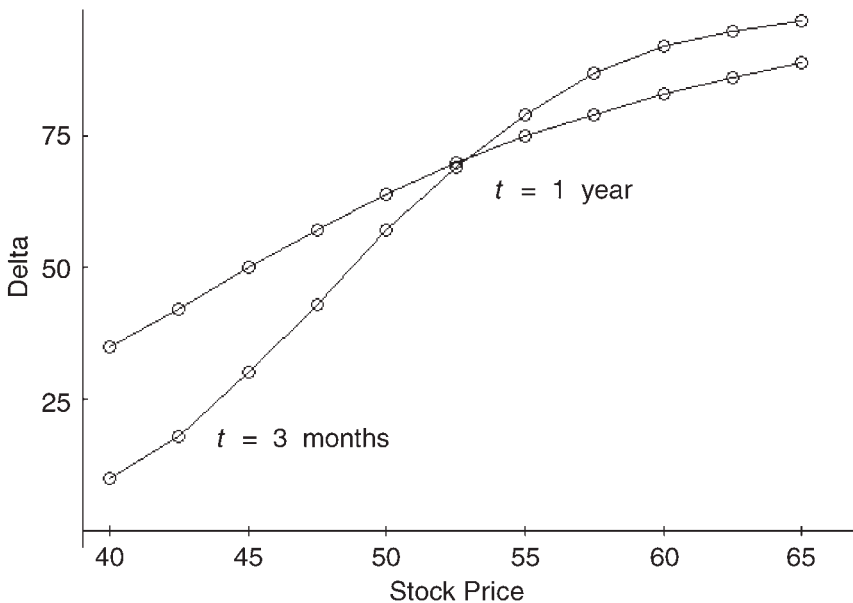

stock trading at 64 (up two points that day, by the way), both of these puts were trading at  $\frac{1}{16}$  of a dollar—the minimum value. When the stock dropped (dramatically) the next day, the Feb 55 puts never budged; they *still* traded at  $\frac{1}{16}$ . However, the March 55 puts jumped to a dollar, rising almost a full point.

Perhaps more vividly displaying the message, the January (1997) 50 LEAPS put, which had almost two years of life remaining at the time but which was five points farther out of the money, outdid both of these other puts, rising by  $1\frac{1}{2}$  points. Thus, the power of time as an effect on the amount an option can move is dramatically shown by this actual example.

The big move by the stock affected the option's deltas as well: the Feb 55 put had a delta of 0.00 before the drop and still had a delta of 0.00 after it, thereby confirming the fact that the delta of a short-term out-of-the-money option doesn't change much when the stock moves (even this far). The March 55 put's delta went from  $-0.01$  before the stock dropped to  $-0.16$  after, an increase of 0.15. However, the longer-term option, even though it changed more in price, had a smaller change in delta, as its delta went from  $-0.13$  to  $-0.23$ , a change of only 0.10. These facts are summarized in the following table:

	Original Delta	Price Change	Resulting Delta
Stock		-6	
Feb 55 put	-0.00	0	-0.00
March 55 put	-0.01	+1	-0.16
Jan (1997) 50 put	-0.13	+ $1\frac{1}{2}$	-0.23

We mentioned earlier that the delta of an at-the-money option is *not* exactly one-half (0.50). Rather, it is something larger. Even more interesting is the fact that the delta of this at-the-money call changes as time passes. Figure 6.9 is a chart of the call's delta and shows this quite clearly. A put would show a similar change; but the put's delta would be going in the opposite direction, changing from something like  $-0.43$  to nearly  $-0.50$  as time passed (remember that the put's delta is the call's delta minus one). Consequently, the at-the-money put becomes a little *more* responsive to price changes by the underlying as expiration approaches, while the call becomes slightly less responsive. However, the magnitude of difference is small in either case.

**Figure 6.9**  
**DELTA OF AT-THE-MONEY OPTION AS TIME PASSES**

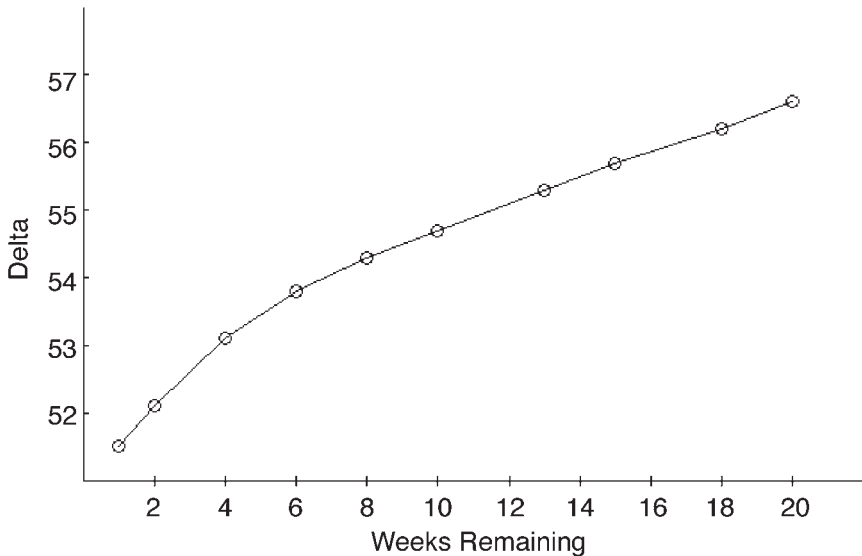

We have already seen that the price movement of the underlying security makes the delta change, and it has also been shown that the passage of time changes the delta. The third major influence on a call's delta is *volatility*. Remember that there are two types of volatility, implied and historical. Historical volatility is the measure of how fast the underlying instrument has been changing in price; implied volatility is the volatility that is currently being displayed by the options—a sort of projection of future volatility. Either one can affect the delta of an option, although it is *implied* volatility that usually has the more dramatic, short-term effect.

The options on a low-volatility stock have only a small amount of time premium. Thus, out-of-the-money options are not so responsive to short-term stock movements, and in-the-money options are very responsive. This means that the delta of out-of-the-money options on a low-volatility stock are small—perhaps near zero—and that the delta of a corresponding in-the-money option is large. The graph in Figure 6.10 shows this fact. This is somewhat similar to the way options with only a short life remaining behave, as discussed earlier.



**Figure 6.10**  
**COMPARISON OF DELTA AND VOLATILITY**

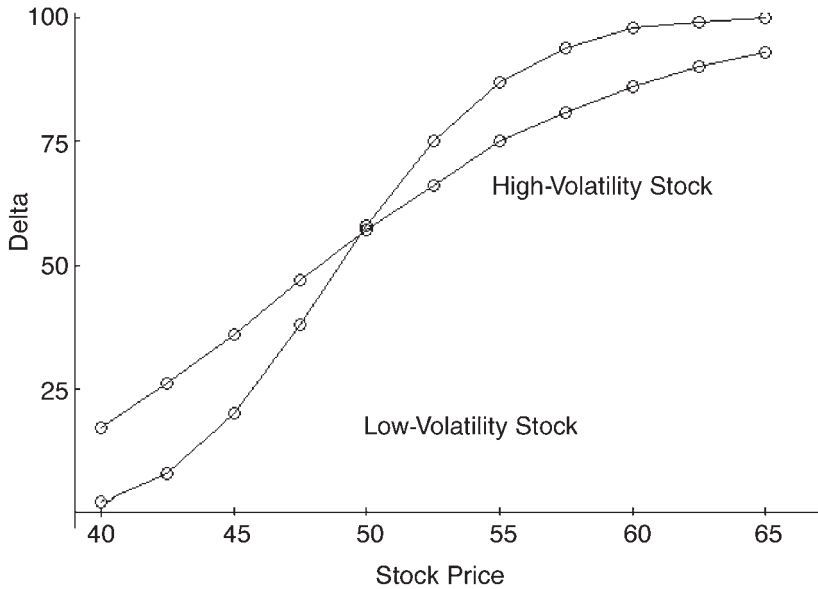

On the other hand, if the underlying is *very* volatile, then its out-of-the-money options will be more responsive to changes in the price of the underlying security; and its in-the-money options, since they have time value premium, won't be able to move complete point for point with the underlying. This is also shown in Figure 6.10 and is similar in nature to the behavior of a longer-term option.

Implied volatility can change very quickly; that is, the market's perception of *future* volatility can change overnight. The following example shows how this happens.

---

In 1994, Gensia Pharmaceuticals, a fledgling drug company, was a typical high-volatility stock. Its normal volatility was about 70 percent annually, which is quite large (the market as a whole is typically about 15 percent). In July 1994, the Food and Drug Administration (FDA) announced that it was going to hold hearings on the Gensia's main drug. The stock slipped from a price of about 10 to 8 and then slowly climbed back to 10 over the next month; so the stock was actually *not* volatile, but the options were. The

implied volatility of the options immediately jumped dramatically and was up in the 130 percent to 140 percent area. This was because traders knew that the FDA’s ruling would either “make or break” this company. Eventually, in October, the FDA ruled against Gensia, and the stock fell 50 percent in price overnight. However, once that was over, the implied volatility changed overnight from 130 percent back to 70 percent, as traders no longer needed to discount such a volatile event as the FDA ruling in the company’s future.

---

Implied volatility can experience these sudden jumps for a variety of reasons. One is a major corporate announcement, such as the FDA ruling in this example or as in the lawsuit example that was given earlier. However, another reason for implied volatility to increase dramatically is a *perceived* change in the future price of the underlying. For stocks, this usually means a takeover rumor; for grain futures, it might often mean expectations of bad weather. When these situations occur, there is not such a well-defined reason for the change in volatility (as an FDA ruling, for example). Instead option traders may often find their options changing in price quite dramatically, even though there is no apparent news to account for it and there is no particular price movement by the underlying security either. In essence, the delta of the option is changing dramatically. We can envision this scenario by looking at the previous graph and thinking of an option’s delta lying along one line on the graph and suddenly moving to the other line, without the stock price changing at all.

It is important for the strategist to understand these concepts, so he will also understand that any “neutral” position is not risk-free; it is only neutral with respect to the variable(s) that have been neutralized initially. Subsequent changes in the other variables will adversely affect the neutrality. We saw this in examples regarding delta earlier in this chapter, where an initially delta neutral position became quite nonneutral when the underlying stock price changed.

## **Vega**

This is the nomenclature given to the Greek term that describes how a change in volatility affects the price of an option (again assuming

that all other variables remain the same). Since the volatility that we are speaking of here is strictly the volatility that we are plugging into our valuation model, we are really talking about implied volatility. Vega is probably not a familiar term to most option traders, but it should be, for nothing affects the price of an option so dramatically as the volatility. In fact, as has been demonstrated several times in this book, a change in implied volatility can have a large short-term affect on the price of an option.

Since the subject of the chapter is volatility trading, we will be talking about vega a good deal in succeeding sections. For if we can measure the effect that a change in volatility has on a position, then we will know how much risk we are taking when trading volatility.

---

*Example:* Suppose, as we did earlier in this chapter, that we observe that the volatility of a certain security trades in a range between 20 percent and 34 percent. Furthermore, suppose that volatility is currently 32 percent, and we are considering selling the volatility.

Assume that we establish a position that has a position vega of  $-5.00$ ; that is, for each one point increase in volatility (i.e., from 32 percent to 33 percent), we would lose \$500. This assumes that  $-5.00$  vega is worth \$500, which it would be for any option whose unit of trading was \$100 per point. If it were a futures option, however, with a larger unit of trading, then the volatility risk would be  $-5.00$  times whatever the unit of trading was.

Vega is stated as a negative number here, indicating that a falling volatility would be profitable for the position, while a rising volatility would be harmful. If we truly believe in our volatility trading range having a top of 34 percent, then our risk due to volatility is two points (from 32 percent to 34 percent), or \$1,000.

If we are looking for volatility to decrease back to 27 percent, for example, which is the center of the volatility's past trading range, then we could make \$2,500 (\$500 times 5 points of volatility decrease, from 32 percent to 27 percent) if that happened.

Overall, then, this is a position that has \$1,000 of risk and \$2,500 of profit potential, as measured by the vega. Of course, as we know, other factors could influence the position, including the fact that implied volatility could trade to higher levels than previously seen. Nevertheless, this example shows that by using vega, we can measure the volatility risk of a position.

---

Later in this chapter, we explore ways to isolate volatility from the other variables in order to produce a position that is neutral to the market with respect to everything except volatility.

## Theta

Theta is the measure of time decay on an option. It is stated as a negative number, indicating that as one day passes, the value of an option will decrease in value. Theta is useful in describing just how the passage of time affects a portfolio of options. If you have a lot of short (naked) options in your portfolio, then you will have a very positive theta, because time is your ally. On the other hand, if you own a lot of options, then the theta of your portfolio will be negative, accurately describing the loss that you can expect daily due to time decay.

## Rho

Rho measures the effect that a change in interest rates would have on the price of an option. Recall that the interest rate used to value options is the *short-term, risk-free interest rate*, which is normally considered to be the 90-day T-bill rate. Rho is a very small number for short-term options, which is what most traders have in their positions, and is therefore rightfully ignored by most traders. It does have more meaning for longer-term options, such as LEAPS. In fact, the longer the remaining life of the option, the more important interest rates are. Figure 6.11 shows three theoretical value curves for a two-year LEAPS option. The top curve depicts the prices if interest rates are 9 percent, the middle curve if interest rates are 6 percent, and the lower curve if interest rates are 3 percent. You can see from the distance between the curves that there is a significant effect from interest rates.

Of course, you wouldn't see short-term interest rates change by 3 percent instantaneously, but you could see such a change over a fairly short period of time if the Fed is aggressively trying to raise or lower rates.

**Figure 6.11**  
**TWO-YEAR LEAPS CALL PRICING CURVE**

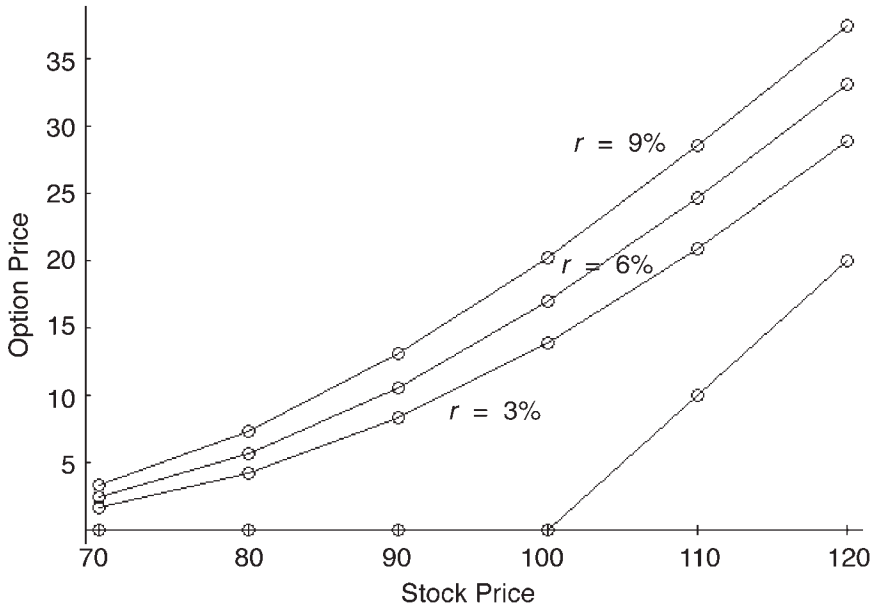

During 1994, the Fed raised the discount rate several times in an attempt to slow down what was perceived to be an overheated economy. During the course of this raising of rates, the risk-free rate rose from 3 percent to 5.5 percent in about 10 months. Typically, when rates are raised, stock prices falter. And 1994 was no exception, as there were three or four fairly steep declines in the broad averages that year, and the averages were off slightly for the year.

What benefited from this rise in rates were LEAPS options. In fact, the rise in rates over eight months actually negated a large part of the time decay for the longer-term options. Essentially the prices moved from the bottom line on the graph in Figure 6.11 to the middle line, although eight months passed in the interim.

## Gamma, Revisited

With the preceding four measures, you can determine how your option positions or your whole option portfolio will react to changes in the marketplace. Still, some theoreticians felt that this was not enough, because two of them—delta and vega—can change so rapidly that it is difficult to neutralize them. So, they thought that if the change in the delta could be measured, for example, it would be useful. This is the *gamma*, which was discussed earlier in this chapter. The gamma measures how much the option’s delta changes when the underlying changes in price by one point. Essentially, it is a measure of how fast the delta changes. Thus, if gamma and delta could be neutralized, then even if the underlying price changed, the option position in question would continue to remain delta neutral. Eventually, if the price of the underlying moved far enough, both gamma and delta would acquire some non-zero value, and the position would lose its neutrality. Still, a delta *and* gamma neutral position has a much better chance of remaining delta neutral than does one that was initially only delta neutral.

Gamma is related to the other measures of risk (in fact, as we said earlier, they are *all* interrelated). Figure 6.12 shows how gamma is related to the amount of time left until expiration of the option in question. If there is a lot of time remaining, the gamma is a relatively stable number, whether the option is in- or out-of-the-money. That is shown by the bottom curve on the graph.

This fact can be depicted in tabular form as well. Table 6.1 assumes that the option has one year of life remaining and that the striking price is 50. It shows the theoretical value of the option and its delta. The gamma is merely the difference in delta for a one-point move in the underlying stock. Thus, in this table, we are showing the observed gamma (the actual difference in deltas), as opposed to the mathematically computed gamma. The two are essentially the same.

You can observe that gamma is fairly stable for this longer-term option: the delta increases rather uniformly as the stock rises (or decreases uniformly as it falls). However, if we consider a short-term option, then things change substantially. Figure 6.12 shows that the gamma of a one-month option behaves quite violently when the

**Figure 6.12**  
**GAMMA VERSUS TIME**

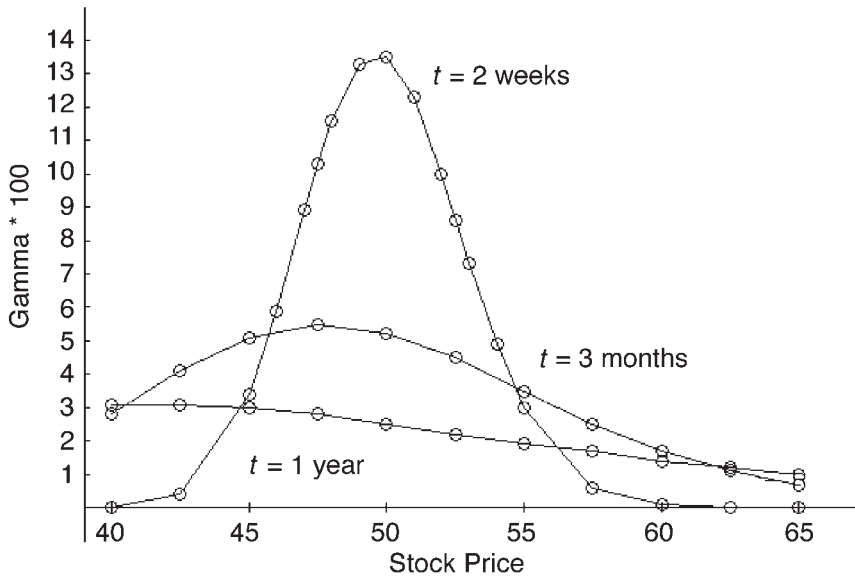

stock is near the striking price. Table 6.2, which is similar to Table 6.1, shows the situation for a one-month option.

In the case of this short-term option, gamma is stable and nearly zero for options that are only moderately in- or out-of-the-money. This makes logical sense. For example, a moderately out-of-the-money option that has very little life remaining has a delta of nearly zero. Even if the underlying rises by a point, that delta is still going to be very nearly zero. Thus, the one-point rise by the underlying doesn't increase the delta much at all; this is merely another way of saying that gamma is almost zero as well. The same thing holds true for the in-the-money option, because in that case the delta is very nearly 1.00, and a one-point move by the underlying won't change the delta much. Hence, once again, the gamma is nearly zero because the delta doesn't change for a one-point move by the underlying.

However, near the striking price, things are much more interesting. The delta changes rather quickly, especially for a short-term

**Table 6.1**  
**ONE-YEAR CALL WITH STRIKE PRICE OF 50**

Stock Price	Theoretical Value	Delta	Gamma (Observed)
40	1.02	0.24	
41	1.27	0.28	0.04
42	1.57	0.32	0.04
—			
—			
—			
49	4.87	0.62	
50	5.50	0.66	0.04
51	6.18	0.69	0.03
—			
—			
—			
58	11.72	0.87	
59	12.60	0.89	0.02
60	13.50	0.91	0.02

**Table 6.2**  
**ONE-MONTH CALL WITH STRIKE PRICE OF 50**

Stock Price	Theoretical Value	Delta	Gamma (Observed)
41	0.00	0	
42	0.00	0	0
43	0.01	0.01	0.01
—			
—			
—			
48	0.47	0.28	
49	0.81	0.41	0.13
50	1.29	0.55	0.14
51	1.90	0.68	0.13
52	2.64	0.79	0.11
—			
—			
—			
59	9.25	1.00	0
60	10.25	1.00	0



option or a low-volatility stock. This, too, is logical, for near expiration, the time value of an option disappears quickly. Thus, a small increase in the stock price as it moves higher from the striking price will result in the delta increasing from something just above 0.50 to something very large quite quickly. So, you can see that gamma is related to time and volatility.

## Gamma and Delta Neutral

The next logical step in constructing a price neutral position is to establish one that is neutral with respect to both delta *and* gamma. In this manner, the position will not acquire much risk due to price changes by the underlying instrument. It is a simple matter to construct such a position, although the thought of doing it is somewhat daunting to many traders. There are really only two steps required: (1) create a gamma neutral position, and then (2) neutralize the delta. The second step can always be accomplished with (equivalent) shares or contracts of the underlying security.

---

*Example:* Suppose that a stock is trading at 98 at the beginning of the year, and a trader is interested in setting up a gamma and delta neutral position with the following three-month options:

Option	Price	Delta	Gamma
March 100 call	5	0.50	0.030
March 110 call	2	0.25	0.020

Note that gamma is a small number, so you should use at least three decimal places when dealing with it, especially if you are trading large quantities.

Now, in order to create a gamma neutral position, we merely need to divide the two gammas in question to determine the neutral ratio. In this case, a neutral position would be to buy two March 100 calls for every three March 110 calls that we sell, since the gammas are in the same ratio of two to three (0.020 to 0.030). This position is going to have a nonzero delta, and in this example we are concerned with neutralizing that delta.

For the purposes of this example, let's assume that our actual trade is to buy 200 March 100 calls and sell 300 March 110 calls. This position has the following ESP, or position delta:

Option	Quantity	Delta	ESP
March 100 call	L 200	0.50	+10,000
March 110 call	S 300	0.25	-7,500
Position Delta:			+2,500

To neutralize this position, we could sell (short) 2,500 shares of the common stock against the option spread, or we could use our knowledge of equivalent positions and instead sell 25 March 100 calls and buy 25 March 100 puts. If we used the options, our resultant position would be:

Long 175 March 100 calls  
Short 300 March 110 calls  
Long 25 March 100 puts

*Note:* the use of the equivalent option position does not change the gamma at all. Neither stock nor the equivalent position has any gamma at all (that is, the gammas of the March 100 call and the March 100 put are equal and offset each other when we buy and sell an equal quantity).

In the preceding example, it was assumed that we used the gammas to establish a neutral position that was a call ratio write. In fact, we could have done the opposite. Either of these positions would be gamma neutral:

Buy 2 March 100 calls  
Sell 3 March 110 calls

or

Sell 2 March 100 calls  
Buy 3 March 110 calls

We would choose one or the other, depending on what we were actually trying to accomplish. If we were trying to sell volatility, we

would use the first position—the call ratio write. However, if we were attempting to buy volatility, we would use the second position—the backspread. The example did not show that position's exposure to volatility; but from what we have already demonstrated in this chapter, we know that the call ratio write is one of the strategies used when selling volatility, while the backspread is a strategy used for buying volatility. We address the volatility exposure of a gamma–delta neutral position shortly.

First, however, let's examine this position a little more closely so that you can see just what the characteristics are of a position that is gamma and delta neutral. Figure 6.13 is that of the delta of this position for various stock prices. The more horizontal line is where the delta would be after 7 days had passed. The other line, which has wider swings, is where the delta would be in 30 days. You can see that even though the position starts out delta and gamma neutral, it does acquire a delta after time passes, especially when the underlying stock changes dramatically in price. You must remember, though, that this example position was a rather large position, so the deltas

**Figure 6.13**  
**POSITION DELTA OF RATIO SPREAD**

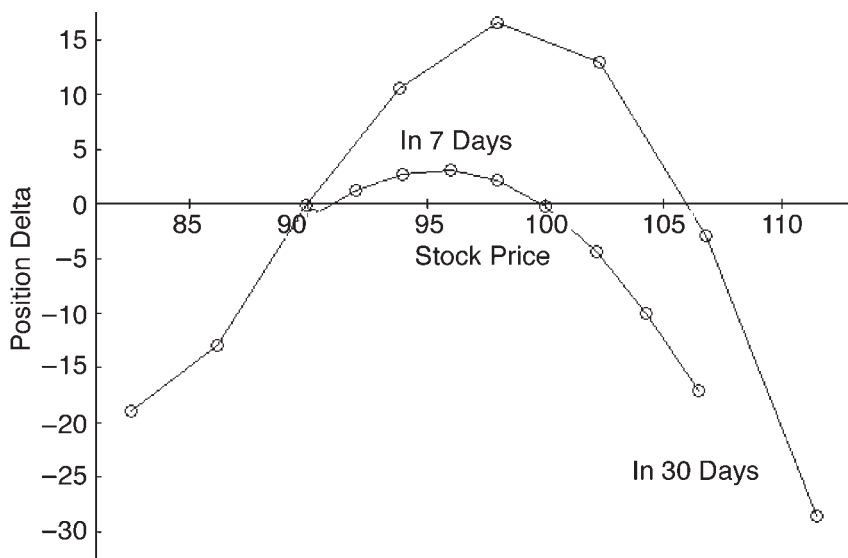

that are acquired are not all *that* large. In fact, the deltas after 7 days are rather insignificant—this is the advantage of the gamma–delta neutral position.

Notice that the deltas stay relatively flat over a range—up to a price of about 100 in 7 days and up to a price of about 107 in 30 days. This means that you would probably not have to adjust your position unless the stock rose above those prices. Above those prices, you begin to get rather delta short. Also, after 30 days, you can see that a large *downside* move will cause the position to acquire a short delta (that’s because we are long the 25 March 100 puts). A neutral trader might want to adjust in that case as well.

Suffice it to say that the delta of this example position is much more stable than a typical one-by-two call ratio would be (buying 100 March 100 calls and selling 200 March 110 calls, for example, which is only a delta neutral position).

The actual position that we constructed with this gamma–delta neutral position is mostly a call ratio write, but it has a few extra puts added for downside profit potential. Also, the ratio of the long calls to short calls is less than you would have in a strictly delta neutral position (1.75-to-3 instead of 1-to-2), so the position doesn’t have as much upside exposure to naked options.

In case you were wondering how this gamma–delta neutral position looked, from a profit-and-loss standpoint, Figure 6.14 shows the profitability at expiration (straight lines) and in 30 days (curved line). This graph assumes that volatility remains the same, so the profits and losses are accruing strictly from stock price movement and from the passage of time. In reality, we would only take such a position if we were expecting volatility to decrease. We will next see how *that* event would affect the profitability.

This example position initially had an exposure to rising volatility. In other words, the position is short volatility; or in Greek terms, it has a negative *vega*. This is what we would want if we were selling volatility. In order to see how these statements are quantified, let’s expand on the previous example by now including volatility in our calculations.

---

*Example:* Let’s make one more assumption about this position. Let’s assume that the trader had observed that volatility typically traded in a range

**Figure 6.14**  
**PROFIT OF RATIO SPREAD**

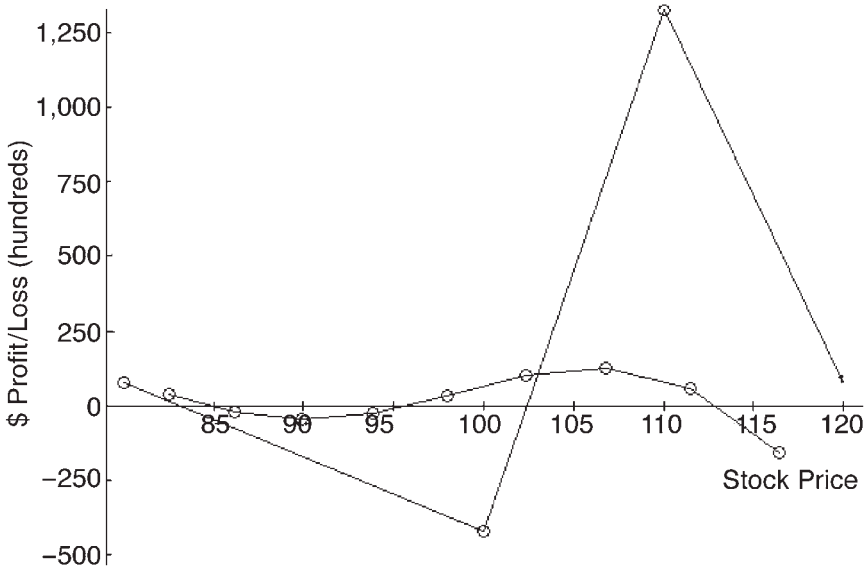

between 20 percent and 30 percent for this stock. Now, with volatility at 30 percent, he wants to establish a gamma–delta neutral position in order to sell the volatility. Our example position is just the ticket.

The data listed below is exactly the same as from the previous example, except that now we can see the vega of each option as well. Remember, the vega is the amount by which the option price would increase for a (instantaneous) 1 percent increase in implied volatility. The put has been added to the table as well.

Option	Price	Delta	Gamma	Vega
March 100 call	5	0.50	0.030	0.180
March 110 call	2	0.25	0.020	0.150
March 100 put	5 $\frac{7}{8}$	-0.50	0.030	0.180

Our initial position—long 175 March 100 calls, short 300 March 100 calls, and long 25 March 100 puts—was delta and gamma neutral, but it has a volatility exposure. We can easily compute that exposure by using the vega of the options.

Position	Option Vega	Position Vega
Long 175 March 100 calls	0.180	+3,150
Short 300 March 100 calls	0.150	-4,500
Long 25 March 100 puts	0.180	+450
	Total Position Vega:	-900

Note that vega is always expressed as a positive number; thus, long option positions (March 100 calls and March 100 puts in this example) have a positive vega, while short option positions have a negative position vega.

The preceding position vega indicates that if implied volatility falls by 1 percent—from 30 percent to 29 percent, for example—then the position will profit by \$900. That is an instantaneous measure, of course, and it is affected by stock price changes and the passage of time. Figure 6.15 shows the profit in 30 days, with the lower curve being the same as seen on the previous profit graph—it is the profit if volatility remains unchanged. The

**Figure 6.15**  
**PROFIT AND LOSS OF RATIO SPREAD IF VOLATILITY CHANGES**

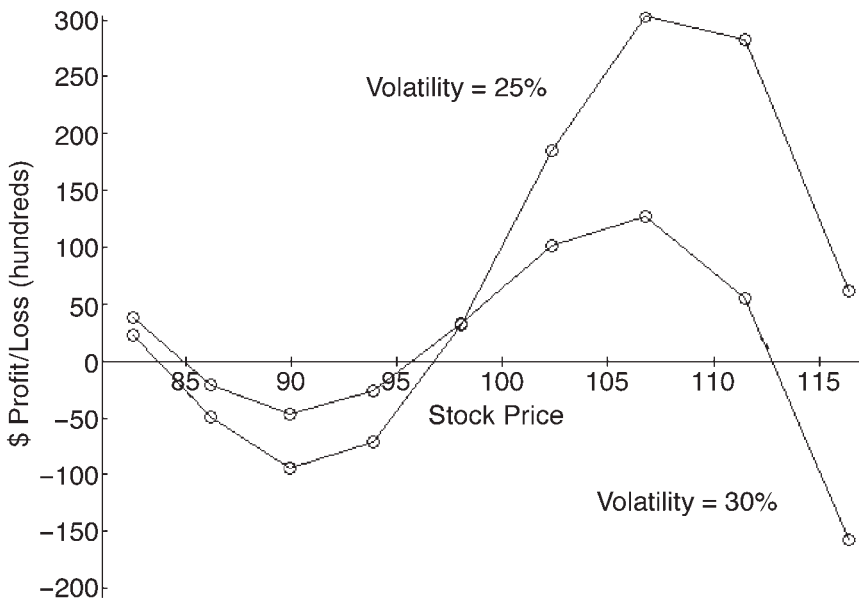

higher curve shows what would happen if volatility declined to 25 percent, about back to the middle of the 20 percent to 30 percent range that we assumed for this example.

You can see how much extra profit that the decrease in volatility would garner for this position, if the stock is above 98.

---

This rather detailed example shows how the gamma–delta neutral position can profit nicely from a decrease in implied volatility, while basically maintaining a much more price neutral outlook than a mere call ratio spread would have. We can look at each of our five preferred delta neutral strategies for trading volatility and see how they would look as gamma–delta neutral positions. The transformation is quite interesting. However, before doing that, we give you one more piece of the general puzzle, and that is how to construct a position that is both gamma and delta neutral and also has the volatility exposure that you feel comfortable with.

This is easily accomplished by solving two equations in two unknowns and then adjusting for any residual delta. As soon as you say, “two equations in two unknowns,” many people panic. Relax. There are easy ways to accomplish this. First of all, it’s only high school algebra; so if you have a high school or college student in your family, they can probably solve the problem for you. More realistically, there are simple programs that can solve two equations in two unknowns. These are available from shareware or are possibly even given away. If you still can’t find one, call us and we’ll send you one if you pay for the postage.

We will continue to use the same example to illustrate this point. We are going to arrive at essentially the same position as we did earlier, but in this case, we are going to approach the whole thing with a specific idea of the risk we want to take. In the earlier example, we merely found the gamma–delta neutral position and then looked at how large the vega was.

---

*Example:* Suppose that you want to establish a call ratio spread with the March options—as we did earlier—and you want to risk \$1,000 for each point that volatility rises. Of course, that means that you will also be making \$1,000 for each point that volatility declines, and that is where your profit

will come from. In Greek terms, risking \$1,000 per point of rising volatility means that the position has a vega of  $-10.00$ .

Option	Price	Delta	Gamma	Vega
March 100 call	5	0.50	0.030	0.180
March 110 call	2	0.25	0.020	0.150

Let  $x$  stand for the number of March 100 calls to buy, and  $y$  stand for the number of March 110 calls to sell. Remember, we want to be gamma neutral and have a vega of  $-10$ . The two equations would then be:

$$\begin{aligned} \text{Gamma neutral: } & 0.030x + 0.020y = 0 \\ \text{Vega risk: } & 0.180x + 0.150y = -10 \end{aligned}$$

Solving, we get  $x = 222$  and  $y = -333$ . That means we should buy 222 of the March 100 calls and sell 333 of the March 110 calls. By doing so, our position will have some delta to it. Since we want to be delta neutral, we need to rid ourselves of this delta.

Position	Delta	ESP or Position Delta
Long 222 March 100 calls	0.50	+11,100
Short 333 March 110 calls	0.25	-8,325
Total Position Delta:		+2,775

So we want to either short 2,800 shares or use the equivalent option position—sell 28 March 100 calls and buy 28 March 100 puts. The resulting position is:

Long 194 March 100 calls  
Short 333 March 110 calls  
Long 28 March 110 puts

Hence, this position is very similar to the one from the earlier examples. It is slightly larger because we wanted vega risk to be \$1,000 per point, whereas it was \$900 per point in the other example.

Now that the theory for determining an appropriate position has been set forth, we can look at the other strategies for trading volatil-



ity. The preceding example is a little simplistic in that we have limited our choices of calls to use in the spread to just the two shown—the March 100 and the March 110. In reality, when we are looking at ways to sell volatility, we have many options to choose from. While it is reasonable to expect that we would use the at-the-money call as the long side of the spread, there are still several choices as to which out-of-the-money call to sell. Usually, the strategist can narrow the selection process down to very few choices; but as we shall see in the next example, there are times when the selection of the “wrong” options changes the position to something the strategist doesn’t really want.

For selling volatility, the one strategy that interests most people is the short naked combo. What happens to this position when you neutralize gamma? The following example illustrates the situation. We start out by showing you a gamma–delta neutral position, with specific vega risk that is based on a sell combo.

---

*Example:* Assume, as in the previous examples, that a trader wants to sell volatility that is currently at the 30 percent level but normally trades in a range of 20 percent to 30 percent; and he wants \$1,000 of volatility risk per point of volatility increase. However, in this example, he wants to use a sell combo to approach the problem. Recall that we prefer to use a combo (two striking prices) rather than a straddle as the short position in these cases.

With the stock at 98, the trader is considering selling the March 95 put and March 105 call as a sell combo, and then he is looking to hedge that sale by buying out-of-the-money options. In this example, he is going to use the Feb 90 puts and Feb 110 calls as the out-of-the-money combo to purchase as a hedge. When he buys an out-of-the-money combo such as this to protect the short combo, he is said to be buying the “wings.”

The following data exists for XYZ: 98, on January 2:

Option	Delta	Gamma	Vega
Feb 90 put	−0.18	0.025	0.096
March 95 put	−0.35	0.027	0.167
March 105 call	0.37	0.028	0.170
Feb 110 call	0.18	0.024	0.095

Everything is expressed as a positive number, except for the deltas of the puts. The trader will have two equations as before—one for gamma and one for vega. But it appears as if he has four unknowns, since there are four options listed before. In reality, though, he can consider this as two unknowns: one being the March sell combo and the other being the Feb combo to be purchased as a hedge. With this simplification, he substitutes the sum of the components in the equation.

So, let  $x$  = the number of March combos to sell, and  $y$  = the number of Feb combos to buy. The two equations then become:

$$\begin{aligned} \text{Gamma neutral: } & (0.027 + 0.028)x + (0.025 + 0.024)y = 0 \\ \text{Vega risk: } & (0.167 + 0.170)x + (0.096 + 0.095)y = -10 \end{aligned}$$

Solving this equation, we get  $x = -81$  and  $y = 91$ . That is, if the trader sells 81 of the March combos, he should buy 91 of the Feb combos as a hedge. If he wants, he can calculate the position gamma and position vega to ensure that they satisfy his criteria—gamma neutral and vega risk of  $-10$ .

The delta of this position can be computed as:

Position	Delta	ESP (Position Delta)
Long 91 Feb 90 puts	-0.18	-1,638
Short 81 March 95 puts	-0.35	+2,835
Short 81 March 105 calls	0.37	-2,997
Long 91 Feb 110 calls	0.18	1,638
Total Position Delta:		-162

Thus, the position is essentially delta neutral. If the trader wanted to be really picky, he could buy 100 or 200 shares of the underlying to neutralize that delta; but as a practical matter, it is not necessary.

The position that is derived in the example is a little different than you might expect. The "normal" part is that the sale of a combo is hedged by buying a combo that consists of further out-of-the-money options. What is unusual, though, is that the long options expire before the short options do. With this configuration, margin considerations can be considerably different. With futures options, the long options are considered to "cover" the short options until the longs expire, so the margin is merely the spread requirements. However,

with equity or index options, which continue to operate with arcane and illogical margin requirements, the short options are considered naked (unless market maker requirements are obtained, that is, the trader is trading for an exchange member).

Having to margin the short options as naked options makes the margin requirement very large—much, much larger than the risk involved. Obviously, no matter how much the underlying moves prior to expiration of the long options—the Februarys in this example—those long options will protect against large losses; that is, the losses are limited. For the collateral requirements *not* to recognize that fact is preposterous.

The margin requirements don't detract from the profit potential of the position itself, although they certainly do lower the *rate* of return. Figure 6.16 shows how the preceding example position would look at February expiration, that is, the expiration of the long options. The lower curved line depicts the profits if the volatility remained unchanged at 30 percent, whereas the upper curved line

**Figure 6.16**  
**WINGS PROFIT AND LOSS**

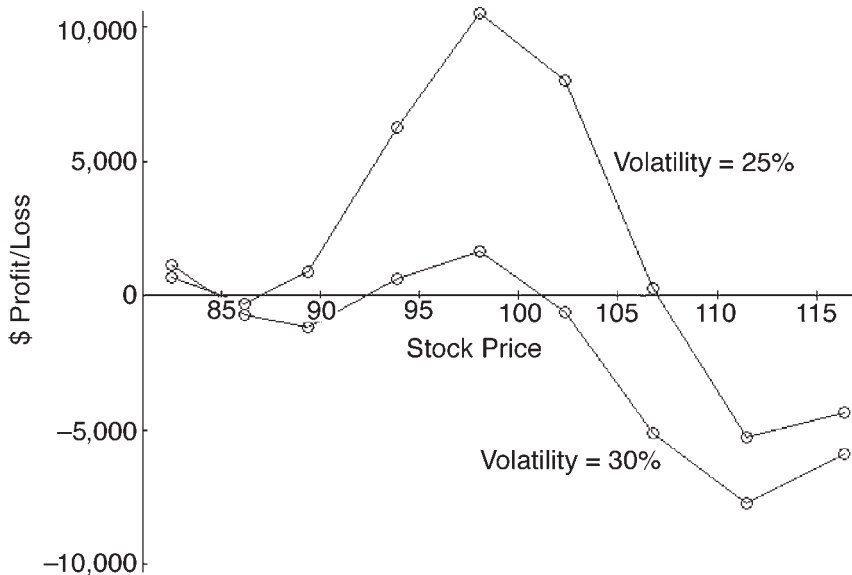

shows the larger profits available if volatility declines to 25 percent—in the middle of the supposed range of implied volatility. Once again, it is apparent that even though the position is initially gamma–delta neutral, it acquires risk due to the passage of enough time and the movement of the underlying stock. Nevertheless, this position has considerably less risk than the mere sale of a naked combo, which of course has unlimited risk if the underlying should move too far in either direction.

You might be wondering why we used the February options instead of longer-term ones as the hedge for the short combo. The reason is this: *in order to begin with the sale of a naked combo and turn it into a delta neutral and gamma neutral position by buying the “wings,” it is necessary to have the wings expire before the short combo does.* The following example shows how a gamma–delta neutral position would look if you were to use a longer-term combo on the buy side.

---

*Example:* Using the same assumptions as in the previous example as far as volatility and wanting to create a gamma neutral position with vega risk of \$1,000 per point are concerned, here are the relevant statistics for XYZ: 98, on January 2:

Option	Delta	Gamma	Vega
April 90 put	-0.24	0.019	0.170
March 95 put	-0.35	0.027	0.167
March 105 call	0.37	0.028	0.170
April 110 call	0.31	0.022	0.192

Once again, we set up two equations in two unknowns, adding the numbers from each combo. Let  $x$  = the number of March combos to sell, and  $y$  = the number of April combos to buy. The two equations then become:

$$\begin{aligned} \text{Gamma neutral: } & (0.027 + 0.028)x + (0.019 + 0.022)y = 0 \\ \text{Vega risk: } & (0.167 + 0.170)x + (0.170 + 0.192)y = -10 \end{aligned}$$

Solving this equation, we get  $x = 67$  and  $y = -90$ . With these data, when we set up and solve the simple set of two equations in two unknowns,

we have a solution that gives us a completely different position. Now,  $x$  is a positive number, which means that we are supposed to *buy* the March combo and *sell* the April combo. In effect, we are setting up two ratio writes, one with calls and one with puts:

Long 67 March 95 puts

Short 90 April 90 puts

and

Long 67 March 105 calls

Short 90 April 110 calls

This is a totally different position than we had planned on originally, but it is the only way to create a gamma neutral position with the required vega from the four options that we have chosen. Figure 6.17 shows how the position looks in 30 days. Once again, the lower curved line represents the profits and losses if implied volatility remains unchanged, while the higher curved line shows the results if implied volatility decreases to 25 percent.

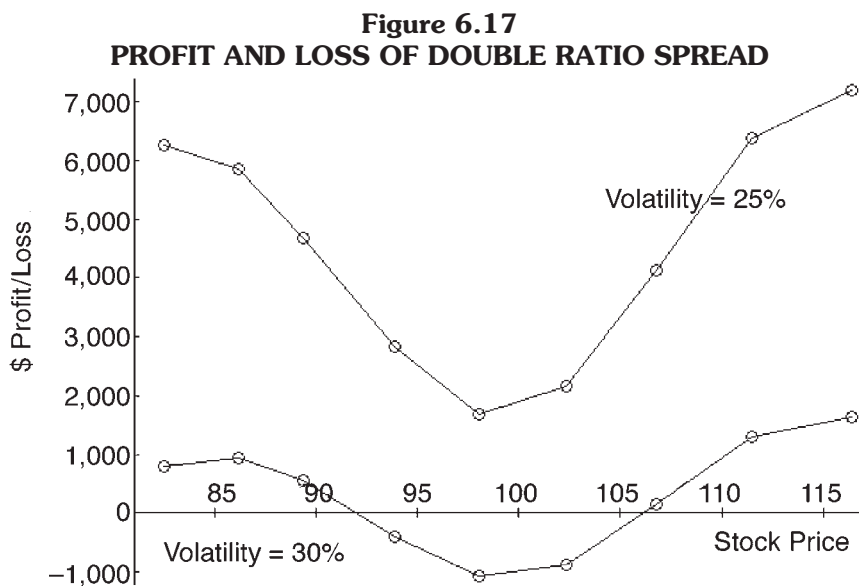

Note that we haven't really solved the dilemma of margin. Just as in the prior example, we are still short the longer-term options (April options in this case), so the position is going to require a fairly large amount of collateral.

The reason that this position takes on a shape that is somewhat unexpected is that the vega of the April options is so large. In order to create a position that has *negative* vega, which was the original intent here, it is virtually impossible to be able to buy those April options because their vega is so large. The combined vega of the March options is 0.337, but the combined vega of the April options is higher, 0.362. This means that whenever volatility declines by a point, the March combo will lose about 34 cents; but the April combo will lose even more—36 cents. Thus, it makes no sense to sell the March combo and buy the April combo if we want to make money from declining volatility.

This example points out something very interesting: it is often difficult to “intuit” a gamma neutral position that has the volatility risk that you want. But by using the Greeks, you can see exactly the construct needed to accomplish your goals. In this chapter, we have spent considerable time outlining the groundwork for our strategy: we want to trade volatility and remove as much of the risk as possible due to price changes by the underlying. By using the Greeks, we guarantee that an appropriate position is taken.

I have often seen traders who want to accomplish the same things as we have outlined in this chapter take a position that does not work but seems like it should. Typically, if we decide to sell a combo in order to capitalize on an outlook for declining volatility, we will then think that buying the wings that expire at the same time or in a later month will protect us. The previous example shows the fallacy of that thinking. In reality, by buying those wings, we effectively more than cancel out our profit potential from declining volatility.

So far we have seen how two of the more common strategies for selling volatility—the ratio spread and the naked short combo—look when they are transformed into gamma–delta neutral positions. Now we examine how the basic strategies for buying volatility—the long straddle, the backspread, and the calendar spread—can be treated as far as gamma–delta neutral positions are concerned.

**The Calendar Spread.** Without going into as much detail as in the previous examples, here is how a calendar spread position that is gamma–delta neutral, with appropriate volatility exposure (vega of +10—note the *plus*, now), would look for XYZ: 100, on January 2, with volatility = 20%:

Long 52 June 100 calls  
Short 44 March 100 calls  
Long 15 June 100 puts

So this looks something like a normal calendar spread, except we are long a few extra calls on the long side, plus long a few puts as well. This is a very attractive position, because it can make money if the underlying moves far enough in either direction, while also profiting if volatility increases (which is our basic assumption). Moreover, the short calls hedge the position if the underlying remains stagnant.

The profitability of this calendar spread is shown in Figure 6.18. The curved lines show the profit at March expiration, the near-term

**Figure 6.18**  
**CALENDAR**

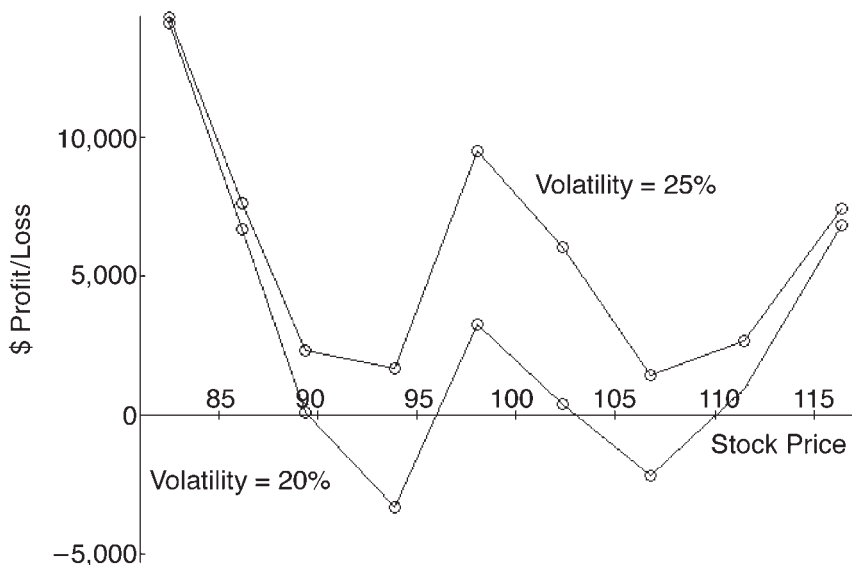

expiration. The lower line on the graph shows the results if volatility remains unchanged at 20 percent, while the higher line on the graph shows the better results that could be expected if implied volatility increased to 25 percent.

**The Backspread and the Long Straddle.** These are the other two basic strategies that we use when we want to buy volatility (i.e., when we want to have a *positive* vega). I do not believe that if we are using these strategies, we should be so concerned with gamma neutrality. When these two strategies acquire a delta, it means we are making money, for the underlying instrument is moving. The neutralizing of price movement was much more important for the volatility selling strategies because a large stock movement could be devastating in that case. But here, a large movement will be helpful; so I generally feel that delta neutral, with the appropriate volatility risk, is sufficient.

---

*Example:* Suppose we want to establish a backspread because we think that volatility, which is currently at 20 percent and at the low end of its historical range, can go higher. The following data describe the situation for XYZ: 100, on January 2; volatility = 20 percent:

Option	Delta	Gamma	Vega
March 90 call	0.91	0.018	0.079
March 100 call	0.57	0.043	0.180

Solving these two equations gives us a *delta* neutral position, with a vega of +10. If volatility increases, we will make \$1,000 per point of volatility increase.

$$\begin{aligned} \text{Delta neutral: } & 0.91x + 0.57y = 0 \\ \text{Vega exposure: } & 0.079x + 0.18y = 10 \end{aligned}$$

Solving, we get  $x = -48$  and  $y = 76$ . So the desired position is:

Long 76 March 100 calls  
Short 48 March 90 calls



This is a typical backspread position. Incidentally, this has a fairly small gamma anyway, even though we didn't neutralize it. We can compute that the position gamma of this position is +2.40. If the underlying rises one point, the position delta, which is neutral to begin with, will increase to 2.40, which means that the position will be delta long 240 shares. On the other hand, if the underlying declines by one point, the delta will become -2.40, or the position will then be delta short 240 shares.

---

The farther that the underlying rises, the more the delta will increase; the farther it declines, the more the delta will decrease. Eventually, you will have a position that has quite a large delta—either positive in a rising market or negative in a falling market. However, that is a “good” problem, because you will have profits after large moves by the underlying. I feel the same way about the long straddle position as well; it's not necessary to zero out the gamma.

If you prefer a gamma–delta neutral strategy for trading volatility from the long side, then I encourage you to use the calendar spread, as shown in a recent example.

## Even More Advanced Constructions

The neutral positions that were described earlier were both gamma and delta neutral. In theory, you could construct positions that had neutrality with respect to as many variables as you might want to consider. Eventually, though, you have to assume some risk somewhere—if you're a commission-paying trader—if you intend to make money; only market makers can be neutral with respect to *all* variables, for their intention is to buy on the bid and sell on the offer and take no further risk.

In order to create a position that is neutral with respect to three variables, for example, you would merely have to set up three equations in three unknowns and solve that set of simultaneous equations. For example, you might want to be neutral with respect to gamma and theta (time) but still have volatility risk.

Another risk measure that traders have come to use is the “gamma of the gamma.” This measures how fast the gamma changes when the underlying security moves by one point. Thus, many of the more theoretical traders feel they need even *another*

measure to help them keep a position neutral with respect to price changes by the underlying security. This shows just how important they consider price neutrality to be.

So the three measures that you might want to use in your equation would be gamma, gamma of the gamma, and vega. You would still neutralize delta at the end, as was done in the previous examples. In this manner, you arrive at a position that is *very* neutral with respect to price movement but still has volatility risk, a risk we want, in the context of this chapter.

The concept can be carried even further—four equations in four unknowns, for example (gamma, time or theta, volatility or vega, and gamma of the gamma), with delta being neutralized at the end. Such a position would be totally impossible to reason out, without using the arithmetic equations.

---

*Example:* Without going into too much detail, one of the previous examples can be used to construct a position that is neutral with respect to four variables and has volatility risk. We will once again begin with the thought of selling the March 95–March 105 combo and using the February 90–February 100 combo as protection. As it turns out, this is the way the position looks after neutralizing the necessary components for XYZ: 98, on January 2:

Long 28 Feb 90 puts  
Short 145 March 95 puts  
Short 45 March 105 calls  
Long 82 Feb 110 calls  
Short 5,400 shares of XYZ

This position has these qualities:

Delta neutral  
Gamma neutral  
Theta neutral  
Gamma of gamma neutral  
Volatility risk: \$1,000 per point

There is risk to the upside in this position, but the 82 long calls mostly offset the risk of the 45 short calls and the 5,400 short stock. To the downside, there is more obvious risk, as the 5,400 short stock and the 28 long puts are less of an absolute hedge against all those short March 95 puts.

---

It is not normally necessary for the small- or medium-sized investor to attempt to get this neutral, but the example shows that it can be done.

## Summary

This concludes the section on using the Greeks to neutralize positions, so that the volatility risk can more accurately be assessed and assumed. It is really not too complicated, as the examples show. Even with all of this preparation, though, you should realize that you can still lose money in these positions, especially if naked options are involved.

The examples that we used were theoretical, whereas most of the examples in this book have been real ones, attempting to demonstrate the viability of the various approaches in the context of actual market action. However, in this section, since the concept is so new to many traders, we felt that the theoretical examples quite accurately depict the ways in which these positions are analyzed and established. The fact that no actual examples were given does not mean that this approach is strictly a theoretical one. Quite the contrary. In fact, the next time that you see OEX options getting overly cheap or expensive, you may want to try this approach, for it works especially well with broad-based index options. It is also quite appropriate in the futures markets, where volatility sometimes jumps quite high on expectations of drought, flood, or other such conditions.

## TRADING THE VOLATILITY SKEW

Up to this point, we have examined the feasibility of trading volatility based on a two-pronged approach: (1) implied volatility is at the end of its range, and (2) it is at a more extreme level than historical volatility. The idea is that implied volatility will move at some point to the middle of its range, and the volatility trader will profit.

Despite all the careful work laid out in this chapter up to this point, it is possible to lose money by trading volatility in the manner described. For example, if you're selling volatility, you may find that

it breaks out of the previous range and trades much higher. This would cause losses, even though the position was essentially delta and gamma neutral. This type of volatility increase has occurred many times in the past. Sometimes, volatility increases occur from an already high volatility.

---

In the summer of 1991, soybeans had broken *down* from a price of about 575 to 525. Volatilities fell toward the lower end of their range, as is the custom for grain options; declining grain prices are usually accompanied by declining implied volatilities. Then in July, a drought scare developed, and beans rallied back up toward 600. This rally brought implied volatilities to the top of their previous range, well above the historical volatilities at that time.

At this point, I established gamma–delta neutral call ratio spreads that had excellent profit potential if volatility declined. What happened was that the drought scare was exacerbated for about another week, during which time beans rallied to nearly 650 and implied volatility skyrocketed to levels way beyond the previous range.

This move was too large even for the gamma–delta neutral position, and I was forced to make adjustments to protect the position. Within a few days it rained, and beans traded down the limit for two days before stabilizing in the 550-to-575 area. Volatilities declined at that point, but it was too late—the adjustments had been so unprofitable that they made the whole position a loss.

---

One must be mindful of the fundamentals when trading volatility; and when the soybean position was established, I felt that the drought was not serious—I felt it was probably just the typical mid-summer hype that the grain markets often experience. Moreover, I also thought that the implied volatility being at the high end of the range was sufficiently accounting for the stories that were circulating. Obviously this was wrong, as losses, albeit limited ones, were taken.

In a like manner, losses can be taken when volatility is traded from the long side as well. We have already given an example of when gold's volatility dropped to then-unheard-of levels during 1994 and 1995, causing losses for buyers of volatility.

The major problem in these situations was that the historical and the implied volatilities never converged, at least not for a while. In fact, that is one of the major problems with trading volatility: *there is no guarantee*

that implied and historical volatilities will converge or that they will converge during the lifetime of your position. As a result, some volatility traders prefer to use another approach. They prefer to look for situations where there is volatility skewing and trade those.

When different options on the same underlying instrument have substantially different implied volatilities, then a *volatility skew* is said to exist. Certain markets have a volatility skew almost continuously—metals and grain options, for example, and OEX and Standard & Poor's (S&P) 500 options since the crash of 1987. Others have a skew that appears occasionally. When we talk about a volatility skew, we are describing a group of options that has a pattern of differing volatilities, not just a few scattered different volatilities. In fact, for options on *any* stock, future, or index, there will be slight discrepancies between the various options of different striking prices and expiration dates. However, in a volatility skew situation, we expect to see rather large discrepancies between the implied volatilities of individual options, especially those with the same expiration date; and there is usually a pattern to those discrepancies. The following examples demonstrate the patterns that we expect to see.

---

The following example shows the type of volatility skew that has existed in OEX and S&P 500 options—and many other broad-based index options—since the crash of 1987. This data is very typical of the skew that has lasted for over eight years. For OEX: 586 in December 1995:

<i>Option</i>	<i>Implied Volatility (%)</i>
Jan 560	15.8
Jan 565	14.9
Jan 570	14.0
Jan 575	13.2
Jan 580	12.5
Jan 585	11.8
Jan 590	11.2
Jan 595	10.7
Jan 600	10.5

Note that we have not labeled the options in this table as puts or calls. That's because a put and a call with the same striking price and expiration

date must have the same implied volatility, or else there will be a riskless arbitrage available.

---

In the preceding volatility skew, note that the lower strikes have the highest implied volatility. This is called a *reverse* volatility skew. It is sometimes caused by bearish expectations for the underlying, but that is usually a short-term event. For example, when a commodity undergoes a sharp decline, the reverse volatility skew will appear and last until the market stabilizes.

However, the fact that the reverse skew has existed for so long in broad-based options is reflective of more fundamental factors. After the crash of 1987 and the losses that traders and brokerage firms suffered, the margin requirements for selling naked options were raised. Some firms even refused to let customers sell naked options at all. This lessened the supply of sellers. In addition, as we pointed out in Chapter 3, money managers have turned to the purchase of index puts as a means of insuring their stock portfolios against losses. This is an increase in demand for puts, especially out-of-the-money puts. Thus, we have a simultaneous increase in demand and reduction in supply. This is what has caused the options with lower strikes to have increased implied volatilities.

In addition, money managers also sometimes sell out-of-the-money calls as a means of financing the purchase of their put insurance. We have described this strategy in previous chapters as the “collar.” This action exerts extra selling pressure on out-of-the-money calls, and that accounts for some of the skew in the upper strikes, where there is low implied volatility.

A *forward* volatility skew has the opposite look from the reverse skew, as you might expect. It typically appears in various futures option markets, especially in the grain option markets, although it is often prevalent in the metals option markets, too. It is less frequent in coffee, cocoa, orange juice, and sugar, but it does appear in those markets with some frequency.

---

The following data shows how a forward volatility skew looks for March soybeans: 745:

<i>Option</i>	<i>Implied Volatility (%)</i>
March 675	15.8
March 700	16.2
March 725	17.7
March 750	19.8
March 775	21.9
March 800	23.8
March 825	24.8
March 850	26.9
March 875	28.8
March 900	30.7

Notice that in a *forward skew*, the volatilities increase at higher striking prices.

---

The forward skew tends to appear in markets where expectations of upward price movements are overly optimistic. This does not mean that everyone is necessarily bullish, but that they are afraid that a very large upward move—perhaps several limit up days—could occur and seriously damage the naked option seller of out-of-the-money calls.

Occasionally, you will see *both* types of skews at the same time, emanating from the striking price in both directions. This is rather rare, but it has been seen in the metals markets at times.

---

The following skew was taken from actual gold option prices for April gold: 390:

<i>Option</i>	<i>Implied Volatility (%)</i>
April 350	10.7
April 360	10.0
April 370	8.8
April 380	8.2
April 390	8.0
April 400	9.6
April 410	11.2
April 420	13.1
April 430	14.9
April 440	16.6
April 450	18.3

Notice that the at-the-money options are the least expensive, while the out-of-the-money options are more expensive, both at lower strikes *and* at higher strikes. This is a dual volatility skew.

---

The interesting thing about volatility skew situations is that you can ideally establish positions where you sell expensive options and buy cheap options on the *same* underlying instrument simultaneously. Then, if the actual price movement of the underlying adheres to normal patterns, the position should profit. In effect, you are being offered an excellent opportunity to trade two differing volatilities on the same underlying—it's as close to a sure thing as you'll find anywhere.

## Price Distributions

Before getting into the specifics of trading the volatility skew, let's discuss stock price distributions for a minute. Stock and commodity price movements are often described by mathematicians as adhering to standard *statistical* distributions. The most common type of statistical distribution is the normal distribution. This is familiar even to many people who have never taken a statistics course.

Figure 6.19 shows the “bell curve,” which is a graph of the normal distribution. The center of the graph is where the average member of the population resides; that is, most of the people are near the average, and very few are way above or way below the average. The normal distribution is used in many ways to describe the total population: results of IQ tests or average adult height, for example. In the normal distribution, results can be infinitely above or below the average, also called the median. Thus, this is not useful for describing stock price movements, since stock prices can rise to infinity but can only fall to zero.

Thus, another statistical distribution is generally used to describe stock price movements. It is called the *lognormal distribution*, and it is pictured in Figure 6.20. The height of the curve at various points essentially represents the probability of stock prices being at those levels. The highest point on the curve is right at the average, reflecting the fact that most results are near that price, as they are with the nor-



**Figure 6.19**  
**BELL CURVE OR NORMAL DISTRIBUTION**

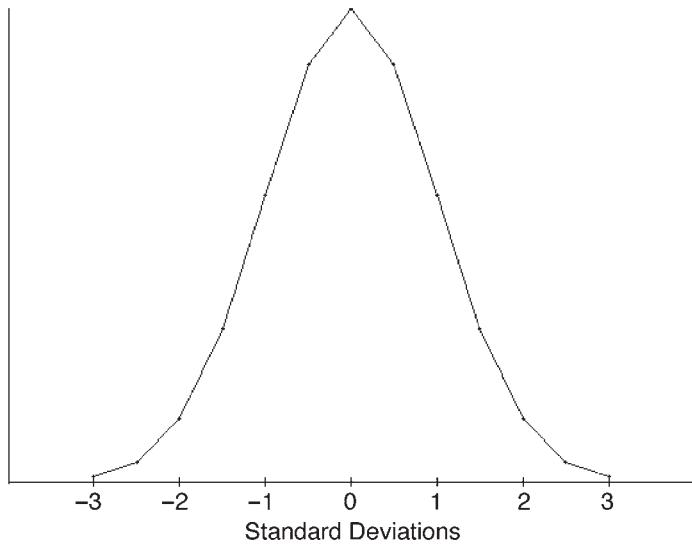

**Figure 6.20**  
**LOGNORMAL DISTRIBUTION**



mal distribution shown in Figure 6.19. Or, in terms of stock prices, if the average is defined as today's price, then most of the time, a stock will be relatively near the average after some period of time. The lognormal distribution allows that stock prices could rise infinitely, although with great rarity, but cannot fall below zero. In fact, they rarely fall to zero.

Mathematicians have spent a great deal of time trying to accurately define the actual distribution of stock price movements, and there is some disagreement over what that distribution really is. However, the lognormal distribution is generally accepted as a reasonable approximation of the way that prices move. Those prices don't have to be just stock prices, either. They could be futures prices, index prices, or interest rates.

Normally, option prices reflect the distribution of the prices that the underlying is expected to follow. For example, the Black-Scholes model is based on a lognormal distribution of prices. However, when a skew is present, the skew is projecting a *different* sort of distribution for prices. Figure 6.21 is a graph of the forward skew, such as you see

**Figure 6.21**  
**FORWARD SKEW**

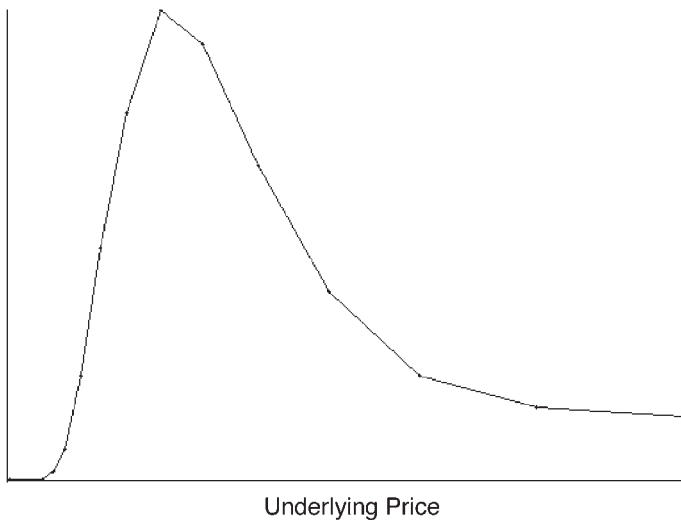

in the grains and metals. Compare it to the graph of the lognormal distribution in Figure 6.20. You can see that this one has a distinctly different shape: the right-hand side of the graph is up in the air, indicating that this skewed distribution implies that there is a far greater chance of the underlying rising by a huge amount. Also, on the left side of the graph, the skewed distribution is squashed down, indicating that there is far less probability of the underlying falling in price than the lognormal distribution would indicate.

The reverse volatility skew is shown in Figure 6.22. Note that it is also different from the regular lognormal distribution. In this case, however, the left-hand side of the graph is lifted higher, indicating that the probability of prices dropping is greater than the lognormal distribution implies that it is. Similarly, the graph on the right flattens out on the right-hand side, which means that it is insinuating that prices won't rise as much as the lognormal distribution says they will.

**Figure 6.22**  
**REVERSE SKEW**



It is my opinion that skewed volatilities are *not* the correct picture of the way markets move, and that the lognormal distribution is a much truer picture. Therefore, when we find significant volatility skewing in a particular group of options, we have a good trading opportunity. A neutral option spread position can be established that has a statistical advantage because the two options have differing implied volatilities.

The best place to look for this volatility skewing is in the options with the same expiration date, as shown in the previous tables of OEX and corn options. The reason that I prefer using options with the same expiration date as the basis of volatility skew trading is that, even if the skew doesn't disappear by expiration, the very fact that the options must go to parity at expiration means that they will then have behaved in a manner similar to the underlying instrument—that is, they will have adhered to the lognormal distribution, not to the skewed distribution.

What we want to accomplish by trading the volatility skew is to capture the implied volatility differential between the two options in question, without being overly exposed to price movements by the underlying instrument. We could use the simple bull or bear spreads, but they are too price dependent. Accordingly, the best strategies are the vertical spread strategies: ratio writes or backspreads.

## Trading the Positive Skew

When the volatility skew is *positive*, as it is with grain options, then it is the *call* ratio spread (Figure 6.23) or the *put* backspread (Figure 6.24) that are the preferred strategies. The reason that these are the two chosen strategies is because, in each one, we are buying options with a lower striking price and selling options with a higher striking price. Since the higher strikes have the inflated volatility in a positive volatility skew, these strategies offer a statistical advantage. This advantage arises from the fact that we are buying the “cheap” option(s) and selling the relatively “expensive” option(s) simultaneously, on the same underlying.

**Figure 6.23**  
**CALL RATIO SPREAD**

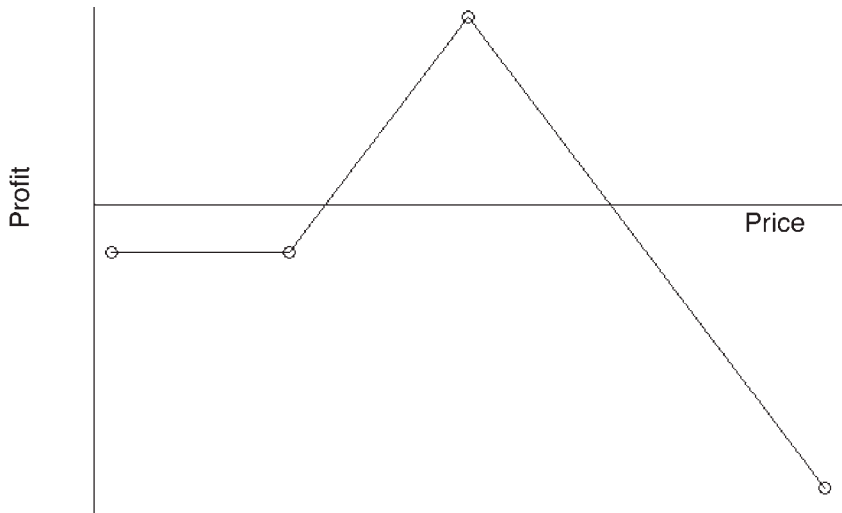

**Figure 6.24**  
**PUT BACKSPREAD**

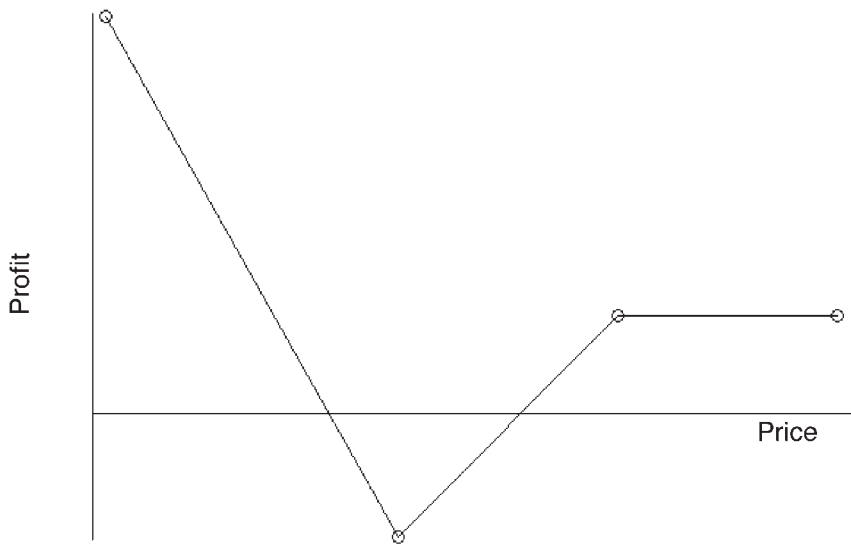

---

The following data is excerpted from the earlier example of the forward volatility skew, using March corn options: 745:

<i>Option</i>	<i>Implied Volatility (%)</i>
March 750	19.8
March 775	21.9

Either one of the two following strategies is delta neutral and takes advantage of the forward skew. The following call ratio spread would be an attractive strategy for trading this volatility skew:

Buy 10 Corn March 750 call  
Sell 20 Corn March 775 calls

But if you felt that volatility could explode and therefore harm the position, you might want to use a put backspread:

Buy 20 Corn March 750 puts  
Sell 10 Corn March 775 puts

Once again, you would be buying options at the lower strike and selling the relatively more expensive options at the higher strike.

---

You could use the past history of implied volatility to help you decide which strategy to use. If you see that the current implieds are in the lower percentiles, then you might favor the backspread, because there is a better chance that implieds might increase while you have the position in place. On the other hand, if implieds are already near the high end of their historic trading range, then you might favor the call ratio spread, since it will profit if implied volatility declines.

When you trade the volatility skew in this manner, there are several ways in which you can profit. First, you would profit almost immediately if the volatility skew disappeared, because your options would then have the same implied volatility. That is a rather rare occurrence, but it sometimes does happen. Second, you would profit if the underlying were within your profit range at expiration. Third, you could profit if implied volatilities move in your favor (i.e., higher if you own the backspread or lower if you have the call ratio spread

in place). You may want to refer back to Figure 6.3 for another picture of the profitability of this strategy.

---

The summer of 1995 was a particularly good time for trading the volatility skew in grain options, even though grain prices rose during that time period. The skew was so steep that it presented traders with a good statistical edge. For Sep corn: 278, in early June 1995:

Option	Price	Implied Volatility (%)
Sep 280 call	13½	26.5
Sep 300 call	8	31.5

This is an unusually large difference in implied volatility for two options that are only two striking prices apart. Moreover, implied volatility was in the eighth percentile at the time, thus favoring the ratio spread strategy. Based upon the deltas of the options (not shown), we recommended that customers establish the following basic position:

Long 10 Sep 280 calls  
Short 16 Sep 300 calls

This position was established for a small debit of seven points (\$350, since one point in grain options is worth \$50). Thus, there was very little downside risk. The *upside* risk was theoretically unlimited if corn were to rise too far. The upside break-even point was approximately 332, so we placed GTC buy stop orders to buy six Sep corn futures at 332 as a means of limiting upside risk. However, since the profit potential was greatest if corn were at 300 at expiration, we were hopeful that the position could be removed for a profit if corn were to rally to 300.

Corn eventually rallied into the 295 area in mid-to-late July. The position acquired a nice unrealized profit at the time, and the volatility skew had dampened somewhat—27.5 percent for the Sep 280 call as compared to 30.7 percent for the Sep 300 call. Thus, the profit resulted from a flattening of the volatility skew *and* a favorable movement by the underlying. Also, implied volatilities were about at the same *absolute* level—in the high 20s—so that was not much of a contributor to the profit.

---

When trading the volatility skew with ratio spreads, I generally prefer to use an at-the-money option for the long side of the spread

and out-of-the-moneys for the short side of the spread. That is exactly the way the previous example is constructed. In this manner, we will normally have a profit if the underlying moves to the striking price of the spread. In fact, if the volatility skew has disappeared, or at least flattened somewhat, by the time that happens, we should have a very good profit.

It is always something of an art to decide when to take the profit, should it occur. If you are fortunate enough to have the underlying move to the striking price—as Sep corn did in the previous example—then you are tempted to leave the position as is, in order to capture even more profits should the underlying remain near that higher strike. What I recommend is to take one of these two actions: (1) take a profit on half of your position, or (2) set some mental stops that are close enough to the current price so that you will still lock in a good profit if they are hit.

---

Continuing with the same Sep corn example, we can demonstrate the usefulness of tightening mental stops when a decent unrealized profit has built up. By August 1, Sep corn had fallen all the way back to 280; and the options, which expired in mid-August, eventually all expired worthless, as corn was at 275 by that time. If there had not been an attempt to lock in some profits with mental stops, the entire unrealized profit would have been lost, and a loss equal to the initial debit would have resulted.

So, when corn was in the high 290s, we set mental stops at 290 and 310, intending to remove the position if either of those prices was hit. On the other hand, if corn were to remain between those two prices, greater profits would result. As we have already explained, corn fell in price, so we removed the position when it reached 290 and took a profit. It wasn't as large a profit as had been available when corn was near 300, but it was still a profit.

---

Of course, one example doesn't demonstrate an entire strategy. But to show that the volatility skew trading does give you a good advantage, I summarized our ratio writes from *The Option Strategist* newsletter over the past four years. All of these were based on volatility skews. There were 39 of them, 24 of which were profitable, 10 of which lost the small initial debit, and 5 of which suffered larger losses. Larger losses can arise from (1) increasing implied volatility,



(2) a gap much higher by the futures, or (3) a reversal in trend after an adjustment has been made (a “whipsaw”). None of the five losses was caused by a gap; rather, the cause was either a quick move resulting in exploding volatility or a whipsaw. The average position was held for 53 days, and the average profit on the 39 positions in this strategy was over 50 percent on an annualized basis, assuming that exchange minimum margin requirements were used. Thus, the ratio spread strategy can be quite profitable when employed in our stated manner: there is a forward volatility skew, and implied volatility is relatively high to begin with.

The companion strategy for the forward volatility skew, used when implied volatility is relatively low, is the put backspread. This strategy is used less frequently than the call ratio spread, partially because of the mechanics of the forward volatility skew itself. The only time that implied volatility drops in the grains is when prices have dropped. Since the put ratio backspread makes its best profits when profits drop even further, it is not often a viable strategy to establish at already-low price levels. However, it is a statistically viable strategy to adopt when the two predominant conditions exist simultaneously: (1) a forward volatility skew and (2) low implied volatility.

## **Trading the Negative Skew**

When implied volatilities are skewed in the negative direction, two strategies that are the exact opposite of the previous ones are appropriate: either (1) the *put* ratio spread (Figure 6.25) or (2) the *call* backspread (Figure 6.26). In these two strategies, we are buying the option at the higher strike, which has the lower implied volatility, and selling the option with the lower strike, which has the higher implied volatility. Once again, there is a statistical advantage, since we are selling an option that is “expensive” on the same security on which we are buying an option. If implied volatility is low, the call backspread is the preferred strategy; but if implied volatility is near the high end of its range, then the put ratio spread would be the better choice of a strategy to trade the reverse skew.

The reverse volatility skew is very prevalent in broad-based index options, although it wasn't always so (prior to 1987, there was a

**Figure 6.25**  
**PUT RATIO SPREAD**

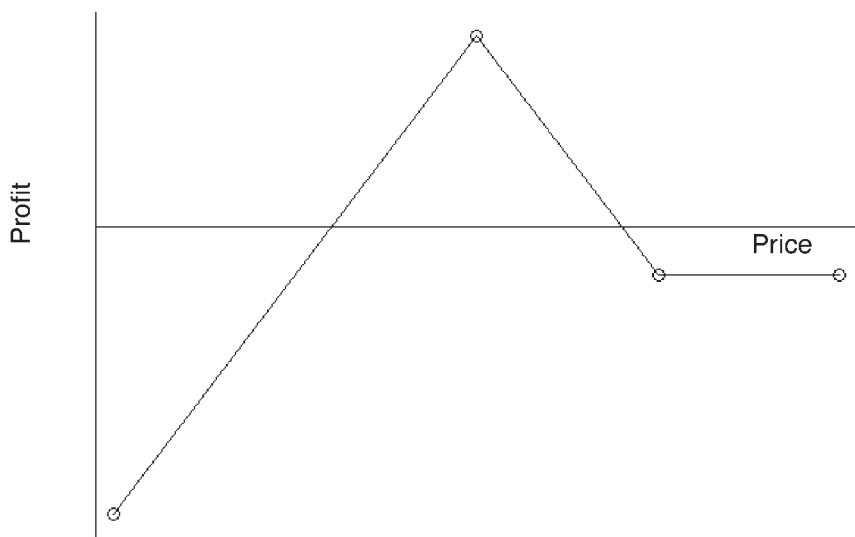

**Figure 6.26**  
**CALL BACKSPREAD**

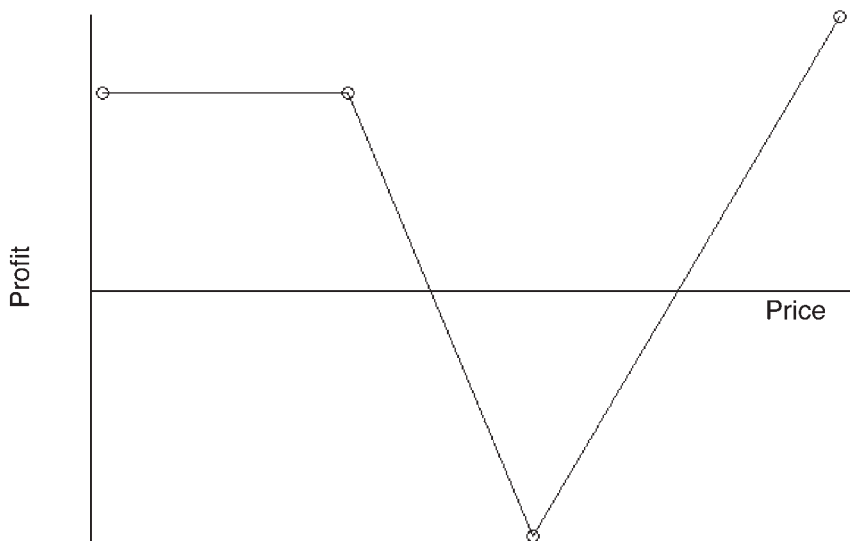

slightly forward skew), and it may therefore disappear once again someday. Nevertheless, it appears with some frequency in futures options markets that experience a sudden decline in price. In recent years, it has appeared in cattle, T-bond, and crude oil options. In these cases, the reverse skew disappears as soon as the underlying commodity stabilizes in price. However, with the broad-based options, the skew has persisted for years, mostly due to the margin and supply/demand factors that were discussed earlier.

In Chapter 4, we pointed out that when OEX implied volatility is low, straddle buying is a good strategy. However, we can now refine that statement because of the volatility skew: backspreads are the preferred strategy in OEX options when implied volatility is low and the reverse volatility skew is present. Since 1987, the call backspread in OEX options has served very well as a strategy with which to take advantage of the reverse volatility skew. This is partly due to the fact that OEX options have, for the most part, traded near the lower end of their volatility range. If you wait for those opportunities to establish the backspread, the rewards are worthwhile.

The subsequent story follows a backspread through several months, pointing out how to make adjustments, how to take profits, and when to close the spread.

---

In February 1995, the implied volatility of OEX options was relatively low. This can sometimes be considered a market sell signal, but it is better interpreted as a precursor of a market explosion in one direction or the other. At that time, the following data was pertinent, and backspreads were established for ourselves and our customers:

OEX: 455 on February 23, 1995

With OEX at 455, we would buy calls with a strike of 455 or 460 and sell calls with strikes of 445 or below. These options should generally have about three months or more of life remaining, so time decay won't be a major factor right away. In addition, I sometimes like to purchase some out-of-the-money puts in order to add some more downside potential to the position, particularly if the striking price of the calls that are being sold is relatively near to the current price.

Option	Price	Implied Volatility (%)
May 460 call	7	9.9
May 445 call	16½	11.7
April 445 put	3½	10.8

The basic backspread position that was established was:

Buy 20 OEX May 460 calls  
 Sell 10 OEX May 445 calls  
 Buy 10 OEX April 445 puts  
 Net debit: 10 points

The May 445 calls being sold were trading with a higher implied volatility than that of the May 460s being bought, the natural by-product of establishing a call backspread when there is a reverse volatility skew. In this case, I used the *April* puts for the extra downside potential because they were a cheaper price. In order to keep the calculations of credits and debits simple, we address commissions at the end of these examples.

Figure 6.27 shows how the position would look at April expiration with volatility still at the low end of the range (middle curved line), at April expiration with increased volatility (higher curved line), and if it dropped to 6 percent (lowest line).

The collateral required for a backspread is essentially the amount of risk; that is, if the underlying expired exactly at the higher strike at expiration, we would realize the maximum loss. That is the margin requirement. Stated in another manner, we must have collateral equal to the difference in the strikes for each of the short calls, plus we must pay for any debit involved. If the position is established for a credit, as is often the case, then the credit may be used to reduce the spread requirement. In this case, the difference in the strikes is 15 points (\$1,500); and since we have 10 bear spreads, the collateral required is \$15,000, plus the \$1,000 debit of the position.

Now, a position such as the one established in this example, is delta neutral to begin with but it has volatility risk *and* gamma risk—it is not gamma neutral. This means that as soon as OEX begins to rise, the position will become delta long; or if OEX should fall, the position will become delta short.

**Figure 6.27**  
**OEX BACKSPREAD—STAGE 1**

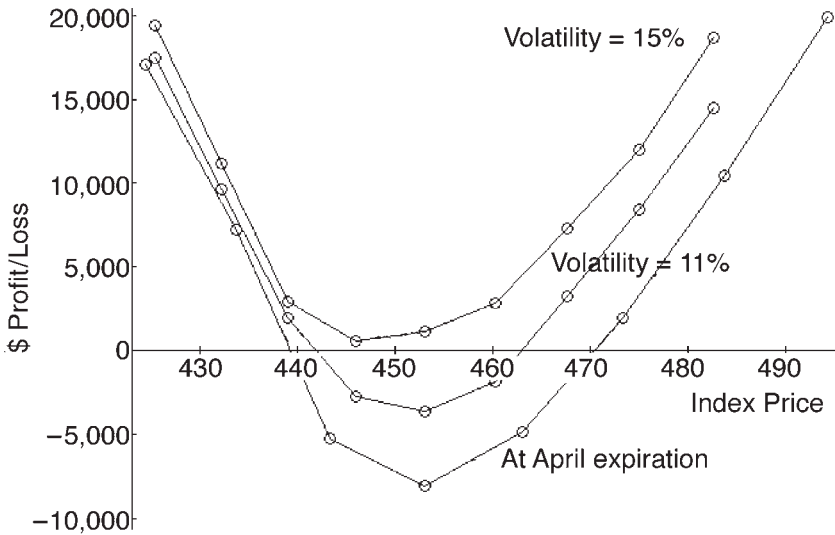

When OEX moves, we must decide how to adjust. This problem was addressed earlier when we discussed the handling of long straddle positions. When a volatility skew is involved, we must look at both the volatility skew and the level of implied volatility in order to determine what to do with the position.

If OEX moves up, for example, and the position becomes quite delta long, we will probably have a profit. If we don't do something and OEX subsequently falls in price, we will lose this profit. So, we would probably opt to take at least a partial profit if volatility has increased. However, if the volatility situation is about the same as it was originally, we might decide to reneutralize the position. This is quite easily accomplished with backspreads: we merely have to roll the long calls up to a higher strike. This action takes a realized profit on the calls we originally owned, while bringing a credit into our account. Furthermore, we are then positioned to make money if OEX subsequently falls or rises farther.

By the end of March, OEX had moved up to nearly 475, and the position was very delta long. Implied volatility had not really increased, nor had the volatility skew disappeared. In fact, this was the situation:

Option	Price	Implied Volatility (%)
May 475 call	7½	10.9
May 460 call	18	13.0
May 445 call	32	16.0

At first glance, it looks like implied volatility has increased substantially for the options that we own—and it has. But that increase is due to the volatility skew, not to any general increase in implied volatility. Notice that the now-at-the-money May 475 call has a volatility only slightly higher than the May 460s implied was when the position was established (10.9 percent as compared 9.9 percent). The volatility skew is what is causing the in-the-money calls (i.e., options with lower strikes) to have inflated implied volatility. We discuss this phenomenon in more detail later.

The fact that the at-the-money call was still cheap was the overriding factor in my decision to roll the calls up, rather than close the position, which at the time had an unrealized profit of about \$3,500 (the April 445 put was still selling for about one point). When rolling up, we should normally buy more than we sell in order to keep the position delta neutral. However, sometimes we're swayed by technical factors, and the market seemed overbought to us; so we only rolled an equal number:

Bought 20 May 475 calls at 7½ opening  
 Sold 20 May 460 calls at 18 closing  
 Net credit of roll: 210 points (\$21,000)

After this adjustment, the position is:

Long 20 May 475 calls  
 Short 10 May 445 calls  
 Long 10 April 445 puts  
 Net credit to date: 200 points

Figure 6.28 shows the adjusted position at April expiration. The lower curve on the graph shows the profits if implied volatility remains at the cur-

**Figure 6.28**  
**OEX BACKSPREAD—STAGE 2**

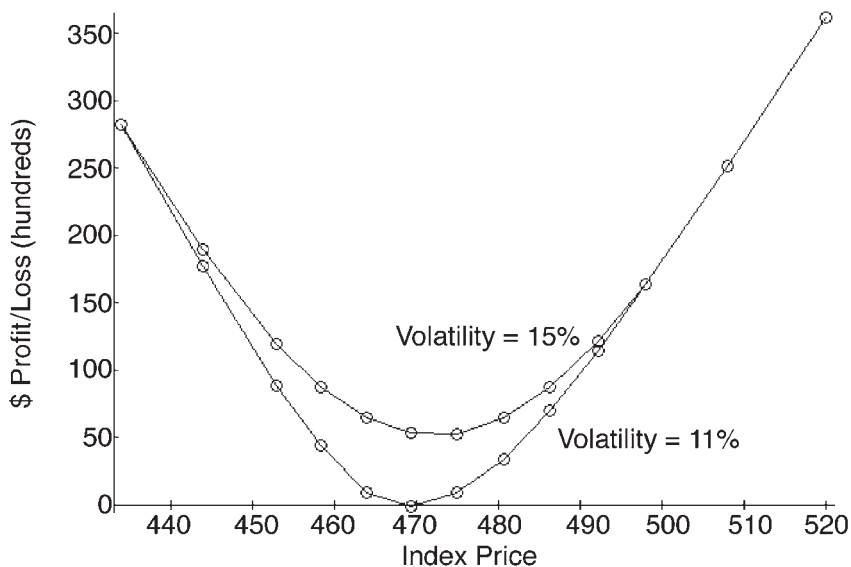

rent low levels, while the higher curve depicts the situation if implied volatility increases.

It should be pointed out that when we roll up, we increase our margin requirement. In this particular case, the difference in the strikes between the short calls and the long calls is now 30 points (\$3,000). We still have 10 of the call bear spreads in the position, so the collateral requirement is now \$30,000. Of course, the \$21,000 credit that was obtained when we rolled up can be applied against this increased collateral requirement.

In a totally theoretical situation, I would always encourage returning the position to a delta neutral status when an adjustment is made. However, in these examples, we're describing actual trading activity, and sometimes one modifies the theoretical approach in the heat of battle. A slight modification of this sort is a minor concession to my market opinion—it's not like abandoning the backspread strategy for a totally one-sided position.

In the larger context, I was wrong, of course, about OEX being overbought at that point in 1995—it rallied for the rest of the year, with only a couple of pauses for breath. However, over the next month, it *did* have some trouble advancing as it consolidated to work off its overbought state. This meant that expiration was about a month away. I don't like to hold long or at- or out-of-the-money options with that little time remaining, so it was time to make another decision.

---

OEX had crept up to about 479 by the third week of April, leaving only a month of time remaining on the long May 475 calls. Once again, implied volatility was fairly low, so the decision was made to roll out to June options and stick with the position for another month in search of the elusive increase in implied volatility. The following trade was made:

Bought 20 June 480 calls at 9 opening  
 Sold 20 May 475 calls at 9½ closing  
 Net credit of this roll: 10 points (\$1,000)

In addition, the April 445 puts had been sold for one point a couple of weeks earlier. Since the short calls were now so deeply in-the-money, there was no reason to buy another out-of-the-money put to add downside potential; the short calls were providing plenty of downside capability. These trades brought in a total credit of 20 points, leaving the position in the following state:

Long 20 June 480 calls  
 Short 10 May 445 calls  
 Net credit to date: 220 points

---

Even though the long options were rolled up to a higher strike, a credit was available because of the fact that OEX was just below the 480 strike and implied volatility was low. With three weeks to go, there wasn't much chance of an early assignment on the May 445 calls, but the possibility increased as expiration approached. However, in any OEX spread, should a trader receive an early assignment notice, he should either quickly sell another, longer-term contract in its place, or he should remove the other side of the spread. He



should *not* decide to become a market predictor; that tack is usually not a wise one.

It has been my general experience over the 13 years that OEX options have been trading that an early assignment is not necessarily an unprofitable thing. True, it is an *inconvenient* occurrence, and it makes a spread position assume a great deal of risk. That is why one should attempt to avoid early assignment. What I am saying, though, is that when I have received an early assignment notice, I have, on average, made money because the market moved favorably after the assignment. Perhaps those traders doing the exercising are doing so because of a short-term market opinion, and that opinion is wrong.

In any case, it is not wise to tempt fate. So with about two weeks to go until May expiration, OEX took off to the upside, and the following adjustments were made.

---

By the first week of May, OEX was in a fast-rising phase once again. It had rallied to above 490. This was a major move that again made the entire position delta long. Moreover, time was now getting quite short for the May options; the chances for early assignment were increasing with each passing day. In addition, implied volatilities had increased somewhat, although they were by no means expensive:

<u>Option</u>	<u>Implied Volatility (%)</u>
June 480 call	12.9
June 495 call	11.1

Finally, it should be noted that the unrealized profit of the position had now reached about \$7,500, less commissions.

Given the fact that the implied volatility of the at-the-money option was still as low as 11 percent, the decision was made to roll the position:

Bought 20 June 495 calls at 9 opening  
 Sold 20 June 480 calls at 20 closing  
 Net credit of this roll: 220 points (\$22,000)

Also, since expiration was approaching, the May calls were rolled to June calls. When the long calls are so far in-the-money, it is sometimes necessary to roll to a higher strike. The decision as to which short strike to use is usually based on two factors: (1) the time value of the short option that

you are considering rolling into, and (2) the collateral requirement—rolling to a higher strike reduces the collateral requirement.

Since there was a reasonable amount of time value premium in the June 445 calls (almost two points), I decided to keep the short strike the same:

Bought 10 May 445 calls at 53½ closing  
 Sold 10 June 445 calls at 54½ opening  
 Net credit of this roll: 10 points (\$1,000)

These adjustments brought more credit into the position:

Previous total position credit: 220 points  
 Roll of long calls: 220 points credit  
 Roll of short calls: 10 points credit  
 Net position credit to date: 450 points credit

This is a credit of \$45,000 dollars. But it is needed to reduce the collateral requirement, which grew again by rolling to the 495 strike. After this, the profit graph for the position at June expiration had improved, as shown in Figure 6.29 (straight lines). You can see that there is almost no area in which a loss can occur, although we would not want to give back the \$7,500 that the position is currently ahead.

The curved line shows the profit if implied volatility increases by the first of June. It again demonstrates the powerful influence that implied volatility could have were it to increase to 15 percent or so.

When expiration approaches, the long side of a backspread becomes a concern in terms of time value decay (assuming that the underlying is near the striking price of that long call). In addition, the short side of the spread becomes a concern because of early assignment possibilities. You must remember that the intent of the position continues to be to trade volatility. It is still low, so the decision is made to remain in a backspread position, rather than just close it out.

In the preceding case, the May options were rolled to June options. That one-month roll doesn't add much time value premium to the position. I have always felt that you need to investigate your objectives when rolling the long options. If you roll to the nearest available month, then you are playing it very tight to the vest. You are exposed to time value decay, but your cost for rolling is smallest (i.e., June options cost less than July options). Since I was still having

**Figure 6.29**  
**OEX BACKSPREAD—STAGE 3**

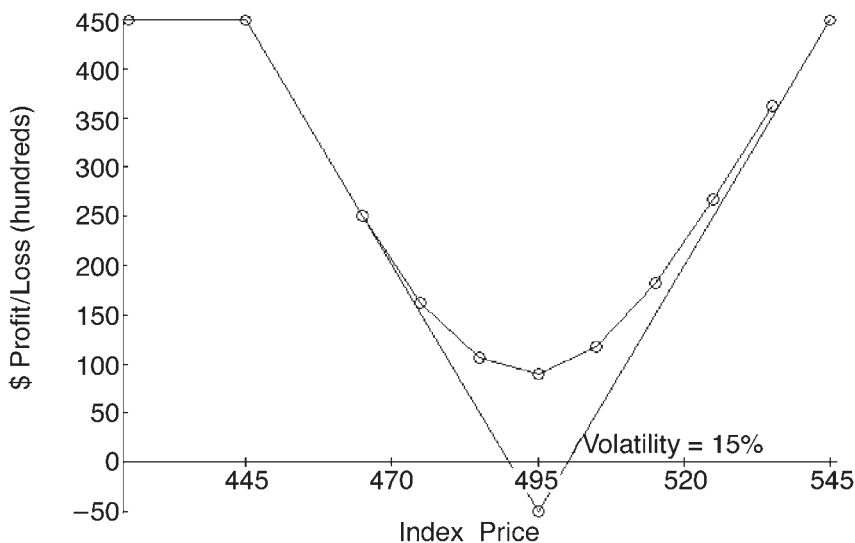

trouble believing that OEX could continue to advance at its then-current pace, I was keeping the rolls short-term, rolling merely from month to month.

OEX wasted no time proving quite clearly that I was misjudging its power. It rose to 505 by the first week of June. Grudgingly, implied volatility of the at-the-money options had increased as well—12.3 percent for the July calls. So, at this time, the position was 3½ months old and the implied volatility of the at-the-money calls had risen from 9.9 percent to 12.3 percent. This placed the current implied volatility in the fourth percentile, no longer cheap, but not expensive either.

The prices and volatilities of the options being considered were:

Option	Price	Implied Volatility (%)
June 495 call	13	13.4
June 445 call	61	n/a
July 505 call	10½	12.3

At this point, the entire position from inception had an unrealized gain of about \$9,000, less commissions.

Since the position had been working so well up until this time, I decided on a halfway measure: I would remove some of the position in order to nail down some profits but would continue to hold the remainder of the position to see if it could make even more money. The actual decision that I made was to take off a quarter of the position and to roll the balance to the July 505 calls.

This was the removal of one quarter of the position:

Sold 5 June 495 calls at 13 closing  
 Bought 3 June 445 calls at 61 closing  
 Debit on this trade: 118 points (\$11,800)

And this was the roll of the remaining longs calls out to July:

Sold 15 June 495 calls at 13 closing  
 Bought 15 July 505 calls at 10 opening  
 Credit on this trade: 45 points (\$4,500)

The remaining position was now:

Long 15 July 505 calls  
 Short 7 June 445 calls  
 Net credit to date: 377 points

This position had a collateral requirement of \$42,000 (seven bear spreads with a 60-point, or \$6,000, requirement for each one). The net credit to date of the position was now 377 points less commissions (it had been 450 points credit and was now reduced by the two trades just cited), so that amount could be applied against the collateral requirement.

After these trades, the position once again was approximately delta neutral, but was somewhat smaller. Figure 6.30 shows the potential at June expiration. It assumes that implied volatility remains unchanged at 12.3 percent. Note that the position can no longer lose any money at all, although it could give back some of the nearly \$9,000 in profits built up to date, if OEX were to stabilize near 505.

---

Perhaps in a more theoretical world, the entire position would have been removed before this last roll was made, since implied volatility had risen to 12.3 percent for the at-the-money options.

**Figure 6.30**  
**OEX BACKSPREAD—STAGE 4**

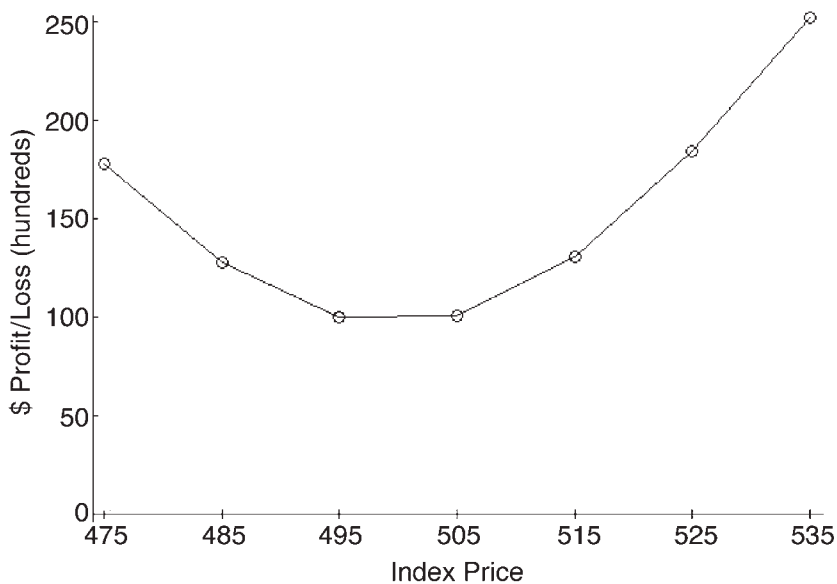

Perhaps it should have been. However, in the real world, we are constantly fighting the battle between theory and reality. Any good trader wants to cut losses and let profits run, even in a hedged position such as this backspread. Since the position had been working so well, I only removed a small part of it, electing to “let the profits run” if they could.

I don't think there's always a “right” and a “wrong” thing to do when managing a hedged position. In a long volatility position like this backspread, it's important to let the position have some room to move; but when the delta builds up too far, the position should be reneutralized. That had been done for this backspread position several times. As long as you are doing that and are mindful of a mental stop, then you are proceeding correctly. The mental stop keeps you from becoming too complacent about time decay. With the current profit at about \$9,000, a mental stop at about \$6,000 seems reasonable.

OEX moved higher over the next month, but then it began to run into some trouble. Moreover, there were some early assignments. The combination of these events “led” me out of the position. The following discussion concerns the handling of an early assignment.

---

As June expiration approached, the short calls were rolled forward to avoid assignment:

Bought 7 June 445 calls at 58 closing  
 Sold 7 July 445 calls at 60 opening  
 Credit for this trade: 14 points (\$1,400)

However, within a week, and with nearly a month remaining until July expiration, an early assignment notice was received on two of the July 445 calls. This was highly unusual, coming so far in advance of expiration. Even though the option was very far in-the-money, I still considered it atypical to be assigned a month before expiration. This assignment was received the morning after OEX had closed at 511.31. Thus, the price on the assignment was  $511.31 - 445.00$ , or 66.31.

There were actually quite a few OEX calls exercised that night. As has often been the case after early assignments, the market opened lower the next morning but then began to recover. In fact, by noon it was well into positive territory. As I said earlier, it has been my experience that this is a common event—early sell-off, followed by rally, after an OEX call exercise.

I had been feeling somewhat uneasy about not having taken a larger portion of the position off at the time of the last roll (to the July 505s). Therefore, I used this assignment as an opportunity to remove another piece of the position. I sold out five of the long July 505 calls. This trade occurred around noon of the day of the assignment.

Thus, the complete trade was:

Bought 2 July 445 calls at 66.31 closing  
 Sold 5 July 505 calls at 15 closing  
 Net debit for this trade: 57.62 points (\$5,762)

The remaining position, after the roll and assignment, was:

Long 10 July 505 calls  
 Short 5 July 445 calls  
 Net credit to date: 333.38 points

---

Handling an early assignment in the manner just described is somewhat risky. As I said, it has been my experience that the initial market sell-off caused by a fairly large OEX call exercise is quickly reversed. But sometimes it isn't. In those cases, you would fare worse by waiting to execute an offsetting trade against your early assignment notice. Therefore, if you decide to approach it in the manner that I did, by not selling something immediately on the opening (when everyone else is), but by waiting to see if there is a reflex rally, then you need to have an absolute mental stop in your head. The mental stop will keep you from "freezing" and holding on way too long.

A good rule of thumb is to see where the S&P futures are trading when the initial selling flurry, caused by the OEX call exercise, subsides. The S&Ps would normally be somewhat off their daily lows at that point. I often use this as a mental stop: if the S&Ps *then* make another daily low, I will sell what I need to, in order to balance my position. On the other hand, if a market rally develops, as was the case in the previous example, then I would look for a place to sell into the rally.

I would *not* change my overall strategy, though. For example, if the market was going my way, I would not attempt to remain overly "long" the market over a longer period of time. After an early assignment, you should return to a balanced position at some point during the trading day on which you received the assignment. If you are able to ride a rally and get a better price for your "resale," so much the better, but don't wait overnight to readjust the position.

---

OEX continued to rally—confounding me, who was keeping my position delta neutral. When it reached 520 in late June, the implied volatility of the August 520 call was only 11.6 percent. So volatility had actually decreased from the last time that a roll was made—into the 505s.

Therefore, I decided to stay with the position, and executed the following trade:

Sold 10 July 505 calls at 18 closing  
 Bought 10 Aug 520 calls at 10<sup>1</sup>/<sub>2</sub> opening  
 Credit on this trade: 75 points (\$7,500)

The total position was then:

Long 10 Aug 520 calls  
 Short 5 July 445 calls  
 Net credit to date: 408.38 points

The unrealized profit had grown to over \$12,000. *I moved my mental stop up to \$9,000; that is, if the position marked at \$9,000 on any day's close, I would exit the next day.*

---

This lengthy position was eventually terminated in August, but not before a couple more early assignments.

---

I received early assignment notices on back-to-back days in July. On the first one, I was assigned on all five of my short July 445 calls. I sold the Aug 445 calls that day, taking in a net credit on the roll. On the very next day, I was assigned on the *Augusts!* At that point, I decided that the only way to avoid these early assignments was to roll to a higher strike, so I sold the August 475 calls. I chose the 475 strike because the open interest was fairly large in that series. This last trade necessitated a debit because the strike was moved higher.

The net debit from these two early assignments was 127.45 points (\$12,745). This left the position as:

Long 10 Aug 520 calls  
 Short 5 Aug 475 calls  
 Net credit to date: 280.93

---

Eventually OEX rose to over 530 in late July, but then it began to slip in early August. Time decay was beginning to become a major factor, and a decision needed to be made as to whether to terminate the position or to roll it once again, this time into September or October options.

---

With OEX at 525, the implied volatility of the at-the-money September calls was 12.7 percent and the Octobers were 13.0 percent. Since the range of implied volatility had been shrinking all year, these numbers were in the fifth and sixth percentiles. Given that fact, plus the fact that time decay had



eroded the value of the long calls as OEX stabilized, I therefore decided to close the position:

Sold 10 Aug 520 calls at 8 closing  
Bought 5 Aug 475 calls at 51 closing  
Net debit of this trade: 175 points (\$17,500)

The net realized credit of position to date was 105.93 points, or \$10,593.

A total of 304 contracts had been traded. At a commission rate of \$4 per contract, that is \$1,216 in commissions. Thus, the net gain on the entire position was \$9,377.

---

The first criticism that a hedged trader usually receives is along these lines: he had to manage a relatively complicated position for six months, making numerous trades, and his net profit was \$9,377. Meanwhile, OEX had risen 70 points. Wouldn't he have been a lot better off just to hold the initial position or to have bought calls in the first place?

Of course he would have, but that's hindsight, and it is not what the goals were when the position was established. In reality, this position had an excellent rate of return and was hedged all the way along. Recall that the \$9,377 profit was on an initial investment of \$16,000, which represents about a 60 percent gain in six months. This is very attractive for a hedged position. Even more important, we were hedged at all times; if there had been a severe market correction, the short calls would have provided very good profit potential (just look at any of the profit graphs in this example).

So, don't confuse hedging with speculation. Yes, speculation has much larger rewards, but hedging is supposed to provide steadier returns. Moreover, when trading volatility with a hedged position, we have the added advantage of having a statistical edge built in.

This example was rather long, but it illustrated most of the decisions that the strategist needs to contemplate while such a position is in place: when and whether to roll the long calls up, when to roll the short calls, how to handle early assignment, and collateral and profit/loss considerations. As I said in the preface, I am often asked what I use to make decisions regarding establishing a position and in

follow-up action—how I decide which options to use, when to roll, how to handle early assignment, and so forth. Hopefully, the preceding example will answer some of those questions.

This concludes the section on using backspreads to trade the volatility skew. Obviously, not all backspreads work so well. However, the strategy is a very attractive one as long as you have a market where there is a volatility skew. I especially like the fact that you can use simple spreads (rolling up the long calls, in the preceding examples) in order to adjust the spread. This is a distinct advantage of a backspread as compared to a long straddle. With a straddle, when the underlying moves higher, your downside protection gets farther and farther away. The only way to reneutralize a straddle is to sell the entire straddle and buy a new one at the higher strike. I have found that, on average, I personally make better, more profitable decisions with the backspread than with the straddle.

## **Put Ratio Spread**

The put ratio spread is also a viable strategy for trading the reverse volatility skew. You buy puts at one strike and sell puts at a lower strike. Since the puts purchased have a lower implied volatility than the puts sold (because of the reverse volatility skew), this position has a nice statistical advantage, too. Many OEX traders use this strategy in one form or another because of the attractiveness of selling expensive out-of-the-money puts.

If you buy and sell an equal number of puts, you have a bear spread with a theoretical advantage. That's great; but if the market continues to rise, as it has for over five years, you don't make much money from the bear spreads. Money managers sometimes take advantage of this volatility skew to buy bear spreads to act as insurance for their long stock positions. Admittedly, the bear spread wouldn't provide complete insurance—it's only insurance down to the lower strike—but these money managers figure it's better than nothing, and it isn't so costly where there's a reverse volatility skew present.

The delta neutral version of the put spread is, of course, the put ratio spread—buying perhaps one at-the-money put and selling two out-of-the-money puts. Sometimes these put ratio spreads can even

be established for credits, when the volatility skew is steep enough. This means that you would profit unless the market dropped through the lower break-even point of the ratio spread before expiration. In fact, a modest decline by the market to the striking price of the written puts could produce very good profits.

---

Since the crash of 1987, it has not been at all uncommon to see prices such as these in OEX options. This particular set of prices was recorded at the end of a very volatile day in the market, which saw the Dow up 35 in the morning, then down 90 points in the afternoon, before rallying 35 points late in the day to finish -20 for the day. The skew is usually quite pronounced after a day like that—which contains a big downdraft—and it is invariably a good time to establish these put spreads.

#### OEX: 587 on January 4

Option	Price	Implied Volatility (%)
Feb 550 put	1.81	16.6
Feb 555 put	2.19	16.0
Feb 560 put	2.69	15.4
Feb 565 put	3.19	14.6
Feb 570 put	4.13	14.3
Feb 575 put	5.00	13.7
Feb 580 put	6.38	13.2
Feb 585 put	7.88	12.6

You can see the nice, uniform pattern of implied volatilities increasing as the strikes get lower. This is a classic reverse skew.

What is very interesting is that you can buy almost any one of these puts and sell two of the puts with a striking price 15 points lower, and still take in a credit. This makes a very attractive put ratio spread. For example, if you bought one Feb 585 put at  $7\frac{7}{8}$  and sold two Feb 570 puts at  $4\frac{1}{8}$ , you would take in a credit of  $\frac{3}{8}$  of a point. This might only be enough to cover commissions, but it is a very attractive spread, theoretically: the option you are buying has an implied volatility of 12.6 percent, while the ones you are selling are trading with a 14.3 percent implied. That is a large discrepancy.

The downside break-even point on this one-by-two ratio spread is about 565, which is 22 points below the current OEX price. That's plenty of downside cushion.

---

A put ratio spread strategy can be operated much like the call ratio spread strategy that was described earlier with an example using corn options. In the put spread, usually no action is necessary if the index rises. However, if the index declines, you would normally have a profit if the underlying gets down to the striking price of the puts that were sold (the exception would be a quick decline, and we'll get to that in a minute). At that point, you can decide if it is best to take some profits or to narrow your action points to protect the profits you have.

The put ratio spread strategy consumes a lot in the way of collateral requirements, so it is best used by traders who have excess collateral in their accounts. Each naked index put requires collateral in the amount of 15 percent of the index value, plus the put premium, less any out-of-the-money amount (if it's out-of-the-money). This can be expensive, although collateral can be equity in your account—it does not have to be cash. Thus, the excess value of your stocks and bonds can be used to finance this strategy.

The problem with the put ratio spread strategy is that everyone remembers the days on which this strategy was particularly poor, the crash of 1987 and the 1989 crash caused by the United Arab League (UAL) leveraged buyout falling apart; then there was the 1990 Iraq-inspired bear market. Admittedly, those were nasty times, but you could have hedged yourself so as to prevent disaster.

---

In the UAL-induced crash of 1989, I had OEX put ratio spreads in place. However, I was able to hedge them with futures even as the market was plunging. As long as the market is open and doesn't gap through your downside, you can protect yourself.

The downside breakeven was about 316, with the OEX index trading at levels above 330. Then, on a quiet Friday afternoon—some self-employed traders had already gotten bored with the market and had gone home—news came out that the UAL deal was going to collapse. UAL itself had been trading at 249 and was halted at 243 due to an order imbalance.

The stock market, though, knew what was coming and headed south—fast! OEX fell over 20 points that afternoon, to close just below 310 (the Dow was off 190 points). OEX put premiums ballooned, and there were several trading halts and rotations. No one can adjust a position in the midst of a trading halt, and to attempt to trade in a rotation is an exercise in masochism.

The S&P 500 futures were open for trading, though, and they were available as a convenient hedge. When the market approached the downside break-even point of the spread (316), enough S&P futures were sold to eliminate the downside risk—one future was sold for every five net naked puts in the ratio spread position. This turns the naked puts into covered puts, in effect, even though the S&P 500 and OEX aren't exactly the same thing. Usually, though, the two indices perform in concert; and when you need a hedge of last resort, you can't be picky about something like tracking error.

---

Thus, you can use the S&P futures as a hedge for OEX positions. If OEX is free trading, that wouldn't be necessary. But if the Chicago Board Options Exchange (CBOE) declares fast market conditions in OEX, I would look to the futures as a hedge. You pretty much always know where the futures are trading; and while they *do* have limits, they are more flexible in fast markets than trying to get an option order executed. It should be noted that once you have sold the futures as a hedge, if the market changes direction and heads back up again, you could have risk if it rallies above the striking price of your short puts. Of course, this is a problem with any adjustment against short options in any strategy—you can be whipsawed. There is no easy remedy when it occurs. You just have to try to reduce your risk by executing closing trades to remove the short put/short futures position.

## **A Volatility Skew Biases a Position**

It is quite true, but not necessarily intuitively apparent, that when the options in a position have a volatility skew, that position is biased. If the skew is a reverse one—à la OEX options—then the position has a bullish bias: it will do better when OEX rises in price than would be normally expected, and it will do worse on the downside. On the other hand, if there is a positive skew, like grain options have, then the position has a bearish bias: it will do better on the downside than you would think.

These biases will persist as long as the skew exists. If the skew disappears, then the position will behave “normally.” The profit

graphs in the previous examples, designed to show how to trade the volatility skew, had the volatility skew built into them. Any trader relying on profit projections generated by a computer must be sure that the computer program doing the projections knows if there is volatility skew or not and, if there is one, accounts for it in the profit forecasts.

---

To verify that a reverse skew puts a bullish bias in a position, consider the OEX backspread example that we have just examined. When the position was established, we had the following situation:

**OEX: 455 in February**

<i>Position</i>	<i>Implied Volatility (%)</i>
Long 20 May 460 calls	9.9
Short 10 May 445 calls	11.7

Later, in March, OEX had rallied, and we saw that the following implied volatilities were then evident:

**OEX: 475 in February**

<i>Position</i>	<i>Implied Volatility (%)</i>
Long 20 May 460 calls	13.0
Short 10 May 445 calls	16.0

Both options' implied volatility had increased because they were now both in-the-money options. Remember that the deeper an option is in-the-money, when you have a reverse volatility skew, the higher is the implied volatility of that option.

The increase of implied volatility from 9.9 percent to 13.0 percent on the 20 calls that were long aids the position. Conversely, the increase in implied volatility from 11.7 percent to 16.0 percent on the 10 short calls hurts the position. Overall, though, the increase in implied volatility on 20 long calls is more dominant than the increase in volatility on the 10 short calls. Thus, the position has been aided by the fact that OEX rose in price while the volatility skew was still in place.

If you would prefer to see actual prices to verify this bias, look at the following table:

Position	Price	Implied (%)	Profit/Loss (\$)
<i>Original</i>			
Long 20 May 460 calls	7	9.9	
Short 10 May 445 calls	16½	11.7	
<i>One month later</i>			
Long 20 May 460 calls	18	13.0	+22,000
Short 10 May 445 calls	32	16.0	-15,500
Total Profit			+6,500

However, suppose for a moment that there was no skew in evidence and that the options retained their original volatility as OEX moved higher. Then the following situation would have existed one month later (according to our option model):

	Price	Implied (%)	Profit/Loss (\$)
Long 20 May 460 calls	17	9.9	+20,000
Short 10 May 445 calls	31	11.7	-14,500
Total Profit			+5,500

No increase implied; one month later position.

The presence of the volatility skew, which caused the implied volatility of the in-the-money options to increase, resulted in the position making \$6,500 instead of the \$5,500 it would have made if implied volatilities had remained as they were when the position was established. This \$1,000 increase in profit is the bias attributable to the volatility skew.

In a similar manner, we could show, but won't bother going through the details, that a forward skew biases a position in a bearish manner. Thus, a seemingly neutral position in soybean options, for example, will do *worse* than expected if soybeans rise in price.

We point this out so that you will not be surprised when these results occur in your positions. As stated earlier, a computer program that correctly incorporates the skewing into profit projections will give you these accurate results. You may also want to anticipate this effect when you construct your initial position. For example, if you determine that an OEX backspread is neutral with 20 long calls and

10 short calls, you know that the position will outperform on the upside and underperform on the downside. Thus, you might want to buy only 18 calls while selling 10. This would compensate for the volatility skew's effect.

## Finding Where Volatility Skewing Exists

Having discussed *how* to trade the volatility skew, it is also important to know *where* to find one. The easiest method seems to be to compute the statistical standard deviation of the individual striking prices with the same expiration date. That is a simple computation, which we show by example momentarily.

First, though, let's define *standard deviation* for those who are not familiar with the term. In order to determine the standard deviation of a group of numbers—implied volatilities of individual options, in this case—you first find the average of the group of numbers. Then, for each number, you (1) subtract that average from the individual number and (2) square the result of step 1. You add up all these squares and, at the end, divide by how many were in the group, less one. Then you take the square root of that final result. What is left is called the *standard deviation*. For the purposes of volatility skewing, we compare that final result with the average implied volatility to see if it is significant.

Mathematically, the formula, for the standard deviation of a group of  $n$  numbers, is as follows. The symbol for percent standard deviation is  $\sigma$ :

$$\sigma = \frac{\sqrt{\frac{\sum(V_i - \mu)^2}{n - 1}}}{\mu}$$

where  $V_i$  = implied volatility of an individual option

$\mu$  = average of all the  $V_i$

$n$  = number of items in the group

The following example shows the actual calculations used to determine the standard deviation of March soybean options on a par-



ticular day. You will be able to see, with your naked eye, that there is a volatility skew here; but our intention is to prove, mathematically, that there is one. In this way, you can have a computer program look for these skews.

The following example is concerned only with March soybean options. The prices are closing prices.

**March Soybeans: 758<sup>3</sup>/<sub>4</sub>**

Strike	Call	Put	Implied
700	59 <sup>3</sup> / <sub>4</sub>	1 <sup>3</sup> / <sub>8</sub>	15.39
725	38 <sup>1</sup> / <sub>2</sub>	5 <sup>1</sup> / <sub>4</sub>	16.33
750	24	15 <sup>1</sup> / <sub>4</sub>	18.93
775	14 <sup>3</sup> / <sub>8</sub>	31	20.74
800	8 <sup>3</sup> / <sub>4</sub>	50	22.70
825	5 <sup>1</sup> / <sub>2</sub>	n/a	24.65
850	3 <sup>3</sup> / <sub>4</sub>	n/a	26.91
875	2 <sup>1</sup> / <sub>2</sub>	n/a	28.67
900	1 <sup>5</sup> / <sub>8</sub>	n/a	30.00

Note that there are nine items in this group (i.e., nine different striking prices in the same expiration month, for which we have computed the implied volatility).

First, we compute the average of these nine implied volatilities, which comes to 22.70. Now, we subtract that average from each of these implieds, and we square that result:

Strike	Implied	Difference from Average	Square of Difference from Average
700	15.39	-7.31	53.45
725	16.33	-6.37	40.62
750	18.93	-3.78	14.26
775	20.74	-1.96	3.84
800	22.70	0.00	0.00
825	24.65	1.95	3.79
850	26.91	4.21	17.74
875	28.67	5.97	35.64
900	30.00	7.30	53.26

Now, we add up the “squares of difference,” the right-hand column in this table, and get 222.61. The standard deviation is

$$\begin{aligned}\sigma &= \sqrt{\text{“Sum of squares of difference”} / (n - 1)} \\ &= \sqrt{222.61 / 8} \\ &= 5.275\end{aligned}$$

Finally, we express the standard deviation as a percentage of the average implied volatility:

$$5.275/22.70 = 23.2\%$$

The idea behind using the standard deviation is to see if there is a large distance between most of the implied volatilities of the individual options and the average volatility. A “large difference” is usually defined by the final percentage being over 15 percent. In this example, the final percentage is 23 percent; so we can definitely say, mathematically, that there is a volatility skew in these March soybean options.

You will normally find volatility skews only in index and futures options. It is rather rare to find them in equity options, although occasionally you will see one in a takeover stock situation.

## THE AGGRESSIVE CALENDAR SPREAD

Before concluding this chapter, we present one more strategy. It is related to volatility but isn’t technically a volatility trading strategy. In fact, in this strategy, which is a calendar spread strategy, we want volatility to remain the same (or go higher), as we would with any calendar spread. The difference here is that this position is established when implied volatility is already high—a dangerous move for a calendar spreader. However, offsetting that risk is the fact that this is a very short-term strategy, so a position is not in place for more than a few trading days. This often helps to mitigate the risk that implied volatility might collapse while the position is in place.

When takeover rumors surface, implied volatilities tend to skyrocket. Strategists often look for ways to sell the extremely expensive short-term options while hedging themselves with either stock or a longer-term option. The following true-life example demonstrates the situations that we often find in these cases.

---

In the late spring of 1994, there were takeover rumors surrounding the stock of American Medical Holdings (symbol: AMI). The stock was trading at 25, and the following prices prevailed, with about two weeks remaining until June expiration:

**AMI: 25**

Option	Price	Implied Volatility (%)
June 25 call	$1\frac{1}{2}$	105
July 25 call	$2\frac{7}{8}$	95

The near-term option is often much more expensive than any longer-term option when takeover rumors are “hot.” AMI was a typical situation in that regard.

---

On the surface, the calendar spread is an attractive strategy because it has limited risk no matter what happens. It is often a strategy that we are tempted to establish in high-volatility options because it seems that the risk is small compared to the possible expansion that the spread would undergo if “nothing” happened.

However, the calendar spread strategy in this situation is extremely dependent on implied volatility remaining inflated. If the implied volatility collapses for one reason or another, the strategy will almost surely lose. One way to increase your odds is to establish the calendar spread when there is a *very* short time remaining until expiration, perhaps as little as a week or 10 days. In that case, there is less of a chance that the rumors will dissipate in so short a time, and therefore there is more of a chance that the strategist will be able to capture the decline in premium of the expensive short-term option, while the longer-term option retains its high implied volatility. If that were to happen, the spread would widen and produce a nice profit very quickly.

Any short-term option strategy is a risky one. When you are operating any strategy with so short a time horizon as one week or less, you would have to consider that a speculative strategy. Speculation is not necessarily bad, but you must understand that even though you are hedged, a big swing in returns can occur in the course of one week in this situation.

If a takeover bid is made during the week in which you are holding the calendar spread, there is a significant chance that both options will trade at or close to parity and that the maximum loss—equal to the initial debit paid for the spread—will be realized. A similarly poor result could occur if the stock collapsed during the ensuing week, perhaps on an evaporation of the rumors.

Figure 6.31 is a graph of a 10-lot calendar spread in the aforementioned AMI options. The spread was established with exactly a week to go until expiration. It shows two scenarios. The first is if implied volatilities remain high: rumors still abound, but no actual news is forthcoming. This ideal situation is represented by the higher, profitable, curve on the graph. The second situation is if implied volatilities collapse to the 30 percent level, as represented by

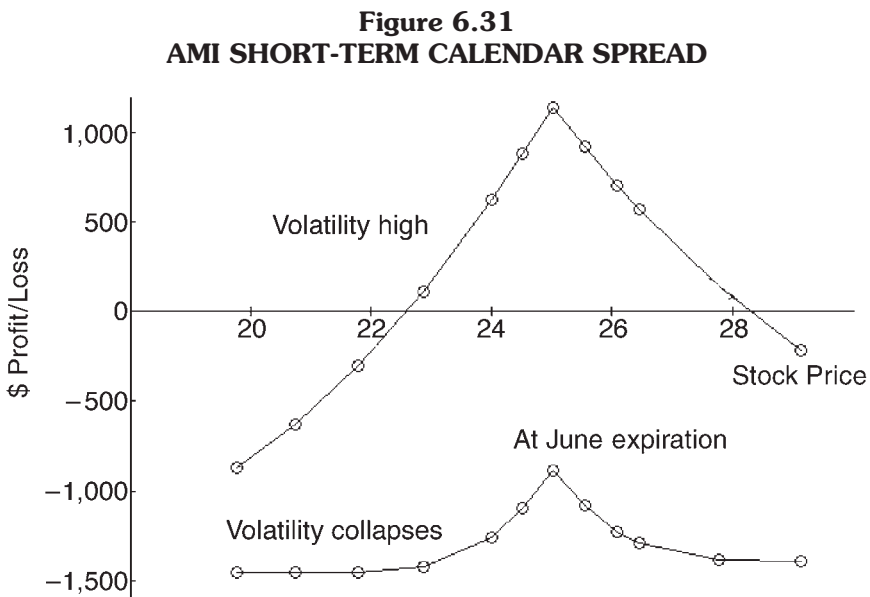

the lower curve on the graph. The two curves are so far apart that it appears they are depicting two totally unrelated strategies; *but they are not!* Notice that, even at its best result, the spread would lose nearly \$1,000 if volatilities collapse, whereas it could make as much as \$1,000 if volatility remains high and AMI is near 25. This picture graphically depicts the risk/reward aspects of this strategy. Of course, the hope is that the shortness of time that the spread must be held will mitigate the chances of the profits falling on that lower curve.

This type of calendar spread should be removed on the Friday of expiration of the near-term option. It could conceivably be removed slightly earlier if the stock were very close to the strike and the spread had widened. You will probably find, however, that the near-term options will continue to have a large premium (implied volatility) right up to the end, as speculators hope that a takeover bid will come before expiration Friday. This means that you will probably not have much of a chance to remove the spread early.

This strategy could be employed in any case where stock options are trading with an extremely inflated volatility. The only two ingredients would be that the stock is trading fairly close to the striking price when you establish the spread and that there is a reasonable chance that no news will occur before expiration. This latter criterion would rule out situations where an earnings report, court verdict, or FDA decision, for example, was scheduled to be handed down right before expiration.

## **USING PROBABILITY AND STATISTICS IN VOLATILITY TRADING**

So far, a number of strategies have been discussed—from the simple approach to the more complex. You might well be asking, “How can I tell which ones are best in which situations?” It is true that we have given guidelines for when to buy volatility or when to sell it, and so forth. But what about times when there are several volatility buying situations that you are considering. How can you decide which is the best? The answer to questions such as these lies in probability and statistics. With what is called an “expected return,” we can rank

strategies and compare them with each other—or just compare them with acceptable market returns at the time.

We will show how to compute expected return shortly, but first let's describe what expected return *is* and what it is *not*. It *is* a useful tool in deciding which positions have the best chance for success; it is *not* a guarantee of success. If we say that the expected return from buying a certain straddle is, say, 42 percent, you might be quite excited—42 percent is a very good return on your money, no matter what the position is; but it's especially good for a strategy with limited risk, like a straddle buy. However, there is no guarantee that in this one case, this position is going to make 42 percent. It could lose 100 percent, as all straddles can. It could fail to reach the breakeven and lose a smaller amount. What expected return measures is this: if you were to invest in this same strategy many times, with the same volatility and the same option prices, then over time you should average 42 percent for the trade. Now, in reality, you won't have the opportunity to invest in this same straddle many times in your lifetime, but you *will* have the opportunity to keep investing in positions with high expected return. And that's all you can ask. If you constantly establish positions with high expected returns, you should eventually have above-average returns—if your analysis has been done correctly.

What does this have to do with probability and statistics? The expected return incorporates the expected stock price movement (i.e., the probability of the stock being at each of the prices over an expected range). This calculation is, of course, dependent on volatility. And it becomes very important to have a good volatility estimate or perhaps to look at several volatility estimates before deciding on what the expected return actually is.

You can also use probability calculators to get certain probability conclusions, in addition to the expected return. These can be especially important for volatility sellers—where they might be forced to make an adjustment to the position during its life. Any adjustment would alter the expected return, of course, and so we'd like to know what chance there is of that occurring.

---

In 1989, as October expiration was about a month away, the market seemed range-bound and was trading quietly. OEX options seemed slightly

overpriced, with an implied volatility nearly 20 percent and OEX trading near 166. A naked strangle—the Oct 175 calls and the Oct 160 puts—could be sold for 2.60. The expected return was good, and the probability that the stock would finish within the breakevens—above 157.4 and below 177.6—was quite high. The strangle was sold, and OEX closed at 162.20 on October expiration. So the maximum return was realized, right?

Not so fast! A week before expiration, UAL backed out of a takeover deal and caused a minicrash in the market. On a quiet Friday morning, one week before expiration, OEX was trading at 165. But then when the market crashed, it fell to 154.30 that afternoon and fell further to 152.10 the next Monday morning, before prices rallied the rest of the week.

A naked strangle seller would surely have made some adjustment on the Friday afternoon or Monday morning when the market was collapsing. In fact, he might have covered his short puts at a high price, since implied volatility skyrocketed while this was happening. So later, when OEX rallied back to 162 (back *inside* the original profit range), he might not have been a participant any longer.

What this trader really needed to know—before establishing the position—was the probability that the index would exceed the break-even points *at any time* during the life of the position, not just the probability at the end of the options' life.

---

So these are the kinds of things that probabilities and statistics can provide us. Let's delve further into this so that you can see how these can be used. Let's discuss probability calculators first, and then we can see how they apply to expected returns.

The simplest probability calculator gives the probability of the stock being at a certain point at the end of some time period—typically at the end of the options' life in some position you are considering. The more sophisticated type of probability calculator can give you the probabilities of the stock exceeding a certain target price (or prices) at any time before expiration. Both calculators are provided on our web site, [www.optionstrategist.com](http://www.optionstrategist.com). The simpler version is free and can be accessed by anyone. The “ever” probability calculator is available only to members of The Strategy Zone on our web site, although we do also sell it as a stand-alone piece of software on CD-ROM. The formulae for these calculators are not being supplied in this book.

Let's look at how you might use them. To do so, we will return to the OEX example just presented—the one in which the market collapsed when UAL pulled out of a takeover bid.

---

The following prices existed:

OEX: 166	Oct 175 call: 1.00
	Oct 155 put: 1.60

Note that the implied volatility of the put is higher than that of the call, reflecting the typical reverse skew that has existed in OEX option since the crash of 1987.

Using a simple probability calculator, assuming a lognormal distribution, these are the inputs required:

Stock price: 166  
 Upside target: 177.6  
 Downside target: 152.4  
 Volatility estimate: 20%  
 Length of study: one month

The simple probability calculator says that the probability of ending above the upper break-even point of 177.6 at expiration is 9.7 percent, and the probability of ending below the downside break-even point of 152.4 is 15.4 percent. If you add them together, there is a 25.1 percent chance that the stock will close beyond one limit or the other. If this were an option *buying* strategy, that might be sufficient information to act on. However, since this is a naked option position, we really need to know the probability of the OEX *ever* trading beyond the break-even points *at any time* between the initial date and expiration. Those probabilities are as follows:

Probability that OEX ever exceeds the upside (177.6) = 26.1%  
 Probability that OEX ever exceeds the downside (152.4) = 15.9%

Together, then, there is a 42 percent chance that OEX will exceed one or the other of the break-even points. This is too high a probability; there is too much risk of having to make an adjustment. I generally want to see the “ever” probability be 25 percent or less for selling strategies. So the trader should sell farther out-of-the-money options to lower the probabilities of having to adjust the position while it is in place. If those farther out-of-the-



money options are so low in price that the overall return is minimal, then this position should be passed over, and the trader should look for other opportunities.

---

Note that we had to enter a probability estimate as input to the probability calculator. This is always a very crucial input. I generally use historical volatility for this input and tend to take a conservative approach. By that I mean that if you are looking at an option buying strategy, then use a low volatility estimate in your probability calculator. However, if you are considering the sale of an option or a strategy with negative vega, then use a high volatility estimate. By using this approach, you will be “penalizing” your probabilities, which is sort of a worst-case scenario. You then won’t be overstating your potential profits. In fact, you may be understating them, but that’s okay because your actual results may then exceed the projections.

In straddle buying situations, you would want to see a high probability of success—80 percent or more. In fact, you might even want to calculate the probability that the underlying moves *past* the break-even price by a reasonable amount—an amount large enough to allow you to make a good profit. For example, if the stock is 50 and a straddle costs 5 points, you might want to calculate the probability of the stock rising to 56 or falling to 44—one point *more* than the break-even points. If that probability is 80 percent or higher, then you have found a good straddle to buy.

Many strategies have break-even points; even calendar spreads do. For example, look at the graph in Figure 6.7 or Figure 6.31. You can clearly see that there is an upside and a downside break-even point in a calendar spread. Most traders are not too concerned with making adjustments at the break-even points of a calendar spread, for the strategy has limited risk inherently. However, you *can* use a probability calculator and the break-even points to determine the probability of making money. Certain assumptions have to be made in order to do this, but again you can adopt a sort of worst-case estimate and arrive at a reasonable projection.

---

These prices existed in early 2004. With IBM at 92, you are considering the following calendar spread, for a debit of 1.90:

Buy July 95 call: 3.30  
 Sell Apr 95 call: 1.40

On this particular day, the various volatility measures were:

	<i>Percent</i>
Today's composite implied	28
20-day historical	26
50-day historical	25
100-day historical	22

If you assume that the underlying will conform to the *lowest* of these volatilities, you are being conservative (high volatilities are an *aid* to calendar spread profits). In this case, using a 22 percent volatility, the break-even points in the spread would be about 90.5 and 100.7 at April expiration—the time value remaining in the July option would be 1.90 at those prices.

Now, we can use the probability calculator to determine the probabilities of IBM being above 90.5 and below 100.7 at expiration. The “end-point” calculation is sufficient here; the “ever” probability calculation is not required. Again using a volatility of 22 percent in the calculation, we find the following:

Probability of IBM closing above 100.9 = 8%  
 Probability of IBM closing below 90.5 = 41%

By inference, then, the probability of IBM closing *between* the two—in profitable territory for this calendar spread—would be 100 percent minus 49 percent (the sum of those two probabilities), or 51 percent.

This isn't a great probability of profit. There are likely others that are better on this day, but at least one has a good handle on his chances of making a profit.

The use of probabilities in calendar spreads can even extend further. We could approximate the odds of making the maximum profit by computing the probability of being within, say, a half point of the strike at any time during the last couple of days of life of the position. If the stock was that close to the strike with that little time remaining, the calendar spread would be nearly at its maximum value.

Probability calculations can be made in similar manners for nearly every strategy. They are a useful guide, but not the ultimate one. For example they are useful in a simple strategy like covered writing, because we could compute the probability of making the maximum return (i.e., being called away), the probability of losing (or making) money, and even the probability that the covered write will outperform or underperform simple stock ownership. For backspreads, we could compute the probabilities of making money, of losing the maximum amount, and so forth.

All strategies can be assessed in this manner—ratio spreads, backspreads, diagonal spreads, even simple call or put purchases. But what does the probability really tell us? It can tell us when we're considering an unfavorable position; but when the probabilities are good, that *still* doesn't necessarily mean we'll be making a good return. Some traders, though, would rather have an extremely high probability of making money—even if it's a small amount of money—than have the optimal return strategy. For a simple strategy like covered writing, this would mean writing deeply in-the-money calls that might have probability of success of 90 percent or higher; but perhaps the return is low—in the single digits. Even calendar spreaders could opt for high-probability spreads, which might not yield large profits, however. So, probability analysis is interesting but not as complete as the expected return, which we are now ready to discuss.

## EXPECTED RETURN

In theory, an expected return analysis is the ultimate form of analysis. It encompasses all of the things we've discussed: volatility, probability, and profitability. By inference, it can also show you what delta, gamma, theta, and vega perhaps cannot—how profits look when the stock makes a big move.

To compute an expected return, we first must estimate the prices at which the underlying is going to trade at the end of the study length. Usually the study length is the time to expiration, but it might

be a different time length in certain, specific circumstances. Rather than trying to guess at the prices at which the underlying will trade, one normally makes the assumption that it moves in accordance with standard price distributions—lognormal distribution, most likely. However, it is certainly acceptable to insert other distributions. For example, if a stock has received a takeover bid, but there are chances that (1) the deal could fall apart or (2) a higher bid could be received from another bidder, then that particular stock is certainly *not* going to move in accordance with a lognormal distribution, at least not until the takeover matter has been concluded.

---

Let's use a simple strategy so that the concept of expected return can be exemplified—a covered call write. It is often the case that expensive options are found in pharmaceutical stocks that are about to announce trial results of drugs in development or are about to meet with the FDA to gain approval to manufacture or sell a new drug. Such was the case with NeoPharm Inc. (NEOL):

NEOL price: 20.75, in March

July 17.5 call: 5.5

100-day historical volatility: 60%

Covered write net investment =  $20.75 - 5.50 = 15.25$

This call provides a lot of downside protection, yet it still has a healthy amount of time value premium (2.25 points). So it appears that it offers both a decent return and decent downside protection. However, the stock is volatile, so it is unclear just how much protection 5.50 points really is.

To compute expected profit, we estimate where the stock would be, the probability of it being there, and multiply that probability times the profit at that price. Then we divide the expected profit by the investment to get expected return. Commissions will not be included in this example.

The following table shows the pertinent items, assuming a lognormal distribution of NEOL stock price. Using a 60 percent volatility, a drop of two standard deviations in one-third of a year (from March to July) would put the stock down to 10.30; a rise of two standard deviations would put the stock all the way up to 41.80. So let's divide up that spectrum—10.30 to 41.80—into seven parts and calculate the results:

<i>Stock Price</i>	<i>Probability</i>	<i>Profit</i>	<i>Probability × Profit</i>
10.30	0.023	-4.95	-0.11
14.80	0.144	-0.45	-0.06
19.30	0.251	+2.25	+0.56
23.79	0.235	+2.25	+0.53
28.29	0.160	+2.25	+0.36
32.78	0.092	+2.25	+0.21
37.28	0.049	+2.25	+0.11
41.78	0.023	+2.25	+0.05
<b>Sum:</b>	<b>0.977</b>		<b>+1.65</b>

Hence, the expected profit is 1.65 points, the investment is 15.25 points (assuming the covered write was executed in a cash account), and, thus, the expected return is the division of the two, or 10.8 percent, not annualized.

In reality, we would evaluate many more than seven data points. I generally scan the spectrum from -3 standard deviations to +3 standard deviations, dividing it up into 40 parts or more. But even this simplistic approach (seven data points) provides a reasonable approximation of the expected return.

As mentioned earlier, we cannot say that this position “should” make 10.3 percent or “will” make 10.3 percent. It could lose everything if the company went bankrupt (if accounting fraud were discovered, for example). It could make as much as 2.25 points (14.8 percent). But, *on average*, a position of this type will make 10.3 percent. In this one instance, an investor can’t know for sure what the return will be; but if he constantly invests in positions with high expected returns, he should realize superior returns.

In the previous example, the investment was fixed, since it was a covered write. But when you have a position that involves naked options, the investment fluctuates, since the margin required by your brokerage firm is dependent on the stock and the option prices at the time. This is not a real problem for expected returns because one can compute an *expected investment*. The calculations are the same as in the previous example, except that the “profit” column is replaced by an “investment” column. Then the expected return itself would be the expected *profit* divided by the expected *investment*.

Expected profit calculations can also be used in a “what-if” form. What if the volatility collapses? What if the volatility explodes? What

if the stock doesn't adhere to a lognormal distribution? Any and all of these questions can be accommodated, merely by changing the factor in the analysis. Traders should be careful about changing the distribution from lognormal to something else; but if a straddle buyer fears the stock will continue to be trapped in a trading range, with perhaps equal probabilities of the stock being at all points within that range, he could lower the volatility and make the distribution flat and see how it affects the return.

You might use expected return analysis in this manner: requiring any position to have an expected return at least 20 percent, or some such fixed number, or requiring it to be a certain multiple of fixed interest rates.

With expected return analysis, you can also easily compare covered writes with calendar spreads, ratio spreads with backspreads, and so forth. All are reduced to their basic profitability, properly incorporating volatility all along the way. This is the real worth of expected return analysis—the comparison of possibilities—not the prediction of actual returns, for there really is no prediction involved. It's a statistical projection, not a prediction of how this one particular investment will turn out.

## **SUMMARY**

There are two basic approaches to dealing with trading volatility, although they are related in that they both rely on using the current percentile level of the implied volatility. In the first approach, we look for the implied to be near the end of its trading range, either in a very high percentile or in a low one, and for the historical volatility to be more in the middle of the range. If that is the case, we will sell volatility when it is high and buy it when it is low. Strategies used for selling this type of volatility are the naked sell combo and the ratio spread. If implied volatility is low, we will buy it, using long straddles, backspreads, or calendar spreads as the favorite strategies. These strategies can all be enhanced to remove price risk—especially the sell combo, ratio spread, and calendar spread that are hurt by volatile price movement—by using gamma and delta neutral strategies.

The second approach for trading volatility concentrates more on locating situations in which the individual options on the same underlying security have differing implied volatilities. When this condition exists, it is called a *volatility skew*. If the skew is positive—that is, implied volatilities increase at successively higher striking prices—then the applicable strategies are put backspreads or call ratio spreads. However, if the opposite situation exists, which is called a *reverse volatility skew*, then call backspreads and put ratio spreads are the two strategies that are the ones to use. Finally, a method for mathematically computing the extent of a volatility skew was presented.

Experienced option traders tend to view volatility as the most important variable when discussing option pricing and option trading strategies. Moreover, it is somewhat more predictable than prices; so if the volatility can be isolated and identified, then you might be able to construct positions with less risk and more profitability by predicting volatility movements rather than by predicting price movements.

# 7 Other Important Considerations

In this chapter, we discuss some other important aspects of option trading. One is support activities, which include order entry, brokers, data vendors, and software. Also included are some discussions on trading in general, including procedures and money management. Finally, we look at the psychological aspect of trading options—perhaps the most important facet of trading, no matter *what* market you are trading.

## SUPPORT ACTIVITIES

Many of today's traders are doing their own research and developing their own trading systems. I assume that is why you are reading this book. Even if you are relying on someone else for advice, such as a daily or monthly newsletter of the type that we publish, you are gathering your own information, apart from your broker. Thus, it is appropriate to discuss brokers and order entry, brokerage, data vendors, and software.

### Order Entry

When you place an order, it can be done in one of two ways: (1) you can call your broker, or (2) you can use one of the computer order-entry systems where you enter the order directly from your computer (or possibly from the touch pad of your telephone). Regardless of which method you choose, the order has to be sent to the floor of the appropriate exchange for execution. This is true for exchange-



traded securities. In the over-the-counter (Nasdaq) market, there are some differences.

For most individual customers, the order-entry process begins with a phone call to your *broker*. Then, depending on the size and complexity of your order, your broker will either put the order over the *electronic entry system* (this is often called the *wire system*) or phone it to a *special-handling desk* or order desk at the home office of the brokerage firm. If you enter the order electronically yourself, it still goes to a brokerage firm, where it is rerouted into their own wire system. A flow chart of the order-entry process is pictured in Figure 7.1.

There are benefits to either method of placing an order. If the order is small and speed of execution is desired, then the electronic method is best, although many customers at home don't have access to high-speed Internet connections. However, even if you call your broker directly with a small order or if it is a simple market or limit order, it is most likely then entered electronically by a clerk at the brokerage office. Thus, it eventually becomes an electronic order as well. One of two things can happen to your order at this point: (1) either it will go to your firm's *booth on the appropriate trading floor*, or (2) it will go onto the *automatic execution system*.

**Figure 7.1**  
**ORDER FLOW**

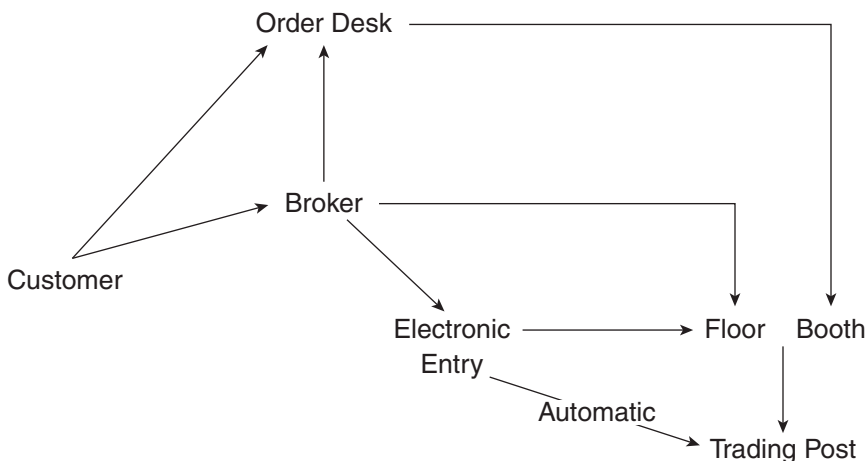

If an electronic order goes into the automatic execution system, it goes into a computer that directs it to the appropriate trading post (the place where the trading in a particular stock or option actually takes place) and gives an immediate, automatic execution. This system is not available for all orders; however, if the order is a small one of 10 contracts or less *and* it is a market order or it is a limit order to buy at the current offer or to sell at the current bid, then the order will go onto the automatic system. Each option exchange has its own particular maxima regarding the number of contracts that are available for automatic execution (for example, they may be larger for index options), and each exchange calls their automatic system by a different name. You should check with your broker for specific details on automatic order entry. When this system is used, another stage in the process—your brokerage firm’s floor trading booth—is bypassed.

The other thing that can happen to an electronic order is that it goes to the firm’s booth on the trading floor. At this point, the order is given to a *floor broker*, and he physically goes into the trading pit and executes the order. Your order can also get to a floor broker through what is called an “electronic deck.” That means the order is sent electronically from upstairs directly to a broker standing in the crowd, and he executes the order. This bypasses going through the brokerage firm’s desk and then having to be sent out to the crowd.

Remember, though, that there was another way to get your order to the floor. If you are a larger trader, for example, you might demand and require the personal attention that a large order sometimes needs. Your order might be called into a special-handling desk—or *order desk*—which will in turn call the order down to the trading floor. This type of order is then monitored by the order desk in order to stay on top of partial fills or for any other type of personal attention that the order might require. Some clients even give the order desk or the broker some discretion (i.e., leeway in what price to pay), figuring that the professionals on the trading desk and on the trading floor are more in tune with the market.

The order desk is staffed by professional traders who are familiar with the sometimes arcane terminology of options and who generally handle larger orders and/or orders involving spreads and more complex situations. In any case, though, there is usually a minimum num-

ber of contracts that you must trade in order to receive the benefits of having the order desk take care of your order. Larger customers, money managers, and institutional option traders talk directly to the order desk to get this special handling. *If you are trading in fairly large size, then you should request that your brokerage firm allow you to talk directly to the order desk.* Your broker will still receive his commissions, but you will be getting faster executions because you have bypassed one phone call in the order-entry chain: the phone call from your broker to the order desk now becomes unnecessary. For some large customers, their broker actually sits next to the order desk so that they effectively gain direct access to the desk by calling their broker; these brokers are generally called *institutional brokers* and are only available to large trading accounts.

Thus, orders that arrive at your brokerage firm's floor booth—whether sent there by the firm's wire system or called in by the firm's order desk—end up in the hands of a floor broker. Floor brokers are of two general types: (1) those who work for the same firm as your broker and (2) independents who work for themselves (sometimes called *two-dollar brokers*). The independent broker charges an additional fee for his services, but he may be better at obtaining favorable price executions and in handling special orders. Unless you are calling the independent broker yourself (which is possible if your brokerage firm will allow it), then you have no control over which type of broker winds up with your order.

These steps are all summarized in Figure 7.1. Note that the quickest path for large traders is for the customer to call the order desk, from where the floor booth is called, which is where the order is executed. As mentioned in the previous paragraph, it is even quicker to call a floor booth yourself. In order to take advantage of this, however, your brokerage firm would have to agree to process trades executed by the independent broker. As there is a certain amount of “handshaking” that needs to go on, it may not be easy to establish such a relationship.

## **Brokers and Brokerage**

Today, if a trader uses a full-service broker, he uses him more for the services provided than for recommendations; that is, he is interested

in technical or fundamental reports, summaries of his account, charts, and other products that the full-service firm can provide. Most important, the full-service broker offers the ability to watch a client's account and to alert him when a previously agreed-upon event occurs. For example, if you are trying to use mental stops—where you want to make a decision in real time when the underlying hits a certain price—you can have your full-service broker call you when the stock, future, or index hits that price. Thus, you, the client, do not necessarily need real-time quotation capabilities if your broker can watch your positions for you.

A discount broker will not be able to give that level of service, but his commission rates will often be lower than those of a full-service firm. If you are using a discount broker, you will need to have some way of knowing prices so that you can make trading decisions. If your investment horizon is intermediate to long term, you probably are not so interested in knowing real-time prices. However, if you are a short-term trader/investor, then you will most likely need access to prices on a timely basis. A discount broker will not be able to offer those, but we discuss price quotation services shortly.

Perhaps the most important aspect of any brokerage *firm*—not of your *broker* himself—is what kind of orders they will take and how they handle those orders. I have had attendees at seminars tell me that their brokerage firm will only take market or limit orders—no spreads, stops, or contingent orders. My advice is always for them to find a firm that will take those orders. Similarly, if your orders are repeatedly slow in getting to the floor and are then sloppily executed, or if you have to argue about executions and partial fills, perhaps you should look for another brokerage firm with which to do business. It does little good to save on commissions by using a deep-discount broker if you have to then give those savings back in the form of restricted order entry or poor order execution.

One thing you should be aware of in selecting a broker and a brokerage firm is commissions, including those for treatment for exercise and assignment. Commissions are important, but they should not be your only concern. I am always hesitant to recommend a specific commission rate that you should seek, because there are other considerations. However, the following are reasonable rates that are attainable from many reputable brokerage firms: stock or index

options: \$3 per option; stock: 6 cents per share; futures options: \$10 per side; futures: \$15 per round turn. If your broker charges a little more than that but you feel you are getting service to justify it, then I would heartily recommend that you stay with him. Exercise and assignment commissions are an important aspect of option trading, particularly for stock and index options. If you are assigned or if you exercise, you should ask your broker for rates comparable to the option trade that would have occurred.

---

This situation often arises near expiration: the call option that you own and want to sell is trading at a discount. It is more efficient for you to sell the stock (short exempt) and exercise your call. In this manner you achieve parity as the net price for your call. Suppose the following prices exist on expiration Friday of January expiration:

XYZ: 23.50 bid, 23.60 offered

XYZ Jan 20 call: 3.40 bid, 3.70 offered

At these prices, the market makers are setting the bid an eighth below parity and are setting the offer 10 cents above parity. This is fairly typical for an in-the-money option at expiration.

You own the Jan 20 calls, and you attempt to sell them at 3.50. However, the market makers don't budge, and time is running short. You can sell the stock at 23.50 (where it is bid) and exercise your calls, thereby buying the stock at 20. In effect, you have sold your calls for 3.50.

How much you have to pay out in commissions has a major effect on the overall net money received from these trades. Suppose you are normally paying \$4 per option and 8 cents per share of stock as commission rates.

Let's compare the two choices that this trader has: (1) selling his call at  $3\frac{3}{8}$ , where it is bid, or (2) selling the stock and exercising the call, as just detailed.

(1) Net money from selling call at 3.40:

Sell call at 3.40:	\$340.00 credit
Commission:	4.00
Net credit:	<u>\$336.00 credit</u>

(2) Net money from selling stock and exercising:

Sell stock at 23.50:	\$2,350 credit
Commission on stock sale:	8 debit
Exercise (buy stock at 20):	2,000 debit
Commission on stock purchase:	<u>8 debit</u>
Net credit:	\$ 334 credit

The two methods produce virtually the same result, so you seem to be just spinning your wheels to go through with the stock trades. The better price achieved is eaten up by the extra commissions.

However, many brokers will discount stock commissions on trades involving exercise or assignment. Suppose that you receive a 50 percent discount on exercises and assignment. Then your net credit from method 2 would be \$342 (\$350 credit from the stock trades, less \$8 in commissions). If that were the case, it *would* make sense to use method 2.

---

Another important feature to consider when selecting a brokerage firm is margin rates, especially for the treatment of naked options. If you are a strategist, you almost certainly will be trading naked options at some time or another. It might arise from selling naked puts to simulate the covered writing strategy; it might come from ratio writes to take advantage of expensive volatility; or it might even evolve out of something simpler, such as selling out the long side of a bull spread that is out of the money and letting the short side expire worthless.

Some option firms don't allow naked option trading at all. Avoid those firms, unless you never plan to do anything besides buy options. Other firms heartily discourage naked option trading by imposing onerous margin or equity requirements. It has been explained that the exchange sets minimum margin requirements for naked option selling. *Select a broker who uses the same standards—exchange minimum margin requirements.* This goes for futures and futures option traders as well. Use a brokerage firm that adheres to exchange minimum margin requirements. In fact, futures option traders should request SPAN margin, which is even more favorable than exchange minimum. SPAN applies logical price projections, which include the

use of volatility, to naked options to arrive at margin requirements. While I wouldn't consider it absolutely mandatory for your broker to allow you to use SPAN requirements for your futures option positions, it would certainly be worth requesting.

The final point I would like to make about selecting a broker is to find one who trades all markets; specifically, this means index, equity, and futures. Later, we encourage you to trade all markets; but in order to do that, you have to have a broker (not necessarily the same broker that executes your stock and stock option trades) who can execute those trades. Even if you don't plan to trade futures options, for example, you will almost certainly have to if you are trading Standard & Poor's 100 Index (OEX) options. You may recall the story of the 1989 crash, where OEX options ceased to trade and the only thing that prevented disaster for those traders who were naked OEX puts was to be able to sell Standard & Poor's (S&P) 500 futures. We have also pointed out that it is sometimes more efficient to trade S&P futures than OEX options if implied volatility is too high.

## **Data Vendors**

Many traders and investors are using their home computers to act as quote machines. There is a wide variety of products and services on the market, and more are being introduced all the time. Thus, while we attempt to survey the landscape accurately at the present time, you must understand that technological advances might present other opportunities in the future.

When deciding to select a data vendor, you need to consider several things, including whether you need real-time or delayed prices, how you will physically receive the prices, and what type of software is able to work with the prices you're receiving.

**Costs.** When buying stock or futures market data from a vendor, you have two costs to consider: (1) the service charge imposed by the vendor and (2) the exchange fee imposed by the exchange that originally disseminated the prices. In essence, the vendor buys the

prices from the exchange and then resells them to its subscribers. If the end user (you) is only interested in delayed quotes or end-of-day closing prices, then there is no exchange fee—only the vendor fee need be paid.

However, in a rather archaic setup, the exchange is entitled to collect exchange fees from every end user of its real-time prices. Therefore, if a trader needs real-time prices, he must pay the exchange fees, too. In the modern world of competitive (and decreasing) costs for data of all sorts, it seems unreasonable that the exchanges can impose these fees. However, at the present time they can, and they do. These exchange fees can be quite modest for individual investors; for example, the New York Stock Exchange (NYSE) only charges \$4 per month for their quotes, if they are disseminated to an individual investor. However, professional investors—and that is defined rather broadly by the exchanges to include everyone who is trading for an account other than his own—must pay considerably more. Moreover, the futures exchanges' fees are quite a bit higher than most stock exchanges.

If you are only interested in stock and option quotes, you can probably get them real-time for less than \$100 per month. Delayed or closing quotes can be obtained for \$20 a month or less. However, if you want real-time quotes on all the stock, option, and futures exchanges, you are probably going to have to pay costs of \$500 a month or more—and that doesn't include much in the way of analysis programs.

**Data Connection.** The next feature that must be considered is how you are going to get the prices, physically. Most investors who are interested in doing their own analysis pull the prices into their own computer and then run various software programs (charting analysis programs, for example) on that data. However, it is not absolutely necessary to have a computer and software in order to be able to receive pricing data.

If you only want to see quotes and you move around a lot, you can get them on handheld devices—usually cell phones with text messaging, personal digital assistants (PDAs), or pagers. These devices also let you see news headlines in many cases. Data Broadcasting Corporation is reintroducing a more sophisticated handheld



device, called a Quotrek—which was very popular at one time but was then phased out.

However, if you are going to perform any analysis, then you will need to have a more sophisticated way of getting and handling data—using a computer. There are essentially three methods by which you can observe and analyze prices by computer: (1) you can use your own computer to access another computer and observe analyses on that computer; (2) you can use a terminal supplied by the data vendor that performs specific tasks and connects to the data vendor's main computer; or (3) again using your own computer, you can download data and analyze it with your own software.

In method one, the trader doesn't have to actually subscribe to a data service, *per se*. The vendor whose computer he is accessing pays the exchange fees and charges the end user a unit charge for access to the main computer. This unit charge might be a flat monthly fee, or it might be a fee based on the amount of time that the user is logged onto the main system. Examples of this type of data connection might include any number of Internet providers, where the trader can log into their web site and look at prices or analyses. This is an increasingly popular way to access data and outputs, as the Internet has gained popularity and speed. The Strategy Zone, at our corporation ([www.optionstrategist.com](http://www.optionstrategist.com)), is one typical example of this sort of access, where you can view charts of put-call ratios, charts of implied volatility, precanned reports showing expected returns and probability analyses for major strategies; or a daily market commentary; or just look at lots of option and volatility data. If you want a more interactive experience, something like PowerAnalyzer can provide it. Prices generally vary, based on the depth of the analysis provided.

The second method of getting data is to install the vendor's terminal at your home or business site. This can be a rather expensive method, but it has some advantages, especially for sophisticated users. Perhaps the best known of this type of data vendor is Bloomberg. Bloomberg terminals can be found all over the world, mostly in professional trading rooms. A Bloomberg terminal is installed at your office and is connected to the main Bloomberg computers by a direct phone line. A direct phone line is one that is dedicated to a specific purpose, in this case, to linking the terminal with

the main computer. A direct phone line can cost upward of \$500 per month, and the rental cost of a Bloomberg terminal is \$1,500 per month. In reality, a Bloomberg "terminal" today is really a Dell computer that you lease from Bloomberg with all the software installed on it.

For this rather large cost, you receive a vast, startling array of data. There are voluminous quotes, not only on listed securities but also on bonds and foreign stocks; and sophisticated analyses are available at the press of a key on the terminal. Option implied volatilities and historic volatilities on the underlying—graphed right on the price graph of the underlying security—are readily available, for example. Moreover, some of the most sophisticated research on Wall Street can be read by Bloomberg users, although much of it requires an additional fee for access. In addition, shopping can even be done on the Bloomberg terminal, although that is hardly a reason to go this route—it's just an added feature.

The third method of receiving data is to have the data come directly into your own computer. This is what eSignal, Realtick, PC Quote, DTN Wallstreet, S&P Comstock, and others supply. With eSignal, you can subscribe to real-time prices, 15-minute delayed prices, or just closing prices. Each one has different costs, with the real-time data being the most expensive. All of these systems are web-based at the present time, meaning that you install their software on your computer, and then you can access their data. Plus, all of these services offer some sort of charting, option montages, news retrieval, and so forth. Some of these services are add-ons, for which there are extra charges. In all cases, your computer can act just like a broker's quote machine. Of course, this ties up your computer while the software is running, so many investors actually buy a second computer to act as a quote machine.

There are at least four ways that data can physically be delivered to your home or office: (1) dial-up phone line, (2) high-speed Internet, (3) cable modem, and (4) satellite. Also, there are several forms of high-speed Internet connection: T-1 line, DSL, and some areas in between. T-1 and DSL are phone lines, too, but they are more expensive than a typical phone line. T-1 is the widest bandwidth and is the most expensive. The others are much less expensive and probably would serve most customers nearly as well.

Remember, though, that if you are watching streaming quotes all day long and accessing the Internet for other uses, you are going to need a relatively large band width to keep things flowing at a high rate. Satellite can be fairly expensive to have installed because someone has to put the dish on your roof and get things started. Any of these can fail on you; but in my experience cable is probably the most reliable (mostly because everyone would be screaming mad if their TV wasn't watchable for any length of time).

Finally, it should be noted that you can buy data and process it yourself. Genesis Financial Data Systems ([www.gfds.com](http://www.gfds.com)) and The Better Software People ([www.tbbsp.com](http://www.tbbsp.com)) are both good sources of closing price data, including bids and offers. Of course, then you would have to write programs to analyze the data or hire a programmer to create those programs. Because of the programming requirements, this method is only applicable to a few traders; but some do enjoy doing their own programming.

## **Software**

As mentioned earlier, when you have an online brokerage account, there is a software interface that allows you to view the data and to place your orders. In some cases, the software interface is quite complete; but in others, you may want to buy or create some software for further analysis. One thing that an option trader should look for in such software is a good option montage—the page that shows a number of option contracts on the same underlying at once. This is necessary for spread trading.

With Realtick, for example, which is the interface for a number of online brokerage firms, you have the ability to view a myriad of technical indicators, to draw charts, and to view one of the best option montages available (with Realtick TurboOptions). What makes the TurboOptions montage very useful is that the option months are easily viewable on the same screen so that you can look at calendar or diagonal spreads very easily. However, if you want to view vertical spreads (in the same month), you can expand the montage to view a lot of different strikes all in one month. The montage

is capable of displaying option theoretical value calculations based on either the Black-Scholes or the Binomial models and can show the “Greeks” and implied volatility for each option. The charting software incorporates many of the most common technical indicators—moving averages, ADX, RSI, and so forth. Realtick interfaces directly with order-entry software, so trading is simple, right from the option montage or from the stock’s market-maker screen.

eSignal also provides a complete set of analysis software, including charting and news retrieval. It also links to *some* online brokerage firms for direct execution. It, too, has an option montage with the capability of displaying theoretical values and the Greeks. Another complete package is offered by TradeStation, which has data, software, and brokerage all wrapped into the same software package.

In fact, no matter which online broker you use, there is probably some sort of interface software; but not all are sufficient for technical or option analysis on their own.

If you want more sophisticated analyses, you need to buy software. Most of the major software packages (for example, technical analysis charting programs, option analysis programs) work with data supplied by the major data providers, such as eSignal or PC Quote.

Buying your own data gives you a lot of flexibility; and if you are an accomplished programmer or want to hire one, this method gives you access to the raw data, from which you can construct your own analyses. Even if you’re not a programmer, this may be the best method because (1) you can keep your costs down by only subscribing to markets that you have an interest in, and (2) you only need to buy software that performs the analyses that you will use.

As an option trader, you will probably need to buy some option analysis software if you are bringing data into your own computer. There are several major option software packages available; you can normally find them through advertisements in financial newspapers or magazines. Some of them include Option Vue ([www.optionvue.com](http://www.optionvue.com)), Option Pro ([www.optionpro.com](http://www.optionpro.com)), PowerAnalyzer ([www.optionstrategist.com](http://www.optionstrategist.com)), and Power Options ([www.poweropt.com](http://www.poweropt.com)). In addition, some of the more advanced, broader-based analytical tools, such as First Alert or AIQ, do option analysis as well. A more

complete list of available software vendors is normally available from the data vendor.

If you are going to buy option software, there are several qualities that I would consider mandatory. First is that the software be able to display option prices in *pages*, along with theoretical values, delta, implied volatility, and so on. I mentioned earlier that I would want the data vendor's software to display option pages. However, if the software vendor's program can display option pages, then you might relax the criterion for the data vendor. The option software should also have a portfolio-management system built into it. This portfolio-management system should be able to do more than calculate profits and losses. It should be able to calculate, for example, the position delta of any position or of your whole portfolio. Ideally, you would also be able to calculate position vega, gamma, and so forth. In this way, you can determine the exposure of your option portfolio to various market conditions.

The specific model that the software uses is not important. As was explained in Chapter 6, there are several option models available, and they give very similar answers to theoretical value questions. Also, if the model does not specifically calculate futures option theoretical prices, that is not a problem as long as the software allows you to change the short-term interest rate (which almost all software packages do). If you set the short-term interest rate in your model to 0 percent, then you will get the correct theoretical value for nearly all futures options. The exception would be deeply in-the-money futures options, which would appear to be somewhat underpriced by our simplistic method. *Be sure that the software allows you to change the interest rate if you are going to trade futures options.*

The software should also be able to perform what-if analyses; that is, you construct a position that you are considering, and the software can describe how that position will perform in the future under certain assumptions such as time passing and volatility changing. Preferably, it will graph this information. Option Vue is particularly good at this kind of analysis. In addition, Option Vue software can perform expected return analysis, which makes it the Cadillac of the industry.

Ideally, your software should be able to keep historical records of volatility and underlying prices. Historical records of option prices are not mandatory, for they take up a lot of disk space and aren't really necessary for further analysis. However, being able to track historical volatility (which can be done via the historical prices of the underlying security) and to track the past ranges of implied volatility are necessary for many option trading strategies, particularly those discussed in Chapters 4, 5, and 6.

Before leaving this section on software, it should be pointed out that there *are* some low-level software programs that are “stand-alone.” They do not get their data from a real-time data feed. Rather you, the user, type data into a file, and the software analyzes those data. For many traders, this type of software is often sufficient, and it is always quite inexpensive (less than \$100) because it doesn't have to link into a real-time data source. For example, to see the implied volatilities of a group of options, all you would have to do would be to type in the stock price, the expiration date, the strike prices, and the current option prices (for this last item, you would need to have some way of quoting prices). The simple computer software program can then display delta, gamma, implied volatility, and so on. Of course, with no historical record of volatility, you would have a hard time deciding whether the options were expensive with respect to their history; but you can see how they compare with each other at the current time. Programs of this type are often called *option calculators*. These are three very useful and popular ones: Option Evaluator by McMillan Analysis Corp. ([www.optionstrategist.com](http://www.optionstrategist.com)), Options Laboratory by Mantic Software ([www.manticsoft.com](http://www.manticsoft.com)), and Option Master by Ken Trester at the Institute for Options Research ([www.options-inc.com](http://www.options-inc.com)).

In sum, there is no best data service and accompanying software. “Best” depends on what you perceive as your needs. If you are a small investor who only wants to see end-of-day quotes, then something very simple will suffice. However, if you are a real-time trader, then you want a more sophisticated data service, although your software needs may not be complex. Finally, if you are planning on trading volatility in the option markets, then you are going to need more sophisticated software and probably real-time pricing as well.

## **TRADING METHODOLOGY AND PHILOSOPHY**

The preceding chapters have concentrated mostly on trading strategies and systems. Thus far in this chapter, we have looked at how to get yourself physically set up to trade. Those are both very important parts of trading, but there is more to trading, much of which has to do with mental preparation and execution.

### **Managing Your Money**

One of the most important aspects of trading is money management. We have presented several systems and strategies in this book, but it is up to the individual investor or money manager to decide how much of his capital he is going to allocate to each position. However, money management encompasses much more than just deciding how much to invest. It also has to do with taking losses so that the investor can be “alive” to invest another day.

Most people are familiar with a simple form of money management: dollar cost averaging. This simple strategy—buying the same dollar amount of stock at equally spaced intervals—is designed to help an investor avoid putting all of his money into a market at once, lest he should be buying at the top. It’s not a bad strategy, but it has little relevance to short- or intermediate-term trading—it is more of a long-term, buy-and-hold strategy.

Most traders approach short-term trading with a fixed amount of money that they feel comfortable risking. Thus, they have a pool of funds, and that pool will either make it or break it; further moneys will not be added if the trading is not working out. A professional trading firm approaches the matter differently. The professional trading firm will put a limit on the losses that it will allow from a strategy—if that limit is hit, trading will cease. This is a proper approach, and one that often distinguishes large professional trading firms from individual investors.

---

Firms that are in the business of trading will often accept new ideas from outside traders or analysts. Traditionally, such firms have been the large bro-

kerage firms; but in recent years they have cut back on their risk taking, so hedge funds have taken up the slack. It is sometimes possible for a trader who has an original idea that is well documented to be profitable to approach one of these firms and receive trading capital. Profits might be split 50-50, perhaps, but the supplier of the capital has the right to terminate the trading if losses get too large. The firm might terminate trading if losses reach 15 percent to 20 percent of original capital.

In the late 1980s, one new strategy that was quite profitable was Japanese warrant trading. The Japanese stock market was soaring at that time toward its all-time high of over ¥40,000. Many Japanese companies had issued warrants. Warrants are much like options, except that warrants are issued by a company, and that company retains the proceeds from the initial warrant sale. Market professionals have always felt that hedged warrant trading was a viable strategy. The book *Beat the Market*, written by Edward Thorp and Sheen Kassouf in 1967, dealt solely with this strategy. In hedged warrant trading, you buy undervalued warrants and short the underlying common in a proper ratio in order to create a delta neutral hedge. This is much like owning a cheap straddle in the option market. Profits can accrue if the underlying stock moves way up or down in price or if the warrant returns to “fair value.”

Thorp and Kassouf were only discussing trading in U.S. markets, and their warrant model in the book was a rather simplistic one; but the strategy was sound. Over the years, U.S. companies stopped issuing warrants, and the strategy dried up. However, the same strategy appealed to many traders when the Japanese companies began issuing warrants.

One fairly large and aggressive trading firm agreed to open a department to trade these warrants in a hedged manner, having been approached by a trader who had outlined the benefits of the strategy and had documented its theoretical success. The way in which the trading evolved and the trading firm managed its risk are the point of this story.

The mechanics of operating the strategy with Japanese stocks introduced some different variables into the real-world equation: one was the difficulty and the high cost of borrowing the actual shares of Japanese companies (they needed to be borrowed so that they could be sold short as a hedge against the warrants); another was the currency risk for U.S. traders—the underlying market was trading in yen, while the warrants were traded in dollars (the warrants were traded out of Hong Kong and London, so they were denominated in dollars).

But an even more insidious problem was built into the pricing structure, and it was a difficult one to foresee. We have discussed the necessity of measuring implied volatility in percentiles, by looking at where it *has* been



trading. Most of Chapter 6 was devoted to trading volatility based on this concept. We saw, however, that sometimes volatility will break out of its previous range and cause losses for a volatility trading strategy.

In effect, warrant hedging is a volatility trading strategy: you attempt to buy the warrants when implied volatility is low and hedge them with stock. When the Japanese market was moving up strongly through the late 1980s and into the beginning of 1990, the range of implied volatilities was quite uniform. However, when that market topped out and began to trade down, implied volatilities fell to levels unheard of then. In some cases, out-of-the-money warrants were dropping nearly as fast as the stock (in effect, the delta of an out-of-the-money option was nearly 1.0!). Of course, this atypical action was caused by the decrease in volatility.

In any event, the hedges that were established for the firm's account were losing a great deal of money when this happened. When the losses reached the previously agreed-upon amount, the traders were ordered to liquidate their positions in an orderly manner and close the accounts. No excuses or rationalizations, just no more trading.

---

This is a discipline that individual traders rarely impose upon themselves. It is easy to make excuses, to reason that next time you'll be more careful with volatility estimates, that you'll be in more liquid issues, and so forth. However, the need to cut losses and terminate a strategy can be great, especially if it is a proven winner and you are losing money trading it. You are probably doing something wrong—perhaps emotions are leading you to overrule your “system—and sometimes the only way to stop that wrongdoing is to stop trading that strategy.

This is distinctly different from operating a strategy properly, but running into several incidences of poor luck that cause losses. For the firm traders in the previous example, it wouldn't be of much help—hitting the stop-loss point would cause them to lose their jobs in any case. However, individual traders, no matter how wealthy, often work with a fixed pool of capital for a strategy, capital that they are willing to risk in order to determine if the strategy can be a successful one. If they are willing to risk the entire pool of capital (which, we assume, is only a portion of their overall assets), then they would not want to use the fixed-loss form of termination, as in the previous example. Rather, they would use a form of investment that allows

them to invest more heavily when they are winning and to reduce the size of their trades when they are losing.

---

This is an important concept that was first illustrated to me many years ago in a book I read that detailed the life of the famous gambler, Nick the Greek (not *Jimmy* the Greek). Nick was a well-known gambler who had many interesting stories and who mainly played casino games and bet sports. Nick believed in progressive betting, and so should you. In progressive betting, you increase your bets each time you win; but if you lose, you return to your original bet size.

One night when not much was happening in a particular Las Vegas casino, Nick was standing at a craps table when a Nebraska farm boy entered and bet \$1 on the pass line. He won. He then bet \$1 again and won again. The farm boy ran off one of the most amazing streaks Nick had ever seen—he rolled 28 straight passes (even if you're not a casino gambler, you should understand that winning 28 straight wagers on any casino game is a pretty remarkable feat). Then he lost. The farm boy had netted out \$27 and he left.

Nick, on the other hand, had started with a \$10 bet and had won \$40,000 by the time the farm boy was done with his remarkable streak. Nick did this with progressive betting. He increased his bet each time that he won, eventually betting massive amounts—all of which was the house's money—near the end of the streak. If there hadn't been a table limit, Nick might have broken the house itself on a streak of that length.

---

The book never explained what progressive system Nick was using, but the common one is to increase your bet by 60 percent every time, pocketing 40 percent of the winnings for yourself. If you are lucky enough to be involved in a streak of even eight or nine straight wins, you'll be very happy. At the end of eight wins, for example, your next bet would be  $1.6^8$  times your initial bet, which is about 43 times your initial bet. If you think it would be hard to remember how much to bet after each win, especially if the streak gets long, just bet the Fibonacci numbers: 5, 8, 13, 21, and so on. Each one is about 1.61 the previous one; but even easier, each one is the sum of the previous two. So all you have to do, in order to calculate the next one, is remember the last two. That's pretty easy to do, even in the heat of battle.

The power of progressive betting is very strong. Of course, in a casino game, you are destined to be a loser if you play long enough, because the house has an advantage. However, if you just gamble occasionally, it's a lot more fun to use progressive betting because you might hit a streak that is long enough to make you a winner for life, considering that you are only visiting the casinos occasionally.

Mathematicians have attempted to apply this same thinking to the stock market and, specifically, to how much to invest in a trade. The main difference between the casino bets and the stock market investments is that you normally have more than one stock market investment going at a time. So instead of getting a series of sequential results, your results are mixed together. Also, it's easy to know when a casino game ends—the shooter passes or craps out, or the card player wins or loses. But in the stock market, only you are in control of how each investment ends. If you are trading with a system, then that system might have specific entry and exit points, and that would make things easier to evaluate in the context of the money management system that we are going to discuss.

---

Back in the early 1950s, a scientist at Bell Telephone Laboratories was working on a problem. He needed a formula to determine the optimum usage of lines in a telephone cable. His name was J. L. Kelly Jr., and in 1956 he published his findings in a technical journal on information theory. How his findings found their way into the gambling community is unknown. Most of the big casinos do employ mathematicians to calculate odds, though, so perhaps one of them saw the article in an obscure technical journal. When the results of Kelly's analysis were applied to gambling, this money management system became known as the Kelly System. It has since been adapted to the stock market as a money management system as well.

---

In reality, the Kelly System was designed only for use on items that have only two results (win or lose, true or false, on or off, etc.). This works very well for gambling, but not so well for the stock market. However, with a little adapting, its principles are applicable to the stock market also. The Kelly System assumes that you are going to bet a fixed percentage of your bankroll on each item. If you are making money, your bets will grow in size as your bankroll does. If

you hit a bad streak and are losing, the Kelly System automatically reduces your actual bet size as the value of your bankroll decreases.

Here is the original Kelly formula in its simplest form:

$$\text{Amount of bet} = (W + L) \times p - L$$

where  $W$  = amount you could win

$L$  = amount you could lose

$p$  = probability of winning

For example, in a situation where you risk one “unit” and pay a 10 percent “commission,” the amount you could win ( $W$ ) would be 1.0, while the amount that you could lose ( $L$ ) would be 1.1. This reflects the 10 percent commission, which is typical in sports betting. With these values for the variable, the Kelly formula would read:

$$\text{Amount of bet} = 2.1p - 1.1$$

So, in order to use the system, you would only need to know what your probability of predicting winners is. For example, if you can predict winners at a 60 percent rate, the Kelly System would tell you to bet  $2.1 \times 0.60 - 1.1 = 0.16$ , or 16 percent of your total bankroll on this one bet.

This formula also tells you that if  $p$  is less than about 52 percent, the Kelly System would tell you not to bet at all ( $2.1 \times 0.52 - 1.1 = -0.01$ ); that is, if you are paying a 10 percent commission and can't predict 52 percent winners, then find another line of work. Of course, it's often hard to admit that you can't predict sporting event winners, or day-trade the S&P futures, or whatever. Sometimes it's hard to admit the results yourself, as the following anecdote relates.

---

A basketball bettor was having a particularly poor season and was lamenting to his friend that he had lost a good deal of money. The concerned friend said, “Well, why don't you try something else—like betting hockey?” The bettor's reply: “Hockey?! I don't know anything about hockey!”

---

At least with the Kelly criteria, this poor guy could have plugged his winning percentage into the formula and seen, mathematically, that he should have given up basketball betting.

The Kelly formula can't be directly applied to the stock market because results are more complicated. Each trade doesn't produce a complete loss or a 100 percent profit, less commissions, as sports or casino betting does. A stock, futures, or option trade can have an infinite number of outcomes. Therefore, we have to adapt a little in order to use the Kelly formula. We not only have to gauge the probability of having a winning trade, but we also have to take into account how big the wins and losses are—that is, we have to factor the average return into the Kelly formula. In this case, the Kelly formula becomes:

$$\text{Amount to risk} = \frac{((r + 1) \times p - 1)}{r}$$

where  $p$  = probability of winning and  $r$  = average win/average loss under this strategy (where the average win and loss are computed, assuming an equal investment in each trade).

Alternatively stated,  $r$  is also the average rate of return on a trade for whatever system you are using. If you use the average rate of return, then you don't have to enforce the requirement that your historical statistical data are based on an equal investment in each trade. However, the average win and average loss statistics are often readily available for trading system summaries. For example, if you are analyzing an S&P futures day-trading system, most system designers will give you the percent of winning trades and the average win and average loss. This information can then be plugged directly into the Kelly formula.

---

*Example:* Suppose that we have the historical results of a trading system and know that it has produced 35 winners and 45 losers, or a probability of winning of 44 percent. In addition, we know that the average winning trade produced a profit of \$1,000, and the average losing trade lost \$500. This is all the information we need in order to use the Kelly formula ( $p = 44$  percent and  $r = 2$ ).

$$\begin{aligned} \text{Amount to risk} &= \frac{((2 + 1) \times 0.44 - 1)}{2} \\ &= 0.16 \end{aligned}$$

Thus, the Kelly criteria say that we should invest 16 percent of our total funds in each trade, when using this strategy.

This is very useful information, as it allows us to increase the size of our trades when our account size is increasing and forces us to cut back on the size of our trades when the system is losing. Despite that benefit, the Kelly criteria have some problems, in that they assume that you are investing sequentially; that is, you are using the system for one trade at a time.

However, most investors are trading several things at a time. For example, suppose you are trading option volume alerts, watching for increasing option volume and then buying stock in anticipation of corporate news events, as described in Chapter 4. At times, there may only be a few of these situations, but at other times there may be many of them. If the Kelly criteria told us to invest 20 percent of our funds in each one trade, what would we do if there were more than five trades that needed to be positioned at one time? One solution might be to trade on margin, but a more conservative approach would be to use what is called the *risk-adjusted* method. In this method, the amount invested in a trade is the Kelly percentage of the *available* equity in the account.

*Example:* Suppose that we computed the Kelly criteria, and they say to invest 20 percent of our capital in each trade. Then, incorporating the risk-adjusted method into the trading would result in the following amount of capital being invested in each trade.

Trade Number	Available Capital before This Trade (%)	Capital Invested in This Trade (%)	Available Capital after This Trade (%)
1	100	20	80
2	80	16	64
3	64	12.8	51.2
etc.			

Thus, if Kelly criteria say to invest 20 percent, then the first trade would consume 20 percent of our whole equity. That leaves 80 percent of our equity to be invested. The next trade would then be 20 percent of the avail-

able equity—or 20 percent of 80 percent (16 percent) of the entire account. In terms of the whole account, 20 percent would be invested in the first trade and 16 percent in the second trade, leaving 64 percent of the account as available equity. The third trade would require 20 percent of 64 percent, and so forth.

---

The main problem with this sequence of money management is that the first trade is bigger than the rest, but it is the only way to guarantee that you don't overinvest and still adhere to the Kelly criteria. Moreover, if a lot of trades are going into the account at one time and all might be negatively affected by the same event (news or volatility, for example), this method automatically scales back the size of each new position. This reduces the tendency to overtrade a particular system at any one time. In addition, as time passes and trades are opened and closed, the sizes of the trades will tend to even out.

Using the risk-adjusted method will even allow you to combine different strategies (which presumably would have different Kelly percentages). For each new investment, you merely use the appropriate Kelly percentage and apply it against the remaining equity in the account in order to determine how much to invest in any particular trade.

In summary, then, the Kelly criteria can be coupled with the risk-adjusted method to produce a useful and impartial way to help you manage your money as you establish each new position.

## **Speculative Trading Procedures**

In this book, many of the trading opportunities identified are speculative in nature. If you are using option volume, option premiums, or the put-call ratio as a predictive indicator, you are most likely going to take an outright position, as opposed to a hedged strategy. Therefore, it would be pertinent to discuss the general philosophy of trading an outright position.

In a broad sense, outright speculative positions are the easiest to manage—you are generally long a security (stock, futures, calls, or puts), and all you have to do for follow-up action is to adhere to some

sort of a stop loss. In reality, though, an outright trading position needs more management than that—from initial selection to final sale. In some cases, there is no underlying—sector index options, for example—so options are then the only choice. However, when there is a choice, the only way to logically make it is to evaluate the options with a mathematical model. *You must know the relative price of an option before you trade it.* If the options are too expensive, you may then decide to trade the underlying instead.

In order to decide if the options are “too expensive,” you must have some gauge against which to measure the current option price. That gauge, of course, is volatility. You should compare the current implied volatility of the options to the recent historical volatility of the underlying. In addition, you should also compare the current implied volatility with recent implied volatilities. An example should help in understanding this procedure.

---

*Example:* A trader is going to buy “the market.” He can either buy OEX options or S&P 500 futures. With OEX at 550, these are the relevant statistics:

**OEX: 550**

<u>Option</u>	<u>Implied Volatility (%)</u>
545 call	13
550 call	12
555 call	11

Historical volatility: 9

Given this information, it appears as if the options are overpriced, and so the trader might opt to buy the S&P 500 futures instead of any of these options. However, a little more investigation reveals that the OEX options *always* seem to have an implied volatility that is higher than the historical volatility. In fact, over the past few months, OEX implied volatility has ranged between 11 percent and 18 percent. Thus, implied volatility is currently near the lower end of that range.

Moreover, looking at historical volatility in the same context, the trader finds that over the past few months, historical volatility has ranged between 6 percent and 13 percent; so it is currently near the center of that range.



Given this additional information—that implied volatility is near the lower end of its normal range, and that it is normally higher than historical volatility—the trader would opt to buy the calls instead of the futures.

---

Another decision that must then be made is which option to buy. As mentioned earlier in this chapter, buying the short-term in-the-money option is usually the best choice. The trader obtains leverage because he owns an option, but he does not spend a lot for time value premium. The number-one reason that option buyers lose money is that they buy options that are too far out-of-the-money. These options also may have too little time remaining. This mistake can cause the trader to lose money even though the underlying may move in his favor. Whereas with the in-the-money option, he will almost assuredly make money if the underlying has a favorable move.

As for actually buying the position, be careful about using market orders in options unless (1) you are trading a very liquid option, such as OEX or IBM, or (2) you are placing a small order of 10 contracts or less. Otherwise, limit orders would serve you better in the long run. You may find that you can often “split” a market (i.e., buy between the bid and the offer), especially in a moderately active option. Don’t be stubborn about using limits, though. If you are attempting to buy a very thin (illiquid) option, the market makers may just raise their offer when they see your bid, for they don’t really want to take a position.

Risk management, through stops, of an existing position is another important factor, especially in speculative trading. Not only must you adhere to a stop loss of some sort, but you should also have a plan for taking partial profits at times along the way. I generally prefer to set my stops based on technical support and resistance levels in the chart of the underlying security. Some traders who buy options set stops based on the *option* price; this can mean that time will stop them out or that they sell their options when the underlying is sitting right on a support level—*not* a good idea. However, when they are trading in-the-money options, they don’t have to worry about time decay so much, so they can use the underlying’s technical levels to place their stops.

If you are trading options, use a *mental* stop; if you are trading stock or futures, you can use an *actual* stop. A mental stop means that you don't actually have a stop-loss order on the floor of an exchange; but when the underlying hits your mental stop price, you can evaluate the situation at that time. If it seems that the position should be sold, then you can decide on a market or limit order. In general, if your mental stop has been violated and if the stock or futures contract seems to be headed in the wrong direction, a market order is best. However, if the stock or futures seem stable, you might try to use a limit order to exit the position.

Perhaps even more important than limiting losses is managing profits. Everyone wants to follow the conventional wisdom to "limit your losses and let your profits run." Actually *doing* this is easier than it might appear, despite conventional wisdom to the contrary. Most traders know the anguish of seeing a position move in their favor, thereby generating an unrealized gain, only to have it fall back and stop them out. To me, this is far more devastating than taking a profit too early, although we can attempt to get the best of both worlds. There are two ways to do this: (1) take partial profits and (2) use a trailing stop.

Some traders take partial profits on a strict basis. For example, if they own options, they may sell a part of the position if they get a 25 percent profit. Then they would sell a similar portion if they get a 50 percent profit. Then they would attempt to hold the remainder with a mental stop. Other traders prefer to take profits based on the underlying's action—if it hits resistance or spurts ahead too fast, they take partial profits on their position. In either case, this is the correct approach, for it allows them to take some realized gains but still lets their profits run.

The other technique that protects profits is the *trailing* stop. Once a position begins to move in your favor, raise your stop price, whether it be a mental or an actual stop. Initially, you use a fairly tight stop in a trading position. But, if you are taking partial profits along the way, you might not want to keep the trailing stop as tight when you raise it. That is, when things are going your way, leave some extra room for a small correction to take place without stopping you out.

I previously said that it wasn't so hard to limit losses and let your profits run. To limit your losses, set a reasonable stop to begin with *and have the discipline to adhere to it*. I prefer to risk no more than a fixed percentage of my account on any particular trade—about 3 percent, or maybe less. I am talking about *position* trades here—not day trades (where I would risk less). Then use the trailing stop to let profits run. Don't be lured by targets, and don't fall prey to your emotions when profits are building up. In my experience, targets don't do anything except get you out of a position that is about to make a long run. Staying with one or two super-trending trades a year can make all the difference in the world.

As for the specific stop, I use the 20-day simple moving average as a mental closing stop. It is *mental* because there's not an actual stop order on the trading floor. It is *closing* because I want the stock to have violated the stop at the close of trading. See Figure 7.2 for examples of closing stops. There are so many intraday feints that I prefer to use closing stops (some traders even use two-day closing stops; that is, the stop has to be violated on a closing basis for two consecutive days). Closing stops are also easier for traders who might be employed in another profession. All you have to do is check where your stock is trading with about 10 minutes to go in the trading day. If it has violated your stop, then exit your position. Or if you miss the close on any given day, then see where the stock closed and exit on the opening the next morning if the stop was violated.

There are variations on the type of stop that could be used. *Chandelier* stops and *parabolic* stops are designed to “hug” the current price more closely if a very strong, parabolic-style move develops, and they incorporate the recent volatility of the underlying. I don't think one type of stop is necessarily any better than another (although the idea of incorporating volatility inherently makes sense), but the real point is *use a trailing closing stop*.

In summary, some axioms are difficult to accomplish—such as “buy low, sell high” (and, I might add, you don't necessarily act in that order). But cutting your losses and letting your profits run is something that everyone can accomplish without much difficulty, merely by setting an initial stop to cut losses if necessary. Then, if profits develop, using a trailing stop to let them run.

**Figure 7.2**  
**EXAMPLES OF CLOSING STOPS**

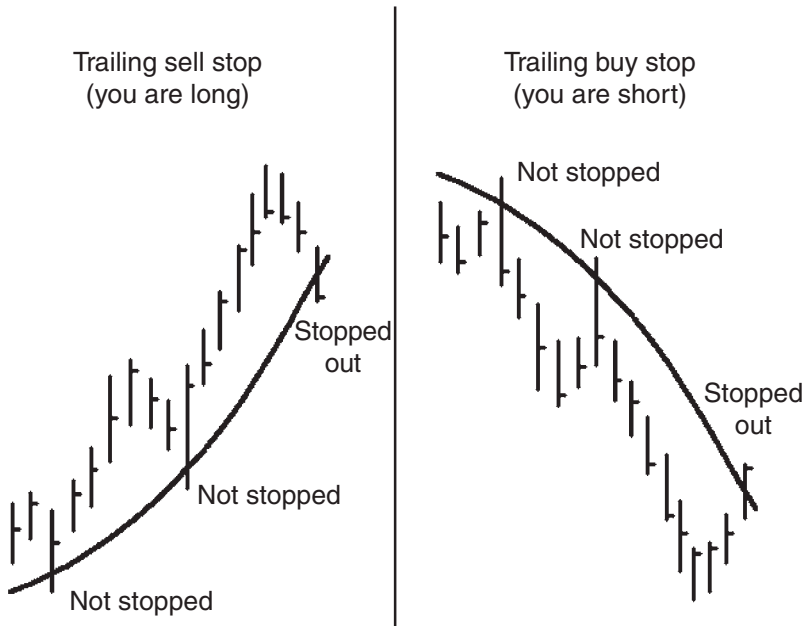

### Actual Trading Examples

On the following pages, there are some rather extraordinary historical examples of actual positions that I have been involved in at one time or another; some of you may call these “war stories.” These examples will help to illustrate some of the points regarding judgment, timing, and luck in the stock and options market. I once heard Jack Schwager (author of *Market Wizards*) say that no one ever gives bad examples of their theories or systems, just good ones. That’s a good point, so some of these examples are of losing trades as well as winning ones. Even experienced traders might enjoy these examples, perhaps because they had similar positions themselves.

The previous section discussed the usage of stops. Of course, no matter how carefully you plan to set stops, there is very little that you can do if no trading takes place. One of the most severe trading gaps that I personally experienced was in the stock of Cities Service Company, back in 1982. All during 1981 and 1982, there had been a myriad of oil company takeovers, many at very inflated prices. Two of the biggest were Conoco (which was eventually acquired by DuPont after outbidding both Seagrams and Mobil) and Marathon Oil (which was acquired by U.S. Steel).

In 1982, Gulf Oil made a bid for Cities Service at \$63 per share. As head of the arbitrage department for Thomson McKinnon, I began to acquire a position. Not only was the stock selling at a wide discount to the eventual tender price—it was selling in the mid-50s—but out-of-the-money puts were expensive as well. So we sold puts naked and bought stock. Most of the arbitrage departments on Wall Street did the same, and then we all tendered our stock to Gulf Oil. After that, one could only sit and wait until the appropriate date, when Gulf would take in the stock and pay out cash.

Unfortunately, that day never came. For reasons that were never specified, Gulf decided to back out. Rumors had begun to spread that something was amiss, but no one could really sell their Cities Service stock because virtually all of the shares in existence had been tendered to Gulf. That made matters worse; the only thing that traders could do was buy puts for protection, but those quickly became so expensive as to be prohibitive. A few Cities Service shares were trading in the cash market, but they were few and far between. By and large, though, most arbs still felt the deal was going to go through.

It was as if Gulf Oil was out to exact the maximum amount of pain, as they waited until a Friday afternoon to make it official—they were, in fact, withdrawing their offer and were releasing all shares that had been tendered to them. Trading halted in Cities Service and didn't reopen until the following Wednesday because of order imbalances (not a very good showing by the NYSE's specialist system). When it finally opened, it opened at 30, down 22 from the last trade!

The aftermath of this Cities Service blown deal was, at the time, one of the biggest single disasters that Wall Street trading firms had ever suffered in their own accounts. Some smaller trading houses went out of business; even Ivan Boesky's firm was in dire straits, needing to borrow money to stay afloat until somebody could rescue the stock.

Cities Service executives, who were basically as much in the dark as anyone else during Gulf's nefarious internal board meetings, set about to find another suitor. They did, in Occidental Petroleum (OXY), who bought

the company a few months later for about \$50 per share. This prevented disaster for any arbs who had the staying power to hold onto their stock during the worst of the mess. Even though we lost money, our loss was only about a tenth of what it might have been had OXY not rescued us all. To this day, I refuse to buy Gulf Oil products.

---

The preceding story illustrates how unexpected losses can occur when a stock gaps. Not only that, it shows that the unexpected can strike any position. No matter how careful your planning and analysis, and no matter how many others doing independent analysis agree with your position, there are just no guarantees, period. However, life does have its strange twists, and you must keep alert for opportunities at all times. It does no good to mope and become mentally weakened by such a loss as the Cities Service deal inflicted. Time and again, I have seen a very good opportunity follow right on the heels of a major loss.

---

The Cities Service deal blew apart in early August 1982. By late August, another deal was formulating for the stock of Martin-Marietta. There was a vague bid for the company—a bid that not many arbs were taking seriously. However, Martin-Marietta stock traded up to near 40, and options were very expensive. At the time, our independent floor broker on the Philadelphia Stock Exchange (PHILX—which is where Martin-Marietta options were traded) called to show us a seemingly very attractive trade: we could buy the stock at 40 and sell the September 35 calls for 8. This was a huge premium for an option that had less than a month of life remaining, so we took the trade in size. The downside breakeven for this trade was thus 32 at September expiration.

As the next few weeks progressed, the chances of a real bid for Martin-Marietta seemed to weaken, and the stock fell to the 33–34 area. This was perilously close to the break-even point; but since we were approaching this from a risk arb point of view, the position was held in its original form. The premiums remained large on the options. Even with the stock at about 33½ on Wednesday of expiration week, the Sep 35 calls were trading at a price of more than a dollar.

At that point, option volume increased significantly and option premiums picked up even more, although the stock itself didn't move much at all. After a series of internal meetings with the executive vice president overseeing the arbitrage, who encouraged us to play the situation aggressively if we

really liked it, we covered the Sep 35 calls that we were short. This was theoretically illogical, of course, since the options were so expensive; moreover, it left us completely exposed on the downside.

The next day, Bendix Corporation emerged as a major factor and bid \$45 for Martin-Marietta. Within a matter of two weeks, they had purchased the stock and the arbs received their cash.

---

The point of the Martin-Marietta story is a subtle one, in terms of trading. The actual strategy employed was extremely risky, but that's the game we had elected to play in risk arbitrage. The example is not meant to demonstrate that you should unhedge your hedged positions, but rather to show that you should operate your strategies consistently. Both Cities Service and Martin-Marietta were aggressive positions. To have changed strategies after the Cities Service deal blew would have been a mistake.

Of course, you don't *always* get such a great chance to recover from major losses. I was once asked at a seminar to describe my best trade and my worst trade. I chose the following as my worst trade, not only because of the result, but also because of the trading mistakes that were made.

---

Nineteen eighty-six had been a pretty good year for risk arbitrage, even for those of us who were operating without access to Drexel Burnham's Mike Milken's deals. That was the heyday of leveraged buyouts, and many deals were consummated via that method. For those needing a definition, a *leveraged buyout* occurs when an entity interested in taking over a company uses the company's own assets as collateral for the buyout of the company. The collateral often took the form of "junk bonds," which were marketed by Mr. Milken's group at Drexel. For those wanting a more in-depth description, see the movie *Wall Street* or read the books, *Den of Thieves*, by James Stewart, or *Barbarians at the Gate*, by Bryan Burrough and John Helyar.

One week in late November, there was a rumor that Gillette was going to be taken over. The stock traded up to 60 on the rumor, and options got very expensive, as volume increased in both the stock and the options. The person who did the research for our arbitrage department liked the prospects, and I liked the opportunity to sell some of the expensive put premium. Thus, we wound up both buying the stock and selling the puts. After the close of trading on Friday, I realized that we had accidentally doubled

our purchase of stock. I was working the order, and the research director was also working the same order, through another broker. This wasn't a crisis, though, as we usually added to a position for several days if we continued to like it.

Saturday morning, I picked up a copy of the *New York Times* and saw the headline "Ivan Boesky Arrested." Uh oh. Over the remainder of the weekend, arbs everywhere speculated on the severity of the beating that the market, and arb stocks in particular, would take on Monday. As it turned out, the market was actually quite calm on Monday, so it appeared that nothing untoward was going to happen.

However, by Tuesday, the attitude had changed; and there was nothing but scrambling going on to exit from as much inventory as possible, all over the street. Heavy losses were taken by most arbs in the next week or two, reducing a good year to a less-than-average one. We eventually exited the last of our Gillette at prices under \$50 per share.

---

There were several reasons that this Gillette trade ranks in my mind as my worst trade, and none of them really have to do with the bad timing of Ivan Boesky's arrest occurring right after we had taken the position. First, there was the matter of the double purchase of stock. Second, we didn't sell much stock on Monday, while the market was stable. I might argue, by the way, that I don't always feel that I know how the market will react to a certain piece of news. I normally let the market show *me* which direction it will take (this has kept me from some bad guesses over the years). However, in this particular case, the market seemed to take a whole trading day to make up its mind, an almost unheard-of occurrence in the volatile markets of the 1980s and 1990s. In any case, there was a chance to sell Gillette stock at a small loss on Monday and lessen risk in the face of the Boesky news. The fact that no one else was selling, either, should not have been a real consideration, but it was. The third mistake was a more personal one, and is not necessarily related to the management of a trading position; but it was in taking a large risk near the end of the year when our compensation was based on profits for the total year.

On top of all those problems, there was the fact that the random event—Boesky's arrest—could and did occur at just the wrong time; and it blew the position out of the water. I believe that's what's called



Murphy's Law, to a large degree. Moreover, there was no *one* trade—à la the Martin-Marietta deal—that allowed traders to bounce back from the losses of December 1986, although the first half of 1987 was generally very profitable for arbs and traders alike.

When I didn't sell the Gillette on Monday, it was the same as saying, in effect, that I didn't believe in my own analysis (which was that the Boesky arrest would be bad for arb stocks). It wasn't the same as having researched a company's prospects and having a definitive, statistical or mathematical opinion to go by—it was more of a gut feeling, which can be wrong at times. However, if you *do* have a well-researched opinion, you should stand your ground. That is the point of the next section.

An important aspect of trading is believing in your own methodology, if you are convinced that you have adequately researched it. You need to have enough conviction in your own ideas and methods so that you can profit from them. It is possible to discover something that the majority of the investment community has overlooked or has chosen to ignore. I don't mean some small stock that no one knows about—that kind of information is generally of an "inside" nature. Nor am I talking about deciding that some patently obvious fact will make a stock move. I mean a public fact that, for one reason or another, is just not being acted upon by the majority of traders. The next two examples demonstrate the wrong approach and the right approach.

---

In 1973, Disney began to rerelease some of its classics for the first time in years. My neighbor went to see whatever the current release was—perhaps *Cinderella*, I really don't remember. He was so convinced that this was a superior strategy on Disney's part that he went out and bought the stock. Over the next year, which encompassed one of the century's worst bear markets, the stock fell over 50 percent. Now, that's not bad luck, that's poor analysis. Didn't the entire world have the chance to evaluate the impact of Disney's releases and factor that into the stock price? Of course, they did. So there was no advantage in his "information."

---

This was clearly an "obvious" analysis, poorly researched; on the other hand, the next example is about information that is not readily apparent to the average trader. If you have taken the time and the

effort to thoroughly analyze a position, you should check your research with someone who is knowledgeable and is a person you can trust. If your analysis holds up under that scrutiny, then do not be afraid to act on it. You must realize that most useful technical indicators were invented by individuals; had they not had the conviction to act on their research, they might have missed out on a golden opportunity. Such ideas might involve buying or selling volatility when no one else seems to think it is the right time to do so, or it might involve a more intricate but no less obvious thing, such as a hedged opportunity. We look for them in our newsletter all the time. Here is an example from several years ago.

---

In 1980, gold stocks were very popular, and the price of gold was near its all-time high. It came to my attention—rather luckily—that the South African gold stocks were all paying unusually high dividends in the summer of 1980. The only reason that I even noticed these dividend increases was that I had bought a few of these stocks for my children, and I saw the dividends hitting their accounts.

Now, ASA Limited (at the time known as American South African) is a closed-end mutual fund of South African gold stocks that trades on the NYSE. ASA would collect dividends from the stocks it owned all year. However, it would pay a “normal,” small dividend in February, May, and August. Then, if there was any excess dividend income, it would pay it out in the form of a special dividend in November. For several years, the special dividend had been 50 cents each year. However, by getting the report of ASA’s holdings and calculating how much they were receiving in dividends, it appeared that they would have to pay a special dividend in excess of \$2.50 in order to pay out most of the unusual dividend income they were receiving that year.

I checked this information with a small research firm with whom we had a friendly working relationship, and they concurred with my analysis. However, the option market had not factored this information in at all. If you know there is going to be a special dividend, then the puts should be expensive and the calls cheap, to reflect the fact that the stock will go ex-dividend with no corresponding benefit to the option holders. In reality, the options were priced exactly as if the special dividend was going to be 50 cents, as usual.

Trading the arbitrage account for Thomson McKinnon, we established risk-free conversions by buying stock, buying puts, and selling calls. We were paying only 50 cents for the special dividend portion of the conver-

sion, however. As we established these conversions, market makers and others taking the other side made it quite obvious that they thought we were fools for overpaying for the arbitrage. If you have a truly original idea, this is the point where you must gather yourself and ignore the “traditional” information. By the time we had set up 100,000 shares, the markets adjusted, and some of the bigger market makers had come to see our point of view.

Eventually, the big day came. ASA Limited held their dividend meeting in New York on a Thursday morning and did indeed decide to declare a \$2.50 special dividend. However, they only made a brief press release and headed out for lunch. Reuters News Service picked up the release and issued a one-line message; but Dow Jones would not publish the news because they needed confirmation (a company policy), and no one was at the ASA offices—they were all at lunch! This caused us consternation because, in those days, very few people—not us—had Reuters News; Dow Jones was the news “king.” So we had to wait through the lunch hour in order to be sure that we were going to officially make our profits. We succeeded.

---

What was especially amazing was that this strategy worked for the next several years, but never to the same degree. It only “disappeared” when the price of gold got into a real bear market and the South African stocks stopped paying large dividends in the mid-1980s. In retrospect, it appears that the reason that this strategy worked was twofold: (1) not many people were interested in it, and (2) the information regarding the South African dividends was not widely published, although it was certainly available to anyone who bothered to look for it.

You can see the difference between the Disney example and the ASA example: one was an obvious fact that everyone knew, while the other was a public fact that no one was paying any attention to. When we refer to serious research that you must stand behind, even if no one else is believing it or acting upon it, we are referring to something akin to the ASA example.

Lest you feel that those sorts of things only happened in the early days of options, when people were less sophisticated, I want to describe the potential available in two-tiered tender offers. The similarities between the St. Joe Minerals takeover in 1981 and the Chiron takeover in 1994 are striking.

Both takeovers involved partial-tender offers, with a residual stock trading after the partial tender. This is sometimes referred to as a “two-tier” deal. Before getting into the actual historical examples, a general one explaining two-tier deals and how options can be used with them might be useful.

---

*Example:* In a two-tier deal, the company doing the buyout usually makes a cash tender offer for a percentage of the company to be acquired, something like 50 percent or so; this initial tender is called *the front end*, while whatever happens afterwards is called *the back end*. After the front-end tender is completed, the remainder of the company to be acquired, called *the stub*, trades freely in the marketplace, sometimes with a different name. In the 1980s, the acquiring company could then make a tender offer for the stub as well; but laws were changed, so currently the stub has to trade as stock.

While the first part of the two-tier deal—the cash tender offer—is taking place, the stock being acquired will trade at a price that reflects the *total* value of both parts of the deal. Suppose that ABC is going to buy XYZ in a two-tier deal. It is going to offer \$100 a share for 50 percent of the company; after that, the remaining stub, which represents 50 percent of the original XYZ, will trade freely in the marketplace. Furthermore, suppose that analysts place the value of the stub at \$60 per share.

We would then see XYZ trading at about 77 per share; for if you bought 100 shares of XYZ and tendered them, you would get 100 for 50 shares, and the other 50 shares would be worth 60 (if the analysts’ estimates are correct), which you could sell in the open market. Thus, you would sell the XYZ for an average of \$80 per share (half at 100 and half at 60). The reason that XYZ sells for slightly less than 80 is that some carrying cost is built into the current price, since it takes time for the tender to be completed and for the stub to begin trading. As the actual date of the cash tender approaches, XYZ will drift upward toward 80.

---

Before reading on, with XYZ at 77, what price would you expect a put with a striking price of 80 to sell for in the preceding example? The answer is at the end of the next paragraph.

In-the-money calls on XYZ in the example would be trading at parity prior to the first part of the deal, the cash tender offer. They wouldn’t have any time value premium because the stock will drop 20

points (from 80 to 60) as soon as the first part of the deal is over. If you owned calls on XYZ in this example, you could always exercise them and tender the stock you got via the exercise. If you didn't, your calls would lose a tremendous amount of value (you can't tender calls, only stock). Puts, on the other hand, reflect the value of the stub. So, since the stub is supposedly going to be trading at 60, a put with a striking price of 80 would have to sell for at least 20 points. This is an important concept that is not readily understood by the average option trader.

The two-tier deal just described was not new to Wall Street in 1981, when Fluor Corporation decided to bid for St. Joe Minerals. However, since puts had only been listed for a short while at that time (they were first listed in 1977), this may have been the first two-tier deal in which the company to be acquired—St. Joe Minerals—had listed puts available.

---

Fluor Corporation made a two-tiered bid for St. Joe Minerals in 1981. The front end was for 60 percent at a price of 60. The back end was also scheduled to be a tender offer—at an unspecified price in the high 40s. As I recall, the cash tender in the front end was to expire in early February, so we were buying February puts to hedge the stock being purchased.

For reasons that I never quite understood, the marketplace was offering a virtually free arbitrage. With St. Joe trading at 53, the Feb 55 puts were selling at about 9. These are rough numbers, as a lot of years have passed since this arbitrage was executed; but they are indicative of what happened. Consider this trade:

Buy 1,000 St. Joe at 53	\$53,000 debit
Buy 4 Feb 55 puts at 9	3,600 debit
Sell 600 St. Joe at 60 via tender	36,000 credit
Sell 400 St. Joe at 55 via put exercise	22,000 credit
Net credit:	1,400 credit

As long as the front end of the deal went through, this was guaranteed money. Apparently, most institutional money managers and many other arbitrageurs were skeptical about the back end of the deal and, thus, weren't willing to pay too much for St. Joe—they kept the price around 53. The rel-

ative newness of put options meant that they either didn't realize puts were available for trading, or they didn't visualize being able to lock in the back end by buying the puts. In any case, we made a very nice profit.

---

You might think that situations like that would have disappeared as the years went by. To a certain extent, you would be right. However, these two-tier deals are rather rare; and whenever one appears, there seems to be opportunity for the buyer of stock who also hedges himself with puts. This was true as recently as the end of 1994, when Chiron was involved in one of these two-tier deals.

---

This was the "deal" for Chiron (symbol, CHIR): a partial tender offer was being made for 40 percent of the company at \$117 per share. The remainder of the company was then to exist in the open market, trading as its own stock once again. The partial tender was probably going to happen before January option expiration, but there was a chance that a second request for information by the government could delay the payout until after January expiration.

Here were the current prices at the beginning of December with CHIR at 75:

Dec 70 call: 5¼	Dec 70 put: ¼
Jan 70 call: 6	Jan 70 put: 7½
April 70 call: 7	April 70 put: 18

Anyone with any understanding of option prices at all would have to know that the Jan 70 and April 70 puts look very expensive—but why? The novice often views such puts as an attractive sale. Moreover, the novice would probably not understand why Chiron was only trading at \$75. Note that the calls are trading near parity, only reflecting enough time value premium to account for the time until the front-end tender actually occurred.

Now, I didn't have the wherewithal to analyze what the back-end stub would be worth, but I didn't need to. Apparently, analysts had looked at what the remaining company would contain and had decided that it would be worth something in the low 50s. I knew this, even without talking to one of these analysts. Why? Because we have to assume that the arbitrageurs are not stupid and have priced the stock properly, where "properly" means that they could make about a three-point profit or so if the deal goes

through and their analysis is correct. Since a Chiron shareholder would sell 40 percent of his stock at 117, the total value of his stock would be:  $0.40 \times \$117 + 0.60 \times \text{stub} = \$78$ . With Chiron currently at 75, leaving a little room for arbitrage profit ( $78 - 75$ , or 3 points) on the total deal is about right for carrying costs, and so on. Solving this equation, we find that the stub is projected to be worth 52.

Now, admittedly, there could be some conjecture over whether the back end (the part of Chiron that is going to trade after the partial-tender offer) is worth more or less than 52. However, given that the current price of Chiron (\$75) is “predicting,” arithmetically, a price of 52, the put options had to be priced as if Chiron were going to be there when the tender ended. Thus, if Chiron were 52, an April 70 put should be worth about 18, which is exactly where it was trading. As in the two previous examples, the puts’ prices are only related to where Chiron would be trading *after* the tender; put holders or sellers would not participate in the partial tender offer at 117.

Okay, so why were the Jan 70 puts only selling for 7? Weren’t they a steal? Actually, the Jan puts were a huge speculation, because it wasn’t known whether they would be worth zero (if the tender were not completed before January expiration) or 18 (if the tender were finished before January expiration). Only people who had some specific feeling on the timing for the deal should have traded the January puts.

The strategy that we established was to buy Chiron stock at these levels and to buy the *April* puts against the remaining 60 percent position. For example, buy 1,000 CHIR and buy 6 April 60 puts. Then, as long as the partial tender at 117 takes place, the downside risk is limited by the presence of the long puts.

If, for some reason, CHIR traded at a price higher than 52, then we might be able to generate additional profits, for we would, in effect, own the stub and the April 60 puts—which is equivalent to owning an April 60 call. So if the stub really took off, we would own free calls.

The risk, of course, is that something happens to “break” the deal, and the partial tender never takes place. In that case, CHIR would collapse and large losses would occur on the 1,000 long shares of stock, despite the presence of the six long puts.

The way things worked out, that was an unnecessary worry. As the tender date approached (which turned out to be *before* January expiration), Chiron stock rose slightly to just over 80. This rise, however, reflected more optimistic estimates for the back end of the deal. In fact, the stub opened for trading at 61 (much higher than the original estimate of 52) and eventually traded all the way up to 67. The “equivalent” calls that were bought for a

fractional price, eventually became worth \$7. Thus, the two-tier strategy paid off, just by observing what was happening in the arbitrage and by constructing the appropriate hedge using the puts.

---

Why didn't everybody set up this hedge? I don't really know. Although one logical reason is probably *size*. The positions held by arbitrageurs and money managers in Chiron were so huge that there just weren't enough puts available for purchase to hedge the positions. Thus, a smaller trader can sometimes have a safer trade than the "big boys."

## OPTION TRADING PHILOSOPHY

In this final section of the book, we discuss some of the aspects of trading that are specific to options. These are not all-encompassing, nor do they guarantee a profit; but if you follow these guidelines, you will have the best chance of being successful with your option trading. These guidelines are *not* the path to easy riches; but following them will generally keep you out of trouble, increase your efficiency of capital, and hopefully improve your chances of making money with options. If you are an experienced option trader, you probably follow a lot of these guidelines subconsciously, not even bothering to think about them. However, if you're new to option trading, then these might prove to be things that you'd want to check as you establish a new position. Some of these have been mentioned in earlier sections of the book, but they are important enough to stress again.

Trade in accordance with your comfort level.

There is a myriad of strategies that option traders can employ. Some will be more in line with your risk and reward levels than others. For example, some traders don't like to buy options. In fairly stagnant markets, the daily wearing away of the option due to time decay is more than they can handle. If this is the way that *you* feel, then you may want to specialize in spread trading and volatility selling.

On the other hand, if you are not comfortable selling naked options, then don't. Even though such strategies are nicely profitable



for some traders, they should not be used if they cause you sleepless nights or other consternation.

---

A friend of mine was an option trader on the floor of the AMEX. As was the custom in the mid-1980s, he was a rather large seller of naked options. However, somewhere along the way, he stopped selling options. I asked him why, and he replied, “I was wishing my life away. I always wished it was next month so that the options would expire.”

---

My favorite story regarding an aversion to selling naked options, though, goes back to someone you would least expect—a very risk-oriented individual, who was head of an arbitrage department.

---

In the 1970s and 1980s, it was common for most of the equity risktaking of a firm—even one as large as PaineWebber—to be done by one department. Thus, the department would trade risk arbitrage, convertible arbitrage, index arbitrage, reversal and conversion arbitrage and also would take a certain number of risk-oriented positions. These risk-oriented positions might be some outright long or short positions in stock, some option strategies, and so forth.

A good friend of mine was trading convertible arbitrage and also setting up option strategies. The head of the department was a well-known arbitrageur who didn't blink at positions of several hundred thousand shares in a risk arbitrage position. However, he didn't really understand options too well. So one day, in 1974, he asked my friend to explain his position in IBM options. Apparently the position had been marking to market at a small loss, and the head of the department wanted to know why. The reason was that IBM had been rallying in October and November, coming out of its oversold bottom of the 1973–1974 bear market.

The position was a one-by-two ratio call spread—the specific details are forgotten, but it was on the order of being long 100 IBM Jan 240 calls and short 200 Jan 270 calls. The spread had an upside break-even point of about 300. Thus, it was net naked short about 100 IBM calls, and IBM was trading around 210 or 220.

So the trader explained that the position was good for another 80 points or so on the upside over the next three months, and that it could make about \$300,000 if IBM got to 270 at expiration. However, the head of the department wanted to know what the result would be if IBM were at

350. When told that this would be a loss of \$500,000, he said “What if the Arabs take over IBM at 350? We’re screwed. Take off the position.”

---

Now that’s paranoia. What were the odds of the Arabs (who were extremely powerful with their OPEC cartel in those days) even *wanting* a computer company? Probably something way less than 0.1 percent. Still, it was too much risk for this otherwise heavy-risk taker. At the least, the department head, an experienced trader, knew what made him uncomfortable, and he didn’t want to pursue that strategy any longer.

Your comfort level extends beyond just deciding whether to trade options strictly from the long side or the short side. It goes deeper—more toward your approach to the overall market. Some people prefer hedging, some prefer speculating. Hedgers generally limit their overall profit, but they also have less risk than speculators do. If hedged positions drive you crazy because you know you’ll have a losing side as well as a winning side, then perhaps you should trade options more as a speculator, forming opinions and acting on them accordingly.

---

One friend of mine, back in the early 1970s, was trading the house account for one of the major grain companies. That is, he was risking their money in the futures market. After a successful career doing that, he decided that he could do better as a floor trader, and he moved to Chicago and bought a seat on the Chicago Board of Trade (CBOT) to primarily trade corn.

His first major position was a very large intramarket spread in corn, something like long May, short March, perhaps. He had always approached the market as a speculator, so this position was a little foreign to him; but he felt that the safety of the spread was a good idea. It turned out to be a bad idea. No matter which way the price of corn went—up, down, or sideways—the spread continued to go against him and cost him money. Eventually, the losses wiped out all the equity in his account.

He later became one of the biggest and most successful corn speculators, but he never traded a hedged position again.

---

The important thing to realize is that it is much easier to make money if you are “in tune” with your strategies, whatever they may

be. No one strategy is right for all traders, due to their individual risk and reward characteristics and accompanying psychological demands.

Many traders don't like speculating, preferring a more conservative tack. If that is your philosophy, that's fine. You should look for hedged positions with a statistical edge and not attempt to day trade or engage in other forms of short-term speculation.

---

There's an interesting footnote to the previous story about the grain trader. He did go broke from that corn spread but was able to borrow money and get started again. Eventually, after he had made his fortune, he told me that there's a saying: "You're never broke until you go broke twice." What he meant was that many successful traders went broke once but bounced back to make large profits. The first time was a learning experience.

Now, I'm not sure that everyone needs to go broke before becoming successful, but it happens to a lot of traders. Those who learn from their initial mistakes can recover to become successful traders.

---

Always use a model.

We have, throughout the book, referred to the necessity of employing a model to evaluate options. The biggest mistake that option traders make is failing to check the fair value of the option before it is bought or sold. It may seem like a nuisance—especially if you or your broker don't have real-time evaluation capability—but this is the basis of all option investments, whether they be strategic or speculative. You need to know whether you're getting a bargain or paying too much for the option.

Don't always use options—the underlying may be better  
(if options are overpriced or markets are too wide).

This statement is related to the previous tenet of using a model. Sometimes it's better to trade the underlying stock or futures contract than it is to trade the options, especially if you're looking for a quick trade. Over a short time period, an overpriced option may significantly underperform the movement by the underlying instrument.

There are other advantages to trading the underlying. For one thing, there is more liquidity, and markets are therefore tighter. Also, you can more readily use stop orders (I don't recommend using stop orders on options themselves). On the other hand, the advantages to trading options are leverage, limited dollar risk, and a possible theoretical advantage if the options are cheap.

Avoid buying out-of-the-money options.

In Chapter 4, we stressed the importance of buying in-the-money options as a substitute for the underlying stock. So this is a related statement. In reality, there are some rare occasions on which you might benefit from buying out-of-the-money options, but it would generally be to limit your risk to a fixed amount in a highly volatile situation. We discussed the Federal Paperboard (FBO) bull spread as an example of that. Another example is Sybase.

---

In Chapter 4, we related the story of how Sybase (SYBS) had heavy put volume, and then the stock collapsed when the company forecast poor earnings. This was an extremely volatile stock, so that even the in-the-money options had a good deal of time value premium. With the stock at 42 and the negative rumors being very rampant, the following option prices existed (April was the near-term month) for SYBS: 42:

April 50 put: 9½

April 45 put: 5½

April 40 put: 2

April 35 put: none available for trading

These all had ridiculously high implied volatilities, which would have collapsed had the negative rumor proved to be false. If there had been an April 35 put listed, I would probably have bought a bear spread (buying the April 40 or 45 put and selling the April 35). But, since there wasn't, I was faced with the choice of buying an expensive in-the-money put or buying the out-of-the-money April 40 put. The April 40 was, of course, the most expensive in terms of implied volatility, but it also offered the least dollar risk. Therefore, I decided on the amount of money that I was willing to lose in this issue and bought the April 40 puts. It was the only out-of-the-money option that I bought all year.

---

This example is atypical in that the in-the-money options were so expensive. In that case, and that case only, would I consider buying an out-of-the-money option.

Don't buy more time than you need.

The longer-term options often appear, to the naked eye, to be better buys. For example, suppose XYZ is 50, the Jan 50 call costs 2, and the April 50 call costs  $2\frac{3}{4}$ . You might feel that the April 50 is the better buy, even if both have the same implied volatility (i.e., neither one is more expensive than the other). This could be a mistake, especially if you're looking for a short-term trade. The excess time value premium that you pay for the April call and the resultant lower delta that it has both combine to limit the profits of the April 50 call vis-à-vis the Jan 50 call. On the other hand, if you're looking for the stock or futures contract to move on fundamentals—perhaps better earnings or a crop yield—then you need to buy more time because you don't know for sure when the improving fundamentals will reflect themselves in the price of the underlying.

Know what strategies are equivalent and use the optimum one at all times.

Equivalent strategies have the same profit potential. For example, owning a call is equivalent to owning both a put and the underlying instrument. However, be aware that the capital requirements of two equivalent strategies (and their concomitant rates of return) can vary widely. The purchase of the call will only cost a fraction of the amount needed to purchase the put and the underlying stock, for example. However, the call purchase has a much larger probability of losing 100 percent of that investment.

The option positions that are equivalent to long stock (or long futures) and to short stock (or short futures) are perhaps the most important ones.

Buying a call and selling a put, both with the same terms (strike price and expiration date), produces a position that is equivalent to being long the underlying instrument. Similarly, buying a put and selling a call with the same terms is equivalent to being short the underlying instrument. The next three guidelines deal with these

equivalences. It was shown in Chapter 3 that the equivalent option strategy may be better than owning the underlying stock itself. Also, the equivalent option strategy is better than selling stock short and, of course, is the only way to completely short an index. Not only that, it doesn't require a plus tick to establish the short position. Finally, the equivalent option strategy is mandatory knowledge for futures traders, for it allows them to extricate themselves from a position that is locked limit against them.

Trade all markets.

There are strategic option opportunities in all markets—equities, indices, and futures. To ignore one or two of these just doesn't make sense. The principles of option evaluation that are needed to construct a statistically attractive strategy apply equally well to all three markets. Furthermore, there are often intermarket hedges that are extremely reliable; but in order to take advantage of them, you have to trade all of the markets.

Have a little humility.

The market has a way of exacting a toll on braggarts. Whenever I meet someone at a social function and he starts telling me about his winning trades, I know I'm not talking to a professional trader. Professional traders, if they want to tell you about their trading *at all*, will more likely tell you about their losses (those are often better stories, anyway). Also, *remember not to confuse brains with a bull market*. That is, if you got lucky in a position because the market moved your way, don't feel that you are of superior intellect; you might get stung the next time.

## **The Biggest Mistake**

I'm often asked what is the biggest mistake that novice option traders make. There are a lot of good answers to this question: not trading with volatility (or, alternatively stated, not using a model) is a

good answer. So is failing to use good money management, both in terms of stops as well as taking partial profits. But the one that seems to me to be the most applicable is that most novice traders—and some not so novice ones, too—put too much *hope* in a position. They buy options that have too little time remaining and that are too far out-of-the-money. They are too optimistic. So, use a model, manage your positions well, and take a realistic view of the position's prospects.

## **SUMMARY**

The information included in this chapter was less specific in nature than the trading systems, strategies, and methods described in earlier chapters. However, since trading is more of an art than a science, this information is extremely important. First, there were suggestions on basic brokerage and data gathering. We also described techniques to help with money management. The historic examples illustrated some of the good points and bad points of speculation and option trading. Finally, we laid out some general guidelines on the philosophy of trading.

## Appendix A

# Listed Index and Sector Options

The following lists are index options and HOLDERS that trade options. You should also be aware of the fact that there are a considerable number of other Exchange Traded Funds (ETFs) listed on the Chicago Board Options Exchange (CBOE) and on the American Stock Exchange (AMEX). The best place to find a current list of these would be at the web sites of the exchanges themselves.

Airline Index: \$XAL  
Asia 25 ADR Index: \$EYR  
Biotech: \$MVB  
Biotech: BTK (AMEX)  
Banking: BKX (PHLX)  
Mexico: MEX (CBOE)  
S&P 500: SPX  
Technology: TXX (CBOE)  
Broker Dealer: XBD  
Computer & Technology: XCI  
Consumer Stock: CMR  
Cyclical Stock: CYC  
Cable Media (SIG): \$SCQ  
Commodity Related Stock Index: \$CRX  
Composite: \$GTC  
Computer Box Maker: \$BMX  
Defense Index: \$DFI or \$DFX  
Deutsche Bank Energy: \$DXE  
Disk Drive Index: \$DDX  
Dogs of the Dow: \$MUT  
Dow Jones 30 Industrials: \$DJX  
Dow Jones Transportation: \$DTX  
Dow Jones Utility Average: \$DUX  
Dow Jones Internet Commerce: \$ECM  
Drug Index: \$RXS (PHLX)  
Drug Stock: DRG



Euro 25 ADR Index: \$EOR  
Europe Sector Index: \$XEX (PHLX)  
Gold Index: \$GOX  
Gold Bugs Index: \$HUI  
Gold and Silver: XAU  
Hardware Index: \$GHA  
Housing Index: \$HGX  
Insurance Index: \$KIX (KBW)  
Interest Rate Indices:  
    Short-Term Interest Rates: IRX  
    5-Year Treasury Note: FVX  
    10-Year Treasury Note: TNX  
    30-Year Treasury Bond: TYX  
Internet: \$MOX  
Internet Index: \$INX  
Investment Manager Index: SMQ (SIG)  
Hong Kong: HKO  
Institutional: XII  
Japan: JPN  
Major Market: XMI  
Morgan Stanley High Tech: MSH  
Multimedia Networking Index: \$GIP  
Natural Gas: XNG  
Nasdaq 100: NDX  
Nasdaq 100 Mini-Index: \$MNX  
Nasdaq Biotech: \$NBI  
Oil Index: \$OIX  
Oil Service: \$OSX  
Oil Services: \$MGO  
Oil Stock: XOJ  
OTC Prime Sector Index: \$OTX  
Retail Stock Subindex: RLX  
Retail: \$MVR  
Russell 2000: RUT  
Russell 3000 Value: \$RAV  
Russell 3000 Growth: \$RAG  
Russell 1000 Value: \$RLV  
Russell Midcap: \$RMC  
Russell 1000 Growth: \$RLG  
Russell 3000 Index: \$RUA  
Russell 1000 Index: \$RUI

Russell 2000 Value: \$RUJ  
 Russell 2000 Growth: \$RUO  
 Russell Midcap Value: \$RMV  
 S&P 100: OEX, CPO  
 S&P 100 (OEX) European style: \$XEO  
 S&P 500: SPX  
 Semiconductor: SOX  
 Semiconductor Index: \$GSM  
 Service Index: \$GSV  
 Small Cap 600 Index: SML  
 Software: \$GSO  
 theStreet.com Internet Sector: \$DOT  
 Utility Stock Subindex: UTY

**HOLDRS (HOLDing company Depository Receipts)  
Listed on the AMEX**

Biotech HOLDRS: BBH  
 Broadband HOLDRS: BDH  
 B2B Internet HOLDRS: BHH  
 Europe 2001 HOLDRS: EKH  
 Internet HOLDRS: HHH  
 Internet Architecture HOLDRS: IAH  
 Internet Infrastructure HOLDRS: IIH  
 Market 2000+ HOLDRS: MKH  
 Oil Service HOLDRS: OIH  
 Pharmaceutical HOLDRS: PPH  
 Regional Bank HOLDRS: RKH  
 Retail HOLDRS: RTH  
 Semiconductor HOLDRS: SMH  
 Software HOLDRS: SWH  
 Telecom HOLDRS: TTH  
 Utilities HOLDRS: UTH  
 Wireless HOLDRS: WMH

ETFs: A rather complete listing is usually available at [www.amex.com](http://www.amex.com). On the left-hand menu, click on ETFs. In the drop-down menu, select "All ETFs." Not all of those that are listed have options, for some ETFs trade by themselves.



## Appendix B

# Futures Options Terms and Expirations

The following data were accurate at the time of publishing, but expiration date definitions may change (contract sizes may change, too, but those are quite infrequent). If you want up-to-date information, either contact your futures broker, or visit the web site of the Institute for Financial Markets ([www.theifm.org](http://www.theifm.org)) and subscribe to the "Futures and Option Fact Book," which is the most comprehensive information available on this subject.

Underlying	\$ / Point of Movement	Expiration Date
British Pound	\$625 (150.00–151.00)	Second Friday before third Wednesday
Canadian Dollar	\$1,000 (72.00–73.00)	Second Friday before third Wednesday
Cattle, Feeder	\$500 (80.00–81.00)	Last Thursday that's not a holiday
Cattle, Live	\$400 (72.00–73.00)	First Friday
Cocoa	\$10 (1,100–1,101)	First Friday of preceding month
Coffee	\$375 (82.00–83.00)	First Friday of preceding month
Copper	\$250 (87.00–88.00)	Fourth day preceding LBD* of preceding month
Corn	\$50 (260–261)	Friday preceding LBD of preceding month by $\geq 2$ business days
Cotton	\$500 (80.00–81.00)	Third business day of month
Crude Oil	\$1,000 (16.00–17.00)	(See a calendar)
CRB Index	\$500 (250.00–250.00)	Second Friday of contract month
Deutsche mark	\$1,250 (58.00–59.00)	Second Friday before third Wednesday

*(continues)*

## 622 APPENDIX B: FUTURES OPTIONS TERMS AND EXPIRATIONS

Underlying	\$ / Point of Movement	Expiration Date
Dollar Index	\$1,000 (84.00–85.00)	Second Friday before third Wednesday
Dow Jones	\$10 (10,500–10,501)	Third Friday of contract month
Euro Currency	\$1,250 (113.00–114.00)	Second Friday before third Wednesday
Eurodollar	\$2,500 (94.00–95.00)	Second London business day before third Wednesday
Five-Year Note	\$1,000 (102.00–103.00)	Friday preceding last day of preceding month by at least 2 business days
Gasoline (unleaded)	\$420 (48.00–49.00)	(See a calendar)
Gold	\$100 (381.00–382.00)	Second Friday of preceding month
Heating Oil	\$420 (46.00–47.00)	(See a calendar)
Hogs, Live	\$400 (45.00–46.00)	First Friday
Japanese Yen	\$1,250 (97.00–98.00)	Second Friday before third Wednesday
Lumber	\$160 (326.00–327.00)	Last Friday of preceding month
Muni Bonds	\$1,000 (90.00–91.00)	Eighth-to-last business day
Nasdaq-100	\$100 (1400.00–1401.00)	Third Friday of contract month
Nikkei Stock Average	\$500 (201.00–202.00)	Third Friday (second Friday in Mar, Jun, Sep, Dec)
Orange Juice	\$150 (100.00–101.00)	First Friday of preceding month
Platinum	\$50 (388.00–389.00)	Second Friday of preceding month
Pork Bellies	\$400 (54.00–55.00)	(See a calendar)
Silver (COMEX)	\$50 (525.00–526.00)	Second Friday of preceding month
Soybeans	\$50 (653–654)	Friday preceding LBD of preceding month by $\geq 2$ business days
Soybean Meal	\$100 (187.00–188.00)	Friday preceding LBD of preceding month by $\geq 2$ business days
Soybean Oil	\$600 (25.00–26.00)	Friday preceding LBD of preceding month by $\geq 2$ business days

Underlying	\$ / Point of Movement	Expiration Date
S&P 500 Index	\$500 (443.00–444.00)	Third Friday
Sugar (#11)	\$1,120 (11.00–12.00)	Second Friday of preceding month (Dec: second Friday of Dec)
Swiss Franc	\$1,250 (69.00–70.00)	Second Friday before third Wednesday
T-Bills	\$2,500 (95.00–96.00)	(See a calendar)
T-Bonds	\$1,000 (105.00–106.00)	Friday preceding LBD of preceding month by $\geq 2$ business days
T-Notes	Same as T-Bonds	Same as T-Bonds
Ten-Year Note	\$1,000 (102–100 to 103–100)	Friday preceding last day of preceding month by at least 2 business days
Wheat	\$50 (314–315)	Friday preceding LBD of preceding month by $\geq 2$ business days

\*LBD: last business day.

*Note:* If no month is specified, *option* contract month is assumed; “preceding month” refers to month preceding *option* contract month.



## Appendix C

# Option Models

### Black-Scholes Model

$$\text{Value} = pN(d_1) - se^{-rt}N(D_2)$$

where

$$d_1 = \frac{\ln(p/s) + (r + v^2/2)t}{v\sqrt{t}}$$

$$d_2 = d_1 - v\sqrt{t}$$

The variables are:

$p$	stock price
$s$	striking price
$t$	time remaining, in years
$r$	current risk-free interest rate, usually the 90-day T-bill rate
$\ln$	natural logarithm
$N(d)$	normal density function
$v$	volatility (annual standard deviation)

The normal density function can be approximated with the following polynomial. First, calculate the values for  $x$ ,  $y$ , and  $z$ . To find  $N(\sigma)$ :

$$z = 0.3989423e^{-\sigma/2}$$

$$y = 1/(1 + 0.2316419 |\sigma|)$$

$$x = 1 - z(1.330274y^5 - 1.821256y^4 + 1.781478y^3 - 0.356538y^2 + 0.3193815y)$$

Then  $N(\sigma) = x$  if  $\sigma > 0$ , or  $N(\sigma) = 1 - x$  if  $\sigma < 0$



The Greeks can be computed by taking partial derivatives of the model's formula. For example,

$$\text{Delta} = N(d_1)$$

$$\text{Gamma} = \frac{e^{-x/2} / \sqrt{(2\pi)}}{pv\sqrt{t}}$$

where 
$$x = \ln\left(\frac{p}{s(1+r)^t}\right) / (v\sqrt{t}) + v\sqrt{t}/2$$

## Binomial Model

Believed by some to be more accurate than Black–Scholes because it gives the modeler the ability to define his own distribution of prices, the binomial model involves more calculations than the Black–Scholes model does. However, with today's faster computers, that's less of a consideration than it once was. The model is also known as the Cox–Ross–Rubinstein (C-R-R) binomial model.

To begin, construct a lattice as shown in Figure C.1. The left side of the lattice represents the current stock price. The defined probabilities are then used to determine the stock prices all along the lattice. The width of the lattice represents the time periods that a trader might be willing to consider from the current time until expiration (in actual practice, up to 50 time periods may be used to value an option).

In the example lattice shown here, it is assumed that the stock can make only two movements: either up 20 percent or down 20 percent for each time period. Furthermore, assume that we are only considering three time periods. In this simple example, the stock must be either at 172.8, 115.2, 76.8, or 51.2 after three time periods. Note that each up node is 1.2 times the previous node, while each down node is 0.8 times the previous node.

Once this process is completed, the intrinsic value of an option at the right-hand side of the lattice is easily determined. For example, if

we were trying to evaluate a call with striking price 100 that expired after three periods, then we can see that the options would be worth the following at expiration:

<i>Stock Price</i>	<i>Option Value at Expiration</i>
172.8	72.8
115.2	15.2
76.8	0
51.2	0

Now, we'd like to also know with what probability these moves occur. The C-R-R formula gives us a formula to determine this:

$$p = (R - d) / (u - d)$$

where  $p$  = probability of an up move

$$R = e^{rt}$$

$r$  = risk-free interest rate

$t$  = years remaining until expiration

$u$  = size of an up move

$d$  = size of a down move

**Figure C.1**  
**BINOMIAL MODEL LATTICE**

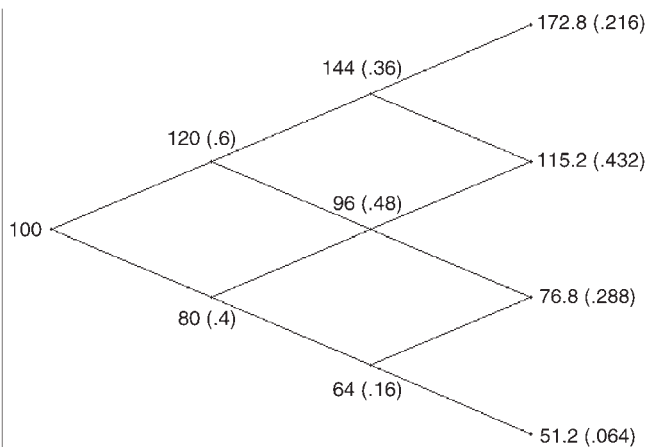

In our simple example, the size of an up move,  $u$ , is 1.2 (a 20 percent increase), while the size of a down move is 0.8 (a 20 percent decrease). Furthermore, for simplicity's sake, assume  $R = 1.04$ . Then we can calculate:

$$p = (1.04 - 0.8) / (1.2 - 0.8) = 0.6$$

Thus,  $p = 0.60$ , so there is a 60 percent chance that the stock will rise during the time period, and, of course, that means that there is a 40 percent chance that it will decline. This is something like the lognormal distribution in that there is a larger chance that the stock will rise than that it will decline.

All of this information is summarized in Figure C.1. The stock prices at each node are shown, as well as the probability of each of them occurring—the number in parentheses. Note that a node that has *two* inputs (one from above and one from below) has a probability equal to the sum of the probabilities from the previous node.

Finally, we can use this information to determine the theoretical value of a call today at the initial node. We merely calculate the intrinsic value at expiration times the probability of being at that node, for each node, and sum them. In this example, the call value ( $C$ ) is

$$\begin{aligned} C &= 0.216 (172.80 - 100) + 0.432 (115.20 - 100) \\ &\quad + 0.288 (0) + 0.064 (0) \\ &= 15.72 + 6.57 + 0 + 0 = 22.29 \end{aligned}$$

Thus, the theoretical value of a three-period call with striking price 100, with the stock at 100, under these assumptions, is 22.29.

In general, the C-R-R model gives us the following formula for determining the value of a call at any node. All that is required is to know the call value at the *succeeding* node. Thus, in actual application, we evaluate the lattice *from right to left* in order to determine the value of the call at the initial node.

The way we do this is to use the C-R-R formula to determine the theoretical call value,  $C$ :

$$C = \frac{pC_{up} + (1-p)C_{down}}{R}$$

where

- $p$  = probability of an up move
- $R = e^{rt}$
- $C_{\text{up}}$  = value of the call if the underlying moves up by  $u$
- $C_{\text{down}}$  = value of the call if the underlying moves down by  $d$

If we are evaluating the tree *from right to left*, we always know  $C_{\text{up}}$  and  $C_{\text{down}}$ , so this is a quick computation.

To summarize, then, we first establish the lattice from left to right, using the assumptions about stock price movement. Then, we work from right to left, using the formula just given to arrive at a theoretical value for the call itself.

For further information on the use of the C-R-R model, you should read *Options Markets*, by John C. Cox and Mark Rubinstein (Prentice-Hall, 1985).



# Index

- ADM, 232–233
- Advance-decline line, 374–377
- Advanced Fibrecom (AFCI), 169–170
- Advanced Micro Devices (AMD), 35, 249–250
- Agricultural options trading, 11
- AIQ, 581
- Alliant Technology (ATK), 315
- Altria, 172
- Amax Corp., 71
- America Online (AOL), 315
- American Cyanamid (ACY), 203–205
- American depository receipts (ADRs), 236
- American Express (AXP), 315
- American Home Products, 203, 205
- American Medical Holdings (AMI), 556–558
- American Stock Exchange (AMEX), 9–10, 27, 102, 308, 385, 414, 465, 617–619
- American-style options:
  - characteristics of, generally, 23
  - European options distinguished from, 381–382, 384, 387
- Amgen, 26
- Analysis, *see* Fundamental analysis; Technical analysis
- Arbitrage (arb):
  - defined, 120
  - diagonal spread, 88–89
  - index, 120–124
  - option volume and, 194–197
  - postexpiration, 157
  - put-call ratio, 297
  - See also* Index arbitrage
- Arbitrageur(s):
  - exercises by, 22–24
  - implied volatility, 283
  - index, 122–124, 128–129, 130–131, 143–145
  - intermarket spread, 381, 384, 387
  - put-call ratio, 284–285
  - risk, 144–145
  - trading with, 148–149
- Arms, Richard, 377
- Arms Index, 342–343, 348, 377
- ASA Limited, 603–604
- Assignments:
  - European-style options, 385
  - implications of, 15–19
  - mechanics of, 19–22
  - partial tender offers, 110–111
  - volatility skew and, 539, 543–547
- At-the-money options:
  - buying, 51
  - delta of, 39
  - implied volatility, 478
  - index futures, 136
  - as insurance, 164
  - put-call ratio, 303
  - ratio spreads, 93
  - seasonal tendencies, 429
  - spreads and, 90
  - volatility changes, 489, 506
  - volatility skew, 521, 528, 541, 545
  - volume and, 227
- AT&T, 9, 88, 161, 164
- Atlantic Richfield, 9

- Automatic execution system, 570–571  
 Avon, 8
- Back-end tender, 605
- Backspread:  
   call, 96–98, 530–531  
   characteristics of, generally, 96  
   long straddle and, 97–98, 478–479  
   put, 98–99, 525–526, 530–531  
   volatility and, 272, 471, 478–479,  
     500, 511, 513–514, 532–536,  
     540, 568
- Banker's Trust, 452
- Banking (BKX) sector, 308, 310
- Bankruptcy, 566
- Banksouth (BKSO), 244–245
- Barbarians at the Gate* (Burrough/Helyar), 600
- Barclays Global Investors, 10, 308,  
 405
- Barings Bank, 123–124, 453
- Barron's*, 147
- Bear/bearish market, 36–37, 54, 62,  
 70, 76, 177, 223, 256–257,  
 267, 276, 284, 289, 297,  
 302, 314, 330, 407, 436
- Bear spread, 70, 81–83, 90, 99, 525,  
 547
- Beat the Market* (Thorp/Kassouf),  
 585
- Bell Atlantic, 14
- Bell curve, 521–522
- Bell Telephone Laboratories, 588
- Bendix Corporation, 600
- Beta, 160, 163
- Bethlehem Steel (BS), 231–232
- Better Software People, The, 580
- Bid-ask spread, 40, 227, 309, 407,  
 467
- Binomial model, 626–629
- Biotech stock, 33
- Black-Scholes option pricing model,  
 170–171, 523, 625–626
- Bloomberg terminal, 578–579
- Blow out, 20
- Boeing (BA), 315
- Boesky, Ivan, 601–602
- Bond market, influential factors, 138,  
 147, 420
- Bonneville, 355
- Break-even point, 94, 462, 467, 470,  
 473, 477, 548, 560–561
- Breakout, 234, 341
- British pound (BP), 334–335, 339,  
 621
- Broker, functions of, 230
- Brokers/brokerage, 572–576,  
 584–585. *See also specific  
 types of brokers*
- Brunswick, 9
- Bull/bullish market, 78, 97, 112–114,  
 257–259, 289, 297, 313, 327,  
 375, 417, 615
- Bull spread, 77–81, 83, 99, 227, 525,  
 575
- Butterfly spread, 99–100
- Buy-and-hold strategy, 584
- Buyers, trading procedures, 12–14
- Buy point, 434–439
- Buy signal:  
   intraday signals, 371–372  
   moving averages, 341–344  
   put-call ratio, 299, 301–304, 306,  
     313–314, 318, 321, 322,  
     324–327, 330–332, 334–338,  
     345  
   seasonal tendencies, 432–433  
   TICKI day trading, 359–361  
   volatility and, 264–265
- Buy stop, 233
- Caesar's World, 200–201
- Calendar spread, 85–88, 471,  
 479–483, 511–513, 555–558,  
 562–563
- Call backspread, 96–98, 530–531
- Call calendar spread, 480
- Call option, generally:  
   break-even point, *see* Break-even  
   point

- buying, 55–57
- defined, 3
- delta of, 39
- exercise and assignment of, 15
- exercising, 8
- intermarket spread, 379–380
- in-the-money options, 15–16
- in over-the-counter market, 7
- price influences, 36
- striking price, 17
- Call ratio spread, 92–94, 464–465, 525–527
- Call ratio write, 501
- Canadian dollar, 621
- Cap Cities ABC, 223
- Capital gains, 118, 388
- Cash option, exercise of, 22–24
- Casino gambling, 587–588
- Cattle options, 322. *See also* Live cattle
- CBOE Futures Exchange (CFE), 177–178
- Certificate of deposit (CD), 117
- Chandelier stops, 596
- Chevron-Texaco (CVX), 316
- Chicago Board of Trade (CBOT), 7–8, 30
- Chicago Board Options Exchange (CBOE):
  - equity-only put-call ratio, 284
  - functions of, generally, 27, 102
  - historical perspective, 6–9
  - implied volatility, 354
  - listed options, 617–619
  - OEX, *see* OEX
  - put-call ratio, 287
  - VIX, 281–282
  - Volatility Index (VXO), 177, 263–268, 278–280, 282
- Chicago Mercantile Exchange (Merc), 9, 30, 337, 358
- Chipcom (CHPM), 207–210
- Chiron (CHIR), 604, 607–609
- Cigna (CI), 316
- Cisco (CSCO), 169–171, 316
- Cities Service Company, 598–600
- Citigroup (C), 315
- Closing price, 343–344, 465, 577
- Closing stop, 224–225, 230, 596
- Closing trade, 12
- Coca-Cola, 43–44, 316
- Cocoa, 339, 340, 621
- Coffee, 28, 324, 326–327, 339, 340, 621
- Collar, 69, 81, 158–159, 168–174
- Collateral, 63–64, 73, 80, 106–107, 533, 541, 546, 549, 600
- Combination:
  - naked, 461–462, 466–467, 482
  - purchases, 58–59
  - sale of, 73–77
  - short, 74
  - short naked, 506
  - trading volume, 193
  - volatility and, 482
- Commission, 6–7, 17, 30–31, 118, 467, 573–575
- Commodities:
  - implied volatility and, 257
  - options volume and, 236
  - reverse volatility skew, 524–525
  - striking price, 3
  - types of, 24–25
  - volatility and, 257
  - See also specific types of commodities*
- Commodity Research Bureau Index, 2
- Common stock, 118, 128, 237
- Compaq, 189
- Composite graphs, 390
- Condor, 99
- Conoco, 598
- Contrarians, 265, 284–285, 288, 298
- Conversion arbitrage, 194
- Copper, 322, 340, 621
- Corn:
  - futures, volatility skew, 528–529
  - options, 25, 28, 236, 257, 322, 340, 378, 527, 612, 621



- Corporate news events, impact of,
  - 187, 189, 222–223, 233, 236,
  - 238–241, 457, 460
- Cotton:
  - futures, 113, 115
  - options, 327, 330, 621
- Covered call writing:
  - characteristics of, 60–62
  - volatility increases and, 258–262
- Covered straddle writing, 76–77
- Covering, 20–21
- Cox-Ross-Rubinstein (C-R-R) binomial
  - model, 626–629
- CRB index, 322, 429, 621
- Credit spread, 80, 83–85, 90, 99
- CRX Index, 424
- Currency futures, 86–88
- Currency options, put-call ratio,
  - 334–338
- Customer, firm distinguished from,
  - 13
  
- Daily oscillator value, 366
- Daily Volume Alert, 226–227
- Data Broadcasting Corporation,
  - 577–578
- Data vendors:
  - costs, 576–577
  - data connection, 577–580
  - function of, 576–580
- Dayton Hudson, 21
- Day trading, 141, 590
- Day-trading vehicles:
  - intraday market-reversal corollary,
    - 363–366
  - overview of, 353–355
  - See also* TICKI Indicator, day trading
- Dealer, functions of, 6–7
- Debits:
  - bear spread and, 81
  - bull spread and, 80
  - cash-based options, 23
  - limit moves and, 115
- Deciles, volatility measure, 458–459,
  - 468, 470, 477
- Decimalization, 376–377
- Deflation, 420
- Delayed quotes, 577
- Dell Computer (DELL), 316
- Delta:
  - buying options, 51
  - characteristics of, 37–38, 484
  - computation of, 626
  - defined, 445
  - influential factors, 39–42
  - neutral trading, *see* Delta neutral trading
  - volatility and, 486–491
- Delta neutral trading:
  - characteristics of, 445–454, 511,
  - 513, 515, 533, 536, 547
  - hedge, 585
  - implied volatility, 474–475
  - trading volatility, 506–511
- Den of Thieves* (Stewart), 600
- Depository trusts, 10
- Deutsche mark, 339, 621
- Diagonal spread, 88–89
- Diamonds (DIA), 304, 308
- Discount, intermarket spread, 381,
  - 386–388, 390
- Discount brokers, 573
- Discount rate, 494
- Disney (DIS), 169, 223, 602, 604
- Dispersion trade, 283
- Dividends, 7, 33, 36, 42, 107,
  - 117–118, 173, 388
- Dollar index, 340, 622
- Dollars per point, 29
- Dollar-weighted put-call ratio, 284,
  - 287
- Dow Jones (DJX), 285, 304, 308
- Dow Jones Industrial Average (DJIA),
  - 2, 54, 123–124, 274,
  - 355–356, 371, 426, 622
- Downtick, 156
- Downtrends, 258

- Dow Theory Letter* (Russell), 375  
 Drawdowns, 437  
 DTN Wallstreet, 579
- Earnings reports, 43–44, 212, 224  
 Eastman Kodak (EK), 9, 316, 349  
 Economic indicators, 362  
 Electronic entry system, 570–571  
 Electronic futures broker, 30  
 Electronic trading, 14–15, 30  
 ELKS (equity-linked securities), 101  
 E-mini futures (ES), 304, 402–404  
 Emotional trades, 586, 596  
 End-of-day quotes, 583  
 End points, 40  
 Equifax (EFX), 246  
 Equity-only put-call ratio, 284–285, 291, 293, 298, 302, 304  
 Equity options, defined, 1  
 Equity put-call ratio, 345–348  
 Equity put options, 158  
 Equity requirements, 62  
 Equivalent futures position (EFP), 446  
 Equivalent stock position (ESP), 446, 449–451, 499  
 Equivalent strategy, 409, 614–615  
 Errors:  
   restitution for, 14  
   tracking, 174–175  
   types of, 13–14  
 eSignal, 579, 581  
 Euro currency (EC), 337, 339, 622  
 Eurodollar, 622  
   futures options, 6, 11, 13  
   put-call ratios, 338–340  
 European-style options, 23, 381–389  
 Event-driven straddle buy, 253  
 Exchange fees, 577  
 Exchange-traded funds (ETFs):  
   characteristics of, 23  
   historical perspective, 9–10  
   intermarket spreads, 423  
   January effect, 403  
   list of, 617–619  
   put-call ratios, 308–310  
 Exchanging physical for futures, 26  
 Ex-dividends, 22, 33, 388  
 Exercises:  
   call options, 543  
   cash options, 22–24  
   mechanics of, 19–22  
   overview of, 15–18  
   prior to expiration, 22  
 Exotic options, 175–176  
 Expected investment, 566  
 Expected return analysis, 558–559, 564–567  
 Expensive stock options, 238–241, 525  
 Expiration date:  
   defined, 3–4  
   exercising options and, 15–17  
   futures options, 28  
   index futures, 129–148  
   individual stocks, effect on, 155–157  
   intrinsic value and, 15–16  
   options volume and, 190–191, 197–199  
   out-of-the-money options, 15–16  
   serial options, 31–32  
   single stock futures, 27  
   time remaining until, 33  
 Exponential moving average, 367  
 Exxon, 8
- Fair value, 35–36, 120–121, 124, 351–352, 359–360  
 Farmer's Group, 198  
 Federal Paperboard (FBO), 228, 448–450, 460, 613  
 Federal Reserve System, 138, 264, 269, 375, 443–444, 493–494  
 Feeder cattle, 621  
 Fibonacci numbers, 587  
 Financial newspapers, as information resource, 581  
 Firm trader, functions of, 13, 16–17

- First Alert, 581
- First day notice, 25–26
- Five-year note, 622
- FLEX options, 12
- Floor broker, 571–572
- Floor traders, 134, 611
- Fluor Corporation, 606
- Food and Drug Administration (FDA), 248–249, 251–255, 490–491, 565
- Ford, 9, 424
- Foreign exchange markets, 10
- Foreign stock markets, 2, 123–124, 465
- Forward volatility skew, 519–520, 523
- Front-end tender, 605
- Fundamental analysis, 42–44
- Futures contracts:
  - characteristics of, 2, 24–25
  - defined, 2
  - first day notice, 25–26
  - limit moves, 112–116
  - unit of trading, 29
- Futures equivalent, 379
- Futures Magazine*, 28
- Futures-only put-call ratio, 286
- Futures options:
  - calendar spread and, 86–87
  - characteristics of, generally, 23–25
  - commissions, 30–31
  - cost of, 4–6
  - defined, 2
  - delta, 37–42
  - electronic trading, 30
  - exercise and assignment, 19–21
  - expiration, 3–4, 28, 621–623
  - fair value, 351–352
  - first day notice, 25–26
  - history of, 10–11
  - price quotes, 29–30
  - put-call ratio, 318–340
  - serial options, 31–32
  - single stock futures, 26–27, 111–112
  - strike price, 3, 28–29
  - terminology, 28–32
  - terms, 621–623
  - trading volume, 340
  - unit of trading, 29
  - volatility indices, 27–28
- Futures trader, option trading procedures, 12–14
- Futures trading, 26
- Gamma:
  - advanced constructions, 514–516
  - computation of, 626
  - delta neutral, 499, 501–502, 504
  - of the gamma, 514–515
  - neutral positions, 454–455, 508–511, 515
  - volatility, 511, 514
- Gas:
  - natural, 32, 324, 331–334, 340
  - unleaded, 321, 339, 389–391, 394, 396–397, 399, 622
- General Electric (GE), 316
- General Motors (GM), 99, 160, 164, 316, 349, 424
- Genesis Financial Data Systems, 580
- Genetech, 252
- Gensia Pharmaceuticals, 251, 490–491
- Gerber (GEB), 21, 205–207, 239–240, 242–243
- Gillette, 600–602
- Globex, 30, 358
- GNMA futures, 1
- Gold, generally:
  - characteristics of, 32, 82, 93–94, 319–321, 326, 339
  - first day notice, 25–26
  - historical volatility, 456
  - stocks versus price, 380–381, 409–414
  - terms and expirations, 622
  - trading philosophy and, 603–604
  - volatility, implications of, 477, 520

- Gold and Silver Index (\$XAU), 2, 285, 308, 310, 381
- Goldman Sachs, 11, 175, 451
- Good-until-canceled orders, 13, 528
- Grain futures, 90, 99, 257
- Grain options, 257–258, 528, 612
- Greeks:
  - delta, 484, 486–491
  - gamma, 495–514
  - model of, 484–486
  - overview of, 483–484, 495–498, 626
  - rho, 484, 493–494
  - software programs, 580–581
  - theta, 484, 493
  - vega, 484, 491–493
- Grupo Tribasa (GTR), 233–234
- Guarantors, 8
- Gulf & Western, 9
- Gulf Oil, 598
  
- Handheld devices, 577–578
- Hang Seng Index, 465
- Hedge/hedging:
  - delta neutral, 585
  - index futures, 129–130
  - intermarket, 615
  - naked put writing, 68
  - options volume and, 191–192
  - over-the-counter options, 174–177
  - put-call ratio, 284–285
  - trading philosophy, 611
  - volatility futures, 178–183
  - volatility skewing, 507, 542, 546, 550
  - warrants, 585–586
- Herd mentality, 295
- Hewlett-Packard (HPQ), 316
- High-flying stocks, 54
- Historical volatility:
  - characteristics of, generally, 34–35, 79, 163–164, 282
  - defined, 442
  - gold, stock versus prices, 413
  - implied volatility compared with, 457–460
  - option volume, 241–242
  - predicting, 283
  - speculative trades, 243, 245, 248, 593
- H. J. Heinz, 41
- Holder:
  - bull spread and, 80
  - defined, 16
  - exercise and assignment, 22
- HOLDRS, 308, 310
- Home Shopping Network, 189
- Hong Kong Index, 2
- Hong Kong Option Index (HKO), 465–470
- Hong Kong Stock Exchange, 465
- Horizontal spread, 86
- HUG/HOG spread, 389–399
  
- IBM stock, 3–4, 8, 26, 68, 75–76, 85, 87, 111, 163, 175, 188–189, 201, 253, 258–262, 287, 316, 349, 378, 562–563, 594, 610–611
- Illiquidity/illiquid options, 400, 594
- Implied volatility:
  - day trading and, 355
  - defined, 442–443, 456
  - delta neutral trading, 445–449, 455, 474–475
  - historical volatility compared with, 457–460
  - implications of, generally, 34–35, 79, 102, 164
  - index options, 262–277
  - market trends predictions, 256–283
  - moving average, 241–244
  - option volume and, 237–238, 242–250, 253
  - predicting, 442–444
  - seasonal tendencies, 426–430
  - skewing, *see* Volatility skew
  - speculative trades, 241–248, 593

- Implied volatility (*continued*)
  - trading:
    - buying, 471–483
    - selling, 461–471
  - trading gap predictions, 248–253
  - trend predictions, 256–258
- Index arbitrage, 120–124
- Index equivalent, 379
- Index futures, effect on stock market:
  - at expiration, 129–149
  - generally, 119–129
  - postexpiration, 149–157
- Index options:
  - conversion to cash, 22–24
  - cost of, 4–6
  - defined, 2
  - historical perspective, 9–10
  - implied volatility of, 262–268
  - list of, 617–619
  - unit of trading, 29
- Index put-call ratio, 286, 290, 292, 307–308, 348
- Individual investors, 584
- Inside traders, 191–192, 233
- Institutional brokers, 128–129, 294, 297, 572
- Integrated Silicon, 189
- Intel (INTC), 189, 249, 316, 317
- Interdigital Communications (IDC), 247–248, 250
- Interest rates, implications of, 33, 36, 42, 107–108, 111, 173, 237, 420, 442–443, 454, 567
- Interindex spreading, 378
- Intermarket hedges, 615
- Intermarket quotient, 412–413
- Intermarket spread:
  - European-style options, 23, 381–389
  - gold, stocks versus price, 380–381, 408–414
  - HUG/HOG spread, 389–399
  - January effect, 399–408
  - oil, stocks versus price, 414–419
  - overview of, 378–381
  - pairs trading, 378, 424–425
  - similar-sector index versus futures, 422–424
  - T-bonds, 30-year, 419–422
  - utility stocks, 419–422
- Intermediate-term trading, 584
- Internal Revenue Service (IRS), 101
- In-the-money options:
  - bull spread, 79
  - buying, 50–52
  - call backspread, 97
  - credit spread, 84
  - defined, 7
  - delta of, 37–38, 40–41
  - European-style options, 381–382, 387
  - exercise and assignment of, 15–17, 22
  - HOG/HUG spread, 396
  - index futures, 135–136, 137, 139, 142–143, 145–146, 149
  - intermarket spread, 379–380
  - January effect, 405
  - limit moves, 114
  - options volume, 200, 227
  - put-call ratio, 304
  - short stock, 109–110, 116–117
  - short-term, 227
  - speculative trading, 594
  - trading philosophy and, 605–606
  - volatility and, 487–488, 496
  - volatility skew, 538, 551
  - volume and, 195
- Intraday market-reversal corollary, 363–366
- Intraday stop, 230
- Intraday trading, 275
- Intramarket spreads, 378
- Intrinsic value, 15–16, 626
- Investor's Business Daily*, 28
- iShares, 10, 308–309, 405–407, 418–419
- ITT Corporation, 201
- January effect, 399–408, 436
- Japanese stock market, 123–124

- Japanese yen (JY), 336, 339, 340, 622
- Japan (JPN) Index, 2, 308, 310, 385–386
- Johnson & Johnson (JNJ), 316
- Jumbo CBOE Volatility Index (VXB), 178
- Jumbo Volatility Index (VIX), 178
- Junk bonds, 600
  
- Kassouf, Sheen, 585
- Kelly, J. L., Jr., 588
- Kelly System, 588–592
- Kerr McGee, 8
- Keynes, John Maynard, 374
- K-Mart, 8
- Kresge, 8, 18
  
- Large-cap index, 407–408
- Large-cap stocks, 399, 401–402
- Last trading day, 25
- Lattice, binomial model, 626–627
- LEAPS:
  - as collars, 169–174
  - European-style options, 385–386
  - impact of, 4, 54–55, 68
  - as long-term stock substitute, 117–119
  - puts, 118–119
  - volatility and, 488, 493–494
- Leverages, 111, 188
- Limit moves, 112–116
- Limit orders, 13, 234, 594
- Liposome Technology (LIPO), 254–255, 324
- Liquidation, 230
- Liquid option contracts, 286, 340
- Liquidity, 308
- Listed options, history of:
  - Chicago Board Options Exchange (CBOE), 6–9
  - exchange-traded funds (ETFs), 9–10, 617–619
  - futures options, 10–11
  - index options, 9–10
  - over-the-counter market, 6–7, 11–12
- Litigation, 386
- Live cattle, 32, 323, 339, 532, 621
- Live hogs, 324, 330, 339, 622
- Local maxima/minima, 290, 298, 322, 342, 345, 414
- Lockheed-Martin (LMT), 316
- Loews, 9
- Lognormal distribution, 521–524, 567
- Long call, 107
- Long-call-short-put option, 115
- Long futures, 130
- Long options, as stock protection:
  - buying call options, 55–57
  - buying put options, 52–55
- Long puts, 70
- Long-Term Capital Management (LTCM) Hedge Fund Crisis, 256, 275
- Long-term options, *see* LEAPS
- Lotus Corporation, 201
- Lumber futures, 112–116, 622
  
- McDonald's (MCD), 9, 316
- McMillan Analysis Corp., 18, 287–288, 367
- Marathon Oil, 598
- Margin:
  - call, generally, 275
  - defined, 24, 111
  - rates, 575
  - requirement, 62, 138, 358, 391, 507–508, 530, 575
  - rules, 8
- Market conditions, significance of, 352, 455, 550
- Market corrections, 430–432, 595
- Market declines, 306–307
- Market makers, 8, 16, 71, 156–157, 191–192, 215, 381–384, 387, 451–452, 594
- Market not held orders, 13
- Market on close orders, 13, 139–140

- Market orders, 13, 109, 595
- Market reversals, 363–364, 372
- Market Wizards* (Schwager), 597
- Martin Marietta, 599–600, 602
- Matsushita, 223
- Maxtor, 189
- MCA/United Artist, 223
- Mental stop, 224, 229–230, 542, 573, 595–596
- Merck (MRK), 9, 316
- Mexico Index, 2
- Micron Tech, 189
- Microsoft (MSFT), 26, 106, 108, 111, 189, 312–315, 456
- Midcap 400 Index (MID), 101–102
- Milken, Mike, 600
- Mini-Value Line (MV), 402–405
- Momentum oscillators, 366–367
- Money management, 225, 230–232, 294, 519
- Money stop, 404–405
- Morgan Stanley, 11, 175, 424, 451
- Morgan Stanley High Tech Index (MSH), 308–310
- Motorola (MOT), 213–216, 250
- Moving average:
  - crossover system, 343
  - exponential, 367
  - implications of, generally, 341–350
  - implied volatility, 241–244
  - put-call ratio, 289, 298, 340
  - techniques, overview, 341–350
  - 20-day, 237–238, 240
- Muni Bond Index, 2
- Municipal bonds, 378–379, 622
- Mutual funds, 375
- Naked call writing, 69–73
- Naked options:
  - characteristics of, generally, 461, 575
  - implied volatility, 469
  - selling, 18, 83–84, 469
  - volatility, 508
  - writing, 62–64
- Naked put writing:
  - characteristics of, 64–67, 107
  - philosophy, 67–68
  - protection strategies, 68–70
- Nasdaq, 109
- Nasdaq100 Index (NDX), 282, 308, 310, 622
- Nasdaq 100 Tracking Stock (QQQ), 10, 13, 263, 282, 285, 295–296, 307, 310
- Natural Gas Sector Index (\$NGX), 308, 310, 422
- NCR Corp., 88–89
- NeoPharm Inc. (NEOL), 565–566
- Net cost of switching, 117–118
- Neutral positions:
  - keeping, 450–454
  - types of, 452–454
  - See also* Greeks
- New York Stock Exchange (NYSE), 10, 102, 131, 139, 356, 366, 577
- Nick the Greek, 587
- Niederhoffer, Victor, 275
- Nifty 50 stocks, 54–55
- Nikkei 225 Index, 385–386
- Nikkei stock average, 622
- No-cost collar, 169–170
- Normal distribution, 521–522
- Northwest Airlines, 9
- Novell, 189
- NQLX, 27
- Occidental Petroleum (OXY), 598–599
- OEF, 304, 405–406
- OEX:
  - arbitrage, 130–137
  - call exercise, 543–544
  - characteristics of, generally, 23–24, 34, 83–85
  - day-trading vehicles, 353–355
  - defined, 132
  - futures fair value and, 351–352
  - hedging, 137–142, 161–162

- implied volatility and, 256, 262–268, 270–271, 443–444, 457–458, 532
- index futures expiration, 143–149
- insurance protection, 164–166
- market reversals, 363–364
- probabilities, 560–561
- put-call ratios, 292–293, 299–307, 318–319, 324, 433
- seasonal tendencies, 426–429, 436
- short-term trading, 368–369
- speculative trades, 593
- volatility, impact on, 267–283
- volatility skew, 518, 532, 534–540, 543–544, 550–553
- Oil:
  - crude, 32, 322, 339, 340, 414–419, 532, 621
  - heating, 64, 322, 340, 389–391, 394, 398–399
  - stocks versus price, 414–419
- Oil & Gas Index (\$XOI), 236, 308, 311, 414–419
- Oil Index, 2
- Oil options, 257–258, 332
- Oil Service (\$OSX) sector, 308, 311
- Oil Service HOLDERS (OIH), 418
- OneChicago, 27
- Opening sell transaction, 20
- Opening settlement, 131–132
- Open interest, 12
- Optimism, 616
- Option calculators, 583
- Option Clearing Corporation (OCC), 8, 19, 21, 176
- Option Evaluator, 583
- Option Master, 583
- Option modeling:
  - access to, 102–103
  - applications, generally, 102–103, 107–108
  - binomial model, 626–629
  - Black-Scholes model, 625–626
- Option premium, 250, 265, 453
- Option price, *see* Price; Strike price
- Option Pro, 581
- Options:
  - cost of, 4–6
  - defined, 1
  - electronic trading, 14–15
  - exercise and assignment, 15–24
  - as insurance policy, 157–168
  - listed, *see* Listed options
  - price influences, 32–37, 42
  - technical analysis, 42–44
  - terminology, 3–4
  - trading procedures, 12–14
  - types of, 3
- See also specific types of options*
- Option strategies:
  - buying put and call options, 57–59
  - long options as stock protection, 52–57
  - option models, 102–103
  - outright option buying, 47–52
  - profit graphs, 45–47
  - ratio strategies, 91–102
  - selling options, 59–77
  - spreads, 77–90
- Option Strategist*, 529
- Option trading philosophy, 609–615
- Option volume, as indicator:
  - analysis of, 190–202
  - average, 188, 191, 226–227
  - examples of:
    - American Cyanamid (ACY), 203–205
    - Cap Cities ABC, 223
    - Chipcom (CHPM), 207–210
    - Disney (DIS), 223
    - Gerber (GEB), 205–207, 239–240
    - Matsushita, 223
    - MCA/United Artist, 223
    - Motorola (MOT), 213–216, 250
    - Southern Pacific Railroad, 199–200, 202–203
    - Sybase (SYBS), 216–218
    - Syntex (SYN), 218–222
    - U.S. Shoe (USR), 210–213



- Option volume, as indicator (*continued*)
  - exceptions to, 235–237
  - in-the-money options, 227
  - out-of-the-money options, 227
  - profitability, 223–226
  - quantity, 188–190
  - significance of, 187–188
  - speculative volume, 227
  - stop orders, 227, 229–235
  - 20-day moving average, 237–238, 241
- Option Vue, 581–582
- Options Laboratory, 583
- optionstrategist.com, 288, 341, 460, 560, 578
- Orange juice, 28, 32–33, 113, 322, 340, 622
- Order desk, 571–572
- Order entry, 14–15, 30, 569–572
- Oscillators:
  - intraday monitoring, 369–374
  - seasonal tendencies, 432
  - short-term trading system, 366–368
- Out-of-the-money options:
  - backspread, 99–100
  - bull spread, 81, 227
  - buying, 49–51
  - call backspread, 97–98
  - covered call writing, 64, 69
  - delta of, 37–41
  - diagonal spread, 89
  - exercise and assignment of, 15–17
  - implied volatility, 283, 462
  - as insurance, 158, 165, 168
  - options volume, 208, 227
  - probabilities, 561–562
  - put-call ratio, 303
  - ratio spread, 93
  - sale of, 90
  - trading philosophy, 613
  - volatility changes, 275, 487–488, 496, 506
  - volatility skew, 519–521, 529, 532, 537, 549
- Outright option purchase, implications of, 47–52
- Overbought market, 268, 342, 366–367, 373–374, 537
- Overpriced futures, 352
- Overpriced options, 241, 355
- Overpriced stock, 67
- Oversold market, 267, 342, 366–367, 372, 374
- Over-the-counter market:
  - current, features of, 11–12
  - historical perspective, 6–7
  - neutral positions, 451–452
- Over-the-counter options, hedging, 174–177
- Overvalued options, 443
- Overvalued stock, 294
- PaineWebber Corporation, 101, 610
- Pairs trading, 378, 424–425
- Panic selling, 291, 302
- Paperless trading, 59
- Parabolic stops, 596
- Parity, 15, 110, 195, 381, 387, 607
- Partial profits, 595
- Pay-later option, 176
- PC Quote, 579, 581
- Pennzoil, 9
- PERCS (Preferred Equity Redemption Cumulative Stock), 99–101
- Pfizer (PFE), 316
- Pharmaceutical (\$DRG) sector, 308, 310
- Phelps Dodge (PD), 409, 423–424
- Philadelphia Stock Exchange (PHLX):
  - characteristics of, 9, 599
  - Gold and Silver Index (\$XAU), 410
  - Utility Index (\$UTY), 388, 422
- Philip Morris, 188
- Platinum, 32, 622
- Polaroid, 9, 55
- Pork bellies, 32, 64, 622
- Portfolio insurance, 119, 124–127, 129, 177–185

- Portfolio management, software
  - programs, 582
- Position delta, 445
- Postexpiration, historical analyses of, 149–155
- Power Options, 581
- PowerAnalyzer, 581
- Preferred stock, 375–377
- Premium:
  - put, 549
  - short-term options, 558
  - time value, 379–380, 396–398, 409, 413, 539
- Price:
  - distributions:
    - bell curve, 521–522
    - lognormal, 521–524
    - normal, 521–522
  - as indicator, 237–256
  - quotes, futures options, 29–30
  - technical analysis, 42–44
- Probability, volatility trading, 558–564
- Probability of rain indicator, 349
- Profitability:
  - option volume and, 223–226
  - volatility trading, 567
  - TICKI day trading, 365–366
- Profit graphs:
  - defined, 45
  - function of, 45–47
- Program trading, 127–129, 358–359
- Progressive betting, 587–588
- Pullback, 234
- Put backspread, 98–99, 525–526
- Put-call ratio:
  - computation of, 284, 286
  - data, 286–289
  - defined, 283–284
  - equity-only, 284–285
  - futures-only, 286
  - futures options, 318–340
  - index, 286
  - interpretation of, 289–308, 349
  - seasonal tendencies, 432
  - sector index options, 308–310
  - trading individual stocks, 312–318
  - trading summary, 339–340
- Put options:
  - buying, 52–55
  - defined, 3
  - exercise and assignment of, 15
  - LEAPS, 118–119
  - naked index, 549
  - overpriced, 452
  - price influences, 36
  - volume and, 190
- Put premium, 107
- Put ratio backspread, 530
- Put ratio spread, 94–95
  
- QQV, 263, 282
- Quaker Oats (OAT), 481–482
- Quote machines, 29–30, 123, 579
- Quote service, 29
- Quotrek, 578
  
- Ratio call write, 91
- Ratio spread:
  - backspread, 95–98
  - butterfly spread, 99
  - call, 92–94
  - characteristics of, generally, 193, 461
  - put, 94–95
  - put backspread, 98–99
  - volatility:
    - delta position, 500–502
    - profit and loss of, 501, 503–504, 508, 510
    - volatility skew, 482–483
- Ratio strategies:
  - ratio spread, *see* Ratio spread
  - ratio writing, 91–92
- RCA, 8
- Realtick TurboOptions, 580–581
- Regional Bank HOLDRS (RKH), 310
- Relative Beta, 160–163
- Retail Index (\$RLX), 473–476

- Reversal arbitrage, 194
- Reverse volatility skew, 524, 530, 551
- Rho, 484, 493–494
- Risk:
  - bear spread, 82
  - bull spread, 78, 80
  - credit spread, 84, 90
  - intermarket spread, 380
  - in long call/short stock, 52–54
  - naked options, 90
  - speculative trading, 594
  - trading programs and, 128
- Risk-adjusted method, 591
- Risk-free interest rate, 493
- Roche, 252
- Round turn, 31
- Rumors, options volume and, 198–199, 206
- Russell, Richard, 375
- Russell 2000 (\$RUT), 310, 405–406
- Russell 2000 Index futures (RU), 406
- Russian debt crisis, 256, 275
  
- St. Joe Minerals, 604, 606
- Salomon Brothers, 11, 451
- S&P, *see* Standard & Poor's
- Santa Claus rally, 434
- Schwager, Jack, 597
- Sears, 8
- Seasonality, 277–281
- Seasonal tendencies:
  - August, 425–430
  - late-January buy point, 436–439
  - late-October buy point, 434–436
  - September-October, 430–434
- Secondary market, 7
- Sector index, 310, 379
- Sector options, 308–310
- Securities and Exchange Commission (SEC), 8, 236
- Seller:
  - assignment positions, 20–21
  - trading procedures, 12–14
- Selling teenies, 71–72
- Sell-offs, 372, 543
- Sell signals:
  - advance-decline line, 375
  - moving averages, 341–344
  - put-call ratio, 299, 302, 306, 318–340
  - seasonal tendencies, 432–433
  - TICKI day trading, 361
  - volatility and, 264–265
- Semiconductor Sector Index (\$SOX), 162–163, 285, 308–309, 310
- Serial options, 31–32, 88
- Service charge, 576
- Sheikh, The, 275
- Short exempt, 156
- Short stock:
  - characteristics of, 121–122, 130, 141–142
  - equivalent, 108–111
  - long call, 55–57
- Short strangle, 467
- Short-term option strategy, 557
- Short-Term Rate Index, 2
- Short-term trading:
  - money management, 584
  - options volume, impact on, 230, 236–237
  - overview of, 366
- Sideways trades, 349, 392
- Signal, 355
- SIGNAL, 29
- Silver, 32, 72–73, 338, 340
- Silver (COMEX), 622
- Silver (SI) futures, 338
- Single stock futures, 26–27, 111–112
- Skewing, volatility, *see* Volatility skew
- Small-cap index, 407–408
- Small-cap stocks, 399, 401–402
- Software programs, 14, 102–103, 190, 226, 349, 443, 580–583
- Soros, George, 275, 303
- Southern Pacific Railroad (RSP), 199–200, 202–203
- Soybean futures, volatility, 33

- Soybean meal, 622
- Soybean oil, 622
- Soybean options:
  - CBOE listing, 11
  - delta neutral trading, 447–448
  - expiration date, 25, 28
  - options volume, 236
  - spreads and, 90
  - volatility skew, 517, 553–554
- SPAN margin, 64, 94, 575–576
- Special-handling desk, 570–572
- Speculation:
  - in expiration week, 143–148
  - implied volatility analysis, 241–248
  - options volume and, 192–194, 235–236
  - put-call ratio, 294, 314
  - short-term options, 557–558
  - trading philosophy, 611–612
  - trading procedures, 592–596
  - volatility skew and, 546
- Speculators, 137–138, 277
- Sperry Rand, 9
- Spreads:
  - attractive, 89–90
  - diagonal, 88–89
  - vertical, 77–85, 525

*See also specific types of spreads*
- SPY (S&P SPDRS), 304
- Stale quotes, 30
- Standard & Poor's (S&P) Comstock, 579
- Standard & Poor's 500, 2, 10
- Standard & Poor's 500 Cash Index (SPX), 140, 178, 184–185, 262, 266, 281, 285, 304, 308, 354, 358, 403–408, 434–436, 438, 623
- Standard & Poor's 500 Depository Receipts (SPDRS), 10, 405
- Standard & Poor's 500 futures, 30–32, 119–120, 355
  - expiration of, 130,
  - intramarket spread, 378–379
  - January effect, 399–409
- Standard & Poor's 500 options, 159–160, 340, 518–519, 550
- Standard & Poor's 600 Small Cap Index fund (IJR), 406
- Standard & Poor's Small Cap Index (\$SML), 406
- Standard deviation, 553, 555, 565–566
- Statistics, volatility trading, 558–564
- Stock Index Securities (SIS), 101–102
- Stock market crash:
  - in 1987, 34, 58, 83, 125–127, 141, 176, 256, 263, 272, 278, 293, 295, 348, 352, 426, 519, 548
  - in 1989, 176–177, 256, 576
- Stock options, defined, 1. *See also* Call option; Put option
- Stock splits, 29, 118
- Stop loss, 358–359, 586, 593
- Stops:
  - actual, 229–230, 595
  - advantages of, 13, 227, 229
  - Chandelier, 596
  - closing stop, 224–225, 230, 596
  - disadvantages of, 229
  - good-until-canceled, 528
  - intraday stop, 230
  - mental stop, 224, 229–230, 542, 573, 595–596
  - money stop, 404–405
  - moving averages and, 343
  - parabolic, 596
  - put-call ratio, 301
  - stop loss, 358–359, 586, 593
  - technical analysis and, 231–232
  - trailing closing, 596
  - trailing stop, 224–225, 229, 341, 360, 435
- Straddle:
  - buying, 57–59, 472–473, 532
  - long, 98, 471–479, 511, 513–514, 547
  - naked, 99, 462

- Straddle (*continued*)  
 probabilities, 559  
 sale of, 73–77, 99, 453  
 seasonal tendencies and, 426–428  
 volatility and, 271–272, 280–281,  
 506, 559, 562
- Strangle:  
 naked, 461–462, 560  
 sale, 463–464  
 short, 467  
*See also* Combination
- Strategy Zone, The, 288, 341, 430,  
 460, 560, 578
- Strike price:  
 defined, 3  
 futures options, 28–29  
 gamma neutral trading, 454  
 as price influence, 35, 42  
 seasonal tendencies, 433  
 volatility and, 480
- Stub, tender offers, 605–606
- Sugar, 32, 326, 339, 622
- Sullivan, Joe, 8
- SUNS (Stock Upside Note Securities),  
 101
- Super-trending trades, 596
- Supply and demand, 112, 381
- Support activities:  
 brokers/brokerage, 572–576  
 data vendors, 576–580  
 order entry, 569–572  
 software, 580–583
- Swissbank, 452–543
- Swiss franc (SF), 86–88, 336, 340, 623
- Sybase (SYBS), 82, 216–218, 613
- Syntax (SYN), 218–222
- Synthetic put, 56, 70
- Takeover rumors:  
 impact of, 198–199, 201, 211,  
 224, 286, 481  
 implied volatility and, 469  
 option volume, 200–201, 206, 212,  
 222–223, 240–241, 244  
 volatility skew and, 556
- T-bill/T-bond/T-note, *see* Treasury  
 bill; Treasury bond; Treasury  
 note
- Technical analysis, 42–44, 230, 334  
*Technical Analysis of Stocks and  
 Commodities*, 434
- Technology stocks, 161–162
- Telecommunications Inc., 14
- Telefonos de Mexico (TMX), 260–262
- Telmex, *see* Telefonos de Mexico  
 (TMX)
- Tender offers, 110, 605–608
- Terrorist attacks (9/11), market impact  
 of, 306, 373
- Texas Instruments, 9, 160, 164
- Theoretical value, 102–103
- Theta, 484, 493, 515
- 30-Year Bond Rate Index, 2
- Thomson McKinnon, 603
- Thorp, Edward, 585
- Three Com, 209
- 3M Company (MMM), 316
- TICKI Indicator:  
 day trading, 353, 355–366  
 index arbitrage, 123, 128  
 Time value premium, 379–380,  
 396–398, 409, 413, 539
- Trading days, 402
- Trading floor, 570
- Trading gaps, 248–253, 598–599
- Trading halt, 274
- Trading methodology/philosophy,  
 609–615  
 actual trading examples, 597–609  
 money management, 584–592  
 speculative trading procedures,  
 592–596
- Trading procedures, 12–14
- Trading systems:  
 day-trading vehicles, 353–355  
 fair value, 351–352  
 intermarket spreads, 378–425  
 seasonal tendencies, 425–439  
 short-term, 366–377  
 TICKI day trading, 355–366

- Trading unit, 446
- Trailing stop, 151, 224–225, 229, 341, 360, 435, 596
- Treasury bill (T-bill), 11, 67, 80, 94, 107–108, 117, 173, 322, 493, 632
- Treasury bond (T-bond), 4, 322, 326, 340, 352, 378–379, 419–422, 429, 532, 623
- Treasury note (T-note), 340, 422, 623
- TRIN, *see* Arms Index
- Turnaround Tuesday, 274
- Two-tier deal, 605
  
- UAL Corp. (UAL), 5, 470–471, 549–550, 560–561
- Underlying security:
  - defined, 3
  - delta of, 40–41
  - options as direct substitute for, 105–116
  - options as proxy for, 116–119
  - types of, 1–3
- Underpriced futures, 352
- United Arab League, 256
- United Bioscience (UBS), 252
- U.S. Bond, 30-year, *see* Treasury bond
- U.S. Dollar Index, 322
- U.S. Shoe (USR), 210–213
- U.S. Surgical, 225, 234–235
- United Technologies (UTX), 316
- Unit of trading, 29
- Unit trusts, 10
- Upjohn, 9
- Uptick, 122
- Utility Index (\$UTY), 2, 308, 310, 379, 388, 422
- Utility stocks, intermarket spread, 419–422
  
- Value Line futures, January effect, 400–404
- Value Line Index (VLE), 2, 9, 378–379, 399, 402–404, 406–408
- Vega, 455, 484, 491–493, 501–507, 509–511, 513
- Vertical spread:
  - bear spread, 81–83, 90, 525
  - bull spread, 77–81, 83, 525, 575
  - credit spread, 80, 83–85, 90
  - defined, 77
  - implications of, generally, 193, 525
- Volatility:
  - direct trades, 281–282
  - futures options and, 33
  - HOG/HUG spread, 394
  - index options, 27, 282–283
  - intermarket spread, 421
  - predicting, 442–444, 455–457
  - seasonal tendencies, 277–281, 426–428
  - See also* Historical volatility; Implied volatility; Volatility skew
- Volatility futures (VX):
  - characteristics of, 177, 282
  - contract details, 178–180
  - options on, 184–185
  - as portfolio insurance, 177–185
  - problems with, 183–184
  - protection strategies, 180–183
- Volatility Index (VIX), 27–28, 178–183, 266–282, 429
- Volatility skew:
  - calculation of, 553–555
  - defined, 479, 568
  - expected return analysis, 564–567
  - forward, 519–520
  - position biases, 550–553
  - positive, 568
  - reverse, 524, 530, 551, 568
  - trading:
    - negative skew, 530–547
    - positive skew, 525–530
    - price distributions, 521–525
    - using probability and statistics in, 558–564

- Volatility skew (*continued*)
  - put ratio spread, 547–550
  - types of, 516–521
- Volume, *see* Option volume, as indicator
- VXN, 263, 282
  
- Wachtel, Larry, 148
- Wal-Mart (WMT), 316
- Walt Disney (DIS), 316
- Warrant trading, 375, 585–586
- Weighted put-call ratio, 291
- Wheat, 25, 31, 322, 340, 623
- Whipsaw, 530
- Wilshire index, 308
- Window dressing, 435
- Wire system, 570
  
- Writer:
  - default by, 8
  - defined, 6
- Written options:
  - best covered writes, 241
  - covered call writing, 60–62
  - defined, 59
  - naked call writing, 69–73
  - naked options, 62–64
  - naked put writing, 64–69
  
- Xerox, 9
  
- Yield, 377
  
- Zero-coupon bond, 101