MCoE SUPPLEMENTAL MANUAL 3-90

FORCE STRUCTURE REFERENCE DATA



BRIGADE COMBAT TEAMS

SEPTEMBER 2013



MCoE SUPPLEMENTAL MANUAL 3-90

TABLE OF CONTENTS

PREFACE	i
VEHICLE IDENTIFICATION	ii
EXPLANATION OF GRAPHICS	iii
INFANTRY BRIGADE COMBAT TEAM	ANNEX A
ARMORED BRIGADE COMBAT TEAM	ANNEX B
STRYKER BRIGADE COMBAT TEAM	ANNEX C

MCoE SUPPLEMENTAL MANUAL 3-90

PREPARED BY:

Organizational Development Branch,
CDID, Concepts Development Division
Building 70
7533 Holtz Avenue
Fort Benning, GA 31905
e-mail: alan.l.farr.civ@mail.mil

PREFACE

PURPOSE: THIS SUPPLEMENTAL MATERIAL PROVIDES AN OVERVIEW OF THE INFANTRY, ARMORED, AND STRYKER BRIGADE COMBAT TEAMS. THIS PUBLICATION IS INTENDED AS A GUIDE ONLY. COMMENTS AND RECOMMENDED CHANGES TO THIS PUBLICATION SHOULD BE FORWARDED TO:
COMMANDER, MCoE, ATTN: ATZB-CIC, 7533 HOLTZ AVENUE,
FORT BENNING, GA 31905

DISCLAIMER

THE INFORMATION DEPICTED HEREIN IS BASED ON CURRENT DATA AT THE TIME OF PUBLICATION. THIS UPDATE REFLECTS THE LATEST APPROVED FORCE DESIGN DECISIONS. THIS DATA WAS TAKEN DIRECTLY FROM THE "R" SERIES TABLES OF ORGANIZATION AND EQUIPMENT (TOE) AND MAY NOT REFLECT ACTUAL MODIFIED TABLE OF ORGANIZATION AND EQUIPMENT (MTOE) AUTHORIZATIONS UNDER WHICH UNITS ARE ORGANIZED.

FIRES BN TRAINING CONSOLIDATION IS NOT SHOWN, INSTEAD ALL FIRES SOLDIERS ARE SHOWN IN RED INDICATING THEIR INTENDED MTOE POSITION.

DISTRIBUTION STATEMENT: Approved for public release; distribution is unlimited.

VEHICLE IDENTIFICATION



M2A3 INFANTRY FIGHTING VEHICLE



M3A3 CAVALRY FIGHTING VEHICLE



M2A2 ODS-E BRADLEY
ENGINEER VEHICLE



M7 BRADLEY FIRE
SUPPORT VEHICLE



M1A2 ABRAMS MBT



M109A6 PALADIN 155SP



M992A2 FA AMMO
SPT VEH (FAASV)



M113A3 (CARRIER PERS (RISE))



M113A3 AMBULANCE



M1064 120MM
MORTAR CARRIER



M1068 CARRIER CP ARMD/
M577A3 CARRIER CP



M577A3 MEDICAL
TREATMENT VEHICLE



M1200 ARMORED KNIGHT



M88A1 MED RCVY VEHICLE



M88A2 IRV (HERCULES)



XM1150 ASSAULT
BREACHER VEHICLE
w/MINE PLOW



TRACTOR FT HIGH SPEED
ARMORED COMBAT M9 ACE



TRACTOR FULL TRACKED
HIGH SPEED: DEPLOYABLE
LT ENGINEER (DEUCE)



M1126 STRYKER
INFANTRY CARRIER



M1127 STRYKER
RECON VEHICLE W/.50 CAL



M1127 STRYKER
RECON VEHICLE W/Mk-19



M1128 MOBILE GUN SYSTEM
(MGS)



M1129 STRYKER
MORTAR CARRIER



M1117 ARMORED SECURITY
VEHICLE (ASV)



M1126 STRYKER
INFANTRY CARRIER



M1127 STRYKER
RECON VEHICLE
W/.50 CAL



M1127 STRYKER
RECON VEHICLE
W/Mk-19



M1128 MOBILE GUN
SYSTEM (MGS)



M1129 STRYKER
MORTAR CARRIER



M1130 STRYKER
COMMAND VEHICLE



M1131 STRYKER
FIRE SUPPORT
VEHICLE



M1132 ENGINEER
SUPPORT VEHICLE



M1133 STRYKER
MEDICAL
EVACUATION VEH



M1134 STRYKER
ATGM



M1135 STRYKER
CBRN
RECONNAISSANCE
VEHICLE

VEHICLE IDENTIFICATION



M1151A1 TRUCK ECV:
ARMT CARRIER



M1151A1 TRUCK ECV:
ARMT CARRIER W/.50 CAL



M1151A1 TRUCK ECV:
ARMT CARRIER W/Mk-19



M1167 TRUCK ECV:
TOW/ITAS CARRIER



M997 TRUCK AMBULANCE
4 LITTER: 4X4 HMMWV



M1165A1 TRUCK EXP CAP:
ENHANCED



M1152A1 TRUCK EXP CAP:
ENHANCED



CPBS

CHEMICAL-BIOLOGICAL
PROTECTIVE
SHELTER SYSTEM (CPBS)



AN/ASM-147

ELECTRONICS SHOP SHELTER
MOUNTED AVIONICS: AN/ASM-147
(SHOWN MTD ON M1078 LMTV)



AN/ASM-146

ELECTRONICS SHOP SHELTER
MOUNTED AVIONICS: AN/ASM-146
(SHOWN MTD ON M1085 MTV)



M1078 TRUCK CARGO:
LMTV



M1079 TRUCK VAN: LMTV



CMD SYSTEM: TACTICAL
(CPP RWS)
(MTD ON M1152A1 HMMWV)



M1152A1 TRUCK EXP CAP:
W/RIGID WALL SHELTER



M1152A1 TRUCK EXP CAP:
ENHANCED W/S788 SHELTER



M1152A1 TRUCK EXP CAP:
W/S250 SHELTER



M1152A1 TRUCK EXP CAP:
W/SECM ORD/ENG APPL

AN/TSQ-190(V)2/3
(TROJAN SPIRIT)



TROJAN SPIRIT (AN/TSQ-190(V)2
OR (V)3)



AN/TSC-154

SMART-T



M916A1 TRUCK TRACTOR:
LET 6X6 66000 GVW W/W



M1083 TRUCK CARGO:
MTV



M1089 TRUCK
WRECKER: MTV



M1157 TRUCK DUMP
10 TON: MTV



M1083 TRUCK: MTV W/TPU



M1084 TRUCK CARGO:
MTV W/MHE



M1085 TRUCK CARGO:
MTV LWB



M1086 TRUCK CARGO:
MTV LWB W/MHE



M1087 TRUCK VAN
EXPANSIBLE: MTV
(T67136)



M1088 TRUCK TRACTOR:
MTV



M977/M985 HEMTT CGO



M978 HEMTT POL TANKER



M984A1 HEMTT WRECKER



M1120 HEMTT LHS



M1074/M1075 TRUCK
CARGO HEAVY PLS
TRANSPORTER 15-16.5 TON

VEHICLE IDENTIFICATION



MULTI-TEMP REFRIGERATED CONTAINER SYSTEM: MTRCS (M30688)



LOAD HANDLING SYSTEM 2000 GAL WATER (HIPPO) (ON M1120 HEMTT LHS)



TACTICAL WATER PURIFICATION SYSTEM (TWPS): (ON M1120 HEMTT LHS)



M969A1 SEMITRAILER TANK: 5000 GAL FUEL DISPENSING



HIGH MOBILITY ENGINEER EXCAVATOR (HMEE)



TRAILER TANK WATER 800GAL (CAMEL)



M1095 MTV TRAILER W/FUEL POD



M1101 LIGHT TACTICAL TRAILER 3/4 TON
M1102 TRAILER HIGH MOBILITY 1-1/4 TON



M1102 1-1/4T TRAILER W/120MM MORTAR QUICK STOW SYSTEM



M1102 1-1/4T TRAILER W/ LIGHTWEIGHT WATER PURIFIER



M1082 TRAILER CARGO: LMTV WITH DROPSIDES



M1095 TRAILER CARGO: MTV W/DROPSIDES (T95555)



STANDARD AUTOMOTIVE TOOL SETS (SATS) TRAILER



CONTAINERIZED KITCHEN (CK)



M129A3 SEMITRAILER VAN: SUPPLY 12 TON



M172A1 SEMITRAILER LOWBED: 25 TON



TRUCK LIFT FORK 4000LB CAP ROUGH TERRAIN



TRUCK LIFT FORK ALL TERRAIN LIFTER ARTICULATED SYSTEM (ATLAS)



M149A2 TRAILER WATER 400 GAL



TOOL OUTFIT HYDRAULIC SYSTEM: (HYSTRU)



LAUNCHER MINE CLEARING LINE CHARGE (MICLIC)



WELDING SHOP TRAILER MOUNTED



DOLLY LIFT SET 2 ½ TON



DOLLY LIFT SET 7 ½ TON



PU 797: GEN SET DED TM: 5KW 60HZ
PU 798: GEN SET DED TM: 10KW 60HZ

VEHICLE IDENTIFICATION (cont)

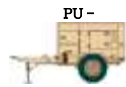

PU -

PU 2003: GEN SET DSL ENG TM: 15KW 50/60HZ
 PU 803: GEN SET DSL ENG TM: 30KW 50/60HZ
 PU 805: GEN SET DSL ENG TM: 60KW 50/60HZ
 PU 806: GEN SET DSL TM 60KW 400HZ



UNMANNED AERIAL VEHICLE LAUNCHER:
 (TUAV-SHADOW)



PWR PLANT: UTILITY

POWER PLANT UTILITY, LARGE
 35KW 12 TON ECU (HVY TMSS)



RADAR SET: AN/TPQ-37(V)9



MED PWR PLANT

POWER PLANT UTILITY, MEDIUM
 20KW 5 TON ECU (MED TMSS)



AN/NJQ-37

POWERPLANT: DSL TRLR MTD 10KW
 60HZ AN/NJQ-37



RADAR SET: AN/TPQ-36(V)10



2.4M KU SATELLITE TERMINAL: SATCOM
 TRANSPORTABLE TRAILER W/ONBOARD 7KW
 GENERATOR



ASSAULT KITCHEN

AK

ASSAULT KITCHEN



HOWITZER, LIGHT TOWED (105MM) M119



HOWITZER, MEDIUM TOWED (155MM) M777



TACTICAL UNMANNED AERIAL VEHICLE
 SYSTEM (SHADOW)



M7 FORWARD REPAIR SYSTEM MOUNTED
 ON HEMTT LHS



M1977 TRANSPORTER COMMON BRIDGE
 W/ RAPIDLY EMPLACED BRIDGE (REB)



M7 FORWARD REPAIR SYSTEM MOUNTED
 ON PLS TRANSPORTER



M1076 TRAILER PLS 8X20



SEMITRAILER LOWBED:
 40 TON 6 WHL M8870A3



M1076 TRAILER PLS 8X20 W/LOAD HANDLING
 SYSTEM 2000GAL CAP WATER TANK (HIPPO)

PU-801

PU 801: GEN SET DSL ENG TM: 15KW 50/60HZ



M1076 TRAILER PLS 8X20 W/RAPIDLY
 EMPLACED BRIDGE (REB)

Explanation of Graphics

TOE Title

TOE Number and Unit Strength

TOE Paragraph

Armor Company, Combined Arms Bn, ABCT

TOE 17307R000
OFF: 5/WO: 0/ENL: 58/TOTAL: 63

(x3) TANK PLATOON PARA 02

AN/VRC-89F
FBCB2
DAGR
EPLRS-V1

C4I
Equipment

AN/VRC-87F
FBCB2
DAGR
EPLRS-V1

AN/VRC-89F
FBCB2
DAGR
EPLRS-V1

AN/VRC-87F
FBCB2
DAGR
EPLRS-V1



LT 19B00 (PLT LDR) M9
SGT 19K20 (GUNNER/ASST TC) M9
SP4 19K10 (TANK CREWMAN) M9
PFC 19K10 (TANK CREWMAN/LDR) M9

SSG 19K30 (TANK CDR) M9
SGT 19K20 (GUNNER/ASST TC) M9
SP4 19K10 (TANK CREWMAN) M9
PFC 19K10 (TANK CREWMAN/LDR) M9

SFC 19K40 (PLT SGT) M9
SGT 19K20 (GUNNER/ASST TC) M9
SP4 19K10 (TANK CREWMAN) M9
PFC 19K10 (TANK CREWMAN/LDR) M9

SSG 19K30 (TANK CDR) M9
SGT 19K20 (GUNNER/ASST TC) M9
SP4 19K10 (TANK CREWMAN) M9
PFC 19K10 (TANK CREWMAN/LDR) M9

x3

Personal Weapon

Multiplier: This shows 3 Platoons, each with 4 Tanks

PAGE INTENTIONALLY LEFT BLANK

MCoE SUPPLEMENTAL MANUAL 3-90

FORCE STRUCTURE REFERENCE DATA



INFANTRY BRIGADE COMBAT TEAM

ANNEX A

SEPTEMBER 2013

FIRES BN TRAINING CONSOLIDATION IS NOT SHOWN. INSTEAD ALL FIRES SOLDIERS ARE SHOWN IN RED INDICATING THEIR INTENDED MTOE POSITION.



INFANTRY BRIGADE COMBAT TEAM

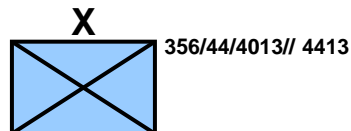

(Objective TOE)
SRC 77300R600

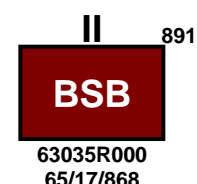
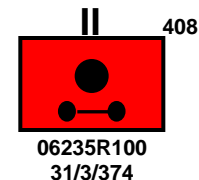
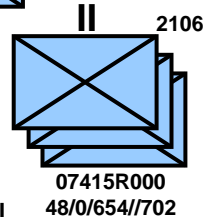
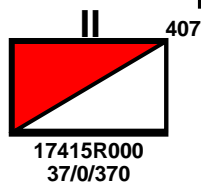
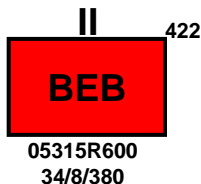
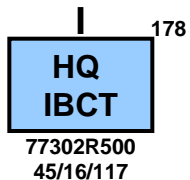

Mission: Disrupt or destroy enemy military forces, control land areas including populations and resources and be prepared to conduct combat operations to protect U.S. national interests.

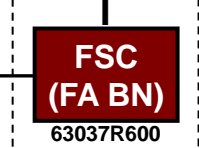
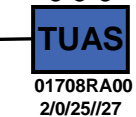
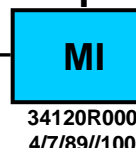
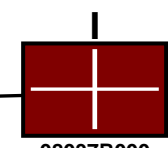
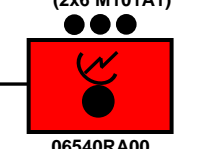
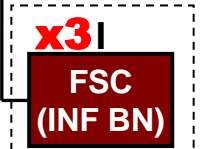
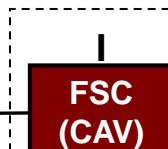
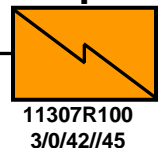
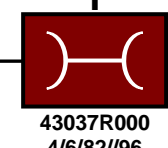
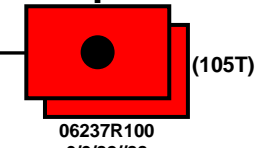
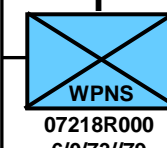
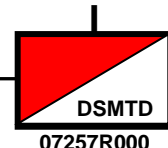
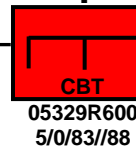
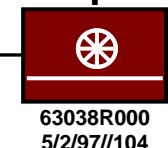
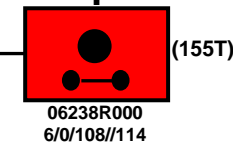
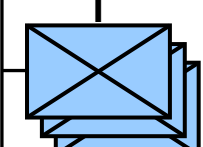
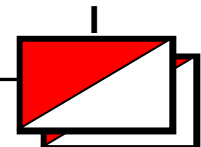
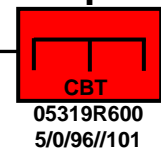
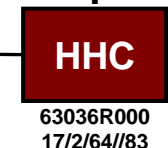
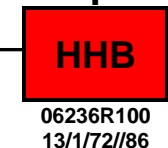
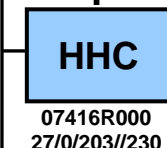
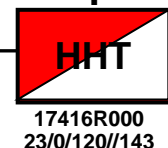
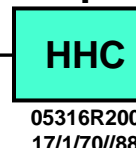

HEADQUARTERS, IBCT

77302R500
45/16/117//178

COMMAND GROUP PARA 01

MISSION: To provide command, control, and supervision of the operation of the brigade and attached units. The Headquarters and Headquarters Company (HHC) also provides operating personnel to support functional requirements for the headquarters.

DAGR x2 NVG
AN/PSC-5 AN/VR-92F
AN/MRC-150 AN/PRC-119F
AN/GYK-48(V)1 AN/VR-104(V)3
AN/UYK-128(V)3



COL 02C00 CDR M4 M9
SSG 11B30 ASST OPS SGT M4
PFC 11B10 VEH DRIVER M4

FBCB2 x2 NVG
DAGR AN/VAS-5
AN/VR-92F AN/VR-104(V)3
AN/PRC-119F AN/UYK-128(V)3



LTC 02C00 DEP CDR M4 M9
(GRADE PLATE REMOVAL)
MOVED TO FIRES :
MAJ 13A00 FIRE SPT COORD M4
CPT 13A00 FIRE CONTROL OFF M4

DAGR x2 NVG
FBCB2 FHMUX
AN/VAS-5 AN/VR-90F
AN/PRC-119F AN/UYK-128(V)3



CSM 00T60 CSM M4 M9
CPT 11A00 OPS OFF M4 AN/PSC-5
SGT 11B20 ASST OPS SGT M4
PFC 25U10 SIG SPT SYS SP M4

CURRENT OPS PARA 02

FBCB2
AN/VAS-5
x2 NVG
DAGR
AN/VR-92F
AN/UYK-128(V)3
AN/TYQ-137B(V)3



LTC 11A00 EXEC OFF M4 M9
MAJ 42H00 S1 M4 M9
MAJ 35D00 S2 M4 M9 AN/PSC-5
SPC 35F10 INTEL ANLST M4

FBCB2
x2 NVG
AN/VR-92F
AN/VR-104(V)3
AN/TYQ-93
AN/TYQ-137B(V)3
ON-721/V
DAGR
AN/PSC-5
AN/GYK-56
AN/TYQ-116(V)3



PWR PLANT: UTILITY

MAJ 27A00 BDE JAG M9
MAJ 46A00 PAO M9
MSG 35X50 CHIEF INTEL SGT M4
SPC 19D10 OPS ASST M4
SPC 13F10 FIRE SPT SP M4

CURR OPS – LNO PARA 03 CURR OPS – FIRE SPT/TACP PARA 04 INTEL CELL – S2X PARA 05

DAGR x2 NVG
FBCB2 AN/VAS-5
AN/VR-90F
AN/UYK-128(V)3



CPT 11A00 LNO M4
SSG 19D30 LNO NCO M4

AN/PED-1 (LLDR)
AN/GYK-56

*MAJ 01A00 AIR FORCE STAFF OFF M4 M9
SFC 00D40 AIR FORCE STAFF NCO M4
SSG 00D30 AIR FORCE STAFF NCO M4

*USAF PERSONNEL – NOT ASSIGNED
TO UNIT

FBCB2 x2 NVG
DAGR AN/VAS-5
AN/PSC-5 AN/VR-92F
AN/PYQ-7 AN/PYQ-3
AN/VR-104(V)3 AN/UYK-128(V)3



FBCB2 2X NVG
DAGR AN/VAS-5
AN/VR-92F ANTYQ-67(V)
(DTSS-L)



PU - 798

x2 NVG DAGR
AN/VAS-5 AN/VR-90F MED PWR PLANT



CPT 35F00 TEAM CHIEF M4 M9
CW2 351M0 HUMINT COLL TECH M9
CW2 125D00 GEOSPATIAL EN TECH M4
SFC 12Y40 SR GEOSPATIAL EN SGT M4
SGT 35L20 CI AGENT M4
SGT 35G20 IMAGERY ANLST M4
SGT 12Y20 GEOSPATIAL EN SGT M4
SGT 35M2L HUMINT COLLECTOR M4
SPC 12Y10 GEOSPA EN M4
SPC 35G10 IMAGERY ANLST M4
PFC 12Y10 GEOSPATIAL EN M4

PLANS CELL PARA 06

DAGR x2 NVG
AN/TYQ-93 AN/VR-92F
AN/UYK-128(V)3
x2 AN/TYQ-137B(V)3



MED PWR PLANT

CPT 02A00 PLANS OFF M4 M9
SFC 11B40 OPS SGT M4
SSG 35F30 INTEL SGT M4

DAGR x2 NVG
FBCB2 AN/VAS-5
AN/VR-90F



CPT 90A00 LOG OFF M4
CPT 12A00 PLANS OFF M4
SFC 12B40 OPS SGT M4

HEADQUARTERS, IBCT

FIRE SPT/PROTECT-NLOS PARA 07

FIRE SPT/PROTECT-ADAM/BAE PARA 08

FIRE SPT/PROTECT-PAO PARA 09

MVMT & MNVR CELL PARA 10

AN/GYG-1(V)3
 FBCB2
 AN/VAS-5
 x2 NVG
 DAGR
 AN/VRC-92F
 AN/TYQ-93
 AN/UJK-128(V)3
 X2 AN/TYQ-137B(V)3



MED PWR PLANT

MAJ 30A00 INFO OPS OFF M4
 CPT 38A00 CIVIL AFFAIRS OFF M4
 X2 CPT 27A00 OPLAW JAG M9
CW2 131A0 TARGET ANAL M4
 SFC 27D40 SR PARALEGAL NCO M4
 SFC 38B40 CIVIL AFFAIRS NCO M4
 SFC 37F40 SR PSYOPS SGT M4

DAGR x2 NVG
 FBCB2 AN/VAS-5
 AN/TYQ-93 AN/VRC-92F
 AN/UJK-128(V)3
 X2 AN/TYQ-137B(V)3



CPT 29A00 EW OFF M9
 CPT 35G00 EW SPT OFF M4
 CW2 290A0 EW TECH M4
 MSG 29E50 EW SGT NCOIC M4
 SFC 29E40 EW SGT M4
 SFC 25E40 ELEC SPECTRUM NCO M4
 SGT 25E20 ELEC SPEC SGT M4
CPT 13A00 ASST FIRE SPT OFF M4
SSG 13F30 TGT/EW NCO M4
SGT 13F20 FIRE SPT SGT M4
SPC 13F10 FIRE SPT SP M4

AN/GYQ-88
 EPLRS
 AN/USQ-140(V)2
 AN/VRC-92F
 AN/VRC-106(V)1
 AN/VRC-104(V)3
 W/PRC-150
 AN/PRC-117F
 AN/FSQ-211



ANT SQ-253
 PU - 798

CW4 150U0 UAS OPS OFF M4
 CW3 153AI TAC OPS OFF M4
 SGT 14G20 TEAM LDR M4
 SPC 14G10 BTL SYS OPER M4

DAGR x2 NVG
 FBCB2 AN/VAS-5
 AN/VRC-90F
 AN/VRC-104(V)3



MAJ 15B00 AVIATION OFF M4 M9
 AN/GRC-240 AN/PSC-5
 CPT 14A00 AD COORD/MGMT OFF M4 M9
 SPC 15P10 AVIATION OPS SP M4
 PFC 14G10 BTL SYS OPER M4

DAGR x2 NVG
 FBCB2 AN/VAS-5
 AN/VRC-90F



CPT 15B00 ASST AVIATION OFF M4 M9
 CW2 140A0 C2 SYS INTEGRATOR M4
 SSG 15P30 AVIATION OPS SGT M4
 SSG 15Q30 A2C2 SGT M4

FBCB2
 AN/VAS-5
 x2 NVG
 DAGR
 AN/VRC-90F



OA-9511/TYQ
 AN/TYQ-122

SSG 46Q30 PUBLIC AFFAIRS NCO M4
 SGT 46Q20 PUBLIC AFFAIRS SGT M4
 SGT 46R20 PA BROADCAST SGT M4

DAGR x2 NVG
 FBCB2 AN/VAS-5
 AN/PSC-5 AN/VRC-92F



MED PWR PLANT

CPT 11A00 OPS OFF M4
 SFC 19K40 OPS SGT M4

FBCB2 X2 NVG
 AN/VAS-5 DAGR
 AN/VRC-92F
 AN/VRC-104(V)3



SFC 11B40 ASST OPS SGT M4
 SFC 74D40 CBRN NCO M4

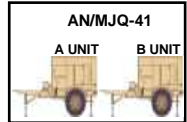

MVMT & MNVR/PROT - PMO PARA 11

SUSTAINMENT - S1 PARA 12

SUSTAINMENT - S4/ MED PARA 13

SUSTAINMENT - S8 PARA 14

SUSTAINMENT - UMT PARA 15

CPT 31A00 PROVOST MARSHAL M4 M9
 SSG 31E30 C/D NCO M4
 SSG 31B30 OPS NCO M4 M9

N/VAS-5
 x2 NVG
 DAGR
 AN/VRC-90F



1LT 42B00 STRENGTH MGR M4
 CW2 420A0 HR TECH M4
 MSG 42A50 SR HR SGT M4
 SSG 42A30 HR SGT M4
 X2 SGT 42A20 HR SGT M4
 X2 SPC 42A10 HR SP M4
 SPC 42A10 HR SP M249
 PFC 42A10 HR SP M4
 PFC 42A10 HR SP M4
 PFC 42A10 HR SP M4

DAGR
 AN/VAS-5
 x2 NVG
 AN/VRC-92F
 AN/UJK-128(V)3



MAJ 90A00 S4 M4 M9
 CW2 882A0 MOBILITY OFF M4
 CW2 920A0 PROP ACCT TECH M4
 CW2 922A0 FOOD ADVISOR M4

AN/VRC-90F
 x2 AN/GYK-61(BCS3)
 AN/TYQ-129(V)1
 X4 AN/TYQ-129(V)2
 AN/TYQ-109(V)1
 AN/TYQ-109(V)2
 AN/UJK-90(V)3
 X2 AN/TYQ-95
 OL-701A/TYQ
 FBCB2
 AN/VAS-5
 x2 NVG
 DAGR
 AN/TYQ-107(V)1
 X2 AN/TYQ-106(V)1
 AN/TYQ-108(V)3
 AN/TYQ-137B(V)3



MAJ 62B00 FIELD SURGEON M9
 CPT 70H67 MED OPS OFF M4 M9
 MSG 92Y50 SR SUPPLY SGT M4
 MSG 92G50 SR FOOD OPS SGT M4
 SFC 88N40 TRANS LOG NOC M4
 SFC 68W40 HEALTH CARE NCO M9
 SFC 92Y40 PROP BOOK NCO M4
 SGT 92Y 20 PROP BOOK NCO M4
 SPC 92Y10 SUPPLY SPEC M4

CPT 36A00 FINANCIAL MGMT OFF M9
 SFC 36B40 FIN MGT MANAGER M4

FBCB2
 AN/VAS-5
 x2 NVG
 DAGR
 AN/VRC-90F
 AN/UJK-128(V)3



MAJ 56A00 CHAPLAIN
 SSG 56M30 CHAPLAIN ASST M4

HEADQUARTERS, IBCT

C4 OPS – S6 PARA 16

AN/VAS-5 x2 NVG
AN/TSQ-243 AN/VRC-90F
AN/GYK-62B AN/GYK-50A
(ISYCON)(V)4 OB-123T
AN/TSR-8(GRT)
AN/TYQ-137B(V)3

MED PWR PLANT



MAJ 25A00 S6 M4 M9
PFC 25U10 SIG SUPT SYS SP M4

FBCB2 x2 DAGR
AN/VRC-89F AN/VRC-90F
AN/VRC-104(V)3 AN/UUK-128(V)3
AN/PYQ-155(V)1

MED PWR PLANT



AN/VAS-5 x2 NVG
AN/VRC-90F
IA/CND
AN/GYK-33D
AN/GYK-149(V)2



x3



AN/TSC-188(V)1

PU - 803

CW3 255S0 NTRWK DEF TECH M4
CW2 255A0 INFO SVCS TECH M4
MSG 25U50 SIG SSPT SYS CHIEF M4
SFC 25B40 INFO SYS STFF NCO M4
SSG 25B30 INFO TECH TM CH M4
SSG 25S30 SATCOM OPNS NCO M4
SSG 25U30 SIG INFO SVC NCO M4
SGT 25B20 IA STAFF ASST M4
SGT 25B20 SR INFO TECH SP M4
SGT 25L20 SR CBL/ANT SYS SP M4
SPC 25B10 INFO TECH SP M4
SPC 25B10 INFO TECH SP M4
PFC 25L10 CBL/ANT SYS SP M4

CW2 255N0 NTRWK MGMT TECH M4
SFC 25E40 ELECT SPEC MGR M4
SFC 25B40 IA STAFF NCO M4
SSG 25B30 COMSEC CUSTODIAN M4
SSG 25N30 NODAL OPS SYS NCO M4
SSG 25Q30 XMSN SYS OPS NCO M4
SGT 25B20 ASST COMSEC CUST M4
SGT 25B20 SR INFO SYS SP M4
SPC 25L10 CBL/ANT SYS SP M4
SPC 25U10 SIG SPT SYS SP M4
PFC 25B10 INFO TECH SP M4
PFC 25U10 SIG SPT SYS SP M4

TAC CURRENT OPS 1 – OPS PARA 17

AN/PSC-5
x2 NVG
AN/VRC-92F
AN/UUK-128(V)3
AN/MRC-150



MAJ 11A00 S3 M4 M9
CPT 35D00 ASST S2 M4
SSG 12B30 RECON SGT M4

FBCB2
AN/TSQ-243
AN/VAS-5
DAGR
AN/VRC-92F
AN/TYQ-93
AN/UUK-128(V)3
AN/PSC-5

MED PWR PLANT



CPT 57A00 BTL CMD OFF M4
SSG 19D30 ASST OPS SGT M4

x2 NVG DAGR
X2 M249 AN/VAS-5
AN/VRC-90F

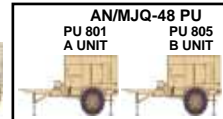

MAJ 12A00 BDE ENG OFF M9
CPT 35D00 INTEL OFF M4
CPT 74A00 CBRN OFF M4
SGM 11Z60 OPS SGT M4

TAC CURRENT OPS 1 – TACP PARA 19

AN/PED-1
AN/GYK-56

*MAJ 01A00 AIR FORCE STAFF OFF M4 M9
SFC 00D40 AIR FORCE STAFF NCO M4
SSG 00D30 AIR FORCE STAFF NCO M4

*USAF PERSONNEL NOT ASSIGNED TO UNIT

TAC CURRENT OPS 2 – INTEL/S2 PARA 20

DAGR x2 NVG
FBCB2 AN/PSC-5
AN/VRC-92F AN/TYQ-93(V)2
AN/UUK-128(V)3

MED PWR PLANT



CW2 350F0 ALL SOURCE INTEL TECH M4
SFC 11B40 SR INTEL SGT M4
SGT 35F20 INTEL SGT M4
SPC 35F10 INTEL ANLST M4
PFC 35F10 INTEL ANLST M4

TAC CURR OPS 2 – SUSTAIN PARA 21

DAGR x2 NVG
FBCB2 AN/VAS-5
AN/VRC-90F
AN/VRC-104(V)3



CPT 92A00 ASST S4 M4
SPC 92Y10 SUPPLY SP M4

TAC CURRENT OPS 2 – C4 OPS PARA 22

DAGR x2 NVG
FBCB2 AN/VAS-5
ON-721/V AN/PYQ-16
AN/VRC-92F AN/GYK-62B
x2 AN/TYQ-155(V)1



CPT 53A00 INFO SYS MGMT OFF M4
SFC 25W40 NTRWK OPS CHIEF M4
SPC 25B10 INFO TECH SPC M4
SPC 25U10 SIG SPT SYS MAINT M4

COMPANY HEADQUARTERS PARA 23

DAGR x2 NVG
FBCB2 AN/VAS-5
AN/VRC-90F
AN/UUK-128(V)3



CPT 01A00 CDR M4 M9
SPC 92Y10 SUPPLY SP M4

x2 NVG X4 M320A1
X4 M249 X4 7.62MM MG
MG CAL .50 AN/VAS-5
AN/VRC90F OL-701A/TYQ
AN/UUK-128(V)3 AN/TYQ-109(V)1



1LT 02B00 XO M4
MSG 19Z5M 1SG M4
SSG 92Y30 SUPPLY SGT M4

MOVED TO FIRES BN TAC CURR OPS 1 – FIRE SPT

DAGR x2 NVG
FBCB2 AN/VAS-5
AN/GYK-58 AN/GYK-56
AN/VRC-92F AN/PRC-119F
AN/UUK-128(V)3



MAJ 13A00 ASST FIRE SPT OFF M4
PFC 13F10 FIRE SPT SP M4

AN/GYG-1(V)3 AN/PSC-5
FBCB2 x2 AN/PRC-119F
AN/GYK-48(V)1 AN/GYK-56
AN/VAS-5 AN/VRC-104(V)3
x2 NVG AN/UUK-128(V)3
DAGR
AN/VRC-92F



CW3 131A0 TGT OFF M4
MSG 13Z50 OPS SGT M4
SFC 13F40 TGT NCO M4
SFC 13F40 FIRE SPT SGT M4
SPC 13F10 FIRE SPT SP M4

EQUIPMENT SUMMARY

WEAPONS

L69080	LAUNCHER GRENADE: M320A1	4
M09009	MACHINE GUN 5.56 MILLIMETER: M249	2
M39263	MACHINE GUN: LIGHT 5.56MM M249	4
M92841	MACHINE GUN: 7.62MM M240B	4
P98152	PISTOL 9MM AUTOMATIC: M9	28
R97234	RIFLE 5 56 MILLIMETER: M4	169
Z00686	MACHINE GUN: CALIBER .50	1

VEHICLES, TRAILERS AND TRLR MTD SYSTEMS

K29708	KNIGHT: ARMORED	0
P42194	POWER PLANT: ELECTRIC TRL/MTD 60KW 50/60HZ AN/MJQ 41	1
P63394	POWER PLANT: UTILITY	1
P63462	POWER PLANT: UTILITY (MEDIUM)	8
P63530	POWER PLANT: ELECTRIC TRAILER MOUNTED	1
T37588	TRUCK UTILITY EXPANDED CAPACITY ENHANCED: M1152A1	19
T56383	TRUCK UTILITY EXPANDED CAPACITY ENHANCED 4X4: M1165A1	12
T60081	TRUCK CARGO: 4X4 LMTV W/E	6
T61908	TRUCK CARGO: MTV W/E	1
T95924	TRAILER CARGO: HIGH MOBILITY 1-1/4 TON	1
T95992	LIGHT TACTICAL TRAILER: 3/4 TON	9
T96564	TRAILER FLAT BED: M1082 TRLR CARGO LMTV W/DROPSIDES	2
Z36683	TRAILER TANK WATER (CAMEL): 800 GAL 5 TON W/E	1

NIGHT VISION / OBSERVATION

D41659	DRIVERS ENHANCERS: AN/VAS-5	41
J03261	ILLUMINATOR: INFRARED	12
M79678	MONOCULAR NIGHT VISION DEVICE: AN/PVS-14	4
N05482	NIGHT VISION: GOGGLE	84
S90535	MEDIUM WEAPON THERMAL SIGHT (MWTS): AN/PAS-13(V)2	10
S90603	HEAVY WEAPON THERMAL SIGHT (HWTS): AN/PAS-13(V)3	1

MISCELANOUS EQUIPMENT

C05701	MONITOR CHEMICAL AGENT:	2
C79000	COLLECTIVE PROTECTION EQUIPMENT: NBC SIMPLIFIED M20	4
G18358	GEN SET: DED SKID MTD 3KW 60HZ	3
G42170	GEN SET DED TM: 10KW 60HZ MTD ONM116A2 PU-798	2
J00697	JOINT CHMCL AGENT: DETECTOR	12
M12986	MASK CHEM BIO JOINT SERVICE GENERAL PURPOSE: FIELD M50	186
R20684	RADIAC SET: AN/VDR-2	14
R30925	RADIAC SET: AN/PDR-75	1

COMMUNICATIONS AND ELECTRONICS

A35329	ALL SOURCE ANALYSIS SYSTEM: AN/TYQ-93	4
A35397	ALL SOURCE ANALYSIS SYSTEM: AN/TYQ-93(V)2	1
C04819	COMTER SYS DIG: AN/PSG-14(V)1 LFFED	4
C18004	COMPUTER SET: AN/GYG-1(V)3	2
C18033	CENTER: COMMUNICATIONS OPERATIONS	1
C18244	COMPUTER SYSTEM: DIGITAL AN/PYQ-7	1
C18277	COMPUTER SET: DIGITAL AN/TYQ-107(V)1	1
C18297	COMPUTER SET GENERAL: AN/GYK-33D	1
C18312	COMPUTER SYSTEM: DIGITAL AN/PYQ-3	1
C18345	COMPUTER SET: DIGITAL AN/TYQ-106(V)1	1
C18378	COMPUTER SET: AN/UYPK-128(V)3	31
C18391	COMPUTER SYS: DIGITAL	1
C18448	COMPUTER SYSTEM: DIGITAL AN/GYK-61	2
C27367	COMPUTER SYSTEM: DIGITAL AN/TYQ-129(V)1	1
C27435	COMPUTER SYSTEM: DIGITAL AN/TYQ-129(V)2	4
C27503	COMPUTER SYSTEM: DIGITAL AN/TYQ-105(V)1	1
C27639	COMPUTER SYSTEM: DIGITAL AN/TYQ-108(V)3	1
C27707	COMPUTER SYSTEM: DIGITAL AN/TYQ-109(V)1	2
C27775	COMPUTER SYSTEM: DIGITAL AN/TYQ-109(V)2	1
C27963	COMPUTER SYSEM: DIGITAL	15
C40996	COMMAND SYSTEM: TACTICAL	4
C61665	COMMAND CENTER SYSTEM: AN/TSQ-243	2
C77755	COMPUTER: TACTICAL AN/GYQ-88	1
C78851	COMPUTER SYSTEM: DIGITAL AN/UYPK-90(V)3	1
C79031	COMPUTER SET: GENERAL AN/GYK-49(V)2	1
C79281	COMPUTER ST FIELD ARTILLERY GENERAL: AN/GYK-48(V)1	3
J54771	INTERCONNECT GROUP: ON-721/V	4
P99881	PROCESSOR GROUP SIG DATA: (CAISI 2.0) OL-701A/TYQ	3
R30658	RECEIVE SUITE: AN/TSR-8	1
R31031	RADIO SET: AN/GRC-240	1
R42399	RADIO SET: AN/USQ-140(V)2(C)	1
R44999	RADIO SET: AN/VRC-89F(C)	1
R45543	RADIO SET: AN/VRC-92F(C)	22
R57606	RADIO SET: AN/PSC-5	14
R68044	RADIO SET: AN/VRC-90F(C)	27
R68566	RADIO SET: AN/VRC-106(V)1 (C)	1
R83141	RADIO SET: AN/PRC-119F(C)	9
R87139	RADIO ST: AN/VRC-104(V)3 150 WATT W/PRC-150 HF RADIO	16
R87207	RADIO ST: AN/PRC-117F TACSAT RADIO MANPACK	2
R93169	RADIO TEST SET: AN/PRM-34(I)	2
T40405	TAPE READER GENERAL PURPOSE: KOI-18/TSEC	2
T43146	TELECONFERENCE SYS: AN/TYQ-122	1
V03198	VIDEO ACQUISITION	1
W63636	WORKSTATION: AIRSPACE OPERATION AN/FSQ-211	1
Z00058	COMPUTER SYSTEM DIGITAL: AN/PSG-10(V)	4
Z00129	COMPUTER SET FIELD ARTILLERY GENERAL: AN/GYK-56	4
Z00384	COMPUTER SYSTEM DIGITAL: AN/PYQ-10(C)	57
Z00512	COMPUTER SYSTEM DIGITAL: AN/GYK-50A (ISYSCON) (V)4	2
Z00560	INTERFACE UNIT COMM EQUIPMENT: OL-713(V)1/TYQ CSS VSAT	1
Z01248	COMPUTER SET: DIGITAL AN/GYK-62B	2
Z01426	COMMAND SYSTEM TACTICAL: AN/TYQ-155 (V) 1	4
Z01463	COMPUTER SYSTEM DIGITAL: AN/PYQ-16	2
Z39781	ARMY H RESOURCES: WRKSTATION	8

HHC, BEB, IBCT

05316R600
17/1/70/88

COMMAND SECTION PARA 01

COMPANY HEADQUARTERS PARA 02

MISSION: The headquarters provides command, control, and supervision of the tactical operations of the Brigade Engineer Battalion (BEB) and attached units. The headquarters company provides unit administration, information management, and logistical support for the battalion staff sections. It also provides administrative and medical support to organic and attached units.

FBCB2 x2 NVG
DAGR EPLRS
AN/VAS-5
AN/PYQ-10(C)
AN/VRC-92F(C)
AN/PRC-119F(C)
AN/UJK-128(V)3



LTC 12A00 CDR M4 M9
PFC 12B10 DRIVER M4

FNCN2 x2 NVG
DAGR EPLRS
AN/PYQ-10(C)
AN/VRC-92F(C)
AN/UJK-128(V)3



MAJ 01A00 BN XO M4 M9
CSM 12A60 CSM M4 M9
SPC 12B00 CBT EN M4

FBCB2 x2 NVG
DAGR EPLRS
AN/VAS-5 X2 MWTS
AN/UJK-128
AN/MRC-149
AN/PYQ-10(C)
AN/VRC-90F(C)



CPT 01A00 CDR M4 M9
SFC 12B40 OPS SGT M4
SPC 92Y10 SUPPLY SPC M249
PFC 12B10 VEH DRIVER M4

x2 NVG DAGR
EPLRS x2 MWTS
OL-701/TYQ X2 HWTS
AN/PYQ-10(C) .50 CAL
AN/VRC-91F(C) MK19
AN/TYQ-109(V)1



1LT 12A00 OPS OFF M4
1SG 12Z5M 1SG M4
SSG 92Y30 SUPPLY SGT M4

SUSTAINMENT - S1 PARA 03 MAIN CP - INTEL/S2 PARA 04

x2 NVG DAGR
EPLRS
OL-701A/TYQ
AN/PYQ-10(C)
AN/VRC-90F(C)
x4 AN/TYQ-116(V)3



CPT 42B00 CPT S1 OFF M4
SFC 42A40 SR HR SGT M4
SSG 42A30 HR SGT M4
SGT 27D20 PARALEGAL SGT M4
SGT 42A20 HR SGT M4
X2 SPC 42A10 HR SP M4
X2 PFC 42A10 HR SP M4

FBCB2 AN/TYQ-93
2X NVG AN/UJK-128(V)3
DAGR AN/TYQ-137B(V)3
EPLRS HWTS
AN/VRC-90F(C) .50 CAL
AN/VRC-92F



CPT 35D00 INTEL OFF S2 M4
SFC 35F40 SR INTEL SGT M4
SGT 29320 EW NCO M4
PFC 35F10 INTEL ANLST M4

x2 NVG DAGR
EPLRS .50 CAL
OL-701/TYQ
AN/PYQ-10(C)
AN/VRC-90F(C)
AN/TYQ-109(V)1



1LT 12A00 ASST S2 OFF M4
MSG 12Z50 INTEL SGT M4
SFC 74D40 CBRN STAFF NCO M4
SSG 29E30 EW NCO M4
SPC 35F10 INTEL ANLST M249

MAIN CP OPS - OPS/S3 PARA 05

x2 NVG DAGR
EPLRS FBCB2
AN/VAS-5 AN/VRC-92F
AN/PYQ-10(C)
X2 AN/UJK-128
AN/VRC-104(V)3
AN/UJK-128(V)3



MAJ 12A00 S3 M4 M9
MSG 11Z50 OPS SGT M4
PFC 12B10 DRIVER M4
SPC 12B10 GUNNER M4

x2 NVG FBCB2
x2 DAGR EPLRS
AN/VRC-91F
X4 AN/TKQ-5



SSG 12T30 TECH EN NCO SGT M9
SPC 12T10 TE CH EN SPC M9

FBCB2 DAGR
AN/VAS-5
x2 NVG
AN/UJK-90(V)3



1LT 12A00 RECON OFF M4
SSG 12B30 RECON SGT M4
SSG 12B30 RECON SGT M4
SSG 12B30 ASST PLANS SGT M4

x2 NVG DAGR
AN/VAS-5
AN/VRC-92F
AN/UJK-90(V)3
X2 AN/UJK-128
X3 AN/PYQ-10(C)



CPT 01A00 ASST S3 OFF M4
SFC 12H40 CONST SGT M4
SFC 12B40 ASST OPS SGT M4
SSG 12H30 ASST CONST SGT M4

FHMUX AN/PSC-5
AN/VRC-92F
AN/VRC-90F
AN/PYQ-10(C)

AN/UJK-128(V)3
x2 AN/TYQ-137B(V)3
AN/PRC-150 HF RADIO
KOI-18/TSEC



CPT 12A00 PLANS OFF M4
CPT 12A00 CONST ENGR M4
W2 120A0 CONST EN TECH M4
SSG 12N30 CONSTRUC FOREMAN M4

SUSTAINMENT - S4 PARA 06

FBCB2
x2 NVG
DAGR
EPLRS
AN/VRC-92F



CPT 12A00 S4 OFF M4
SPC 92Y10 SUPPLY SPC M4

x2 AN/TYQ-129(V)2
AN/TYQ-109(V)1
AN/TYQ-137B(V)3
AN/UJK-90(V)3
AN/TSC-183
OL-701A/TYQ
KOI-18/TSEC



SFC 92Y40 SR SUPPLY SGT M4
SGT 92Y10 SUPPLY NCO M4

HHC, BEB, IBCT

SUSTAINMENT – C4 OPS/S6 PARA 07

DAGR
AN/PYQ-12
AN/TSQ-243
AN/GYK-50A
AN/TSR-8 (GRT)
AN/TYQ-137B(V)3
AN/GYK-50B(SYSCON)(V)4
AN/TSQ-259
AN/GYK-62B



CPT 25A00 S6 OFF M4
SGT 25U20 FWD SIG SPT NCO M4

x2 NVG
DAGR
AN/VAS-5
AN/VRC-92F
AN/UUYQ-90(V)3



PU - 798

SFC 25U40 SECT CHIEF M4
SSG 25U30 SIG INFO SVE NCO M4
SPC 25U10 SIG SPT SYS SPC M4
PFC 25U10 SIG SPT SYS SPC M4
SPC 25B10 LAN MGR M4
PFC 25B10 LAN MGR M4

SUST - MED SUPPORT SECT PARA 08

x2 NVG DAGR
EPLRS
AN/VRC-90F
AN/TYQ-107(V)1
AN/TYQ-106(V)1
x6 AN/TYQ-105(V)01
OL-701/TYQ



CPT 65D00 PHYSICIAN ASST M9
SFC 68W40 HEALTH CARE NCO M4
X2 SSG 68W30 HEALTH CARE SGT M4
X3 SPC 68W10 COMBAT MEDIC M9
PFC 68W10 HEALTH CARE SP M4

x2 NVG
DAGR
PLRS
AN/VRC-90F
AN/TYQ-128(V)3
x2 AN/TYQ-105(V)1



x2

SGT 68W20 EMER CARE SGT M9
SGT 68W20 EMER CARE SGT M9
X2 SPC 68W10 AMB AIDE/DRIVER M4
X2 PFC 68W10 AMB AIDE/DRIVER M4

SUSTAINMENT – UMT PARA 09

x2 NVG
DAGR
EPLRS
AN/VRC-90F



CPT 56A00 CHAPLAIN
SGT 56M20 CHAP ASST M4

CBRN RECCE PLATOON PARA 10

FBCB2 x2 NVG
EPLRS FHMUX
AN/VRC-89F
AN/VRC-90F
AN/UUYK-128(V)3
ON-721/V DAGR



1LT 74A00 PLT LDR M4
SGT 74D20 ASST TM LDR M4
SPC 74D10 CBRN SP M249
PFC 74D10 CBRN SP M4



x2

FBCB2
x2 NVG
EPLRS
AN/VRC-89F
AN/VRC-90F
AN/UUYK-128(V)3
FHMUX
ON-721/V
DARG

SFC 74D40 PLT SGT M4
SSG 74D30 TEAM LDR M4
X2 SGT 74D20 ASST TM LDR M4
X2 SPC 74D10 CBRN SPC M249
X2 PFC 74D10 CBRN SPC M4

EQUIPMENT SUMMARY

Item ID	Description	Quantity	Item ID	Description	Quantity
L69080	WEAPONS			COMMUNICATIONS AND ELECTRONICS	
L91701	LAUNCHER GRENADE: M320A1	6	A35329	ALL SOURCE ANALYSIS SYSTEM: AN/TYQ-93	1
M09009	MACHINE GUN CALIBER .50: HEAVY FIXED TURRET TYPE	3	C18277	COMPUTER SET: DIGITAL AN/TYQ-107(V)1	1
M39263	MACHINE GUN 5.56 MILLIMETER: M249	6	C18278	COMPUTER SYSTEM: DIGITAL AN/UUYQ-90(V)2	6
M92362	MACHINE GUN: LIGHT 5.56MM M249	4	C18345	COMPUTER SET: DIGITAL AN/TYQ-106(V)1	1
M92841	MACHINE GUN GRENADE 40MM: MK19 MOD III	3	C18378	COMPUTER SET: AN/UUYK-128(V)3	17
P98152	MACHINE GUN: 7.62MM M240B	2	C18641	COMPUTER SYST DIGITAL: AN/PYQ-12	1
R97234	PISTOL 9MM AUTOMATIC: M9	7	C19266	COUNTER ELECTRONIC DIGITAL READOUT: AN/USM-459	1
S40541	RIFLE 5 56 MILLIMETER: M4	80	C27435	COMPUTER SYSTEM: DIGITAL AN/TYQ-129(V)2	2
Z00686	SHOTGUN: 12 GAGE	3	C27503	COMPUTER SYSTEM: DIGITAL AN/TYQ-105(V)1	10
	MACHINE GUN: CALIBER .50	7	C27707	COMPUTER SYSTEM: DIGITAL AN/TYQ-109(V)1	2
	VEHICLES, TRAILERS AND TRLR MTD SYSTEMS		C27963	COMPUTER SYSTEM: DIGITAL	5
A93374	ARMORED SECURITY VEHICLE: WHEELED W/MOUNT (ASV)	6	C61665	COMMAND CENTER SYSTEM: AN/TSQ-243	1
A94943	ASSAULT KTCHN: (AK)	2	C78851	COMPUTER SYSTEM: DIGITAL AN/UUYQ-90(V)3	3
C27633	CONTAINERIZED KITCHEN: CK	1	J54771	INTERCONNECT GROUP: ON-721/V	2
G53778	GENERATOR SET DIESEL ENGINE TM: PU-802	1	N96248	LOCATION SET: SATELLITE SIGNALS AN/PSN-13	45
P63462	POWER PLANT: UTILITY (MEDIUM)	2	P49587	PJR INTERFACE VEHICLE RADIO SET: AN/VSQ-2(V)	36
T34704	TRUCK UTILITY: ECV ARMAMENT CARRIER W/AMP ARMOR READY M1151A1	4	P9988	PROCESSOR GROUP SIG DATA: (CAISI 2.0) OL-701A/TYQ	5
T37588	TRUCK UTILITY EXPANDED CAPACITY ENHANCED: M1152A1	7	R36178	RADIO TEST SET AN/GRM-122	1
T38844	TRUCK AMBULANCE: 4 LITTER ARMED 4X4 W/E (HMMWV)	1	R4999	RADIO SET: AN/VRC-89F(C)	3
T39586	TRUCK CARGO: TACTICAL 8X8 HEAVY EXPANDED MOBILITY W/MED CRANE	1	R543	RADIO SET: AN/VRC-92F(C)	8
T41135	TRUCK CARGO: MTV W/E W/W	1	R6804	RADIO SET: AN/PSC-5	1
T56383	TRUCK UTILITY EXPANDED CAPACITY ENHANCED 4X4: M1165A1	1	R6804	RADIO SET: AN/VRC-90F(C)	27
T60081	TRUCK CARGO: 4X4 LMTV W/E	5	R68146	RADIO SET: AN/VRC-91F(C)	16
T61704	TRUCK CARGO: MTV LWB W/E	1	R87139	RADIO ST: AN/VRC-104(V)3 150 WATT W/PRC-150 HF RADIO	2
T61908	TRUCK CARGO: MTV W/E	3	R93169	RADIO TEST SET: AN/PRM-34()	3
T63093	TRUCK WRECKER: TACTICAL 8X8 HEAVY EXPANDED MOBILITY W/WINCH	1	T40405	TAPE READER GENERAL PURPOSE: KOI-18/TSEC	2
T87243	TRUCK TANK: FUEL SERVICING 2500 GALLON 8X8 HEAVY EXP MOB	2	Z00384	COMPUTER SYSTEM DIGITAL: AN/PYQ-10(C)	42
T93761	TRAILER: PALLETIZED LOADING 8X20	1	Z00512	COMPUTER SYSTEM DIGITAL: AN/GYK-50A (ISYSCON) (V)4	1
T95924	TRAILER CARGO: HIGH MOBILITY 1-1/4 TON	7	Z00513	COMPUTER SYSTEM DIGITAL: AN/GYK-50B (ISYSCON) (V)4	1
T95992	LIGHT TACTICAL TRAILER: 3/4 TON	8	Z00560	INTERFACE UNIT COMMUNICATION EQUIPMENT: OL-713(V)1/TYQ CSS VSAT	1
T96496	TRUCK CARGO: TACTICAL 8X8 HEAVY EXPANDED MOB W/LHS	1	Z00930	COMMUNICATIONS SUBSYSTEM: AN/TSQ-259	1
T96564	TRAILER FLAT BED: M1082 TRLR CARGO LMTV W/DROPSIDES	5	Z01162	COMPUTER SYSTEM: DIGITAL AN/TYQ-139	1
U31832	UNMANNED GROUND VEHICLE TRACKED: XM216	3	Z01320	RADIO SET: AN/PRC-148 (V) 4 URBAN JEM	30
Z00206	MULTI-TEMPERATURE REFRIGERATED CONTAINER SYSTEM: MTRCS	1	Z39781	ARMY H RESURCES: WRKSTATION	4
Z00514	MODULAR FUEL SYSTEM - TANKRACK MODULE:	2			
Z01404	TRAILER-MTD: PU-2101/ 15 KW/ 50/60HZ/ M200A1	1		MISC EQUIPMENT	
Z01414	LTT TRAILER-MTD: PU-2002/ 10 KW/ 50/60HZ	1			
Z01437	TRLR MTD: PP-3003/15 KW 50/60HZ	1	C05701	MONITOR CHEMICAL AGENT:	7
Z36683	TRAILER TANK WATER (CAMEL): 800 GAL 5 TON W/E	2	G18358	GEN SET: DED SKID MTD 3KW 60HZ	2
	NIGHT VISION/OBSERVATION		G40175	GENERATOR SWEEP: SG-1206/U	1
J03261	ILLUMINATOR: INFRARED	58	M12986	MASK CHEMICAL BIOLOGICAL JOINT SERVICE GENERAL PURPOSE: FIELD M50	95
J68403	INTEGRATED LASER WHITE POINTER (ILWLP): AN/PEQ-14	42	M13236	MASK CHEMICAL-BLGCJL JNT SRV GNL PRPSE: CMBT VHL CRWMN M51	22
M79678	MONOCULAR NIGHT VISION DEVICE: AN/PVS-14	18	N83206	PERSONNEL IDENTIFICATION BAND KIT: W/COMP (PRISONER OF WAR USE)	4
N05482	NIGHT VISION: GOGGLE	88	Z01330	GEN SET DED 10KW 50/60HZ: SKID-MTD	2
N07848	NIGHT VISION DEVIC: AN/PSQ-20	14			
S60356	SIGHT: THERMAL AN/PAS-13B(V)1	28			
S90535	MEDIUM WEAPON THERMAL SIGHT (MWTS): AN/PAS-13(V)2	20			
S90603	HEAVY WEAPON THERMAL SIGHT (HWTS): AN/PAS-13(V)3	22			

COMBAT ENGINEER COMPANY, BEB, IBCT

05319R600
5/0/96//101

COMPANY HEADQUARTERS SECTION PARA 01

(X2) COMBAT ENGR PLATOON HQ PARA 02

MISSION: To increase the combat effectiveness of the Infantry Brigade by accomplishing limited mobility, countermobility, survivability, and sustainment engineering missions, or to perform infantry combat missions when required.

FBCB2 DAGR
EPLRS
AN/VRC-92F
AN/UYK-128(V)3
AN/MRC-149



CPT 12A00 CDR M4 M9 ILLUM NVG
PFC 12B10 VEH DRIVER M4 NVG
SGT 25U20 FWD SIG SPT NCO M4 NVG

FBCB2 DAGR
EPLRS
AN/VRC-90F
AN/UYK-128(V)3
AN/TYQ-109(V01)



1SG 12Z5M 1SG M4 NVG
SSG 92Y30 SUPPLY NCO M4 NVG
SPC 92Y10 SUPPLY SP M4 NVG

FBCB2 ON-721/V
DAGR
EPLRS
AN/UYK-128(V)3
AN/VRC-91F



2LT 12A00 PLT LDR M4 ILLUM NVG
SPC 12B00 GUNNER M4 NVG
PFC 12B00 DRIVER M4 NVG

FBCB2 DAGR
EPLRS ON-721/V
x4 JAVELIN
AN/VRC-92F
AN/VRC-90F
KOI-18/TSEC
OL-701A/TYQ
AN/UYK-128(V)3
AN/TYQ-137B(V)3



1LT 12A00 OPS OFF M4 NVG
SFC 12B40 OPS SGT M4 NVG

FBCB2 DAGR
EPLRS
AN/VRC-89F
AN/UYK-128(V)3
AN/PRC-148(V)4



SFC 12B40 PLT SGT M4 ILLUM NVG
SPC 12B00 COMBAT EN M4 NVG

COMBAT ENGR SQUAD PARA 03

FBCB2
DAGR
EPLRS
AN/VRC-89F

FBCB2
DAGR
EPLRS
AN/VRC-89F

SSG 12B30 SQD LDR M4 ILLUM NVG
SGT 12B20 TM LDR M4 ILLUM NVG
SGT 12B20 TM LDR M4 ILLUM NVG
SPC 12B10 GUNNER M4 ILLUM NVG
SPC 12B10 CBT ENG M4 ILLUM NVG
SPC 12B10 CBT ENG M249 ILLUM NVG
PFC 12B10 DRIVER M4 ILLUM NVG
PFC 12B10 DRIVER M4 ILLUM NVG
PFC 12B10 CBT ENG M4 ILLUM NVG
PFC 12B10 CBT ENG M4 ILLUM NVG



x6

SUPPORT PLT HQ PARA 04

FBCB2
DAGR
EPLRS
AN/VRC-89F
AN/UYK-128(V)3
AN/PRC-148(V)4



2LT 12A00 PLT LDR M4 ILLUM NVG
SFC 12B40 PLT SGT M4 ILLUM NVG
SPC 12B10 COMBAT EN M4 NVG
PFC 12B10 DRIVER M4 NVG

FBCB2
DAGR
EPLRS
AN/VRC-89F
AN/UYK-128(V)3
AN/PRC-148(V)4



BREACH SQD PARA 05

FBCB2
DAGR
EPLRS
AN/VRC-90F(C)



FBCB2
DAGR
EPLRS
AN/VRC-89F(C)



SSG 12B10 SQD LDR M4 NVG
SPC 12B10 CBT EN M4 ILLUM NVG
SPC 12B10 CBT EN M4 ILLUM NVG
PFC 12B10 VEH DRIVER M4 NVG

HORIZONTAL CONST SQUAD PARA 06

DAGR
FBCB2
AN/VRC-90F
AN/UYK-128(V)3



X2

SSG 12N30 SQUAD LDR M4 NVG
SPC 12N10 HORIZ CONST ENG M4 NVG

DAGR
AN/PRC-119F



X3

SGT 12N20 HVY VEH DRIVER M4 NVG AN/PRC-119F
SGT 12N20 HORIZ CONST SGT M4 NVG AN/PRC-119F
SGT 12N20 HORIZ CONST SGT M4 NVG AN/PRC-119F
SPC 12N10 HORIZ CONST ENG M4 NVG AN/PRC-119F
SPC 12N10 HORIZ CONST ENG M4 NVG AN/PRC-119F
SPC 12N10 HORIZ CONST ENG M4 NVG AN/PRC-119F
SPC 12N10 HORIZ CONST ENG M4 NVG AN/PRC-119F

AN/VRC-90F
AN/UYK-128(V)3
DAGR



AN/PRC-119F
DAGR



X2

SGT 12N20 HORIZ CONST SGT M4 NVG AN/PRC-119F
SPC 12N10 HVY VEH DRIVER M4 NVG AN/PRC-119F
SPC 12N10 HVY VEH DRIVER M4 NVG AN/PRC-119F
SPC 12N10 HVY VEH DRIVER M4 NVG AN/PRC-119F
PFC 12N10 HORIZ CONST ENG M4 NVG AN/PRC-119F
PFC 12N10 HORIZ CONST ENG M4 NVG AN/PRC-119F
PFC 12N10 HORIZ CONST ENG M4 NVG AN/PRC-119F
PFC 12N10 HORIZ CONST ENG M4 NVG AN/PRC-119F

AN/PRC-119F
DAGR



EQUIPMENT SUMMARY

WEAPONS

L69080	LAUNCHER GRENADE: M320A1	16
M09009	MACHINE GUN 5.56 MILLIMETER: M249	6
M92362	MACHINE GUN GRENADE 40MM: MK19 MOD III	2
M92454	MACHINE GUN 7.62 MILLIMETER: M240L	6
M92841	MACHINE GUN: 7.62MM M240B	4
P98152	PISTOL 9MM AUTOMATIC: M9	1
R97234	RIFLE 5 56 MILLIMETER: M4	95
S40541	SHOTGUN: 12 GAGE	12
Z00686	MACHINE GUN: CALIBER .50	2

VEHICLES, TRAILERS AND TRLR MTD SYSTEMS

L76897	LOADER SCOOP TYPE: 2.5 CUBIC YARD	1
S70517	SEMITRAILER LOW BED: 25 TON 4 WHEEL W/E	2
T37588	TRUCK UTILITY EXPANDED CAPACITY ENHANCED: M1152A1	9
H53576	HIGH MOBILITY ENG EXCAVATOR (HMEE): TYPE I	3
T56383	TRUCK UTILITY EXPANDED CAPACITY ENHANCED 4X4: M1165A1	2
T61239	TRUCK TRACTOR: MTV W/E	1
T61908	TRUCK CARGO: MTV W/E	1
T65047	TRUCK DUMP FMTV: 10 TON	1
T65115	TRUCK DUMP (FMTV) 10 TON: M1157	1
T76541	TRACTOR FULL TRACKED HIGH SPEED: DEPLOYABLE LT ENGINEER (DEUCE)	2
T95555	TRAILER CARGO: MTV W/DROPSIDES M1095	1
T95924	TRAILER CARGO: HIGH MOBILITY 1-1/4 TON	8
T95992	LIGHT TACTICAL TRAILER: 3/4 TON	1
U31832	UNMANNED GROUND VEHICLE TRACKED: XM216	6
Z36683	TRAILER TANK WATER (CAMEL): 800 GAL 5 TON W/E	1

NIGHT VISION/OBSERVATION

J03261	ILLUMINATOR: INFRARED	53
M79678	MONOCULAR NIGHT VISION DEVICE: AN/PVS-14	10
N05482	NIGHT VISION: GOGGLE	24
N07848	NIGHT VISION DEVIC: AN/PSQ-20	40
S60356	SIGHT: THERMAL AN/PAS-13B(V)1	6
S90535	MEDIUM WEAPON THERMAL SIGHT (MWTS): AN/PAS-13(V)2	22
S90603	HEAVY WEAPON THERMAL SIGHT (HWTS): AN/PAS-13(V)3	7

COMMUNICATIONS AND ELECTRONICS

C18378	COMPUTER SET: AN/UJK-128(V)3	16
C27707	COMPUTER SYSTEM: DIGITAL AN/TYQ-109(V)1	1
C27963	COMPUTER SYSEM: DIGITAL	1
C67436	COMPTER SYSTEM DIGITAL: AN/PYQ-6C	1
J54771	INTERCONNECT GROUP: ON-721/V	3
N96248	NAVIGATION SET: SATELLITE SIGNALS AN/PSN-13	21
P49587	PJH SURFACE VEHICLE RADIO SET: AN/VSQ-2(V)	16
P99724	PJH SURFACE VEHICLE RADIO SET: AN/VSQ-2 (V)2 (PJHI)	3
P99881	PROCESSOR GROUP SIG DATA: (CAISI 2.0) OL-701A/TYQ	1
R44999	RADIO SET: AN/VRC-89F(C)	2
R45543	RADIO SET: AN/VRC-92F(C)	2
R68044	RADIO SET: AN/VRC-90F(C)	11
R68146	RADIO SET: AN/VRC-91F(C)	2
R83141	RADIO SET: AN/PRC-119F(C)	5
T27221	RADIO TEST SET: AN/PRM-34()	1
T40405	TARGET LOCATION AND OBSERVATION: AN/PLQ-8	6
Z00384	TAPE READER GENERAL PURPOSE: KOI-18/TSEC	1
Z01320	COMPUTER SYSTEM DIGITAL: AN/PYQ-10(C)	23
	RADIO SET: AN/PRC-148 (V) 4 URBAN JEM	10

MISC EQUIPMENT

B84404	BOAT RECONNAISSANCE: PNEUMATIC 3-MAN	2
C05701	MONITOR CHEMICAL AGENT:	2
D17191	DIGITAL TOPOGRAPHIC SUPPORT SYSTEM (DTSS): UPDATE	3
G18358	GEN SET: DED SKID MTD 3KW 60HZ	1
J00697	JOINT CHMCL AGENT: DETECTOR	3
M12986	MASK CHEMICAL BIOLOGICAL JOINT SERVICE GENERAL PURPOSE: FIELD M50	74
R20684	RADIAC SET: AN/VDR-2	3
R30925	RADIAC SET: AN/PDR-75	1
R31061	RADIAC SET: AN/UDR-13	10
Z01476	URBAN OPERATIONS: PLATOON	2
Z01531	URBAN OPERATIONS SQUAD SET:	6

COMBAT ENGINEER COMPANY, BEB, BCT

05329R600
5/0/83//88

COMPANY HEADQUARTERS SECTION PARA 01

COMBAT ENGR PLATOON HQ PARA 02

MISSION: To provide command and control of assigned subordinate units to coordinate, direct and conduct vertical and horizontal general engineering, survey and design and conduct detection and neutralization of explosive hazards along routes in support of Brigade Combat Teams (BCT).

FBCB2 DAGR
EPLRS
AN/VRC-92F
AN/MRC-149
AN/UJK-128(V)3



CPT 12A00 CDR M4 M9 ILLUM NVG
PFC 12B10 VEH DRIVER M4 NVG
SGT 25U20 FWD SIG SPT NCO M4 NVG

FBCB2 DAGR
EPLRS ON-721/V
x4 JAVELIN
AN/VRC-92F
AN/VRC-90F
KOI-18/TSEC
OL-701A/TYQ
AN/UJK-128(V)3
AN/TYQ-137B(V)3



1LT 12A00 OPS OFF M4 NVG
SFC 12B40 OPS SGT M4 NVG

FBCB2 DAGR
EPLRS AN/VRC-90F
AN/UJK-128(V)3
AN/TYQ-109(V)1



1SG 12Z5M 1SG M4 NVG
SSG 92Y30 SUPPLY NCO M4 NVG
SPC 92Y10 SUPPLY SP M4 NVG

FBCB2 DAGR
EPLRS ON-721/V
AN/UJK-128(V)3
AN/VRC-91F



2LT 12A00 PLT LDR M4 ILLUM NVG
SPC 12B10 GUNNER M4 NVG
PFC 12B00 VEH DRIVER M4 NVG

FBCB2 DAGR
EPLRS AN/VRC-89F
AN/UJK-128(V)3
AN/PRC-148(V)4



SFC 12B40 PLT SGT M4 ILLUM NVG
PFC 12B00 VEH DRIVER M4 NVG

COMBAT ENGR SQUAD PARA 03

SUPPORT PLT HQ PARA 04

BREACH SQD PARA 05

FBCB2 DAGR
EPLRS
AN/VRC-89F



SSG 12B30 SQD LDR M4 ILLUM NVG
SGT 12B20 TM LDR M4 ILLUM NVG
SPC 12B10 GUNNER M4 ILLUM NVG
SPC 12B10 CBT ENG M4 ILLUM NVG
PFC 12B10 DRIVER M4 ILLUM NVG
PFC 12B10 CBT ENG M4 ILLUM NVG

x3

FBCB2 DAGR
EPLRS
AN/VRC-89F



SGT 12B20 TM LDR M4 ILLUM NVG
SPC 12B10 CBT ENG M249 ILLUM NVG
PFC 12B10 DRIVER M4 ILLUM NVG
PFC 12B10 CBT ENG M4 ILLUM NVG

FBCB2 DAGR
EPLRS
AN/VRC-89F
AN/UJK-128(V)3
AN/PRC-148(V)4



2LT 12A00 PLT LDR M4 ILLUM NVG
SFC 12B40 PLT SGT M4 ILLUM NVG
SPC 12B10 COMBAT EN M4 NVG
PFC 12B10 VEH DRIVER M4 NVG

FBCB2 DAGR
EPLRS
AN/VRC-89F
AN/UJK-128(V)4
AN/PRC-148(V)4



FBCB2
DAGR
EPLRS
AN/VRC-89F



FBCB2
DAGR
EPLRS
AN/VRC-89F



SSG 12B10 SQD LDR M4 NVG
SPC 12B10 CBT ENG M4 ILLUM NVG
PFC 12B10 VEH DRIVER NVG
PFC 12B10 VEH DRIVER M4 NVG

HORIZONTAL SQUAD PARA 06

CLEARANCE PLT HQ PARA 07

(x2) CLEARANCE SQUAD PARA 08

FBCB2 DAGR
EPLRS HWTS
AN/VRC-90F
AN/VRC-119F
AN/UJK-128(V)3



x2

SSG 12N30 SQUAD LDR M4 NVG
X3 SPC 12N10 HVY VEH DRIVER M4 NVG
SPC 12N10 HORIZ CONST ENG M4 NVG
SGT 12N20 HORIZ CONST SGT M4 NVG AN/PRC-119F
SGT 12N20 HORIZ CONST SGT M4 NVG AN/PRC-119F
PFC 12N10 HOIRZ CONST ENG M4 NVG AN/PRC-119F
PFC 12N10 HOIRZ CONST ENG M4 NVG AN/PRC-119F
PFC 12N10 HOIRZ CONST ENG M4 NVG AN/PRC-119F

DAGR
AN/PRC-119F



x3

DAGR
AN/PRC-119F



x2

DAGR
AN/VRC-90F
AN/UJK-128(V)3



x2



SGT 12N20 HVY VEH DRIVER M4 NVG AN/PRC-119F
SGT 12N20 HORIZ CONST SGT M4 NVG AN/PRC-119F
SPC 12N10 HORIZ CONST ENG M4 NVG AN/PRC-119F
SPC 12N10 HORIZ CONST ENG M4 NVG AN/PRC-119F
PFC 12N10 HOIRZ CONST ENG M4 NVG AN/PRC-119F



FBCB2 DAGR
EPLRS
AN/VRC-91F
AN/UJK-128(V)3
AN/PRC-148(V)4



x2

2LT 12A00 PLT LDR M4 ILLUM NVG
SFC 12B40 PLT SGT M4 ILLUM NVG
SPC 12B10 COMBAT ENGR M4 NVG
SPC 12B10 COMBAT ENGR M4 NVG
PFC 12B00 VEH DRIVER M4 NVG
PFC 12B00 VEH DRIVER M4 NVG



Talon Robot

FBCB2 DAGR
EPLRS
AN/VRC-91F



DAGR
AN/VRC-90F



DAGR
AN/VRC-90F



SSG 12B30 SQD LDR M4 ILLUM NVG
SGT 12B20 TM LDR M4 ILLUM NVG
SGT 12B20 TM LDR M4 ILLUM NVG
SPC 12B10 CBT ENG M4 ILLUM NVG
SPC 12B10 CBT ENG M249 ILLUM NVG
SPC 12B10 VMMD DRIVER M4
PFC 12B10 DRIVER M4 ILLUM NVG
PFC 12B10 DRIVER M4 ILLUM NVG

x2

EQUIPMENT SUMMARY

WEAPONS

L69080	LAUNCHER GRENADE: M320A1	16
M09009	MACHINE GUN 5.56 MILLIMETER: M249	5
M92362	MACHINE GUN GRENADE 40MM: MK19 MOD III	5
M92454	MACHINE GUN 7.62 MILLIMETER: M240L	6
M92841	MACHINE GUN: 7.62MM M240B	4
P98152	PISTOL 9MM AUTOMATIC: M9	1
R97234	RIFLE 5 56 MILLIMETER: M4	80
S40541	SHOTGUN: 12 GAGE	12
Z00686	MACHINE GUN: CALIBER .50	2

VEHICLES, TRAILERS AND TRLR MTD SYSTEMS

L76897	LOADER SCOOP TYPE: 2.5 CUBIC YARD	1
S70517	SEMITRAILER LOW BED: 25 TON 4 WHEEL W/E	2
T37588	TRUCK UTILITY EXPANDED CAPACITY ENHANCED: M1152A1	9
H53576	HIGH MOBILITY ENG EXCAVATOR (HMEE): TYPE I	3
T56383	TRUCK UTILITY EXPANDED CAPACITY ENHANCED 4X4: M1165A1	3
T61239	TRUCK TRACTOR: MTV W/E	2
T61908	TRUCK CARGO: MTV W/E	1
T65047	TRUCK DUMP FMTV: 10 TON	1
T65115	TRUCK DUMP (FMTV) 10 TON: M1157	1
T76541	TRACTOR FULL TRACKED HIGH SPEED: DEPLOYABLE LT ENGINEER (DEUCE)	2
T95555	TRAILER CARGO: MTV W/DROPSIDES M1095	1
T95924	TRAILER CARGO: HIGH MOBILITY 1-1/4 TON	8
T95992	LIGHT TACTICAL TRAILER: 3/4 TON	1
U31832	UNMANNED GROUND VEHICLE TRACKED: XM216	6
Z36683	TRAILER TANK WATER (CAMEL): 800 GAL 5 TON W/E	1

NIGHT VISION/OBSERVATION

J03261	ILLUMINATOR: INFRARED	53
M79678	MONOCULAR NIGHT VISION DEVICE: AN/PVS-14	10
N05482	NIGHT VISION: GOGGLE	24
N07848	NIGHT VISION DEVIC: AN/PSQ-20	40
S60356	SIGHT: THERMAL AN/PAS-13B(V)1	6
S90535	MEDIUM WEAPON THERMAL SIGHT (MWTS): AN/PAS-13(V)2	22
S90603	HEAVY WEAPON THERMAL SIGHT (HWTS): AN/PAS-13(V)3	7

COMMUNICATIONS AND ELECTRONICS

C18378	COMPUTER SET: AN/UJK-128(V)3	16
C27707	COMPUTER SYSTEM: DIGITAL AN/TYQ-109(V)1	1
C27963	COMPUTER SYSEM: DIGITAL	1
C67436	COMPTER SYSTEM DIGITAL: AN/PYQ-6C	1
J54771	INTERCONNECT GROUP: ON-721/V	3
N96248	NAVIGATION SET: SATELLITE SIGNALS AN/PSN-13	21
P49587	PJH SURFACE VEHICLE RADIO SET: AN/VSQ-2(V)	16
P99724	PJH SURFACE VEHICLE RADIO SET: AN/VSQ-2 (V)2 (PJHI)	3
P99881	PROCESSOR GROUP SIG DATA: (CAISI 2.0) OL-701A/TYQ	1
R44999	RADIO SET: AN/VRC-89F(C)	2
R45543	RADIO SET: AN/VRC-92F(C)	2
R68044	RADIO SET: AN/VRC-90F(C)	11
R68146	RADIO SET: AN/VRC-91F(C)	2
R83141	RADIO SET: AN/PRC-119F(C)	5
R33111	RADIO TEST SET: AN/PRM-34()	1
T2722	TARGET LOCATION AND OBSERVATION: AN/PLQ-8	6
T40405	TAPE READER GENERAL PURPOSE: KOI-18/TSEC	1
Z00384	COMPUTER SYSTEM DIGITAL: AN/PYQ-10(C)	23
Z01320	RADIO SET: AN/PRC-148 (V) 4 URBAN JEM	10

MISC EQUIPMENT

B84404	BOAT RECONNAISSANCE: PNEUMATIC 3-MAN	2
C05701	MONITOR CHEMICAL AGENT:	2
D17191	DIGITAL TOPOGRAPHIC SUPPORT SYSTEM (DTSS): UPDATE	3
G18358	GEN SET: DED SKID MTD 3KW 60HZ	1
J00697	JOINT CHMCL AGENT: DETECTOR	3
M12986	MASK CHEMICAL BIOLOGICAL JOINT SERVICE GENERAL PURPOSE: FIELD M50	74
R20684	RADIAC SET: AN/VDR-2	3
R30925	RADIAC SET: AN/PDR-75	1
R31061	RADIAC SET: AN/UDR-13	10
Z01476	URBAN OPERATIONS: PLATOON	2
Z01531	URBAN OPERATIONS SQUAD SET:	6

BRIGADE SIGNAL COMPANY, BEB, BCT 11307R100 3/0/42/145

COMPANY HEADQUARTERS PARA 01 SMALL CMD POST SUPPORT TM PARA 02 RETRANSMISSION TM PARA 03

MISSION: To provide 24-hour operational Command, Control, Communications, Computer, Intelligence, Surveillance, and Reconnaissance (C4ISR) signal systems network to the supported Brigade Combat Team.

FBCB2 AN/VAS-5
2X NVG DAGR
EPLRS MK-19
AN/VRC-92F
AN/VRC-104(V)3
HWTS
KOI-18/TSEC



CPT 25A00 CDR M4 M9
1SG 25U5M 1SG M4

FBCB2 X2 NVG
DAGR EPLRS
AN/VAS-5
AN/VRC-89F



SGT 25Q20 SR XMSN SYS OPR-MNT M4
SPC 25Q10 XMSN SYS OPR-MNT M4

FBCB2 x2 NVG
DAGR EPLRS
AN/VAS-5
X3 AN/VRC-92F



SGT 25U20 TEAM CHIEF M4
SPC 25U10 RETRANS OPR M4
PFC 25U10 RETRANS OPR M249

FBCB2 AN/VAS-5
MK-19
2X NVG
DAGR
EPLRS
AN/VRC-90F
HWTS



SGT 92Y20 SUPPLY NCO M4
SPC 92Y10 SUPPLY SP M320

AN/VAS-5
2X NVG
AN/VRC-90F



SPC 25Q10 XMSN SYS OPR-MNT M4
SPC 25N10 NODAL NT SYS OPR-MNT M4
PFC 25N10 NODAL NT SYS OPR-MNT M4
PFC 25Q10 XMSN SYS OPR-MNT M249

REPLACED BY WIN-T WHEN DOCUMENTED

x2 PLT HQ PARA 04

FBCB2 2X NVG
DAGR EPLRS
AN/VAS-5
AN/VRC-90F
AN/VRC-104(V)3
KOI-18/TSEC



1LT 25A00 PLT LDR M4
SFC 25W40 PLT SGT M4

x2

(X2) JOINT NTRWK NODE/SMART-T TM PARA 05

FBCB2 2X NVG
DAGR EPLRS AN/TSC-154
AN/VAS-5
AN/VRC-90F



SGT 25N20 SR NODAL NT SYS OPR-MNT M4
PFC 25N10 NODAL NET SYS OPR M4

FBCB2 x2 NVG
AN/VAS-5 DAGR AN/TTC-59 (JNN)
EPLRS KSV-3
AN/VRC-90F
AN/TYQ-122



SPC 25N10 NODAL NET SYS OPR-MNT M4

AN/VAS-5
2X NVG
DAGR
EPLRS
AN/VRC-90F



SPC 25S10 SATCOM SYS OPR-MNT M4
PFC 25S10 SATCOM SYS OPR-MNT M4

AN/VAS-5 2X NVG
AN/VRC-90F
MK-19 HWTS
AN/VRC-104(V)3



SPC 25Q10 RANGE EXT OPR M4

HIGH CAP LINE OF SIGHT SECT PARA 06

AN/VAS-5 2X NVG
DAGR
AN/VRC-90F
AN/TRC-190(V)3



SGT 25Q20 SR XMSN SYS OPR M4
SPC 25Q10 XMSN SYS OPR M4
SPC 25Q10 XMSN SYS OPR M4
SPC 25Q10 XMSN SYS OPR M4
PFC 25Q10 XMSN SYS OPR M259

x2

RETRANSMISSION TEAM PARA 07

FBCB2
AN/VAS-5
2X NVG
3X AN/VRC-92F



SGT 25U20 TEAM CHIEF M4
SPC 25U10 RETRANS OPR M4
PFC 25U10 RETRANS OPR M4

x2

EPLRS NETWORK MANAGER AND GATEWAY PARA 08

FBCB2 DAGR
X2 NVG EPLRS
AN/VAS-5 AN/VRC-90F
AN/GRC-229 KOI-18/TSEC
KOK-13/TSEC AN/TSQ-158



SSG 25C30 ELPRS NCS SUPV M4
SP4 25C10 EPLRS NCS OPR M4
PFC 25C10 EPLRS NCS OPR M249

x2



SGT 25C20 SR EGRU OPR M4
SP4 25C10 EGRU OPR M4

x2

all Soldiers and equip x2

EQUIPMENT SUMMARY

WEAPONS

L69012	LAUNCHER GRENADE: M320A2	1
L69080	LAUNCHER GRENADE: M320A1	1
M09009	MACHINE GUN 5.56 MILLIMETER: M249	4
M39263	MACHINE GUN: LIGHT 5.56MM M249	3
M92362	MACHINE GUN GRENADE 40MM: MK19 MOD III	4
P98152	PISTOL 9MM AUTOMATIC: M9	1
R97234	RIFLE 5 56 MILLIMETER: M4	41

VEHICLES, TRAILERS AND TRLR MTD SYSTEMS

G42170	GEN SET DED TM: 10KW 60HZ MTD ONM116A2 PU-798	3
G42238	GEN SET DED TM: 5KW 60HZ MTD ON M116A2 PU-797	6
T37588	TRUCK UTILITY EXPANDED CAPACITY ENHANCED: M1152A1	8
T56383	TRUCK UTILITY EXPANDED CAPACITY ENHANCED 4X4: M1165A1	12
T61908	TRUCK CARGO: MTV W/E	1
T95924	TRAILER CARGO: HIGH MOBILITY 1-1/4 TON	2
T95992	LIGHT TACTICAL TRAILER: 3/4 TON	8
Z36683	TRAILER TANK WATER (CAMEL): 800 GAL 5 TON W/E	1

NIGHT VISION/OBSERVATION

D41659	DRIVERS ENHANCERS: ANVAS-5	27
N05482	NIGHT VISION: GOGGLE	45
S90535	MEDIUM WEAPON THERMAL SIGHT (MWTS): ANPAS-13(V)2	4
S90603	HEAVY WEAPON THERMAL SIGHT (HWTS): ANPAS-13(V)3	4

MISC EQUIPMENT

A33020	ALARM: CHEMICAL AGENT AUTOMATIC M22	10
C05701	MONITOR CHEMICAL AGENT:	2
G18358	GEN SET: DED SKID MTD 3KW 60HZ	6
G36237	GENERATOR SET DIESEL: 60HZ AC MEP-531A	2
J00697	JOINT CHMCL AGENT: DETECTOR	10
M12986	MASK CHEMICAL BIOLOGICAL JOINT SERVICE GENERAL PURPOSE: FIELD M50	45
R20684	RADIAC SET: ANVDR-2	12
R30925	RADIAC SET: ANPDR-75	1
R31061	RADIAC SET: ANUDR-13	12

COMMUNICATIONS AND ELECTRONICS

A81826	ANTENNA: AB-1404/TRC	2
C18378	COMPUTER SET: ANUYK-128(V)3	14
C27707	COMPUTER SYSTEM: DIGITAL ANTYQ-109(V)1	1
E03028	ELECT KEY GEN DEDICATED LOOP ENCRYPTION DEVICE: TSEC/KG-84	4
M13833	MAST: AB-1339A/G	6
N04580	NET CONTROL STATION: ANTSQ-158	2
N96248	NAVIGATION SET: SATELLITE SIGNALS AN/PSN-13	18
P49587	PJH SURFACE VEHICLE RADIO SET: ANVSQ-2(V)	16
P99881	PROCESSOR GROUP SIG DATA: (CAISI 2.0) OL-701A/TYQ	1
R44999	RADIO SET: ANVRC-89F(C)	1
R45543	RADIO SET: ANVRC-92F(C)	12
R68044	RADIO SET: ANVRC-90F(C)	20
R78005	RADIO SET GRID REFERENCE UNIT: ANVSQ-2 (N)4	4
R87139	RADIO ST: ANVRC-104(V)3 150 WATT W/PRC-150 HF RADIO	6
R90451	RADIO TERMINAL: LINE OF SIGHT MULTI-C ANTRC-190C(V)1	4
R90587	RADIO TERMINAL: LINE OF SIGHT MULTI-C ANTRC-190C(V)3	2
R91580	RADIO TERMINAL SET: ANGRC-229	2
S01373	SPEECH SECURITY EQUIPMENT: TSEC/KY-57	6
S24749	SWITCHING GROUP: DIGITAL DATA OA-9511/TYQ	2
T40405	TAPE READER GENERAL PURPOSE: KOI-18/TSEC	5
T43146	TELECONFERENCE SYS: ANTYQ-122	2
T81733	TERMINAL: SATELLITE COMMUNICATION AN/TSC-154	2
Z00056	PROCESSOR GROUP SIGNAL DATA: OL-700/TYQ	1
Z00384	COMPUTER SYSTEM DIGITAL: ANPYQ-10(C)	14
Z00562	JOINT NODE NETWORK (JNN) CENTRAL OFC TELEPHONE AUTOMATIC: AN/TTC	2
Z00564	BATTALION COMMAND POST(SWITCHING GROUP): OM-XXX	1
Z62433	REKEYING CONTROLLER: KOK-13/TSEC	2
Z92849	TRANSEC MODULE: KSV-3	2

MILITARY INTELLIGENCE COMPANY, BEB, BCT

34128RA00
4/5/64// 73

COMPANY HEADQUARTERS PARA 01

MISSION.

To provide timely, relevant, accurate, and synchronized Intelligence, Surveillance, and Reconnaissance (ISR) support to the maneuver units within the Brigade Combat Team, and support the BCT commander, staff and subordinates during the planning, preparation, and execution of multiple, simultaneous decisive actions on a distributed battlefield.

X2 NVG HWTS FBCB2 AN/VRC-92F	DAGR EPLRS AN/VAS-5	2X NVG .50 CAL HWTS X2 NVG DAGR X4 M-249 40MM MK93 AN/VRC-90F
---------------------------------------	---------------------------	---

CPT 35D00 CDR M4 M9
SPC 92Y10 SUPPLY SP M249

1LT 35D00 XO M4
1SG 35X5M 1SG M4
SGT 92Y20 SUPPLY NCO M4

IEW SYSTEMS INTEGRATION SECTION PARA 02

2X OL-701A/TYQ AN/VRC-90F	2X NVG AN/VRC-90F AN/ASM-146	AN/NJQ-37
------------------------------	------------------------------------	-----------

CW2 353T0 IEW EQUIP TECH M4
SPC 35T10 MI SYS MNTR./INTGR M4

SGT 35T20 MI SYS MNTR./INTGR M4
SPC 35T10 MI SYS MNTR./INTGR M4
T10 MI SYS MNTR./INTGR M4

AN/ASM-147

2X NVG
AN/VRC-90F

AN/NJQ-37

SGT 92A20 EQUIP REC/PARTS SGT M4
SPC 35T10 MI SYS MNTR./INTGR M249

INFO COLLECTION PLT HQ'S PARA 03

2X NVG
AN/VRC-90F

2LT 35D00 PLT LDR M4
SFC 35F40 PLT SGT M4

OPS MGMT TEAM PARA 04

DAGR 2X NVG MBTR AN/VAS-5 AN/VRC-91F	EPLRS AN/PYQ-3 AN/PYQ-8 AN/PC-5 AN/VRC-91F
--	--

CW2 351M0 HUMINT COLL TECH M4 M9
SSG 35M3L HUMINT COLL M4 M9
SPC 35M10 HUMINT COLLECTOR M4 M9
PFC 35M10 HUMINT COLLECTOR M4

CRYPTOLOGIC SUPPORT TEAM (CST) PARA 05

X2 NVG DAGR AN/VRC-90F AN/MSW-23	FBCB2 EPLRS AN/MSW-24 PROPHET-CTRL	2X NVG AN/VRC-90F AN/MSW-24
---	---	-----------------------------------

CW2 352N0 SIGINT ANLST TECH M4
SGT 35N20 SIGINT ANLST M4
SPC 35N10 SIGINT ANLST M4

SSG 35P30 SR CRYT LNGST M4
SPC 35N10 SIGINT ANLST M4
PFC 35N10 SIGINT ANLST M4

COMMON GROUND SENSOR (DCGS-A) PARA 06

DAGR 2X NVG AN/PSC-5 KOI-18/TSEC	EPLRS AN/VAS-5 AN/VRC-92F	2X NVG AN/VAS-5 AN/VSQ-2D(V)1 AN/TSQ-179
---	---------------------------------	---

SSG 35G30 IMAGERY SGT M4
SPC 35G10 IMAGERY ANLST M4

SGT 35G20 IMAGERY ANLST M4
SPC 35G10 IMAGER ANLST M4
PFC 35G10 IMAGERY ANLST M4
PFC 35G10 IMAGERY ANLST M249

RELEVANT ISR TO THE EDGE (RITE) PARA 07

2X NVG AN/VAS-5 AN/VRC-90F	NVG AN/TSQ-190(V)2/3 (TROJAN SPIRIT)
----------------------------------	--

SGT 35F20 INTEL ANLST M4
SFC 35F10 INTEL ANLST M4

SPC 35F10 INTEL ANLST M4

SYNCHRONIZATION AND COLL MGMT SECTION PARA 08

2X NVG FBCB2 AN/TYQ-93 AN/VRC-92F	DAGR EPLRS AN/TYQ-103 AN/VRC-92F	2X NVG DAGR AN/VRC-92E	M249 AN/VRC-90F	2X NVG DAGR AN/VRC-92E	M249 AN/VRC-90F
--	---	------------------------------	--------------------	------------------------------	--------------------

CW2 350F0 ALL SOURCE
INTEL TECH M4
SSG 35F30 INTEL ANLST M4

CW2 350F0 ALL SOURCE
INTEL TECH M4
SFC 35F40 SR INTEL SGT M4

SPC 35N10 SIGINT ANLST M4

SGT 35F20 INTEL ANLST M4
X2 SPC 35F10 INTEL ANLST M4
X2 PFC 35F10 INTEL ANLST M4

MULTI-FUNCTION PLT HQ PARA 09

DAGR EPLRS AN/VAS-5 AN/VRC-92F	FBCB2 2X NVG
---	-----------------

1LT 35D00 PLT LDR M4
SFC 35M40 PLT SGT M4

EXPLOITATION TEAM PARA 10

FBCB2 2X NVG EPLRS AN/VRC-92F AN/PSC-5	AN/PYQ-7 AN/PYQ-3 DAGR KOI-18/TSEC
--	---

SGT 35F20 INTEL ANLST M4
SPC 35F10 INTEL ANLST M4
PFC 35F10 INTEL ANLST M4

BCT Mft SECTION PARA 11

AN/VAS-5 2X NVG FBCB2 M240B EPLRS AN/PSC-5	AN/VRC-90F AN/PRC-119F HWTS DAGR AN/VRC-92F	2X NVG DAGR EPLRS AN/VRC-90F
---	---	---------------------------------------

SSG 35M30 HUMINT COLL SGT M4 M9
SGT 35M2L HUMINT COLLECTR M4 M9
SPC 35M10 HUMINT COLL SPC M4 M9
PFC 35M10 HUMINT COLL SPC M4 M9

SGT 35P2L CRYPTO LINGUIST M4
SPC 35P1L CRYPTO LINGUIST M4
SPC 35P1L CRYPTO LINGUIST M4

STAFF WEATHER OFFICE PARA 12

DAGR 2X NVG AN/VRC-90F	EPLRS AN/GMQ-36
------------------------------	--------------------

*SSG 00D30 AIRFORCE STAFF NCO M4
SGT 00D20 AIR FORCE STAFF NCO M4
SGT 00D20 AIR FORCE STAFF NCO M4
SGT 00D20 AIR FORCE STAFF NCO M4

x3

EQUIPMENT SUMMARY

WEAPONS

L69080	LAUNCHER GRENADE: M320A1	4
M09009	MACHINE GUN 5.56 MILLIMETER: M249	3
M39263	MACHINE GUN: LIGHT 5.56MM M249	7
M92362	MACHINE GUN GRENADE 40MM: MK19 MOD III	1
M92841	MACHINE GUN: 7.62MM M240B	2
P98152	PISTOL 9MM AUTOMATIC: M9	16
R97234	RIFLE 5 56 MILLIMETER: M4	70
Z00686	MACHINE GUN: CALIBER .50	1

VEHICLES, TRAILERS AND TRLR MTD SYSTEMS

S01563	SHELTER: NONEXPD LTWR MP RIGID -WALL S788 102LX84WX67H MTD HMMWV	2
T34704	TRUCK UTILITY: ECV ARMAMENT CARRIER W/IAP ARMOR READY M1151A1	6
T37588	TRUCK UTILITY EXPANDED CAPACITY ENHANCED: M1152A1	8
T41515	TRUCK CARGO: 5 TON WO/WINCH	6
T56383	TRUCK UTILITY EXPANDED CAPACITY ENHANCED 4X4: M1165A1	8
T95555	TRAILER CARGO: MTV W/DROPSIDES M1095	1
T95924	TRAILER CARGO: HIGH MOBILITY 1-1/4 TON	7
T95992	LIGHT TACTICAL TRAILER: 3/4 TON	4
Z01395	TRAILER-MTD: PU-2102/ 30 KW/ 50/60HZ/ M200A1	1
Z01415	TRAILER-MTD: PP-3102/ 10 KW/ 50/60HZ/ M200A1	3
Z36683	TRAILER TANK WATER (CAMEL): 800 GAL 5 TON W/E	1

NIGHT VISION/OBSERVATION

D41659	DRIVERS ENHANCERS: AN/VAS-5	14
N05482	NIGHT VISION: GOGGLE	66
S90535	MEDIUM WEAPON THERMAL SIGHT (MWTS): AN/PAS-13(V)2	9
S90603	HEAVY WEAPON THERMAL SIGHT (HWTS): AN/PAS-13(V)3	2

COMMUNICATIONS AND ELECTRONICS

A35329	ALL SOURCE ANALYSIS SYSTEM: AN/TYQ-93	5
C18176	COMPUTER SYSTEM: DIGITAL AN/TYQ-103	1
C18244	COMPUTER SYSTEM: DIGITAL AN/PYQ-7	1
C18312	COMPUTER SYSTEM: DIGITAL AN/PYQ-3	4
C18378	COMPUTER SET: AN/UJK-128(V)3	15
C27707	COMPUTER SYSTEM: DIGITAL AN/TYQ-109(V)1	1
C43399	CENTRAL: COMMUNICATIONS AN/TSQ-226(V)3	1
C77823	COMPUTER: SYSTEM DIGITAL AN/PYQ-8	6
E08940	ENCRYPTION-DECRYPTION EQUIPMENT: TACLANE KG 175	2
J41800	INTEGRATED METEOROLOGICAL SYSTEM LIGHT: AN/GMQ-36	1
J54771	INTERCONNECT GROUP: ON-721/V	2
M18029	MBITR: URBAN VERSION	6
N96248	NAVIGATION SET: SATELLITE SIGNALS AN/PSN-13	19
P49587	PJH SURFACE VEHICLE RADIO SET: AN/VSQ-2(V)	14
P99881	PROCESSOR GROUP SIG DATA: (CAISI 2.0) OL-701A/TYQ	2
R22666	RADIO FREQUENCY POWER TEST SET: AN/URM-213	1
R45543	RADIO SET: AN/VRC-92F(C)	7
R57606	RADIO SET: AN/PSC-5	7
R68044	RADIO SET: AN/VRC-90F(C)	14
R68146	RADIO SET: AN/VRC-91F(C)	6
R83141	RADIO SET: AN/PRC-119F(C)	2
R87139	RADIO ST: AN/VRC-104(V)3 150 WATT W/PRC-150 HF RADIO	1
S01373	SPEECH SECURITY EQUIPMENT: TSEC/KY-57	1
T37036	TARGET ACQUISITION SUBSYSTEM: COMMON GROUND STATION AN/TSQ-179(V)	1
T40405	TAPE READER GENERAL PURPOSE: KOI-18/TSEC	3
Z00993	DETECTING SYSTEM COUNTERMEASURES: AN/MLQ-40(V)4	2
Z01041	DATA ANALYSIS CENTRAL: AN/MSW-24	1
Z01162	COMPUTER SYSTEM: DIGITAL AN/TYQ-139	1
Z01247	COMPUTER SET: DIGITAL AN/UJK-128(V)1	6

MISC EQUIPMENT

C05701	MONITOR CHEMICAL AGENT:	6
G74711	GEN SET: DED SKID MTD 10KW 60HZ	2
H01907	ELECTRONIC SHOP SHELTER MOUNTED AVIONICS: AN/ASM-146 LESS POWER	1
H01912	ELECTRONIC SHOP SHELTER MOUNTED AVIONICS: AN/ASM-147 LESS POWER	1
M12986	MASK CHEMICAL BIOLOGICAL JOINT SERVICE GENERAL PURPOSE: FIELD M50	67
R20684	RADIAC SET: AN/VDR-2	8
R30925	RADIAC SET: AN/PDR-75	1
R31061	RADIAC SET: AN/UDR-13	13

Tactical Unmanned Aircraft System (TUAS) Platoon, BEB, IBCT

01708RA00
0/2/25// 27

MISSION: To provide airborne imagery intelligence support.

PLT HQ PARA 01

AN/TYQ-151(V)2
AN/VRC-92F

CW3 150UB PLT LDR M4
SFC 15W40 PLT SGT M4
CW2 150U0 UAS OPS TECH M4

MSN PLNG & CTL SEC PARA 02

x2 NVG
DAGR
EPLRS
Ground Control
Station (TUAV-SHADOW)



AN/UYK-128(V)3
AN/TYQ-151(V)1
AN/TYQ-151(V)3
x2 AN/TYQ-150(V)1
x2 AN/VRC-89F
AN/VRC-92F
GDT TUAV-SHADOW



x2

SSG 15W30 UAV SGT M4	SGT 15W20 UAV OPR M4
SGT 15W20 UAV OPR M4	PFC 15W10 UAV OPR M4
SPC 15W10 UAV OPR M4	PFC 15W10 UAV OPR M4
SPC 15W10 UAV OPR M4	SPC 15W10 UAV OPR M4
SPC 15E10 UAS SYS REP M249	

LAUNCH & RECOVERY SECTION PARA 03

AN/TYQ-151(V)2
x5 AN/TYQ-151(V)1
x2 NVG

(EQUIP VEH)



x4

SFC 15E40 SR UAS SYS CHIEF M4
SSG 15W30 UAV SGT M4
SSG 15E30 UAS SYS TECH INSP M4
SGT 15E20 UAS SYS TEP TM CH M4
SGT 15W20 UAV OPR M4
SGT 15W20 UAV OPR M4

x2 OL-701A/TYQ
AN/VRC-89F
AN/TYQ-151(V)1 ULLS-A(E)
x2 NVG

ATV



AN/VRC-89F
PGDT
AN/TYQ-151(V)1 ULLS-A(E)
x2 NVG

PGCS



x2 OL-701/TYQ
AN/VRC-89F
AN/TYQ-151(V)1 ULLS-A(E)
AN/TYQ-151(V)2
x2 NVG

MSMF

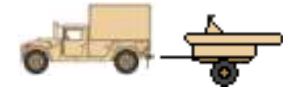

SGT 15E20 UAS SYS TECH INSP M4
PFC 15E10 UAS SYS REP M4
PFC 15W10 UAS SYS REP M4
PFC 15W10 UAV OPR M4
PFC 15W10 UAV OPR M249
SPC 15W10 UAV OPR M4
SPC 15E10 UAS SYS REP M4
SPC 15E10 UAS SYS REP M4
SPC 15W10 UAV OPR M4

EQUIPMENT SUMMARY

WEAPONS

MACHINE GUN 5.56MM M249 ----- 2
RIFLE 5.56MM M4 CARBINE----- 25

VEHICLES, TRAILERS, AND TRLR MTD SYSTEMS

TRUCK UTILITY EXP CAPACITY ENH 4X4: M1152A1----- 6
TRUCK CARGO: 4X4 LMTV (M1078)----- 1
TRAILER HIGH MOBILITY 1-1/4T (M1102)----- 4

MISCELLANEOUS EQUIPMENT

GEN SET DIESEL: 60HZ AC MEP-531A----- 8
GEN SET: DED SKID MTD 10KW 60HZ (MEP-803A)----- 2
SAW CHAIN: GAS DRVN BAR FRAME----- 2

TUAS SYSTEM EQUIPMENT

AIR VEHICLE TRANSPORTER: (AVT) (TUAV-SHADOW)----- 1
GROUND CONTROL STATION (GCS): (TUAV-SHADOW)----- 2
MOBILE SECTION MULTI-FUNCTIONAL : (MSMF)----- 1
TACT UNMANNED AERIAL VEHICLE SYSTEM: (SHADOW)----- 1
UNMANNED AERIAL VEHICLE LAUNCHER: (TUAV-SHADOW)----- 2
PORTABLE GROUND DATA TERMINAL (PGDT)----- 1
PORTABLE GROUND CONTROL STATION (PGCS)----- 1
UNMANNED AERIAL VEHICLE (UAV): (TUAV-SHADOW)----- 4
TACTICAL AUTOMATIC LANDING SYSTEM: (TALS)----- 2
GROUND DATA TERMINAL (GDT): (TUAV-SHADOW)----- 2

COMMUNICATION-ELECTRONICS EQUIPMENT

ANTENNA GROUP: OE-254----- 5
COMP SET DIGIT: AN/UYK-128(V)3 (FBCB2 BFT APPLIQUE)---- 2
COMPUTER SYSTEM DIGITAL: (AMPS)----- 2
COMPUTER SET DIGITAL: AN/TYQ-151(V)2----- 3
COMPUTER SET DIGITAL: AN/TYQ-151(V)3----- 2
COMPUTER SET DIGITAL: AN/TYQ-150(V)1 ULLS-A(E)----- 2
COMPUTER SET DIGITAL: AN/TYQ-151(V)1 ULLS-A(E)----- 10
NAV SET: SATELLITE SIGNALS AN/PSN-13 (DAGR)----- 2
PROCESSOR GRP SIGNAL DATA: (CAISI 2.0) OL-701A/TYQ----- 2
RADIAC SET: AN/VDR-2----- 3
RADIO SET: AN/VRC-89F----- 7
RADIO SET: AN/VRC-92F----- 3

NIGHT VISION/OBSERVATION EQUIPMENT

NIGHT VISION GOGGLES: AN/PVS-7B----- 16

HHT, CAVALRY SQDN, IBCT

17416R000
23/0/120//143

MISSION: To provide command, control, and supervision of the tactical operations of the Reconnaissance Squadron and attached units; unit administration and logistical support for the squadron staff sections; and administrative and medical support to organic and attached units.

COMMAND GROUP PARA 01

FBCB2
x2 NVG
DAGR
AN/VRC-92F
AN/VRC-104(V)3
AN/PRC-119F
AN/UYK-128(V)3
ON-721/V
AN/PSC-5
AN/MRC-150

LTC 02B00 CDR M4 M9 ENVG
AN/PRC-119F AN/PSC-5
SPC 19D10 OPS SPEC M4
SPC 19D10 SCT DRIVER M4

FBCB2
AN/VAS-5
x2 NVG
DAGR
AN/VRC-90F
AN/UYK-128(V)3

MAJ 02B00 EXEC OFF M4 M9 ENVG
CSM 00R60 CSM M4 M9
SPC 19D10 SCOUT DRIVER M4



CURRENT OPS-INTEL/S2 PARA 02

FBCB2
AN/VAS-5
x2 NVG
DAGR
AN/VRC-92F

x2 AN/TYQ-93
AN/TYQ-93(V)2
AN/UYK-128(V)3
AN/TYQ-137B(V)3
ON-721/V
AN/VRC-104(V)3

CPT 35D00 S2 M4 ENVG
1LT 35D00 TAC INTEL OFF M4
SSG 35F30 INTEL SGT M4
X2 SGT 35F20 INTEL ANLST M4
SGT 35F20 INTEL ANLST M4
X4 SPC 35F10 INTEL ANLST M4
SPC 35F10 INTEL ANLST M4
SPC 35F10 INTEL ANLST M4
PFC 35F10 INTEL ANLST M4
PFC 35F10 INTEL ANLST M4



CURRENT OPS-OPS/S3 PARA 03

FBCB2
AN/PSC-5
x2 NVG
x2 DAGR
AN/VRC-92F
AN/VRC-104(V)3
AN/UYK-128(V)3
AN/MRC-149

MAJ 02B00 S3 M4 M9 ENVG
AN/PRC-119F AN/PSC-5
CPT 19C00 PLANS OFF M4
SFC 11B40 ASST OPS SGT M4
SPC 11B10 OPS ASST M4

x2 NVG
DAGR
AN/VRC-90F

CPT 19C00 PLANS OFF M4
MSG 19Z60 OPS SGT M4

CPT 19C00 PLANS OFF M4
LT 74A00 CBRN OFF M4
SFC 19D40 ASST OPS SGT M4
SFC 11B40 ASST OPS SGT M4
SSG 74D30 CBRN NCO M4
SSG 19D30 ASST OPS SGT M4
SGT 19D20 OPS ASST M4
SPC 74D10 CBRN DECON SP M4

AN/MJQ-48 PU
PU 801 A UNIT
PU 805 B UNIT

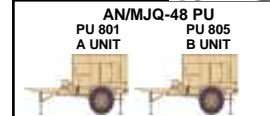

CURRENT OPS-FIRE SPT PARA 04

DAGR
FBCB2
AN/VRC-90F
OL-701A/TYQ
AN/UYK-128(V)3
AN/TYQ-137B(V)3

x2 NVG
KG-175
AN/VRC-92F
AN/VRC-104(V)3
AN/TYQ-129(V)2
AN/UYQ-90(V)3

SSG 29E30 EW SGT M4
SGT 29E20 EW SGT M4

DAGR
KG-175
AN/VRC-92F

FBCB2
AN/VAS-5
AN/UYK-128(V)3

ALL MOVED TO FIRES BN

CPT 13A00 FIRES SPT OFF M4
AN/PRC-119F
1LT 13A00 ASST FIRE SPT OFF M4
SFC 13F40 FIRES SPT SGT M4
SSG 13F30 TGT NCO M4
SGT 13F20 FIRES SPT SGT M4
SPC 13F10 FIRE SPT SP M4
SPC 13F10 FIRE SPT SP M4



CURRENT OPS-FIRE SPT/TACP PARA 05

AN/PED-1 (LLDR)
AN/GYK-56

*CPT 01A00 AIR FORCE STAFF OFF M4
SSG 00D30 AIR FORCE STAFF NCO M4
SPC 00D10 AIR FORCE ENLISTED M4

*USAF PERSONNEL NOT ASSIGNED TO UNIT

SUSTAINMENT-S1 PARA 06

AN/VAS-5
x2 NVG
AN/VRC-90F

OL-701A/TYQ
x5 AN/TYQ-118(V)3

CPT 42B00 S1 M4 AN/PAS-20
SSG 42A30 HR SGT M4
SGT 42A20 HR SGT M4
SPC 42A10 HR SP M4
SPC 42A10 HR SP M4
SPC 27D10 PARALEGAL M4
PFC 42A10 HR SP M4
PFC 42A10 HR SP M4



SUSTAINMENT-S4 PARA 07

FBCB2
DAGR
AN/VRC-218(V)3

x2 NVG
AN/VRC-90F

CPT 11A00 S4 M4

KG-175
AN/VRC-92F
AN/UYQ-90(V)3
AN/UYK-128(V)3
AN/TYQ-109(V)1

AN/VRC-90F
OL-701A/TYQ
AN/VRC-104(V)3
AN.TYQ-129(V)2
AN/TYQ-137B(V)3

MED PWR PLANT

SFC 92Y40 SR SUPPLY SGT M4
SPC 92Y10 SUPPLY SPEC M4



SUSTAINMENT-UMT PARA 08

DAGR
AN/VRC-90F
AN/TYQ-137B(V)3

x2 NVG
AN/UYK-128(V)3

CPT 56A00 CHAPLAIN
SGT 56M20 CHAPLAIN ASST M4



HHT, CAVALRY SQDN, IBCT

SUSTAINMENT-C4 OPS/S6 PARA 09

FBCB2
x2 NVG
DAGR
AN/VRC-90F
AN/UJK-218(V)3



CPT 25A00 S6 M4
SSG 25U30 SIG INFO SVC NCO M4

AN/VRC-90F
AN/UJK-128(V)3
AN/PYQ-12
ON-721/V
AN/TSR-8(GRT)
2X AN/GYK-62B



x2 NVG
AN/VRC-90F
AN/PYQ-12
AN/TSQ-243
AN/TSQ-259



J-798

SFC 25U40 SECT CHIEF M4
SPC 25U10 SIG SPT SP M4

SSG 25E30 ELECTRO SPECT NCO M4
SGT 25Q20 SR XMSN SYS OPR/MNT M4
SPC 25U10 SIG SPT SYS MAINT M4
SPC 25B10 LAN MGR M4
PFC 25B10 LAN MGR M4

x2 NVG
AN/VRC-90F

BATTALION COMMAND POST
SWITCHING GROUP:OM-87A/T



SGT 25Q20 SR XMSN SYS OPR/MNT M4
SPC 25Q10 XMSN SYS OPR/MNT M4
SPC 25N10 NODAL NET SYS OPR/MNT M4
SPC 25Q10 XMSN SYS OPR M4
PFC 25N10 NODAL NET SYS OPR/MNT M4

RETRANSMISSION SECTION PARA 10

FBCB2 x2 NVG
DAGR
x2 AN/VRC-92F
AN/MRC-149



SSG 25U30 TEAM CHIEF M4
SPC 25U10 RADIO RETRANS OPR M4
PFC 25U10 RADIO RETRANS OPR M4

FBCB2 x2 NVG
DAGR
AN/VRC-92F
AN/MRC-149
AN/UJK-128(V)3



SGT 25U20 TEAM CHIEF M4
SPC 25U10 RADIO RETRANS OPR M4
PFC 25U10 RADIO RETRANS OPR M4

x2

TROOP HEADQUARTERS PARA 11

FBCB2
x2 NVG
DAGR
AN/VRC-92F
AN/UJK-128(V)3



CPT 11A00 CDR M4 M9 NVG
SPC 92Y10 SUPPLY SP M4

FBCB2
DAGR
OL-701A.TYQ AN/PRC-104A
AN/UJK-128(V)3
AN/TYQ-109(V)1



1LT 19C00 XO M4
1SG 11Z5M 1SG M4
SSG 92Y30 SUPPLY SGT M4

FBCB2
x2 NVG
DAGR
AN/VRC-92F
AN/UJK-128(V)-



MEDICAL TREATMENT PLT HQ PARA 12

x2 NVG
DAGR
AN/VRC-89F
AN/TYQ-107(V)1
AN/UJK-128(V)3
AN/TYQ-108(V)3
OL-701A/TYQ



1LT 70B67 FLD MED ASST M4
SFC 68W40 PLT SGT M4

MEDICAL TREATMENT SQUAD PARA 13

x2 NVG
DAGR
AN/VRC-89F
AN/UJK-128(V)3
OL-701A/TYQ



CPT 62B00 FLD SURGEON M9
1LT 65D00 PHYSICIAN ASST M9

DAGR
AN/VRC-89F
AN/TYQ-106(V)1
x4 AN/TYQ-105(V)1



x2

SSG 68W30 HLTH CARE SGT M4
SGT 68W20 HLTH CARE SGT M4
SGT 68W20 HLTH CARE SGT M4
PFC 68W10 HLTH CARE SP M4
PFC 68W10 HLTH CARE SP M4
PFC 68W10 HLTH CARE SP M4

AMBULANCE SQD (WHEELED) PARA 14

x2 NVG
DAGR
AN/VRC-90F
AN/UJK-128(V)3
x2 AN/TYQ-105(V)1



x8

SGT 68W20 EMERG CARE SGT M4
SGT 68W20 EMERG CARE SGT M4
x2SP4 68W10 AMB AIDE/DRIVER M4
x2SP4 68W10 AMB AIDE/DRIVER M4
x2SP4 68W10 AMB AIDE/DRIVER M4
X2 PFC 68W10 AMB AIDE/DRIVER M4
X2 PFC 68W10 AMB AIDE/DRIVER M4

COMBAT MEDIC SECTION PARA 15

x11 AN/TYQ-105(V)1

x2 SGT 68W20 EMERG CARE SGT M9
x6 SPC 68W10 COMBAT MEDIC M9
x3 SPC 68W10 COMBAT MEDIC M9

MOVED TO FIRES BN FIRES SUPPORT PLATOON

M249 DAGR
FBCB2 AN/PED-1
AN/VAS-5 AN/PSG-14(V)1
MWTS x2 AN/VRC-91F



1LT 13A00 FSO M4 ILLUM NVG
AN/PRC-119F AN/PSC-5
SSG 13F30 FIRE SP SGT M4 ILLUM NVG
SGT 13F20 FWD OBSERVER M4
SPC 13F10 FIRE SPT SPEC M4 ILLUM NVG
PFC 13F10 FIRE SPT SPEC M4 NVG

x2

(MOTORIZED TROOP)

x8 DAGR x8 AN/PSC-5
x8 AN/PSG-10(V)

SGT 13F20 FO M4 NVG DAGR
AN/PSC-5
PFC 13F10 RATELO M4 NVG

x8

(DISMOUNT TROOP)

MWTS M249
DAGR FBCB2
AN/PED-1 AN/VAS-5
x2 AN/VRC-91F
AN/PSG-14(V)1



1LT 13A00 FSO M4 ILLUM NVG
AN/PRC-119F AN/PSC-5
SSG 13F30 FIRE SP SGT M4 ILLUM NVG
SPC 13F10 FIRE SPT SP M4 ILLUM NVG

EQUIPMENT SUMMARY

WEAPONS		COMMUNICATIONS AND ELECTRONICS		
L69080	LAUNCHER GRENADE: M320A1	8	A35329 ALL SOURCE ANALYSIS SYSTEM: AN/TYQ-93	2
M39263	MACHINE GUN: LIGHT 5.56MM M249	7	A35397 ALL SOURCE ANALYSIS SYSTEM: AN/TYQ-93(V)2	1
P98152	PISTOL 9MM AUTOMATIC: M9	19	C04819 COMTER SYS DIG: AN/PSG-14(V)1 LFED	3
R97234	RIFLE 5 56 MILLIMETER: M4	99	C17936 COMPUTER SET: AN/GYG-1(V)1	1
Z00686	MACHINE GUN: CALIBER .50	3	C18277 COMPUTER SET: DIGITAL AN/TYQ-107(V)1	1
VEHICLES, TRAILERS AND TRLR MTD SYSTEMS		COMMUNICATIONS AND ELECTRONICS		
C07506	CHEMICAL BIOLOGICAL PROTECTIVE SHELTER: (CBPS)	2	C18345 COMPUTER SET: DIGITAL AN/TYQ-106(V)1	3
K29708	KNIGHT: ARMORED	3	C18378 COMPUTER SET: AN/UYSK-128(V)3	28
P63462	POWER PLANT: UTILITY (MEDIUM)	2	C18641 COMPUTER SYST DIGITAL: AN/PYQ-12	2
P63530	POWER PLANT: ELETRIC TRAILER MOUNTED	1	C27435 COMPUTER SYSTEM: DIGITAL AN/TYQ-129(V)2	2
			C27503 COMPUTER SYSTEM: DIGITAL AN/TYQ-105(V)1	27
T34704	TRUCK UTILITY: ECV ARM CARR W/IAP ARMOR READY M1151A1	2	C27707 COMPUTER SYSTEM: DIGITAL AN/TYQ-109(V)1	2
T37588	TRUCK UTILITY EXPANDED CAPACITY ENHANCED: M1152A1	10	C27963 COMPUTER SYSEM: DIGITAL	6
T38844	TRUCK AMBULANCE: 4 LITTER ARMD 4X4 W/E (HMMWV)	4	C61665 COMMAND CENTER SYSTEM: AN/TSQ-243	1
T56383	TRUCK UTILITY EXPANDED CAPACITY ENHANCED 4X4: M1165A1	10	C78851 COMPUTER SYSTEM: DIGITAL AN/UYSK-90(V)3	1
T60081	TRUCK CARGO: 4X4 LMTV W/E	1	C79281 COMPUTER ST FIELD ARTILLERY GENERAL: AN/GYK-48(V)1	1
T61908	TRUCK CARGO: MTV W/E	3	E08940 ENCRYPTION-DECRYPTION EQUIPMENT: TACLANE KG 175	2
T95555	TRAILER CARGO: MTV W/DROPSIDES M1095	1	J54771 INTERCONNECT GROUP: ON-721/V	4
T95992	LIGHT TACTICAL TRAILER: 3/4 TON	7	J99233 INTERROGATOR SET: AN/TYX-1	1
T96564	TRAILER FLAT BED: M1082 TRLR CARGO LMTV W/DROPSIDES	1	P99881 PROCESSOR GROUP SIG DATA: (CAISI 2.0) OL-701A/TYQ	5
Z36683	TRAILER TANK WATER (CAMEL): 800 GAL 5 TON W/E	1	R44999 RADIO SET: AN/VRC-89F(C)	4
	NIGHT VISION/OBSERVATION		R45543 RADIO SET: AN/VRC-92F(C)	18
D41659	DRIVERS ENHANCERS: AN/VAS-5	35	R55200 RADIO SET: AN/PRC-104A	1
J03261	ILLUMINATOR: INFRARED	18	R57606 RADIO SET: AN/PSC-5	13
M79678	MONOCULAR NIGHT VISION DEVICE: AN/PVS-14	7	R68044 RADIO SET: AN/VRC-90F(C)	16
N05482	NIGHT VISION: GOGGLE	101	R68146 RADIO SET: AN/VRC-91F(C)	6
N07848	NIGHT VISION DEVIC: ENVG	6	R83141 RADIO SET: AN/PRC-119F(C)	6
S90535	MEDIUM WEAPON THERMAL SIGHT (MWTS): AN/PAS-13(V)2	7	R87139 RADIO ST: AN/VRC-104(V)3 150 WATT W/PRC-150 HF RADIO	6
S90603	HEAVY WEAPON THERMAL SIGHT (HWTS): AN/PAS-13(V)3	3	R93169 RADIO TEST SET: AN/PRM-34()	4
	MISC EQUIPMENT		Z00058 COMPUTER SYSTEM DIGITAL: AN/PSG-10(V)	11
C05701	MONITOR CHEMICAL AGENT:	6	Z00129 COMPUTER SET FIELD ARTILLERY GENERAL: AN/GYK-56	1
C07506	CHEMICAL BIOLOGICAL PROTECTIVE SHELTER: (CBPS)	2	Z00384 COMPUTER SYSTEM DIGITAL: AN/PYQ-10(C)	56
C79000	COLLECTIVE PROTECTION EQUIPMENT: NBC SIMPLIFIED M20	4	Z00512 COMPUTER SYSTEM DIGITAL: AN/GYK-50A (ISYSCON) (V)4	1
C96840	CONTROL REMOTE LANDMINE SYSTEM: M71	2	Z00564 BATTALION COMMAND POST(SWITCHING GROUP): OM-XXX	1
D82404	DECONTAMINATING APPARATUS: PWR DRVN LT WT	2	Z00930 COMMUNICATIONS SUBSYSTEM: AN/TSQ-259	1
G18358	GEN SET: DED SKID MTD 3KW 60HZ	7	Z01248 COMPUTER SET: DIGITAL AN/GYK-62B	2
G42170	GEN SET DED TM: 10KW 60HZ MTD ONM116A2 PU-798	1	Z39781 ARMY H RESURCES: WRKSTATION	5
J00697	JOINT CHMCL AGENT: DETECTOR	18		
J01197	JOINT SERVICE: TRANSPORTABLE DECONTAMINATION	2		
M12986	MASK CHEMICAL BIO JOINT SERVICE GEN PURPOSE: FIELD M50	126		
M13236	MASK CHEM-BIO JNT SRV GNL PRPSE: CMBT VHL CRWMM M51	11		

HHT, CAVALRY SQDN, IBCT

MOTORIZED CAVALRY TROOP, CAV SQDN, IBCT

17217R000
5/0/87// 92

TROOP HEADQUARTERS PARA 01

MORTAR SECTION PARA 02

MISSION: To conduct reconnaissance and surveillance supporting the development of the brigade's situational awareness and knowledge in the area of operations.

FBCB2
x2 NVG
DAGR
AN/VRC-92F
AN/PRC-119F
AN/UJK-128(V)3
ON-721/V
AN/PED-1(LLDR)
AN/VRC-90F
LRAS3
AN/MRC-149



CPT 19C00 CDR M4 M9 ILLUM ENVG
AN/PRC-119F
SGT 19D20 OPS ASST M4 ILLUM
SPC 19D10 SCOUT DRIVER M4 ILLUM

FBCB2
x2 NVG
DAGR
AN/VRC-92F
AN/VRC-90F
AN/UJK-128(V)3



1SG 19Z5M 1SG M4 ILLUM ENVG
SGT 25U20 FWD SIG SPT NCO M4
PFC 19D10 VEH DRIVER M4 ILLUM

DAGR
KG-175
ON-721/V
AN/VRC-90F
AN/UJK-128(V)3

FBCB2
x2 NVG
AN/VRC-92F
AN/VRC-104(V)3



1LT 19C00 XO M4 ILLUM ENVG
SSG 19D30 OPS NCO M4 ILLUM

DAGR
x2 NVG
OL-701A/TYQ
AN/TYQ-109(V)1



SGT 74D20 CBRN NCO M4 ILLUM
SGT 92Y20 SUPPLY NCO M4 ILLUM
SPC 92Y10 SUPPLY SP M4 ILLUM

M150 MFCS
M32 LHMCB
AN/VRC-91F
AN/UJK-128(V)1
MORTAR 120MM



SSG 11C30 SQD LDR M4 ILLUM
SPC 11C10 GUNNER M4 ILLUM
PFC 11C10 ASST GUNNER M4 ILLUM
PFC 11C10 AMMO BEARER M4 ILLUM

M150 MFCS
M32 LHMCB
AN/VRC-91F
AN/UJK-128(V)1
MORTAR 120MM



SSG 11C30 SQD LDR M4 ILLUM
SPC 11C10 GUNNER M4 ILLUM
PFC 11C10 ASST GUNNER M4 ILLUM
PFC 11C10 AMMO BEARER M4 ILLUM

DAGR
FBCB2
x2 NVG
AN/VAS-5
AN/VRC-92F
AN/UJK-128(V)3



SFC 11C40 SECTION LDR M4 ILLUM

SCOUT PLATOON PARA 03, 04, 05

3X JAVELIN
2X ON-721/V
3X M240L
AN/PED-1
3X LWTS
3X MWTS
SUGV

FBCB2
MK-19
x2 DAGR
AN/VRC-92F
AN/VRC-104(V)3
AN/PRC-119F
AN/UJK-128(V)3
ON-721/V
LRAS3
2 LMR
HAND HELD RADIO

FBCB2
AN/VAS-5
x2 DAGR
AN/VRC-91F
AN/UJK-128(V)3
SHOTGUN
LRAS3
3 LMR
HAND HELD RADIO

FBCB2
AN/VAS-5
x2 DAGR
AN/VRC-91F
AN/UJK-128(V)3
SHOTGUN
ITAS
2 LMR

FBCB2
AN/VAS-5
x2 DAGR
AN/VRC-91F
AN/UJK-128(V)3
SHOTGUN
LRAS3
3 LMR
HAND HELD RADIO

FBCB2
AN/VAS-5
x2 DAGR
AN/VRC-91F
AN/UJK-128(V)3
SHOTGUN
ITAS
2 LMR



1LT 19C00 PLT LDR M4
ENVG AN/PRC-148
AN/PRC-119F HWTS
PFC DRIVER M4 ILLUM
ENVG
SPC 19D10 JAVELIN GNR M4
ILLUM ENVG LMR
PFC 19D10 SCOUT M4 ILLUM
ENVG LMR



SFC 19D40 PLT SGT M4
ENVG AN/PRC-148
AN/PRC-119F
PFC 19D10 SCOUT M4 ILLUM
ENVG
SPC 19D10 SCOUT M4 ILLUM
ENVG LMR
SPC 19D10 JAVELIN GNR M4
ILLUM ENVG LMR



SSG 19D30 SEC LDR M4
ENVG AN/PRC-148
PFC 19D10 SCOUT M4
ILLUM ENVG
SGT 19D20 TM LDR M4
ILLUM ENVG LMR
SPC 19D10 JAVELIN GNR
M4 ILLUM ENVG
LMR



SGT 19D20 TM LDR M4
ILLUM ENVG LMR
PFC DRIVER 19D10 M4
ILLUM ENVG
SGT 19D20 TOW GNR M9 ILLUM
NVG
SPC 19D10 SCOUT M4
ILLUM ENVG .MR



SSG 19D30 SEC LDR M4
ENVG AN/PRC-148
PFC 19D10 SCOUT M4
ILLUM ENVG
PFC 19D10 SCOUT M4
ILLUM ENVG LMR
SPC 19D10 JAVELIN GNR
M4 ILLUM ENVG
LMR



SGT 19D20 TM LDR M4
ILLUM ENVG LMR
PFC DRIVER 19D10 M4
ILLUM ENVG
SGT 19D20 TOW GNR M9 ILLUM
NVG
PFC 19D10 SCOUT M4
ILLUM ENVG .MR

x3

EQUIPMENT SUMMARY

WEAPONS

COMMAND LAUNCH UNIT (JAVELIN)-----	9
LAUNCHER GRENADE: M320A1-----	10
MACHINE GUN: CALIBER .50 (M2E2)-----	8
MORTAR 120MM TOWED-----	2
MACHINE GUN GRENADE 40MM MK-19 MOD III-----	6
MACHINE GUN 7.62MM: M240L-----	9
MACHINE GUN 7.62MM M240B-----	4
PISTOL 9MM AUTOMATIC M9-----	7
RIFLE 5.56MM M4 CARBINE-----	86
SHOTGUN: 12 GAUGE (MASS) XM26-----	12

VEHICLES, TRAILERS, AND TRLR MTD SYSTEMS

TRUCK UTIL: ECV ARMT CARRIER W/IAP ARMOR M1151A1-----	13
TRUCK UTIL: ECV TOW CARRIER W/IAP M1167A1-----	6
TRUCK UTILITY EXP CAPACITY ENH 4X4: M1152A1-----	2
TRUCK CARGO: MTV W/MHE (M1084)-----	1
TRUCK CARGO: MTV (M1083)-----	1
TRUCK UTILITY EXP CAPACITY ENH 4X4: M1165A1-----	2
TRAILER CARGO: MTV W/ DROPSIDES (M1095)-----	1
TRAILER HIGH MOBILITY 1-1/4T (M1102)-----	3
LIGHT TACTICAL TRAILER: 3/4T (M1101)-----	1
TRAILER TANK WATER (CAMEL) 800 GAL 5 TON-----	1

MISCELLANEOUS EQUIPMENT

GEN SET: DED SKID MTD 5 KW 60HZ (MEP-802A)-----	1
HOIST UNIT: HYD VEH (120MM MORTAR QUICK STOW SYSTEM)-----	2
MUNITION: NETWORK COMMAND (SPIDER)-----	1
SHELTER: NONEXPANDABLE S250-----	1
SAW CHAIN: GAS DRVN BAR FRAME-----	6
SMALL UNMANNED AIRCRAFT SYSTEM: (SUAS) RAVEN B-----	1

COMMUNICATION-ELECTRONICS EQUIPMENT

ANTENNA GROUP: OE-254-----	4
COMP SET DIGITAL: AN/JYK-128(V)3 (FBCB2 BFT APPLIQUE)-----	25
COMPUTER SET DIGITAL: AN/TYQ-109(V)1 (GCSS-A (V)1)-----	1
ENCRYPT/DECRYPT EQUIPMENT: TACLANE KG-175-----	1
FIRE CONTROL SYSTEM MORTAR: M150-----	2
FREQUENCY HOPPING MULTIPLEXER: TF-1456VRC (FHMUX)-----	3
INTERCONNECTING GROUP: ON-721/V-----	8
LIGHTWEIGHT MORTAR BALLISTIC COMPUTER M32-----	2
NAVIGATION SET: SATELLITE SIGNALS AN/PSN-13 (DAGR)-----	36
PROCESSOR GROUP SIGNAL DATA: (CAISI 2.0) OL-701A/TYQ-----	1
RADIAC SET: AN/VDR-2-----	6
RADIO SET: AN/VRC-90F-----	4
RADIO SET: AN/VRC-91F-----	14
RADIO SET: AN/VRC-92F-----	10
RADIO SET: AN/VRC-104(V)3 150 WATT IK: PRC-150 HF RADIO-----	7
RADIO SET: AN/PRC-119F-----	7
LAND MOBILE RADIO: (LMR)-----	42
RADIO SET: HAND-HELD RADIO-----	12
COMMS SYSTEM AN/MRC-149 (SOLDIER NETWORK EXTENSION)-----	1

NIGHT VISION/OBSERVATION EQUIPMENT

DRIVERS VISION ENHANCER: AN/VAS-5-----	25
MINI EYESAFE LASER IR OBS SET: AN/PVS-6 (MELIOS)-----	7
NIGHT VISION GOGGLES: AN/PVS-7B-----	18
NIGHT VISION DEVICE: AN/PSQ-20 (ENVG)-----	69
RANGE FINDER-TGT DESIGNATOR: LASER AN/PED-1 (LLDR)-----	4
SURVEILLANCE SYS: SCOUT LONG RANGE AN/TAS-8 (LRAS3)-----	13
LIGHT THERMAL WEAPONS SIGHT: AN/PAS-13(V1)-----	9
MEDIUM THERMAL WEAPONS SIGHT: AN/PAS-13(V2)-----	13
HEAVY THERMAL WEAPONS SIGHT: AN/PAS-13(V3)-----	17
TARGET ACQUISITION SYSTEM: TOW IMPROVED ITAS M41-----	6
LASER TARGET LOCATOR SYSTEM (LTLS)-----	6

MOTORIZED CAV TROOP, CAV SQDN (IBCT)

DISMOUNTED CAVALRY TROOP, CAV SQDN, IBCT

07257R000
4/075// 79

TROOP HEADQUARTERS PARA 01

60MM MORTAR SECTION PARA 02

SNIPER SQUAD PARA 03

SCOUT PLT HQ PARA 04

MISSION: To conduct reconnaissance and surveillance supporting the development of the brigade's situational awareness and knowledge in the area of operations.

FBCB2
x2 AN/PSC-5
DAGR
AN/VRC-92F
AN/VRC-90F
AN/PRC-119F
AN/PRC-104A
AN/UYK-128(V)3
ON/721/V
AN/MRC-149



CPT 11A00 CDR M4 M9
SGT 25C20 SR RTO M4
SPC 25C10 RTO M4
PFC 11B10 RTO M4

FBCB2
DAGR
AN/VRC-90F
AN/PRC-109(V)1
AN/UYK-128(V)3
OL-701A/TYQ
AN/PSC-5



1SG 11B5M 1SG M4
SGT 74D20 CBRN NCO M4
SGT 92Y20 SUPPLY NCO M4
SPC 92Y10 SUPPLY SP M4

FBCB2
DAGR
AN/VRC-90F
AN/PRC-119F
AN/UYK-128(V)3
x2 AN/PSC-5



1LT 11A00 XO M4
SPC 11B10 OPS ASST M4

x2 M32 LHMBC
x2 MORTAR 60MM
DAGR
AN/PRC-119F

SSG 11C30 SECT LDR M4 ILLUM NVG
SGT 11C20 SQD LDR M4 ILLUM NVG
SPC 11C10 GNR M4 ILLUM NVG
SPC 11C10 GNR M4 ILLUM NVG
PFC 11C10 ASST GNR M4 ILLUM NVG
PFC 11C10 ASST GNR M4 ILLUM NVG

X2 ILLUM
X2 STORM
X2 NVG
X2 M107 .50CALSNIPER RIFLE
X2 M110 SNIPER RIFLE
X2 M24 7.62SNIPER RIFLE
2X AN/PVS-29
2X LWTS
2X AN/PVS-10
2X HWTS
AN/PRC-119F

SGT 11B20 SR SNIPER M4 M9
SPC 11B10 SNIPER M4 M9
SPC 11B10 SNIPER M4 M9

x2

SSG 11B30 SQD LDR M4 M9

FBCB2
X2 AN/PSC-5
DAGR
AN/VRC-90F
AN/VRC-92F
AN/PRC-104A
AN/UYK-128(V)3
ON-721/V
AN/MRC-149



1LT 11A00 PLT LDR M4 ILLUM
ENVG ANPRC-119F AN/PRC-148
SFC 11B4G PLT SGT M4 ILLUM
ENVG
PFC 11B10 RTO M4 ILLUM NVG
PFC 11B10 RTO M4 ILLUM ENVG

SCOUT SECTION PARA 05

SCOUT SECTION PARA 06

SCOUT PLT HQ PARA 07

SCOUT SECTION PARA 08

SCOUT SECTION PARA 09

JAVELIN
2X M249
x2 DAGR
x2 AN/PRC-104A
x2 AN/PRC-119F
x2 AN/PRC-148(V)4
SHOTGUN
2X MWTS

SSG 11B30 TM LDR M4 M9 ILLUM ENVG
AN/PRC-148 LMR
SGT 11B20 A TM LDR M4 M9 ILLUM ENVG
AN/PRC-148 LMR
SPC 11B10 SCOUT M4 ILLUM ENVG
LWTS LMR
SPC 11B10 SCOUT M4 ILLUM ENVG
LWTS LMR
SPC 11B10 SCOUT M4 ILLUM ENVG
LWTS LMR
SPC 11B10 SCOUT M4 ILLUM ENVG
LWTS LMR
PFC 11B10 RATELO M4 ILLUM ENVG
LWTS LMR
PFC 11B10 RATELO M4 ILLUM ENVG
LWTS LMR

x2

JAVELIN
2X M249
DAGR
AN/PRC-104A
AN/PRC-119F
AN/PRC-148(V)4
SHOTGUN
2X MWTS

SSG 11B30 TM LDR M4 M9 ILLUM ENVG
AN/PRC-148 LMR
SGT 11B20 A TM LDR M4 M9 ILLUM ENVG
AN/PRC-148 LMR
SPC 11B10 SCOUT M4 ILLUM ENVG
LWTS LMR
SPC 11B10 SCOUT M4 ILLUM ENVG
LWTS LMR
SPC 11B10 SCOUT M4 ILLUM ENVG
LWTS LMR
SPC 11B10 SCOUT M4 ILLUM ENVG
LWTS LMR
PFC 11B10 RATELO M4 ILLUM ENVG
LWTS LMR
PFC 11B10 RATELO M4 ILLUM ENVG
LWTS LMR

FBCB2
x2 DAGR
AN/VRC-90F
AN/PRC-119F
AN/UYK-128(V)3
ON-71/V
AN/PED-1 (LLDR)
HAND HELD RADIO



1LT 11A00 PLT LDR M4 ILLUM ENVG
ANPRC-119F AN/PRC-148
SFC 11B4G PLT SGT M4 ILLUM ENVG
PFC 11B10 RTO M4 ILLUM NVG
PFC 11B10 RTO M4 ILLUM ENVG

JAVELIN
2X M249
x2 DAGR
x2 AN/PRC-104A
x2 AN/PRC-119F
x2 AN/PRC-148(V)4
SHOTGUN
2X MWTS

SSG 11B30 TM LDR M4 M9 ILLUM ENVG
AN/PRC-148 LMR
SGT 11B20 A TM LDR M4 M9 ILLUM ENVG
AN/PRC-148 LMR
SPC 11B10 SCOUT M4 ILLUM ENVG
LWTS LMR
SPC 11B10 SCOUT M4 ILLUM ENVG
LWTS LMR
SPC 11B10 SCOUT M4 ILLUM ENVG
LWTS LMR
PFC 11B10 SCOUT M4 ILLUM ENVG
LWTS LMR
PFC 11B10 SCOUT M4 ILLUM ENVG
LWTS LMR
SPC 11B10 SCOUT M4 ILLUM ENVG
LWTS LMR

x2

JAVELIN
2X M249
DAGR
AN/PRC-104A
AN/PRC-119F
AN/PRC-148(V)4
SHOTGUN
2X MWTS

SSG 11B30 TM LDR M4 M9 ILLUM ENVG
AN/PRC-148 LMR
SGT 11B20 A TM LDR M4 M9 ILLUM ENVG
AN/PRC-148 LMR
SPC 11B10 SCOUT M4 ILLUM ENVG
LWTS LMR
SPC 11B10 SCOUT M4 ILLUM ENVG
LWTS LMR
SPC 11B10 SCOUT M4 ILLUM ENVG
LWTS LMR
PFC 11B10 SCOUT M4 ILLUM ENVG
LWTS LMR
PFC 11B10 SCOUT M4 ILLUM ENVG
LWTS LMR
SPC 11B10 SCOUT M4 ILLUM ENVG
LWTS LMR

EQUIPMENT SUMMARY

WEAPONS

C60750	COMMAND LAUNCH UNIT: (JAVELIN) 13305405-119	6
L69080	LAUNCHER GRENADE: M320A1	18
M09009	MACHINE GUN 5.56 MILLIMETER: M249	12
M39263	MACHINE GUN: LIGHT 5.56MM M249	2
M67939	MORTAR 60 MILLIMETER: ON MOUNT M170 CANNON M225 W/E	2
P98152	PISTOL 9MM AUTOMATIC: M9	20
R45351	RIFLE SNIPER .50 CALIBER: M107	2
R45601	RIFLE SNIPER: M110	2
R97234	RIFLE 5 56 MILLIMETER: M4	79
S40541	SHOTGUN: 12 GAGE	10
Z00686	MACHINE GUN: CALIBER .50	1

VEHICLES, TRAILERS AND TRLR MTD SYSTEMS

T37588	TRUCK UTILITY EXPANDED CAPACITY ENHANCED: M1152A1	1
T41135	TRUCK CARGO: MTV W/E W/W	1
T56383	TRUCK UTILITY EXPANDED CAPACITY ENHANCED 4X4: M1165A1	3
T95992	LIGHT TACTICAL TRAILER: 3/4 TON	4
Z36683	TRAILER TANK WATER (CAMEL): 800 GAL 5 TON W/E	1

NIGHT VISION/OBSERVATION

J03261	ILLUMINATOR: INFRARED	79
J68653	ILLUMINATOR INTEGRATED: SMALL ARMS STORM MLRF	2
N05050	NIGHT VISION SIGHT SET: AN/UAS-11	2
N05482	NIGHT VISION: GOGGLE	17
N07848	NIGHT VISION DEVICE: ENVG	62
S60342	SIGHT NIGHT VISION (SNS): AN/PVS-29	2
S60356	SIGHT: THERMAL AN/PAS-13B(V)1	40
S90433	SIGHT: NIGHT VISION SNIPERSCOPE AN/PVS-10	2
S90535	MEDIUM WEAPON THERMAL SIGHT (MWTS): AN/PAS-13(V)2	14
S90603	HEAVY WEAPON THERMAL SIGHT (HWTS): AN/PAS-13(V)3	5

COMMUNICATIONS AND ELECTRONICS

C18378	COMPUTER SET: AN/UYSK-128(V)3	5
C27707	COMPUTER SYSTEM: DIGITAL AN/TYQ-109(V)1	1
J54771	INTERCONNECT GROUP: ON-721/V	3
N96248	NAVIGATION SET: SATELLITE SIGNALS AN/PSN-13	28
P99881	PROCESSOR GROUP SIG DATA: (CAISI 2.0) OL-701A/TYQ	1
R45543	RADIO SET: AN/VRC-92F(C)	1
R55200	RADIO SET: AN/PRC-104A	7
R57606	RADIO SET: AN/PSC-5	5
R60282	RANGE FINDER-TARGET DESIGNATOR: LASER AN/PED-1	2
R68044	RADIO SET: AN/VRC-90F(C)	5
R83141	RADIO SET: AN/PRC-119F(C)	25
T40405	TAPE READER GENERAL PURPOSE: KOI-18/TSEC	1
Z00384	COMPUTER SYSTEM DIGITAL: AN/PYQ-10(C)	33
Z00862	LAND MOBILE RADIO: (LMR)	42
Z01320	RADIO SET: AN/PRC-148 (V) 4 URBAN JEM	20

MISC EQUIPMENT

B57077	BATTLEFIELD ANTI-INTRUSION SYSTE: AN/PRS-9	6
B57327	BATTLEFIELD ANTI-INTRUSION SYSTEM (BAIS): AN/GSR-9(V)1	1
B84293	BOAT LANDING CRAFT INFLATABLE: 7 PERSON	9
B85867	BATTLEFIELD ANTI-INTRUSION SYS (BAIS): AN/GSR-10(V) 1	2
C05701	MONITOR CHEMICAL AGENT:	6
F35965	FCS CLASS I UAV: SYSTEM	2
G18358	GEN SET: DED SKID MTD 3KW 60HZ	1
J00697	JOINT CHMCL AGENT: DETECTOR	9
M12986	MASK CHEMICL BIOLOGICL JOINT SERVICE GENERAL PURPOSE: FIELD M50	80
M32043	M32 LIGHTWEIGHT HAND-HELD: MORTAR BALLISTIC COMPUTER (LHMBC)	2
M92387	MUNITION: NETWORK COMMAND (SPIDER)	1
P34402	OUTBOARD MOTOR GASOLINE: 35 HP SILENCED WATERPROOFED	9
R20684	RADIAC SET: AN/VDR-2	3
R30925	RADIAC SET: AN/PDR-75	1
R31061	RADIAC SET: AN/UDR-13	15
S83835	SMALL UNMANNED AIRCRAFT SYSTEM (SUAS): RAVEN B (MIP)	1
Z00441	SMALL UNMANNED: GROUND VEHICLE (SUGV)	2

HHC, INFANTRY BATTALION, IBCT

07416R000
27/0/203// 230

COMMAND GROUP PARA 01

CURRENT OPS – INTEL / S2 PARA 02

CURRENT OPS – OPS/S3 PARA 03

MISSION: To provide command, control, and supervision of the tactical operations of the Infantry Battalion and attached units; unit administration and logistical support for the battalion staff sections; and indirect mortar fire support, reconnaissance, and administrative and medical support to organic and attached units.

FBCB2 x2 DAGR
ON-721/V AN/VAS-5
AN/MRC-150
AN/VRC-92F
AN/VRC-104(V)3
x2 AN/PRC-119F
AN/UJK-128(V)3



LTC 11A00 CDR M4 M9
PFC 11B10 DRIVER M4
PFC 11B10 RATELO M4

FBCB2 x2 DAGR
AN/VRC-92F
AN/PRC-119F
AN/VRC-104(V)3
AN/UJK-128(V)3



MAJ 11A00 XO M4 M9
CSM 11Z60 CSM M4 M9
PFC 25U10 SIG SPT SYS SP M4

FBCB2 x2 DAGR
ON-721/V AN/VRC-92F
x2 AN/TYQ-93
x2 AN/PRC-119F
AN/VRC-104(V)3
AN/UJK-128(V)3



CPT 35D00 S2 M4 ILLUM NVG AN/PRC-119F
1LT 35D00 ASST S2 M4 ILLUM NVG
SFC 35F40 SR INTEL SGT M4 ILLUM NVG
X5 SGT 35F20 INTEL ANLST M4 ILLUM NVG
X6 SPC 35F10 INTEL ANLST M4 ILLUM NVG
PFC 35F10 INTEL ANLST M4 ILLUM NVG

FBCB2 x2 DAGR
AN/VAS-5
AN/VRC-92F
AN/PRC-119F
AN/MRC-149
AN/VRC-104(V)3
AN/UJK-128(V)3



MAJ 11A00 S3 M4 M9
SGT 11B20 ASST OPS SGT M4
CPT 11A00 PLANS OFF M4
SPC 11B10 OPS ASST M4

FBCB2 DAGR
ON-721/V AN/VAS-5
AN/VRC-92F
AN/VRC-104(V)3
AN/UJK-128(V)3
x3 AN/TYQ-137B(V)3



MED PWR PLANT

FBCB2 DAGR
x13 NVG
AN/VAS-5
AN/VRC-92F
AN/UJK-128(V)3

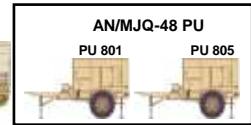

AN/MJQ-48 PU

PU 801 PU 805

CPT 11A00 ASST S3 M4
CPT 11A00 PLANS OFF M4
1LT 74A00 CBRN OFF M4
SGM 11Z60 OPS SGT M4
SFC 11B40 ASST OPS SGT M4
SSG 74D30 CBRN NCO M4
SSG 12B30 RECON SGT M4

SFC 11B40 ASST OPS SGT M4
SSG 11B30 ASST OPS SGT M4
SGT 11B20 ASST OPS SGT M4
SPC 11B10 OPS ASST M4
SPC 74D10 CBRN DECON SP M4
PFC 74D10 CBRN SPC M4

CURRENT OPS – FIRE SPT PARA 04

CURRENT OPS – FIRE SPT/TACP PARA 05

CURRENT OPS – LNO PARA 06

SUSTAINMENT – S1 PARA 07

FBCB2
AN/VAS-5
x2 DAGR
X6 NGV
AN/VRC-92F
AN/VRC-104(V)3
AN/GYK-57
FHMUX
AN/PSC-5



SSG 29E30 EW SGT M4 ILLUM
SGT 29E20 EW SGT M4 ILLUM

FBCB2
AN/VAS-4
DAGR
X4 NGV
AN/VRC-92F
AN/UJK-128(V)3
AN/GYK-48(V)1



ALL MOVED TO FIRES BN

CPT 13A00 EFFECT COORD M4 ILLUM
SFC 13F40 EFFECTS NCO M4 ILLUM
1LT 13A00 ASST EFFECTS COORD M4 ILLUM
SFC 13F40 TGT NCO M4 ILLUM
SGT 13F20 FIRE SPT SGT M4 ILLUM
SPC 13F10 FIRE SPT SPC M4 ILLUM
SPC 13F10 FIRE SPT SP M4 ILLUM

AN/PED-1 (LLDR)
AN/GYK-56

*CPT 01A00 USAF STAFF OFF M4 ILLUM NVG
SSG 00D30 USAF STAFF NCO M4 ILLUM NVG
SPC 00D10 USAF STAFF ENLISTED M4 ILLUM NVG

*USAF PERSONNEL NOT ASSIGNED TO UNIT

FBCB2
AN/VAS-5
DAGR
AN/VRC-90F
AN/UJK-128(V)3



1LT 11A00 LNO M4 ILLUM NVG
SPC 11B10 LIAISON ASST M4 ILLUM NVG

X9 NVG
AN/VAS-5
AN/VRC-90F
AN/UJK-128(V)3
OL-701A/TYQ
x5 AN/TYQ-116(V)3



CPT 42B00 S1 M4 ILLUM
SFC 42A40 SR HR SGT M4 ILLUM
SSG 42A30 HR SGT M4 ILLUM
SGT 42A20 HR SGT M4 ILLUM
SGT 27D20 PARALEGAL NCO M4
SPC 42A10 HR SP M4 ILLUM
SPC 42A10 HR SP M4 ILLUM
PFC 42A10 HR SP M4 ILLUM
PFC 42A10 HR SP M4 ILLUM

HHC, INFANTRY BATTALION, IBCT

SUSTAINMENT – S4 PARA 08

DAGR
X3 NVG
AN/VRC-92F
AN/UYK-128(V)3
X2 AN/TYQ-129(V)2
AN/TYQ-109(V)1
AN/PRC-119F
AN/UYQ-90(V)3
x2 KG-175
AN/TYX-1
OL-701A/TYQ
KOI-18/TSEC



CPT 11A00 S4 M4
PFC 92Y10 SUPPLY SP M4

FBCB2
AN/VAS-5
DAGR
AN/VRC-92F
AN/PRC-119F



SFC 92Y40 SR SUPPLY SGT M4
SGT 92Y20 SUPPLY SGT M4
SPC 92Y10 SUPPLY SP M4

SUSTAINMENT – UMT PARA 09

X2 NVG
FBCB2
AN/VAS-5
DAGR
AN/VRC-90F
AN/UYK-128(V)3



CPT 56A00 CHAPLAIN
SGT 56M20 CHAPLAIN ASST M4

SUSTAINMENT – C4 OPS/S6 PARA 10

FBCB2 X2 NVG
x2 DAGR AN/VAS-5
AN/VRC-90F



CPT 25A00 S6 M4
SPC 25U10 SIG SPT SYS SP M4

DAGR X3 NVG
AN/VRC-90F AN/GYK-62B
AN/TSR-8(GRT)
AN/UYK-128(V)3
AN/TYQ-137B(V)3



SFC 25U40 SEC CHIEF M4
SPC 25B10 LAN MGR M4
PFC 25B10 LAN MGR M4
SPC 25U10 SIG INFO SVC SP M4

FBCB2 X2 NVG
x2 DAGR AN/VAS-5
AN/VRC-90F



SPC 25N10 NODAL SYS OPR/MNT M4
PFC 25N10 NODAL SYS OPR/MNT M4

DAGR X2 NVG
AN/VAS-5 AN/VRC-90F

BCP (SWITCHING GP)
OM 87A/T



SGT SR XMSN SYS OPR-MNT M4
SPC 25Q10 XMSN SYS OPR MNT M4

DAGR X2 NVG
AN/VAS-5 AN/PYQ-12
AN/VRC-90F AN/TSQ-243
AN/TSQ-259 PU - 798



SSG 25E30 ELECT SPECT NCO M4
SPC 25U10 SIG SP SYS MAINT M4

RETRANSMISSION SECTION PARA 11

FBCB2
AN/VAS-5
DAGR
x2 AN/VRC-92F
AN/UYK-128(V)3
AN/MRC-149



SSG 25U30 RETRANS SUPV
M4 ILLUM NVG
SPC 25U10 RETRANS OPR
M4 ILLUM NVG
PFC 25U10 RETRANS OPR
M4 ILLUM NVG

FBCB2
AN/VAS-5
DAGR
x2 AN/VRC-92F
AN/UYK-128(V)3
AN/MRC-149



SGT 25U20 TEAM CHIEF
M4 ILLUM NVG
SPC 25U10 RETRANS OPR
M4 ILLUM NVG
PFC 25U10 RETRANS OPR
M4 ILLUM NVG

COMPANY HEADQUARTERS PARA 12

FBCB2 DAGR
KG-175
AN/VAS-5
AN/VRC-92F
AN/UYK-128(V)3



CPT 11A00 CDR M4 M9
SPC 25U10 SIG INFO SVC SP M4

FBCB2
x2 NVG
DAGR
AN/VRC-88F
AN/VRC-90F
AN/UYK-128(V)3
AN/TYQ-109(V)1
OL-701A/TYQ



SSG 92Y30 SUPPLY SGT M4
PFC 92Y10 SUPPLY SP M4

FBCB2 DAGR
AN/VAS-5
AN/VRC-88F
AN/VRC-90F
AN/UYK-128(V)3



1LT 11A XO M4
1SG 11Z5M 1SG M4

SCOUT PLT HQ PARA 13

FBCB2 2X ON-721/V
AN/VAS-5 AN/PED-1
DAGR SUGV
AN/VRC-92F 2X SHOTGUN



1LT 11A00 PLT LDR M4 ILLUM ENVG
DAGR AN/VRC-119F AN/PRC-148(V)4
PFC 11B10 RTO M4 ILLUM NVG

FBCB2
AN/VAS-5
DAGR
AN/VRC-92F



SFC 11B4G PLT SGT M4 ILLUM ENVG
DAGR AN/PRC-119F AN/PRC-148(V)1
PFC 11B10 SCOUT M4 ILLUM NVG

SCOUT SQUAD PARA 14

FBCB2 JAVELIN
AN/VAS-5 SHOTGUN
x2 DAGR
AN/VRC-91F
AN/UYK-128(V)3
AN/PRC-148
3 LMR



SSG 11B3G SQD LDR M4
SPC 11B10 SCOUT M4 ILLUM ENVG
LMR LWTS
PFC 11B10 M4 ILLUM NVG LMR LWTS

FBCB2 JAVELIN
AN/VAS-5 SHOTGUN
x2 DAGR
AN/VRC-90F
AN/UYK-128(V)3
AN/PRC-148
3 LMR



SGT 11B20 ASST SQD LDR M4
SPC 11B10 SCOUT M4 ILLUM ENVG
LMR LWTS
PFC 11B10 SCOUT M4 ILLUM NVG LWTS

x3

HHC, INFANTRY BATTALION, IBCT

MORTAR PLT HQ PARA 15

FBCB2
AN/VAS-5
x2 DAGR
AN/VRC-92F
AN/PRC-119F
AN/UYK-128(V)3
ON-721/V
LMR



1LT 11A00 PLT LDR M4
PFC 11C10 RATELO M4

FBCB2
AN/VAS-5
x2 DAGR
AN/VRC-92F
AN/PRC-119F
AN/UYK-128(V)3
LMR



SFC 11C40 PLT SGT M4
PFC 11C10 RATELO M4

MORTAR SECTION PARA 16

FBCB2
DAGR
AN/VRC-92F
X2 AN/PRC-119F
AN/UYL-128(V)3
M32 LHMBBC
M151 MFCS
LMR



SSG 11C30 SECTION LDR M4
SGT 11C20 FIRE DIR COMP M4
SGT 11C20 FIRE DIR COMP M4
PFC 11C10 RTO M4 ILLUM NVG

MORTAR SQUAD PARA 17

FBCB2
AN/VAS-5
DAGR
AN/VRC-92F
AN/UYK-128(V)3

M150 (D-MFCS)
81MM MORTAR
M32 LHMBBC
120MM MORTAR
M240B
MWTS



SGT 11C20 SQUAD LDR M4 ILLUM NVG
SPC 11C10 GUNNER M4 ILLUM NVG
PFC 11C10 ASST GNR M4 ILLUM NVG
PFC 11C10 AMMO BEARER M4 ILLUM NVG

x4

SNIPER SQUAD PARA 18

FBCB2
AN/VAS-5
x2 DAGR
AN/VRC-88F
AN/PRC-119F
AN/UYK-128(V)3



SSG 11B30 SQD LDR M4 M9 ILLUM NVG
AN/PRC-119F DAGR

DAGR
AN/PRC-119F

SGT 11B20 SR SNIPER M9 ILLUM NVG
AN/PVS-10 AN/PVS-29 AN/PRC-119F
M110 STORM

SPC 11B10 SNIPER M4 M9 ILLUM NVG
M107
SPC 11B10 SNIPER M4 M9 ILLUM NVG
LWTS

x3

MEDICAL PLT HQ PARA 19

FBCB2
AN/VAS-5
DAGR
AN/VRC-89F
AN/UYK-128(V)3

AN/TYQ-107(V)1
OL-701A/TYQ



MAJ 62B00 PLT LDR M4 (from MED CO)
1LT 70B67 MED OPS OFF M4 NVG
SFC 68W40 PLT SGT M4 NVG

MED TREATMENT SQUAD PARA 20

FBCB2
DAGR
AN/VRC-89F
AN/UYK-128(V)3
OL-701/TYQ



CPT 62B00 FIELD SURGEON M9
CPT 65D00 PHYSICIAN ASST M9
SSG 68W30 HLTH CARE SGT M4

FBCB2
DAGR
AN/VRC-89F
AN/TYQ-106(V)01
x4 AN/TYQ-105(V)01



CBPS

x2

SGT 68W20 HLTH CARE SGT M4
SGT 68W20 HLTH CARE SGT M4
SPC 68W10 HLTH CARE SP M4
PFC 68W10 HLTH CARE SP M4
PFC 68W10 HLTH CARE SP M4

AMBULANCE SQUAD (WHEELED) PARA 21

FBCB2
DAGR
X2 NVG
AN/VRC-90F
AN/UYK-128(V)3
x2 AN/TYQ-105(V)1



SGT 68W20 EMERG CARE SGT M4
SPC 68W10 AMB AIDE/DVR M4
PFC 68W10 AMB DVR M4

x4

FBCB2
DAGR
X2 NVG
AN/VRC-90F
AN/UYK-128(V)3
x2 AN/TYQ-105(V)1



SPC 68W10 AMB AIDE/DVR M4
SPC 68W10 AMB AIDE/DVR M4
PFC 68W10 AMB AIDE.DRV M4

COMBAT MEDIC SECT PARA 22

x15 AN/TYQ-105(V)1

SGT 68W20 EMERG CARE SGT M9

x3

PC 68W10 COMBT MEDIC M9 NVG

x12

MOVED TO FIRES BN

FIRES SUPPORT PLATOON PARA 11

FBCB2
AN/VAS-5
DAGR
x2 AN/VRC-91F
AN/PRC-119F
AN/PSG-14(V)1 LFED
AN/UYK-128(V)3
AN/PSC-5
AN/PED-1 (LLDR)
AN/PSG-10(V)



1LT 13A00 FSO M4
SSG 13F30 FIRE SPT SGT M4
SPC 13F10 FIRE SPT SP M4
PFC 13F10 RTO M4

x4

DAGR
AN/PSC-5
AN/PSG-10(V)

SGT 13F20 FO M4
PFC 13F10 RTO M4

x9

EQUIPMENT SUMMARY

WEAPONS

C60750	COMMAND LAUNCH UNIT: (JAVELIN) 13305405-119	6
L69080	LAUNCHER GRENADE: M320A1	15
M02114	MORTAR 81 MILLIMETER: M252	4
M92841	MACHINE GUN: 7.62MM M240B	4
P98152	PISTOL 9MM AUTOMATIC: M9	32
R45351	RIFLE SNIPER .50 CALIBER: M107	3
R45601	RIFLE SNIPER: M110	3
R97234	RIFLE 5 56 MILLIMETER: M4	198
S40541	SHOTGUN: 12 GAGE	8
Z00686	MACHINE GUN: CALIBER .50	3
Z01020	M120A1: GROUND MOUNTED MORTAR SYSTEM	4

VEHICLES, TRAILERS AND TRLR MTD SYSTEMS

C07506	CHEMICAL BIOLOGICAL PROTECTIVE SHELTER: (CBPS)	2
P63462	POWER PLANT: UTILITY (MEDIUM)	2
P63530	POWER PLANT: ELETRIC TRAILER MOUNTED	1
T37588	TRUCK UTILITY EXPANDED CAPACITY ENHANCED: M1152A1	9
T38844	TRUCK AMBULANCE: 4 LITTER ARMD 4X4 W/E (HMMVV)	8
T41135	TRUCK CARGO: MTV W/E W/W	1
T56383	TRUCK UTILITY EXPANDED CAPACITY ENHANCED 4X4: M1165A1	29
T60081	TRUCK CARGO: 4X4 LMTV W/E	6
T95555	TRAILER CARGO: MTV W/DROPSIDES M1095	1
T95924	TRAILER CARGO: HIGH MOBILITY 1-1/4 TON	4
T95992	LIGHT TACTICAL TRAILER: 3/4 TON	11
T96564	TRAILER FLAT BED: M1082 TRLR CARGO LMTV W/DROPSIDES	2
Z36683	TRAILER TANK WATER (CAMEL): 800 GAL 5 TON W/E	1

NIGHT VISION/OBSERVATION

D41659	DRIVERS ENHANCERS: AN/VAS-5	55
J03261	ILLUMINATOR: INFRARED	177
J68653	ILLUMINATOR INTEGRATED: SMALL ARMS STORM MLRF	3
M79678	MONOCULAR NIGHT VISION DEVICE: AN/PVS-14	18
N05482	NIGHT VISION: GOGGLE	177
N07848	NIGHT VISION DEVIC: ENVG	28
S60342	SIGHT NIGHT VISION (SNS): AN/PVS-29	3
S60356	SIGHT: THERMAL AN/PAS-13B(V)1	1
S60356	SIGHT: THERMAL AN/PAS-13B(V)1	21
S90433	SIGHT: NIGHT VISION SNIPERSCOPE AN/PVS-10	3
S90535	MEDIUM WEAPON THERMAL SIGHT (MWTS): AN/PAS-13(V)2	4
S90603	HEAVY WEAPON THERMAL SIGHT (HWTS): AN/PAS-13(V)3	3

COMMUNICATIONS AND ELECTRONICS

A35329	ALL SOURCE ANALYSIS SYSTEM: AN/TYQ-93	2
A35397	ALL SOURCE ANALYSIS SYSTEM: AN/TYQ-93(V)2	1
A79381	ANTENNA GROUP: OE-254()/GRC	26
C04819	COMTER SYS DIG: AN/PSG-14(V)1 LFED	4
C17936	COMPUTER SET: AN/GYG-1(V)1	1
C18277	COMPUTER SET: DIGITAL AN/TYQ-107(V)1	1
C18345	COMPUTER SET: DIGITAL AN/TYQ-106(V)1	3
C18378	COMPUTER SET: AN/UJK-128(V)3	50
C18641	COMPUTER SYST DIGITAL: AN/PYQ-12	1
C27435	COMPUTER SYSTEM: DIGITAL AN/TYQ-129(V)2	2
C27503	COMPUTER SYSTEM: DIGITAL AN/TYQ-105(V)1	39
C27707	COMPUTER SYSTEM: DIGITAL AN/TYQ-109(V)1	2
C27963	COMPUTER SYSTEM: DIGITAL	5
C78851	COMPUTER SYSTEM: DIGITAL AN/UJK-90(V)3	1
C79281	COMPUTER ST FIELD ARTILLERY GENERAL: AN/GYK-48(V)1	1
E08940	ENCRYPTION-DECRYPTION EQUIPMENT: TACLANE KG 175	2
F55682	FIRE CONTROL SYSTEM MORTAR: M150	4
J54771	INTERCONNECT GROUP: ON-721/V	6
M32043	M32 LIGHTWEIGHT HAND-HELD: MORTAR BALLISTIC COMPUTER (LHMBC)	5
M53619	MORTAR FIRE CONTROL SYSTEM: M151	1
N96248	NAVIGATION SET: SATELLITE SIGNALS AN/PSN-13	84
P99881	PROCESSOR GROUP SIG DATA: (CAISI 2.0) OL-701A/TYQ	5
R30658	RECEIVE SUITE: AN/TSR-8	1
R44999	RADIO SET: AN/VRC-89F(C)	4
R45543	RADIO SET: AN/VRC-92F(C)	24
R67330	RADIO SET: AN/VRC-88F(C)	4
R68044	RADIO SET: AN/VRC-90F(C)	21
R68146	RADIO SET: AN/VRC-91F(C)	12
R83141	RADIO SET: AN/PRC-119F(C)	22
R87139	RADIO ST: AN/VRC-104(V)3 150 WATT W/PRC-150 HF RADIO	6
R93169	RADIO TEST SET: AN/PRM-34()	5
T40405	TAPE READER GENERAL PURPOSE: KOI-18/TSEC	4
Z00058	COMPUTER SYSTEM DIGITAL: AN/PSG-10(V)	13
Z00129	COMPUTER SET FIELD ARTILLERY GENERAL: AN/GYK-56	1
Z00384	COMPUTER SYSTEM DIGITAL: AN/PYQ-10(C)	100
Z00512	COMPUTER SYSTEM DIGITAL: AN/GYK-50A (ISYSCON) (V)4	1
Z00564	BATTALION COMMAND POST(SWITCHING GROUP): OM-XXX	1
Z00862	LAND MOBILE RADIO: (LMR)	21
Z00930	COMMUNICATIONS SUBSYSTEM: AN/TSQ-259	1
Z01248	COMPUTER SET: DIGITAL AN/GYK-62B	1
Z01279	COMMON REMOTELY OPERATED WPN STATION (CROWS):	8
Z01320	RADIO SET: AN/PRC-148 (V) 4 URBAN JEM	8
Z39781	ARMY H RESURCES: WRKSTATION	5
C79000	COLLECTIVE PROTECTION EQUIPMENT: NBC SIMPLIFIED M20	4
D82404	DECONTAMINATING APPARATUS: PWR DRVN LT WT	2
G18358	GEN SET: DED SKID MTD 3KW 60HZ	4
G42170	GEN SET DED TM: 10KW 60HZ MTD ONM116A2 PU-798	1
J00697	JOINT CHMCL AGENT: DETECTOR	15
J01197	JOINT SERVICE: TRANSPORTABLE DECONTAMINATION	2
R20684	RADIAC SET: AN/VDR-2	24
R30925	RADIAC SET: AN/PDR-75	1
R31061	RADIAC SET: AN/UDR-13	31
Z00441	SMALL UNMANNED: GROUND VEHICLE (SUGV)	1

MISC EQUIPMENT

RIFLE COMPANY, INFANTRY BATTALION, IBCT

07217R000
5/0/126// 131

COMPANY HEADQUARTERS PARA 01

RIFLE PLT HQ PARA 02

RIFLE SQUAD PARA 03

WEAPONS SQUAD PARA 04

MISSION: To close with the enemy by means of fire and maneuver to destroy or capture, or to repel his assault by fire, close combat, and counterattack.

FBCB2
AN/VAS-5
DAGR
AN/VRC-92F
x2 AN/PRC-119F
AN/UYK-128(V)3
AN/MRC-149

KG-175
x2 CLASS I UAV
ON-721/V
x18 SHOTGUN
x2 M240B
RAVEN
MWTS
KOI-18



FBCB2
AN/VAS-5
x2 DAGR
AN/VRC-88F
OL-701A/TYQ
AN/VRC-104(V)3
x7 AN/PRC-119F
AN/UYK-128(V)3
AN/TYQ-109(V)1

CPT 11A00 CDR M4 N9
PFC 11B10 RTO M4
1LT 11A00 XO M4
SGT 11B20 SR RTO M4



1SG 11Z5M 1SG M4
SGT 25U20 FWD SIG SPT NCO M4
SSG 92Y30 SUPPLY SGT M4
SPC 92Y10 SUPPLY SP M4

AN/PRC-119F
DAGR
AN/PRC-148(V)4
SUGV

1LT 11A00 PLT LDR M4
SFC 11B4G PLT SGT M4
PFC 11B10 RTO M4

x2

DAGR
AN/PRC-148(V)4
x9 LMR

SSG 11B3G SQD LDR M4 ILLUM ENVG
AN/PRC-148(V)4 LMR HWTS DAGR
SGT 11B2G TM LDR M4 ILLUM ENVG LMR
SGT 11B20 TM LDR M4 ILLUM ENVG LMR
SPC 11B10 AUTO RIFLEMAN M249 ILLUM NVG
LMR MWTS
SPC 11B10 AUTO RIFLEMAN M249 ILLUM NVG
LMR MWTS
SPC 11B10 GRENADIER M320 ILLUM ENVG
LMR
SPC 11B10 GRENADIER M320 ILLUM ENVG
LMR
PFC 11B10 RIFLEMAN M4 ILLUM NVG
LMR LWTS
PFC 11B10 RIFLEMAN M4 ILLUM NVG
LMR LWTS

x6

x2 JAVELIN
x2 M240L
2X MWTS
DAGR
AN/PRC-148(V)4
x9 LMR

SSG 11B30 SQD LDR M4
SPC 11B10 MACHINE-GUNNER M9
SPC 11B10 MACHINE-GUNNER M9
PFC 11B10 ASST MACHINE-GUNNER M4
PFC 11B10 ASST MACHINE-GUNNER M4
PFC 11B10 AMMO HANDLER M4 ILLUM
PFC 11B10 AMMO HANDLER M4
SPC 11B10 AAT SP M4
SPC 11B10 AAT SP M4

x2

RIFLE PLT HQ PARA 05

RIFLE SQUAD PARA 06

RIFLE SQUAD PARA 07

WEAPONS SQUAD PARA 08

MORTAR SECTION PARA 09

DAGR
AN/PRC-119F
AN/PRC-148(V)4

1LT PLT LDR M4
SFC 11B40 PLT SGT M4
PFC 11B10 RTO M4

DAGR
AN/PRC-148(V)4
x9 LMR

SSG 11B30 SQD LDR M4 ILLUM ENVG
SGT 11B2G TM LDR M4 ILLUM ENVG LMR
SGT 11B20 TM LDR M4 ILLUM ENVG LMR
SPC 11B10 AUTO RIFLEMAN M249 ILLUM NVG
SPC 11B10 AUTO RIFLEMAN M249 ILLUM NVG
SPC 11B10 GRENADIER M320 ILLUM ENVG
SPC 11B10 GRENADIER M320 ILLUM ENVG
PFC 11B10 RIFLEMAN M4 ILLUM NVG
PFC 11B10 RIFLEMAN M4 ILLUM NVG

x2

DAGR
AN/PRC-148(V)4
x9 LMR

SSG 11B30 SQD LDR M4 ILLUM ENVG
AN/PRC-148(V)4 LMR HWTS DAGR
SGT 11B2G TM LDR M4 ILLUM ENVG LMR
SGT 11B20 TM LDR M4 ILLUM ENVG LMR
SPC 11B10 AUTO RIFLEMAN M249 ILLUM NVG
LMR MWTS
SPC 11B10 AUTO RIFLEMAN M249 ILLUM NVG
LMR MWTS
SPC 11B10 GRENADIER M320 ILLUM ENVG
LMR
SPC 11B10 GRENADIER M320 ILLUM ENVG
LMR
PFC 11B10 RIFLEMAN M4 ILLUM NVG
LMR LWTS
PFC 11B10 RIFLEMAN M4 ILLUM NVG
LMR LWTS

DAGR
AN/PRC-148(V)4
x9 LMR

SSG 11B30 SQD LDR M4 ILLUM ENVG
AN/PRC-148(V)4 LMR HWTS
SPC 11B10 MACHINE-GUNNER M9 ILLUM NVG LMR
SPC 11B10 MACHINE-GUNNER M9 ILLUM NVG LMR
PFC 11B10 ASST MACHINE-GUNNER M4 ILLUM NVG LMR
PFC 11B10 ASST MACHINE-GUNNER M4 ILLUM NVG LMR
PFC 11B10 AMMO HANDLER M4 ILLUM NVG LMR
PFC 11B10 AMMO HANDLER M4 ILLUM NVG LMR
SPC 11B10 AAT SP M4 ILLUM ENVG LMR
SPC 11B10 AAT SP M4 ILLUM ENVG LMR

DAGR
AN/PRC-119F
x2 M32 LHMBC

x2 LHMBC
x2 MORTAR 60MM

SSG 11C30 SECT LDR M4 ILLUM NVG
SGT 11C20 SQD LDR M4 ILLUM NVG
SPC 11C10 GUNNER M9 ILLUM NVG
SPC 11C10 GUNNER M9 ILLUM NVG
PFC 11C10 AMMO BEARER M4 ILLUM NVG
PFC 11C10 AMMO BEARER M4 ILLUM NVG

EQUIPMENT SUMMARY

WEAPONS			COMMUNICATIONS AND ELECTRONICS		
C60750	COMMAND LAUNCH UNIT: (JAVELIN) 13305405-119	6	B85867	BATTLEFIELD ANTI-INTRUSION SYS (BAIS): AN/GSR-10(V) 1	3
L69080	LAUNCHER GRENADE: M320A1	20	C18378	COMPUTER SET: AN/UYK-128(V)3	2
M09009	MACHINE GUN 5.56 MILLIMETER: M249	18	C27707	COMPUTER SYSTEM: DIGITAL AN/TYQ-109(V)1	1
M67939	MORTAR 60 MILLIMETER: ON MOUNT M170 CANNON M225 W/E	2	E08940	ENCRYPTION-DECRYPTION EQUIPMENT: TACLANE KG 175	1
M92454	MACHINE GUN 7.62 MILLIMETER: M240L	6	J54771	INTERCONNECT GROUP: ON-721/V	1
M92841	MACHINE GUN: 7.62MM M240B	2	M32043	M32 LTWEIGHT HAND-HELD: MORTAR BALLISTIC COMP (LHMBC)	2
P98152	PISTOL 9MM AUTOMATIC: M9	9	N96248	NAVIGATION SET: SATELLITE SIGNALS AN/PSN-13	23
R97234	RIFLE 5 56 MILLIMETER: M4	105	P99881	PROCESSOR GROUP SIG DATA: (CAISI 2.0) OL-701A/TYQ	1
S40541	SHOTGUN: 12 GAGE	18	R45543	RADIO SET: AN/VRC-92F(C)	1
Z00686	MACHINE GUN: CALIBER .50	1	R67330	RADIO SET: AN/VRC-88F(C)	1
			R83141	RADIO SET: AN/PRC-119F(C)	15
			R87139	RADIO ST: AN/VRC-104(V)3 150 WATT W/PRC-150 HF RADIO	1
			R93169	RADIO TEST SET: AN/PRM-34()	1
			T40405	TAPE READER GENERAL PURPOSE: KOI-18/TSEC	1
			Z00384	COMPUTER SYSTEM DIGITAL: AN/PYQ-10(C)	13
			Z00862	LAND MOBILE RADIO: (LMR)	108
			Z01320	RADIO SET: AN/PRC-148 (V) 4 URBAN JEM	18
VEHICLES, TRAILERS AND TRLR MTD SYSTEMS					
T41135	TRUCK CARGO: MTV W/E W/W	1			
T56383	TRUCK UTILITY EXPANDED CAPACITY ENHANCED 4X4: M1165A1	1			
T95992	LIGHT TACTICAL TRAILER: 3/4 TON	1			
Z36683	TRAILER TANK WATER (CAMEL): 800 GAL 5 TON W/E	1			
NIGHT VISION/OBSERVATION			MISC EQUIPMENT		
D41659	DRIVERS ENHANCERS: AN/VAS-5	2	C05701	MONITOR CHEMICAL AGENT:	2
J03261	ILLUMINATOR: INFRARED	131			
M79678	MONOCULAR NIGHT VISION DEVICE: AN/PVS-14	40	J00697	JOINT CHMCL AGENT: DETECTOR	3
N05482	NIGHT VISION: GOGGLE	22	M12986	MASK CHEMICAL BIO JOINT SERVICE GENERAL PURPOSE: FIELD M50	131
N07848	NIGHT VISION DEVIC: ENVG	69	S83835	SMALL UNMANNED AIRCRAFT SYSTEM (SUAS): RAVEN B (MIP)	1
S60356	SIGHT: THERMAL AN/PAS-13B(V)1	18	Z00441	SMALL UNMANNED: GROUND VEHICLE (SUGV)	3
S90535	MEDIUM WEAPON THERMAL SIGHT (MWTS): AN/PAS-13(V)2	26			
S90603	HEAVY WEAPON THERMAL SIGHT (HWTS): AN/PAS-13(V)3	1			
S90603	HEAVY WEAPON THERMAL SIGHT (HWTS): AN/PAS-13(V)3	16			

WEAPONS COMPANY, INFANTRY BATTALION, IBCT

07218R000
6/01 73// 79

COMPANY HEADQUARTERS PARA 01

(x3) ASSAULT PLATOON PARA 02

MISSION: To Provide anti-armor fire support for the rifle companies and additional mobile firepower to close with the enemy by means of fire and maneuver to destroy or capture, or to repel his assault by fire, close combat, and counterattack.

FBCB2 DAGR X2 NVG
DAGR CLASS I UAV
X2 NVG ON-721/V
AN/VRC-92F x16 SHOTGUN
AN/UJK-128(V)3 KOI-18/TSEC



CPT 11A00 CDR M4 M9
PFC 11B10 RTO M4



1SG 11Z5M 1SG M4
SGT 25U20 FWD SIG SPT NCO M4

FBCB2 DAGR X2 NVG
AN/VRC-90F
AN/UJK-128(V)3
AN/TYQ-109(V)1
OL-701A/TYQ



1LT 11A00 XO M4
SGT 92Y20 SUPPLY NCO M4
SPC 92Y10 SUPPLY SP M4

FBCB2 DAGR X2 NVG
AN/VRC-91F
AN/UJK-128(V)3
x2 ON-721/V
x4 LMR



1LT 11A00 PLT LDR M4 ILLUM NVG
SPC 11B10 RIFLEMAN M4 ILLUM
SPC 11B10 RIFLEMAN M4 ILLUM
PFC 11B10 VEH DRIVER M4 ILLUM

FBCB2 DAGR X4 NGV
AN/VRC-91F
AN/UJK-128(V)3
x2 ON-721/V
x4 LMR



SFC 11B4G PLT SGT M4
SPC 11B10 GNR M9
PFC 11B10 ASST GNR M4
SPC 11B10 RIFLEMAN M4

FBCB2 DAGR AN/VRC-91F
AN/UJK-128(V)3
x2 LMR



SSG 11B3G SECT LDR M4 ILLUM
SPC 11B10 GNR M9 NVG LMR
SPC 11B10 RIFLEMAN M4 ILLUM
PFC 11B10 A GNR M4 ILLUM NVG LMR

FBCB2 DAGR AN/VRC-91F
AN/UJK-128(V)3
x2 LMR
x6 ITAS



X2

SGT 11B2G SQD LDR M4 ILLUM
SGT 11B2G SQD LDR M4 ILLUM
SPC 11B10 GNR M4 ILLUM
SPC 11B10 GNR M4 ILLUM

x3

EQUIPMENT SUMMARY

ASSAULT PLATOON PARA 03

FBCB2 DAGR AN/VRC-91F
AN/UJK-128(V)3
x2 ON-721/V
x4 LMR



1LT 11A00 PLT LDR M4 ILLUM NVG
SPC 11B10 GUNNER M4
SPC 11B10 RIFLEMAN M4
PFC 11B10 ASST GUNNER M4 ILLUM NVG

FBCB2 DAGR AN/VRC-91F
AN/UJK-128(V)3
ON-721/V x4 LMR



SFC 11B4G PLT SGT M4 ILLUM NVG
SPC 11B10 RIFLEMAN M4
PFC 11B10 DRIVER M4 ILLUM NVG
PFC 11B10 VEH DRIVER M4

FBCB2 DAGR AN/VRC-91F
AN/UJK-128(V)3
x2 LMR ITAS



SSG 11B3G SECT LDR M4 ILLUM
SPC 11B10 GNR M9 NVG
SPC 11B10 RIFLEMAN M4 ILLUM NVG
PFC 11B10 A GNR M4 ILLUM

FBCB2 DAGR AN/VRC-91F
AN/UJK-128(V)3
x2 LMR x2 ITAS



x2

SGT 11B2G SQD LDR M4 ILLUM
SGT 11B2G SQD LDR M4 ILLUM
SPC 11B10 GUNNER M9 NVG
SPC 11B10 GUNNER M9 NVG
PFC 11B10 ASST GNR M4 ILLUM NVG
PFC 11B10 ASST GNR M4 ILLUM NVG

WEAPONS

L69080	LAUNCHER GRENADE: M320A1	16
M92362	MACHINE GUN GRENADE 40MM: MK19 MOD III	8
M92454	MACHINE GUN 7.62 MILLIMETER: M240L	8
P98152	PISTOL 9MM AUTOMATIC: M9	10
R97234	RIFLE 5 56 MILLIMETER: M4	52
S40541	SHOTGUN: 12 GAGE	16
T24690	TARGET ACQUISITION SYSTEM: TOW IMPROVED ITAS M41	8
Z00686	MACHINE GUN: CALIBER .50	9
	VEHICLES, TRAILERS AND TRLR MTD SYSTEMS	
T34704	TRUCK UTIL: ECV ARMAMENT CARR W/IAP ARMOR READY M1151A1	8
T34840	TRUCK UTILITY ECV TOW/ITAS CARRIER WITH IAP ARMOR READY: M1167	8
T37588	TRUCK UTILITY EXPANDED CAPACITY ENHANCED: M1152A1	1
T41135	TRUCK CARGO: MTW W/E W/W	1
T56383	TRUCK UTIL EXPANDED CAP ENHANCED 4X4: M1165A1	5
T95992	LIGHT TACTICAL TRAILER: 3/4 TON	5
Z36683	TRAILER TANK WATER (CAMEL): 800 GAL 5 TON W/E NIGHT VISION/OBSERVATION	1
D41659	DRIVERS ENHANCERS: AN/VAS-5	23
J03261	ILLUMINATOR: INFRARED	79
M79678	MONOCULAR NIGHT VISION DEVICE: AN/PVS-14	17
N05482	NIGHT VISION: GOGGLE	62
S60356	SIGHT: THERMAL AN/PAS-13B(V)1	16
S90535	MEDIUM WEAPON THERMAL SIGHT (MWTS): AN/PAS-13(V)2	8
S90603	HEAVY WEAPON THERMAL SIGHT (HWTS): AN/PAS-13(V)3	17
S90603	HEAVY WEAPON THERMAL SIGHT (HWTS): AN/PAS-13(V)3	1

COMMUNICATIONS AND ELECTRONICS

C18378	COMPUTER SET: AN/UJK-128(V)3	23
C27707	COMPUTER SYSTEM: DIGITAL AN/TYQ-109(V)1	1
E08940	ENCRYPTION-DECRYPTION EQUIP: TACLANE KG 175	1
J54771	INTERCONNECT GROUP: ON-721/V	9
N96248	NAVIGATION SET: SATELLITE SIGNALS AN/PSN-13	23
P99881	PROCESSOR GROUP SIG DATA: (CAISI 2.0) OL-701A/TYQ	1
R45543	RADIO SET: AN/VRC-92F(C)	2
R68044	RADIO SET: AN/VRC-90F(C)	1
R68146	RADIO SET: AN/VRC-91F(C)	20
T40405	TAPE READER GENERAL PURPOSE: KOI-18/TSEC	1
Z00384	COMPUTER SYSTEM DIGITAL: AN/PYQ-10(C)	43
Z00862	LAND MOBILE RADIO: (LMR)	56
	MISC EQUIPMENT	
B57077	BATTLEFIELD ANTI-INTRUSION SYSTE: AN/PRS-9	1
B57327	BTLEFLD ANTH-INTRUSION SYS (BAIS): AN/GSR-9(V)1	1
G18358	GEN SET: DED SKID MTD 3KW 60HZ	1
J00697	JOINT CHMCL AGENT: DETECTOR	5
M12986	MASK CHEMICL BIOLOGICL JOINT SERVICE GENERAL PURPOSE: FIELD M50	79
M92387	MUNITION: NETWORK COMMAND (SPIDER)	1
R20684	RADIAC SET: AN/VDR-2	5
R30925	RADIAC SET: AN/PDR-75	1
R31061	RADIAC SET: AN/UDR-13	5
S83835	SMALL UNMANNED AIRCRAFT SYS (SUAS): RAVEN B (MIP)	1
Z01279	COMMON REMOTELY OPER WPN STATION (CROWS):	9

HHB, FIRES BN, IBCT

06126R000
13/172// 86

MISSION: To provide command, control and administrative supervision and service support of organic and attached Field Artillery units.

COMMAND SECTION PARA 01

FBCB2 ON-721/V
2X NVG
DAGR
AN/VRC-92F
AN/VRC-104(V)3



LTC 13A00 CDR M4 M9
AN/GYK-48(V)1
PFC 13D10 DRIVER M4

FBCB2
2X NVG
DAGR
AN/VRC-92F



MAJ 13A00 EXEC OFF M4 M9
CSM 00Z50 CSM M4 M9
SPC 13D10 FATDS SP M4

CURRENT OPS-INTEL/S2 PARA 2

FBCB2 ANTYQ-93
2X NVG M240B
DAGR MWTS
AN/VRC-92F AN/GYK-56



CPT 13A00 S2 M4
MSG 13Z50 INTEL SGT M4
SSG 35F30 INTEL SGT M4
SGT 35F20 INTEL ANLST M4

CURRENT OPS - OPS/S3 PARA 03

FBCB2
2X NVG
DAGR
AN/VRC-92F
AN/PSC-5
AN/PRC-119F



MAJ 13A00 S3 M4 M9
AN/GYK-48(V)1
SSG 29E30 EW SGT M4
SPC 74D10 CBRN SP M4
SPC 13D10 FATDS SP M4

FBCB2
DAGR
X2 NVG
AN/VRC-92F
AN/TYQ-129(V)3
AN/TYQ-137B(V)3



WO2 740A0 CBRN WARRANT M4
SGT 74D20 CBRN NCO M4

AN/MJQ-48 PU
PU 805 PU 805

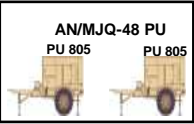

2 AN/VRC-92F
AN/GYK-57
AN/TYQ-129(V)2
2 AN/TYQ-137B(V)3
AN/TSQ-243
FHMUX
DAGR



MED PWR PLANT

CPT 13A00 OPS OFF M4
SFC 13B40 OPS SGT M4
SGT 28E20 EW SGT M4
SPC 13D10 FATDS SP M4

AN/VRC-92F
AN/PRC-119F
DAGR



MSG 13Z50 OPS SGT M4
SSG 74D30 CBRN NCO M4
SSG 13T30 CH SURVEYOR M4
PFC 13D10 FATDS SP M4

CURRENT OPS - FDC PARA 04

FBCB2 AN/GYG-1(V)3
2X NVG MK-19 M240B
DAGR MWTS HWTS
AN/VRC-92F KOI-18/TSEC



CPT 13A00 FIRE DIR OFF M4
SGT 13D20 FIRE CONT SGT M4
SPC 13D10 FATDS SP M4

SFC 13D40 CH FIRE CONT SGT M4
PFC 13D10 FATDS SP M4

AN/PYQ-1
2X NVG
DAGR
AN/VRC-90F
HWTS
.50 CAL



SSG 13D30 FIRE CONT SGT M4
SPC 13D10 FATDS SP M4
SPC 13D10 FATDS SP M4
PFC 13D10 FATDS SP M4

SUSTAINMENT-S1 PARA 05

FBCB2 M240B MWTS
2X NVG OL-701A/TYQ
DAGR AN/VRC-92F
AN/VRC-90F HWTS .50 CAL
4X HR WORKSTATION



CPT 42B00 S1 M4
SFC 42A40 SFC SR HR SGT M4
SSG 42A30 HR SGT M4
SGT 42A20 HR SGT M4
SPC 27D10 PARALEGAL M4
SPC 42A10 HR SP M4
X2 PFC 42A10 HR SP M4

SUSTAINMENT-S4 PARA 06

FBCB2 2X NVG
DAGR
AN/VRC-92F



MED PWR PLANT

CPT 13A00 S4 M4
SGT 92Y20 SUPPLY NCO M4

AN/TYQ-129(V)2
AN/TYQ-109(V)1
COMPUTER SYS DIGITAL
AN/UYQ-90(V)3
GLPS MK-19
M240B
OL-701A/TYQ
MWTS 2X HWTS



2X NVG
DAGR
AN/VRC-92F

SFC 92Y40 SR SUPPLY SGT M4
SPC 92Y10 SUPPLY SP M4

SUSTAINMENT - UMT PARA 7

FBCB2
2X NVG
DAGR
AN/VRC-90F



CPT 56A00 CHAPLAIN
SPC 56M10 CHAPLAIN ASST M4

SUSTAINMENT-C4 OPS/S6 PARA 08

FBCB2 M240B
2X NVG MWTS
DAGR KOI-18/TSEC
AN/VRC-92F AN/GYK-62B



CPT 25A00 S6 M4
PFC 25U10 SIG SPT SYS SP M4
SFC 25U40 SECT CH M4
SPC 25U10 SIG INFO SVC SP M4
PFC 25U10 SIG SPT SYS MAINT M4

NETWORK MMNT TEAM PARA 09

FBCB2 AN/TSQ-243
2X NVG
DAGR
AN/VRC-92F



SPC 25B10 LAN MGR M4
PFC 25B10 LAN MGR M4

NETWORK OPERATIONS PARA 10

FBCB2 BATTALION COMMAND
2X NVG POST SWITCHING GROUP
DAGR
AN/VRC-90F
AN/VRC-92F



SGT 25Q20 SR XMSN SYS OPR M4
PFC 25N10 NODAL SYS OPR/MNT M4

AN/PYQ-12
AN/TSR-8
AN/GYK-50A
AN/TSQ-259



SPC 25Q10 XMSN SYS OPR M4
SPC 25N10 NODAL SYS OPR/MNT M4

RETRANSMISSION TEAM PARA 11

FBCB2 M249
2X NVG MWTS
DAGR
AN/VRC-92F



SGT 25U20 TM CH M4
SPC 25U10 RETRANS OPR M4
PFC 25U10 RETRANS OPR M4

BATTERY HQ PARA 12

FBCB2
2X NVG
DAGR
AN/VRC-90F



CPT 13A00 CDR M4 M9
PFC 13D10 DRIVER M4
1SG 13Z5M 1SG M4

HHB, FIRES BN, IBCT

SUPPLY SECTION PARA 13

FBCB2 AN/TYQ-109(V)1
2X NVG HWTS
DAGR .50 CAL
AN/VRC-90F DECON



2X NVG
AN/VRC-90F



SSG 92Y30 SUPPLY SGT M4
SPC 92Y10 SUPPLY SP M4

MEDICAL PLT HQ PARA 14

AN/TYQ-107(V)1 OL-701A/TYQ
FBCB2
x2 NVG
DAGR
AN/VRC-89F



1LT 70B67 FLD MED ASST M4
SPC 68W40 PLT SGT M4

MEDICAL TREATMENT TEAM PARA 15

AN/TYQ-106(V)1 OL-701A/TYQ
FBCB2
x2 AN/TYQ-105(V)1
x2 NVG
DAGR
AN/VRC-90F



CPT 65D00 PHYSICIAN ASST M9
SPC 68W10 HEALTH CARE SP M4

FBCB2
AN/TYQ-105(V)1
x2 NVG
DAGR
AN/VRC-90F



SSG 68W30 HEALTH CARE SGT M4
PFC 68W10 HLTH CARE SP M4

AMBULANCE TEAM PARA 16

FBCB2
x2 AN/TYQ-105(V)1
AN/VAS-5
x2 NVG
DAGR
AN/VRC-90F



SGT 68W20 EMER CARE SGT M4
SPC 68W10 AMB AIDE/DRIVER M9
PFC 68W10 DRIVER M4

x3

COMBAT MEDIC SECT PARA 17

x4 AN/TYQ-105(V)1

SPC 68W10 COMBAT MEDIC M9 NVG

x6

EQUIPMENT SUMMARY

WEAPONS

M39263	MACHINE GUN: LIGHT 5.56MM M249	1
M92362	MACHINE GUN GRENADE 40MM: MK19 MOD III	2
M92841	MACHINE GUN: 7.62MM M240B	6
P98152	PISTOL 9MM AUTOMATIC: M9	10
R97234	RIFLE 5 56 MILLIMETER: M4	74
Z00686	MACHINE GUN: CALIBER .50	4
	LAUNCHER GRENADE: M320A1	4

VEHICLES, TRAILERS AND TRLR MTD SYSTEMS

G42170	GEN SET DED TM: 10KW 60HZ MTD ONM116A2 PU-798	1
P63462	POWER PLANT: UTILITY (MEDIUM)	2
P63530	POWER PLANT: ELETRIC TRAILER MOUNTED	1
T37588	TRUCK UTILITY EXPANDED CAPACITY ENHANCED: M1152A1	12
T38844	TRUCK AMBULANCE: 4 LITTER ARMD 4X4 W/E (HMMWV)	3
T56383	TRUCK UTILITY EXPANDED CAPACITY ENHANCED 4X4: M1165A1	9
T60081	TRUCK CARGO: 4X4 LMTV W/E	4
T61908	TRUCK CARGO: MTV W/E	1
T95924	TRAILER CARGO: HIGH MOBILITY 1-1/4 TON	9
T96564	TRAILER FLAT BED: M1082 TRLR CARGO LMTV W/DROPSIDES	4

NIGHT VISION/OBSERVATION

D41659	DRIVERS ENHANCERS: AN/VAS-5	3
N05482	NIGHT VISION: GOGGLE	62
S90535	MEDIUM WEAPON THERMAL SIGHT (MWTS): AN/PAS-13(V)2	7
S90603	HEAVY WEAPON THERMAL SIGHT (HWTS): AN/PAS-13(V)3	6

MISC EQUIPMENT

C05701	MONITOR CHEMICAL AGENT:	2
D03932	DETECTING SET: MINE AN/PSS-14	2
G18358	GEN SET: DED SKID MTD 3KW 60HZ	4
G42170	GEN SET DED TM: 10KW 60HZ MTD ONM116A2 PU-798	1
J00697	JOINT CHMCL AGENT: DETECTOR	6
J01197	JOINT SERVICE: TRANSPORTABLE DECONTAMINATION	2
M12986	MASK CHEMICAL BIOLOGICAL JOINT SERVICE GENERAL PURPOSE: FIELD M50	71
M13236	MASK CHEMICAL-BLGLCL JNT SRV GNL PRPSE: CMBT VHL CRWMN M51	9

COMMUNICATIONS AND ELECTRONICS

A35329	ALL SOURCE ANALYSIS SYSTEM: AN/TYQ-93	1
C17936	COMPUTER SET: AN/GYG-1(V)1	1
C18004	COMPUTER SET: AN/GYG-1(V)3	1
C18277	COMPUTER SET: DIGITAL AN/TYQ-107(V)1	1
C18345	COMPUTER SET: DIGITAL AN/TYQ-106(V)1	2
C18378	COMPUTER SET: AN/UYSK-128(V)3	25
C18641	COMPUTER SYST DIGITAL: AN/PYQ-12	1
C27435	COMPUTER SYSTEM: DIGITAL AN/TYQ-129(V)2	3
C27503	COMPUTER SYSTEM: DIGITAL AN/TYQ-105(V)1	14
C27707	COMPUTER SYSTEM: DIGITAL AN/TYQ-109(V)1	2
C27963	COMPUTER SYSEM: DIGITAL	5
C61665	COMMAND CENTER SYSTEM: AN/TSQ-243	2
C78851	COMPUTER SYSTEM: DIGITAL AN/UYSK-90(V)3	1
C79281	COMPUTER ST FIELD ARTILLERY GENERAL: AN/GYK-48(V)1	2
J54771	INTERCONNECT GROUP: ON-721/V	1
N96248	NAVIGATION SET: SATELLITE SIGNALS AN/PSN-13	27
P99881	PROCESSOR GROUP SIG DATA: (CAISI 2.0) OL-701A/TYQ	5
R30658	RECEIVE SUITE: AN/TSR-8	1
R44999	RADIO SET: AN/VRC-89F(C)	1
R45543	RADIO SET: AN/VRC-92F(C)	21
R57606	RADIO SET: AN/PSC-5	1
R68044	RADIO SET: AN/VRC-90F(C)	13
R83141	RADIO SET: AN/PRC-119F(C)	2
R87139	RADIO ST: AN/VRC-104(V)3 150 WATT W/PRC-150 HF RADIO	2
R93169	RADIO TEST SET: AN/PRM-34(I)	3
T40405	TAPE READER GENERAL PURPOSE: KOI-18/TSEC	3
Z00129	COMPUTER SET FIELD ARTILLERY GENERAL: AN/GYK-56	1
Z00384	COMPUTER SYSTEM DIGITAL: AN/PYQ-10(C)	26
Z00512	COMPUTER SYSTEM DIGITAL: AN/GYK-50A (ISYSCON) (V)4	1
Z00564	BATTALION COMMAND POST(SWITCHING GROUP): OM-XXX	1
Z00930	COMMUNICATIONS SUBSYSTEM: AN/TSQ-259	1
Z01248	COMPUTER SET: DIGITAL AN/GYK-62B	1
Z39781	ARMY H RESURCES: WRKSTATION	5

Fires Battalion, (3x6)

105T/155T

(CONSOLIDATED FOR TRAINING)

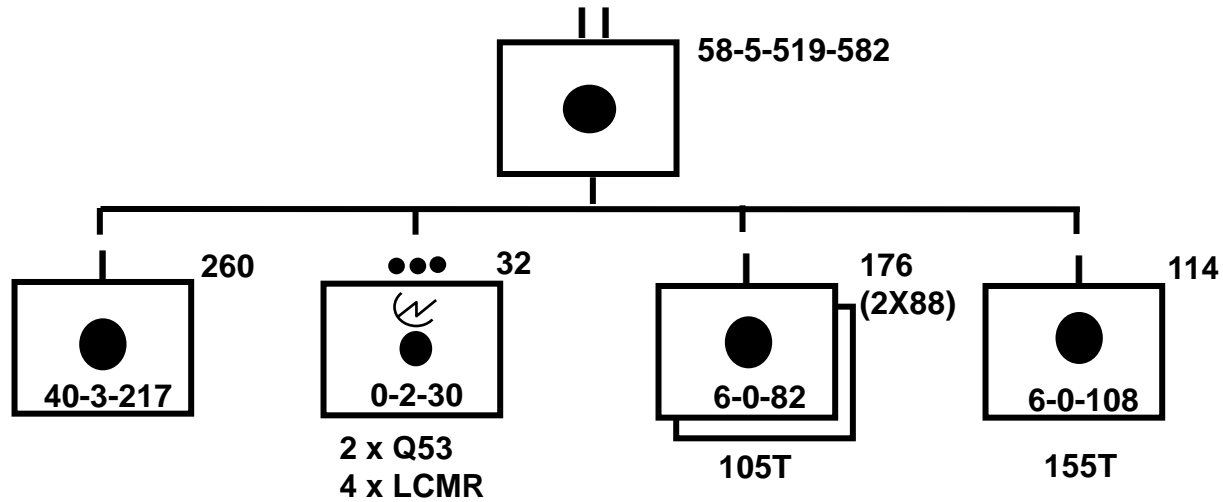

HHB, Fires Battalion

105T/155T

(CONSOLIDATED FOR TRAINING)

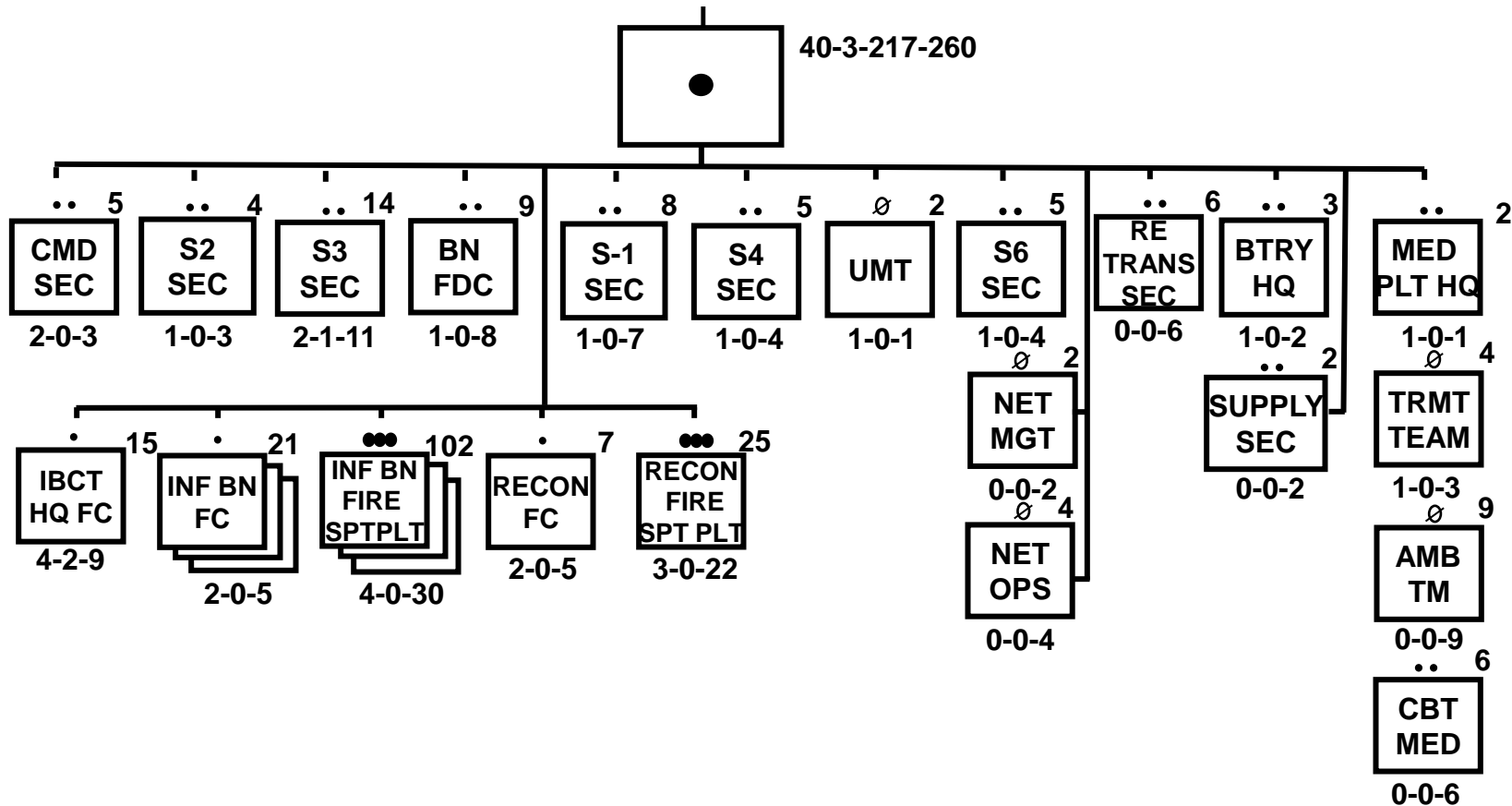

FIRES BATTERY(105T), FIRES BN, IBCT

MISSION.

**To destroy, neutralize or suppress
the enemy with cannon fire.**

FIRES BATTERY(105T), FIRES BN, IBCT

06237R000
6/082/ 88

BATTERY HEADQUARTERS PARA 01

FBCB2
x2 NVG
DAGR
AN/VRC-92F
RAVEN

ON-721/V



CPT 13A00 CDR M4 M9
1LT 13A00 EXEC OFF M4
PFC 13D10 DRIVER M4
1SG 13Z5M 1SG M4
SSG 25U30 FWD SIG SPT NCO M4
SPC 13D10 FATDS SPC M4
PFC 13D10 DRIVER M4

SUPPLY SECTION PARA 02

FBCB2
x2 NVG
DAGR
AN/VRC-90F

AN/TYQ-109(V)1
OL-701A/TYQ
HWTS
.50 CAL





SGT 92Y20 SUPPLY SGT M4
SPC 92Y10 SUPPLY SP M4

FIRING PLATOON HEADQUARTERS PARA 03

FBCB2
x2 NVG
DAGR
AN/VRC-92F
AN/VRC-88F

FBCB2
x2 NVG
DAGR
AN/VRC-92F

GLPS
MK-19
M240B
MWTS
HWTS

1LT 13A00 PLT LDR M4
SPC 13B10 FA WPNS EMCH M4

SFC 13B40 PLT SGT M4
SFC 13B40 GUNNERY SGT M4

FIRE DIRECTION CENTER PARA 04

FBCB2 x2 NVG DAGR
AN/VRC-92F AN/VRC-88F

X2 FBCB2
X2 NVG DAGR
AN/GYG-1(V)1
x2 AN/PYG-1
x2 AN/VRC-92F
AN/VRC-90F
AN/VRC-104(V)3



1LT 13A00 FIRE DIR OFF M4
SSG 13D30 FIRE CONT SGT M4
SSG 13D30 FIRE CONT SGT M4
SGT 13D20 FIRE CONT SGT M4
X2SPC 13D10 FATDS SP M4
PFC 13D10 FATDS SP M4

SPC 13D10 FATDS SP M4
PFC 13D10 FATDS SP M4

HOWITZER SECTION (105T) PARA 05

x2 NVG
DAGR
AN/VRC-90F

AN/PYG-2(V)1
M240B
NVG
MWTS

FBCB2
x2 NVG
DAGR
AN/VRC-91F



SSG 13B30 SECT CHIEF M4
SGT 13B20 GUNNER M4
SGT 13B20 AMMO CHIEF M4
SPC 13B10 ASST GNR M4

SPC 13B10 DRIVER M4
PFC 13B10 CANNONEER M4
PFC 13B10 CANNONEER M4

x6

AMMUNITION SECTION PARA 06

AN/UYQ-90(V)2
FBCB2
x2 NVG
DAGR
AN/VRC-90F

AN/UYQ-90(V)3
MK-19
HWTS

AN/UYQ-90(V)2
x2 NVG
DAGR
AN/VRC-90F

AN/UYQ-90(V)3
HWTS
.50 CAL



SSG 13B30 AMMO CH M4
SPC 13B10 AMMO SP M4
PFC 13B10 AMMO HANDLER M4

SGT 13B20 AMMO SGT M4
SPC 13B10 AMMO SP M4
PFC 13B10 AMMO HANDLER M4

x2

EQUIPMENT SUMMARY

WEAPONS

H57505	HOWITZER LIGHT TOWED: M119	8
L69080	LAUNCHER GRENADE: M320A1	14
M92362	MACHINE GUN GRENADE 40MM: MK19 MOD III	4
M92841	MACHINE GUN: 7.62MM M240B	12
P98152	PISTOL 9MM AUTOMATIC: M9	1
R97234	RIFLE 5 56 MILLIMETER: M4	94
Z00686	MACHINE GUN: CALIBER .50	3

VEHICLES, TRAILERS AND TRLR MTD SYSTEMS

T37588	TRUCK UTILITY EXPANDED CAPACITY ENHANCED: M1152A1	20
T41135	TRUCK CARGO: MTV W/E W/W	2
T41203	TRUCK CARGO: MTV W/MHE W/E	2
T56383	TRUCK UTILITY EXPANDED CAPACITY ENHANCED 4X4: M1165A1	5
T61908	TRUCK CARGO: MTV W/E	1
T95555	TRAILER CARGO: MTV W/DROPSIDES M1095	4
T95924	TRAILER CARGO: HIGH MOBILITY 1-1/4 TON	2
T95992	LIGHT TACTICAL TRAILER: 3/4 TON	3
Z36683	TRAILER TANK WATER (CAMEL): 800 GAL 5 TON W/E NIGHT VISION/OBSERVATION	1
N05482	NIGHT VISION: GOGGLE	70
S90535	MEDIUM WEAPON THERMAL SIGHT (MWTS): AN/PAS-13(V)2	12
S90603	HEAVY WEAPON THERMAL SIGHT (HWTS): AN/PAS-13(V)3	7

COMMUNICATIONS AND ELECTRONICS

C17936	COMPUTER SET: AN/GYG-1(V)1	2
C18278	COMPUTER SYSTEM: DIGITAL AN/UYQ-90(V)2	4
C18378	COMPUTER SET: AN/UYK-128(V)3	20
C27707	COMPUTER SYSTEM: DIGITAL AN/TYQ-109(V)1	1
C40495	CMPTNR SY DI: AN/PYG-2(V)1	8
C53293	CT SY D: AN/PYG-1	4
C78851	COMPUTER SYSTEM: DIGITAL AN/UYQ-90(V)3	2
J54771	INTERCONNECT GROUP: ON-721/V	1

N96248	NAVIGATION SET: SATELLITE SIGNALS AN/PSN-13	30
P99881	PROCESSOR GROUP SIG DATA: (CAISI 2.0) OL-701A/TYQ	1
Q77755	RADIO SET CONTROL: C-2328/GRA-39	8
R45543	RADIO SET: AN/VRC-92F(C)	9
R67330	RADIO SET: AN/VRC-88F(C)	2
R68044	RADIO SET: AN/VRC-90F(C)	17
R68146	RADIO SET: AN/VRC-91F(C)	8
R87139	RADIO ST: AN/VRC-104(V)3 150 WATT W/PRC-150 HF RADIO	2
T40405	TAPE READER GENERAL PURPOSE: KOI-18/TSEC	2
Z00384	COMPUTER SYSTEM DIGITAL: AN/PYQ-10(C)	22

MISC EQUIPMENT

C05701	MONITOR CHEMICAL AGENT:	6
D03932	DETECTING SET: MINE AN/PSS-14	2
G18358	GEN SET: DED SKID MTD 3KW 60HZ	2
J00697	JOINT CHMCL AGENT: DETECTOR	3
M12986	MASK CHEMCL BIOLOGICL JOINT SERVICE GENERAL PURPOSE: FIELD M50	88
M13236	MASK CHEMCL-BLGCL JNT SRV GNL PRPSE: CMBT VHL CRWMN M51	6
S83835	SMALL UNMANNED AIRCRAFT SYSTEM (SUAS): RAVEN B (MIP)	1

FIRES BATTERY (155T), FIRES BN, IBCT

06238R000
6/0/108//114

BATTERY HEADQUARTERS PARA 01

FBCB2
2X NVG
DAGR
EPLRS
AN/VRC-92F



CPT 13A00 CDR M4 M9
LT 13A00 EXECUTIVE OFFICER
1SG 13Z5M 1SG M4
SSG 25U30 FWD SIG SPT NCO M4
PFC 13D10 DRIVER M4

SUPPLY SECTION PARA 02

2X NVG AN/TYQ-109(V)1
DAGR AN/UHQ-90(V)3
AN/VRC-90F .50 CAL
HWTS
OL-701A/TYQ



SGT 92Y20 SUPPLY NCO M4
SPC 92Y10 SUPPLY SP M4

FIRING PLATOON HEADQUARTERS PARA 03

FBCB2 2X NVG
DAGR EPLRS
AN/VRC-92F
AN/UJTK-128(V)1
MK-19
HWTS



1LT 13A00 PLT LDR M4
PFC 13D10 DRIVER M4

FBCB2 2X NVG
DAGR EPLRS
AN/VRC-89F
AN/UJK-128(V)1
M240B
MWTS



SFC 13B40 PLT SGT M4
SFC 13B40 GUNNERY SGT M4

x2

Mission: To destroy, neutralize or suppress the enemy with cannon fire.

FIRE DIRECTION CENTER PARA 04

2X NVG
DAGR
2X AN/VRC-92F

2X AN/PYG-1

AN/GYG-1(V)1
FBCB2 2X NVG
DAGR EPLRS
2X AN/VRC-92F
AN/VRC-90F
AN/VRC-104(V)3
AN/UJK-128(V)1
M240B MWTS
KOI-18/TSEC



1LT 13A00 FIRE DIR OFF M4
SSG 13D30 FIRE CONT SGT M4
SGT 13D20 FIRE CONT SGT M4
SPC 13D10 FATDS SP M4

SSG 13D30 FIRE CONT SGT M4
SPC 13D10 FATDS SP M4
PFC 13D10 FATDS SP M4
PFC 13D10 FATDS SP M4

x2

HOWITZER SECTION (155T) PARA 05

AN/PVS-6
2X NVG
DAGR
AN/VRC091F
HWTS



SSG 13B30 SEC CH M4
SPC 13B10 CANNONEER M4
SPC 13B10 CANNONEER M4
SGT 13B20 GUNNER/AMMO TM CH M4
SPC 13B10 PRIME MOVER DRIVER M4

SGT 13B20 GUNNER
SPC 13B10 ASST GNR M4
SPC 13B10 CANNONEER M4
SPC 13B10 CANNONEER M4
SPC 13B10 CANNONEER M4

x6

AMMUNITION SECTION PARA 06

AN/VAS-5
AN/UHQ-90(V)2
2X NVG
DAGR
AN/VRC-90F



x10

SSG 13B30 AMMO SECTION CH M4
SGT 13B20 AMMO SGT M4
SGT 13B20 AMMO SGT M4
SGT 13B20 AMMO SGT M4
SPC 13B00 AMMO SP M4
SPC 13B00 AMMO SP M4
SPC 13B00 AMMO SP M4
PFC 13B00 AMMO HANDLER/VEH DRIVER M4
PFC 13B00 AMMO HANDLER/VEH DRIVER M4
PFC 13B00 AMMO HANDLER/VEH DRIVER M4

x2

EQUIPMENT SUMMARY

WEAPONS

H57505	HOWITZER LIGHT TOWED: M119	6
L69080	LAUNCHER GRENADE: M320A1	14
M92362	MACHINE GUN GRENADE 40MM: MK19 MOD III	4
M92841	MACHINE GUN: 7.62MM M240B	12
P98152	PISTOL 9MM AUTOMATIC: M9	1
R97234	RIFLE 5 56 MILLIMETER: M4	94
Z00686	MACHINE GUN: CALIBER .50	3

VEHICLES, TRAILERS AND TRLR MTD SYSTEMS

T37588	TRUCK UTILITY EXPANDED CAPACITY ENHANCED: M1152A1	20
T41135	TRUCK CARGO: MTV W/E W/W	2
T41203	TRUCK CARGO: MTV W/MHE W/E	2
T56383	TRUCK UTILITY EXPANDED CAPACITY ENHANCED 4X4: M1165A1	5
T61908	TRUCK CARGO: MTV W/E	1
T95555	TRAILER CARGO: MTV W/DROPSIDES M1095	4
T95924	TRAILER CARGO: HIGH MOBILITY 1-1/4 TON	2
T95992	LIGHT TACTICAL TRAILER: 3/4 TON	3
Z36683	TRAILER TANK WATER (CAMEL): 800 GAL 5 TON W/E	1

NIGHT VISION/OBSERVATION

N05482	NIGHT VISION: GOGGLE	70
S90535	MEDIUM WEAPON THERMAL SIGHT (MWTS): AN/PAS-13(V)2	12
S90603	HEAVY WEAPON THERMAL SIGHT (HWTS): AN/PAS-13(V)3	7

COMMUNICATIONS AND ELECTRONICS

C17936	COMPUTER SET: AN/YG-1(V)1	2
C18278	COMPUTER SYSTEM: DIGITAL AN/UYQ-90(V)2	4
C18378	COMPUTER SET: AN/UYK-128(V)3	20
C27707	COMPUTER SYSTEM: DIGITAL AN/TYQ-109(V)1	1
C40495	CMPTR SY DI: AN/PYG-2(V)1	8
C53293	CT SY D: AN/PYG-1	4
C78851	COMPUTER SYSTEM: DIGITAL AN/UYQ-90(V)3	2
J54771	INTERCONNECT GROUP: ON-721/V	1
N96248	NAVIGATION SET: SATELLITE SIGNALS AN/PSN-13	30
P99881	PROCESSOR GROUP SIG DATA: (CAISI 2.0) OL-701A/TYQ	1
Q77755	RADIO SET CONTROL: C-2328/GRA-39	8
R45543	RADIO SET: AN/VRC-92F(C)	9
R67330	RADIO SET: AN/VRC-88F(C)	2
R68044	RADIO SET: AN/VRC-90F(C)	17
R68146	RADIO SET: AN/VRC-91F(C)	8
R87139	RADIO ST: AN/VRC-104(V)3 150 WATT W/PRC-150 HF RADIO	2
T40405	TAPE READER GENERAL PURPOSE: KOI-18/TSEC	2
Z00384	COMPUTER SYSTEM DIGITAL: AN/PYQ-10(C)	22

MISC EQUIPMENT

C05701	MONITOR CHEMICAL AGENT:	6
D03932	DETECTING SET: MINE AN/PSS-14	2
G18358	GEN SET: DED SKID MTD 3KW 60HZ	2
J00697	JOINT CHMCL AGENT: DETECTOR	3
M12986	MASK CHEMICAL BIOLOGICAL JOINT SERVICE GENERAL PURPOSE: FIELD M50	88
M13236	MASK CHEMICAL-BLGCAL JNT SRV GNL PRPSE: CMBT VHL CRWMN M51	6
S83835	SMALL UNMANNED AIRCRAFT SYSTEM (SUAS): RAVEN B (MIP)	1

FIRES BATTERY(155SP), FIRES BATTALION, IBCT

Target Acquisition Platoon Fires Battalion

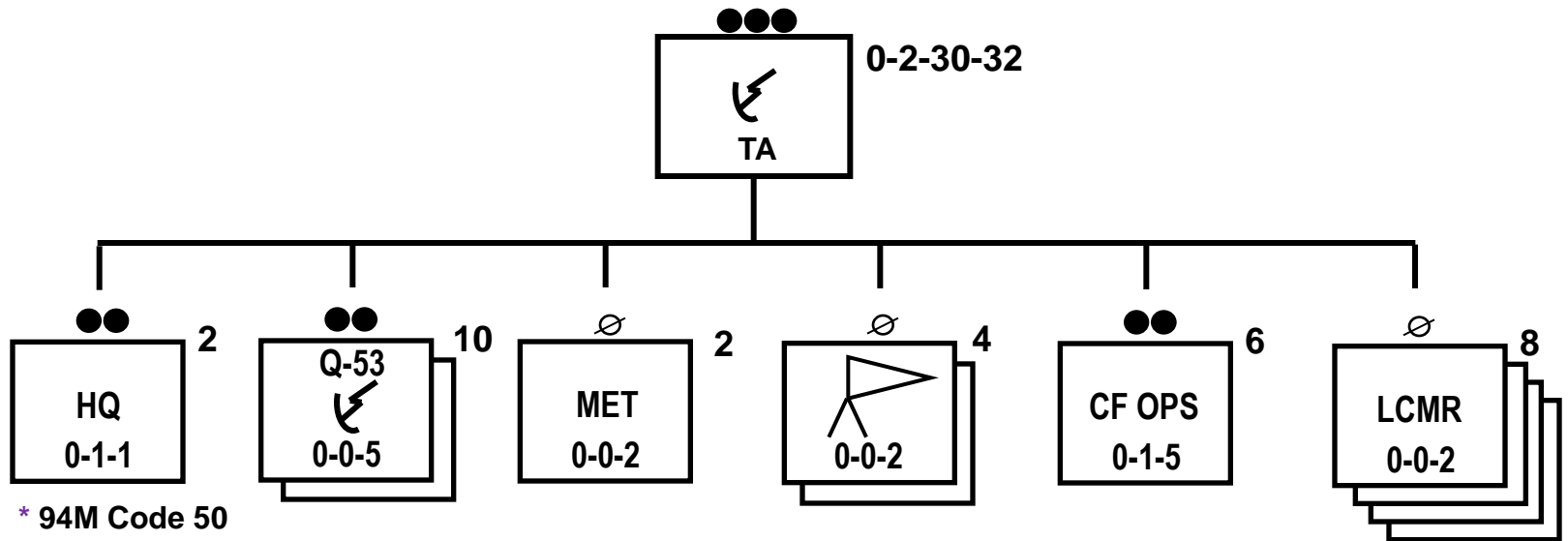

* Code 50 account for on SRC 63 not included in total

TARGET ACQUISITION PLATOON, FIRES BN, IBCT

06540RA00
0/1/1// 2

MISSION: To provide team-level command and control for attached Field Artillery target acquisition teams.

TARGET ACQUISITION PLATOON HQ PARA 01

FBCB2
AN/VAS-5
x2 NVG
DAGR
AN/VRC-92F

AN/PSG-14(V)1
M240B
MWTS
KOI-18/TSEC

EQUIPMENT SUMMARY



CW2 131A0 PLT LDR M4
SFC 13R40 PLT SGT M4

WEAPONS

LAUNCHER GRENADE: M320A1----- 1
MACHINE GUN 7.62MM M240B----- 1
RIFLE 5.56MM M4 CARBINE----- 2

VEHICLES, TRAILERS, AND TRLR MTD SYSTEMS

TRUCK UTILITY EXP CAPACITY ENH 4X4: M1165A1----- 1
TRAILER HIGH MOBILITY 1-1/4T (M1102)----- 1

NIGHT VISION/OBSERVATION EQUIPMENT

DRIVERS VISION ENHANCER: AN/VAS-5----- 1
NIGHT VISION GOGGLES: AN/PVS-7B----- 2
SIGHT THERMAL: AN/PAS-13B(V)2 MEDIUM TWS----- 1

COMMUNICATION-ELECTRONICS EQUIPMENT

ANTENNA GROUP: OE-254----- 1
COMPUTER SYSTEM DIGITAL: AN/PSG-14(V)1 LFED----- 1
COMP SET DIGITAL: AN/UJK-128(V)3 (FBCB2 BFT APPLIQUE)----- 1
NAVIGATION SET: SATELLITE SIGNALS AN/PSN-13 (DAGR)----- 1
RADIAC SET: AN/VDR-2----- 1
RADIO SET: AN/VRC-92F----- 1

WLRS, (TPQ-53), FIRES BN, IBCT

06540RB00
0/0/5// 5

MISSION: To locate enemy mortar firing positions in the area of operations.

(X2) WEAPONS LOCATING RADAR SECTION (TPQ-53) PARA 01



(TPQ-53)
SSG 13R30 SECT CHIEF M4
PFC 13R10 FF RADAR OPR M4

AN/PU - 805B
SGT 13R20 SR FF RADAR OPR M4
SPC 13R10 FF RADAR OPR M4
PFC 13R10 FF RADAR OPR M4

EQUIPMENT SUMMARY

WEAPONS

LAUNCHER GRENADE: M320A1----- 1
MACHINE GUN 7.62MM M240B----- 1
RIFLE 5.56MM M4 CARBINE----- 4

VEHICLES, TRAILERS, AND TRLR MTD SYSTEMS

GENERATOR SET: DED TM: 10KW 400HZ PU-799----- 1
TRUCK CARGO MTV----- 2

MISCELLANEOUS EQUIPMENT

GEN SET: DED SKID MTD 60KW PU-805B-)----- 1
RADAR SET: AN/TPQ-53----- 1

COMMUNICATION-ELECTRONICS EQUIPMENT

ANTENNA GROUP: OE-254----- 2
COMP SET DIGITAL: AN/UJK-128(V)3 (FBCB2 BFT APPLIQUE)----- 1
NAVIGATION SET: SATELLITE SIGNALS AN/PSN-13 (DAGR)----- 2
RADIAC SET: AN/VDR-2----- 1
RADIO SET: AN/VRC-90F----- 3
RADIO SET: AN/VRC-92F----- 1

NIGHT VISION/OBSERVATION EQUIPMENT

DRIVERS VISION ENHANCER: AN/VAS-5----- 2
NIGHT VISION GOGGLES: AN/PVS-7B----- 5
MEDIUM WEAPON THERMAL SIGHT (MWTS): AN/PAS-13(V)2----- 1

METEOROLOGICAL TEAM, FIRES BN, IBCT

06540RD00
0/0/2/ 2

**MISSION: Provide meteorological data for
Field Artillery technical fire direction.**

METEOROLOGICAL TEAM PARA 01

FBCB2
AN/VAS-5
x2 NVG
DAGR
AN/VRC-92F
AN/VRC-90F

M240B
MWTS
AN/TSR-8
KOI-18/TSEC

AN/TMQ-52



SGT 13T20 METRO EQUIP REP M4
SPC 13T10 FA METRO SP M4

EQUIPMENT SUMMARY

WEAPONS

MACHINE GUN 7.62MM M240B----- 1
RIFLE 5.56MM M4 CARBINE----- 2

VEHICLES, TRAILERS, AND TRLR MTD SYSTEMS

TRUCK UTILITY EXP CAPACITY ENH 4X4: M1152A1----- 1
TRAILER HIGH MOBILITY 1-1/4T (M1102)----- 1

MISCELLANEOUS EQUIPMENT

METEOROLOGICAL MEASURING SET: PROFILER AN/TMQ-52----- 1

COMMUNICATION-ELECTRONICS EQUIPMENT

ANTENNA GROUP: OE-254----- 1
NAVIGATION SET: SATELLITE SIGNALS AN/PSN-13 (DAGR)----- 1
RADIAC SET: AN/VDR-2----- 1
RECEIVE SUITE: AN/TSR-8 (GRT)----- 1
RADIO SET: AN/VRC-90F----- 1
RADIO SET: AN/VRC-92F----- 1

NIGHT VISION/OBSERVATION EQUIPMENT

DRIVERS VISION ENHANCER: AN/VAS-5----- 1
NIGHT VISION GOGGLES: AN/PVS-7B----- 2
MEDIUM THERMAL WEAPONS SIGHT: AN/PAS-13(V2)----- 1

SURVEY TEAM, FIRES BN, IBCT

06540RE00
0/0/2/ 2

**MISSION: Provide survey control points and other data for precise
locating and orientation of radars and meteorological sets.**

(x2) FA SURVEY TEAM PARA 01

FBCB2
AN/VAS-5
x2 NVG
DAGR
AN/VRC-92F

AN/PSG-14(V)1
M249
MWTS



SGT 13T20 SURVEYOR COMPUTER/PADS TEAM CHIEF M4
SPC 13T10 FA SURVEYOR/PADS VEH DRIVER M4

EQUIPMENT SUMMARY

WEAPONS

LAUNCHER GRENADE: M320A1----- 1
MACHINE GUN LIGHT 5.56MM M249----- 1
RIFLE 5.56MM M4 CARBINE----- 2

VEHICLES, TRAILERS, AND TRLR MTD SYSTEMS

TRUCK UTILITY EXP CAPACITY ENH 4X4: M1152A1----- 1

MISCELLANEOUS EQUIPMENT

IMPROVED POSN AND AZIMUTH DETERMINING SYS: (IPADS)----- 1

COMMUNICATION-ELECTRONICS EQUIPMENT

COMPUTER SYSTEM DIGITAL: AN/PSG-14(V)1 LFED----- 1
NAVIGATION SET: SATELLITE SIGNALS AN/PSN-13 (DAGR)----- 1
RADIAC SET: AN/VDR-2----- 1
RADIO SET: AN/VRC-92F----- 1

NIGHT VISION/OBSERVATION EQUIPMENT

DRIVERS VISION ENHANCER: AN/VAS-5----- 1
MINI EYESAFE LASER INFR OBSN DEVICE: (MELIOS): AN/PVS-6----- 2
NIGHT VISION GOGGLES: AN/PVS-7B----- 2
MEDIUM THERMAL WEAPONS SIGHT: AN/PAS-13(V2)----- 1

COUNTERFIRE OPERATIONS SECTION, FIRES BN, IBCT

06540RF00
0/1/5// 6

MISSION: To provide target processing and targeting data for attack by lethal means.

COUNTERFIRE OPERATIONS SECTION, FIRES BN (IBCT) PARA 01

FBCB2
x2 NVG
DAGR
AN/VRC-92F

AN/PSC-5
AN/GYK-56

EQUIPMENT SUMMARY



CW2 131A0 TARGETING OFF M4 S
SFC 13R40 SR FA TARGETING NCO M4
SSG 13F30 TARGETING NOC M4
SGT 13F20 TGT NCO M4
SPC 13F10 TGT PROC SP M4
PFC 13F10 TGT PROC SP M4

WEAPONS

RIFLE 5.56MM M4 CARBINE----- 6

VEHICLES, TRAILERS, AND TRLR MTD SYSTEMS

TRUCK UTILITY EXP CAPACITY ENH 4X4: M1165A1----- 1
LIGHT TACTICAL TRAILER: 3/4T (M1101)----- 1

COMMUNICATION-ELECTRONICS EQUIPMENT

NAVIGATION SET: SATELLITE SIGNALS AN/PSN-13 (DAGR)----- 1
RADIO SET: AN/VRC-92F----- 1
RADIO SET: AN/PSC-5----- 1
COMPUTER SET FA GENERAL: AN/GYK-56 (EMT)----- 1

NIGHT VISION/OBSERVATION EQUIPMENT

NIGHT VISION GOGGLES: AN/PVS-7B----- 2

LIGHTWEIGHT COUNTER MORTAR RADAR SECTION, FIRES BN, IBCT

06540RG00
0/0/8// 8

MISSION: To locate enemy mortar firing positions in the area of operations.

LCMR SECTION PARA 01

FBCB2
x2 NVG
DAGR
AN/VRC-89F

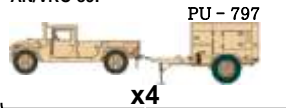

SSG 13R30 SECT CHIEF M4
SGT 13R20 SR LCMR RD OPR M4
SPC 13R10 LCMR RADAR OPR M4
SPC 13R10 LCMR RADAR OPR M4
SPC 13R10 LCMR RADAR OPR M4
PFC 13R10 LCMR RADAR OPR M4
PFC 13R10 LCMR RADAR OPR M4
PFC 13R10 LCMR RADAR OPR M4

EQUIPMENT SUMMARY

WEAPONS

LAUNCHER GRENADE: M320A1----- 4
RIFLE 5.56MM M4 CARBINE----- 8

VEHICLES, TRAILERS, AND TRLR MTD SYSTEMS

GEN SET DED TM: 5KW 60HZ (PU-797)----- 4
TRUCK UTILITY EXP CAPACITY ENH 4X4: M1152A1----- 4

MISCELLANEOUS EQUIPMENT

LIGHTWEIGHT COUNTER MORTAR RADAR: AN/TPQ-50----- 4

COMMUNICATION-ELECTRONICS EQUIPMENT

ANTENNA GROUP: OE-254----- 4
NAVIGATION SET: SATELLITE SIGNALS AN/PSN-13 (DAGR)----- 4
RADIO SET: AN/VRC-89F----- 4

NIGHT VISION/OBSERVATION EQUIPMENT

NIGHT VISION GOGGLES: AN/PVS-7B----- 8

HHC, Brigade Support Bn (BSB), IBCT

MISSION.

To provide command and control, staff planning, supervision and field feeding support for all organic assigned or attached units to the Brigade Support Battalion (BSB).

HHC, BSB, IBCT

63036R000
17/2/64// 83

COMMAND SECTION PARA 01

CURR OPS-INTEL/S2 PARA 02

CURRENT OPS-OPS/S3 PARA 03

SUSTAINMENT 1-S1 PARA 04

SUSTAINMENT 1-S4 PARA 05

AN/TYQ-90(V)2
FBCB2
2X NVG
DAGR
ON-721/V
AN/VRC-92F



LTC 90A00 CDR M4 M9
SPC 88M10 DRIVER M4

MAJ 90A00 XO M4 M9

AN/UYQ-90(V)2
FBCB2
2X NVG
DAGR
AN/VRC-90F



CSM 00Z50 CSM M4 M9

2X NVG
DAGR
AN/TYQ-93
AN/VRC-90F



CPT 35D00 S2 M4
SGT 35F20 INTEL ANLST M4
SPC 35F10 INTEL ANLST M4

2X NVG
DAGR
AN/VRC-92F
AN/VRC-104(V)3

COMPUTER SYS DIGITAL
AN/PYQ-6C



FBCB2
AN/GYK-61
2X NVG
AN/VRC-90F



MED PWR PLANT

2X NVG
DAGR
AN/VRC-92F
AN/VRC-104(V)3



AN/MJQ-40

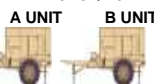

A UNIT B UNIT

2X NVG
DAGR
AN/VRC-90F
4X ARMY HR WORKSTATION



CPT 42B00 S1 M4
SFC 42A40 SR HR SGT M4
SSG 42A30 HR SGT M4
SGT 42A20 HR SGT M4
SGT 27D20 PARALEGAL M4
SPC 42A10 HR SP M4
PFC 42A10 HR SP M4
PFC 42A10 HR SP M4

AN/GYK-61
AN/TYQ-109(V)1
AN/UYQ-90(V)3
2X NVG
DAGR
AN/VRC-90F



MED PWR PLANT

CPT 90A00 S4 M4
SFC 92Y40 SUPPLY SGT M4
SPC 92Y10 SUPPLY SP M4
SGT 92Y20 SUPPLY NCO M4

SUSTAINMENT 1-C4OPS/S6 PARA 06

SUSTAINMENT 1-UMT PARA 7

SUSTAINMENT 2-SUPPORT OPERATIONS PARA 08

AN/PYQ-12
AN/TSQ-243
2X KG-175
AN/TSR-8
AN/GYK-50B
AN/TSQ-259
AN/GYK-62B

2X NVG
DAGR
AN/VRC-92F



2X NVG
DAGR
AN/VRC-90F



2X NVG
DAGR
AN/VRC-90F



CPT 25A00 S6 M4
SFC 25U40 SECT CHIEF M4
SGT 25Q20 SR XMSN SYS OPR M4
SPC 25U10 SIG INFO SVC SP M4
SPC 25B10 LAN MGR M4
SPC 25U10 SIG SPT SYS MAINT M4
SPC 25U10 NODAL OPR MAINT M4
SPC 25Q10 XMSN SYS OPR MNT M4
PFC 25B10 LAN MGR M4
PFC 25U10 SIG SPT SYS SP M4
PFC 25U10 SIG SPT SYS MAINT M4
PFC NODAL SYS OPR/MAINT M4

2X NVG
DAGR
AN/VRC-90F

BATTALION COMMAND
POST SWITCHING



2X NVG
DAGR
AN/VRC-90F



CPT 56A00 CHAPLAIN
PFC 56M10 CHAPLAIN ASST M4

AN/UYQ-90(V)2
FBCB2
2X NVG
DAGR
AN/VRC-92F



2X NVG
DAGR
AN/VRC-90F



AN/TYQ-106(V)1
AN/GYK-61
AN/TYQ-105(V)1
OL-701A/TYQ
AN/VRC-90F
OL-713/TYQ



2X NVG
DAGR
AN/VRC-90F



MED PWR PLANT

MAJ 90A00 SUPP OPS OFF M4 M9
CW4 915E0 SR ORD GRD MAINT WO M4
CPT 92A00 OPS OFF M4
CPT 90A00 TRANS OFF M4
CPT 70H67 MED OPS OFF M4
CPT 90A00 AMMO OFF M4
CPT 70K67 MED LOG OFF M4
MSG 92A50 OPS SGT M4
SFC 92A40 MAT MGT NCO M4
SFC 68W40 OPS SGT M4
SFC 89B40 AMMO LOG SGT M4
SFC 91C40 MAINT MGT NCO M4
SSG 88N30 MVTS SUPV M4
SSG 92F30 PETRL SUPPLY SGT M4
SSG 92M30 MORT AFFAIRS NCO M4
SSG 89B30 AMMO INSP M4
SGT 88N20 TRANS MGMT NCO M4

SUSTAIN 2-C4OPS/CSSAMO PARA 09

COMPANY HEADQUARTERS PARA 10

FIELD FEEDING SECTION PARA 11

2X NVG
DAGR
AN/VRC-90F



CW2 255A0 INFO SYS TECH M4
SFC 25B40 INFO SYS SUPV M4
SSG 92Y30 SUPPLY SGT M4
SSG 92A20 MAT MGT NCO M4
SGT SR INFO SYS SP M4
SGT 68G20 PAT SVCS NCO M4
SGT 92A30 MAT MGT NCO M4
SGT 92Y20 SUPPLY NCO M4
SPC 25B10 INFO SYS SP M4
PFC 25B10 INFO SYS SP M4

AN/TYQ-107(V)1
AN/TYQ-109(V)2
AN/TYQ-107(V)1
AN/TYQ-120(V)2
AN/TYQ-108(V)3
OL-603/TYQ
DGR
AN/VRC-90F
AN/TYQ-141



AN/UYQ-90(V)2
FBCB2
2X NVG
DAGR
AN/VRC-92F



CPT 90A00 CDR M4 M9

2X NVG
DAGR
AN/VRC-90F



SGT 92Y20 SUPPLY NCO M4
SPC 92Y10 SUPPLY SP M4

OL-701A/TYQ
RAVEN
.50 CAL
HWTS



1SG 92A5M 1SG M4

AN/TYQ-109(V)1

2X NVG
AN/VRC-90F



2X NVG
AN/VRC-90F



2X NVG
AN/VRC-90F



MTRCS

SFC 92G40 SR FOOD OPNS SGT M4
SSG 92G30 FOOD OPS MGR M4
SGT 92G20 FOOD OPS NCO M4
SGT 92G20 FOOD OPS NCO M4
SPC 92G10 FOOD OPS SP M4
SPC 92G10 FOOD OPS SP M4
SPC 92G10 FOOD OPS SP M4
PFC 92G10 FOOD OPS SP M4
PFC 92G10 FOOD OPS SP M4
PFC 92G10 FOOD OPS SP M4
PFC 92G10 FOOD OPS SP M4

EQUIPMENT SUMMARY

WEAPONS

L69080	LAUNCHER GRENADE: M320A1	4
M09009	MACHINE GUN 5.56 MILLIMETER: M249	8
M39263	MACHINE GUN: LIGHT 5.56MM M249	4
M92362	MACHINE GUN GRENADE 40MM: MK19 MOD III	1
M92841	MACHINE GUN: 7.62MM M240B	3
P98152	PISTOL 9MM AUTOMATIC: M9	6
R97234	RIFLE 5 56 MILLIMETER: M4	73
Z00686	MACHINE GUN: CALIBER .50	3

VEHICLES, TRAILERS AND TRLR MTD SYSTEMS

C27633	CONTAINERIZED KITCHEN: CK	1
E02807	CHASSIS TRAILER: GENERATOR 2-1/2 TON 2 WHEEL W/E	1
P42126	POWER PLANT: ELECTRIC TRAILER MTD 30KW 50/60HZ AN/MJQ 40	1
P63462	POWER PLANT: UTILITY (MEDIUM)	3
T37588	TRUCK UTILITY EXPANDED CAPACITY ENHANCED: M1152A1	7
T41271	TRUCK VAN: EXPANSIBLE MTV W/E M1087A1	1
T56383	TRUCK UTILITY EXPANDED CAPACITY ENHANCED 4X4: M1165A1	8
T60081	TRUCK CARGO: 4X4 LMTV W/E	6
T61908	TRUCK CARGO: MTV W/E	3
T95924	TRAILER CARGO: HIGH MOBILITY 1-1/4 TON	4
T96564	TRAILER FLAT BED: M1082 TRLR CARGO LMTV W/DROPSIDES	4
Z00206	MULTI-TEMPERATURE REFRIGERATED CONTAINER SYSTEM: MTRCS	1
Z36683	TRAILER TANK WATER (CAMEL): 800 GAL 5 TON W/E	2

NIGHT VISION/OBSERVATION

N05482	NIGHT VISION: GOGGLE	52
S90535	MEDIUM WEAPON THERMAL SIGHT (MWTS): AN/PAS-13(V)2	7
S90603	HEAVY WEAPON THERMAL SIGHT (HWTS): AN/PAS-13(V)3	4

MISC EQUIPMENT

C79000	COLLECTIVE PROTECTION EQUIPMENT: NBC SIMPLIFIED M20	4
D82404	DECONTAMINATING APPARATUS: PWR DRVN LT WT	2
G42170	GEN SET DED TM: 10KW 60HZ MTD ONM116A2 PU-798	1
G74711	GEN SET: DED SKID MTD 10KW 60HZ	1
J00697	JOINT CHMCL AGENT: DETECTOR	3
J01197	JOINT SERVICE: TRANSPORTABLE DECONTAMINATION	2
M12986	MASK CHEMICL BIOLOGICL JOINT SERVICE GENERAL PURPOSE: FIELD M50	82
R20684	RADIAC SET: AN/VDR-2	3
R20684	RADIAC SET: AN/VDR-2	1
R30925	RADIAC SET: AN/PDR-75	1
R31061	RADIAC SET: AN/UDR-13	4
S83835	SMALL UNMANNED AIRCRAFT SYSTEM (SUAS): RAVEN B (MIP)	1
Z01330	GEN SET DED 10KW 50/60HZ: SKID-MTD	1

COMMUNICATIONS AND ELECTRONICS

A35329	ALL SOURCE ANALYSIS SYSTEM: AN/TYQ-93	1
C18209	COMPUTER SET: DIGITAL AN/TYQ-107(V)2	1
C18277	COMPUTER SET: DIGITAL AN/TYQ-107(V)1	1
C18278	COMPUTER SYSTEM: DIGITAL AN/UYQ-90(V)2	7
C18345	COMPUTER SET: DIGITAL AN/TYQ-106(V)1	1
C18378	COMPUTER SET: AN/UUK-128(V)3	6
C18448	COMPUTER SYSTEM: DIGITAL AN/GYK-61	4
C18641	COMPUTER SYST DIGITAL: AN/PYQ-12	1
C27435	COMPUTER SYSTEM: DIGITAL AN/TYQ-129(V)2	3
C27503	COMPUTER SYSTEM: DIGITAL AN/TYQ-105(V)1	2
C27639	COMPUTER SYSTEM: DIGITAL AN/TYQ-108(V)3	1
C27707	COMPUTER SYSTEM: DIGITAL AN/TYQ-109(V)1	2
C27775	COMPUTER SYSTEM: DIGITAL AN/TYQ-109(V)2	1
C27823	COMPUTER SET: DIGITAL OL-608/TYQ	2
C27963	COMPUTER SYSEM: DIGITAL	5
C61665	COMMAND CENTER SYSTEM: AN/TSQ-243	1
C67436	COMPUTER SYSTEM DIGITAL: AN/PYQ-6C	1
C78827	COMPUTER SET: DIGITAL OL-603/TYQ	1
C78851	COMPUTER SYSTEM: DIGITAL AN/UYQ-90(V)3	4
E08940	ENCRYPTION-DECRYPTION EQUIPMENT: TACLANE KG 175	3
J54771	INTERCONNECT GROUP: ON-721/V	1
N96248	NAVIGATION SET: SATELLITE SIGNALS AN/PSN-13	21
P99881	PROCESSOR GROUP SIG DATA: (CAISI 2.0) OL-701A/TYQ	5
R30658	RECEIVE SUITE: AN/TSR-8	1
R44999	RADIO SET: AN/VRC-89F(C)	1
R45543	RADIO SET: AN/VRC-92F(C)	6
R68044	RADIO SET: AN/VRC-90F(C)	18
R87139	RADIO ST: AN/VRC-104(V)3 150 WATT W/PRC-150 HF RADIO	3
R93169	RADIO TEST SET: AN/PRM-34()	4
Z00384	COMPUTER SYSTEM DIGITAL: AN/PYQ-10(C)	21
Z00513	COMPUTER SYSTEM DIGITAL: AN/GYK-50B (ISYSCON) (V)4	1
Z00560	INTERFACE UNIT COMMUNICATION EQUIPMENT: OL-713(V)1/TYQ CSS VSAT	2
Z00564	BATTALION COMMAND POST(SWITCHING GROUP): OM-XXX	1
Z00930	COMMUNICATIONS SUBSYSTEM: AN/TSQ-259	1
Z01160	COMPUTER SYSTEM: DIGITAL AN/TYQ-141	2
Z01248	COMPUTER SET: DIGITAL AN/GYK-62B	1
Z39781	ARMY H RESURCES: WRKSTATION	5

DISTRIBUTION COMPANY, BSB, IBCT

63038R000
5/2/97// 104

COMPANY HEADQUARTERS PARA 01 TRANSPORTATION PLT HQ PARA 02 TRUCK SQUAD (HEAVY) PARA 03

MISSION: To provide field maintenance, transportation, and supply support to a IBCT.

2X NVG DAGR
HWTS X2 MWTS
FBCB2 KG-175
ON-721/V M240B
AN/UYK-128
AN/PYQ-10 (C)
AN/UYQ-90(V)3
CPT 90A00 CDR M4 M9
SPC 92Y10 SUPPLY SP M4
SFC 88M40 TRUCKMASTER M4



2X NVG DAGR
HWTS X4 MWTS
X2 .50 CAL M240B
AN/UYK-128 OL-701A/TYQ
AN/VRC-90F AN/PYQ-10 (C)
AN/UYQ-90(V)2 AN/TYQ-109(V)1



1LT 92A00 OPS OFF M4
1SG 92A5M 1SG M4
SSG 92Y30 SUPPLY SGT M4

FBCB2 2X NVG
DAGR AN/PYQ-10
AN/VRC-92F
AN/UYQ-90(V)2
AN/UYQ-90(V)3



1LT 88A00 PLT LDR M4
SFC 88M40 PLT SGT M4
SGT 88M20 DISPATCHER M4
SGT 88M20 DISPATCHER M4

2X NVG M249
.50 CAL AN/UYQ-90(V)2
AN/VRC-90F 2X NVG
AN/PRC-148(V)4 AN/VRC-90F
AN/UYQ-90(V)2 AN/UYQ-90(V)2
X2 HAND-HELD RADIO



x15

SSG 88M30 SQD LDR M4 SGT 88M20 DRIVER M4
SSG 88M30 DRIVER M4 SGT 88M20 DRIVER M4
SGT 88M20 DRIVER M4 SPC 88M10 DRIVER M4
SPC 88M10 DRIVER M4 SPC 88M10 DRIVER M4
PFC 88M10 DRIVER M4 PFC 88M10 DRIVER M4

x3 (was x5)

SUPPLY PLT HQ PARA 04

AN/UYQ-90(V)2 AN/UYK-128
FBCB2 OL-603/TYQ
2X NVG AN/UYQ-90(V)3
DAGR OL-701A/TYQ
AN/PYQ-10
AN/VRC-90F



1LT 92A00 PLT LDR M4
CW2 920B0 SUPPLY SYS TECH M4
SFC 92A40 PLT SGT M4
SSG 92A30 MAT CON/ACCTG SUPV M4
SGT 92A20 MAT CON/ACCTG NCO M4
SPC 92A10 MAT CON/ACCTG SP M4
SPC 92A10 MAT CON/ACCTG SP M4
PFC 92A10 MAT CON/ACCTG SP M249

GENERAL SUPPLY AND CLASS IX SECTION PARA 05

DAGR 2X NVG

OL-701A/TYQ

OL-604/TYQ
AN/VRC-90F

S-785G SHELTER



x5

DAGR 2X NVG
AN/PYQ-10(C)
AN/VRC-90F



x5



x4

SSG 92A30 MAT MGMT SUPV M4
SSG 92A30 MAT MGMT SUPV M4
SGT 92A20 MAT STORE/HDLG SGT M4
SGT 92A20 MAT STORE/HDLG SGT M4
X2 SGT 92A20 MAT STORE/HDLG SGT M4

SPC 92A10 SUBSISTANCE SUP SP M4
X2 SPC 92A10 SUBSISTANCE SUP SP M4

SPC 92A10 MAT STORE/HDLG SP M4
SPC 92A10 MAT STORE/HDLG SP M249
X3 SPC 92A10 MAT STORE/HDLG SP M4

PFC 92A10 MAT STORE/HDLG SP M4
X2 PFC 92A10 SUBSISTANCE SUP SP M4
PFC 92A10 MAT STORE/HDLG SP M4
X2 PFC 92A10 MAT STORE/HDLG SP M249
PFC 92A10 MAT STORE/HDLG SP M4

AMMUNITION TRANSFER HOLDING POINT SECTION PARA 6

X2 NVG DAGR
AN/VRC-90F
AN/PYQ-10(C)
AN/UYQ-90(V)2
X3 AN/UYQ-90(V)2
FBCB2
X2 NVG
DAGR
X3 AN/PYQ-10(C)
X3 AN/VRC-90F
PU - 797
CW2 890A0 AMMO WO M4
SSG 89B30 SECT CHIEF M4



x3

2X NVG DAGR
AN/VRC-90F
AN/PYQ-10(C)



x2

W2 890A0 AMMO WO M4
SSG 89B30 SECT CHIEF M4
SGT 89B20 AMMO SGT M4
X2 SPC 89B10 AMMO SP M4
PFC 89B10 AMMO SP M4

SPC 89B10 AMMO SP M4
PFC 89B10 AMMO SP M4
PFC 89B10 AMMO SP M249
SGT 89A20 AMMO STK CON/ACCTG SP M4
SPC 89A10 AMMO SYTK CON/ACCTG SP M4

DISTRIBUTION COMPANY, BSB, IBCT

FUEL AND WATER PLT HQ PARA 07

CLASS III SECTION PARA 08

WATER SECTION PARA 09

FBCB2 2X NVG
DAGR
AN/VRC-90F(C)
AN/UJK-128
AN/UYG-90(V)3



1LT 92A00 PLT LDR M4
SFC 92F40 PLT SGT M4
SGT 92L20 PETRL LAB SGT M4

2X NVG DAGR
X1 50 CAL X1 M240B
AN/VRC-90F(C) AN/UJK-90(V)2



SSG 92F30 SECT CHIEF M4 SSG 92F30 SECT CHIEF M4
SGT 92F20 PETRL VEH OPR M4 SGT 92F20 PETRL VEH OPR M4
SPC 92F10 PETRL VEH OPR M4 SPC 92F10 PETRL VEH OPR M4
SPC 92F10 PETRL VEH OPR M4 SPC 92F10 PETRL VEH OPR M4
SPC 92F10 PETRL VEH OPR M4 SPC 92F10 PETRL VEH OPR M4

2X NVG X1 M240B
X1 MK-19 MOD III
AN/VRC-90F
AN/UJK-90(V)2
X2 AN/PYQ-10(C)



SSG 92W30 WATER TRMT SUPV M4
SGT 92W20 WATER TRMT NCO M4
SGT 92W20 WATER TRMT NCO M4
SGT 92W20 WATER TRMT NCO M4
SPC 92W10 WATER TMT SP M4
SPC 92W10 WATER TMT SP M4
SPC 92W10 WATER TMT SP M4
SPC 92W10 WATER TMT SP M4
PFC 92W10 WATER TRMT SP M4
PFC 92W10 WATER TRMT SP M4
PFC 92W10 WATER TRMT SP M4

EQUIPMENT SUMMARY

WEAPONS

L69080	LAUNCHER GRENADE: M320A1	4	C18278
M09009	MACHINE GUN 5.56 MILLIMETER: M249	16	C18378
M39263	MACHINE GUN: LIGHT 5.56MM M249	4	C18684
M92362	MACHINE GUN GRENADE 40MM: MK19 MOD III	8	C27435
M92841	MACHINE GUN: 7.62MM M240B	13	C27707
P98152	PISTOL 9MM AUTOMATIC: M9	1	C78827
R97234	RIFLE 5 56 MILLIMETER: M4	139	C78851
Z00686	MACHINE GUN: CALIBER .50	10	E08940

VEHICLES, TRAILERS AND TRLR MTD SYSTEMS

G42238	GEN SET DED TM: 5KW 60HZ MTD ON M116A2 PU-797	1	N96248
S70517	SEMITRAILER LOW BED: 25 TON 4 WHEEL W/E	7	P99881
T32629	LOAD HANDLING SYS (LHS): 2000 GAL COMP WATER TANK-RACK (HIPPO)	16	R45543
T37588	TRUCK UTILITY EXPANDED CAPACITY ENHANCED: M1152A1	2	R68044
T49255	TRUCK LIFT FORK: DSL DRVN 4000 LB CAP ROUGH TERRAIN	1	Z00384
T56383	TRUCK UTILITY EXPANDED CAPACITY ENHANCED 4X4: M1165A1	4	Z00712
T58161	TRUCK TANK: FUEL SERVICING 2500 GALLON 8X8 HEAVY EXP MOB W/WINCH	3	Z01320
T60081	TRUCK CARGO: 4X4 LMTV W/E	13	B83002
T61239	TRUCK TRACTOR: MTV W/E	7	C05701
T61908	TRUCK CARGO: MTV W/E	2	C84930
T73347	TRUCK LIFT: FORK VARIABLE REACH ROUGH TERRAIN	6	F04898
T87243	TRUCK TANK: FUEL SERVICING 2500 GALLON 8X8 HEAVY EXP MOB	3	F42612
T93761	TRAILER: PALLETIZED LOADING 8X20	39	G11966
T95555	TRAILER CARGO: MTV W/DROPSIDES M1095	1	G12034
T95924	TRAILER CARGO: HIGH MOBILITY 1-1/4 TON	2	G18358
T95992	LIGHT TACTICAL TRAILER: 3/4 TON	2	G74711
T96496	TRUCK CARGO: TACTICAL 8X8 HEAVY EXPANDED MOB W/LHS	34	H94824
T96564	TRAILER FLAT BED: M1082 TRLR CARGO LMTV W/DROPSIDES	13	J00697
Z36683	TRAILER TANK WATER (CAMEL): 800 GAL 5 TON W/E	1	M12986

NIGHT VISION/OBSERVATION

N05482	NIGHT VISION: GOGGLE	138	S01359
S90535	MEDIUM WEAPON THERMAL SIGHT (MWTS): AN/PAS-13(V)2	17	T14017
S90603	HEAVY WEAPON THERMAL SIGHT (HWTS): AN/PAS-13(V)3	18	W30051

COMMUNICATIONS AND ELECTRONICS

COMPUTER SYSTEM: DIGITAL AN/UJK-90(V)2	43
COMPUTER SET: AN/UJK-128(V)3	5
COMPUTER SET: DIGITAL OL-604/TYQ	5
COMPUTER SYSTEM: DIGITAL AN/TYQ-129(V)2	1
COMPUTER SYSTEM: DIGITAL AN/TYQ-109(V)1	1
COMPUTER SET: DIGITAL OL-603/TYQ	1
COMPUTER SYSTEM: DIGITAL AN/UJK-90(V)3	5
ENCRYPTION-DECRYPTION EQUIPMENT: TACLANE KG 175	1
INTERCONNECT GROUP: ON-721/V	1
NAVIGATION SET: SATELLITE SIGNALS AN/PSN-13	30
PROCESSOR GROUP SIG DATA: (CAISI 2.0) OL-701A/TYQ	4
RADIO SET: AN/VRC-92F(C)	2
RADIO SET: AN/VRC-90F(C)	66
COMPUTER SYSTEM DIGITAL: AN/PYQ-10(C)	63
COMPUTER SYSTEM DIGITAL: SAAS-MOD-ATHP	1
RADIO SET: AN/PRC-148 (V) 4 URBAN JEM	10

MISC EQUIPMENT

BED CARGO: DEMOUNTABLE PLS 8X20	148
MONITOR CHEMICAL AGENT:	2
CONTAINER HANDLING: HEAVY EXP MOBIL TACT TRK (HEMTT)	6
FUEL SYSTEM SUPPLY POINT: FSSP TYPE 3 120K	1
FORWARD AREA WATER POINT SUPPLY SYSTEM: (FAW SS)	1
GEN SET: DED SKID MTD 5KW 60HZ	1
GEN SET: DED SKID MTD 60KW 50/60HZ	1
GEN SET: DED SKID MTD 3KW 60HZ	4
GEN SET: DED SKID MTD 10KW 60HZ	1
FORWARD AREA REFUELING EQUIPMENT: (FARE)	1
JOINT CHMCL AGENT: DETECTOR	6
MASK CHEM BIOLOGICL JOINT SERVICE GENERAL PURPOSE: FIELD M50	155
RADIAC SET: AN/VDR-2	6
RADIAC SET: AN/PDR-75	1
RADIAC SET: AN/UDR-13	14
SHELTER: TACTICAL EXPANDABLE TWOSIDE	2
TACTICAL WATER PURIFICATION SYSTEM (TWPS) 1500 GPH:	1
WATER: PURIFIER LIGHTWEIGHT	2
COMMON REMOTELY OPERATED WPN STATION (CROWS):	12
GEN SET DED 10KW 50/60HZ: SKID-MTD	1

FIELD MAINTENANCE COMPANY, BSB, IBCT

43337R100
4/6/82// 92

MISSION: To provide field level maintenance support to an Infantry Brigade Support Battalion (BSB) for all automotive, ground support equipment, communications-electronic, armament peculiar systems, and limited recovery support.

COMPANY HEADQUARTERS PARA 01

AN/UYQ-90(V)2
FBCB2
ON-721/V
x2 NVG
DAGR
AN/VRC-90F
HWTS
.50 CAL



CPT 91A00 CDR M4 M9
SPC 92Y10 SUPPLY SP M4

AN/UYQ-90(V)2
FBCB2
x2 NVG
DAGR
AN/VRC-90F
HWTS
.50 CAL

x2 OL-701A/TYQ



1LT 91A00 XO M4
1SG 91Z5M 1SG M4
SGT 92Y20 SUPPLY NCO M4

MAINT CONTROL SECTION/PLT HQ PARA 02

x2 NVG
AN/VRC-90F



1LT 91A00 MAINT CONTROL OFF M4
PFC 92A10 EQUIP PARTS SP M4

x2 NVG
AN/VRC-90F



SFC 91X40 MATIN CONT SGT M4
SSG 88M30 MASTER DRV TRNR M4
PFC 92A10 EQUIP PARTS SP M4

x2 NVG
AN/VRC-90F



SGT 92A10 EQUIP PARTS SP M249

x2 NVG
OL-701A/TYQ
AN/VRC092F
KOI-18/TSEC



PU - 2101

SGT 92A20 EQUIP PARTS SGT M4
SGT 92A20 EQUIP PARTS SGT M4

AN/UYQ-90(V)2
AN/UYQ-90(V)3
x2 NVG
DAGR
AN/VRC-89F



SGT 92A10 EQUIP PARTS SP M4

SERVICE/RECOVERY SECTION PARA 03

AN/UYQ-90(V)2
FBCB2
2X NVG
DAGR
AN/VRC-90F
HWTS
.50 CAL



x2

AN/UYQ-90(V)2
FBCB2
M240B
2X NVG
DAGR
AN/VRC090F
MWTS



x2

2X NVG
AN/VRC-90F



FBCB2
x2 NVG
DAGR
AN/VRC-90F



CW2 914A0 ALLIED TRADES WO M4
SSG 91E30 RECOV VEH SUPV M4
PFC 91B10 RECOV VEH OPR M4
PFC 91B10 RECOV VEH OPR M4
SPC 91B10 RECOV VEH OPR M4
SGT 91B20 RECOV VEH OPR M4
SGT 91E20 ALLIED TRADES SP M4
PFC 91E10 ALLIED TRADES SP M4
PFC 91E10 ALLIED TRADES SP M4

FIELD MAINTENANCE SECTION PARA 04

x2 NVG
AN/VRC-90F



x5

AN/UYQ-90(V)2
FBCB2
x2 NVG
DAGR
AN/VRC-90F



x2

CW2 915A0 UTO MAINT WO M4
SFC 91X40 MOTOR SGT M4
X2 SSG 91B30 SR MECH M4
X2 SSG 91B30 SR MECH M4
X6 SGT 91B20 WH VEH MECH M4
X2 SGT 91B20 WH VEH MECH M4
PFC 91B10 WH VEH MECH M4

SGT 91B20 WH VEH MECH M4
SPC 91B10 WH VEH MECH M4
SPC 91B10 WH VEH MECH M4
X3 SPC 91B10 WH VEH MECH M4
X4 SPC 91B10 WH VEH MECH M4
X5 PFC 91B10 WH VEH MECH M4
X6 PFC 91B10 WH VEH MECH M4

AN/UYQ-90(V)2
xFCB2
x2 NVG
DAGR
AN/VRC-90F
HWTS



AN/UYQ-90(V)2
FBCB2
x2 NVG
DAGR
AN/VRC-90F



FIELD MAINTENANCE COMPANY, BSB, IBCT

MAINTENANCE PLT HQ PARA 05

AN/UYQ-90(V)2
FBCB2
x2 NVG
DAGR
AN/VRC-92F



1LT 91A00 PLT LDR M4
SFC 91X40 PLT SGT M4

GROUND SUPPORT EQUIPMENT REPAIR SECTION PARA 06

AN/UYQ-90(V)2
FBCB2
x2 NVG
DAGR
AN/VRC-90F



FBCB2
x2 NVG
DAGR
AN/VRC-90F



FBCB2
x2 NVG
DAGR
AN/VRC-90F



PU - 802

CW2 919A0 ENG EQUIP MAINT WO M4
SFC 91X40 SP PURP EQUIP REP SUPV M4
SSG 91C30 SR QM & CHEM EQ REP M4
SSG SR UTIL EQUIP REP M4
SGT UTIL EQUIP REP M4
SGT PWR GEN EQUIP REP M4
SGT 91J20 QM/CHEM EQ REP M4
SPC 91C10 UTIL EQUIP REP M4
SPC PWR GEN EQUIP REP M4
SPC 91J10 QM/CHEM EQ REP M4
PFC UTIL EQUIP REP M4
X2 PFC 91J10 QM/CHEM EQ REP M4
X2 PFC 91D10 PWR-GEN EQ REP M4

C&E SECTION PARA 07

x2 NVG
AN/VRC-90F



2X NVG
AN/VRC-90F



2X NVG
AN/VRC-90F



2X NVG
AN/VRC-90F



2X NVG
AN/VRC-90F

AN/ASM-147



PU - 802

2X NVG
AN/VRC-90F



PU - 802

CW2 948B0 EL SYS MANT WO M4
CW2 948D0 EL-MSL SYS MNT WO M4
SFC 94W40 EL MAINT SUPV M4
SSG 94A30 LC ELECT MSL SYS FOREMAN M4
SPC 94A10 LC ELECT MSL SYS REP M4
SPC 94A10 LC ELECT MSL SYS REP M4
SPC 94F10 COMP/DET SYS REP M4
SPC 94E10 COMSEC/READIO EQUIP RPR M4
PFC 94A10 LC ELECT MSL SYS REP M249
PFC 94A10 LC ELECT MSL SYS REP M249

ARMAMENT REPAIR SECTION PARA 08

FBCB2
2X NVG
DAGR
AN/VRC-90F



2X NVG
AN/VRC-90F



NSMF

CW2 913A0 ARMAMENT SYS MAINT WO M4
SSG 91K30 ARMT MAINT SUPV M4
SGT91F20 SMALL ARMS/ARTY REP M4
SPC 91G10 FIRE CONTROL REP M4
PFC 91G10 FIRE CONTROL REP M4
PFC 91F10 SMALL ARMS/ARTY REP M4

EQUIPMENT SUMMARY

WEAPONS

LAUNCHER GRENADE: M320A1-----	4
MACHINE GUN 5.56MM M249-----	8
MACHINE GUN LIGHT 5.56MM M249-----	4
MACHINE GUN: CALIBER .50 (M2E2)-----	5
MACHINE GUN GRENADE 40MM MK-19 MOD III-----	1
MACHINE GUN 7.62MM M240B-----	5
PISTOL 9MM AUTOMATIC M9-----	1
RIFLE 5.56MM M4 CARBINE-----	75

VEHICLES, TRAILERS, AND TRLR MTD SYSTEMS

FORWARD REPAIR SYSTEM: M7 (FRS)-----	1
DOLLY SET LIFT TRANSPORTABLE SHELTER: 2 1/2 TON-----	1
GEN SET DIESEL ENGINE TM: 15KW 50/60HZ (PU-802)-----	5
TOOL SET STANDARD AUTOMOTIVE (TRAILER MTD)-----	1
SEMITRAILER VAN: SUPPLY 12T 4 WHL (M129A2C)-----	1
TOOL OUTFIT HYD SYS: TEST & REP 3/4T TLR MTD (HYSTRU)-----	1
TRUCK VAN LMTV (M1079)-----	2
TRUCK UTILITY EXP CAPACITY ENH 4X4: M1152A1-----	7
TRUCK VAN EXPANSIBLE MTV (M1087A1)-----	1
TRUCK UTILITY EXP CAPACITY ENH 4X4: M1165A1-----	4
TRUCK CARGO: MTV (M1083)-----	11
TRUCK CARGO: 4X4 LMTV (M1078)-----	1
TRUCK TRACTOR MTV (M1088)-----	1
TRUCK CARGO MTV LWB (M1085)-----	1
TRUCK WRECKER: TACTICAL 8X8 HEMTT (M984A1)-----	2
TRUCK WRECKER: MTV (M1089)-----	2
TRAILER CARGO: MTV W/ DROPSIDES (M1095)-----	7
TRAILER HIGH MOBILITY 1-1/4T (M1102)-----	1
LIGHT TACTICAL TRAILER: 3/4T (M1101)-----	1
TRUCK CARGO HEMTT LHS (M1120)-----	1
TRAILER CARGO: LMTV W/DROPSIDES (M1082)-----	1
SHOP EQUIPMENT: WELDING TRAILER MTD-----	1
TRAILER TANK WATER (CAMEL) 800 GAL 5 TON-----	1

COMMUNICATION-ELECTRONICS EQUIPMENT

ANTENNA GROUP: OE-254-----	6
COMPUTER SYSTEM DIGITAL: AN/UYQ-90(V)2 (MTS)-----	12
COMP SET DIGITAL: AN/UYK-128(V)3 (FBCB2 BFT APPLIQUE)-----	15
COMPUTER SET DIGITAL: AN/TYQ-109(V)1 (GCSS-A (V)1)-----	1
COMPUTER SYSTEM: DIGITAL AN/TYQ-139 (SAMS-1E V1)-----	4
COMPUTER SYSTEM: DIGITAL AN/TYQ-140 (SAMS/SAMS-1E V2)-----	1
COMPUTER SYSTEM DIGITAL: AN/UYQ-90(V)3 (MTS-CS)-----	2
NAVIGATION SET: SATELLITE SIGNALS AN/PSN-13 (DAGR)-----	15
PROCESSOR GROUP SIGNAL DATA: (CAISI 2.0) OL-701A/TYQ-----	2
RADIAC SET: AN/VDR-2-----	2
RADIO SET: AN/VRC-89F-----	1
RADIO SET: AN/VRC-90F-----	30
RADIO SET: AN/VRC-92F-----	3

NIGHT VISION/OBSERVATION EQUIPMENT

NIGHT VISION GOGGLES: AN/PVS-7B-----	68
SIGHT THERMAL: AN/PAS-13B(V)2 MEDIUM TWS-----	9
SIGHT THERMAL: AN/PAS-13B(V)3 HEAVY TWS-----	6

MISCELLANEOUS EQUIPMENT

DECON APPARATUS LT WT-----	2
GEN SET : DED SKID MTD 3KW 60HZ (MEP-831A)-----	4
GEN SET : DED SKID MTD 10KW 60HZ (MEP-803A)-----	1
ELECTRONICS SHOP SHEL MTD AVIONICS: AN/ASM-146-----	1
ELECTRONICS SHOP SHEL MTD AVIONICS: AN/ASM-147-----	1
SHELTER: NONEXPANDABLE S250-----	3
SHELTER: NONEXPANDABLE S280-----	1
SHOP EQUIPMENT NIGHT SIGHT MAINT FACILITY: (NSMF)-----	1
SET: CONTACT SUPPORT FIGHTING VEHICLE (TOW)-----	1
SHOP EQUIP: CONTACT MAINT ORD/ENGR TRK MTD-----	3

FORWARD SUPPORT COMPANY (BEB), BSB, IBCT

63037R000
4/2/106//138

COMPANY HEADQUARTERS PARA 01

FIELD FEEDING SECTION PARA 02

MISSION: To provide field maintenance including communication equipment and COMSEC equipment, field feeding, transportation and supply support to the Brigade Engineer Battalion.

FBCB2
x2 NVG
DAGR
AN/MRC-149
AN/VRC-92F
AN/UYQ-90(V)2
AN/UYK-128(V)3



CPT 90A00 CDR M4 M9
SPC 92Y10 SUPPLY SP M4

ON-721/V
AN/UYQ-90(V)3
AN/VRC-90F



1LT 88A00 XO M4

DAGR
X3 NVG
AN/GYK-61 (BCS3)
AN/VRC-90F
AN/TYQ-109(V)1
OL-701A/TYQ



1SG 91Z5M 1SG M4
SSG 92Y30 SUPPLY SGT M4

AN/VRC-90F



x2

AN/VRC-90F



x3

ASSAULT
KITCHEN
AK



NOTE: Lift for MTRCS
provided by Distr Sec

SFC 92G40 SR FOOD OPS SGT M4
x2 SSG 92G30 FOOD OPS SGT M4
x2 SGT 92G20 FOOD OPS SGT M4
SGT 92G20 FOOD OPS SGT M4
x7 SPC 92G10 FOOD OPS SPEC M4
x2 PFC 92G10 FOOD OPS SPEC M4
x4 PFC 92G10 FOOD OPS SPEC M4

DISTRIBUTION PLT HQ PARA 03

DISTRIBUTION SECTION PARA 04

MAINTENANCE CONTROL SECTION PARA 05

FBCB2
X2 NVG
DAGR
AN/VRC-92(V)2
AN/UYQ-90(V)3
AN/TYQ-129(V)2



1LT 92A00 PLT LDR M4
SFC 88M40 PLT SGT M4

M240B
2X NVG
DAGR
AN/VRC-90F
MWTS



x3

M240B
2X NVG
DAGR
AN/VRC-90F
MWTS



x3

SSG 88M30 SECTION SGT M4
SGT 88M20 HVY VEH DRIVER M4
SGT 89B20 AMMO SGT M4
SGT 92F20 PETRL HVY VEH OPR M4
SGT 92F20 PETRL HVY VEH OPR M4
SPC 88M10 HVY VEH DRIVER M4
SPC 88M10 HVY VEH DRIVER M249
x4 SPC 92F10 PETRL HVY VEH OPR M4
PFC 88M10 HVY VEH DRIVER M4

FBCB2
x2 NVG
DAGR
AN/VRC-92F



1LT 91A00 MAINT CONT OFF M4
CW2 915A0 AUTO MAINT WO M4
SPC 92A10 EQ REC/PARTS SP M4
PFC 92A10 EQ REC/PARTS SP M4

x2 NVG
DAGR
AN/VRC-90F
KOI-18/TSE



1LT 92A20 EQ REC/PARTS SGT M4
SGT 92A20 EQ REC/PARTS SGT M4
SPC 92A10 EQ REC/PARTS SP M4
PFC 92A10 EQ REC/PARTS SP M4

AN/TYQ-140
x2 NVG
DAGR
OL-701A/TYQ
AN/VRC-89F
OL-713(V)1
x2 AN/TYQ-139



CW3 919A0 ENGR EQUIP MAINT WO M4
SFC 91X40 MAINT MGT NCO M4
SSG 88M30 MASTER DRV TRNR M4
PFC 92A10 EQ REC/PARTS SP M4

PU-802

FORWARD SUPPORT COMPANY (BEB), BSB, IBCT

FIELD MAINTENANCE SECTION PARA 06

x2 NVG
DAGR
AN/VRC-90F
AN/UYK-128(V)3



x2 NVG
AN/VRC-90F
HWTS



x2 NVG
AN/VRC-90F



x2 NVG
DAGR
AN/VRC-90F



x2 NVG
AN/VRC-90F



x2 NVG
DAGR
AN/VRC-90F



SFC 91X40 SECTION SGT M4
X3 SSG 91B30 SR MECH M4
SSG SR CONST EQ REP M4
SSG 91C30 SR UTIL EQ REP M4
SSG 91D30 SR PWR GEN EQ REP M4

SGT 91B20 WH VEH MECH M4
X5 SGT 91B20 WH VEH MECH M4
X2 SGT 91B20 WH VEH MECH M249
SGT 91B20 WH VEH MECH M4
SGT 91B20 REC VEH OPR M4
SGT 91C20 UTIL EQUIP REP M4
SGT 91D20 PWR GEN REP M4
SGT 94F20 SMLL ARMS/ARTY REP M4
X2 SGT 91L20 CONST EQ REP M4

X3 SPC 91B10 WH VEH MECH M4
SPC 91B10 WH VEH MECH M4
X4 SPC 91B10 WH VEH MECH M4
X2 SPC 91B10 WH VEH MECH M4
SPC 91B10 REC VEH OPR M4

SPC 91C10 UTILITIES EQ REP M4
X2 SPC 91D10 PWR-GEN EQP REP M4
SPC 91F10 SMALL ARMS/ARTY REP M4
SPC 91J10 QM/CHEM EQUIP REP M4
X2 SPC 91L10 CONST EQ REP M4
SPC 94F10 COMP/DET SYS REP M4

X2 PFC 91B10 WH VEH MECH M249
X4 PFC 91B10 WH VEH MECH M4
PFC 91B10 WH VEH MECH M4
PFC 91B10 WH VEH MECH M4
X2 PFC 91B10 WH VEH MECH M4
PFC 91B10 WH VEH MECH M4
PFC 91B10 WH VEH MECH M4
X2 PFC 91B10 REC VEH OPR M4
X2 PFC 91C10 UTILITIES EQ REP M4
X2 PFC 91D10 PWR-GEN EQP REP M4
PFC 91F10 SMALL ARMS/ARTY REP M4
X2 PFC 91L10 CONST EQ REP M4

EQUIPMENT SUMMARY

WEAPONS

LAUNCHER GRENADE: M320A1-----	4
MACHINE GUN 5.56MM M249-----	9
MACHINE GUN LIGHT 5.56MM M249-----	4
MACHINE GUN: CALIBER .50 (M2E2)-----	8
MACHINE GUN 7.62MM M240B-----	7
PISTOL 9MM AUTOMATIC M9-----	1
RIFLE 5.56MM M4 CARBINE-----	83

VEHICLES, TRAILERS, AND TRLR MTD SYSTEMS

CONTAINERIZED KITCHEN (CK)-----	1
FORWARD REPAIR SYSTEM: M7 (FRS)-----	1
GEN SET DED TM: 10KW 60HZ (PU-798)-----	1
GEN SET DED TM: 5KW 60HZ (PU-797)-----	1
GEN SET DIESEL ENGINE TM: 15KW 50/60HZ (PU-802)-----	2
SHOP EQUIPMENT: AUTOMOTIVE VEHICLE (TLR MTD) (SATS)-----	1
TRUCK LIFT FORK: DSL DRVN 4000LB CAP ROUGH TERR-----	1
TRUCK UTILITY EXP CAPACITY ENH 4X4: M1152A1-----	8
TRUCK VAN EXPANSIBLE MTV (M1087A1)-----	1
TRUCK UTILITY EXP CAPACITY ENH 4X4: M1165A1-----	3
TRUCK VAN LMTV (M1079)-----	1
TRUCK CARGO: MTV (M1083)-----	9
TRUCK CARGO: 4X4 LMTV (M1078)-----	2
TRUCK CARGO MTV LWB (M1085)-----	1
TRUCK WRECKER: TACTICAL 8X8 HEMTT (M984A1)-----	1
TRAILER: PLS 8X20 (M1076)-----	1
TRUCK WRECKER: MTV (M1089)-----	2
TRAILER CARGO: MTV W/ DROPSIDES (M1095)-----	8
LIGHT TACTICAL TRAILER: 3/4T (M1101)-----	4
TRUCK CARGO HEMTT LHS (M1120)-----	2
SHOP EQUIPMENT: WELDING TRAILER MTD-----	1
TRAILER TANK WATER (CAMEL) 800 GAL 5 TON-----	2

COMMUNICATION-ELECTRONICS EQUIPMENT

ANTENNA GROUP: OE-254-----	4
COMPUTER SYSTEM DIGITAL: AN/UYQ-90(V)2 (MTS)-----	32
COMP SET DIGITAL: AN/UYK-128(V)3 (FBCB2 BFT APPLIQUE)-----	5
BTL CMD SUSTAINMENT SPT SYSTEM: AN/GYK-61 (BCS3)-----	1
COMPUTER SYS DIGITAL: AN/TYQ-129(V)2 (TC-AIMS II WS)-----	1
COMPUTER SET DIGITAL: AN/TYQ-109(V)1 (GCSS-A (V)1)-----	1
COMPUTER SYSTEM: DIGITAL AN/TYQ-139 (SAMS-1E V1)-----	3
COMPUTER SYSTEM: DIGITAL AN/TYQ-140 (SAMS/SAMS-1E V2)-----	1
COMPUTER SYSTEM DIGITAL: AN/UYQ-90(V)3 (MTS-CS)-----	2
INTERCONNECTING GROUP: ON-721/V-----	1
TERM SAT COMMS : AN/TSC-183: (OL-713(V)1/TYQ CSS VSAT)-----	1
NAVIGATION SET: SATELLITE SIGNALS AN/PSN-13 (DAGR)-----	21
PROCESSOR GROUP SIGNAL DATA: (CAISI 2.0) OL-701A/TYQ-----	2
RADIAC SET: AN/VDR-2-----	3
RADIO SET: AN/VRC-89F-----	1
RADIO SET: AN/VRC-90F-----	50
RADIO SET: AN/VRC-92F-----	3
COMMS SYSTEM AN/MRC-149 (SOLDIER NETWORK EXTENSION)-----	1

NIGHT VISION/OBSERVATION EQUIPMENT

DRIVERS VISION ENHANCER: AN/VAS-5-----	12
NIGHT VISION GOGGLES: AN/PVS-7B-----	92
MEDIUM THERMAL WEAPONS SIGHT: AN/PAS-13(V2)-----	14
HEAVY THERMAL WEAPONS SIGHT: AN/PAS-13(V3)-----	12

MISCELLANEOUS EQUIPMENT

ASSAULT KITCHEN (AK)-----	4
BED CARGO: DEMOUNTABLE PLS 8X20-----	1
GEN SET : DED SKID MTD 3KW 60HZ (MEP-831A)-----	3
GEN SET DIESEL: 60HZ AC MEP-531A-----	1
GEN SET: DED SKID MTD 10KW 60HZ (MEP-803A)-----	2
ELECTRONICS SHOP SHEL MTD AVIONICS: AN/ASM-146-----	1
MULTI-TEMP REFRIGERATED CONTAINER SYS: MTRCS-----	1
SHOP EQUIP: CONTACT MAINT ORD/ENGR TRK MTD-----	3

FORWARD SUPPORT COMPANY

(CAV), BSB, IBCT

63037R200
3/1/72/ 76

COMPANY HEADQUARTERS PARA 01

FIELD FEEDING SECTION PARA 02

MISSION: To provide field maintenance including communication equipment and COMSEC equipment, field feeding, transportation and supply support to the Cavalry Squadron, IBCT.

AN/UYQ-90(V)2
FBCB2
2X NVG
DAGR
AN/VRC-92F
HWTS

AN/GYK-61
AN/UYQ-90(V)3
ON-721/V
OL-701Z/TYQ



CPT 90A00 CDR M4 M9
SPC 92Y10 SUPPLY SP M4

2X NVG
DAGR
AN/VRC-90F
HWTS
.50 CAL

AN/TYQ-109(V)1



1LT 88A00 EXEC OFF M4
1SG 91Z5M 1SG M4
SGT 92Y20 SUPPLY NCO M4

2X NVG
DAGR
AN/VRC-90F



x3

2X NVG
AN/VRC-90F



2X NVG
DAGR
AN/VRC-90F



2X NVG
AN/VRC-90F



SFC 92G40 SR FOOD OPNS SGT M4
SSG 92G30 FOOD OPNS SGT M4
SGT 92G20 FOOD OPNS SGT M4
SGT 92G20 FOOD OPNS SGT M4
X3 SPC 92G10 FOOD OPS SP M4
SPC 92G10 FOOD OPS SP M4
SPC 92G10 FOOD OPS SP M4
PFC 92G10 FOOD OPS SP M249
PFC 92G10 FOOD OPS SP M249
PFC 92G10 FOOD OPS SP M249

DISTRIBUTION PLT HQ PARA 03

DISTRIBUTION SECTION PARA 04

MAINTENANCE CONTROL SECTION PARA 05

FBCB2
AN/UYQ-90(V)3
2X NVG
DAGR
AN/VRC-92(V)2

AN/TYQ-129(V)2



1LT 92A00 PLT LDR M4
SFC 88M40 PLT SGT M4

M240B
2X NVG
DAGR
AN/VRC-90F
MWTS



x3

M240B
2X NVG
DAGR
AN/VRC-90F
MWTS



x3

SSG 88M30 SECTION SGT M4
SGT 88M20 HVY VEH DRIVER M4
SGT 89B20 AMMO SGT M4
SGT 92F20 PETRL HVY VEH OPR M4
SGT 92F20 PETRL HVY VEH OPR M4

X2 SPC 88M10 HVY VEH DRIVER M4
SPC 88M10 HVY VEH DRIVER M249
x4 SPC 92F10 PETRL HVY VEH OPR M4
PFC 88M10 HVY VEH DRIVER M4
PFC 88M10 HVY VEH DRIVER M4

FBCB2
x2 NVG
DAGR
AN/VRC-92F



1LT 91A00 MAINT CONT OFF M4
SSG 88M30 MASTER DRV TRNR M4
SPC 92A10 EQ REC/PARTS SP M4
PFC 92A10 EQ REC/PARTS SP M4

x2 NVG
DAGR
AN/VRC-90F
KOI-18/TSE



CW2 915A0 AUTO MAINT WO M4
SGT 92A20 EQ REC/PARTS SGT M4
SPC 92A10 EQ REC/PARTS SP M4
PFC 92A10 EQ REC/PARTS SP M4

AN/TYQ-140
x2 NVG
DAGR
OL-701A/TYQ
AN/VRC-89F
OL-713(V)1
x2 AN/TYQ-139



SFC 91X40 MAINT MGT NCO M4
SGT 92A20 EQ REC/PARTS SGT M4
PFC 92A10 EQ REC/PARTS SP M4

FORWARD SUPPORT COMPANY (CAV), BSB, IBCT

FIELD MAINTENANCE SECTION PARA 06

x2 NVG
DAGR
AN/VRC-90F
AN/UYSK-128(V)3



x2 NVG
AN/VRC-90F
HWTS



x2 NVG
AN/VRC-90F



x2 NVG
DAGR
AN/VRC-90F



PU - 802

x2 NVG
AN/VRC-90F



x2 NVG
DAGR
AN/VRC-90F



x2

SFC 91X40 SECTION SGT M4
X2 SSG 91B30 SR MECH M4

X2 SGT 91B20 WH VEH MECH M4
X2 SGT 91B20 WH VEH MECH M249
SGT 91B20 REC VEH OPR M4
SGT 91C20 UTIL EQUIP REP M4
SGT 91D20 PWR GEN REP M4
SGT 94F20 SMLL ARMS/ARTY REP M4

X2 SPC 91B10 WH VEH MECH M4
SPC 91B10 WH VEH MECH M4
X2 SPC 91B10 WH VEH MECH M4
SPC 91B10 REC VEH OPR M4
SPC 91J10 QM/CHEM EQUIP REP M4
SPC 91L10 CONST EQ REP M4
SPC 94F10 COMP/DET SYS REP M4

PFC 91B10 WH VEH MECH M249
X2 PFC 91B10 WH VEH MECH M4
PFC 91B10 WH VEH MECH M4
PFC 91B10 WH VEH MECH M4
X2 PFC 91B10 WH VEH MECH M4
PFC 91B10 REC VEH OPR M4
PFC 91C10 UTILITIES EQ REP M4
X2 PFC 91D10 PWR-GEN EQP REP M4
PFC 91F10 SMALL ARMS/ARTY REP M4

EQUIPMENT SUMMARY

WEAPONS

LAUNCHER GRENADE: M320A1	4
MACHINE GUN 5.56MM M249	9
MACHINE GUN LIGHT 5.56MM M249	4
MACHINE GUN: CALIBER .50 (M2E2)	1
MACHINE GUN 7.62MM M240B	7
PISTOL 9MM AUTOMATIC M9	1
RIFLE 5.56MM M4 CARBINE	76

VEHICLES, TRAILERS, AND TRLR MTD SYSTEMS

CONTAINERIZED KITCHEN (CK)	1
FORWARD REPAIR SYSTEM: M7 (FRS)	1
GEN SET DED TM: 10KW 60HZ (PU-798)	1
GEN SET DED TM: 5KW 60HZ (PU-797)	1
GEN SET DIESEL ENGINE TM: 15KW 50/60HZ (PU-802)	2
SHOP EQUIPMENT: AUTOMOTIVE VEHICLE (TLR MTD) (SATS)	1
TRUCK LIFT FORK: DSL DRVN 4000LB CAP ROUGH TERR	1
TRUCK UTILITY EXP CAPACITY ENH 4X4: M1152A1	8
TRUCK VAN EXPANSIBLE MTV (M1087A1)	1
TRUCK UTILITY EXP CAPACITY ENH 4X4: M1165A1	3
TRUCK VAN LMTV (M1079)	1
TRUCK CARGO: MTV (M1083)	9
TRUCK CARGO: 4X4 LMTV (M1078)	2
TRUCK CARGO MTV LWB (M1085)	1
TRUCK WRECKER: TACTICAL 8X8 HEMTT (M984A1)	1
TRAILER: PLS 8X20 (M1076)	1
TRUCK WRECKER: MTV (M1089)	2
TRAILER CARGO: MTV W/ DROPSIDES (M1095)	8
LIGHT TACTICAL TRAILER: 3/4T (M1101)	4
TRUCK CARGO HEMTT LHS (M1120)	2
SHOP EQUIPMENT: WELDING TRAILER MTD	1
TRAILER TANK WATER (CAMEL) 800 GAL 5 TON	2

COMMUNICATION-ELECTRONICS EQUIPMENT

ANTENNA GROUP: OE-254	4
COMPUTER SYSTEM DIGITAL: AN/UYSK-90(V)2 (MTS)	32
COMP SET DIGITAL: AN/UYSK-128(V)3 (FBCB2 BFT APPLIQUE)	5
BTL CMD SUSTAINMENT SPT SYSTEM: AN/GYK-61 (BCS3)	1
COMPUTER SYS DIGITAL: AN/TYQ-129(V)2 (TC-AIMS II WS)	1
COMPUTER SET DIGITAL: AN/TYQ-109(V)1 (GCSS-A (V)1)	1
COMPUTER SYSTEM: DIGITAL AN/TYQ-139 (SAMS-1E V1)	3
COMPUTER SYSTEM: DIGITAL AN/TYQ-140 (SAMS/SAMS-1E V2)	1
COMPUTER SYSTEM DIGITAL: AN/UYSK-90(V)3 (MTS-CS)	2
INTERCONNECTING GROUP: ON-721/V	1
TERM SAT COMMS : AN/TSC-183: (OL-713(V)1/TYQ CSS VSAT)	1
NAVIGATION SET: SATELLITE SIGNALS AN/PSN-13 (DAGR)	21
PROCESSOR GROUP SIGNAL DATA: (CAISI 2.0) OL-701A/TYQ	2
RADIAC SET: AN/VDR-2	3
RADIO SET: AN/VRC-89F	1
RADIO SET: AN/VRC-90F	50
RADIO SET: AN/VRC-92F	3
COMMS SYSTEM AN/MRC-149 (SOLDIER NETWORK EXTENSION)	1

NIGHT VISION/OBSERVATION EQUIPMENT

DRIVERS VISION ENHANCER: AN/VAS-5	12
NIGHT VISION GOGGLES: AN/PVS-7B	92
MEDIUM THERMAL WEAPONS SIGHT: AN/PAS-13(V2)	14
HEAVY THERMAL WEAPONS SIGHT: AN/PAS-13(V3)	12

MISCELLANEOUS EQUIPMENT

ASSAULT KITCHEN (AK)	4
BED CARGO: DEMOUNTABLE PLS 8X20	1
GEN SET : DED SKID MTD 3KW 60HZ (MEP-831A)	3
GEN SET DIESEL: 60HZ AC MEP-531A	1
GEN SET: DED SKID MTD 10KW 60HZ (MEP-803A)	2
ELECTRONICS SHOP SHEL MTD AVIONICS: AN/ASM-146	1
MULTI-TEMP REFRIGERATED CONTAINER SYS: MTRCS	1
SHOP EQUIP: CONTACT MAINT ORD/ENGR TRK MTD	3

FORWARD SUPPORT COMPANY

(IN BN), BSB, IBCT

63037R000
4/174/179

COMPANY HEADQUARTERS PARA 01

FIELD FEEDING SECTION PARA 02

MISSION: To provide field maintenance including communication equipment and COMSEC equipment, field feeding, transportation and supply support to the Infantry Battalion.

FBCB2
x2 NVG
DAGR
AN/MRC-149
AN/VRC-92F
AN/UYQ-90(V)2
AN/UYK-128(V)3



CPT 90A00 CDR M4 M9
SPC 92Y10 SUPPLY SP M4

ON-721/V
AN/UYQ-90(V)3
AN/VRC-90F



1LT 88A00 XO M4

DAGR
X3 NVG
AN/GYK-61 (BCS3)
AN/VRC-90F
AN/TYQ-109(V)1
OL-701A/TYQ



1SG 91Z5M 1SG M4
SSG 92Y30 SUPPLY SGT M4

AN/VRC-90F



x2

AN/VRC-90F



x3

ASSAULT
KITCHEN
AK



MTRCS
NOTE: Lift for MTRCS provided by Distr Sec

SFC 92G40 SR FOOD OPS SGT M4
x2 SSG 92G30 FOOD OPS SGT M4
x2 SGT 92G20 FOOD OPS SGT M4
SGT 92G20 FOOD OPS SGT M4
X7 SPC 92G10 FOOD OPS SPEC M4
x2 PFC 92G10 FOOD OPS SPEC M4
x4 PFC 92G10 FOOD OPS SPEC M4

DISTRIBUTION PLT HQ PARA 03

DISTRIBUTION SECTION PARA 04

MAINTENANCE CONTROL SECTION PARA 05

FBCB2
X2 NVG
DAGR
AN/VRC-92(V)2
AN/UYQ-90(V)3
AN/TYQ-129(V)2



1LT 92A00 PLT LDR M4
SFC 88M40 PLT SGT M4

M240B
2X NVG
DAGR
AN/VRC-90F
MWTS



x3

M240B
2X NVG
DAGR
AN/VRC-90F
MWTS



x3

SSG 88M30 SECTION SGT M4
SGT 88M20 HVY VEH DRIVER M4
SGT 89B20 AMMO SGT M4
SGT 92F20 PETRL HVY VEH OPR M4
SGT 92F20 PETRL HVY VEH OPR M4
SPC 88M10 HVY VEH DRIVER M4
SPC 88M10 HVY VEH DRIVER M249
x4 SPC 92F10 PETRL HVY VEH OPR M4
PFC 88M10 HVY VEH DRIVER M4

FBCB2
x2 NVG
DAGR
AN/VRC-92F



1LT 91A00 MAINT CONT OFF M4
SSG 88M30 MASTER DRV TRNR M4
SPC 92A10 EQ REC/PARTS SP M4
PFC 92A10 EQ REC/PARTS SP M4

AN/TYQ-140
x2 NVG
DAGR
OL-701A/TYQ
AN/VRC-89F
OL-713(V)1
x2 AN/TYQ-139



SFC 91X40 MAINT MGT NCO M4
PFC 92A10 EQ REC/PARTS SP M4

x2 NVG
DAGR
AN/VRC-90F
KOI-18/TSEC



CW2 915A0 AUTO MAINT WO M4
SGT 92A20 EQ REC/PARTS SGT M4
SGT 92A20 EQ REC/PARTS SGT M4
SPC 92A10 EQ REC/PARTS SP M4
PFC 92A10 EQ REC/PARTS SP M4

FORWARD SUPPORT COMPANY (IN), BSB, IBCT

FIELD MAINTENANCE SECTION PARA 09

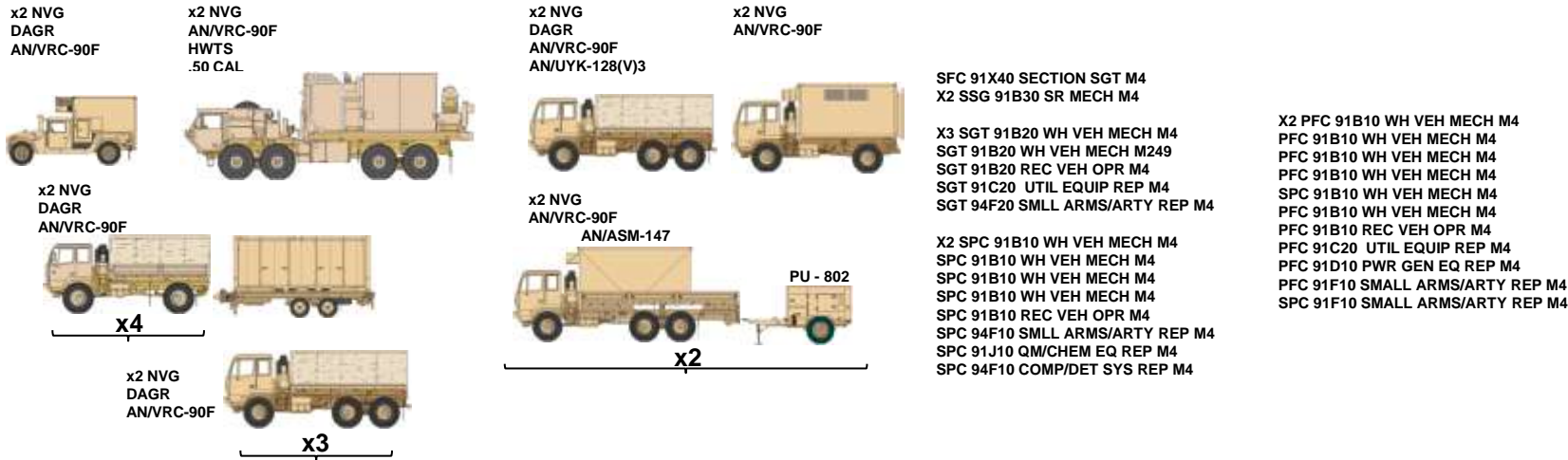

EQUIPMENT SUMMARY

WEAPONS

LAUNCHER GRENADE: M320A1	4
MACHINE GUN 5.56MM M249	9
MACHINE GUN LIGHT 5.56MM M249	4
MACHINE GUN: CALIBER .50 (M2E2)	8
MACHINE GUN 7.62MM M240B	7
PISTOL 9MM AUTOMATIC M9	1
RIFLE 5.56MM M4 CARBINE	79

VEHICLES, TRAILERS, AND TRLR MTD SYSTEMS

CONTAINERIZED KITCHEN (CK)	1
FORWARD REPAIR SYSTEM: M7 (FRS)	1
GEN SET DED TM: 10KW 60HZ (PU-798)	1
GEN SET DED TM: 5KW 60HZ (PU-797)	1
GEN SET DIESEL ENGINE TM: 15KW 50/60HZ (PU-802)	2
SHOP EQUIPMENT: AUTOMOTIVE VEHICLE (TLR MTD) (SATS)	1
TRUCK LIFT FORK: DSL DRVN 4000LB CAP ROUGH TERR	1
TRUCK UTILITY EXP CAPACITY ENH 4X4: M1152A1	8
TRUCK VAN EXPANSIBLE MTV (M1087A1)	1
TRUCK UTILITY EXP CAPACITY ENH 4X4: M1165A1	3
TRUCK VAN LMTV (M1079)	1
TRUCK CARGO: MTV (M1083)	9
TRUCK CARGO: 4X4 LMTV (M1078)	2
TRUCK CARGO MTV LWB (M1085)	1
TRUCK WRECKER: TACTICAL 8X8 HEMTT (M984A1)	1
TRAILER: PLS 8X20 (M1076)	1
TRUCK WRECKER: MTV (M1089)	2
TRAILER CARGO: MTV W/ DROPSIDES (M1095)	8
LIGHT TACTICAL TRAILER: 3/4T (M1101)	4
TRUCK CARGO HEMTT LHS (M1120)	2
SHOP EQUIPMENT: WELDING TRAILER MTD	1
TRAILER TANK WATER (CAMEL) 800 GAL 5 TON	2

COMMUNICATION-ELECTRONICS EQUIPMENT

ANTENNA GROUP: OE-254	4
COMPUTER SYSTEM DIGITAL: AN/JYQ-90(V)2 (MTS)	32
COMP SET DIGITAL: AN/UYK-128(V)3 (FBCB2 BFT APPLIQUE)	5
BTL CMD SUSTAINMENT SPT SYSTEM: AN/GYK-61 (BCS3)	1
COMPUTER SYS DIGITAL: AN/TYQ-129(V)2 (TC-AIMS II WS)	1
COMPUTER SET DIGITAL: AN/TYQ-109(V)1 (GCSS-A (V)1)	1
COMPUTER SYSTEM: DIGITAL AN/TYQ-139 (SAMS-1E V1)	3
COMPUTER SYSTEM: DIGITAL AN/TYQ-140 (SAMS/SAMS-1E V2)	1
COMPUTER SYSTEM DIGITAL: AN/JYQ-90(V)3 (MTS-CS)	2
INTERCONNECTING GROUP: ON-721/N	1
TERM SAT COMMS: AN/TSC-183: (OL-713(V)1/TYQ CSS VSAT)	1
NAVIGATION SET: SATELLITE SIGNALS AN/PSN-13 (DAGR)	21
PROCESSOR GROUP SIGNAL DATA: (CAISI 2.0) OL-701A/TYQ	2
RADIAC SET: AN/VDR-2	3
RADIO SET: AN/VRC-89F	1
RADIO SET: AN/VRC-90F	50
RADIO SET: AN/VRC-92F	3
COMMS SYSTEM AN/MRC-149 (SOLDIER NETWORK EXTENSION)	1

NIGHT VISION/OBSERVATION EQUIPMENT

DRIVERS VISION ENHANCER: AN/VAS-5	12
NIGHT VISION GOGGLES: AN/PVS-7B	92
MEDIUM THERMAL WEAPONS SIGHT: AN/PAS-13(V2)	14
HEAVY THERMAL WEAPONS SIGHT: AN/PAS-13(V3)	12

MISCELLANEOUS EQUIPMENT

ASSAULT KITCHEN (AK)	4
BED CARGO: DEMOUNTABLE PLS 8X20	1
GEN SET : DED SKID MTD 3KW 60HZ (MEP-831A)	3
GEN SET DIESEL: 60HZ AC MEP-531A	1
GEN SET: DED SKID MTD 10KW 60HZ (MEP-803A)	2
ELECTRONICS SHOP SHEL MTD AVIONICS: AN/ASM-146	1
MULTI-TEMP REFRIGERATED CONTAINER SYS: MTRCS	1
SHOP EQUIP: CONTACT MAINT ORD/ENGR TRK MTD	3

FORWARD SUPPORT COMPANY

(FA), BSB, IBCT

63337R500
4/1/96// 101

COMPANY HEADQUARTERS PARA 01

FIELD FEEDING SECTION PARA 02

MISSION: To provide field maintenance including communication equipment and COMSEC equipment, field feeding, transportation and supply support to the Fires Battalion (IBCT).

AN/UYQ-90(V)2
FBCB2
x2 NVG
DAGR
AN/VRC-92F

AN/UYQ-90(V)3
KG-175
OM-721/V
x2 M240
x2 MWTS
KOI-18/TSEC
HWTS
.50 CAL



CPT 90A00 CDR M4 M9
SPC 92Y10 SUPPLY SP M4

x2 NVG
DAGR
AN/GYK-61
HWTS
AN/VRC-90F
OL-701A/TYQ
AN/TYQ-109(V)1



1LT 88A00 EXEC OFF M4
1SG 91Z5M 1SG M4
SSG 92Y30 SUPPLY SGT M4

PU-797

DAGR
AN/VRC-90F



AN/VRC-90F



AN/VRC-90F

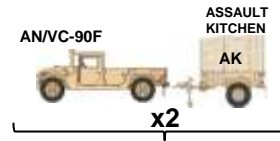

SFC 92G40 SR FOOD OPS SGT M4
SSG 92G30 FOOD OPS SGT M4
SGT 92G20 FOOD OPS SGT M4
X2 SGT 92G20 FOOD OPS SGT M4

X5 SPC 92G10 FOOD OPS SP M4
SPC 92G10 FOOD OPS SP M4
PFC 92G10 FOOD OPS SP M4
X3 PFC 92G10 FOOD OPS SP M4

DISTRIBUTION PLT HQ PARA 03

DISTRIBUTION SECTION PARA 04

MAINTENANCE CONTROL SECTION PARA 05

FBCB2
AN/UYQ-90(V)3
2X NVG
DAGR
AN/VRC-92(V)2

AN/TYQ-129(V)2



1LT 92A00 PLT LDR M4
SFC 88M40 PLT SGT M4
SPC 92A10 MAT CON/ACCTG SP M4

PU - 798

M240B
2X NVG
DAGR
AN/VRC-90F
MWTS



x3

M240B
2X NVG
DAGR
AN/VRC-90F
MWTS

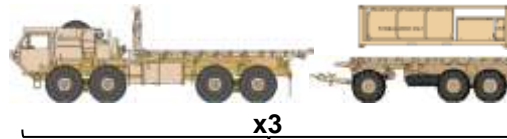

x3

SSG 88M30 SECTION SGT M4
SGT 88M20 HVY VEH DRIVER M4
SGT 88M20 HVY VEH DRIVER M4
SGT 88M20 HVY VEH DRIVER M4
SGT 89B20 AMMO SGT M4
SGT 92F20 PETRL HVY VEH OPR M4

SPC 88M10 HVY VEH DRIVER M4
SPC 88M10 HVY VEH DRIVER M4
SPC 88M10 HVY VEH DRIVER M249
x4 SPC 92F10 PETRL HVY VEH OPR M4
PFC 88M10 HVY VEH DRIVER M4

FBCB2
x2 NVG
DAGR
AN/VRC-92F



1LT 91A00 MAINT CONT OFF M4
SSG 88M30 MASTER DRV TRNR M4
SPC 92A10 EQ REC/PARTS SP M4
PFC 92A10 EQ REC/PARTS SP M4

x2 NVG
DAGR
AN/VRC-90F
KOI-18/TSEC



CW2 915A0 AUTO MAINT WO M4
SGT 92A20 EQ REC/PARTS SGT M4
SPC 92A10 EQ REC/PARTS SP M4
PFC 92A10 EQ REC/PARTS SP M4

AN/TYQ-140
x2 NVG
DAGR
OL-701A/TYQ
AN/VRC-89F
OL-713(V)1
x2 AN/TYQ-139



SFC 91X40 MAINT MGT NCO M4
SGT 92A20 EQ REC/PARTS SGT M4
PFC 92A10 EQ REC/PARTS SP M4

PU-802

FORWARD SUPPORT COMPANY (FA), BSB, IBCT

FIELD MAINTENANCE SECTION PARA 06

x2 NVG
AN/VRC-90F



x2 NVG
AN/VRC-90F



x2 NVG
DAGR
AN/VRC-90F



x2 NVG
HWTS
.50 CAL



x2 NVG
DAGR
AN/VRC-90F



x2 NVG
DAGR
AN/VRC-90F



SFC 91X40 SECTION SGT M4
X2 SSG 91B30 SR MECH M4
SSG 91B30 SR MECH M4
SSG 91D30 SR PWR-GEN REP M4

X4 SGT 91B20 WH VEH MECH M4
X3 SGT 91B20 WH VEH MECH M249
SGT 91B20 WH VEH MECH M4
SGT 91B20 REC VEH OPR M4
SGT 91C20 UTIL EQUIP REP M4
SGT 91D20 PWR GEN EQ REP M4
SGT 94F20 SMLL ARMS/ARTY REP M4

X3 SPC 91B10 WH VEH MECH M4
SPC 91B10 WH VEH MECH M4
X3 SPC 91B10 WH VEH MECH M4
SPC 91B10 WH VEH MECH M4
SPC 91B10 WH VEH MECH M4
SPC 91B10 REC VEH OPR M4

SPC 91C10 UTIL EQUIP REP M4
SPC 91D10 PWR GEN EQ REP M4
SPC 94F10 SMLL ARMS/ARTY REP M4
SPC 94F10 SMLL ARMS/ARTY REP M4
SPC 91J10 QM/CHEM EQ REP M4
SPC 94F10 COMP/DET SYS REP M4

PFC 91B10 WH VEH MECH M4
X3 PFC 91B10 WH VEH MECH M4
X3 PFC 91B10 WH VEH MECH M4
PFC 91B10 WH VEH MECH M4
PFC 91B10 WH VEH MECH M4
PFC 91B10 WH VEH MECH M4
PFC 91B10 WH VEH MECH M4

PFC 91B10 REC VEH OPR M4
PFC 91C10 UTIL EQUIP REP M4
PFC 91C10 UTIL EQUIP REP M4
X2 PFC 91D10 PWR GEN EQ REP M4
PFC 91F10 SMALL ARMS/ARTY REP M4
SPC 91F10 SMALL ARMS/ARTY REP M4

RADAR REPAIR TEAM PARA 07

x2 NVG
AN/VRC-90F



SGT 94M20 RADAR REPAIRER M4
PFC 91D10 PWR-GEN EQ REP M4
SPC 94M10 RADAR REPAIRER M4

EQUIPMENT SUMMARY

WEAPONS

L69080	LAUNCHER GRENADE: M320A1	4
M09009	MACHINE GUN 5.56 MILLIMETER: M249	9
M39263	MACHINE GUN: LIGHT 5.56MM M249	4
M92841	MACHINE GUN: 7.62MM M240B	7
P98152	PISTOL 9MM AUTOMATIC: M9	1
R97234	RIFLE 5 56 MILLIMETER: M4	77
Z00686	MACHINE GUN: CALIBER .50	5

VEHICLES, TRAILERS AND TRLR MTD SYSTEMS

A94943	ASSAULT KTCHN: (AK)	2
C27633	CONTAINERIZED KITCHEN: CK	1
F64544	FORWARD: REPAIR SYSTEM (FRS)	1
G53778	GENERATOR SET DIESEL ENGINE TM: PU-802	3
S25681	SHOP EQUIP: CONTACT MAINT ORD/ENG TRUCK MOUNTING	3
T37588	TRUCK UTILITY EXPANDED CAPACITY ENHANCED: M1152A1	6
T41135	TRUCK CARGO: MTV W/E W/W	1
T41271	TRUCK VAN: EXPANSIBLE MTV W/E M1087A1	1
T49255	TRUCK LIFT FORK: DSL DRVN 4000 LB CAP ROUGH TERRAIN	1
T56383	TRUCK UTILITY EXPANDED CAPACITY ENHANCED 4X4: M1165A1	2
T60081	TRUCK CARGO: 4X4 LMTV W/E	1
T61704	TRUCK CARGO: MTV LWB W/E	2
T61908	TRUCK CARGO: MTV W/E	7
T63093	TRUCK WRECKER: TAC 8X8 HVY EXPANDED MOBILITY W/WINCH	1
T93484	TRUCK VAN: LMTV W/E	1
T93761	TRAILER: PALLETIZED LOADING 8X20	3
T94709	TRUCK WRECKER: MTV W/E W/W	2
T95555	TRAILER CARGO: MTV W/DROPSIDES M1095	4
T95992	LIGHT TACTICAL TRAILER: 3/4 TON	2
T96496	TRUCK CARGO: TACTICAL 8X8 HEAVY EXPANDED MOB W/LHS	7
T96564	TRAILER FLAT BED: M1082 TRLR CARGO LMTV W/DROPSIDES	1
Z00206	MULTI-TEMPERATURE REFRIGTD CONTAINER SYSTEM: MTRCS	1
Z00514	MODULAR FUEL SYSTEM - TANKRACK MODULE:	3
Z01404	TRAILER-MTD: PU-2101/ 15 KW/ 50/60HZ/ M200A1	3
Z01414	LTT TRAILER-MTD: PU-2002/ 10 KW/ 50/60HZ	1
Z01420	LTT TRAILER-MTD: PU-2001/ 5 KW/ 50/60HZ	1
Z36683	TRAILER TANK WATER (CAMEL): 800 GAL 5 TON W/E	2

NIGHT VISION/OBSERVATION

D41659	DRIVERS ENHANCERS: AN/VAS-5	6
N05482	NIGHT VISION: GOGGLE	63
S90535	MEDIUM WEAPON THERMAL SIGHT (MWTS): AN/PAS-13(V)2	11
S90603	HEAVY WEAPON THERMAL SIGHT (HWTS): AN/PAS-13(V)3	5

COMMUNICATIONS AND ELECTRONICS

C18278	COMPUTER SYSTEM: DIGITAL AN/UYYQ-90(V)2	11
C18378	COMPUTER SET: AN/JYK-128(V)3	2
C18448	COMPUTER SYSTEM: DIGITAL AN/GYK-61	2
C27435	COMPUTER SYSTEM: DIGITAL AN/TYQ-129(V)2	1
C27707	COMPUTER SYSTEM: DIGITAL AN/TYQ-109(V)1	1
C67686	COMPUTE SYSTEM: DIGITAL AN/TYQ-140	1
C78851	COMPUTER SYSTEM: DIGITAL AN/UYYQ-90(V)3	2
H01907	ELECTRONIC SHOP SHELTER MOUNTED AVIONICS: AN/ASM-146 LESS POWER	2
J54771	INTERCONNECT GROUP: ON-721/V	1
N96248	NAVIGATION SET: SATELLITE SIGNALS AN/PSN-13	21
P99881	PROCESSOR GROUP SIG DATA: (CAISI 2.0) OL-701A/TYQ	2
R36178	RADIO TEST: SET AN/GRM-122	1
R45543	RADIO SET: AN/VRC-92F(C)	3
R68044	RADIO SET: AN/VRC-90F(C)	27
T40405	TAPE READER GENERAL PURPOSE: KOI-18/TSEC	2
Z00384	COMPUTER SYSTEM DIGITAL: AN/PYQ-10(C)	24
Z00560	INTERFACE UNIT COMMUNICATION EQUIPMENT: OL-713(V)1/TYQ CSS VSAT	1
Z01162	COMPUTER SYSTEM: DIGITAL AN/TYQ-139	4

MISC EQUIPMENT

C05701	MONITOR CHEMICAL AGENT:	1
D03932	DETECTING SET: MINE AN/PSS-14	2
G11966	GEN SET: DED SKID MTD 5KW 60HZ	1
G18358	GEN SET: DED SKID MTD 3KW 60HZ	4
G74711	GEN SET: DED SKID MTD 10KW 60HZ	2
J00697	JOINT CHMCL AGENT: DETECTOR	4
M12986	MASK CHEM BIO JOINT SERVICE GEN PURPOSE: FIELD M50	86
R20684	RADIAC SET: AN/VDR-2	4
R30925	RADIAC SET: AN/PDR-75	1
R30993	RADIAC SET: AN/PDR-77()	1
R31061	RADIAC SET: AN/UDR-13	10
Z01328	GEN SET DED 5KW 50/60HZ: SKID-MTD	1
Z01330	GEN SET DED 10KW 50/60HZ: SKID-MTD	2

MEDICAL COMPANY, BSB, IBCT

08037R000
15/0/67// 82

MISSION: To provide Echelon II medical care to supported maneuver battalions with organic medical platoons. This company provides both Echelons I and II medical treatment on an area basis to those units without organic medical assets operating in the brigade support area (BSA).

COMPANY HEADQUARTERS PARA 01

FBCB2 KOI-18/TSEC
ANUYQ-90(V)2
2X NVG
DAGR
EPLRS
AN/VRC-89F
ANUYK-128(V)1



FBCB2 AN/TYQ-107(V)1
2X NVG AN/TYQ-108(V)3
DAGR AN/TYQ-109(V)1
EPLRS OL-701A/TYQ
AN/VRC-90F



2X NVG
DAGR
EPLRS
AN/VRC-89F



2X NVG
DAGR
EPLRS
AN/VRC-89F
X4 AN/PYQ-10(C)



MAJ 05A00 CDR M4 M9
CPT 70B67 EXEC OFF M4
1SG 68W5M 1SG M4
SGT 92Y20 SUPPLY NCO M4
SPC 92Y10 SUPPLY SP M4
SPC 74D10 CBRN DECON SP M4

PREVENTIVE MED SECTION PARA 02

FBCB2 AN/TYQ-107(V)1
2X NVG AN/TYQ-105(V)1
DAGR
EPLRS
AN/VRC-90F(C)



1LT 72D67 ENVIR SCIENCE OFF M4
SGT 68S20 PREVENTIVE MED NCO M4

MENTAL HEALTH SECTION PARA 03

FBCB2 AN/TYQ-107(V)1
2X NVG 2X AN/TYQ-106(V)1
DAGR AN/TYQ-105(V)1
EPLRS
AN/VRC-90F



CPT 67D00 BEHAVIORAL SCI OFF M4
CPT 67D00 BEHAVIORAL SCI OFF M4
SGT 68X20 BEHAVIORAL HLTH NCO M4
SPC 68X10 BEHAVIORAL HLTH SP M4

MED TREATMENT PLT HQ PARA 04

FBCB2 2X AN/TYQ-107(V)2
2X NVG AN/TYQ-107(V)1
DAGR AN/TYQ-106(V)1
EPLRS 2X AN/TYQ-105(V)1
AN/VRC-90F OL-701A/TYQ



2X NVG DAGR
AN/VRC-90F
ANUYK-128
AN-UYQ-90(V)2



MAJ 62B00 PLT LDR (IHHC, IN BN)
1LT 70B67 FLD MED ASST M4
SFC 68W40 PLT SGT M4
SPC 68G10 PAT ADMIN SP M4

MEDICAL TREATMENT SQUAD PARA 05

FBCB2 2X NVG
DAGR EPLRS
AN/VRC-89F
ANUYK-128(V)1



FBCB2 2X NVG
DAGR EPLRS
AN/VAS-5 AN/VRC-89F
OL-701/TYQ
AN/PYQ-10(C)
AN/TYQ-106(V)1
ANUYK-128(V)1



x2

CPT 62B00 FLD SURGEON M9 AN/TYQ-105(V)1
CPT 65D00 PHYSICIAN ASST M9 AN/TYQ-105(V)1
SSG 68W30 HLTH CARE SGT M4 AN/TYQ-105(V)1
SGT 68W20 HLTH CARE SGT M4 AN/TYQ-105(V)1
SGT 68W20 HLTH CARE SGT M4 AN/TYQ-105(V)1
SPC 68W10 HLTH CARE SP M4 AN/TYQ-105(V)1
PFC 68W10 HLTH CARE SP M4 AN/TYQ-105(V)1
PFC 68W10 HLTH CARE SP M4 AN/TYQ-105(V)1

AREA SUPPORT SQUAD PARA 06

x2 NVG
EPLRS
AN/VRC-90F



x2 NVG EPLRS
AN/VRC-90F OL-701A/TYQ
AN/TYQ-106(V)1
AN/TYQ-107(V)1
4X AN/TYQ-105(V)1
x2 AN/TYQ-107(V)2



CPT 63A00 GEN DENTAL OFF M9
CPT 65B00 PHY THERAPIST M4 AN/TYQ-105(V)1
SGT 68K20 MED LAB SGT M4
SGT 68P20 RADIOLOGY SGT M4
SGT 68F20 PHY THERAPY SGT M4 AN/TYQ-105(V)1
SPC 68E10 DENTAL SPEC M4
SPC 68K10 MED LAB SPEC M4
SPC 68P10 RADIOLOGY SPEC M4

MEDICAL TREATMENT SQUAD (AREA) PARA 07

FBCB2 AN/TYQ-106(V)1
AN/VAS-5 OL-701A/TYQ
2X NVG
DAGR
EPLRS
AN/VRC-89F
ANUYK-128(V)1



x2

AN/TYQ-106(V)1 2X NVG
OL-701A/TYQ DAGR
AN/VRC-90F



MAJ 62B00 FLD SURGEON M9 AN/TYQ-105(V)1
MAJ 65D00 SR PHYSICIAN ASST M9
SSG 68W30 HLTH CARE SGT M4 AN/TYQ-105(V)1
SGT 68W20 HLTH CARE SGT M4 AN/TYQ-105(V)1
SGT 68W20 HLTH CARE SGT M4 AN/TYQ-105(V)1
SGT 68W20 HLTH CARE SGT M4 AN/TYQ-105(V)1
SPC 68W10 HLTH CARE SP M4 AN/TYQ-105(V)1
PFC 68W10 HLTH CARE SP M4 AN/TYQ-105(V)1
PFC 68W10 HLTH CARE SP M4 AN/TYQ-105(V)1

MEDICAL COMPANY, BSB, IBCT

PATIENT HOLDING SQUAD PARA 08

EVACUATION PLT HQ PARA 09

(x3) EVACUATION SQUAD (FORWARD) PARA 10

(x2) EVACUATION SQUAD (AREA) PARA 11

AN/VRC-88F(C)
AN/TYQ-106(V)1



CBPS

x2 NVG
DAGR
AN/VRC-88



CPT 66H00 MED-SURGICAL NURSE M4 AN/TYQ-105(V)1
SGT 68W20 HLTH CARE SGT M4 AN/TYQ-105(V)1
SGT 68W20 HLTH CARE SGT M4 AN/TYQ-105(V)1
SPC 68W10 HLTH CARE SP M4 N/TYQ-105(V)1
PFC 68W10 HLTH CARE SP M4 N/TYQ-105(V)1

FBCB2 X2 NVG
DAGR
OL-701A/TYQ
KOI-18/TSEC
AN/YTQ-90(V)3
AN/UJK-128(V)1
EPLRS AN/VRC-89F



1LT 70B67 PLT LDR M4 AN/TYQ-107(V)1
SFC 68W40 PLT SGT M4

FBCB2
AN/VAS-5
X2 NVG
DAGR
EPLRS
AN/VRC-90F(C)
AN/UJK-128(V)1



SGT 68W20 EMER CARE SGT M4 AN/TYQ-105(V)1
SGT 68W20 EMER CARE SGT M4 AN/TYQ-105(V)1
SPC 68W10 AMB AIDE/DRIVER M4 AN/TYQ-105(V)1
SPC 68W10 AMB AIDE/DRIVER M4 AN/TYQ-105(V)1
PFC 68W10 AMB AIDE/DRIVER M4 AN/TYQ-105(V)1
PFC 68W10 AMB AIDE/DRIVER M4 AN/TYQ-105(V)1

x3

FBCB2
AN/VAS-5
X2 NVG
DAGR
EPLRS
AN/VRC-90F(C)
AN/UJK-128(V)1



SGT 68W20 EMER CARE SGT M4 AN/TYQ-105(V)1
SPC 68W10 AMB AIDE/DRIVER M4 AN/TYQ-105(V)1
SPC 68W10 AMB AIDE/DRIVER M4 AN/TYQ-105(V)1
PFC 68W10 AMB AIDE/DRIVER M4 AN/TYQ-105(V)1
PFC 68W10 AMB AIDE/DRIVER M4 AN/TYQ-105(V)1

x2

BRIGADE MEDICAL SUPPLY OFFICE PARA 12

FBCB2 X2 NVG
DAGR EPLRS
AN/VRC-90F
AN/PYQ-10(C)



2X NVG
AN/VRC-92F(C)
AN/TYQ-139
OL-701A/TYQ
AN/PYQ-10(C)
X2 AN/TYQ-105(V)1



1LT 70K67 HLTH SVC MAT OFF M4
SSG 68J30 MED LOG SGT M4
SGT 68A20 BIOMEDICAL EQ SGT M4 AN/TYQ-107(V)1
AN/TYQ-105(V)1
SGT 68J20 MED LOG SGT M4
SGT 68Q20 PHARMACY SGT M4 AN/TYQ-105(V)1
SPC 68J10 MED LOG SP M4

12 series

EQUIPMENT SUMMARY

WEAPONS

PISTOL 9MM AUTOMATIC M9----- 6
RIFLE 5.56MM M16A2----- 69

VEHICLES, TRAILERS, AND TRLR MTD SYSTEMS

CHEM AND BIO PROTECTED SHELTER SYS (CBPS)----- 6
GEN SET DIESEL ENGINE TM: 30KW 50/60 HZ (PU-803)----- 1
GEN SET DED TM: 10KW 60HZ (PU-798)----- 1
TRUCK UTILITY EXP CAPACITY ENH 4X4: M1152A1----- 6
TRUCK AMBULANCE: 4 LITTER HMMWV (M997)----- 16
TRUCK UTILITY EXP CAPACITY ENH 4X4: M1165A1----- 3
TRUCK CARGO: MTV (M1083)----- 6
TRAILER CARGO: MTV W/ DROPSIDES (M1095)----- 4
LIGHT TACTICAL TRAILER: 3/4T (M1101)----- 11
TRAILER TANK WATER (CAMEL) 800 GAL 5 TON----- 1

NIGHT VISION/OBSERVATION EQUIPMENT

DRIVERS VISION ENHANCER: AN/VAS-5----- 14
NIGHT VISION GOGGLES: AN/PVS-7B----- 62

MISCELLANEOUS EQUIPMENT

GEN SET: DED SKID MTD 5 KW 60HZ (MEP-802A)----- 2
GEN SET : DED SKID MTD 3KW 60HZ (MEP-831A)----- 5
JOINT SERVICE: TRANSPORTABLE DECON SYSTEM (JSTDS)----- 2

COMMUNICATION-ELECTRONICS EQUIPMENT

ANTENNA GROUP: OE-254----- 8
COMPUTER SYSTEM DIGITAL: AN/TYQ-107(V)2----- 4
COMPUTER SYSTEM DIGITAL: AN/TYQ-107(V)1----- 10
COMPUTER SYSTEM DIGITAL: AN/TYQ-106(V)1----- 8
COMP SET DIGITAL: AN/UJK-128(V)3 (FBCB2 BFT APPLIQUE)----- 28
COMPUTER SYSTEM DIGITAL: AN/TYQ-105(V)1----- 50
COMPUTER SYS DIGITAL: AN/TYQ-108(V)3----- 1
COMPUTER SET DIGITAL: AN/TYQ-109(V)1 (GCSS-A (V)1)----- 1
COMPUTER SYSTEM: DIGITAL AN/TYQ-139 (SAMS-1E V1)----- 1
COMPUTER SYSTEM DIGITAL: AN/UJK-90(V)3 (MTS-CS)----- 1
NAVIGATION SET: SATELLITE SIGNALS AN/PSN-13 (DAGR)----- 29
PROCESSOR GROUP SIGNAL DATA: (CAISI 2.0) OL-701A/TYQ----- 9
RADIAC SET: AN/VDR-2----- 17
RADIO SET: AN/VRC-88F----- 1
RADIO SET: AN/VRC-89F----- 10
RADIO SET: AN/VRC-90F----- 17
RADIO SET: AN/VRC-92F----- 1
RADIO SET: AN/PSC-5----- 3
COMPUTER SET: DIGITAL AN/GYK-62B (BFT TOC KIT)----- 1

PAGE INTENTIONALLY LEFT BLANK

MCoE SUPPLEMENTAL MANUAL 3-90

FORCE STRUCTURE REFERENCE DATA



ARMORED BRIGADE COMBAT TEAM

ANNEX B

SEPTEMBER 2013

FIRES BN TRAINING CONSOLIDATION IS NOT SHOWN, INSTEAD ALL FIRES SOLDIERS ARE SHOWN IN RED INDICATING THEIR INTENDED MTOE POSITION.



ARMORED BRIGADE COMBAT TEAM

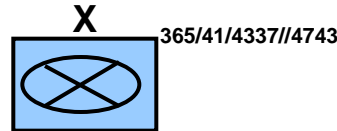

(Objective TOE)
SRC 87310R000

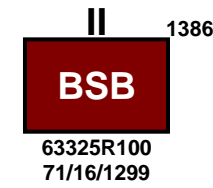
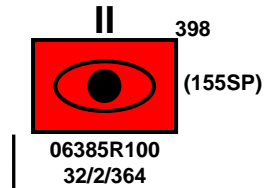
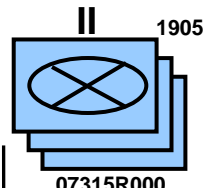
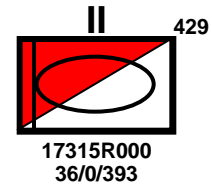
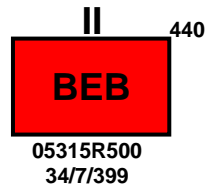
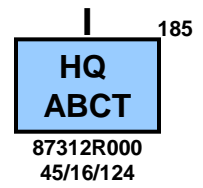

Mission: Disrupt or destroy enemy military forces, control land areas including populations and resources and be prepared to conduct combat operations to protect U.S. national interests.

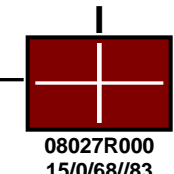
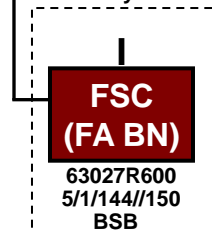
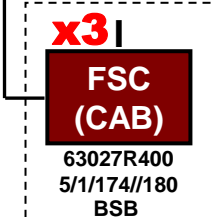
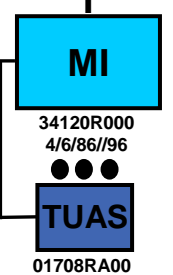
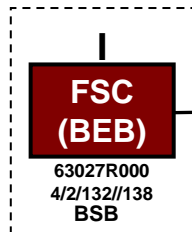
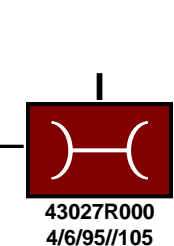
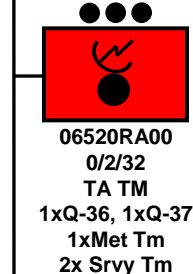
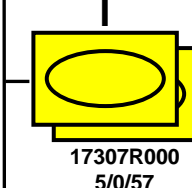
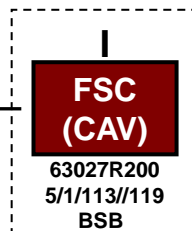
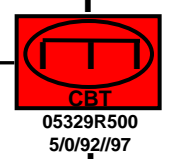
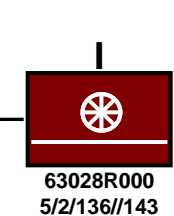
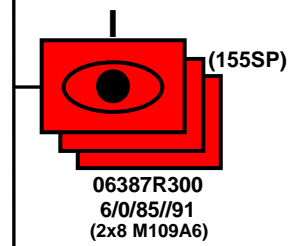
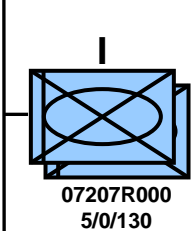
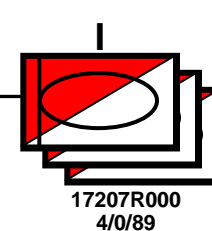
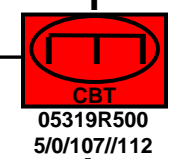
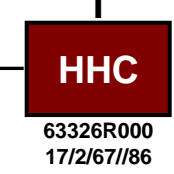
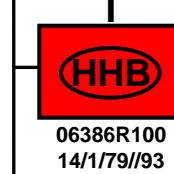
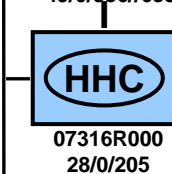
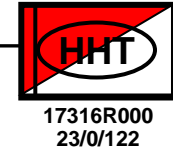
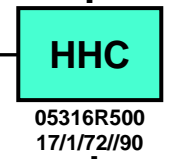

HQ, Armored Brigade Combat Team (ABCT)

MISSION.

To provide command, control, and supervision of the operation of the brigade and attached units. The Headquarters and Headquarters Company (HHC) also provides operating personnel to support functional requirements for the headquarters.

HEADQUARTERS, ABCT

87302R100
45/15/124//184

COMMAND GROUP PARA 01

FBCB2
M257
MG 7.62 RH FEED
2X NVG
DAGR
EPLRS
x2 AN/VRC-92F
X2 AN/PRC-113F
AN/PSC-5
2X M231
AN/VRC-104(V)3



COL 02C00 CDR DAGR M9
SGT 11B20 GUNNER M4
SPC 11B10 IFV DRIVER M4
SSG 11B30 ASST OPS SGT M4

FBCB2
AN/VAS-5
2X NVG
DAGR
EPLRS
AN/VRC-92F
AN/VRC-104(V)3



*COL 02C00 CDR *
PFC 25U10 VEH DVR M4
* WHEN NOT MOUNTED IN BFV

FBCB2
M257
MG 7.62 RH FEED
2X NVG
DAGR
EPLRS
X2 AN/VRC-92F
X2 AN/PRC-119F
AN/PSC-5
2X M231
AN/VRC-104(V)3



LTC 02C00 DEP CDR M9
MAJ 19A00 PLANS OFF M9
CPT 13A00 FIRE CONT OFF M4
SSG 11B30 ASST OPS SGT M4
SGT 11B20 GUNNER M4
SPC 11B10 IFV DRIVER M4

FBCB2
AN/VAS-5
x2 NVG
DAGR
EPLRS-V1
AN/VRC-92F
AN/UJK-128(V)01



*LTC 02C00 DEP CDR M9
* WHEN NOT MOUNTED IN BFV

FBCB2
AN/VAS-5
x2 NVG
DAGR
EPLRS-V1
AN/VRC-90F
AN/UJK-128(V)1



CSM 00T60 CSM M9
PFC 11B10 VEH DRIVER M4

FBCB2
AN/VAS-5
2X NVG
DAGR
EPLRS
AN/VRC-92F
AN/VRC-90F
AN/GYK-48(V)1
KOI-18/TSEC



MAJ 13A00 FIRE SPT
COORD M9

CURRENT OPS PARA 02

FBCB2
x2 NVG
DAGR
AN/VRC-92F
AN/TYQ-93
AN/GYK-57
AN/TYQ-137B(V)3
AN/PSC-5



LTC 02B00 EXEC OFF M9
SPC 35F10 INTEL ANLST M4

AN/VAS-5
x2 NVG
AN/VRC-90F
AN/TYQ-137B(V)03
AN/TYQ-116(V)3



PWR PLANT: UTILITY

FBCB2
AN/VAS-5
x2 NVG
DAGR
AN/VRC-92F
AN/TYQ-137B(V)3



MAJ 42H00 S1 M9
MAJ 35D00 S2 M9
MAJ 46A00 PAO M9
MAJ 27A00 BDE SJA M9
MSG 35X50 CH INTEL SGT M4
SPC 13F10 FIRE SPT SP M4

CURR OPS-LNO PARA 03

FBCB2
x2 NVG
DAGR
AN/VRC-90F
AN/UJK-128(V)1



CPT 11A00 LNO M4

CURRENT OPS - FIRE SPT/TACP PARA 04

FBCB2 M259
HWTS .50 CAL
2X NVG DAGR
EPLRS
AN/VRC-92F
AN/VRC-104(V)3
AN/PED-1 (LLDR)
ANN/GYK-56



*MAJ 01A00 AIR FORCE STAFF OFF M9
*SFC 00D40 AIR FORCE STAFF NCO M4
*SSG 00D30 AIR FORCE STAFF NCO M4
SPC 11B10 CARRIER DRIVER M4

*USAF STAFF NOT ASSIGNED TO UNIT

INTEL CELL - S2X PARA 05

AN/VAS-5
x2 NVG
AN/PSC-5
AN/VRC-90F
AN/VRC-104(V)3
DAGR



MED PWR PLANT

CPT 35F00 TEAM CHIEF M4
SGT 35M2L HUMINT COLL M4
SGT 12Y30 GEOSPATIAL EN SGT M4
SPC 12Y10 GEOSPATIAL EN M4



CW2 351M0 HUMINT COLL TECH M9
SGT 35L20 CI AGENT M9

x2 NVG
DAGR
AN/VRC-90F
AN/VRC-104(V)3



AN/TYQ-67

W2 125D0 GEOSPATIAL EN TECH M4
SFC 12Y40 SR GEOSPATIAL EN SGT M4
SGT 35G20 IMAGERY ANLST M4
SPC 35G10 IMAGERY ANLST M4
PFC 12Y10 GEOSPATIAL EN M4

PLANS CELL PARA 06

DAGR x2 NVG
FBCB2 DAGR
AN/PSC-5 AN/VAS-5
EPLRS-V1 AN/TYQ-93
AN/VRC-92F AN/VRC-104(V)3
AN/UJK-128(V)1 AN/TYQ-137B(V)03



CPP RWS

MED PWR PLANT

CPT 02A00 PLANS OFF M9
CPT 12A00 PLANS OFF M9
CPT 90A00 LOG OFF M4
SFC 11B40 OPS SGT M4
SSG 12B30 OPS SGT M4
SSG 35F30 INTEL SGT M4

FIRE SPT/PROTECT-NLOS PARA 07

FBCB2
AN/VAS-5
DAGR
EPLRS
AN/VRC-92F
AN/TYQ-93
x3 137B(V)3
GY/GYK-56



MED PWR PLANT

MAJ 30A00 INFO OPS OFF M9
CPT 27A00 OPLAW JAG M4
CPT 27A00 TRIAL CNSL M9
CPT 29A00 EW OFF M4
CPT 35G00 EW SPT OFF M4
W2 290A0 EW TECH M4
SFC 29E40 EW SGT M4
SSG 29E30 EW SGT M4
SGT 29E20 EW SGT M4

FBCB2
x2 NVG
DAGR
AN/VRC-92F



CPT 38A00 CIVIL AFFAIRS OFF M9
CPT 13A00 ASST FIRE SPT OFF M4
W2 131A0 TARGET ANAL M4
SFC 27D40 SR PARALEGAL NCO M9
SFC 37F40 SR PSYOP SGT M4
SFC 38B40 CIVIL AFFAIRS NCO M4
SSG 25E30 ELECTRO SPECT MGR M4
SSG 13F30 TARGETING/EW NCO M4
SGT 13F20 FIRE SPT SGT M4
SPC 13F10 FIRE SPT SP M4

ONLY ONE M1165A1

FIRE SPT/PROTECT-ADAM/BAE PARA 08

x2 NVG
DAGR
AN/VRC-90F
AN/FSQ-211 (TAIS-WS)



MAJ 15B00 AVIATION OFF M9
SPC 15P10 AVIATION OPS SP M4

FBCB2
AN/VRC-92F
AN/VRC-90F
AN/VRC-104(V)3
AN/UJK-128(V)1
AN/VRC-100(V)1
x2 AN/PSC-5
X2 AN/FSQ-211
KOI-18/TSEC
AN/PRC-117F



AN/TSQ-253

PU-798

FBCB2
x2 NVG
DAGR
AN/FSQ-211 (TAIS-WS)
AN/VRC-92F



CPT 15B00 ASST AVIATION OFF M9
CPT 14A00 AD COORD/MGMT OFF M9
W4 150U0 UAS OPS OFF M4
W3 153A1 TAC OPS OFF M4
W2 140A0 C2 SYS INTEGRATOR M4
SSG 15P30 AVIATION OPS SGT M4
SSG 15Q30 A2C2 SGT M4
SGT 14G20 TEAM LDR M4
PFC 14G10 BTL SYS OPER M4
PFC 14G10 BTL SYS OPER M4

FIRE SPT/PROTECT-PAO PARA 09

FBCB2
AN/VAS-5
x2 NVG
DAGR
AN/VRC-90F
AN/UJK-128(V)1
OA-9511:TYQ
AN/TYQ-122



SSG 46Q30 PUBLIC AFFAIRS NCO M4
SGT 46Q20 PUBLIC AFFAIRS SGT M4
SGT 46R20 PA BROADCAST SGT M4

HEADQUARTERS, ABCT

MOVEMENT AND MANEUVER CELL PARA 10

2X NVG
AN/VRC-90F

MED PWR PLANT

x2 NVG
AN/VRC-90F

CPT 11A00 OPS OFF M4
MSG 19Z50 MASTER GUNNER M4

AN/MJQ-41 PU
A UNIT B UNIT

SGM 19Z60 OPS SGT M4
SFC 11B40 ASST OPS SGT M4
SFC 74D40 CBRN STAFF NCO M4

MVMT & MAN/PROTECT-PMO PARA 11

FBCB2
x2 NVG
DAGR
AN/VRC-92F

CPT 31A00 PROVOST MARSHAL M9
SSG 31E30 I/R NCO M9 M4
SSG 31B30 OPS NCO M9 M4 11

SUSTAINMENT-S1 PARA 12

x2 NVG
DAGR
AN/VRC-90F
OL-701A/TYQ
OL-713(V)1/TYQ
x7 AN/TYQ-116(V)3

1LT 42B00 STRENGTH MGR M4
W2 420A0 HR TECH M4
SFC 42A50 SR HR SGT M4
SSG 42A30 HR SGT M4
X2 SGT 42A20 HR SGT M4
SPC 42A10 HR SPC M4
x2 SPC 42A10 HR SPC M4
x3 PFC 42A10 HR SP M4

SUSTAINMENT-S4/MED PARA 13

FBCB2
x2 NVG
DAGR
AN/VRC-90F
X2 AN/GYK-61 (BCS3)
x4 AN/TYQ-129(V)2
AN/TYQ-106(V)1
AN/TYQ-109(V)2
AN/TYQ-137B(V)3
AN/TYQ-95

AN/VRC-89F
DAGR

AN/TYQ-109(V)1
AN/VRC-92F

MED PWR PLANT

AN/TYQ-109(V)1
AN/TYQ-108(V)3
AN/UYG-90(V)3
OL-701A/TYQ

MAJ 90A00 S4 M9
MAJ 62B00 FIELD SURGEON M9
CPT 70H67 MED OPS OFF M9
W2 882A0 MOBILITY OFF M4
W2 920A0 PROP ACCT TECH M4
W2 922A0 FOOD ADVISOR
MSG 92G50 SR FOOD OPS SGT M4
MSG 92Y50 SR SUPPLY SGT M4
SFC 68W40 HEALTH CARE NCO M4
SFC 88N40 TRANS LOG NCO M4
SFC 92Y40 PROP BOOK NCO M4 (NEW)
SGT 92Y20 PROPERTY BOOK NCO M4
SPC 92Y10 SUPPLY SPEC M4

SUSTAINMENT - S8 PARA 14

FBCB2
AN/VAS-5
x2 NVG
DAGR
AN/VRC-90F
AN/UYK-128(V)3

CPT 36A00 FINANCE OFF M4
SFC 36B40 FIN MGT MANAGER M4

SUSTAINMENT-UMT PARA 15

FBCB2
x2 NVG
DAGR
AN/VRC-90F

MAJ 56A00 CHAPLAIN
SSG 56M30 CHAPLAIN
ASST NCO M4

C4 OPS - S6 PARA 16

x2 NVG
AN/VRC-90F
OB-123T

x2 AN/VRC-90F
x2 AN/TYQ-155(V)1
AN/UYK-128(V)1
AN/PYQ-16
EPLRS-V1

CPP RWS

MAJ 25A00 S6 M9
W3 255S0 NTRWK DEF TECH M4
W2 255A0 INFO SVCS TECH M4
W2 250N0 NETWORK MGMT TECH M4
MSG 25U50 SIG SPT SYS CHIEF M4 (NEW)
SFC 25B40 IA STAFF NCO M4
SFC 25B40 INFO SYS STAFF NCO M4
SFC 25E40 ELCTRM SPEC MGR M4
SSG 25B30 INFO TECH TM CHIEF M4
SSG 25B30 COMSEC CUSTODIAN M4
SSG 25N30 NODAL OPS SYS NCO M4
SSG 25Q30 XMSN SYS OPS NCO M4

x2 NVG
AN/VRC-90F

SSG 25S30 SATCO OPSN NCO M4
SGT 25B20 SR INFO SYS SP M4
SGT 25B20 ASST COMSEC CUS M4
SGT 25B20 IA STAFF ASST M4
SGT 25L20 SR CBL/ANT SYS SPL M4
SPC 25B10 INFO TECH SP M4
SPC 25B10 INFO TECH SP M4
SPC 25L10 CBL/ANT SYS SPL M4
SPC 25U10 SIG INFO SVC NCO M4
PFC 25B10 INFO TECH SP M4
PFC 25L10 CBL/ANT SYS SPL M4
PFC 25U10 SIGNAL SPT SYS SP M4

AN/VRC-90F AN/GYK-62B
AN/TSQ-243
AN/TSR-8(GRT)
AN/TYQ-137B(V)3
AN/GYK-50B (ISYCON)(V)4
AN/GYK-33D AN/GYK-149(V)2

MED PWR PLANT

x2 NVG
AN/VRC-90F

AN/TSC-188(V)1

PU 803

HEADQUARTERS, ABCT

TAC CURRENT OPS 1 – OPS PARA 17

x2 NVG
DAGR
AN/VRC-92F
AN/UJK-128(V)1
EPLRS-V1
AN/MRC-150



X2 NVG
DAGR
AN/VRC-92F
AN/VRC-90F
x2 AN/TYQ-137B(V)3



FBCB2
x2 NVG
DAGR
EPLRS-V1
AN/VRC-92F
AN/VRC-104(V)3
AN/TYQ-93
AN/UJK-128(V)1
x3 AN/TYQ-137B(V)3



x2 NVG
DAGR
AN/VRC-90F

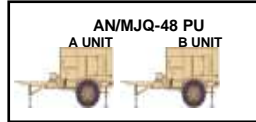

MAJ 02B00 S3 M9
MAJ 12A00 BDE EN OFF M9
CPT 35D00 ASST S2 M4
CPT 35D00 INTEL OFF M4
CPT 57A00 BATTLE CMD OFF M4
CPT 74A00 CBRN OFF M4
MSG 11Z50 OPS SGT M4
SFC 19K40 OPS SGT M4
SSG 12B30 RECON SGT M4

TAC CURRENT OPS 1 – TACP PARA 18

FBCB2
M259
.50 CAL
DAGR
EPLRS
AN/VRC-92F
AN/VRC-104(V)3



MAJ 01A00 AIR FORCE STAFF OFF M9
SFC 00D40 AIR FORCE STAFF NCO M4
SSG 00D30 AIR FORCE STAFF NCO M4

SPC 11B10 CARRIER DRIVER M4

AN/PED-1 (LLDR)
AN/GYK-56

TAC CURRENT OPS 2-INTEL/S2 PARA 19

2X NVG AN/PSC-5
AN/VRC-104(V)3
AN/TYQ-93(V)2
KOI-18/TSEC
AN/VRC-104(V)3



W2 350F0 ALL SOURCE INTEL TECH M4
SPC 35F10 INTEL ANLST M4

FBCB2
x2 NVG
DAGR
EPLRS
AN/VRC-92F
AN/TYQ-93(V)2
AN/PSC-5



SFC 19D40 SR INTEL SGT M4
SGT 35F20 INTEL SGT M4
PFC 35F10 INTEL ANLST M4

TAC CURRENT OPS 2-SUSTAIN PARA 20

FBCB2
x2 NVG
DAGR
AN/VRC-90F



CPT 90A92 ASST S4 M4
SPC 92Y10 SUPPLY SP M4

TAC CURRENT OPS 2-C4 OPS PARA 21

FBCB2 AN/PYQ-16
x2 NVG AN/TYQ-138B(V)3
DAGR AN/TSQ-243
X2 EPLRS-V1 X2 AN/TYQ-155(V)1
AN/VRC-90F AN/GYK-50B(SYSCON)(V)4
AN/VRC-104(V)3 AN/GYK-62B
AN/UJK-128(V)1



CPT 53A00 INFO SYS MGMT OFF M4
SFC 25W40 NTRWK OPS CHIEF M4
SPC 25B10 INFO TECH SPC M4
SPC 25U10 SIG SPT SYS MAINT M4

COMPANY HEADQUARTERS PARA 22

FBCB2 x2 NVG
DAGR AN/VRC-90F



CPT 01A00 CDR M9
SPC 92Y10 SUPPLY SP M4

FBCB2 .50 CAL
x2 NVG DAGR
AN/VRC-87F AN/TYQ-109(V)1
OL-701A/TYQ



1LT 19C00 EXEC OFF M4
MSG 19Z5M 1SG M4
SSG 92Y30 SUPPLY SGT M4
PFC 92Y10 SUPPLY SPC M4

COMBINED WITH PARA 05

MVMT & MANUEVER/PROTECT-ENG PARA 11

x2 NVG
DAGR
AN/VRC-90F
AN/VRC-104(V)3



FBCB2
x2 NVG
DAGR
AN/VRC-92F
AN/VRC-90F
AN/TYQ-137B(V)3



W2 125D0 GEOSPATIAL INFO TECH M4
SFC 12B40 OPS SGT M4 (MOVED TO PARA 06)
SFC 12Y40 SR GEOSPATIAL ENG SGT M4
SGT 12Y20 GEOSPATIAL ENGR SGT M4
SPC 12Y10 GEOSPATIAL ENG M4
PFC 12Y10 GEOSPATIAL ENG M4

MOVED TO FIRES BN

TAC CURRENT OPS 1-FIRE SPT PARA 18

x2 NVG
DAGR
AN/VRC-92F
AN/PSC-5
X2 AN/PRC-119F
AN/GYK-48(V)1



x2 NVG
AN/VRC-92F
AN/VRC-104(V)
AN/GYK-58
DAGR
AN/PSC-5
AN/GYK-56



MAJ 13A00 ASST FIRE SPT OFF M9
W3 131A0 TARGETING OFF M4
MSG 13Z50 OPS SGT M4
SFC 13F40 FIRE SPT SGT M4
SFC 13F40 TARGETING NCO M4
SPC 13F10 FIRE SPT SP M4
PFC 13F10 FIRE PST SP M4

DELETED COLT PARA 24

AN/PSG-14(V)1
FBCB2
DAGR
EPLRS-V1
AN/VRC-92F
AN/PSC-5
AN/VRC-104(V)3
AN/UJK-128(V)1
AN/PED-1 (LLDR)



SGT 13F20 STRYKER/COLT CHIEF M4
SPC 13F10 FIRE SPT SP M4
PFC 13F10 RATELO M4

x4

EQUIPMENT SUMMARY

WEAPONS		COMMUNICATIONS AND ELECTRONICS		
L69080	LAUNCHER GRENADE: M320A1	4	A35329 ALL SOURCE ANALYSIS SYSTEM: AN/TYQ-93	4
M09009	MACHINE GUN 5.56 MILLIMETER: M249	2	A35397 ALL SOURCE ANALYSIS SYSTEM: AN/TYQ-93(V)2	1
M39263	MACHINE GUN: LIGHT 5.56MM M249	8	C04819 COMTER SYS DIG: AN/PSG-14(V)1 LFED	8
M92420	MACHINE GUN 7.62 MILLIMETER: FIXED RH FEED	2	C17936 COMPUTER SET: AN/GYG-1(V)1	2
P98152	PISTOL 9MM AUTOMATIC: M9	33	C18004 COMPUTER SET: AN/GYG-1(V)3	2
R97234	RIFLE 5 56 MILLIMETER: M4	159	C18033 CENTER: COMMUNICATIONS OPERATIONS	1
S56419	SUBMACHINE GUN 5.56 MILLIMETER: PORT FIRING M231	4	C18244 COMPUTER SYSTEM: DIGITAL AN/PYQ-7	1
Z00686	MACHINE GUN: CALIBER .50	3	C18297 COMPUTER SET GENERAL: AN/GYK-33D	1
			C18312 COMPUTER SYSTEM: DIGITAL AN/PYQ-3	1
			C18345 COMPUTER SET: DIGITAL AN/TYQ-106(V)1	1
			C18378 COMPUTER SET: AN/UJK-128(V)3	13
			C18391 COMPUTER SYS: DIGITAL	2
			C18448 COMPUTER SYSTEM: DIGITAL AN/GYK-61	2
			C27435 COMPUTER SYSTEM: DIGITAL AN/TYQ-129(V)2	4
			C27503 COMPUTER SYSTEM: DIGITAL AN/TYQ-105(V)1	1
			C27639 COMPUTER SYSTEM: DIGITAL AN/TYQ-108(V)3	1
			C27707 COMPUTER SYSTEM: DIGITAL AN/TYQ-109(V)1	2
			C27775 COMPUTER SYSTEM: DIGITAL AN/TYQ-109(V)2	1
			C27963 COMPUTER SYSEM: DIGITAL	17
			C40996 COMMAND SYSTEM: TACTICAL	4
			C61665 COMMAND CENTER SYSTEM: AN/TSQ-243	2
			C77755 COMPUTER: TACTICAL AN/GYQ-88	1
			C78851 COMPUTER SYSTEM: DIGITAL AN/UJQ-90(V)3	1
			C79031 COMPUTER SET: GENERAL AN/GYK-49(V)2	1
			C79281 COMPUTER ST FIELD ARTILLERY GEN: AN/GYK-48(V)1	3
			P49587 PJH SURFACE VEHICLE RADIO SET: AN/VSQ-2(V)	16
			P99881 PROCESSOR GROUP SIG DATA: (CAISI 2.0) OL-701A/TYQ	3
			R30658 RECEIVE SUITE: AN/TSR-8	1
			R31031 RADIO SET: AN/GRC-240	1
			R42399 RADIO SET: AN/USQ-140(V)2(C)	1
			R44999 RADIO SET: AN/VRC-89F(C)	1
			R45543 RADIO SET: AN/VRC-92F(C)	33
			R57606 RADIO SET: AN/PSC-5	12
			R67296 RADIO SET: AN/VRC-87F(C)	1
			R68044 RADIO SET: AN/VRC-90F(C)	27
			R81691 RADIO SET: HIGH FREQUENCY AN/VRC-100 (V)1	1
			R83141 RADIO SET: AN/PRC-119F(C)	6
			R87139 RADIO ST: AN/VRC-104(V)3 W/PRC-150 HF RADIO	17
			R87207 RADIO ST: AN/PRC-117F TACSAT RADIO MANPACK	2
			R93169 RADIO TEST SET: AN/PRM-34()	1
			S24749 SWITCHING GROUP: DIGITAL DATA OA-9511/TYQ	1
			T40405 TAPE READER GENERAL PURPOSE: KOI-18/TSEC	3
			T43146 TELECONFERENCE SYS: AN/TYQ-122	1
			V03198 VIDEO ACQUISITION	1
			W63636 WORKSTATION: AIRSPACE OPERATION AN/FSQ-211	2
			Z00129 COMPUTER SET FIELD ARTILLERY GEN: AN/GYK-56	4
			Z00384 COMPUTER SYSTEM DIGITAL: AN/PYQ-10(C)	61
			Z00512 COMPUTER SYS DIGITAL: AN/GYK-50A (ISYSCON) (V)4	2
			Z00513 COMPUTER SYS DIGITAL: AN/GYK-50B (ISYSCON) (V)4	2
			Z00560 INTERFACE UNIT COMMUNICATION EQUIPMENT: OL-713(V)1/TYQ CSS VSAT	1
			Z01247 COMPUTER SET: DIGITAL AN/UJK-128(V)1	13
			Z01248 COMPUTER SET: DIGITAL AN/GYK-62B	2
			Z01426 COMMAND SYSTEM TACTICAL: AN/TYQ-155 (V) 1	4
			Z01463 COMPUTER SYSTEM DIGITAL: AN/PYQ-16	2
			Z39781 ARMY HUMAN RESOURCES: WRKSTATION	9
VEHICLES, TRAILERS AND TRLR MTD SYSTEMS				
C11158	CARRIER ARMORED COMMAND POST: FULL TRACKED	3		
C18234	CARRIER PERSONNEL FULL TRACKED: ARMORED (RISE)	2		
F60564	FIGHTING VEHICLE: FULL TRACKED INFANTRY (IFV) M2A3	2		
K29708	KNIGHT: ARMORED	0		
P63394	POWER PLANT: UTILITY	1		
P63462	POWER PLANT: UTILITY (MEDIUM)	8		
P63530	POWER PLANT: ELETRIC TRAILER MOUNTED	1		
T37588	TRUCK UTILITY EXPANDED CAPACITY ENHANCED: M1152A1	18		
T56383	TRUCK UTILITY EXPANDED CAPACITY ENHANCED 4X4: M1165A1	15		
T60081	TRUCK CARGO: 4X4 LMTV W/E	5		
T61908	TRUCK CARGO: MTV W/E	1		
T95924	TRAILER CARGO: HIGH MOBILITY 1-1/4 TON	1		
T95992	LIGHT TACTICAL TRAILER: 3/4 TON	9		
T96564	TRAILER FLAT BED: M1082 TRLR CARGO LMTV W/DROPSIDES	2		
Z36683	TRAILER TANK WATER (CAMEL): 800 GAL 5 TON W/E	1		
	NIGHT VISION/OBSERVATION			
D41659	DRIVERS ENHANCERS: AN/VAS-5	43		
J03261	ILLUMINATOR: INFRARED	12		
M79678	MONOCULAR NIGHT VISION DEVICE: AN/PVS-14	4		
N05482	NIGHT VISION: GOGGLE	100		
S90535	MEDIUM WEAPON THERMAL SIGHT (MWTS): AN/PAS-13(V)2	10		
S90603	HEAVY WEAPON THERMAL SIGHT (HWTS): AN/PAS-13(V)3	3		
	MISC EQUIPMENT			
C05701	MONITOR CHEMICAL AGENT:	2		
C79000	COLLECTIVE PROTECTION EQUIPMENT: NBC SIMPLIFIED M20	2		
G18358	GEN SET: DED SKID MTD 3KW 60HZ	1		
G42170	GEN SET DED TM: 10KW 60HZ MTD ONM116A2 PU-798	1		
J00697	JOINT CHMCL AGENT: DETECTOR	13		
M12986	MASK CHEMICAL BIOLOGICAL JOINT SERVICE GENERAL PURPOSE: FIELD M50	165		
M13236	MASK CHEMICAL-BLGLCL JNT SRV GNL PRPSE: CMBT VHL CRWMN M51	26		
R20684	RADIAC SET: AN/VDR-2	14		
R30925	RADIAC SET: AN/PDR-75	1		

HHC, BEB, ABCT

05316R500
17/1/72/90

COMMAND SECTION PARA 01

COMPANY HEADQUARTERS PARA 02

MISSION: The headquarters provides command, control, and supervision of the tactical operations of the Brigade Engineer Battalion (BEB) and attached units. The headquarters company provides unit administration, information management, and logistical support for the battalion staff sections. It also provides administrative and medical support to organic and attached units.

FBCB2
AN/VAS-5
x2 NVG
DAGR
EPLRS
AN/VRC-92F
AN/PRC-119F
AN/UJK-128(V)3



LTC 12A00 CDR M4 M9
SGT 12B20 VEH CDR M4
SPC 12B10 GUNNER M4
PFC 12B10 TRACK DRIVER M4

FNCN2
x2 NVG
DAGR
EPLRS
AN/VRC-92F
AN/UJK-128(V)3



*LTC 12A00 CDR M4 M9
CSM 12A60 CSM M4 M9
*WHEN NOT ON BRADLEY

FNCN2
x2 NVG
DAGR
EPLRS
AN/VRC-92F
AN/UJK-128(V)3



MAJ 01A00 BN XO M4 M9
SPC 12B00 CBT EN M4

FBCB2
AN/VAS-5
x2 NVG
DAGR
EPLRS
AN/VRC-90F
AN/UJK-128(V)3



CPT 01A00 CDR M4 M9
1LT 12A00 OPS OFF M4
PFC 12B10 DRIVER M4

x2 NVG
DAGR
EPLRS
AN/VRC-90F
AN/TYQ-109(V)1
OL-701/TYQ



1SG 12Z5M 1SG M4
SFC 12B40 OPS SGT M4
SSG 92Y30 SUPPLY SGT M4
SPC 92Y10 SUPPLY SPC M4

SUSTAINMENT - S1 PARA 03

S2 SECTION PARA 04

S3 SECTION PARA 05

x2 NVG
DAGR
EPLRS
AN/VRC-90F

OL-701A/TYQ
x4 AN/TYQ-116(V)3



CPT 42B00 CPT S1 OFF M4
SFC 42A40 SR HR SGT M4
SSG 42A30 HR SGT M4
SGT 27D20 PARALEGAL SGT M4
SGT 42A20 HR SGT M4
X2 SPC 42A10 HR SP M4
X2 PFC 42A10 HR SP M4

FBCB2 x2 NVG
DAGR EPLRS
AN/VAS-5
AN/VRC-92F
AN/VRC-104(V)3
AN/UJK-128(V)3



CPT 35D00 INTEL OFF S2 M4
SFC 35F40 INTEL SGT M4
SGT 29320 ELECT WARFARE NCO M4
PFC 35F10 INTEL ANLST M4

FBCB2
2X NVG
DAGR
EPLRS
AN/VRC-92F

AN/TYQ-93
AN/UJK-128(V)3
AN/TYQ-137B(V)3
HWTS
.50 CAL



1LT 12A00 ASST S2 OFF M4
MSG 12Z50 SR INTEL SGT M4
SFC 74D40 CBRN STAFF NCO M4
SSG 29E30 ELECT WARFARE NCO M4
SPC 35F10 INTEL ANLST M4

FBCB2 x2 NVG
DAGR EPLRS
AN/VAS-5
AN/VRC-92F
AN/VRC-104(V)3
AN/UJK-128(V)3



MAJ 12A00 S3 M4 M9
SFC 12H40 CONST NCO M4
PFC 12B10 DRIVER M4
SSG 12B30 ASST PLANS NCO M4

x2 NVG FBCB2
x2 DAGR EPLRS
AN/VRC-91F



SSG 12T30 TE TOPO SURVEY SGT M4
SPC 12T10 TE TOPO SURVEY SPC M4

FBCB2
AN/VAS-5
x2 NVG
DAGR
AN/UJK-90(V)3



CPT 12A00 PLANS OFF M4
MSG 11Z50 OPS SGT M4
SSG 12B30 RECON SGT M4

AN/VRC-92F AN/VRC-90F
AN/UJK-128(V)3
x2 AN/TYQ-137B(V)3
AN/PRC-150 HF RADIO
FHMUX
KOI-18/TSEC
.AN/PSC-5



CPT 01A00 ASST S3 OFF M4
CPT 12A00 CONST ENGR M4
W2 120A0 CONST EN TECH M4
SFC 12B40 ASST OPS SGT M4
SSG 12H30 ASST CONST NCO M4
SSG 12N30 CONSTRUCT FOREMAN M4

AN/VAS-5
x2 NVG
DAGR
AN/VRC-92F
AN/UJK-90(V)3



1LT 12A00 RECON OFF M4
SSG 12B30 RECON SGT M4

HHC, BEB, ABCT

SUSTAINMENT – S4 PARA 06

FBCB2
x2 NVG
DAGR
EPLRS
AN/VRC-92F



CPT 12A00 S4 OFF M4
SPC 92Y10 SUPPLY SPEC M4

x2 AN/TYQ-129(V)2 AN/TYQ-109(V)1
AN/TYQ-137B(V)3 AN/UYQ-90(V)3
AN/TSC-183 OL-701A/TYQ
KOI-18/TSEC



SFC 92Y40 SR SUPPLY SGT M4
SGT 92Y10 SUPPLY NCO M4

S6 SECTION PARA 07

AN/PYQ-12 AN/TSQ-243
DAGR AN/TSR-8 (GRT)
AN/GYK-50A AN/TSQ-259
AN/TYQ-137B(V)3
AN/GYK-50B(SYSCON)(V)4
AN/GYK-62B



CPT 25A00 S6 OFF M4
SPC 25B10 LAN MGR M4
SGT 25U20 FWD SIG SPT NCO M4
SPC 25U10 SIG SPT SYS SPC M4

AN/VAS-5
x2 NVG
DAGR
AN/VRC-92F
AN/UYQ-90(V)3



SFC 25U40 SECT CHIEF M4
SSG 25U30 SIG INFO SVE NCO M4
PFC 25U10 SIG SPT SYS SPC M4
PFC 25B10 LAN MGR M4

SUSTAINMENT - MEDICAL SUPPORT SECTION PARA 08

x2 NVG
DAGR
PLRS
AN/VRC-90F
AN/TYQ-128(V)3
x2 AN/TYQ-105(V)1



x2

SGT 68W20 EMER CARE SGT M4
SGT 68W20 EMER CARE SGT M4
SPC 68W10 AMB AIDE/DRIVER M4
SPC 68W10 AMB AIDE/DRIVER M4
PFC 68W10 AMB AIDE/DRIVER M4
PFC 68W10 AMB AIDE/DRIVER M4

x2 NVG
DAGR
PLRS
AN/VRC-90F
AN/TYQ-107(V)1
AN/TYQ-106(V)1
x6 AN/TYQ-105(V)1
OL-701/TYQ



CPT 65D00 PHYSICIAN ASST M9
SFC 68W40 HEALTH CARE NCO M4
X2 SSG 68W30 HEALTH CARE SGT M4
X3 SPC 68W10 COMBAT MEDIC M9
PFC 68W10 HEALTH CARE SP M4

SUSTAINMENT – UMT PARA 09

x2 NVG
DAGR
EPLRS
AN/VRC-90F



CPT 56A00 CHAPLAIN
SGT 56M20 CHAPLAIN ASST M4

CBRN RECCE PLATOON PARA 10

FBCB2
x2 NVG
EPLRS
AN/VRC-89F
AN/VRC-90F
AN/UYK-128(V)3
FHMUX
ON-721/V
DARG



1LT 74A00 PLT LDR M4
SGT 74D20 ASST TM LDR M4
SPC 74D10 CBRN SP M249
PFC 74D10 CBRN SP M4

FBCB2
x2 NVG
EPLRS
AN/VRC-89F
AN/VRC-90F
AN/UYK-128(V)3
FHMUX
ON-721/V
DARG



SFC 74D40 PLT SGT M4
SGT 74D20 ASST TM LDR M4
SPC 74D10 CBRN SPC M249
PFC 74D10 CBRN SPC M4

FBCB2
x2 NVG
EPLRS
AN/VRC-89F
AN/VRC-90F
AN/UYK-128(V)3
FHMUX
ON-721/V
DARG



SSG 74D30 TEAM LDR M4
SGT 74D20 ASST TM LDR M4
SPC 74D10 CBRN SPC M249
PFC 74D10 CBRN M4

EQUIPMENT SUMMARY

WEAPONS			
L69080	LAUNCHER GRENADE: M203A1	4	
M09009	MACHINE GUN 5.56 MILLIMETER: M249	2	
M39263	MACHINE GUN: LIGHT 5.56MM M249	8	
M92420	MACHINE GUN 7.62 MILLIMETER: FIXED RH FEED	2	
P98152	PISTOL 9MM AUTOMATIC: M9	9	
R97234	RIFLE 5 56 MILLIMETER: M4	83	
S56419	SUBMACHINE GUN 5.56 MILLIMETER: PORT FIRING M231	4	
Z00686	MACHINE GUN: CALIBER .50	3	
VEHICLES, TRAILERS AND TRLR MTD SYSTEMS			
C11158	CARRIER ARMORED COMMAND POST: FULL TRACKED	0	
C18234	CARRIER PERSONNEL FULL TRACKED: ARMORED (RISE)	1	
F60564	FIGHTING VEHICLE: FULL TRACKED INFANTRY (IFV) M2A3	1	
P63394	POWER PLANT: UTILITY	1	
P63462	POWER PLANT: UTILITY (MEDIUM)	0	
P63530	POWER PLANT: ELETRIC TRAILER MOUNTED	1	
T37588	TRUCK UTILITY EXPANDED CAPACITY ENHANCED: M1152A1	4	
T56383	TRUCK UTILITY EXPANDED CAPACITY ENHANCED 4X4: M1165A1	6	
T60081	TRUCK CARGO: 4X4 LMTV W/E	3	
T61908	TRUCK CARGO: MTV W/E	3	
T95924	TRAILER CARGO: HIGH MOBILITY 1-1/4 TON	5	
T95992	LIGHT TACTICAL TRAILER: 3/4 TON	0	
T96564	TRAILER FLAT BED: M1082 TRLR CARGO LMTV W/DROPSIDES	2	
Z36683	TRAILER TANK WATER (CAMEL): 800 GAL 5 TON W/E	1	
NIGHT VISION/OBSERVATION			
D41659	DRIVERS ENHANCERS: AN/VAS-5	43	
J03261	ILLUMINATOR: INFRARED	12	
M79678	MONOCULAR NIGHT VISION DEVICE: AN/PVS-14	4	
N05482	NIGHT VISION: GOGGLE	99	
S90535	MEDIUM WEAPON THERMAL SIGHT (MWTS): AN/PAS-13(V)2	10	
S90603	HEAVY WEAPON THERMAL SIGHT (HWTS): AN/PAS-13(V)3	3	
MISC EQUIPMENT			
C05701	MONITOR CHEMICAL AGENT:	2	
C79000	COLLECTIVE PROTECTION EQUIPMENT: NBC SIMPLIFIED M20	2	
G18358	GEN SET: DED SKID MTD 3KW 60HZ	1	
G42170	GEN SET DED TM: 10KW 60HZ MTD ONM116A2 PU-798	1	
J00697	JOINT CHMCL AGENT: DETECTOR	13	
M12986	MASK CHEMCL BIOLOGICL JOINT SERVICE GENERAL PURPOSE: FIELD M50	99	
M13236	MASK CHMCL-BLGCL JNT SRV GNL PRPSE: CMBT VHL CRWMN M51	26	
R20684	RADIAC SET: AN/VDR-2	14	
R30925	RADIAC SET: AN/PDR-75	1	
COMMUNICATIONS AND ELECTRONICS			
A35329	ALL SOURCE ANALYSIS SYSTEM: AN/TYQ-93	4	
A35397	ALL SOURCE ANALYSIS SYSTEM: AN/TYQ-93(V)2	1	
C04819	COMTER SYS DIG: AN/PSG-14(V)1 LFED	8	
C17936	COMPUTER SET: AN/GYG-1(V)1	2	
C18004	COMPUTER SET: AN/GYG-1(V)3	2	
C18033	CENTER: COMMUNICATIONS OPERATIONS	1	
C18244	COMPUTER SYSTEM: DIGITAL AN/PYQ-7	1	
C18297	COMPUTER SET GENERAL: AN/GYK-33D	1	
C18312	COMPUTER SYSTEM: DIGITAL AN/PYQ-3	1	
C18345	COMPUTER SET: DIGITAL AN/TYQ-106(V)1	1	
C18378	COMPUTER SET: AN/UYPK-128(V)3	13	
C18391	COMPUTER SYS: DIGITAL	2	
C18448	COMPUTER SYSTEM: DIGITAL AN/GYK-61	2	
C27435	COMPUTER SYSTEM: DIGITAL AN/TYQ-129(V)2	4	
C27503	COMPUTER SYSTEM: DIGITAL AN/TYQ-105(V)1	1	
C27639	COMPUTER SYSTEM: DIGITAL AN/TYQ-108(V)3	1	
C27707	COMPUTER SYSTEM: DIGITAL AN/TYQ-109(V)1	2	
C27775	COMPUTER SYSTEM: DIGITAL AN/TYQ-109(V)2	1	
C27963	COMPUTER SYSEM: DIGITAL	17	
C40996	COMMAND SYSTEM: TACTICAL	4	
C61665	COMMAND CENTER SYSTEM: AN/TSQ-243	2	
C77755	COMPUTER: TACTICAL AN/GYQ-88	1	
C78851	COMPUTER SYSTEM: DIGITAL AN/UYPQ-90(V)3	1	
C79031	COMPUTER SET: GENERAL AN/GYK-49(V)2	1	
C79281	COMPUTER ST FIELD ARTILLERY GEN: AN/GYK-48(V)1	3	
P49587	PJH SURFACE VEHICLE RADIO SET: AN/VSQ-2(V)	16	
P99881	PROCESSOR GROUP SIG DATA: (CAISI 2.0) OL-701A/TYQ	3	
R30658	RECEIVE SUITE: AN/TSR-8	1	
R31031	RADIO SET: AN/GRC-240	1	
R42399	RADIO SET: AN/USQ-140(V)2(C)	1	
R44999	RADIO SET: AN/VRC-89F(C)	1	
R45543	RADIO SET: AN/VRC-92F(C)	33	
R57606	RADIO SET: AN/PSC-5	12	
R67296	RADIO SET: AN/VRC-87F(C)	1	
R68044	RADIO SET: AN/VRC-90F(C)	27	
R81691	RADIO SET: HIGH FREQUENCY AN/VRC-100 (V)1	1	
R83141	RADIO SET: AN/PRC-119F(C)	6	
R87139	RADIO ST: AN/VRC-104(V)3 W/PRC-150 HF RADIO	17	
R87207	RADIO ST: AN/PRC-117F TACSAT RADIO MANPACK	2	
R93169	RADIO TEST SET: AN/PRM-34()	1	
S24749	SWITCHING GROUP: DIGITAL DATA OA-9511/TYQ	1	
T40405	TAPE READER GENERAL PURPOSE: KOI-18/TSEC	3	
T43146	TELECONFERENCE SYS: AN/TYQ-122	1	
V03198	VIDEO ACQUISITION	1	
W63636	WORKSTATION: AIRSPACE OPERATION AN/FSQ-211	2	
Z00129	COMPUTER SET FIELD ARTILLERY GEN: AN/GYK-56	4	
Z00384	COMPUTER SYSTEM DIGITAL: AN/PYQ-10(C)	61	
Z00512	COMPUTER SYS DIGITAL: AN/GYK-50A (ISYSCON) (V)4	2	
Z00513	COMPUTER SYS DIGITAL: AN/GYK-50B (ISYSCON) (V)4	2	
Z00560	INTERFACE UNIT COMMUNICATION EQUIPMENT: OL-713(V)1/TYQ CSS VSAT	1	
Z01247	COMPUTER SET: DIGITAL AN/UYPK-128(V)1	13	
Z01248	COMPUTER SET: DIGITAL AN/GYK-62B	2	
Z01426	COMMAND SYSTEM TACTICAL: AN/TYQ-155 (V) 1	4	
Z01463	COMPUTER SYSTEM DIGITAL: AN/PYQ-16	2	
Z39781	ARMY H RESURCES: WRKSTATION	9	

DRAFT

COMBAT ENGINEER COMPANY, BEB, ABCT

05319R500
5/0/107//112

MISSION: To increase the combat effectiveness of the maneuver commander by accomplishing mobility, and countermobility, as well as limited survivability, and general engineering tasks.

COMPANY HEADQUARTERS PARA 01

FBCB2 M257
MG 7.62 RH FEED
DAGR EPLRS
AN/VRC-2X M231



CPT 12A00 CDR M4 M9
AN/PRC-119F
SGT 12B20 VEH CDR M4
SPC 12B10 GUNNER M4
PFC 12B10 TRCK VEH DR M4

FBCB2 DAGR
AN/VAS-5 EPLRS
AN/VRC-92F



CPT 12B00 CDR M4 M9
1SG 12Z5M 1SG M4 NVG
PFC 12B10 DRIVER M4
*WHEN NOT MOUNTED ON BRADLEY

FBCB2 X2 NVG
M259 .50 CAL
DAGR EPLRS
AN/VRC-92F
HWTS



1LT 12A00 OPS OFF M4
SFC 12B40 OPS SGT M4 NVG
PFC 12B10 ODS-E DR M4
SGT 25U20 FWD SIG SPT NCO
M4 NVG

AN/TYQ-109(V)1
OL-701A/TYQ
HWTS
3X JAVELIN
KOI-18/TSEC

DAGR
AN/VRC-90F
OL-700/TYQ
AN/PYQ-6C



SSG 92Y30 SUPPLY SGT M4 NVG
SPC 92Y10 SUPPLY SP M4 NVG

(X2) ENGINEER PLT HQ PARA 02

FBCB2
M257
MG 7.62 RH FEED
DAGR
EPLRS
AN/VRC-89F
2X M231
AN/PRC-148



1LT 12A00 PLT LDR M4
SGT 12B20 VEH CDR M4
SPC 12B00 GUNNER M4
PFC 12B10 TRK VEH DR M4

FBCB2 MK-19
DAGR EPLR:
AN/VRC-89F
HWTS
AN/PRC-148(V)4



SFC 12B40 PLT SGT M4
PFC 12B10 DRIVER M4

ENGINEER SQUAD PARA 03

FBCB2
M257
MG 7.62 RH FEED
DAGR
EPLRS
AN/VRC-89F
2X M231
AN/PRC-148(V)4



SSG 12B30 SQD LDR M4 ILLUM ENVG
SGT 12B20 VEH CDR M4 NVG
SGT 12B20 TM LDR M4 ILLUM ENVG
SGT 12B20 TM LDR M4 ILLUM ENVG
SPC 12B10 GUNNER M4 NVG
SPC 12B10 CBT ENG M4 ILLUM ENVG
SPC 12B10 CBT ENG M320 ILLUM ENVG
PFC 12B10 TRACK VEH DRIVER M4 NVG
PFC 12B10 ODS-E DRVR M4 ILLUM ENVG

x6

ASSAULT PLT HQ PARA 04

FBCB2
AN/VAS-5
DAGR
EPLRS
AN/VRC-89F



1LT 12A00 PLT LDR M4
PFC 12B10 DRIVER M4

FBCB2
AN/VAS-5
DAGR
EPLRS
AN/VRC-89F



SFC 12B40 PLT SGT M4
PFC 12B10 DRIVER M4

BREACH SQUAD PARA 05

X2 NVG FBCB2
EPLRS M250
.50 CAL
AN/VRC-90F



SGT 12B20 ABV CDR M4 NVG
SPC 12B10 ABV OPR M4 NVG

x2

x2 NVG FBCB2
DAGR EPLRS
AN/VRC-89F



SGT 12B20 ABV VEH DVR M4
SPC 12B10 ABV OPERATOR M4

FBCB2
DAGR
EPLRS
AN/VRC-89F



SGT 12B20 AVLB CDR M4 M9
SPC 12B10 AVLB OPERATOR M4 M9

x2

HORIZONTAL SQUAD PARA 06

DAGR
AN/VRC-91F
AN/PRC-119F



x2

SSG 12N30 SQD LDR M4 NVG
SPC 12N10 HVY VEH DRVR M4 NVG
SPC 12N10 HVY VEH DRVR M4 NVG
SPC 12N10 HORZ CONST ENG M4 NVG

DAGR
AN/VRC-90F



x3

SGT 12N20 HORIZ CONST ENG M4 NVG AN/PRC-119F
SGT 12N20 HORIZ CONST ENG M4 NVG AN/PRC-119F
SPC 12N10 HORIZ CONST ENG M4 NVG AN/PRC-119F
PFC 12N10 HORIZ CONST ENG M4 NVG AN/PRC-119F
PFC 12N10 HORIZ CONST ENG M4 NVG AN/PRC-119F
PFC 12N10 HORIZ CONST ENG M4 NVG AN/PRC-119F

x3 NVG DAGR
x3 AN/PRC-119F



x3

SGT 12N20 HORIZ CONST ENG M4
SPC 12N10 HORIZ CONST ENG M4
SPC 12N10 HORIZ CONST ENG M4



DAGR
AN/PRC-119F



SPC 12N10 HORIZ CONST ENG M4
NVG AN/PRC-119F

EQUIPMENT SUMMARY

WEAPONS			COMMUNICATIONS AND ELECTRONICS		
C60750	COMMAND LAUNCH UNIT: (JAVELIN) 13305405-119	3	C18378	COMPUTER SET: ANUYK-128(V)3	40
L69080	LAUNCHER GRENADE: M320A1	22	C27707	COMPUTER SYSTEM: DIGITAL AN/TYQ-109(V)1	1
L91701	MACHINE GUN CALIBER .50: HEAVY FIXED TURRET TYPE	6	C67436	COMPTER SYSTEM DIGITAL: AN/PYQ-6C	1
M09009	MACHINE GUN 5.56 MILLIMETER: M249	18	N96248	NAVIGATION SET: SATELLITE SIGNALS AN/PSN-13	44
M92362	MACHINE GUN GRENADE 40MM: MK19 MOD III	4	P49587	PJH SURFACE VEHICLE RADIO SET: ANV/SQ-2(V)	40
M92420	MACHINE GUN 7.62 MILLIMETER: FIXED RH FEED	13	P99881	PROCESSOR GROUP SIG DATA: (CAISI 2.0) OL-701A/TYQ	1
M92454	MACHINE GUN 7.62 MILLIMETER: M240L	9	R44999	RADIO SET: AN/VRC-89F(C)	17
M92841	MACHINE GUN: 7.62MM M240B	4	R45543	RADIO SET: AN/VRC-92F(C)	4
P98152	PISTOL 9MM AUTOMATIC: M9	7	R68044	RADIO SET: AN/VRC-90F(C)	18
R97234	RIFLE 5.56 MILLIMETER: M4	107	R68146	RADIO SET: AN/VRC-91F(C)	2
S40541	SHOTGUN: 12 GAGE	18	R83141	RADIO SET: AN/PRC-119F(C)	4
S56419	SUBMACHINE GUN 5.56 MILLIMETER: PORT FIRING M231	26	T40405	TAPE READER GENERAL PURPOSE: KOI-18/TSEC	1
Z00686	MACHINE GUN: CALIBER .50	3	Z00384	COMPUTER SYSTEM DIGITAL: AN/PYQ-10(C)	45
			Z01320	RADIO SET: AN/PRC-148 (V) 4 URBAN JEM	44
VEHICLES, TRAILERS AND TRLR MTD SYSTEMS			MISC EQUIPMENT		
C11158	CARRIER ARMORED COMMAND POST: FULL TRACKED	1	A33020	ALARM: CHEMICAL AGENT AUTOMATIC M22	7
C18234	CARRIER PERSONNEL FULL TRACKED: ARMORED (RISE)	1	B84404	BOAT: CONNAISSANCE: PNEUMATIC 3-MAN	3
M31793	M2A2ODS: FOR ENGINEERS	13	C05701	MONITOR: CHEMICAL AGENT:	9
T34704	TRUCK UTILITY: ECV ARMAMENT CARRIER W/IAP ARMOR READY M1151A1	2	D06840	CONTROL REMOTE LANDMINE SYSTEM: M71	12
T37588	TRUCK UTILITY EXPANDED CAPACITY ENHANCED: M1152A1	5	D06832	DETECTING SET: MINE AN/PSS-14	38
T39586	TRUCK CARGO: TACTICAL 8X8 HEAVY EXPANDED MOBILITY W/MED CRANE	4	F91490	DEMOLITION SET EXPLOSIVE: INITIATING ELECTRIC AND SEMI ELECTRIC	9
H53576	HIGH MOBILITY ENG EXCAVATOR (HMEE): TYPE I		G18358	GEN SET: DED SKID MTD 3KW 60HZ	1
T56383	TRUCK UTILITY EXPANDED CAPACITY ENHANCED 4X4: M1165A1		J00697	JOINT CHMCL AGENT: DETECTOR	7
T61908	TRUCK CARGO: MTV W/E	1	M12986	MASK CHEMICAL BIOLOGICAL JOINT SERVICE GENERAL PURPOSE: FIELD M50	28
T93761	TRAILER: PALLETIZED LOADING 8X20	4	M13236	MASK CHEMICAL-BLGCJL JNT SRV GNL PRPSE: CMBT VHL CRWMN M51	122
T95992	LIGHT TACTICAL TRAILER: 3/4 TON	5	R20684	RADIAC SET: AN/VDR-2	11
W76473	TRACTOR FULL TRACKED HIGH SPEED: ARMORED COMBAT EARTHMOVER (ACE)	6	R30925	RADIAC SET: AN/PDR-75	1
W95811	TRAILER CARGO: 1-1/2 TON 2 WHEEL W/E	9	R31061	RADIAC SET: AN/UDR-13	5
W98825	TRAILER TANK: WATER 400 GALLON 1-1/2 TON 2 WHEEL W/E	1	S83835	SMALL UNMANNED AIRCRAFT SYSTEM (SUAS): RAVEN B (MIP)	1
Z01092	BREACHER COMPLEX OBSTACLE FULL TRACKED: ASSAULT XM1150	6	S93791	SOF DEMOLITION KIT: M303	4
Z36683	TRAILER TANK WATER (CAMEL): 800 GAL 5 TON W/E	1	W34511	TOOL KIT CARPENTERS: ENGINEER PLATOON W/CHEST	4
			W34648	TOOL KIT CARPENTERS: ENGINEER SQUAD W/CHEST	12
			W48074	TOOL KIT PIONEER ENGINEER COMBAT PLATOON: TOOLS FOR MANUAL LABOR	4
			W48211	TOOL KIT PIONEER ENGINEER PLATOON: GENERAL USE	1
			W48348	TOOL KIT PIONEER ENGINEER SQUAD: LAND CLR AND BLDG ERECTION	11
NIGHT VISION/OBSERVATION			Z01476	URBAN OPERATIONS: PLATOON	3
D41659	DRIVERS ENHANCERS: AN/VAS-5	10	Z01531	URBAN OPERATIONS SQUAD SET:	9
J03261	ILLUMINATOR: INFRARED	72			
M79678	MONOCULAR NIGHT VISION DEVICE: AN/PVS-14	68			
N05482	NIGHT VISION: GOGGLE	33			
N07848	NIGHT VISION DEVIC: AN/PSQ-20	51			
S60356	SIGHT: THERMAL AN/PAS-13B(V)1	9			
S90535	MEDIUM WEAPON THERMAL SIGHT (MWTS): AN/PAS-13(V)2	31			
S90603	HEAVY WEAPON THERMAL SIGHT (HWTS): AN/PAS-13(V)3	7			
T27221	TARGET LOCATION AND OBSERVATION: AN/PLQ-8	9			

COMBAT ENGINEER COMPANY, BEB, ABCT

05329R500
5/09/97

COMPANY HEADQUARTERS PARA 01

FBCB2 M257
MG 7.62 RH FEED
DAGR EPLRS
AN/VRC-92F
2X M231



CPT 12A00 CDR M4 M9
AN/PRC-119F
SFC 12B40 OPS SGT M4 NVG
SPC 12B10 GUNNER M4
PFC 12B10 ODS-E DRV M4
SGT 12B20 VEH CDR M4

AN/TYQ-109(V)1
OL-701A/TYQ
HWTS
3X JAVELIN
KOI-18/TSEC

FBCB2 DAGR
AN/VAS-5 EPLRS
AN/VRC-92F



CPT 12B00 CDR M4 M9
1SG 12Z5M 1SG M4 NVG
SGT 25U20 FWD SIG SPT
NCO M4 NVG
**WHEN NOT MOUNTED
ON BRADLEY*



1LT 12A00 CONST OFF M4
SSG 92Y30 SUPPLY SGT M4 NVG
SPC 92Y10 SUPPLY SP M4 NVG

COMBAT EN PLT HQ PARA 02

FBCB2 M257
MG 7.62 RH FEED
DAGR EPLRS
AN/VRC-89F
2X M231
AN/PRC-148



1LT 12A00 PLT LDR M4
SGT 12B20 VEH CDR M4
SPC 12B00 GUNNER M4
PFC 12B10 ODS-E M4

FBCB2 MK-19
DAGR EPLRS
AN/VRC-89F
HWTS
AN/PRC-148(V)4



SFC 12B40 PLT SGT M4
PFC 12B10 DRIVER M4

COMBAT EN SQUAD PARA 03

FBCB2 M257 M240L
MG 7.62 RH FEED SHOTGUN
DAGR EPLRS LWTS
AN/VRC-89F MWTS
2X M231 AN/PLQ-8
AN/PRC-148(V)4



SSG 12B30 SQD LDR M4 ILLUM ENVG
SGT 12B20 VEH CDR M4 NVG
X2 SGT 12B20 TM LDR M4 ILLUM ENVG
SPC 12B10 GUNNER M4 NVG
SPC 12B10 CBT ENG M4 ILLUM ENVG
SPC 12B10 CBT ENG M320 ILLUM ENVG
X2 PFC 12B10 CBT ENG M4 ILLUM ENVG
PFC 12B10 ODS-E DRVR M4 ILLUM ENVG

x3

ENGR SUPPORT PLT HQ PARA 04

FBCB2 DAGR
EPLRS
AN/VRC-89F
AN/UYK-128(V)3
AN/PRC-148(V)4



2LT 12A00 PLT LDR M4 ILLUM ENVG
PFC 12B10 DRIVER M4 NVG

FBCB2 DAGR
EPLRS
AN/VRC-89F
AN/UYK-128(V)3
AN/PRC-148(V)4



SFC 12B40 PLT SGT M4 ILLUM ENVG
SPC 12B10 CBT EN M4 NVG

BREACH SQUAD PARA 05

FBCB2 M250
.50 CAL
DAGR
EPLRS
AN/VRC-90F



SGT 12B20 ABV CDR N4 NVG
SPC 12B10 ABV OPR 4 NVG

x2

FBCB2 DAGR
EPLRS
AN/VRC-89F



SGT 12B20 ABV VEH DVR M4 NVG
SPC 12B10 ABV OPERATOR M4 NVG

FBCB2 DAGR
EPLRS
AN/VRC-90F



SPC 12B10 ACE OPR M4 M9

FBCB2 DAGR
EPLRS
AN/VRC-89F



SGT 12B20 AVLB CDR M4 M9
SPC 12B10 AVLB OPERATOR M4 M9

x2

HORIZONTAL CONST SQUAD PARA 06

FBCB2 DAGR
EPLRS HWTS
AN/VRC-90F
AN/VRC-119F
AN/UYK-128(V)3



x2



DAGR AN/PRC-119F



x3



DAGR AN/PRC-119F



x2

SSG 12N30 SQUAD LDR M4 NVG
SGT 12N20 HVY VEH DRIVER M4 NVG
X2 SGT 12N20 HORIZ CONST SGT M4 NVG AN/PRC-119F
SGT 12N20 HORIZ CONST SGT M4 NVG AN/PRC-119F
SPC 12N10 HVY VEH DRIVER M4 NVG
X2 SPC 12N10 HORIZ CONST ENG M4 NVG
X3 SPC 12N10 HOIRZ CONST ENG M4 NVG AN/PRC-119F
X3 PFC 12N10 HOIRZ CONST ENG M4 NVG AN/PRC-119F

CLEARANCE PLT HQ PARA 07 (X2) CLEARANCE SQUAD PARA 08

FBCB2 DAGR
EPLRS
AN/VRC-91F
AN/UYK-128(V)3
AN/PRC-148(V)4



x2

2LT 12A00 PLT LDR M4 ILLUM ENVG
SFC 12B40 PLT SGT M4 ILLUM ENVG
X2 SPC 12B10 COMBAT ENGR M4 ENVG
X2 PFC 12B00 VEH DRIVER M4 NVG

FBCB2 DAGR
EPLRS
AN/VRC-91F



DAGR EPLRS
FBCB2
AN/VRC-90F



DAGR AN/VRC-90F



DAGR AN/VRC-90F



SSG 12B30 SQD LDR M4 ILLUM ENVG
SGT 12B20 TM LDR M4 ILLUM ENVG
SGT 12B20 TM LDR M4 ILLUM ENVG
SPC 12B10 VMMD OPR M4
SPC 12B10 CBT ENG M4 ILLUM ENVG
SPC 12B10 CBT ENG M4 ILLUM ENVG
PFC 12B10 VEH DRIVER M4 ILLUM NVG
PFC 12B10 VEH DRIVER M4 ILLUM NVG

x2

EQUIPMENT SUMMARY

WEAPONS			COMMUNICATIONS AND ELECTRONICS		
C60750	COMMAND LAUNCH UNIT: (JAVELIN) 13305405-119	3	C18378	COMPUTER SET: ANUYK-128(V)3	40
L69080	LAUNCHER GRENADE: M320A1	22	C27707	COMPUTER SYSTEM: DIGITAL AN/TYQ-109(V)1	1
L91701	MACHINE GUN CALIBER .50: HEAVY FIXED TURRET TYPE	6	C67436	COMPTER SYSTEM DIGITAL: AN/PYQ-6C	1
M09009	MACHINE GUN 5.56 MILLIMETER: M249	18	N96248	NAVIGATION SET: SATELLITE SIGNALS AN/PSN-13	44
M92362	MACHINE GUN GRENADE 40MM: MK19 MOD III	4	P49587	PJH SURFACE VEHICLE RADIO SET: ANV/SQ-2(V)	40
M92420	MACHINE GUN 7.62 MILLIMETER: FIXED RH FEED	13	P99881	PROCESSOR GROUP SIG DATA: (CAISI 2.0) OL-701A/TYQ	1
M92454	MACHINE GUN 7.62 MILLIMETER: M240L	9	R44999	RADIO SET: AN/VRC-89F(C)	17
M92841	MACHINE GUN: 7.62MM M240B	4	R45543	RADIO SET: AN/VRC-92F(C)	4
P98152	PISTOL 9MM AUTOMATIC: M9	7	R68044	RADIO SET: AN/VRC-90F(C)	18
R97234	RIFLE 5.56 MILLIMETER: M4	90	R68146	RADIO SET: AN/VRC-91F(C)	2
S40541	SHOTGUN: 12 GAGE	18	R83141	RADIO SET: AN/PRC-119F(C)	4
S56419	SUBMACHINE GUN 5.56 MILLIMETER: PORT FIRING M231	26	T40405	TAPE READER GENERAL PURPOSE: KOI-18/TSEC	1
Z00686	MACHINE GUN: CALIBER .50	3	Z00384	COMPUTER SYSTEM DIGITAL: AN/PYQ-10(C)	45
			Z01320	RADIO SET: AN/PRC-148 (V) 4 URBAN JEM	44
VEHICLES, TRAILERS AND TRLR MTD SYSTEMS			MISC EQUIPMENT		
C11158	CARRIER ARMORED COMMAND POST: FULL TRACKED	1	A33020	ALERT CHEMICAL AGENT AUTOMATIC M22	7
C18234	CARRIER PERSONNEL FULL TRACKED: ARMORED (RISE)	1	B84404	BOA RECONNAISSANCE: PNEUMATIC 3-MAN	3
M31793	M2A2ODS: FOR ENGINEERS	13	C05111	MONITOR CHEMICAL AGENT:	9
T34704	TRUCK UTILITY: ECV ARMAMENT CARRIER W/IAP ARMOR READY M1151A1	2	C7968	CONTROL REMOTE LANDMINE SYSTEM: M71	12
T37588	TRUCK UTILITY EXPANDED CAPACITY ENHANCED: M1152A1	5	C7993	DETECTING SET: MINE AN/PSS-14	38
T39586	TRUCK CARGO: TACTICAL 8X8 HEAVY EXPANDED MOBILITY W/MED CRANE	1	F91490	DEMOLITION SET EXPLOSIVE: INITIATING ELECTRIC AND SEMI ELECTRIC	9
H53576	HIGH MOBILITY ENG EXCAVATOR (HMEE): TYPE I	2	G18358	GEN SET: DED SKID MTD 3KW 60HZ	1
T56383	TRUCK UTILITY EXPANDED CAPACITY ENHANCED 4X4: M1165A1	2	J00697	JOINT CHMCL AGENT: DETECTOR	7
T61908	TRUCK CARGO: MTV W/E	1	M12986	MASK CHEMICAL BIOLOGICAL JOINT SERVICE GENERAL PURPOSE: FIELD M50	28
T93761	TRAILER: PALLETIZED LOADING 8X20	4	M13236	MASK CHEMICAL-BLGCJL JNT SRV GNL PRPSE: CMBT VHL CRWMN M51	122
T95992	LIGHT TACTICAL TRAILER: 3/4 TON	5	R20684	RADIAC SET: AN/VDR-2	11
W76473	TRACTOR FULL TRACKED HIGH SPEED: ARMORED COMBAT EARTHMOVER (ACE)	6	R30925	RADIAC SET: AN/PDR-75	1
W95811	TRAILER CARGO: 1-1/2 TON 2 WHEEL W/E	9	R31061	RADIAC SET: AN/UDR-13	5
W98825	TRAILER TANK: WATER 400 GALLON 1-1/2 TON 2 WHEEL W/E	1	S83835	SMALL UNMANNED AIRCRAFT SYSTEM (SUAS): RAVEN B (MIP)	1
Z01092	BREACHER COMPLEX OBSTACLE FULL TRACKED: ASSAULT XM1150	6	S93791	SOF DEMOLITION KIT: M303	4
Z36683	TRAILER TANK WATER (CAMEL): 800 GAL 5 TON W/E	1	W34511	TOOL KIT CARPENTERS: ENGINEER PLATOON W/CHEST	4
			W34648	TOOL KIT CARPENTERS: ENGINEER SQUAD W/CHEST	12
			W48074	TOOL KIT PIONEER ENGINEER COMBAT PLATOON: TOOLS FOR MANUAL LABOR	4
			W48211	TOOL KIT PIONEER ENGINEER PLATOON: GENERAL USE	1
			W48348	TOOL KIT PIONEER ENGINEER SQUAD: LAND CLR AND BLDG ERECTION	11
NIGHT VISION/OBSERVATION			Z01476	URBAN OPERATIONS: PLATOON	3
D41659	DRIVERS ENHANCERS: AN/VAS-5	10	Z01531	URBAN OPERATIONS SQUAD SET:	9
J03261	ILLUMINATOR: INFRARED	72			
M79678	MONOCULAR NIGHT VISION DEVICE: AN/PVS-14	68			
N05482	NIGHT VISION: GOGGLE	33			
N07848	NIGHT VISION DEVIC: AN/PSQ-20	51			
S60356	SIGHT: THERMAL AN/PAS-13B(V)1	9			
S90535	MEDIUM WEAPON THERMAL SIGHT (MWTS): AN/PAS-13(V)2	31			
S90603	HEAVY WEAPON THERMAL SIGHT (HWTS): AN/PAS-13(V)3	7			
T27221	TARGET LOCATION AND OBSERVATION: AN/PLQ-8	9			

BRIGADE SIGNAL COMPANY, BEB, BCT 11307R100 3/0/42/145

COMPANY HEADQUARTERS PARA 01 SMALL CMD POST SUPPORT TM PARA 02 RETRANSMISSION TM PARA 03

MISSION: To provide 24-hour operational Command, Control, Communications, Computer, Intelligence, Surveillance, and Reconnaissance (C4ISR) signal systems network to the supported Brigade Combat Team, which includes deploying, installing, operating, and maintaining these systems.

FBCB2 AN/VAS-5
2X NVG DAGR
EPLRS MK-19
AN/VRC-92F
AN/VRC-104(V)3
HWTS
KOI-18/TSEC



CPT 25A00 CDR M4 M9
1SG 25U5M 1SG M4

FBCB2 AN/VAS-5
MK-19
2X NVG
DAGR
EPLRS
AN/VRC-90F
HWTS



SGT 92Y20 SUPPLY NCO M4
SPC 92Y10 SUPPLY SP M320

FBCB2 X2 NVG
DAGR EPLRS
AN/VAS-5
AN/VRC-89F



SGT 25Q20 SR XMSN SYS OPR-MNT M4
SPC 25Q10 XMSN SYS OPR-MNT M4

AN/VAS-5
2X NVG
AN/VRC-90F



SPC 25Q10 XMSN SYS OPR-MNT M4
SPC 25N10 NODAL NT SYS OPR-MNT M4
PFC 25N10 NODAL NT SYS OPR-MNT M4
PFC 25Q10 XMSN SYS OPR-MNT M249

FBCB2 x2 NVG
DAGR EPLRS
AN/VAS-5
X3 AN/VRC-92F



SGT 25U20 TEAM CHIEF M4
SPC 25U10 RETRANS OPR M4
PFC 25U10 RETRANS OPR M249

REPLACED BY WIN-T WHEN DOCUMENTED

x2 PLT HQ PARA 04

FBCB2 2X NVG
DAGR EPLRS
AN/VAS-5
AN/VRC-90F
AN/VRC-104(V)3
KOI-18/TSEC



1LT 25A00 PLT LDR M4
SFC 25W40 PLT SGT M4

x2

(X2) JOINT NTRWK NODE/SMART-T TM PARA 05

FBCB2 AN/VAS-5
2X NVG
DAGR
EPLRS
AN/VRC-90F



SGT 25N20 SR NODAL NT SYS OPR-MNT
PFC 25N10 NODAL NET SYS OPR M4

FBCB2 x2 NVG
AN/VAS-5 DAGR
EPLRS KSV-3
AN/VRC-90F
AN/TYQ-122



SPC 25N10 NODAL NET SYS OPR-MNT M4

AN/VAS-5
2X NVG
DAGR
EPLRS
AN/VRC-90F



SPC 25S10 SATCOM SYS OPR-MNT M4
PFC 25S10 SATCOM SYS OPR-MNT M4

AN/VAS-5 2X NVG
AN/VRC-90F
MK-19 HWTS
AN/VRC-104(V)3



SPC 25Q10 RANGE EXT OPR M4

all Soldiers and equip x2

HIGH CAP LINE OF SIGHT SECT PARA 06

AN/VAS-5 2X NVG
DAGR
AN/VRC-90F
AN/TRC-190(V)3



SGT 25Q20 SR XMSN SYS OPR M4
SPC 25Q10 XMSN SYS OPR M4
SPC 25Q10 XMSN SYS OPR M4
SPC 25Q10 XMSN SYS OPR M4
PFC 25Q10 XMSN SYS OPR M259

x2

RETRANSMISSION TEAM PARA 07

FBCB2 AN/VAS-5
2X NVG
3X AN/VRC-92F



SGT 25U20 TM CH M4
SPC 25U10 RETRANS OPR M4
PFC 25U10 RETRANS OPR M4

x2

EPLRS NETWORK MANAGER AND GATEWAY PARA 08

FBCB2 DAGR
X2 NVG EPLRS
AN/VAS-5 AN/VRC-90F
AN/GRC-229 KOI-18/TSEC
KOK-13/TSEC AN/TSQ-158



SSG 25C30 ELPRS NCS SUPV M4
SP4 25C10 EPLRS NCS OPR M4
PFC 25C10 EPLRS NCS OPR M249

x2



SGT 25C20 SR EGRU OPR M4
SP4 25C10 EGRU OPR M4

x2

EQUIPMENT SUMMARY

WEAPONS

L69012	LAUNCHER GRENADE: M203A2	1
L69080	LAUNCHER GRENADE: M320A1	1
M09009	MACHINE GUN 5.56 MILLIMETER: M249	6
M39263	MACHINE GUN: LIGHT 5.56MM M249	4
M92362	MACHINE GUN GRENADE 40MM: MK19 MOD III	4
P98152	PISTOL 9MM AUTOMATIC: M9	1
R97234	RIFLE 5 56 MILLIMETER: M4	50

VEHICLES, TRAILERS AND TRLR MTD SYSTEMS

G42170	GEN SET DED TM: 10KW 60HZ MTD ONM116A2 PU-798	3
G42238	GEN SET DED TM: 5KW 60HZ MTD ON M116A2 PU-797	6
T37588	TRUCK UTILITY EXPANDED CAPACITY ENHANCED: M1152A1	18
T56383	TRUCK UTILITY EXPANDED CAPACITY ENHANCED 4X4: M1165A1	8
T61908	TRUCK CARGO: MTV W/E	1
T95924	TRAILER CARGO: HIGH MOBILITY 1-1/4 TON	2
T95992	LIGHT TACTICAL TRAILER: 3/4 TON	8
Z36683	TRAILER TANK WATER (CAMEL): 800 GAL 5 TON W/E	1

NIGHT VISION/OBSERVATION

D41659	DRIVERS ENHANCERS: ANVAS-5	27
N05482	NIGHT VISION: GOGGLE	54
S90535	MEDIUM WEAPON THERMAL SIGHT (MWTS): ANPAS-13(V)2	4
S90603	HEAVY WEAPON THERMAL SIGHT (HWTS): ANPAS-13(V)3	4

COMMUNICATIONS AND ELECTRONICS

A81826	ANTENNA: AB-1404/TRC	2
C18378	COMPUTER SET: ANUYK-128(V)3	14
C27707	COMPUTER SYSTEM: DIGITAL ANTYQ-109(V)1	1
E03028	ELECT KEY GEN DEDICATED LOOP ENCRYPTION DEVICE: TSEC/KG-84	4
M13833	MAST: AB-1339A/G	6
N04580	NET CONTROL STATION: ANTSQ-158	2
N96248	NAVIGATION SET: SATELLITE SIGNALS AN/PSN-13	18
P49587	PJH SURFACE VEHICLE RADIO SET: ANV SQ-2(V)	16
P99881	PROCESSOR GROUP SIG DATA: (CAISI 2.0) OL-701A/TYQ	1
R44999	RADIO SET: ANVRC-89F(C)	1
R45543	RADIO SET: ANVRC-92F(C)	12
R68044	RADIO SET: ANVRC-90F(C)	20
R78005	RADIO SET GRID REFERENCE UNIT: ANV SQ-2 (N)4	2
R87139	RADIO ST: ANVRC-104(V)3 150 WATT W/PRC-150 HF RADIO	6
R90451	RADIO TERMINAL: LINE OF SIGHT MULTI-C ANTRC-190C(V)1	4
R90587	RADIO TERMINAL: LINE OF SIGHT MULTI-C ANTRC-190C(V)3	2
R91580	RADIO TERMINAL SET: AN/GRC-229	2
S01373	SPEECH SECURITY EQUIPMENT: TSEC/KY-57	6
S24749	SWITCHING GROUP: DIGITAL DATA OA-9511/TYQ	2
T40405	TAPE READER GENERAL PURPOSE: KOI-18/TSEC	5
T43146	TELECONFERENCE SYS: ANTYQ-122	2
T81733	TERMINAL: SATELLITE COMMUNICATION AN/TSC-154	2
Z00056	PROCESSOR GROUP SIGNAL DATA: OL-700/TYQ	1
Z00384	COMPUTER SYSTEM DIGITAL: AN/PYQ-10(C)	14
Z00562	JOINT NODE NETWORK (JNN) CENTRAL OFC TELEPHONE AUTOMATIC: AN/TTC	2
Z00564	BATTALION COMMAND POST(SWITCHING GROUP): OM-XXX	1
Z62433	REKEYING CONTROLLER: KOK-13/TSEC	2
Z92849	TRANSEC MODULE: KSV-3	2

MISC EQUIPMENT

A33020	ALARM: CHEMICAL AGENT AUTOMATIC M22	10
C05701	MONITOR CHEMICAL AGENT:	2
G18358	GEN SET: DED SKID MTD 3KW 60HZ	6
G36237	GENERATOR SET DIESEL: 60HZ AC MEP-531A	2
J00697	JOINT CHM CL AGENT: DETECTOR	10
M12986	MASK CHEMICAL BIOLOGICAL JOINT SERVICE GENERAL PURPOSE: FIELD M50	56
R20684	RADIAC SET: ANVDR-2	12
R30925	RADIAC SET: AN/PDR-75	1

MILITARY INTELLIGENCE COMPANY, BEB, BCT

34128RA00
4/5/64/ 73

COMPANY HEADQUARTERS PARA 01

MISSION.

To provide timely, relevant, accurate, and synchronized Intelligence, Surveillance, and Reconnaissance (ISR) support to the maneuver units within the Brigade Combat Team, and support the BCT commander, staff and subordinates during the planning, preparation, and execution of multiple, simultaneous decisive actions on a distributed battlefield.

X2 NVG HWTS FBCB2 AN/VRC-92F	DAGR EPLRS AN/VAS-5	2X NVG HWTS DAGR 40MM AN/VRC-90F	.50 CAL X2 NVG X4 M-249 MK93 MK
---------------------------------------	---------------------------	--	---

CPT 35D00 CDR M4 M9 SPC 92Y10 SUPPLY SP M249	1LT 35D00 XO M4 1SG 35X5M 1SG M4 SGT 92Y20 SUPPLY NCO M4
---	--

IEW SYSTEMS INTEGRATION SECTION PARA 02

INFO COLLECTION PLT HQ'S PARA 03

OPS MGMT TEAM PARA 04

CRYPTOLOGIC SUPPORT TEAM (CST) PARA 05

2X OL-701A/TYQ AN/VRC-90F	2X NVG AN/VRC-90F AN/ASM-146	AN/NJQ-37
------------------------------	------------------------------------	-----------

CW2 353T0 IEW EQUIP TECH M4
SPC 35T10 MI SYS MNTR./INTGR M4
SGT 35T20 MI SYS MNTR./INTGR M4
SPC 35T10 MI SYS MNTR./INTGR M4
T10 MI SYS MNTR./INTGR M4
AN/ASM-147
AN/VRC-90
SGT 92A20 EQUIP REC/PARTS SGT M4
SPC 35T10 MI SYS MNTR./INTGR M249

2X NVG AN/VRC-90F

2LT 35D00 PLT LDR M4
SFC 35F40 PLT SGT M4

DAGR 2X NVG MBTR AN/VAS-5 AN/VRC-91F	EPLRS AN/PYQ-3 AN/PYQ-8 AN/PC-5 AN/VRC-91F
--	--

CW2 351M0 HUMINT COLL TECH M4 M9
SSG 35M3L HUMINT COLL M4 M9
SPC 35M10 HUMINT COLLECTOR M4 M9
PFC 35M10 HUMINT COLLECTOR M4

X2 NVG DAGR AN/VRC-90F AN/MSW-23	FBCB2 EPLRS AN/MSW-24 PROPHET-CTRL	2X NVG AN/VRC-90F AN/MSW-24
---	---	-----------------------------------

CW2 352N0 SIGINT ANLST TECH M4
SGT 35N20 SIGINT ANLST M4
SPC 35N10 SIGINT ANLST M4
SSG 35P30 SR CRYT LNGST M4
SPC 35N10 SIGINT ANLST M4
PFC 35N10 SIGINT ANLST M4

COMMON GROUND SENSOR (DCGS-A) PARA 06

RELEVANT ISR TO THE EDGE (RITE) PARA 07

SYNCHRONIZATION AND COLL MGMT SECTION PARA 08

DAGR 2X NVG AN/PSC-5 KOI-18/TSEC	EPLRS AN/VAS-5 AN/VRC-92F	2X NVG AN/VAS-5 AN/VSQ-2D(V)1 AN/TSQ-179
---	---------------------------------	---

SSG 35G30 IMAGERY SGT M4
SPC 35G10 IMAGERY ANLST M4
SGT 35G20 IMAGERY ANLST M4
SPC 35G10 IMAGER ANLST M4
PFC 35G10 IMAGERY ANLST M4
PFC 35G10 IMAGERY ANLST M249

2X NVG AN/VAS-5 AN/VRC-90F	NVG AN/TSQ-190(V)2/3 (TROJAN SPIRIT)
----------------------------------	--

SGT 35F20 INTEL ANLST M4
SPC 35F10 INTEL ANLST M4
SPC 35F10 INTEL ANLST M4

2X NVG FBCB2 AN/TYQ-93 AN/VRC-92F	DAGR EPLRS AN/TYQ-103 AN/VRC-92F	2X NVG DAGR AN/VRC-92E	M249 AN/VRC-90F AN/VRC-92E	2X NVG DAGR AN/VRC-92E	M249 AN/VRC-90F AN/VRC-92E
--	---	------------------------------	----------------------------------	------------------------------	----------------------------------

CW2 350F0 ALL SOURCE INTEL TECH M4
SSG 35F30 INTEL ANLST M4
CW2 350F0 ALL SOURCE INTEL TECH M4
SFC 35F40 SR INTEL SGT M4
SPC 35N10 SIGINT ANLST M4
SGT 35F20 INTEL ANLST M4
X2 SPC 35F10 INTEL ANLST M4
X2 PFC 35F10 INTEL ANLST M4

MULTI-FUNCTION PLT HQ PARA 09

EXPLOITATION TEAM PARA 10

BCT Mft SECTION PARA 11

STAFF WEATHER OFFICE PARA 12

DAGR EPLRS AN/VAS-5 AN/VRC-92F

1LT 35D00 PLT LDR M4
SFC 35M40 PLT SGT M4

FBCB2 2X NVG EPLRS AN/VRC-92F AN/PSC-5	AN/PYQ-7 AN/PYQ-3 DAGR KOI-18/TSEC
--	---

SGT 35F20 INTEL ANLST M4
SPC 35F10 INTEL ANLST M4
PFC 35F10 INTEL ANLST M4

AN/VAS-5 2X NVG FBCB2 M240B EPLRS AN/PSC-5	AN/VRC-90F AN/PRC-119F HWTS DAGR AN/VRC-92F
---	---

SSG 35M30 HUMINT COLL SGT M4 M9
SGT 35M2L HUMINT COLLECTR M4 M9
SPC 35M10 HUMINT COLL SPC M4 M9
PFC 35M10 HUMINT COLL SPC M4 M9

2X NVG DAGR EPLRS AN/VRC-90F	AN/MLQ-40(V)4 PROPHET-SENSOR
---------------------------------------	---------------------------------

SGT 35P2L CRYPTO LINGUIST M4
SPC 35P1L CRYPTO LINGUIST M4
SPC 35P1L CRYPTO LINGUIST M4

DAGR 2X NVG AN/VRC-90F	EPLRS AN/GMQ-36
------------------------------	--------------------

*SSG 00D30 AIRFORCE STAFF NCO M4
SGT 00D20 AIR FORCE STAFF NCO M4
SGT 00D20 AIR FORCE STAFF NCO M4
SGT 00D20 AIR FORCE STAFF NCO M4

x3

EQUIPMENT SUMMARY

WEAPONS

L69080	LAUNCHER GRENADE: M320A1	4
M09009	MACHINE GUN 5.56 MILLIMETER: M249	4
M39263	MACHINE GUN: LIGHT 5.56MM M249	7
M92362	MACHINE GUN GRENADE 40MM: MK19 MOD III	1
M92841	MACHINE GUN: 7.62MM M240B	2
P98152	PISTOL 9MM AUTOMATIC: M9	17
R97234	RIFLE 5 56 MILLIMETER: M4	63
Z00686	MACHINE GUN: CALIBER .50	1

VEHICLES, TRAILERS AND TRLR MTD SYSTEMS

G35851	GENERATOR SET DIESEL ENGINE TM: PU-803	1
G78374	GENERATOR SET: DIESEL ENG TRLR -MTD 15KW 60HZ	1
P42262	POWER PLANT: DIESEL TRL/MTD 10KW60HZ AN/NJQ-37	3
P49587	PJH SURFACE VEHICLE RADIO SET: ANV/SQ-2(V)	14
T34704	TRUCK UTILITY: ECV ARMAMENT CARRIER W/IAF ARMOR READY M1151A1	6
T37036	TARGET ACQUISITION SUBSYSTEM: COMMON GROUND STATION ANTSQ-179(V)	1
T37588	TRUCK UTILITY EXPANDED CAPACITY ENHANCED: M1152A1	8
T56383	TRUCK UTILITY EXPANDED CAPACITY ENHANCED 4X4: M1165A1	8
T61908	TRUCK CARGO: MTV W/E	6
T95555	TRAILER CARGO: MTV W/DROPSIDES M1095	1
T95924	TRAILER CARGO: HIGH MOBILITY 1-1/4 TON	7
T95992	LIGHT TACTICAL TRAILER: 3/4 TON	4
Z36683	TRAILER TANK WATER (CAMEL): 800 GAL 5 TON W/E	1

NIGHT VISION/OBSERVATION

D41659	DRIVERS ENHANCERS: AN/VAS-5	14
N05482	NIGHT VISION: GOGGLE	56
S90535	MEDIUM WEAPON THERMAL SIGHT (MWTS): AN/PAS-13(V)2	9
S90603	HEAVY WEAPON THERMAL SIGHT (HWTS): AN/PAS-13(V)3	2

COMMUNICATIONS AND ELECTRONICS

A35329	ALL SOURCE ANALYSIS SYSTEM: AN/TYQ-93	5
C18176	COMPUTER SYSTEM: DIGITAL AN/TYQ-103	1
C18244	COMPUTER SYSTEM: DIGITAL AN/PYQ-7	1
C18312	COMPUTER SYSTEM: DIGITAL AN/PYQ-3	4
C18378	COMPUTER SET: AN/UJK-128(V)3	15
C19266	COUNTER ELECTRONIC DIGITAL READOUT: AN/USM-459	1
C27707	COMPUTER SYSTEM: DIGITAL AN/TYQ-109(V)1	1
C43399	CENTRAL: COMMUNICATIONS AN/TSQ-226(V)3	1
C77823	COMPUTER: SYSTEM DIGITAL AN/PYQ-8	6
E08940	ENCRYPTION-DECRYPTION EQUIPMENT: TACLANE KG 175	2
E94970	CONTROL RADIO SET: C-2299/VRC	1
J41800	INTEGRATED METEOROLOGICAL SYSTEM LIGHT: AN/GMQ-36	1
M18029	MBITR: URBAN VERSION	6
N96248	NAVIGATION SET: SATELLITE SIGNALS AN/PSN-13	19
P49587	PJH SURFACE VEHICLE RADIO SET: ANV/SQ-2(V)	14
P99881	PROCESSOR GROUP SIG DATA: (CAISI 2.0) OL-701A/TYQ	4

R22666	RADIO FREQUENCY POWER TEST SET: AN/URM-213	1
R45543	RADIO SET: AN/VRC-92F(C)	7
R57606	RADIO SET: AN/PSC-5	7
R68044	RADIO SET: AN/VRC-90F(C)	14
R68146	RADIO SET: AN/VRC-91F(C)	6
R83141	RADIO SET: AN/PRC-119F(C)	2
R87139	RADIO ST: AN/VRC-104(V)3 150 WATT W/PRC-150 HF RADIO	1
S01373	SPEECH SECURITY EQUIPMENT: TSEC/KY-57	1
T37036	TARGET ACQUISITION SUBSYSTEM: COMMON GROUND STATION AN/TSQ-179(V)	1
T40405	TAPE READER GENERAL PURPOSE: KOI-18/TSEC	3
Z00384	COMPUTER SYSTEM DIGITAL: AN/PYQ-10(C)	29
Z00993	DETECTING SYSTEM COUNTERMEASURES: AN/MLQ-40(V)4	2
Z01041	DATA ANALYSIS CENTRAL: AN/MSW-24	1
Z01162	COMPUTER SYSTEM: DIGITAL AN/TYQ-139	1
Z01577	INTERCONNECTING GROUP: ON-721/V	2

MISC EQUIPMENT

A33020	ALARM: CHEMICAL AGENT AUTOMATIC M22	13
C05701	MONITOR CHEMICAL AGENT:	6
G74711	GEN SET: DED SKID MTD 10KW 60HZ	2
H01907	ELECTRONIC SHOP SHELTER MOUNTED AVIONICS: AN/ASM-146 LESS POWER	1
H01912	ELECTRONIC SHOP SHELTER MOUNTED AVIONICS: AN/ASM-147 LESS POWER	1
M12986	MASK CHEMICAL BIOLOGICAL JOINT SERVICE GENERAL PURPOSE: FIELD M50	67

Tactical Unmanned Aircraft System (TUAS) Platoon, BEB, ABCT

01708RA00
0/2/25/27

MISSION: To provide airborne imagery intelligence support.

PLT HQ PARA 01

AN/TYQ-151(V)2
AN/VRC-92F

CW3 150UB PLT LDR M4
SFC 15W40 PLT SGT M4
CW2 150U0 UAS OPS TECH M4

MSN PLNG & CTL SEC PARA 02

FBCB2
2X NVG
DAGR
EPLRS
COMPUTER SYS DIGITAL
AN/VAS-5
AN/VRC-92F

Ground Control
Station (TUAV-SHADOW)



AN/UYK-128(V)3
AN/TYQ-151(V)1
AN/TYQ-151(V)3
x2 AN/TYQ-150(V)1
x2 AN/VRC-89F
AN/VRC-92F
GDT TUAV-SHADOW



x2

SSG 15W30 UAV SGT M4	SGT 15W20 UAV OPR M4
SGT 15W20 UAV OPR M4	PFC 15W10 UAV OPR M4
SPC 15W10 UAV OPR M4	PFC 15W10 UAV OPR M4
SPC 15W10 UAV OPR M4	SPC 15W10 UAV OPR M4
SPC 15E10 UAS SYS REP M249	

LAUNCH & RECOVERY SECTION PARA 03

AN/TYQ-151(V)2
x5 AN/TYQ-151(V)1
x2 NVG

(EQUIP VEH)

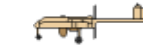

x4

SFC 15E40 SR UAS SYS CHIEF M4
SSG 15W30 UAV SGT M4
SSG 15E30 UAS SYS TECH INSP M4
SGT 15E20 UAS SYS TEP TM CH M4
SGT 15W20 UAV OPR M4
SGT 15W20 UAV OPR M4

x2 OL-701A/TYQ
AN/VRC-89F
AN/TYQ-151(V)1 ULLS-A(E)
x2 NVG

ATV



AN/VRC-89F
PGDT
AN/TYQ-151(V)1 ULLS-A(E)
x2 NVG



x2 OL-701/TYQ
AN/VRC-89F
AN/TYQ-151(V)1 ULLS-A(E)
AN/TYQ-151(V)2
x2 NVG

MSMF



SGT 15E20 UAS SYS TECH INSP M4
PFC 15E10 UAS SYS REP M4
PFC 15W10 UAV OPR M4
PFC 15W10 UAV OPR M4
SPC 15W10 UAV OPR M4
SPC 15E10 UAS SYS REP M4
SPC 15E10 UAS SYS REP M4
SPC 15W10 UAV OPR M4

EQUIPMENT SUMMARY

WEAPONS

MACHINE GUN 5.56MM M249 ----- 3
RIFLE 5.56MM M4 CARBINE----- 24

VEHICLES, TRAILERS, AND TRLR MTD SYSTEMS

TRUCK UTILITY EXP CAPACITY ENH 4X4: M1152A1----- 7
TRUCK CARGO: 4X4 LMTV (M1078)----- 1
TRAILER HIGH MOBILITY 1-1/4T (M1102)----- 4

MISCELLANEOUS EQUIPMENT

GEN SET DIESEL: 60HZ AC MEP-531A----- 8
GEN SET: DED SKID MTD 10KW 60HZ (MEP-803A)----- 2
SAW CHAIN: GAS DRVN BAR FRAME----- 2

TUAS SYSTEM EQUIPMENT

AIR VEHICLE TRANSPORTER: (AVT) (TUAV-SHADOW)----- 1
GROUND CONTROL STATION (GCS): (TUAV-SHADOW)----- 2
MOBILE SECTION MULTI-FUNCTIONAL : (MSMF)----- 1
TACT UNMANNED AERIAL VEHICLE SYSTEM: (SHADOW)----- 1
UNMANNED AERIAL VEHICLE LAUNCHER: (TUAV-SHADOW)---- 2
PORTABLE GROUND DATA TERMINAL (PGDT)----- 1
PORTABLE GROUND CONTROL STATION (PGCS)----- 1
UNMANNED AERIAL VEHICLE (UAV): (TUAV-SHADOW)----- 4
TACTICAL AUTOMATIC LANDING SYSTEM: (TALS)----- 2
GROUND DATA TERMINAL (GDT): (TUAV-SHADOW)----- 2

COMMUNICATION-ELECTRONICS EQUIPMENT

ANTENNA GROUP: OE-254----- 5
COMP SET DIGIT: AN/UYK-128(V)3 (FBCB2 BFT APPLIQUE)---- 2
COMPUTER SYSTEM DIGITAL: (AMPS)----- 2
COMPUTER SET DIGITAL: AN/TYQ-151(V)2----- 3
COMPUTER SET DIGITAL: AN/TYQ-151(V)3----- 2
COMPUTER SET DIGITAL: AN/TYQ-150(V)1 ULLS-A(E)----- 2
COMPUTER SET DIGITAL: AN/TYQ-151(V)1 ULLS-A(E)----- 10
NAV SET: SATELLITE SIGNALS AN/PSN-13 (DAGR)----- 2
PROCESSOR GRP SIGNAL DATA: (CAISI 2.0) OL-701A/TYQ---- 2
RADIAC SET: AN/VDR-2----- 3
RADIO SET: AN/VRC-89F----- 7
RADIO SET: AN/VRC-92F----- 3

NIGHT VISION/OBSERVATION EQUIPMENT

NIGHT VISION GOGGLES: AN/PVS-7B----- 16

HHT, CAVALRY SQUADRON, ABCT

MISSION.

To provide command, control, and supervision of the tactical operations of the Cavalry Squadron and attached units; unit administration and logistical support for the squadron staff sections; and administrative and medical support to organic and attached units.

HHT, CAVALRY SQDN, ABCT

17316R000
23/01/22/1/145

COMMAND GROUP PARA 01

AN/PSG-14(V)1
M257
MG 7.62 RH FEED
2X NVG
DAGR
EPLRS
AN/VR-92F
AN/PSC-5
AN/VR-104(V)3



LTC 02B00 CDR M9 ENVG AN/PRC-119F
SSG 19D30 VEH CDR M9
SGT 19D20 CFV GUNNER M9
SPC 19D10 CFV DRIVER M9

FBCB2
AN/VAS-5
2X NVG
DAGR
EPLRS
AN/VR-92F
AN/PYQ-128(V)1



FBCB2
AN/VAS-5
DAGR
2X NVG
EPLRS
AN/VR-90F
AN/UJK-128(V)1



CSM 19Z60 CSM M9

*LTC 02B00 CDR M9 ENVG AN/PRC-119F
MAJ 02B00 XO M9 ENVG DAGR
PFC 19D10 VEH DRIVER M4

*WHEN NOT MOUNTED

CURRENT OPS-INTEL/S2 PARA 02

DAGR 2X NVG
AN/VAS-5 AN/VR-92F



CPT 35D00 S2 M4 ENVG
SPC 35F10 INTEL ANLST M4

2X NVG DAGR
EPLRS FBCB2
AN/VAS-5 AN/PSC-5
AN/TYQ-93
AN/VR-92F
KOI-18/TSEC
AN/TYQ-93(V)2
AN/VR-104(V)6
AN/UJK-128(V)1



1LT 35D00 ASST S2 M4
SFC 35F40 SR INTEL SGT M4
SSG 35F30 INTEL SGT M4
SGT 35F20 INTEL ANLST M4
SGT 35F20 INTEL ANLST M4
SGT 35F20 INTEL ANLST M4
SGT 35F20 ISR SYNCH MGR M4
SGT 35F20 ISR SYNCH MGR M4
X3 SPC 35F10 INTEL ANLST M4
SPC 35F10 INTEL ANLST M4
PFC 35F10 INTEL ANLST M4
PFC 35F10 INTEL ANLST M4

CURRENT OPS-OPS/S3 PARA 03

M257
MG 7.62 RH FEED
x2 NVG
DAGR
EPLRS-V1
AN/VR-92F
AN/PRC-119F
AN/VR-104(V)3



MAJ 02B00 S3 M9 ENVG
CPT 19C00 ASST S3 M4
SFC 19D40 ASST OPS SGT M4
SSG 19D30 VEH CDR M9
SGT 19D20 CFV GNR M9
SPC 19D10 CFV DRIVER M9

FBCB2
x2 NVG
DAGR
KOI-18
EPLRS-V1
AN/VR-92F
AN/PSC-5
AN/VR-104(V)3
AN/UJK-128(V)1



MED PWR PLANT

CPT 19C00 ASST S3 M4
CPT 19C00 PLANS OFF M4
SFC 19D40 ASST OPS SGT M4
SGT 19D20 OPS ASST M4
SPC 19D10 CARRIER DVR M4

AN/VAS-5
x2 NVG
DAGR
AN/VR-92F
AN/MRC-149



*MAJ 02B00 S3 M9 ENVG
PFC 19D10 VEH DVR M4
*WHEN NOT MOUNTED ON CFV

AN/VAS-5
2X NVG
AN/VR-90F



1LT 74A00 CBRN OFF M4
SSG 74D30 CBRN NCO M4



AN/MJQ-48 PU
A UNIT
B UNIT

SGT 19D20 OPS ASST M4
SPC 74D10 CBRN DECON SP M4

DAGR HWTS
.50 CAL x2 NVG
FBCB2 AN/VAS-5
EPLRS-V1
AN/VR-91F
AN/UJK-128(V)1



SGM 19Z60 OPS SGT M4
SFC 19D40 ASST OPS SGT M4
PFC 19D10 VEH DVR M4

CURRENT OPS-FIRE SUPPORT PARA 04

SGT 29E20 EW SGT M4
SSG 29E30 EW SGT M4

DAGR 2X NVG
AN/GYK-57 AN/GYK-48(V)1
AN/GYK-48(V)1 X2 AN/VR-92F
AN/VR-104(V)3



MOVED TO FIRES BN

CPT 13A00 FSO M4 ILLUM NVG
SPC 13F10 FIRE SPT SP M4 ILLUM
SGT 13F20 FIRE SPT SGT M4 ILLUM
1LT 13A00 ASST EFFECTS COORD M4 ILLUM
SPC 13F10 FIRE SPT SP M4 ILLUM
SFC 13F40 TGT NCO M4 ILLUM
SFC 13F40 FIRE SPT SGT M4 ILLUM NVG
SPC 13F10 FIRE SPT SP M4 ILLUM

CURRENT OPS-FIRE SPT/TACP PARA 05

*CPT 01A00 AIR FORCE STAFF OFF M4
SSG 00D30 AIR FORCE STAFF NCO M4
SPC 00D10 AIR FORCE STAFF ENLISTED M4

*USAF PERSONNEL NOT ASSIGNED TO UNIT

SUSTAINMENT - S1 PARA 06

x2 NVG
DAGR
AN/VR-90F
AN/TYQ-10(C)
OL-701A/TYQ



CPT 42B00 S1 M4 ENVG
SFC 42A40 SR HR SGT M4
SSG 42A30 HR SGT M4
SGT 42A20 HR SGT M4
SPC 42A10 HR SPC M4
SPC 27D10 PARALEGAL SPC M4
PFC 42A10 HR SPC M4
PFC 42A10 HR SPC M4

SUSTAINMENT - S4 PARA 07

AN/VAS-5
x2 NVG
AN/VR-92F(C)



CPT 19C00 S4 M4 ENVG

FBCB2
x2 NVG
DAGR
EPLRS-V1
AN/PYQ-10(C)
AN/UJK-128
AN/VSQ-2D(V)1
AN/VR-89F
AN/VR-92F(C)
AN/VR-104(V)6
AN/UJK-128(V)1

X2 AN/TYQ-129(V)2
AN/TYQ-109(V)1
OL-701A/TYQ
AN/UJK-90(V)3
KG-175
KOI-18/TSEC



MED PWR PLANT

SFC 92740 SR SUPPLY SGT M4

x2 NVG
DAGR
AN/VR-90F(C)



SGT 92Y20 SUPPLY NCO M4

SUSTAINMENT - UMT PARA 08

x2 NVG
DAGR
AN/PSN-13
AN/VR-90F



CPT 56A00 CHAPLAIN
SGT 56M20 CHAPLAIN ASST M4

HHT, CAVALRY SQDN, ABCT

SUSTAINMENT-C4 OPS/S6 PARA 09

DAGR EPLRS-V1 AN/VRC-90F AN/UYK-128(V)1	x2 NVG AN/GYK-62 AN/PYQ-10(C)	FBCB2 DAGR AN/PYQ-12 AN/GYK-50B AN/UYK-128 AN/TSR-8(GRT) AN/UYK-62 AN/TSQ-243 AN/TSQ-259 AN/VSQ-2D(V)1	x2 NVG EPLRS-V1 AN/VRC-92F AN/TSR-8(GRT) AN/UYK-128 AN/TSR-8(GRT) AN/UYK-62 AN/TSQ-243 AN/TSQ-259 AN/VSQ-2D(V)1
--	-------------------------------------	---	--

CPT 25A00 S6 M4 ENVG
SSG 25U30 SIG INFO SVC NCO M4

SFC 25U40 SECT CHIEF M4
SPC 25B10 LAN MGR M4
SPC 25U10 SIG SPT SYS SP M4
SPC 25U10 SIG SPT SYS MAINT M4
PFC 25B10 LAN MGR M4

x2 NVG
AN/TSR-8
AN/PYQ-10(C)
AN/VRC-90F

BATTALION COMMAND
POST SWITCHING GROUP

SGT 25Q20 SR XMSN SYS OPR-MNT M4
SPC 25Q10 XMSN SYS OPR-MNT M4

x2 NVG
AN/VRC-90F

SSG 25E30 ELECTRO SPECT NCO M4
SPC 25N10 NODAL NET SYS OPR-MNT M4
PFC 25N10 NODAL NET SYS OPR-MNT M4

RETRANSMISSION SECTION PARA 10

FBCB2 x2 NVG AN/PYQ10(C) X2 EPLRS-V1 AN/MRC-149 x2 AN/VSQ-2D(V)1	AN/VAS-5 DAGR AN/UYK-128 x2 AN/VRC-92F(C) AN/UYK-128(V)1 x2 AN/VSQ-2D(V)1	FBCB2 x2 NVG AN/PYQ10(C) X2 EPLRS-V1 AN/MRC-149 x2 AN/VSQ-2D(V)1	AN/VAS-5 DAGR AN/UYK-128 x2 AN/VRC-92F(C) AN/UYK-128(V)1 x2 AN/VSQ-2D(V)1
---	--	---	--

SGT 25U20 TEAM CHIEF M4
SPC 25U10 RETRANS OPR M4
PFC 25U10 RETRANS OPR M4

SGT 25U20 TEAM CHIEF M4
SPC 25U10 RETRANS OPR M4
PFC 25U10 RETRANS OPR M4

FBCB2
x2 NVG
AN/PYQ10(C)
AN/MRC-149
x2 AN/VRC-92F(C)
AN/UYK-128(V)1
x2 AN/VSQ-2D(V)1
 AN/VAS-5 DAGR AN/UYK-128 x2 AN/VRC-92F(C) AN/UYK-128(V)1 x2 AN/VSQ-2D(V)1 |

SSG 25U30 TEAM CHIEF M4
SPC 25U10 RETRANS OPR M4
PFC 25U10 RETRANS OPR M4

TROOP HEADQUARTERS PARA 11

DAGR x2 NVG EPLRS-V1 AN/PYQ-10(C) AN/UYK-128(V)1	FBCB2 AN/VAS-5 AN/VRC-92F(C) AN/PYQ-10(C) AN/UYK-128(V)1
--	--

CPT 19C00 CDR M9
PFC 19D10 DVR M4

DAGR
AN/VAS-5
AN/PYQ-10(C)
AN/VRC-92F(C)

x2 NVG

1LT 19C00 XO M4
PFC 19D10 DVR M4

DAGR
x3 NVG
CROWS
AN/UYK-128
X2 AN/VRC-92F(C)
X2 AN/PSS-14
OL-701A/TYQ
AN/PYQ-10(C)
AN/TYQ-109(V)1

HWTS
M240B .50 CAL
AN/VAS-5
X2 AN/VRC-92F(C)

SSG 25U30 TEAM CHIEF M4
SPC 25U10 RETRANS OPR M4
PFC 25U10 RETRANS OPR M4

x2

1SG 19Z5M 1SG M4
SSG 92Y30 SUPPLY SGT M4
SPC 92Y10 SUPPLY SP M4

MED TREATMENT PLT HQ PARA 13

DAGR x2 NVG EPLRS-V1 AN/VRC-89F AN/TYQ-107(V)1 AN/UYK-128(V)1	FBCB2 AN/VAS-5 AN/PYQ-10(C) AN/UYK-128 AN/VSQ-2D(V)1 AN/TYQ-108(V)3
--	--

CPT 62B00 PLT LDR M4
1LT 70B67 FIELD MED ASST
SFC 68W40 PLT SGT M4

MEDICAL TREATMENT SQUAD PARA 14

DAGR x2 NVG AN/VRC-89F(C) X2 AN/TYQ-106(V)1 X2 AN/PYQ-10(C) X2 AN/UYK-128(V)1	FBCB2 EPLRS-V1 AN/VRC-89F(C) AN/PYQ-10(C) AN/UYK-128(V)1
--	--

x2

x2 NVG
AN/VRC-90F

CPT 62B00 FLD SURGEON
AN/TYQ-107(V)1 AN/TYQ-105(V)1
CPT 65D00 PHYSICIAN ASST M9
AN/TYQ-105(V)1
SSG 68W30 HEALTH CARE SGT M9
AN/TYQ-105(V)1
X2 SGT 68W20 HEALTH CARE SGT M4
AN/TYQ-105(V)1
SPC 68W10 HEALTH CARE SP M4
AN/TYQ-105(V)1
X2 PFC 68W10 HEALTH CARE SP M4
AN/TYQ-105(V)1

AMBULANCE SQUAD PARA 15

FBCB2 DAGR EPLRS-V1 AN/VRC-90F(C) X8 AN/UYK-128(V)1	M259 x2 NVG EPLRS-128 AN/VSQ-2D(V)1 AN/PYQ-10(C) AN/UYK-128(V)1
---	--

SGT 68W20 EM CARE SGT M9
AN/TYQ-105(V)1
SPC 68W10 AIDE/DRIVER M9
AN/TYQ-105(V)1
PFC 68W10 AIDE/DRIVER M9

x8

COMBAT MEDIC SECTION PARA 16

X12 NVG
X3 AN/TYQ-106(V)1
X9 AN/TYQ-105(V)1

SSG 68W30 SECTION NCO M9
SPC 68W10 COMBAT MEDIC M9
SPC 68W10 COMBAT MEDIC M9
SPC 68W10 COMBAT MEDIC M9

x3

MOVED TO FIRES BN FIRES SUPPORT PLT PARA 10

FBCB2 DAGR AN/PVS-6 EPLRS-V1 AN/VRC-92F AN/PED-1 (LLDR) MG 7.62 RH FEED X2 AN/PSG-14(V)1	M257 x2 NVG AN/PSC-5 AN/PLQ-8 AN/VRC-87F AN/UYK-128(V)1
---	--

1LT 13A00 FSO M4 ILLUM NVG
SPC 13F10 FIRE SPT SP M4 ILLUM NVG
PFC 13F10 RTO M4 ILLUM NVG
SSG 13F30 FIRE SPT SGT M4 ILLUM NVG

x3

EQUIPMENT SUMMARY

WEAPONS

L44031 LAUNCHER GRENADE ARMAMENT SUBSYSTEM: M257 5
 L44748 LAUNCHER GRENADE ARMAMENT SUBSYSTEM: SCREEN RP M259 8
 L69080 LAUNCHER GRENADE: M320A1 7
 M92420 MACHINE GUN 7.62 MILLIMETER: FIXED RH FEED 5
 M92841 MACHINE GUN: 7.62MM M240B 4
 P98152 PISTOL 9MM AUTOMATIC: M9 49
 R97234 RIFLE 5 56 MILLIMETER: M4 98
 Z00686 MACHINE GUN: CALIBER .50 2

VEHICLES, TRAILERS AND TRLR MTD SYSTEMS

C11158 CARRIER ARMORED COMMAND POST: FULL TRACKED 4
 C18234 CARRIER PERSONNEL FULL TRACKED: ARMORED (RISE) 8

 D11538 CARRIER COMMAND POST: LIGHT TRACKED 2
 F90796 FIGHTING VEHICLE FULL TRACKED CAVALRY M3A3 2
 G42170 GEN SET DED TM: 10KW 60HZ MTD ONM 116A2 PU-798 1
 P63462 POWER PLANT: UTILITY (MEDIUM) 2
 P63530 POWER PLANT: ELECTRIC TRAILER MOUNTED 1
 T34704 TRUCK UTILITY: ECV ARMAMENT CARRIER W/AP ARMOR READY M1151A1 1

T37588 TRUCK UTILITY EXPANDED CAPACITY ENHANCED: M1152A1 10
 T41135 TRUCK CARGO: MTV W/E W/W 2
 T56383 TRUCK UTILITY EXPANDED CAPACITY ENHANCED 4X4: M1165A1 5
 T60081 TRUCK CARGO: 4X4 LMTV W/E 4
 T61908 TRUCK CARGO: MTV W/E 1
 T95992 LIGHT TACTICAL TRAILER: 3/4 TON 3
 T96564 TRAILER FLAT BED: M1082 TRLR CARGO LMTV W/DROPSIDES 2
 Z01393 M3A3 BFIST WITH FS3: 3
 Z36683 TRAILER TANK WATER (CAMEL): 800 GAL 5 TON W/E 1

NIGHT VISION/OBSERVATION

D41659 DRIVERS ENHANCERS: ANVAS-5 22
 J03261 ILLUMINATOR: INFRARED 19
 M74849 MINI EYESAFE LASER INFRARED OBSERVATION SET (MELIOS): ANPVS-6 3
 M79678 MONOCULAR NIGHT VISION DEVICE: ANPVS-14 8
 N05482 NIGHT VISION: GOGGLE 98
 N07848 NIGHT VISION DEVIC: AN/PSQ-20 6
 R60282 RANGE FINDER-TARGET DESIGNATOR: LASER AN/PED-1 3
 S90535 MEDIUM WEAPON THERMAL SIGHT (MWTs): ANPAS-13(V)2 4
 S90603 HEAVY WEAPON THERMAL SIGHT (HWTs): ANPAS-13(V)3 2
 T27221 TARGET LOCATION AND OBSERVATION: AN/PLQ-8 3

COMMUNICATIONS AND ELECTRONICS

A35329 ALL SOURCE ANALYSIS SYSTEM: ANTYQ-93 2
 A35397 ALL SOURCE ANALYSIS SYSTEM: ANTYQ-93(V)2 1
 C04819 COMTER SYS DIG: AN/PSG-14(V)1 LFED 7
 C17936 COMPUTER SET: AN/GYG-1(V)1 1
 C18277 COMPUTER SET: DIGITAL ANTYQ-107(V)1 1
 C18345 COMPUTER SET: DIGITAL ANTYQ-106(V)1 3
 C18378 COMPUTER SET: AN/UUK-128(V)3 25
 C18641 COMPUTER SYST DIGITAL: AN/PYQ-12 1
 C27435 COMPUTER SYSTEM: DIGITAL ANTYQ-129(V)2 2
 C27503 COMPUTER SYSTEM: DIGITAL ANTYQ-105(V)1 44
 C27707 COMPUTER SYSTEM: DIGITAL ANTYQ-109(V)1 2
 C27963 COMPUTER SYSEM: DIGITAL 3
 C61665 COMMAND CENTER SYSTEM: AN/TSQ-243 1
 C78851 COMPUTER SYSTEM: DIGITAL ANUYQ-90(V)3 1
 C79281 COMPUTER ST FIELD ARTILLERY GENERAL: AN/GYK-48(V)1 1
 E08940 ENCRYPTION-DECRYPTION EQUIPMENT: TACLANE KG 175 1
 J99233 INTERROGATOR SET: ANTYX-1 1
 N96248 NAVIGATION SET: SATELLITE SIGNALS AN/PSN-13 36
 P49587 PJH SURFACE VEHICLE RADIO SET: AN/VSQ-2(V) 30

P99881 PROCESSOR GROUP SIG DATA: (CAISI 2.0) OL-701A/TYQ 5
 T40405 TAPE READER GENERAL PURPOSE: KOI-18/TSEC 7
 Z00058 COMPUTER SYSTEM DIGITAL: AN/PSG-10(V) 3
 Z00384 COMPUTER SYSTEM DIGITAL: AN/PYQ-10(C) 46
 Z00512 COMPUTER SYSTEM DIGITAL: AN/GYK-50A (ISYSCON) (V)4 1
 Z00513 COMPUTER SYSTEM DIGITAL: AN/GYK-50B (ISYSCON) (V)4 1
 Z00564 BATTALION COMMAND POST(SWITCHING GROUP): OM-XXX 1
 Z00930 COMMUNICATIONS SUBSYSTEM: AN/TSQ-259 1
 Z01247 COMPUTER SET: DIGITAL AN/UUK-128(V)1 25
 Z01248 COMPUTER SET: DIGITAL AN/GYK-62B 2
 Z01279 COMMON REMOTELY OPERATED WPN STATION (CROWS): 1
 Z39781 ARMY H RESURCES: WRKSTATION 5

MISC EQUIPMENT

A33020 ALARM: CHEMICAL AGENT AUTOMATIC M22 21
 C05701 MONITOR CHEMICAL AGENT: 2
 C79000 COLLECTIVE PROTECTION EQUIPMENT: NBC SIMPLIFIED M20 4
 C96840 CONTROL REMOTE LANDMINE SYSTEM: M71 4
 D03932 DETECTING SET: MINE AN/PSS-14 2
 D82404 DECONTAMINATING APPARATUS: PWR DRVN LT WT 2
 G18358 GEN SET: DED SKID MTD 3KW 60HZ 5
 G42170 GEN SET DED TM: 10KW 60HZ MTD ONM 116A2 PU-798 1
 H48896 FILTER UNIT GAS PARTICULATE ARMORED AMBULANCE: M14 8
 J00697 JOINT CHMCL AGENT: DETECTOR 21
 J01197 JOINT SERVICE TRANSPORTABLE DECONTAMINATION 2
 M12986 MASK CHEMICAL BIOLOGICAL JOINT SERVICE GENERAL PURPOSE: FIELD M50 82
 M13236 MASK CHMICAL-BLGCAL JNT SRV GNL PRPSE: CMBT VHL CRWMN M51 66

M23673 MEDICAL EQUIPMENT SET CHEMICAL AGENT PATIENT TREATMENT: 2
 M25865 MEDICAL EQUIPMENT SET CHEMICAL AGENTS PATIENT DECONTAMINATION: 1
 M26413 MEDICAL EQUIPMENT SET GROUND AMBULANCE: 8
 M30156 MEDICAL EQUIPMENT SET SICK CALL FIELD: 2
 M30499 MEDICAL EQUIPMENT SET TRAUMA FIELD: 2
 R20684 RADIAC SET: ANVDR-2 26
 R30925 RADIAC SET: AN/PDR-75 1

HHT, CAV SQDN, ABCT

CAVALRY TROOP, CAV SQDN, ABCT

17207R000
4/0/89/93

TROOP HEADQUARTERS PARA 01

MORTAR SECTION PARA 02

Mission: To perform accurate and timely ground reconnaissance and surveillance in support of brigade operations, enabling the commander to employ his ground forces or joint fires precisely at the time and place of his choosing.

M257 DAGR
FHMUX EPLRS-V1
MG 7.62 RH FEED
AN/VRC-90F
AN/VRC-92F
AN/MRC-149

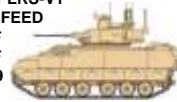

CPT 19C00 CDR M9 ENVG
AN/PRC-119F
SGT 19D20 CFV GNR M9
SPC 19D10 CFV DVR M9

DAGR CROWS
2X NVG AN/VAS-5
HWTS OL-700/TYQ
.50 CAL OL-701A/TYQ
X4 M320A1 AN/TYQ-109(V)1
AN/VRC-92F X4 AN/VSQ-2D(V)1



SGT 92Y20 SUPPLY NCO M4
SPC 92Y10 SUPPLY SP M4

DAGR FBCB2
x2 NVG AN/VAS-5
EPLRS-V1 AN/VRC-92F
AN/UJK-128
AN/PYQ-10(C)
AN/UJK-128(V)1



*CPT 19C00 CDR M9 ENVG AN/PRC-119F
SGT 74D20 CBRN NCO M4

*WHEN NOT MOUNTED IN CFV

DAGR HWTS
FBCB2 x2 NVG
.50 CAL CROWS
EPLRS-V1
AN/VRC-92F
AN/UJK-128
AN/PYQ-10(C)
AN/UJK-128(V)1



1SG 19Z5M 1SG M4 ENVG
SPC 19D10 CARRIER DVR M4

DAGR FBCB2
x2 NVG EPLRS-V1
AN/VRC-92F
AN/VRC-90F
AN/UJK-128
AN/PYQ-10(C)
AN/VRC-104(V)6
AN/UJK-128(V)1



1LT 19C00 XO M4 ENVG
SPC 19D10 CARRIER DVR M4
SSG 19D30 OPS NCO M4
SGT 25U20 FWD SIG SPT NCO M4

DAGR EPLRS
FBCB2 2X NVG
AN/VAS-5
AN/VRC-92F
AN/UJK-128
AN/UJK-128(V)1



SFC 11V40 SECT LDR M4

HWTS .50 CAL
DAGR 2X NVG
MORTAR 120MM
X5 AN/PYQ-10(C)
M95 MFCS
AN/VSQ-2D(V)1
X2 AN/VRC-91F



SSG 11C30 SQD LDR M4
SPC 11C10 GUNNER M4
SPC 11C10 CARRIER DVR M4
PFC 11C10 ASST GNR M4

x2

CAVALRY PLATOON PARA 03 and PARA 04

MK-19 M240L
MWTS HWTS
FBCB2 AN/VAS-5
AN/TAS-8 EPLRS-V1
NVG AN/PRS-9
AN/VRC-92F
AN/UJK-128
AN/VRC-104(V)6
AN/UJK-128(V)1
AN/PED-1 (LLDR)



1LT 19C00 PLT LEADER M4
ILLUM ENVG DAGR AN/PRC-119F
SPC 19D10 SCOUT DRIVER M4 ILLUM
SGT 19D20 TM LDR M4 ILLUM ENVG

MK-19 NVG
LRAS3 FBCB2
AN/VAS-5 AN/TAS-8
EPLRS-V1 AN/VRC-92F
AN/UJK-128
AN/PRC-119F
AN/UJK-128(V)1
AN/VRC-104(V)6
AN/PED-1 (LLDR)



SFC 19D40 PLT SGT M4
ILLUM ENVG DAGR
SGT 19D2B TM LDR M4 ILLUM ENVG
SPC 19D10 SCOUT DVR M4 ILLUM

M257 M320A1
x2 NVG DAGR
HWTS AN/PRS-9
MWTS JAVELIN
AN/PVS-6 EPLRS-V1
AN/VRC-92F AN/PRC-119F
AN/PYQ-10(C)
AN/VRC-89F(C)
AN/VRC-104(V)6
MG 7.62 RH FEED
SHOTGUN 12 GAGE



SSG 19D30 SECT LDR M9
ILLUM ENVG
SGT 19D20 CFV GNR M9 ILLUM
SPC 19D10 CFV DVR M9 ILLUM
SPC 19D10 SCOUT M4 ILLUM ENVG
PFC 19D10 SCOUT M4 ILLUM ENVG
PFC 19D10 SCOUT M4 ILLUM ENVG

x3

x2

.50 CAL M240L HWTS
MWTS FBCB2 x2 NVG
AN/TAS-8 EPLRS-V1
AN/VRC-89F
AN/UJK-128
AN/PRC-119F
AN/PYQ-10(C)
AN/UJK-128(V)1
SHOTGUN 12 GAGE



SGT 19D20 SQD LDR M4
ILLUM NVG DAGR
SPC 19D10 SCOUT DVR M4 ILLUM
PFC 19D10 SCOUT M4 ILLUM ENVG
SPC 19D10 SCOUT M4 ILLUM ENVG

x2

.50 CAL M240L
HWTS MWTS
FBCB2 x2 NVG
EPLRS-V1 AN/TAS-8
AN/VRC-89F AN/UJK-128
AN/PRC-119F
AN/UJK-128(V)1
SHOTGUN 12 GAGE



SGT 19D20 SQD LDR M4
ILLUM NVG DAGR
SGT 19D20 TEAM LDR M4
ILLUM NVG DAGR
SPC 19D10 SCOUT DVR M4 ILLUM
PFC 19D10 SCOUT M4 ILLUM ENVG

EQUIPMENT SUMMARY

WEAPONS

COMMAND AND LAUNCH UNIT (JAVELIN)-----	6
LAUNCHER GRENADE: M320A1-----	10
MACHINE GUN: CALIBER .50 (M2E2)-----	10
MORTAR 120MM-----	2
MACHINE GUN GRENADE 40MM MK-19 MOD III-----	4
MACHINE GUN 7.62MM M240C-----	7
MACHINE GUN 7.62MM: M240L-----	16
PISTOL 9MM AUTOMATIC M9-----	21
RIFLE 5.56MM M4 CARBINE-----	72
SHOTGUN: 12 GAUGE-----	12

VEHICLES, TRAILERS, AND TRLR MTD SYSTEMS

CARRIER 120MM MORTAR: SP ARMORED (M1064)-----	2
CARRIER ARMORED COMMAND POST: (M1068)-----	1
CARRIER PERSONNEL FT ARMORED (RISE) (M113A3)-----	1
FIGHTING VEHICLE: FT CAVALRY M3A3-----	7
TRUCK UTILITY EXP CAPACITY: ARMAMENT CARRIER M1151-----	10
TRUCK UTILITY EXP CAPACITY ENH 4X4: M1152A1-----	1
TRUCK UTILITY EXP CAPACITY ENH 4X4: M1165A1-----	1
TRUCK CARGO: MTV (M1083)-----	1
TRAILER HIGH MOBILITY 1-1/4T (M1102)-----	1
TRAILER TANK WATER (CAMEL) 800 GAL 5 TON-----	1

MISCELLANEOUS EQUIPMENT

GEN SET: DED SKID MTD 5 KW 60HZ (MEP-802A)-----	1
MUNITION: NETWORK COMMAND (SPIDER)-----	1
SAW CHAIN: GAS DRVN BAR FRAME-----	4
SMALL UNMANNED AIRCRAFT SYSTEM: (SUAS) RAVEN B-----	1

COMMUNICATION-ELECTRONICS EQUIPMENT

ANTENNA GROUP: OE-254-----	6
COMPUTER SET: DIGITAL AN/UJK-128(V)1 (FBCB2 APPLIQUE)-----	14
COMPUTER SET DIGITAL: AN/TYQ-109(V)1 (GCSS-A (V)1)-----	1
MORTAR FIRE CONTROL SYSTEM: M95-----	2
NAVIGATION SET: SATELLITE SIGNALS AN/PSN-13 (DAGR)-----	17
PJH SURFACE VEH RADIO SET: AN/VSQ-2(V)1 (EPLRS-V1)-----	21
PROCESSOR GROUP SIGNAL DATA: (CAISI 2.0) OL-701A/TYQ-----	1
RADIAC SET: AN/VDR-2-----	4
RADIO SET: AN/VRC-89F-----	6
RADIO SET: AN/VRC-90F-----	2
RADIO SET: AN/VRC-91F-----	2
RADIO SET: AN/VRC-92F-----	15
RADIO SET: AN/PRC-119F-----	17
RADIO SET: HF AN/VRC-104(V)3-----	11
COMMS SYSTEM AN/MRC-149 (SOLDIER NETWORK EXTENSION)---	1

NIGHT VISION/OBSERVATION EQUIPMENT

DRIVERS VISION ENHANCER: AN/VAS-5-----	13
MINI EYESAFE LASER INFR OBSN DEVICE: (MELIOS): AN/PVS-6-----	2
NIGHT VISION GOGGLES: AN/PVS-7B-----	42
NIGHT VISION DEVICE: AN/PSQ-20 (ENVG)-----	53
RANGE FINDER-TGT DESIGNATOR: LASER AN/PED-1 (LLDR)-----	4
SURVEILLANCE SYS: SCOUT LONG RANGE AN/TAS-8 (LRAS3)-----	10
LIGHT THERMAL WEAPONS SIGHT: AN/PAS-13(V1)-----	4
MEDIUM THERMAL WEAPONS SIGHT: AN/PAS-13(V2)-----	16
HEAVY THERMAL WEAPONS SIGHT: AN/PAS-13(V3)-----	30
LASER TARGET LOCATOR SYSTEM (LTL5)-----	6

HHC, CAB, ABCT 07316R000 28/0/206/1234

COMMAND GROUP PARA 01

CURRENT OPS-INTEL/S2 PARA 02

Mission: To provide command, control, and supervision of the tactical operations of the Combined Arms Battalion and attached units; unit administration and logistical support for the battalion staff sections; and indirect mortar fire support, reconnaissance, and administrative and medical support to organic and attached units.

FBCB2 AN/VRC-104(V)6
M250 x2 M4
.50 CAL MWTS
MG 7.62 FIXED HWTS
DAGR CROWS
EPLRS-V1
AN/VRC-92F



LTC CDR 02B00 M4 M9 ILLUM
ENVG AN/PRC-119F(C)
SGT 19K20 GUNNER M9 ILLUM NVG
SPC 19K10 CREWMAN M9 ILLUM NVG
PFC 19K10 LOADER M9 ILLUM NVG

FBCB2 AN/VAS-5
DAGR
EPLRS-V1
AN/VRC-90F
AN/UJK-128(V)1



CSM 00R60 CMD CSM M4 M9 ILLUM NVG
PFC 11B10 DRIVER M4 ILLUM NVG

FBCB2 AN/VAS-5
DAGR
EPLRS-V1
AN/VRC-92F
AN/VRC-104(V)6
AN/MRC-150



*LTC CDR 02B00 M9 ILLUM ENVG
AN/PRC-119F *
MAJ 02B00 X0 M9 ILLUM ENVG
AN/PRC-119F
PFC 11B10 RTO M4 ILLUM NVG
PFC 11B10 DRIVER M4 ILLUM NVG

**WHEN NOT MOUNTED IN TANK*

AN/VAS-5
AN/VRC-90F



CPT 35D00 S2 M4 ILLUM NVG
SSG 35F30 INTEL SGT M4 ILLUM NVG
SGT 35F20 INTEL ANLST M4 ILLUM NVG
SPC 35F10 INTEL ANLST M4 ILLUM NVG

FBCB2 DAGR
EPLRS-V1 AN/VRC-92F
AN/PYQ-10(C) KOI-18/TSEC
AN/VRC-92F(C) AN/TYQ-93(V)2
AN/UJK-128 AN/TYQ-94(V)2
AN/VSQ-2D(V)1
AN/VRC-104(V)6
AN/UJK-128(V)1



X7 AN/TYQ-93(V)
1LT 35D00 TACT INTEL OFF M4 ILLUM NVG
SFC 35F40 SR INTEL SGT M4 ILLUM NVG
X4 SGT 35F20 INTEL ANLST M4 ILLUM NVG
SGT 35F20 ISR SYNCH MGR M4 ILLUM NVG
SPC 35F10 INTEL ANLST M4 ILLUM NVG
X4 SPC 35F10 INTEL ANLST M4 ILLUM NVG
PFC 35F10 INTEL ANLST M4 ILLUM NVG
PFC 35F10 INTEL ANLST M4 ILLUM NVG

CURRENT OPS - OPS/S3 PARA 03

M257 2X M231
FBCB2 HWTS
MG 7.62 RH FEED
EPLRS-V1
AN/VRC-92F
AN/VRC-104(V)6



MAJ 02B00 S3 M9 ILLUM ENVG
AN/PRC-119F
SSG 74D30 CBRN NCO M4 ILLUM NVG
SGT 11B20 GUNNER M4 ILLUM NVG
SPC 11B10 IFV DVR M4 ILLUM NVG

AN/VAS-5 DAGR
EPLRS-V1
AN/VRC-92F



*MAJ 02B00 S3 M9 ILLUM ENVG
AN/PRC-119F
SFC 11B40 MASTER GNR M4
ILLUM NVG
PFC 19K10 DVR M4 ILLUM NVG
**WHEN NOT MOUNTED IN IFV*

DAGR
AN/VRC-92F

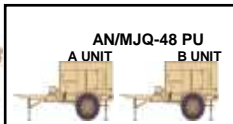

CPT 12A00 COMBAT EN OPS OFF M4 ILLUM NVG
SSG 11B30 ASST OPS SGT M4 ILLUM NVG

FBCB2 DAGR
EPLRS-V1 AN/VRC-92F
AN/VRC-90F AN/UJK-128
AN/UJK(V)1 AN/MRC-149
AN/VSQ-2D(V)1 AN/VRC-104(V)6
AN/UJK-128(V)1
X3 AN/TYQ-137B(V)3



MED PWR PLANT

CPT 11A00 PLANS OFF M4 ILLUM NVG
CPT 11A00 PLANS OFF M4 ILLUM NVG
SFC 11B40 ASST OPS SGT M4 ILLUM NVG
SSG 12B30 RECON SGT M4 ILLUM NVG

AN/VAS-5
AN/VRC-90F
M240B
MWTS



1LT 74A00 CBRN OFF M4 ILLUM NVG
SPC 74D10 CBRN DECON SP M4 ILLUM NVG
PFC 74D10 CBRN SP M4 ILLUM NVG

M259 .50 AL
HWTS CROWS
AN/VRC-90F
AN/VRC-92F



CPT 02B00 ASST S3 M4 ILLUM NVG
SGM 11Z60 OPS SGT M4 ILLUM NVG
SGT 11B20 ASST OPS SGT M4 ILLUM NVG
SPC 11B10 OPS ASST M4 ILLUM NVG

CURRENT OPS-FIRE SPT PARA 4

SSG 29E30 EW SGT M4 ILLUM NVG
SGT 29E20 EW SGT M4 ILLUM NVG

AN/VAS-5 **13s MOVED TO FIRES BN**
DAGR
AN/VRC-92F
AN/VRC-90F



**CPT 13A00 EFFECTS COORD M4
ILL NVG AN/GYK-48(V)1
SGT 13F20 FIRE SPT SGT M4 ILLUM NVG**

DAGR
x2 AN/VRC-92F
AN/VRC-104(V)3
AN/GYK-57
FHMUX



**1LT 13A00 ASST EFFECTS COORD M4
ILLUM NVG
SFC 13F40 EFFECTS NCO M4 ILLUM NVG
SFC 13F40 TARGET NCO M4 ILLUM NVG
SPC 13F10 FIRE SPT SP M4 ILLUM NVG
SSG 25E30 ELECTRO SPECTRU NCO M4
ILLUM NVG
SGT 13F20 FIRE SPT SP M4 ILLUM NVG
SPC 13F10 FIRE SPT SP M4 ILLUM NVG**

HHC, CAB, ABCT

CURR OPS-FIRE SPT/TACP PARA 5

M259 .50 CAL
DAGR HWTS
CROWS
AN/VRC-92F



*CPT 01A00 AF STAFF OFF M4 NVG
SSG 00D30 AF STAFF NCO M4 NVG
SPC 00D10 AF STAFF ENLISTED M4 NVG

*USAF PERSONNEL - NOT ASSIGNED TO THE UNIT

CURRENT OPS - LNO PARA 6

DAGR FBCB2
AN/VAS-5 EPLRS-V1
AN/UJK128 AN/VRC-90F
AN/PYQ-10(C)
AN/VSQ-2D(V)1
AN/UJK128(V)1



1LT 11A00 LNO M4 ILLUM NVG
SPC 11B10 LIAISON ASST M4 ILLUM NVG

SUSTAINMENT - S1 PARA 7

AN/VAS-5
AN/VRC-90F
OL-700/TYQ
OL-701A/TYQ
X5 AN/TYQ-116(V)3



CPT 42B00 S1 M4 ILLUM NVG
SFC 42A40 SR HR SGT M4 ILLUM NVG
SSG 42A30 HR SGT M4 ILLUM NVG
SGT 42A20 HR SGT M4 ILLUM NVG
SGT 27D20 PARALGL NCO M4 ILLUM NVG
X2 SPC 42A10 HR SP M4 ILLUM NVG
X2 PFC 42A10 HR SP M4 ILLUM NVG

SUSTAINMENT - S4 PARA 08

AN/VAS-5
DAGR
AN/VRC-92F
AN/PRC-119F
AN/VRC-104V6



CPT 02B00 S4 M4 ILLUM NVG
SPC 92Y10 SUPPLY SP M4 ILLUM NVG

DAGR
AN/VRC-90F
HWTS



SGT 92Y20 SUPPLY NCO M4 ILLUM NVG

FBCB2 DAGR
AN/VRC-90F AN/VRC-92F
AN/PRC-119F
OL-701A/TYQ
KOI-18/TSEC
AN/TYQ-109(V)1
AN/UJK-128(V)1
AN/TYQ-137B(V)3
2X AN/TYQ-129(V)2



SFC 92Y40 SR SUPPLY SGT M4 ILLUM NVG
PFC 92Y10 SUPPLY SP M4 ILLUM NVG



MED PWR PLANT

SUSTAINMENT- UMT PARA 09

AN/VAS-5
DAGR
AN/VRC-90F
AN/PYQ-10(C)



CPT 56A00 CHAPLAIN NVG
SGT 56M20 CHAPLAIN ASST M4 NVG

SUSTAINMENT - C4 OPS/S6 PARA 10

FBCB2 DAGR
AN/VAS-5 EPLRS-V1
AN/VRC-90F AN/UJK-128
AN/PYQ-10(C)
AN/UJK-128(V)1



CPT 25A00 S6 M4 ILLUM NVG
PFC 25U10 SIG SPT SYS SPC M4 ILLUM NVG

DAGR AN/VAS-5
DAGR AN/VRC-90F
AN/PYQ-10(C)



SGT 25Q20 SR XMSN SYS OPR-MNT M4 ILLUM NVG
SPC 25Q10 XMSN SYS OPR-MNT M4 ILLUM NVG

AN/VRC-90F AN/PYQ-12
AN/TSQ-243 AN/TSQ-259
AN/GYK-50A AN/GYK-62B
AN/TSR-8 (GRT)
X2 AN/PYQ-10(C)
AN/GYK-50B (ISYSCON)



SFC 25U40 SECT CHIEF M4 NVG
SSG 25E30 ELECTRO SPECT NCO M4 ILLUM NVG

SPC 25B10 LAN MGT M4 ILLUM NVG
SPC 25U10 SIG INFO SVC SP M4 ILLUM NVG

SPC 25U10 SIG SPT SYS MAINT M4 ILLUM NVG
PFC 25B10 LAN MGR M4 ILLUM NVG

AN/VAS-5 AN/VRC-90F
AN/PYQ-10(C)



SPC 25N10 NODAL NET SYS OPR-MNT M4 ILLUM NVG
PFC 25N10 NODAL NET SYS OPR-MNT M4

RETRANS MISSION TEAM PARA 11

DAGR FBCB2
AN/VAS-5 AN/MRC-149
AN/UJK-128 AN/PYQ-10(C)
x2 EPLRS-V1
AN/VSQ-2D(V)1
AN/UJK-128(V)1
x2 AN/VRC-92F(C)



SGT 25U20 TEAM CHIEF M4 ILLUM NVG
SPC 25U10 RADIO RETRANS OPR M4 ILLUM NVG
PFC 25U10 RADIO RETRANS OPR M4 ILLUM NVG

COMPANY HEADQUARTERS PARA 12

FBCB2
AN/VAS-5
DAGR
EPLRS-V1
AN/VRC-92F
AN/UJK-128(V)1



CPT 02B00 CDR M4 ILLUM NVG
PFC 92Y10 SUPPLY SP M4 ILLUM NVG

DAGR AN/VAS-5
AN/VRC-87F(C)



1LT 02B00 XO M4 ILLUM NVG
1SG 11Z5M 1SG M4 ILLUM NVG

AN/VAS-5 DAGR HWTS
.50 CAL CROWS
OL-700/TYQ OL-701A/TYQ
AN/VRC-90F(C)
AN/TYQ-109(V)1
X2 AN/PYQ-10(C)



SPC 92Y10 SUPPLY SP M4 ILLUM NVG

X6 M320A1 .50 CAL DAGR
X4 7.62MM HWTS CROWS
X4 M240B AN/VAS-5
AN/PYQ-10(C) AN/UJK-128
AN/VRC-88F(C) AN/VSQ-2D(V)1



SSG 92Y30 SUPPLY SGT M4 ILLUM NVG
SPC 92Y10 SUPPLY SP M4 ILLUM NVG

HHC, CAB, ABCT

SCOUT PLT HEADQUARTERS PARA 13

M240B M320A1 .50 CAL DAGR RAVEN
 MWTS KOI-18 FBCB2 HWTS
 AN/VAS-5 AN/PSS-14 AN/PVS-6
 AN/PED-1 EPLRS-V1 AN/VAS-92F(C)
 AN/TAS-8 SHOTGUN AN/PLQ-8 ANVSQ-2D(V)1
 AN/UJK-128(V)1 X2 AN/PYQ-10(C) AN/UJK-128



1LT 02B00 PLT LDR M4 ILLUM ENVG
 DAGR AN/PRC-119F AN/PRC-148(V)4
 SPC 19D10 SCOUT DRIVER M4 ILLUM NVG
 PFC 19D10 SCOUT M4 ILLUM NVG

MK-19 M320A1 M240B DAGR FBCB2
 HWTS MWTS AN/VAS-5 AN/UJK-128
 AN/PVS-6 AN/PED-1 AN/PSS-14
 EPLRS-V1 AN/VRC-92F(C) AN/TAS-8 ANVSQ-2D(V)1
 SHOTGUN AN/PLQ-8 AN/UJK-128(V)1



SFC 19D40 PSG M4 ILLUM ENVG
 AN/PRC-119F AN/PRC-148(V)4
 SPC 19D10 SCOUT DRIVER M4 ILLUM NVG
 PFC 19D10 SCOUT M4 ILLUM NVG

SCOUT SECTION PARA 14

M240L X2 M320A1 FBCB2
 M257 MWTS M7.62MM
 DAGR JAVELIN SHOTGUN
 AN/PLQ-8 EPLRS-V1
 AN/UJK-128 AN/VRC-92F(C)
 AN/PRC-119F X4 AN/PYQ-10(C)
 MG 7.62 RH FEED



SSG 19D30 SQD LEADER M9 NVG
 AN/PRC-148
 SGT 19D20 CFV GUNNER M9 NVG
 SPC 19D10 CFV DRIVER M9 NVG
 SPC 19D10 SCOUT M4 ENVG LMR
 PFC 19D10 SCOUT M4 ILLUM NVG
 PFC 19D10 SCOUT M4 ILLUM NVG

M240L .50 CAL M7.62MM
 HWTS DAGR LWTS
 MWTS FBCB2 AN/VAS-5
 AN/PVS-6 SHOTGUN
 EPLRS-V1 AN/PLQ-8
 AN/VRC-91F(C) AN/PRC-119F
 AN/UJK-128(V)1 X4 AN/PYQ-10(C)



SSG 19D30 SECT LEADER M4 NVG
 AN/PRC-148
 SPC 19D10 SCOUT DRIVER M4
 SPC 19D10 SCOUT M4 ENVG LMR
 PFC 19D10 SCOUT M4 NVG LMR

X2

SCOUT SECTION PARA 15

FBCB2 M257 M240L
 MWTS LWTS JAVELIN
 DAGR AN/PVS-6 AN/PRC-119F
 EPLRS-V1 SHOTGUN
 AN/PLQ-8 AN/PSQ-20
 MG 7.62 RH FEED
 AN/VRC-92F(C)
 AN/UJK-128
 AN/PYQ-10(C)
 AN/PRC-119F
 X2 ANVSQ-2D(V)1



SSG 19D30 SECT LEADER M9 NVG
 AN/PRC-148
 SGT 19D20 CFV GUNNER M9 NVG
 SGT 19D20 TEAM LEADER M4 NVG

SPC 19D10 CFV DRIVER M9 NVG
 PFC 19D10 SCOUT M4 ILLUM NVG
 PFC 19D10 SCOUT M4 ILLUM NVG

FBCB2 DAGR
 AN/VAS-5 EPLRS-V1
 SHOTGUN HWTS
 .50 CAL M320A1
 M240L LWTS MWTS
 AN/PLQ-8 AN/PVS-6
 AN/PSQ-20 AT/TAS-8
 AN/PRC-119F
 AN/PYQ-10(C)
 AN/VRC-91F(C)
 AN/UJK-128(V)1



SSG 19D30 SQD LEADER M4 ILLUM
 ENVG AN/PRC-148(V)4
 SPC 19D10 SCOUT M4 ILLUM NVG
 SPC 19D10 SCOUT DRIVER M4 ILLUM
 ENVG
 PFC 19D10 SCOUT M4 ILLUM NVG
 LMR

MORTAR PLT HQ PARA 16

FBCB2 DAGR
 AN/VAS-5 EPLRS-V1
 AN/UJK-128 AN/PYQ-10(C)
 AN/VRC-92F(C)
 AN/VSQ-2D(V)1
 AN/UJK-128(V)1



1LT 02B00 PLT LDR M4 ILLUM
 NVG LMR AN/PVS-6
 SFC 11C40 PLT SGT M4 ILLUM
 NVG LMR AN/PVS-6

MORTAR SECTION PARA 17

FBCB2 7.62MM M240B
 MWTS LMR DAGR
 M96 MFCS
 EPLRS -V1
 AN/UJK-128
 AN/PYQ-10(C)
 X2 AN/VRC-92F
 AN/UJK-128(V)1



SSG 11C30 FIRE DIR CH M4 ILLUM NVG
 SGT 11C20 FIRE DIR COMPUTER M4 ILLUM NVG
 X3 SGT 11C20 FIRE DIR COMPUTER M4 ILLUM NVG
 SPC 11C10 CARR DRIVER M4 ILLUM NVG

MORTAR SQUAD PARA 18

M95 MFCS LMR HWTS .50 CAL
 DAGR HWTS
 X4 AN/PYQ-10(C)
 MORTAR 120MM
 AN/VRC-91F(C)



SGT 11C20 SQD LDR M4 ILLUM NVG
 SPC 11C10 GUNNER M4 ILLUM NVG
 SPC 11C10 MORTAR CARR DRIVER M4 ILLUM NVG
 PFC 11C10 ASST GUNNER M4 ILLUM NVG

X4

SNIPER SQUAD PARA 19

FBCB2 DAGR
 AN/VAS-5 EPLRS -V1
 M320A1 HWTS
 AN/UJK-128
 AN/VRC-88F(C)
 AN/PRC-119F
 AN/PYQ-10(C)
 X4 AN/PYQ-10(C)
 AN/UJK-128(V)1



SSG 11B30 SQD LDR M4 ILLUM NVG

AN/PRC-119F(C)

SGT 11B20 SR SNIPER M9 STORM ENVG
 M4 M110 M24 AN/PVS-29
 SPC 11B10 SNIPER M4 M107 ILLUM ENVG LWTS
 SPC 11B10 SNIPER M4 M110 ILLUM ENVG

X3

HHC, CAB, ABCT

MED TREATMENT PLT HQ PARA 20

FBCB2
AN/VAS-5
DAGR
EPLRS-V1
AN/VRC-89F
AN/TYQ-107(V)1
AN/UYK-128(V)1

OL-701A/TYQ
OL-700/TYQ



1LT 70B67 MED OPS OFF M4 NVG
SFC 68W40 PLT SGT M4 NVG

MEDICAL TREATMENT SQUAD PARA 21

FBCB2
DAGR
EPLRS-V1
AN/VRC-89F
AN/VRC-90F
AN/UYK-128(V)1
AN/TYQ-106(V)1
OL-701A/TYQ
X4 AN/TYQ-105(V)1



CPT 62B00 SURGEON/PLT LDR M9
NVG AN/TYQ-105(V)1
SGT 68W20 HEALTH CARE SGT M4
NVG AN/TYQ-105(V)1
PFC 68W10 HEALTH CARE SP M4
NVG AN/TYQ-105(V)1

AN/VAS-5
AN/VRC-90F



SSG 68W30 HEALTH ARE SGT M4
NVG AN/TYQ-105(V)1
SPC 68W10 HEALTH CARE SP M4
NVG AN/TYQ-105(V)1

FBCB2
DAGR
EPLRS-V1
AN/VRC-89F
AN/UYK-128(V)1
AN/TYQ-106(V)1
X4 AN/TYQ-105(V)1



CPT 65D00 PA M9 NVG AN/TYQ-105(V)1
SGT 68W20 HEALTH CARE SGT M4
NVG AN/TYQ-105(V)1
PFC 68W10 HEALTH CARE SP M4
NVG AN/TYQ-105(V)1

AMBULANCE SQUAD PARA 22

FBCB2
DAGR
EPLRS-V1
AN/VRC-90F
AN/UYK-128(V)1

FBCB2
DAGR
EPLRS-V1
AN/VRC-90F
AN/UYK-128(V)1



SGT 68W20 EMER CARE SGT M9 NVG AN/TYQ-105(V)1
SPC 68W10 AIDE/DVR M9 NVG AN/TYQ-105(V)1
PFC 68W10 AIDE/DVR M9 NVG AN/TYQ-105(V)1

x4

COMBAT MEDIC SECT PARA 23

x10 AN/TYQ-105(V)1

x2 SGT 68W20 EMER CARE SGT M9
x8 SPC 68W10 COMBAT MEDIC M9
NVG AN/TYQ-105(V)1

MINE ROLLER SECTION PARA 24

BLADE MINE CLEARING
ROLLER MINE CLEARING
AN/VAS-5
AN/VRC-87F



SPC 19K10 ASST HVY VEH DVR M4 ILLUM NVG
PFC 19K10 ASST HVY VEH DVR M4 ILLUM NVG

x2

MOVED TO FIRES BN FIRE SUPPORT PLATOON PARA 11

FBCB2
M257
MG 7.62 RH FEED
DAGR
EPLRS
AN/VRC-92F
AN/PSC-5
AN/VRC-91F
AN/UYK-128(V)1



1LT 13A00 FIRE SPT TM CH M4 ILLUM NVG
AN/PSG-14(V)1
SSG 13F30 FIRE SPT SGT M4 ILLUM NVG
SPC 13F10 FIRE SPT SP M4 ILLUM NVG
PFC 13F10 FIRE SPT SP M4 ILLUM NVG

x2

FBCB2
M257
MG 7.62 RH FEED
DAGR
EPLRS-V1
AN/VRC-92F
AN/PSC-5
AN/VRC-91F
AN/UYK-128(V)1
AN/PED-1 (LLDR)
X2 AN/PSG-14(V)1 LFERD



1LT 13A00 FIRE SPT TM CH M4 ILLUM
NVG AN/PSG-14(V)1
SSG 13F30 FIRE SPT SGT M4 ILLUM NVG
SPC 13F10 FIRE SPT SP M4 ILLUM NVG
PFC 13F10 FIRE SPT SP M4 ILLUM NVG

x2

AN/PRC-119F
DAGR
AN/PSC-5
AN/PSG-10(V)
AN/VRC-87F

SGT 13F20 FO M4 ILLUM NVG
PFC 13F10 RTO M4 ILLUM NVG

x3

EQUIPMENT SUMMARY

WEAPONS

C60750	COMMAND LAUNCH UNIT: (JAVELIN) 13305405-119	3
L69080	LAUNCHER GRENADE: M320A1	22
L92352	MACHINE GUN 7.62 MILLIMETER: FIXED	2
M12647	MOUNT MACHINE GUN: 40MM MK93	15
M68405	MORTAR 120 MILLIMETERS:	4
M92362	MACHINE GUN GRENADE 40MM: MK19 MOD III	3
M92387	MUNITION: NETWORK COMMAND (SPIDER)	1
M92420	MACHINE GUN 7.62 MILLIMETER: FIXED RH FEED	8
M92454	MACHINE GUN 7.62 MILLIMETER: M240L	6
M92841	MACHINE GUN: 7.62MM M240B	8
P98152	PISTOL 9MM AUTOMATIC: M9	55
R45351	RIFLE SNIPER .50 CALIBER: M107	3
R45601	RIFLE SNIPER: M110	3
R97234	RIFLE 5 56 MILLIMETER: M4	184
S40541	SHOTGUN: 12 GAGE	8
S56419	SUBMACHINE GUN 5.56 MILLIMETER: PORT FIRING M231	2
Z00686	MACHINE GUN: CALIBER .50	12

VEHICLES, TRAILERS AND TRLR MTD SYSTEMS

C10990	CARRIER 120 MILLIMETER MORTAR: SELF PROPELLED ARMORED	4
C11158	CARRIER ARMORED COMMAND POST: FULL TRACKED	6
C18234	CARRIER PERSONNEL FULL TRACKED: ARMORED (RISE)	10
D11538	CARRIER COMMAND POST: LIGHT TRACKED	3
F60564	FIGHTING VEHICLE: FULL TRACKED INFANTRY (IFV) M2A3	1
F90796	FIGHTING VEHICLE: FULL TRACKED CAVALRY (CFV) M3A3	3
M92362	MACHINE GUN GRENADE 40MM: MK19 MOD III	3
P63462	POWER PLANT: UTILITY (MEDIUM)	2
P63530	POWER PLANT: ELETRIC TRAILER MOUNTED	1
S70594	SEMITRAILER LOW BED: 40 TON 6 WHEEL W/E	2
T13305	TANK COMBAT FULL TRACKED: 120MM GUN M1A2	1
T34704	TRUCK UTILITY: ECV ARMAMENT CARRIER W/1AP ARMOR READY M1151A1	5
T37588	TRUCK UTILITY EXPANDED CAPACITY ENHANCED: M1152A1	8
T41135	TRUCK CARGO: MTV W/E W/W	2
T56383	TRUCK UTILITY EXPANDED CAPACITY ENHANCED 4X4: M1165A1	9
T60081	TRUCK CARGO: 4X4 LMTV W/E	5
T61908	TRUCK CARGO: MTV W/E	1
T91656	TRUCK TRACTOR: LET 6X6 66000 GVW W/W C/S	2
T95992	LIGHT TACTICAL TRAILER: 3/4 TON	5
T96564	TRAILER FLAT BED: M1082 TRLR CARGO LMTV W/DROPSIDES	3
W98825	TRAILER TANK: WATER 400 GALLON 1-1/2 TON 2 WHEEL W/E	1
Z01393	M3A3 BFIST WITH FS3:	4
Z36683	TRAILER TANK WATER (CAMEL): 800 GAL 5 TON W/E	1

NIGHT VISION/OBSERVATION

D41659	DRIVERS ENHANCERS: AN/VAS-5	32
M74849	MINI EYESAFE LASER INFRARED OBSERVATION SET (MELIOS): AN/PVS-6	20
M79678	MONOCULAR NIGHT VISION DEVICE: AN/PVS-14	29
N05482	NIGHT VISION: GOGGLE	187
N07848	NIGHT VISION DEVIC: AN/PSQ-20	22
R60282	RANGE FINDER-TARGET DESIGNATOR: LASER AN/PED-1	6
S02976	SURVEILLANCE SYSTEM: SCOUT LONG RANGE AN/TAS-8	5
S60288	SIGHT: REFLEX COLLIMATOR	178
S60342	SIGHT NIGHT VISION (SNS): AN/PVS-29	3
S60356	SIGHT: THERMAL AN/PAS-13B(V)1	7
S90535	MEDIUM WEAPON THERMAL SIGHT (MWTS): AN/PAS-13(V)2	15
S90603	HEAVY WEAPON THERMAL SIGHT (HWTS): AN/PAS-13(V)3	18
T27221	TARGET LOCATION AND OBSERVATION: AN/PLQ-8	12
T45593	SIGHT BORE OPTICAL:	2

COMMUNICATIONS AND ELECTRONICS

A35329	ALL SOURCE ANALYSIS SYSTEM: AN/TYQ-93	2
A35397	ALL SOURCE ANALYSIS SYSTEM: AN/TYQ-93(V)2	1
B57077	BATTLEFIELD ANTI-INTRUSION SYSTE: AN/PRS-9	6
C04819	COMTER SYS DIG: AN/PSG-14(V)1 L FIED	8
C17936	COMPUTER SET: AN/GYG-1(V)1	1
C18277	COMPUTER SET: DIGITAL AN/TYQ-107(V)1	1
C18345	COMPUTER SET: DIGITAL AN/TYQ-106(V)1	3
C18378	COMPUTER SET: AN/UYK-128(V)3	32
C18641	COMPUTER SYST DIGITAL: AN/PYQ-12	1
C27435	COMPUTER SYSTEM: DIGITAL AN/TYQ-129(V)2	2
C27503	COMPUTER SYSTEM: DIGITAL AN/TYQ-105(V)1	42
C27707	COMPUTER SYSTEM: DIGITAL AN/TYQ-109(V)1	2
C27963	COMPUTER SYSEM: DIGITAL	3
C78851	COMPUTER SYSTEM: DIGITAL AN/UYK-90(V)3	1
C79281	COMPUTER ST FIELD ARTILLERY GENERAL: AN/GYK-48(V)1	1
C96840	CONTROL REMOTE LANDMINE SYSTEM: M71	5
F83625	M95: MOTAR FIRE CONTROL SYSTEM	4
F83693	M96: MORTAR FIRE CONTROL SYSTEM	1
F49587	PJH SURFACE VEHICLE RADIO SET: AN/VSQ-2(V)	38
P99881	PROCESSOR GROUP SIG DATA: (CAISI 2.0) OL-701A/TYQ	5
R30658	RECEIVE SUITE: AN/TSR-8	1
R44999	RADIO SET: AN/VRC-89F(C)	3
R45543	RADIO SET: AN/VRC-92F(C)	28
R57606	RADIO SET: AN/PSC-5	10
R67296	RADIO SET: AN/VRC-87F(C)	3
R67330	RADIO SET: AN/VRC-88F(C)	3
R68044	RADIO SET: AN/VRC-90F(C)	26
R68146	RADIO SET: AN/VRC-91F(C)	11
R83141	RADIO SET: AN/PRC-119F(C)	21
R87139	RADIO ST: AN/VRC-104(V)3 150 WATT W/PRC-150 HF RADIO	7
R93169	RADIO TEST SET: AN/PRM-34()	2
T40405	TAPE READER GENERAL PURPOSE: KOI-18/TSEC	5
Z00056	PROCESSOR GROUP SIGNAL DATA: OL-700/TYQ	3
Z00058	COMPUTER SYSTEM DIGITAL: AN/PSG-10(V)	6
Z00384	COMPUTER SYSTEM DIGITAL: AN/PYQ-10(C)	98
Z00512	COMPUTER SYSTEM DIGITAL: AN/GYK-50A (ISYSCON) (V)4	1
Z00513	COMPUTER SYSTEM DIGITAL: AN/GYK-50B (ISYSCON) (V)4	1
Z00564	BATTALION COMMAND POST(SWITCHING GROUP): OM-XXX	1
Z00862	LAND MOBILE RADIO: (LMR)	17
Z00930	COMMUNICATIONS SUBSYSTEM: AN/TSQ-259	1
Z01247	COMPUTER SET: DIGITAL AN/UYK-128(V)1	32
Z01320	RADIO SET: AN/PRC-148 (V) 4 URBAN JEM	8
Z39781	ARMY H RESURCES: WRKSTATION	5
Z53098	PROCESSOR GROUP SIGNAL DATA: OL-701/TYQ	1

MISC EQUIPMENT

A33020	ALARM: CHEMICAL AGENT AUTOMATIC M22	10
D82404	DECONTAMINATING APPARATUS: PWR DRVN LT WT	2
G18358	GEN SET: DED SKID MTD 3KW 60HZ	2
G42170	GEN SET DED TM: 10KW 60HZ MTD ONM116A2 PU-798	1
H48896	FILTER UNIT GAS PARTICULATE ARMORED AMBULANCE: M14	8
J00697	JOINT CHMCL AGENT: DETECTOR	10
J01197	JOINT SERVICE: TRANSPORTABLE DECONTAMINATION	2
M12986	MASK CHEMICL BIOLOGICL JOINT SERVICE GENERAL PURPOSE: FIELD M50	135
M13236	MASK CHMICL-BLGCL JNT SRV GNL PRPSE: CMBT VHL CRWMN M51	103

RIFLE COMPANY, CAB, ABCT

MISSION.

To close with the enemy by means of fire and maneuver to destroy or capture, or to repel his assault by fire, close combat, and counterattack.

RIFLE COMPANY, CAB, ABCT

07207R000
5/0/130//135

COMPANY HEADQUARTERS PARA 01

(x3) RIFLE PLATOON HQ PARA 02 AND 05

M257
MG 7.62 RH FEED
EPLRS-V1
AN/VRC-92F
x2 M231
AN/PRC-104A



CPT 11A00 CDR M9 ILLUM ENVG
AN/PRC-119F HWTS
SSG 11B30 MASTER GNR M9 ILLUM NVG
SPC 11B10 DVR M4 ILLUM NVG

AN/VAS-5
AN/VRC-92F



SGT 25U20 FWD SIG SPT NCO
M4 ILLUM NVG

FBCB2
AN/VAS-5
DAGR
EPLRS-V1
AN/VRC-92F
AN/UYK-128(V)1
AN/MRC-149



*CPT 11A00 CDR M9 ILLUM ENVG
AN/PRC-119F HWTS
PFC 11B10 RTO M4 ILLUM NVG

**WHEN NOT MOUNTED IN IFV*

AN/VAS-5
MK-19
AN/VRC-90F
HWTS
CROWS
AN/TYQ-109(V)1
OL-701A/TYQ



SSG 92Y30 SUPPLY SGT M4 ILLUM NVG
SPC 92Y10 SUPPLY SP M4 ILLUM NVG

M257
MG 7.62 RH FEED
EPLRS-V1
AN/VRC-92F
x2 M231

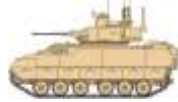

1LT 11A00 XO M4 ILLUM ENVG
AN/PRC-119F
SGT 11B20 GNR M4 ILLUM NVG
SPC 11B10 DVR M4 ILLUM NVG

FBCB2
AN/VAS-5
M259
DAGR
EPLRS-V1
AN/VRC-91F
AN/UYK-128(V)1
HWTS
.50 CAL
CROWS



1SG 11Z5M 1SG M4 ILLUM ENVG
AN/PRC-119F
SPC 11B10 DVR M4 ILLUM NVG

AN/PRC-119F
DAGR

1LT 11A00 PLT LDR M4 ILLUM ENVG
DAGR AN/PRC-119F HWTS AN/PRC-148(V)4
PFC 11B10 RTO M4 ILLUM NVG

AN/PRC-119F
DAGR

1LT 11A00 PLT LDR M4 ILLUM ENVG
DAGR AN/PRC-119F HWTS AN/PRC-148(V)4
PFC 11B10 RTO M4 ILLUM NVG

AN/PRC-119F
DAGR

1LT 11A00 PLT LDR M4 ILLUM ENVG
DAGR AN/PRC-119F HWTS AN/PRC-148(V)4
PFC 11B10 RTO M4 ILLUM NVG

(x3) RIFLE PLATOON VEHICLE SECTION PARA 03 AND 06

(x9) RIFLE SQUAD PARA 04 , 07, AND 08

M257
MG 7.62 RH FEED
EPLRS-V1
AN/VRC-91F
x2 M231



1LT 11A00 PLT LDR M4 ILLUM ENVG
DAGR AN/PRC-119F HWTS AN/PRC-148(V)4
PFC 11B10 RTO M4 ILLUM NVG
SGT 11B20 GNR M4 ILLUM NVG
SPC 11B10 IFV DRIVER M4 ILLUM NVG

M257
MG 7.62 RH FEED
EPLRS-V1
AN/VRC-91F
x2 M231



SFC 11B40 PLT SGT M4 ILLUM ENVG
AN/PRC-119F AN/PRC-148(V)4
SGT 11B20 GNR M4 ILLUM NVG
SPC 11B10 GNR M4 ILLUM NVG
SPC 11B10 IFV DVR M4 ILLUM NVG

M257
MG 7.62 RH FEED
EPLRS-V1
AN/VRC-91F
x2 M231



SSG 11B30 SEC LDR M4 ILLUM NVG
SPC 11B10 GNR M4 ILLUM NVG
SPC 11B10 IFV DVR M4 ILLUM NVG

M257
MG 7.62 RH FEED
EPLRS-V1
AN/VRC-91F
x2 M231



SSG 11B30 SEC LDR M4 ILLUM NVG
SPC 11B10 GNR M4 ILLUM NVG
SPC 11B10 IFV DVR M4 ILLUM NVG

x27 DAGR
x81 LMR
X9 AN/PRC-148(V)4

SSG 11B30 SQD LDR M4 ILLUM ENVG
SGT 11B20 TM LDR M4 ILLUM ENVG
SPC 11B10 AUTO RIFLEMAN M249 ILLUM NVG
SPC 11B10 GRENADEER M320 ILLUM ENVG
PFC 11B10 RIFLEMAN M4 ILLUM NVG LWTS
SGT 11B20 TM LDR M4 ILLUM ENVG
SPC 11B10 AUTO RIFLEMAN M249 ILLUM NVG
SPC 11B10 GRENADEER M320 ILLUM ENVG
PFC 11B10 AA SP M4 ILLUM NVG JAVELIN

x3

x9

EQUIPMENT SUMMARY

WEAPONS

C60750	COMMAND LAUNCH UNIT: (JAVELIN) 13305405-119	9
L69080	LAUNCHER GRENADE: M320A1	20
M09009	MACHINE GUN 5.56 MILLIMETER: M249	18
M92362	MACHINE GUN GRENADE 40MM: MK19 MOD III	2
M92387	MUNITION: NETWORK COMMAND (SPIDER)	1
M92420	MACHINE GUN 7.62 MILLIMETER: FIXED RH FEED	14
M92454	MACHINE GUN 7.62 MILLIMETER: M240L	9
M92841	MACHINE GUN: 7.62MM M240B	2
P98152	PISTOL 9MM AUTOMATIC: M9	2
R97234	RIFLE 5 56 MILLIMETER: M4	116
S40541	SHOTGUN: 12 GAGE	18
S56419	SUBMACHINE GUN 5.56 MILLIMETER: PORT FIRING M231	28
Z00686	MACHINE GUN: CALIBER .50	1

VEHICLES, TRAILERS AND TRLR MTD SYSTEMS

C18234	CARRIER PERSONNEL FULL TRACKED: ARMORED (RISE)	1
F60564	FIGHTING VEHICLE: FULL TRACKED INFANTRY (IFV) M2A3	14
T56383	TRUCK UTILITY EXPANDED CAPACITY ENHANCED 4X4: M1165A1	2
T60081	TRUCK CARGO: 4X4 LMTV W/E	1
T61908	TRUCK CARGO: MTV W/E	1
T96564	TRAILER FLAT BED: M1082 TRLR CARGO LMTV W/DROPSIDES	1
Z36683	TRAILER TANK WATER (CAMEL): 800 GAL 5 TON W/E	1

NIGHT VISION/OBSERVATION

B67766	BINOCULAR: MODULAR CONSTRUCTION MIL SCALE RETICLE 7X50MM W/E	27
D41659	DRIVERS ENHANCERS: ANVAS-5	5
J03261	ILLUMINATOR: INFRARED	136
M74849	MINI EYESAFE LASER INFRARED OBSERVATION SET (MELIOS): ANPVS-6	7
M79678	MONOCULAR NIGHT VISION DEVICE: ANPVS-14	30
N05050	NIGHT VISION SIGHT SET: ANUAS-11	1
N05482	NIGHT VISION: GOGGLE	52
N07848	NIGHT VISION DEVIC: ANPSQ-20	54
S60356	SIGHT: THERMAL ANPAS-13B(V)1	18
S90535	MEDIUM WEAPON THERMAL SIGHT (MWTS): ANPAS-13(V)2	29
S90603	HEAVY WEAPON THERMAL SIGHT (HWTS): ANPAS-13(V)3	17

COMMUNICATIONS AND ELECTRONICS

C18378	COMPUTER SET: ANUYK-128(V)3	2
C27707	COMPUTER SYSTEM: DIGITAL ANTYQ-109(V)1	1
N96248	NAVIGATION SET: SATELLITE SIGNALS ANPSN-13	32
P49587	PJH SURFACE VEHICLE RADIO SET: ANV SQ-2(V)	16
P99881	PROCESSOR GROUP SIG DATA: (CAISI 2.0) OL-701A/TYQ	1
R45543	RADIO SET: ANVRC-92F(C)	4
R55200	RADIO SET: ANPRC-104A	1
R68044	RADIO SET: ANVRC-90F(C)	2
R68146	RADIO SET: ANVRC-91F(C)	13
R83141	RADIO SET: ANPRC-119F(C)	16
T40405	TAPE READER GENERAL PURPOSE: KOI-18/TSEC	2
Z00056	PROCESSOR GROUP SIGNAL DATA: OL-700/TYQ	1
Z00384	COMPUTER SYSTEM DIGITAL: ANPYQ-10(C)	44
Z00862	LAND MOBILE RADIO: (LMR)	81
Z01247	COMPUTER SET: DIGITAL ANUYK-128(V)1	2
Z01320	RADIO SET: ANPRC-148 (V) 4 URBAN JEM	15

MISC EQUIPMENT

A33020	ALARM: CHEMICAL AGENT AUTOMATIC M22	4
B57077	BATTLEFIELD ANTI-INTRUSION SYSTE: ANPRS-9	4
C05701	MONITOR CHEMICAL AGENT:	2
D03932	DETECTING SET: MINE ANPSS-14	8
G18358	GEN SET: DED SKID MTD 3KW 60HZ	1
J00697	JOINT CHMCL AGENT: DETECTOR	4
L02015	LIGHTING KT: MOTION DETECTOR (LKMD) ANGAR-2	9
M12986	MASK CHEMICAL BIOLOGICAL JOINT SERVICE GENERAL PURPOSE: FIELD M50	63
M13236	MASK CHEMICAL-BLGCL JNT SRV GNL PRPSE: CMBT VHL CRWMN M51	73
M92387	MUNITION: NETWORK COMMAND (SPIDER)	1
N96248	NAVIGATION SET: SATELLITE SIGNALS ANPSN-13	32
P49587	PJH SURFACE VEHICLE RADIO SET: ANV SQ-2(V)	16
R20684	RADIAC SET: ANVDR-2	13
R30925	RADIAC SET: ANPDR-75	1
R31061	RADIAC SET: ANUDR-13	7
R45543	RADIO SET: ANVRC-92F(C)	4
S83835	SMALL UNMANNED AIRCRAFT SYSTEM (SUAS): RAVEN B (MIP)	1
Z01279	COMMON REMOTELY OPERATED WPN STATION (CROWS):	3

ARMOR COMPANY, CAB, ABCT

17307R000
5/0/57//62

COMPANY HEADQUARTERS PARA 01

Mission: To close with and destroy enemy forces using fire, maneuver, and shock effect, or to repel assault by fire and counterattack.

M250 DAGR
MG 7.62 FIXED
x2 NVG EPLRSV1
AN/VRC-92F
AN/VRC-104(V)3
x2 M4 MWTS
HWTS .50 CAL
CROWS



CPT 19B00 CDR M9
SPC 19K10 CREWMAN M9
PFC 19K10 LOADER M9
SGT 19K20 GNR/ASST TC M9

DAGR M250
MG 7.62 FIXED
x2 NVG EPLRS-V1
AN/VRC-92F
AN/VRC-104(V)3
x2 M4 MWTS
HWTS .50 CAL
CROWS



1LT 19B00 XO M9
SGT 19K20 GNR M9
SPC 19K10 CREWMAN M9
PFC 19K10 LOADER M9

FBCB2 M259
x2 NVG DAGR
EPLRS-V1
AN/VRC-92F
HWTS .50 CAL
AN/UYSK-128(V)1



1SG 19Z5M 1SG M4
SPC 19K10 DVR M9

AN/VAS-5 x2 NVG
AN/VRC-90F
HWTS .50 CAL
CROWS KOI-18
AN/TYQ-109(V)1
OL-701A/TYQ
OL-700/TYQ

FBCB2
AN/VAS-5
x2 NVG
DAGR
EPLRS-V1
AN/VRC-89F
AN/VRC-104(V)3



*CPT 19B00 CDR M9
SGT 25U20 FWD SIG SPT NCO M4
*WHEN NOT MOUNTED IN TANK

x2 NVG
AN/VRC-89F



*1LT 19B00 EXEC OFF M9
SSG 19K30 MASTER GNR M9
*WHEN NOT MOUNTED IN TANK



SGT 92Y20 SUPPLY NCO M4
SPC 92Y10 SUPPLY SP M4

TANK PLATOON PARA 02

M250
MG 7.62 FIXED
x2 NVG
DAGR
EPLRS-V1
AN/VRC-89F
x2 M4
MWTS
HWTS
.50 CAL
CROWS



1LT 19B00 PLT LDR M9
SPC 19K10 CREWMAN M9
PFC 19K10 LOADER M9
SGT 19K20 GNR M9

M250
MG 7.62 FIXED
x2 NVG
DAGR
EPLRS-V1
AN/VRC-89F
x2 M4
MWTS
HWTS
.50 CAL
CROWS



SFC 19K40 PLT SGT M9
SPC 19K10 CREWMAN M9
PFC 19K10 LOADER M9
SGT 19K20 GNR M9

M250
MG 7.62 FIXED
x2 NVG
DAGR
EPLRS
AN/VRC-87F
x2 M4
MWTS
HWTS
.50 CAL
CROWS



SSG 19K30 TANK CDR M9
SPC 19K10 CREWMAN M9
PFC 19K10 LOADER M9
SGT 19K20 GNR/ASST TC M9

M250
MG 7.62 FIXED
x2 NVG
DAGR
EPLRS-V1
AN/VRC-87F
x2 M4
MWTS
HWTS
.50 CAL
CROWS



SSG 19K30 TANK CDR M9
SPC 19K10 CREWMAN M9
PFC 19K10 LOADER M9
SGT 19K20 GNR/ASST TC M9

x3

EQUIPMENT SUMMARY

WEAPONS

L69080	LAUNCHER GRENADE: M320A1	4
L92352	MACHINE GUN 7.62 MILLIMETER: FIXED	28
M92387	MUNITION: NETWORK COMMAND (SPIDER)	1
P98152	PISTOL 9MM AUTOMATIC: M9	58
R97234	RIFLE 5 56 MILLIMETER: M4	33
Z00686	MACHINE GUN: CALIBER .50	17

VEHICLES, TRAILERS AND TRLR MTD SYSTEMS

C18234	CARRIER PERSONNEL FULL TRACKED: ARMORED (RISE)	1
T13305	TANK COMBAT FULL TRACKED: 120MM GUN M1A2	14
T56383	TRUCK UTILITY EXPANDED CAPACITY ENHANCED 4X4: M1165A1	2
T60081	TRUCK CARGO: 4X4 LMTV W/E	1
T61908	TRUCK CARGO: MTV W/E	1
Z36683	TRAILER TANK WATER (CAMEL): 800 GAL 5 TON W/E	1

NIGHT VISION/OBSERVATION

B67766	BINOCULAR: MODULAR CONSTRUCTION MIL SCALE RETICLE 7X50MM W/E	16
D41659	DRIVERS ENHANCERS: ANVVAS-5	4
N05482	NIGHT VISION: GOGGLE	38
S90535	MEDIUM WEAPON THERMAL SIGHT (MWTS): AN/PAS-13(V)2	14
S90603	HEAVY WEAPON THERMAL SIGHT (HWTS): AN/PAS-13(V)3	17

COMMUNICATIONS AND ELECTRONICS

C18378	COMPUTER SET: ANUYK-128(V)3	2
C27707	COMPUTER SYSTEM: DIGITAL AN/TYQ-109(V)1	1
N96248	NAVIGATION SET: SATELLITE SIGNALS AN/PSN-13	16
P49587	PJH SURFACE VEHICLE RADIO SET: ANV/SQ-2(V)	16
P99881	PROCESSOR GROUP SIG DATA: (CAISI 2.0) OL-701A/TYQ	1
R44999	RADIO SET: ANVRC-89F(C)	9
R45543	RADIO SET: ANVRC-92F(C)	3
R67296	RADIO SET: ANVRC-87F(C)	6
R87139	RADIO ST: ANVRC-104(V)3 150 WATT W/PRC-150 HF RADIO	1
R93169	RADIO TEST SET: AN/PRM-34()	1
T40405	TAPE READER GENERAL PURPOSE: KOI-18/TSEC	2
Z00056	PROCESSOR GROUP SIGNAL DATA: OL-700/TYQ	1
Z00384	COMPUTER SYSTEM DIGITAL: AN/PYQ-10(C)	19
Z01247	COMPUTER SET: DIGITAL ANUYK-128(V)1	2

MISC EQUIPMENT

A33020	ALARM: CHEMICAL AGENT AUTOMATIC M22	4
B57077	BATTLEFIELD ANTI-INTRUSION SYSTE: AN/PRS-9	3
C05701	MONITOR CHEMICAL AGENT:	2
D03932	DETECTING SET: MINE AN/PSS-14	2
G18358	GEN SET: DED SKID MTD 3KW 60HZ	1
J00697	JOINT CHMCL AGENT: DETECTOR	4
M12986	MASK CHEMICAL BIOLOGICAL JOINT SERVICE GENERAL PURPOSE: FIELD M50	4
M13236	MASK CHEMICAL-BLGCCL JNT SRV GNL PRPSE: CMBT VHL CRWMN M51	59
M92387	MUNITION: NETWORK COMMAND (SPIDER)	1
R20684	RADIAC SET: ANVDR-2	4
R30925	RADIAC SET: AN/PDR-75	1
R31061	RADIAC SET: ANUDR-13	4

ARMOR COMPANY, CAB, ABCT

HHB, FIRES BATTALION, ABCT

06386R000
14/076/90

COMMAND SECTION PARA 01

CURRENT OPS-INTEL/S2 PARA 02

CURRENT OPS – OPS/S3 PARA 03

Mission: To provide command, control and administrative supervision of organic and attached Field Artillery units

FBCB2
2X NVG
DAGR
EPLRS
AN/VRC-92F
AN/PSC-5
AN/PRC-104(V)3
AN/UJK-128(V)1



LTC 13A00 CDR M4 M9
AN/GYK-48(V)1
PFC 13D10 DRIVER M4

FBCB2
2X NVG
DAGR
EPLRS
AN/VRC-90F
AN/UJK-128(V)1



CSM 00Z50 CSM M4 M9
PFC 13D10 FATDS SP M4

MAJ 13A00 EXEC OFF M4 M9

AN/TYQ-93
2X NVG
DAGR
AN/VRC-92F
AN/GYK-56



SPC 35F10 INTEL ANLST M4
CPT 13A00 S2 M4
MSG 13Z50 INTEL SGT M4
SSG 35F30 INTEL SGT M4

FBCB2
2X NVG
DAGR
EPLRS
AN/VRC-92F
AN/VRC-104(V)3
AN/UJK-128(V)1



CPT 13A00 OPS OFF M4
SPC 13D10 FATDS SP M4
SSG 29E30 EW SGT M4
SGT 74D20 CBRN NCO M4
SGT 29E20 EW SGT M4
SPC 74D10 CBRN DECON SP M4
SPC 13D10 FATDS SP M4
PFC 13D10- DRIVER M4
SFC 13B40 OPS SGT/MSTR GNR M4

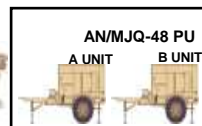

2X NVG
DAGR
AN/VRC-90F



MAJ 13A00 S3 M4 M9
AN/GYK-48(V)1
PFC 13D10 DRIVER M4

2X NVG
DAGR
AN/VRC-90F



1LT 74A00 CHEM OFF M4
SSG 74D30 CBRN NCO M4

2X NVG
DAGR
AN/VRC-92F
AN/PSC-5



MSG 13A50 OPS SGT M4
SSG 13T30 CHIEF SURVEYOR M4
PFC 13D10 FATDS SP M4



CURR OPS – FDC PARA 04

SUSTAINMENT – S1 PARA 05

SUSTAINMENT – S4 PARA 06

SUSTAINMENT – UMT PARA 07

SUSTAINME3NT – C4/S6 PARA 08

AN/GYG-1(V)3
FBCB2
2X NVG
DAGR
EPLRS
AN/VRC-92F
AN/VRC-104(V)3
AN/UJK-128(V)1



SPC 13D10 FATDS SP M4
SFC 13D40 CH FIRE CONTROL SGT M4
SSG 13D30 FIRE CONTROL SGT M4
SGT 13D20 FIRE CONTROL SGT M4
SPC 13D10 FATDS SP M4

2X NVG
DAGR
.50 CAL
HWTS



PFC 13D10 FATDS SP M4

2X NVG
AN/VRC-90F



PFC 13D10 FATDS SP M4
CPT 13A00 FIRE DIR OFF M4

2X NVG
DAGR
AN/VRC-90F
M240B
MWTS
OL-701A/TYQ
X4 AN/TYQ-116(V)3



CPT 42B00 S1 M4
SFC 42A40 SR HR SGT M4
PFC 42A10 HR SP M4
SSG 42A30 HR SGT M4
SGT 42A20 HR SGT M4
SPC 27D10 PARALEGAL M4
SPC 42A10 HR SP M4
SPC 42A10 HR SP M4
PFC 42A10 HR SP M4

FBCB2
2X NVG
DAGR
EPLRS
AN/VRC-92F
AN/UJK-128(V)1
M240B
MWTS



CPT 13A00 S4 M4
SGT 92Y10 SUPPLY SGT M4

2X NVG
AN/TYQ-129(V)2
AN/TYQ-109(V)1
AN/UJK-90(V)3



SFC 92Y40 SR SUPPLY SGT M4
SPC 92Y10 SUPPLY SP M4
PFC 92Y10 SUPPLY SP M4
SPC 92Y10 SUPPLY SP M4

2X NVG
DAGR
AN/VRC-90F



CPT 56A00 CHAPLAIN
SPC 56M10 M4

FBCB2
2X NVG
DAGR
EPLRS
AN/VRC-92F
AN/UJK-128(V)1



CPT 25A00 S6 M4
PFC 25U10 SIG SPT SYS SP M4
SFC 25U40 SECT CH M4
SPC 25U10 SIG INFO SVC SP M4
PFC 25U10 SIG SPT SYS MAINT M4

HHB, FIRES BATTALION, ABCT

NETWORK MANAGEMENT TEAM PARA 09

2X NVG
DAGR
AN/VRC-92F
AN/TSQ-243



SPC 25B10 LAN MGR M4
PFC 25B10 LAN MGR M4

NETWORK OPERATIONS PARA 10

2X NVG AN/PYQ-12
DAGR AN/GYK-50A
AN/TSR-8 AN/GYK-50B
AN/VRC-90F



SPC 25Q10 XMSN SYS OPR-,MT M4

2X NVG DAGR
AN/VRC-92F
AN/TSQ-259



BATTALION COMMAND
POST SWITCHING GROUP
SGT 25Q20 SR XMSN SYS OPR/MNT M4

RETRANSMISSION SECTION PARA 11

FBCB2 2X NVG
DAGR EPLRS
AN/VRC-92F
M249 MWTS



SSG 25U30 RETRANS SUPV M4
SPC 25U10 RETRANS OPR M4
PFC 25U10 RETRANS OPR M4

FBCB2 2X NVG
DAGR EPLRS
AN/VRC-92F
M249 MWTS



SGT 25U20 TM CHIEF M4
SPC 25U10 RETRANS OPR M4
PFC 25U10 RETRANS OPR M4

BATTERY HEADQUARTERS PARA 12

FBCB2
2X NVG
DAGR
EPLRS
AN/VRC-90F



CPT 13A00 CDR M4 M9
PFC 13D10 DRIVER M4
1SG 13Z5M 1SG M4

BATTERY SUPPLY SECTION PARA 13

AN/VRC-90F
AN/TYQ-109(V)1
OL-701A/TYQ



SSG 92Y30 SUPPLY SGT M4
SPC 92Y10 SUPPLY SP M4

AN/VRC-90F



AN/VRC-90F



SPC 92Y10 SUPPLY SP M4

MEDICAL PLT HQ PARA 14

FBCB2 AN/TYQ-107(V)1
2X NVG OL-701A/TYQ
DAGR
EPLRS
AN/VRC-89F



1LT FIELD MED ASST M4
SFC 68W40 PLT SGT M4

MEDICAL TREATMENT TEAM PARA 15

FBCB2 AN/TYQ-106
x2 NVG x2 AN/TYQ-105
DAGR
EPLRS
AN/VRC-92F



CPT 65D00 PA/PLT LDR M9
SPC 68W10 HEALTH CARE SP M4

x2 NVG
AN/VRC-90F
x2 AN/TYQ-105



SSG 68W30 HEALTH CARE SGT M4
PFC 68W10 HEALTH CARE SP M4

AMBULANCE TEAM PARA 16

FBCB2 x2 AN/TYQ-105(V)1
AN/VAS-5
2X NVG
DAGR
EPLRS
AN/VRC-90F



SGT 68W20 EMERGENCY CARE SGT M4
SPC 68W10 AMBUL AIDE/DRIVER M4
PFC 68W10 DRIVER M4

x3

COMBAT MEDIC SECTION PARA 17

x4 AN/TYQ-105(V)1

SPC 68W10 COMBAT MEDIC M9
SPC 68W10 COMBAT MEDIC M9
SPC 68W10 COMBAT MEDIC M9
SPC 68W10 COMBAT MEDIC M9

EQUIPMENT SUMMARY

WEAPONS			COMMUNICATIONS AND ELECTRONICS		
M39263	MACHINE GUN: LIGHT 5.56MM M249	2	A35329	ALL SOURCE ANALYSIS SYSTEM: ANTYQ-93	1
M92362	MACHINE GUN GRENADE 40MM: MK19 MOD III	2	C17936	COMPUTER SET: AN/GYG-1(V)1	1
M92841	MACHINE GUN: 7.62MM M240B	6	C18004	COMPUTER SET: AN/GYG-1(V)3	1
P98152	PISTOL 9MM AUTOMATIC: M9	8	C18277	COMPUTER SET: DIGITAL ANTYQ-107(V)1	1
R97234	RIFLE 5 56 MILLIMETER: M4	83	C18345	COMPUTER SET: DIGITAL ANTYQ-106(V)1	2
Z00686	MACHINE GUN: CALIBER .50	4	C18378	COMPUTER SET: ANUYK-128(V)3	14
VEHICLES, TRAILERS AND TRLR MTD SYSTEMS			C18641	COMPUTER SYST DIGITAL: ANPYQ-12	1
C11158	CARRIER ARMORED COMMAND POST: FULL TRACKED	3	C27435	COMPUTER SYSTEM: DIGITAL ANTYQ-129(V)2	2
P63462	POWER PLANT: UTILITY (MEDIUM)	2	C27503	COMPUTER SYSTEM: DIGITAL ANTYQ-105(V)1	12
P63530	POWER PLANT: ELECTRIC TRAILER MOUNTED	1	C27707	COMPUTER SYSTEM: DIGITAL ANTYQ-109(V)1	2
T37588	TRUCK UTILITY EXPANDED CAPACITY ENHANCED: M1152A1	12	C27963	COMPUTER SYSTEM: DIGITAL	5
T38844	TRUCK AMBULANCE: 4 LITTER ARMD 4X4 W/E (HMMWV)	3	C61665	COMMAND CENTER SYSTEM: ANTSQ-243	1
T56383	TRUCK UTILITY EXPANDED CAPACITY ENHANCED 4X4: M1165A1	10	C78851	COMPUTER SYSTEM: DIGITAL ANUYQ-90(V)3	1
T60081	TRUCK CARGO: 4X4 LMTV W/E	3	C79281	COMPUTER ST FIELD ARTILLERY GENERAL: AN/GYK-48(V)1	2
T61908	TRUCK CARGO: MTV W/E	1	N96248	NAVIGATION SET: SATELLITE SIGNALS AN/PSN-13	25
T95924	TRAILER CARGO: HIGH MOBILITY 1-1/4 TON	7	P49587	PJH SURFACE VEHICLE RADIO SET: ANVVSQ-2(V)	14
T96564	TRAILER FLAT BED: M1082 TRLR CARGO LMTV W/DROPSIDES	2	P99881	PROCESSOR GROUP SIG DATA: (CAISI 2.0) OL-701A/TYQ	5
Z36683	TRAILER TANK WATER (CAMEL): 800 GAL 5 TON W/E	1	R44999	RADIO SET: ANVRC-89F(C)	1
NIGHT VISION/OBSERVATION			R45543	RADIO SET: ANVRC-92F(C)	18
D41659	DRIVERS ENHANCERS: AN/VAS-5	3	R57606	RADIO SET: AN/PSC-5	2
N05482	NIGHT VISION: GOGGLE	66	R68044	RADIO SET: ANVRC-90F(C)	19
S90535	MEDIUM WEAPON THERMAL SIGHT (MWTS): AN/PAS-13(V)2	8	R87139	RADIO ST: ANVRC-104(V)3 150 WATT W/PRC-150 HF RADIO	3
S90603	HEAVY WEAPON THERMAL SIGHT (HWTS): AN/PAS-13(V)3	6	R93169	RADIO TEST SET: AN/PRM-34()	4
MISC EQUIPMENT			T40405	TAPE READER GENERAL PURPOSE: KOI-18/TSEC	4
A33020	ALARM: CHEMICAL AGENT AUTOMATIC M22	8	Z00129	COMPUTER SET FIELD ARTILLERY GENERAL: AN/GYK-56	1
C05701	MONITOR CHEMICAL AGENT:	2	Z00384	COMPUTER SYSTEM DIGITAL: AN/PYQ-10(C)	25
C79000	COLLECTIVE PROTECTION EQUIPMENT: NBC SIMPLIFIED M20	4	Z00512	COMPUTER SYSTEM DIGITAL: AN/GYK-50A (ISYSCON) (V)4	1
D03932	DETECTING SET: MINE AN/PSS-14	2	Z00513	COMPUTER SYSTEM DIGITAL: AN/GYK-50B (ISYSCON) (V)4	1
D82404	DECONTAMINATING APPARATUS: PWR DRVN LT WT	2	Z00564	BATTALION COMMAND POST(SWITCHING GROUP): OM-XXX	1
G18358	GEN SET: DED SKID MTD 3KW 60HZ	5	Z00930	COMMUNICATIONS SUBSYSTEM: ANTSQ-259	1
G42170	GEN SET DED TM: 10KW 60HZ MTD ONM116A2 PU-798	1	Z01247	COMPUTER SET: DIGITAL ANUYK-128(V)1	14
J00697	JOINT CHMCL AGENT: DETECTOR	8	Z01248	COMPUTER SET: DIGITAL AN/GYK-62B	1
J01197	JOINT SERVICE: TRANSPORTABLE DECONTAMINATION	2	Z39781	ARMY H RESURCES: WRKSTATION	5
P63462	POWER PLANT: UTILITY (MEDIUM)	2			
P63530	POWER PLANT: ELECTRIC TRAILER MOUNTED	1			
R20684	RADIAC SET: ANVDR-2	10			
R30925	RADIAC SET: ANPDR-75	1			
R31061	RADIAC SET: ANUDR-13	11			

HHB, Fires Battalion, 155SP

***(CONSOLIDATED FOR TRAINING)**

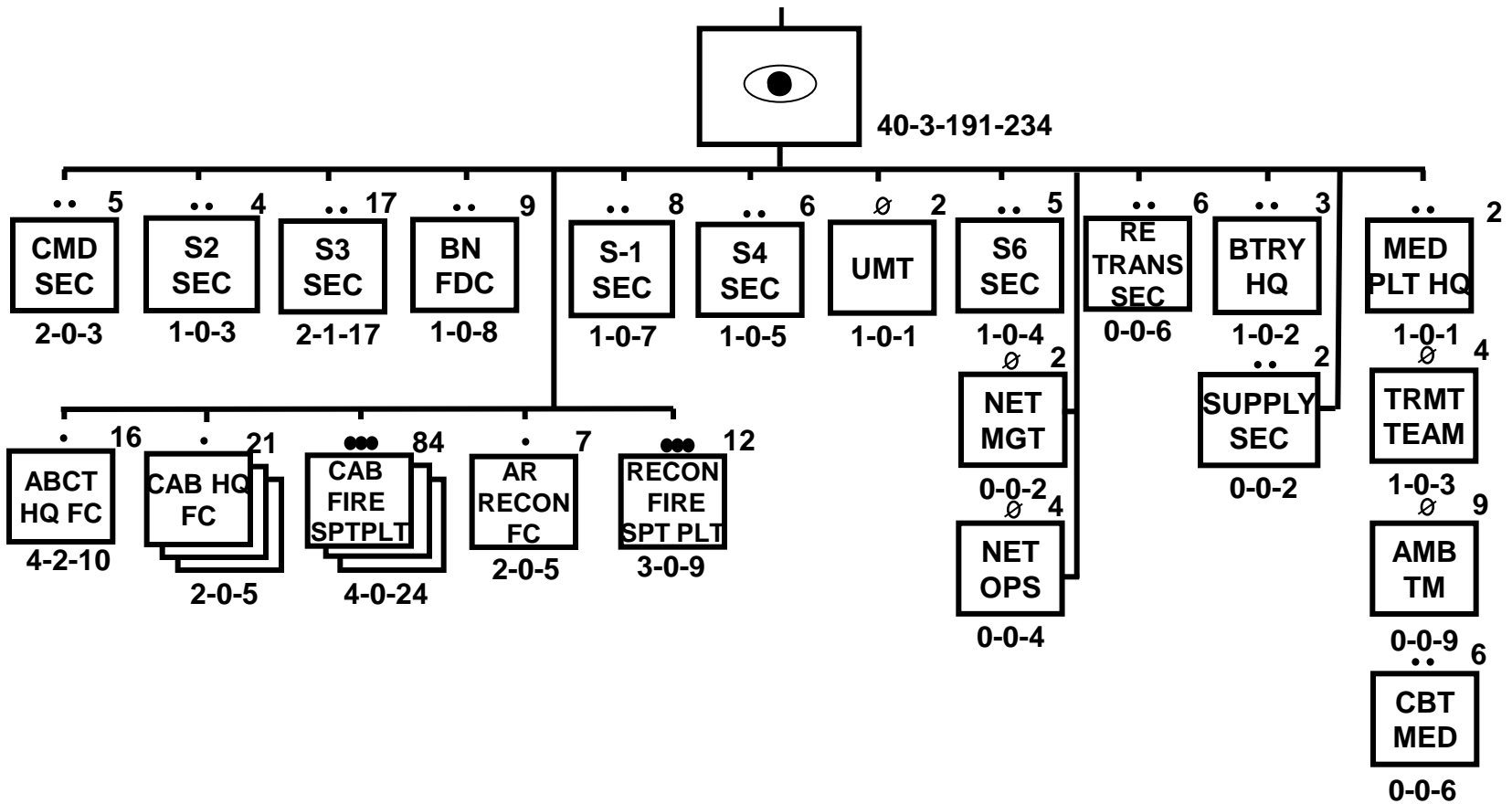

FIRES BATTERY(155SP), FIRES BATTALION, ABCT

06238R000
6/0/108//114

BATTERY HEADQUARTERS PARA 01

SUPPLY SECTION PARA 02

FIRING PLATOON HEADQUARTERS PARA 03

Mission: To destroy, neutralize or suppress the enemy with cannon fire.

FBCB2
2X NVG
DAGR
EPLRS
AN/VRC-92F



CPT 13A00 CDR M4 M9
1LT 13A00 EXEC OFF M4
1SG 13Z5M 1SG M4
SSG 25U30 FWD SIG SPT NCO M4
PFC 13D10 DRIVER M4

2X NVG
DAGR
AN/VRC-90F

AN/TYQ-109(V)1
AN/UYQ-90(V)3
.50 CAL
HWTS
OL-701A/TYQ



SGT 92Y20 SUPPLY NCO M4
SPC 92Y10 SUPPLY SP M4

FBCB2
2X NVG
DAGR
EPLRS
AN/VRC-92F
AN/UYTK-128(V)1
HWTS



1LT 13A00 PLT LDR M4
PFC 13D10 DRIVER M4

FBCB2
2X NVG
DAGR
EPLRS
AN/VRC-89F
AN/UYK-128(V)1
M240B
MWTS



SFC 13B40 PLT SGT M4
SFC 13B40 GUNNERY SGT M4

x2

FIRE DIRECTION CENTER PARA 04

HOWITZER SECTION (155SP) PARA 05

AMMUNITION SECTION PARA 06

2X NVG
DAGR
2X AN/VRC-92F
2X AN/PYG-1

FBCB2 2X NVG
DAGR EPLRS
2X AN/VRC-92F
AN/VRC-90F
AN/GYG-1(V)1
AN/VRC-104(V)3
AN/UYK-128(V)1
M240B MWTS
KOI-18/TSEC



1LT 13A00 FIRE DIR OFF M4
SGT 13D20 FIRE CNTRL SGT M4
SPC 13D10 FATDS SP M4
PFC 13D10 FATDS SP M4

SSG 13D30 FIRE CNTRL SGT M4
SSG 13D30 FIRE CNTRL SGT M4
SPC 13D10 FATDS SP M4
PFC 13D10 FATDS SP M4

x2

AN/PVS-6
2X NVG
DAGR
AN/VRC091F
HWTS



SSG 13B30 SEC CH M4
SGT 13B20 GUNNER M4
SPC 13B10 ASST GNR M4
SPC 13B10 CANNONEER M4

MK-19
2X NVG
DAGR
AN/VRC-90F
HWTS



SGT 13B20 GUNNER AMMO TEAM CH M4
SPC 13B10 DRIVER M4
SPC 13B10 CANNONEER M4
X3 PFC 13B10 CANNONEER M4

x6

AN/VAS-5 2X NVG
DAGR
AN/VRC-90F
AN/UYQ-90(V)2

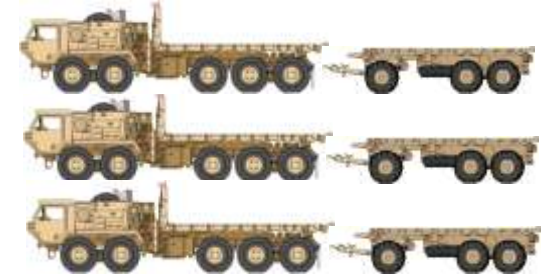

SSG 13B30 AMMO CH M4
SGT 13B20 AMMO SGT M4
SPC 13B10 AMMO SP M4
SPC 13B10 AMMO SP M4
PFC 13B10 AMMO HANDLER M4
PFC 13B10 AMMO HANDLER M4

x2

EQUIPMENT SUMMARY

WEAPONS

H57505	HOWITZER LIGHT TOWED: M119	8
L69080	LAUNCHER GRENADE: M320A1	14
M92362	MACHINE GUN GRENADE 40MM: MK19 MOD III	4
M92841	MACHINE GUN: 7.62MM M240B	12
P98152	PISTOL 9MM AUTOMATIC: M9	1
R97234	RIFLE 5 56 MILLIMETER: M4	94
Z00686	MACHINE GUN: CALIBER .50	3

VEHICLES, TRAILERS AND TRLR MTD SYSTEMS

T37588	TRUCK UTILITY EXPANDED CAPACITY ENHANCED: M1152A1	20
T41135	TRUCK CARGO: MTV W/E W/W	2
T41203	TRUCK CARGO: MTV W/MHE W/E	2
T56383	TRUCK UTILITY EXPANDED CAPACITY ENHANCED 4X4: M1165A1	5
T61908	TRUCK CARGO: MTV W/E	1
T95555	TRAILER CARGO: MTV W/DROPSIDES M1095	4
T95924	TRAILER CARGO: HIGH MOBILITY 1-1/4 TON	2
T95992	LIGHT TACTICAL TRAILER: 3/4 TON	3
Z36683	TRAILER TANK WATER (CAMEL): 800 GAL 5 TON W/E	1

NIGHT VISION/OBSERVATION

N05482	NIGHT VISION: GOGGLE	70
S90535	MEDIUM WEAPON THERMAL SIGHT (MWTS): AN/PAS-13(V)2	12
S90603	HEAVY WEAPON THERMAL SIGHT (HWTS): AN/PAS-13(V)3	7

COMMUNICATIONS AND ELECTRONICS

C17936	COMPUTER SET: AN/GYG-1(V)1	2
C18278	COMPUTER SYSTEM: DIGITAL AN/UYQ-90(V)2	4
C18378	COMPUTER SET: AN/UYK-128(V)3	20
C27707	COMPUTER SYSTEM: DIGITAL AN/TYQ-109(V)1	1
C40495	CMPTR SY DI: AN/PYG-2(V)1	8
C53293	CT SY D: AN/PYG-1	4
C78851	COMPUTER SYSTEM: DIGITAL AN/UYQ-90(V)3	2
J54771	INTERCONNECT GROUP: ON-721/V	1
N96248	NAVIGATION SET: SATELLITE SIGNALS AN/PSN-13	30
P99881	PROCESSOR GROUP SIG DATA: (CAISI 2.0) OL-701A/TYQ	1
Q77755	RADIO SET CONTROL: C-2328/GRA-39	8
R45543	RADIO SET: AN/VRC-92F(C)	9
R67330	RADIO SET: AN/VRC-88F(C)	2
R68044	RADIO SET: AN/VRC-90F(C)	17
R68146	RADIO SET: AN/VRC-91F(C)	8
R87139	RADIO ST: AN/VRC-104(V)3 150 WATT W/PRC-150 HF RADIO	2
T40405	TAPE READER GENERAL PURPOSE: KOI-18/TSEC	2
Z00384	COMPUTER SYSTEM DIGITAL: AN/PYQ-10(C)	22

MISC EQUIPMENT

C05701	MONITOR CHEMICAL AGENT:	6
D03932	DETECTING SET: MINE AN/PSS-14	2
G18358	GEN SET: DED SKID MTD 3KW 60HZ	2
J00697	JOINT CHMCL AGENT: DETECTOR	3
M12986	MASK CHEMICAL BIOLOGICAL JOINT SERVICE GENERAL PURPOSE: FIELD M50	88
M13236	MASK CHEMICAL-BIOLOGICAL JOINT SERVICE GENERAL PURPOSE: CMBT VHL CRWMN M51	6
S83835	SMALL UNMANNED AIRCRAFT SYSTEM (SUAS): RAVEN B (MIP)	1

FIRES BATTERY, FIRES BATTALION, ABCT

Target Acquisition Platoon

155SP Fires Battalion

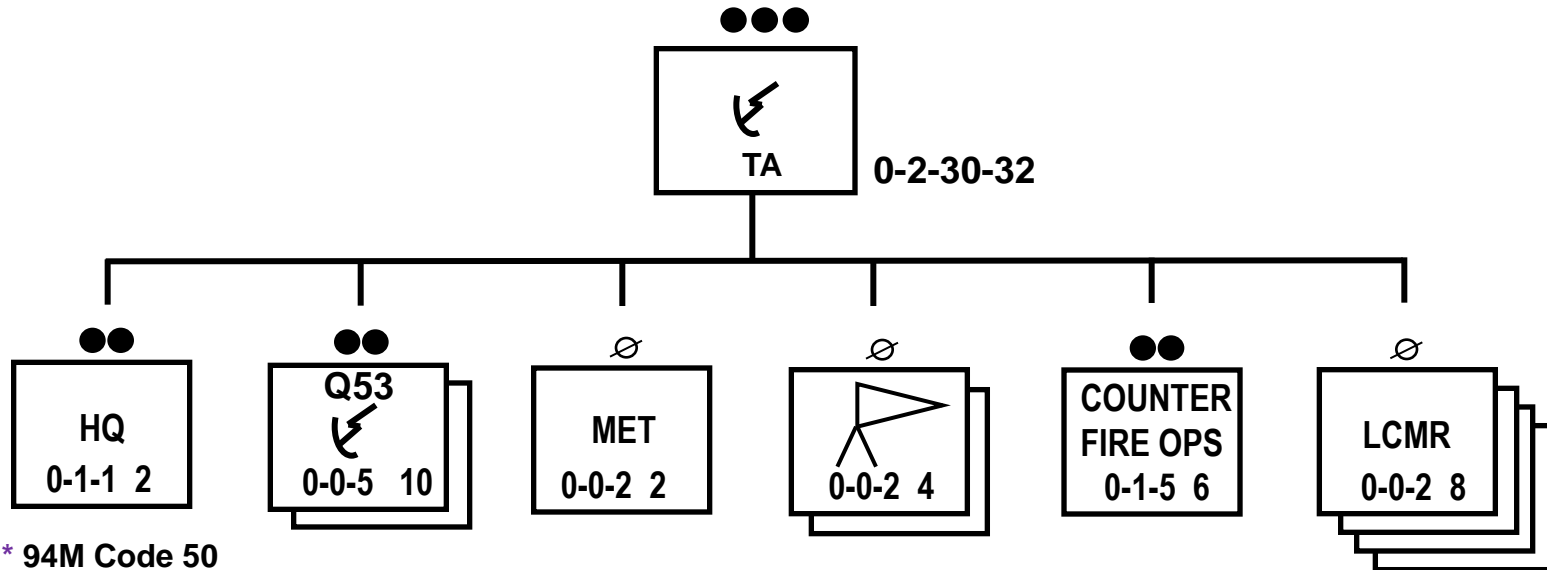

* Code 50 accounted for on SRC 63 not included in total

TARGET ACQUISITION PLATOON, FIRES BN, ABCT

Mission:
**To provide team-level command and control
 for attached Field Artillery target acquisition teams.**

06520RA00
 0/1/1//2

TARGET ACQUISITION PLT HQ PARA 01

FBCB2 AN/PSG-14(V)1
 AN/VAS-5 M240B
 x2 NVG MWTS
 DAGR KOI-18/TSEC
 AN/VRC-92F



CW2 131A0 PLT LDR M4
 SFC 13R40 PLT SGT M4

EQUIPMENT SUMMARY

WEAPONS

LAUNCHER GRENADE: M320A1----- 1
 MACHINE GUN 7.62MM M240B----- 1
 RIFLE 5.56MM M4 CARBINE----- 2

VEHICLES, TRAILERS, AND TRLR MTD SYSTEMS

TRUCK UTILITY EXP CAPACITY ENH 4X4: M1165A1----- 1
 TRAILER HIGH MOBILITY 1-1/4T (M1102)----- 1

NIGHT VISION/OBSERVATION EQUIPMENT

DRIVERS VISION ENHANCER: AN/VAS-5----- 1
 NIGHT VISION GOGGLES: AN/PVS-7B----- 2
 SIGHT THERMAL: AN/PAS-13B(V)2 MEDIUM TWS----- 1

COMMUNICATION-ELECTRONICS EQUIPMENT

ANTENNA GROUP: OE-254----- 1
 COMPUTER SYSTEM DIGITAL: AN/PSG-14(V)1 LFED----- 1
 COMP SET DIGITAL: AN/UJK-128(V)3 (FBCB2 BFT APPLIQUE)----- 1
 NAVIGATION SET: SATELLITE SIGNALS AN/PSN-13 (DAGR)----- 1
 RADIAC SET: AN/VDR-2----- 1
 RADIO SET: AN/VRC-92F----- 1

WLRS, (TPQ-53), FIRES BN, IBCT

Mission:
**To locate enemy mortar firing
 positions in the area of operations.**

06540RB00
 0/0/5// 5

(X2) WEAPONS LOCATING RADAR SECTION (TPQ-53) PARA 01



(TPQ-53)
 SSG 13R30 SECT CHIEF M4
 PFC 13R10 FF RADAR OPR M4
 SGT 13R20 SR FF RADAR OPR M4
 SPC 13R10 FF RADAR OPR M4
 PFC 13R10 FF RADAR OPR M4
 AN/PU - 805B

EQUIPMENT SUMMARY

WEAPONS

LAUNCHER GRENADE: M320A1----- 1
 MACHINE GUN 7.62MM M240B----- 1
 RIFLE 5.56MM M4 CARBINE----- 4

VEHICLES, TRAILERS, AND TRLR MTD SYSTEMS

GENERATOR SET: DED TM: 10KW 400HZ PU-799----- 1
 TRUCK CARGO MTV----- 2

MISCELLANEOUS EQUIPMENT

GEN SET: DED SKID MTD 60KW PU-805B-)----- 1
 RADAR SET: AN/TPQ-53----- 1

COMMUNICATION-ELECTRONICS EQUIPMENT

ANTENNA GROUP: OE-254----- 2
 COMP SET DIGITAL: AN/UJK-128(V)3 (FBCB2 BFT APPLIQUE)----- 1
 NAVIGATION SET: SATELLITE SIGNALS AN/PSN-13 (DAGR)----- 2
 RADIAC SET: AN/VDR-2----- 1
 RADIO SET: AN/VRC-90F----- 3
 RADIO SET: AN/VRC-92F----- 1

NIGHT VISION/OBSERVATION EQUIPMENT

DRIVERS VISION ENHANCER: AN/VAS-5----- 2
 NIGHT VISION GOGGLES: AN/PVS-7B----- 5
 MEDIUM WEAPON THERMAL SIGHT (MWTS): AN/PAS-13(V)2----- 1

METEOROLOGICAL TEAM, FIRES BN, ABCT

Mission:

To provide meteorological data for Field Artillery technical fire direction.

06520RD00
0/0/2/2

METEOROLOGICAL TEAM PARA 01

FBCB2 M240B
AN/VAS-5 MWTS
x2 NVG AN/TSR-8
DAGR KOI-18/TSEC
AN/VRC-92F
AN/VRC-90F

EQUIPMENT SUMMARY



SGT 13T20 (METRO EQ REP) C
SP4 13T10 (FA METRO CREWMEMBER) C

WEAPONS

MACHINE GUN 7.62MM M240B----- 1
RIFLE 5.56MM M4 CARBINE----- 2

VEHICLES, TRAILERS, AND TRLR MTD SYSTEMS

TRUCK UTILITY EXP CAPACITY ENH 4X4: M1152A1----- 1
TRAILER HIGH MOBILITY 1-1/4T (M1102)----- 1

MISCELLANEOUS EQUIPMENT

METEOROLOGICAL MEASURING SET: PROFILER AN/TMQ-52----- 1

COMMUNICATION-ELECTRONICS EQUIPMENT

1 ANTENNA GROUP: OE-254----- 1
2 NAVIGATION SET: SATELLITE SIGNALS AN/PSN-13 (DAGR)----- 1
RADIAC SET: AN/VDR-2----- 1
RECEIVE SUITE: AN/TSR-8 (GRT)----- 1
RADIO SET: AN/VRC-90F----- 1
RADIO SET: AN/VRC-92F----- 1

NIGHT VISION/OBSERVATION EQUIPMENT

DRIVERS VISION ENHANCER: AN/VAS-5----- 1
NIGHT VISION GOGGLES: AN/PVS-7B----- 2
MEDIUM THERMAL WEAPONS SIGHT: AN/PAS-13(V2)----- 1

SURVEY TEAM, FIRES BN, ABCT

06520RE00
0/0/2/2

Mission:

To provide survey control points and other data for precise locating and orientation of radars and meteorological sets.

(X2) FA SURVEY TEAM PARA 01

FBCB2 AN/PSG-14(V)1
AN/VAS-5 M249
x2 NVG MWTS
DAGR
AN/VRC-92F



SGT 13T20 SURVEYOR COMPUTER/PADS TEAM CHIEF M4
SPC 13T10 FA SURVEYOR/PADS VEH DRIVER M4

EQUIPMENT SUMMARY

WEAPONS

LAUNCHER GRENADE: M320A1----- 1
MACHINE GUN LIGHT 5.56MM M249----- 1
RIFLE 5.56MM M4 CARBINE----- 2

VEHICLES, TRAILERS, AND TRLR MTD SYSTEMS

TRUCK UTILITY EXP CAPACITY ENH 4X4: M1152A1----- 1

MISCELLANEOUS EQUIPMENT

IMPROVED POSN AND AZIMUTH DETERMINING SYS: (IPADS)----- 1

COMMUNICATION-ELECTRONICS EQUIPMENT

1 COMPUTER SYSTEM DIGITAL: AN/PSG-14(V)1 LFED----- 1
1 NAVIGATION SET: SATELLITE SIGNALS AN/PSN-13 (DAGR)----- 1
2 RADIAC SET: AN/VDR-2----- 1
RADIO SET: AN/VRC-92F----- 1

NIGHT VISION/OBSERVATION EQUIPMENT

DRIVERS VISION ENHANCER: AN/VAS-5----- 1
MINI EYESAFE LASER INFR OBSN DEVICE: (MELIOS): AN/PVS-6----- 1
NIGHT VISION GOGGLES: AN/PVS-7B----- 2
MEDIUM THERMAL WEAPONS SIGHT: AN/PAS-13(V2)----- 1

COUNTERFIRE OPERATIONS SECTION, FIRES BN, ABCT

06520RF00
0/15/6

Mission:
To provide target processing
and targeting data for attack by lethal means.

COUNTERFIRE OPERATIONS SECTION, FIRES BN (ABCT) PARA 01

FBCB2
x2 NVG
DAGR
AN/VRC-92F

AN/PSC-5
AN/GYK-56



CW2 131A0 TARGETING OFF M4 S
SFC 13R40 SR FA TARGETING NCO M4
SSG 13F30 TARGETING NOC M4
SGT 13F20 TGT NCO M4
SPC 13F10 TGT PROC SP M4
PFC 13F10 TGT PROC SP M4

EQUIPMENT SUMMARY

WEAPONS

RIFLE 5.56MM M4 CARBINE----- 6

VEHICLES, TRAILERS, AND TRLR MTD SYSTEMS

TRUCK UTILITY EXP CAPACITY ENH 4X4: M1165A1----- 1
LIGHT TACTICAL TRAILER: 3/4T (M1101)----- 1

COMMUNICATION-ELECTRONICS EQUIPMENT

NAVIGATION SET: SATELLITE SIGNALS AN/PSN-13 (DAGR)----- 1
RADIO SET: AN/VRC-92F----- 1
RADIO SET: AN/PSC-5----- 1
COMPUTER SET FA GENERAL: AN/GYK-56 (EMT)----- 1

NIGHT VISION/OBSERVATION EQUIPMENT

NIGHT VISION GOGGLES: AN/PVS-7B----- 2

LIGHTWEIGHT COUNTER MORTAR RADAR SECTION, (TPQ-50) FIRES BN, ABCT

06520RG00
0/0/8/8

Mission:
To locate enemy mortar firing
positions in the area of operations.

LCMR SECTION PARA 01

FBCB2
x2 NVG
DAGR
AN/VRC-89F



SSG 13R30 SECT CH M4
SPC 13R10 LCMR RADAR OPR M4

FBCB2
x2 NVG
DAGR
AN/VRC-89F



SGT 13R20 SR LCMR RD OPR M4
PFC 13R10 LCMR RADAR OPR M4

FBCB2
x2 NVG
DAGR
AN/VRC-89F



SPC 13R10 LCMR RADAR OPR M4
PFC 13R10 LCMR RADAR OPR M4

X2

EQUIPMENT SUMMARY

WEAPONS

LAUNCHER GRENADE: M320A1----- 4
RIFLE 5.56MM M4 CARBINE----- 8

VEHICLES, TRAILERS, AND TRLR MTD SYSTEMS

GEN SET DED TM: 5KW 60HZ (PU-797)----- 4
TRUCK UTILITY EXP CAPACITY ENH 4X4: M1152A1----- 4

MISCELLANEOUS EQUIPMENT

LIGHTWEIGHT COUNTER MORTAR RADAR: AN/TPQ-50----- 4

COMMUNICATION-ELECTRONICS EQUIPMENT

ANTENNA GROUP: OE-254----- 4
NAVIGATION SET: SATELLITE SIGNALS AN/PSN-13 (DAGR)----- 4
RADIO SET: AN/VRC-89F----- 4

NIGHT VISION/OBSERVATION EQUIPMENT

NIGHT VISION GOGGLES: AN/PVS-7B----- 8

HHC, BRIGADE SUPPORT BN (BSB), ABCT

MISSION.

To provide command and control, staff planning, supervision and field feeding support for all organic assigned or attached units to the Brigade Support Battalion (BSB).

HHC, BSB, ABCT

63326R000
17/2/66//85

COMMAND SECTION PARA 01

CURR OPS-INTEL/S2 PARA 02

CURRENT OPS-OPS/S3 PARA 03

SUSTAINMENT 1-S1 PARA 04

SUSTAINMENT 1-S4 PARA 05

AN/YTQ-90(V)2
FBCB2
2X NVG
DAGR
ON-721/V
AN/VRC-92F



LTC 90A00 CDR M4 M9
SPC 88M10 DRIVER M4

MAJ 90A00 XO M4 M9

AN/UHQ-90(V)2
FBCB2
2X NVG
DAGR
AN/VRC-90F



CSM 00Z50 CSM M4 M9

2X NVG
DAGR
AN/TYQ-93
AN/VRC-90F



CPT 35D00 S2 M4
SGT 35F20 INTEL ANLST M4
SPC 35F10 INTEL ANLST M4

2X NVG
DAGR
AN/VRC-92F
AN/VRC-104(V)3



FBCB2
AN/GYK-61
2X NVG
AN/VRC-90F



2X NVG
DAGR
AN/VRC-92F
AN/VRC-104(V)3



COMPUTER SYS DIGITAL
AN/PYQ-6C

MAJ 90A00 S3 M4 M9
CPT 90A00 OPS OFF M4
CPT 90A00 PLANS OFF M4
MSG 92A50 OPS SGT M4
SSG 74D30 CBRN NCO M4
SGT 29E20 EW SGT M4
SGT 74D20 CBRN NCO M4
SSG 29E30 EW SGT M4
SPC 74D10 CBRN SP M4

MED PWR PLANT

AN/MJQ-40 PU
A UNIT B UNIT

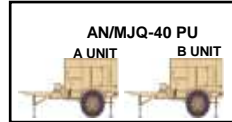

2X NVG
DAGR
AN/VRC-90F



COMPUTER SYS DIGITAL
OL-701A/TYQ
4X ARMY HR WORKSTATION

CPT 42B00 S1 M4
SFC 42A40 SR HR SGT M4
SSG 42A30 HR SGT M4
SGT 42A20 HR SGT M4
SGT 27D20 PARALEGAL M4
SPC 42A10 HR SP M4
PFC 42A10 HR SP M4
PFC 42A10 HR SP M4

AN/GYK-61
AN/TYQ-109(V)1
AN/UHQ-90(V)3
2X NVG
DAGR
AN/VRC-90F



MED PWR PLANT

CPT 90A00 S4 M4
MSG 91Z50 SR MAINT SUPV M4
SFC 92Y40 SUPPLY SGT M4
SPC 92Y10 SUPPLY SP M4
SGT 92Y20 SUPPLY NCO M4

SUSTAINMENT 1-C4OPS/S6 PARA 06

SUSTAINMENT 1-UMT PARA 7

SUSTAINMENT 2-SUPPORT OPERATIONS PARA 08

AN/PYQ-12
AN/TSQ-243
2X KG-175
AN/TSR-8
AN/GYK-50B
AN/TSQ-259
AN/GYK-62B

2X NVG
DAGR
AN/VRC-92F



2X NVG
DAGR
AN/VRC-90F



SFC 25U40 SECT CH M4
SPC 25B10 LAN MGR M4
SSG 25E30 ELECTRO SPECT NCO M4
SPC 25U10 SIG SPT SYS MAINT M4
SPC 25U10 SIG INFO SVC SP M4
SPC 25U10 SIG SPT SYS MAINT M4
SGT 25Q20 SR XMSN SYS OPR M4
SPC 25Q10 XMSN SYS OPR MNT M4
PFC 25B10 LAN MGR M4
PFC 25U10 SIG SPT SYS SP M4

2X NVG
DAGR
AN/VRC-90F



2X NVG
DAGR
AN/VRC-90F



BATTALION COMMAND
POST SWITCHING GROUP

2X NVG
DAGR
AN/VRC-90F



CPT 56A00 CHAPLAIN
PFC 56M10 CHAPLAIN ASST M4

AN/UHQ-90(V)2
FBCB2
2X NVG
DAGR
AN/VRC-92F



2X NVG
DAGR
AN/VRC-90F



AN/TYQ-106(V)1
AN/GYK-61
AN/TYQ-105(V)1
OL-701A/TYQ
AN/VRC-90F
OL-713/TYQ



2X NVG
DAGR
AN/VRC-90F



FBCB2
AN/TYQ-129(V)2
2X NVG
AN/VRC-89F
AN/VRC-104(V)3
MED PWR PLANT

MAJ 90A00 SUPP OPS OFF M4 M9
CPT 92A00 OPS OFF M4
CPT 88A00 TRANS OFF M4
CPT 70H67 MED OPS OFF M4
CPT 91A00 AMMO OFF M4
CPT 70K67 MED LOG OFF M4
SFC 92A40 MAT MGT NCO M4
SSG 88N30 MVTS SUPV M4
SFC 68W40 OPS SGT M4
SFC 89B40 AMMO LOG SGT M4
CW4 91E50 SR ORD GRD MAINT WO M4
SFC 91C40 MAINT MGT NCO M4
MSG 92A50 OPS SGT M4
SSG 92F30 PETRL SUPPLY SGT M4
SSG 92M30 MORTUARY AFFAIRS NCO M4
SSG 89B30 AMMO INSP M4
SGT 88N20 TRANS MGMT NCO M4

SUSTAIN 2-C4OPS/CSSAMO PARA 09

COMPANY HEADQUARTERS PARA 10

FIELD FEEDING SECTION PARA 11

2X NVG
DAGR
AN/VRC-90F



CW2 251A0 INFO SYS TECH M4
SFC 25B40 INFO SYS SUPV M4
SGT SR INFO SYS SP M4
SGT 68G20 PAT SVCS NCO M4
SGT 92A30 MAT MGT NCO M4
SSG 92Y30 SUPPLY SGT M4
SPC 25B10 INFO SYS SP M4
SGT 92Y20 SUPPLY NCO M4
SGT 92A20 MAT MGT NCO M4
PFC 25B10 INFO SYS SP M4



AN/TYQ-107(V)1
AN/TYQ-109(V)2

AN/TYQ-107(V)1
AN/TYQ-120(V)2
AN/TYQ-108(V)3
OL-603/TYQ
DGR
AN/VRC-90F
AN/TYQ-141

AN/UHQ-90(V)2
AN/TYQ-105(V)1
OL-608/TYQ
2X NVG
OL-701A/TYQ
OL-713(V)1/TYQ

AN/UHQ-90(V)2
FBCB2
2X NVG
DAGR
AN/VRC-92F



2X NVG
DAGR
AN/VRC-90F



SGT 92Y20 SUPPLY NCO M4
SPC 92Y10 SUPPLY SP M4

OL-701A/TYQ
RAVEN
.50 CAL
HWTS



1SG 92A5M 1SG M4

2X NVG
AN/VRC-90F



2X NVG
AN/VRC-90F



SFC 92G40 SR FOOD OPNS SGT M4
SSG 92G30 FOOD OPS MGR M4
SPC 92G10 FOOD OPS SP M4
SPC 92G10 FOOD OPS SP M4
SPC 92G10 FOOD OPS SP M4
PFC 92G10 FOOD OPS SP M249
SGT 92G20 FOOD OPS NCO M4
SGT 92G20 FOOD OPS NCO M4
PFC 92G10 FOOD OPS SP M4
PFC 92G10 FOOD OPS SP M4

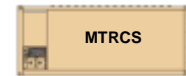

MTRCS

EQUIPMENT SUMMARY

WEAPONS

L69080	LAUNCHER GRENADE: M320A1	4
M09009	MACHINE GUN 5.56 MILLIMETER: M249	8
M39263	MACHINE GUN: LIGHT 5.56MM M249	4
M92362	MACHINE GUN GRENADE 40MM: MK19 MOD III	1
M92841	MACHINE GUN: 7.62MM M240B	3
P98152	PISTOL 9MM AUTOMATIC: M9	6
R97234	RIFLE 5 56 MILLIMETER: M4	73
Z00686	MACHINE GUN: CALIBER .50	3

VEHICLES, TRAILERS AND TRLR MTD SYSTEMS

C27633	CONTAINERIZED KITCHEN: CK	1
E02807	CHASSIS TRAILER: GENERATOR 2-1/2 TON 2 WHEEL W/E	1
P42126	POWER PLANT: ELECTRIC TRAILER MTD 30KW 50/60HZ AN/MJQ 40	1
P63462	POWER PLANT: UTILITY (MEDIUM)	3
T37588	TRUCK UTILITY EXPANDED CAPACITY ENHANCED: M1152A1	7
T41271	TRUCK VAN: EXPANSIBLE MTV W/E M1087A1	1
T56383	TRUCK UTILITY EXPANDED CAPACITY ENHANCED 4X4: M1165A1	8
T60081	TRUCK CARGO: 4X4 LMTV W/E	6
T61908	TRUCK CARGO: MTV W/E	3
T95924	TRAILER CARGO: HIGH MOBILITY 1-1/4 TON	4
T9564	TRAILER FLAT BED: M1082 TRLR CARGO LMTV W/DROPSIDES	4
Z00206	MULTI-TEMPERATURE REFRIGERATED CONTAINER SYSTEM: MTRCS	1
Z36683	TRAILER TANK WATER (CAMEL): 800 GAL 5 TON W/E	2

NIGHT VISION/OBSERVATION

N05482	NIGHT VISION: GOGGLE	52
S90535	MEDIUM WEAPON THERMAL SIGHT (MWTS): AN/PAS-13(V)2	7
S90603	HEAVY WEAPON THERMAL SIGHT (HWTS): AN/PAS-13(V)3	4

MISC EQUIPMENT

C79000	COLLECTIVE PROTECTION EQUIPMENT: NBC SIMPLIFIED M20	4
D82404	DECONTAMINATING APPARATUS: PWR DRVN LT WT	2
G42170	GEN SET DED TM: 10KW 60HZ MTD ONM116A2 PU-798	1
G74711	GEN SET: DED SKID MTD 10KW 60HZ	1
J00697	JOINT CHMCL AGENT: DETECTOR	3
J01197	JOINT SERVICE: TRANSPORTABLE DECONTAMINATION	2
M12986	MASK CHEMICAL BIOLOGICAL JOINT SERVICE GENERAL PURPOSE: FIELD M50	82
R20684	RADIAC SET: AN/VDR-2	3
R20684	RADIAC SET: AN/VDR-2	1
R30925	RADIAC SET: AN/PDR-75	1
R31061	RADIAC SET: AN/UDR-13	4
S83835	SMALL UNMANNED AIRCRAFT SYSTEM (SUAS): RAVEN B (MIP)	1
Z01330	GEN SET DED 10KW 50/60HZ: SKID-MTD	1

COMMUNICATIONS AND ELECTRONICS

A35329	ALL SOURCE ANALYSIS SYSTEM: AN/TYQ-93	1
C18209	COMPUTER SET: DIGITAL AN/TYQ-107(V)2	1
C18277	COMPUTER SET: DIGITAL AN/TYQ-107(V)1	1
C18278	COMPUTER SYSTEM: DIGITAL AN/UHQ-90(V)2	7
C18345	COMPUTER SET: DIGITAL AN/TYQ-106(V)1	1
C18378	COMPUTER SET: AN/UHK-128(V)3	6
C18448	COMPUTER SYSTEM: DIGITAL AN/GYK-61	4
C18641	COMPUTER SYST DIGITAL: AN/PYQ-12	1
C27435	COMPUTER SYSTEM: DIGITAL AN/TYQ-129(V)2	3
C27503	COMPUTER SYSTEM: DIGITAL AN/TYQ-105(V)1	2
C27639	COMPUTER SYSTEM: DIGITAL AN/TYQ-108(V)3	1
C27707	COMPUTER SYSTEM: DIGITAL AN/TYQ-109(V)1	2
C27775	COMPUTER SYSTEM: DIGITAL AN/TYQ-109(V)2	1
C27823	COMPUTER SET: DIGITAL OL-608/TYQ	2
C27963	COMPUTER SYSEM: DIGITAL	5
C61665	COMMAND CENTER SYSTEM: AN/TSQ-243	1
C67436	COMPTER SYSTEM DIGITAL: AN/PYQ-6C	1
C78827	COMPUTER SET: DIGITAL OL-603/TYQ	1
C78851	COMPUTER SYSTEM: DIGITAL AN/UHQ-90(V)3	4
E08940	ENCRYPTION-DECRYPTION EQUIPMENT: TACLANE KG 175	3
J54771	INTERCONNECT GROUP: ON-721/V	1
N96248	NAVIGATION SET: SATELLITE SIGNALS AN/PSN-13	21
P99881	PROCESSOR GROUP SIG DATA: (CAISI 2.0) OL-701A/TYQ	5
R30658	RECEIVE SUITE: AN/TSR-8	1
R44999	RADIO SET: AN/VRC-89F(C)	1
R45543	RADIO SET: AN/VRC-92F(C)	6
R68044	RADIO SET: AN/VRC-90F(C)	18
R87139	RADIO ST: AN/VRC-104(V)3 150 WATT W/PRC-150 HF RADIO	3
R93169	RADIO TEST SET: AN/PRM-34()	4
Z00384	COMPUTER SYSTEM DIGITAL: AN/PYQ-10(C)	21
Z00513	COMPUTER SYSTEM DIGITAL: AN/GYK-50B (ISYSCON) (V)4	1
Z00560	INTERFACE UNIT COMMUNICATION EQUIPMENT: OL-713(V)1/TYQ CSS VSAT	2
Z00564	BATTALION COMMAND POST(SWITCHING GROUP): OM-XXX	1
Z00930	COMMUNICATIONS SUBSYSTEM: AN/TSQ-259	1
Z01160	COMPUTER SYSTEM: DIGITAL AN/TYQ-141	2
Z01248	COMPUTER SET: DIGITAL AN/GYK-62B	1
Z39781	ARMY H RESURCES: WRKSTATION	5

DISTRIBUTION COMPANY, BSB, ABCT

63028R000
5/2/136/143

COMPANY HEADQUARTERS PARA 01

TRANS PLT HQ PARA 02

TRANSPORTATION PLATOON PARA 03

Mission:
To provide field maintenance, transportation, and supply support to a ABCT.

FBCB2 AN/UYQ-90(V)3
2X NVG KG-175
DAGR ON-721/V
HWTS
.50 CAL



CPT 90A00 CDR M4 M9
SFC 88M40 TRUCKMASTER M4
SPC 92Y10 SUPPLY SP M249

2X NVG DAGR
HWTS .50 CAL
X4 M249
X2 M240B
X4 M320A1
AN/UYK-128
AN/VRC-90F
OL-701A/TYQ
AN/UYQ-90(V)3
AN/TYQ-109(V)1
X2 AN/UYK-128(V)1



1LT 92A00 OPS OFF M4
1SG 92A5M 1SG M4
SSG 92Y30 SUPPLY SGT M4

AN/UYQ-90(V)2 AN/TYQ-129(V)2
FBCB2 AN/UYQ-90(V)3
2X NVG
DAGR
AN/VRC-92F



1LT 88A00 PLT LDR M4
SFC 88M40 PLT SGT M4
SGT 88M20 DISPATCHER M4
SGT 88M20 DISPATCHER M4

AN/UYQ-90(V)2
2X NVG
AN/VRC-90F
AN/UYQ-90(V)2
HWTS
.50 CAL



x20

SSG 88M30 SQD LDR M4 AN/PRC-148(V)4
SSG 88M30 SQD LDR M4 AN/PRC-148(V)4
SSG 88M30 HVY VEH DRIVER M4
SSG 88M30 HVY VEH DRIVER M4

SGT 88M20 HVY VEH DRIVER M4
SGT 88M30 HVY VEH DRIVER M4
SGT 88M30 HVY VEH DRIVER M4
SGT 88M30 HVY VEH DRIVER M4
SGT 88M30 HVY VEH DRIVER M4
SGT 88M30 HVY VEH DRIVER M4

SPC 88M10 HVY VEH DRIVER M4
SPC 88M10 HVY VEH DRIVER M4
SPC 88M10 HVY VEH DRIVER M4
SPC 88M10 HVY VEH DRIVER M4
SPC 88M10 HVY VEH DRIVER M4
SPC 88M10 HVY VEH DRIVER M4

PFC 88M10 HVY VEH DRIVER M4
PFC 88M10 HVY VEH DRIVER M4
PFC 88M10 HVY VEH DRIVER M240
PFC 88M10 HVY VEH DRIVER M240

x2

SUPPLY PLT HQ PARA 04

GENERAL SUPPLY AND CLASS IX SECTION PARA 05

AN/UYQ-90(V)2
FBCB2
2X NVG
DAGR
AN/VRC-90F



OL-603/TYQ
AN/UYQ-90(V)3
OL-701A/TYQ



1LT 92A00 PLT LDR M4
CW2 920B0 SUPPLY SYS TECH M4
SFC 92A40 PLT SGT M4
SSG 92A30 MAT CON/ACCTG SUPV M4
SGT 92A20 MAT CON/ACCTG NCO M4
SPC 92A10 MAT CON/ACCTG SP M4
SPC 92A10 MAT CON/ACCTG SP M4
PFC 92A10 MAT CON/ACCTG SP M249

2X NVG
DAGR
OL-604/TYQ
AN/VRC-90F
(ALSO 8 LMR FOR SECTION USE)



x4

SFC 92A40 STOCK CNTL SUPV M4
X2 SSG 92A30 MAT MGMT SUPV M4
SGT 92A20 MAT STORE/HDLG SGT M4
SGT 92A20 MAT STORE/HDLG SGT M4
X2 SGT 92A20 MAT STORE/HDLG SGT M4
SGT 92A20 MAT STORE/HDLG SGT M4



**REMOVED
FROM ABCT
Moved to EAB**

2X NVG
DAGR
AN/VRC-90F



x4



SPC 92A10 MAT STORE/HDLG SP M4
SPC 92A10 MAT STORE/HDLG SP M249
X3 SPC 92A10 MAT STORE/HDLG SP M4
SPC 92A10 MAT STORE/HDLG SP M249
SPC 92A10 SUBSISTANCE SUP SP M4

X3 PFC 92A10 MAT STORE/HDLG SP M249
X2 PFC 92A10 MAT STORE/HDLG SP M4
PFC 92A10 MAT STORE/HDLG SP M4
PFC 92A10 MAT STORE/HDLG SP M4
PFC 92A10 MAT STORE/HDLG SP M4
PFC 92A10 MAT STORE/HDLG SP M4
X2 PFC 92A10 SUBSISTANCE SUP SP M4



x10



x6

2X NVG
DAGR
AN/VRC-90F
OL-701A/TYQ



x5



DISTRIBUTION COMPANY, BSB, ABCT

AMMUNITION TRANSFER HOLDING POINT SECTION PARA 06

AN/UYQ-90(V)2
FBCB2
2X NVG
DAGR
AN/VRC-90F



2X NVG
DAGR
AN/VRC-90F



x3

2X NVG
DAGR
AN/VRC-90F



x2



x2

CW2 890A0 AMMO WO M4
SSG 89BSECT CHIEF M4
SGT 89B20 AMMO SGT M4
SPC 89B10 AMMO SPEC M4
SPC 89B10 AMMO SPEC M4

SPC 89B10 AMMO SPEC M4
PFC 89B10 AMMO SPEC M4
X2 PFC 89B10 AMMO SPEC M4
SGT 89A20 AMMO STK CON/ACCTG SP M4
SPC 89A10 AMMO SYTK CON/ACCTG SP M4

FUEL AND WATER PLT HQ PARA 07

FBCB2
2X NVG
DAGR
AN/VRC-90F
AN/UYQ-90(V)3



1LT 92A00 PLT LDR M4
SFC 92F40 PLT SGT M4
SGT 92L20 PETRL LAB SGT M4

CLASS III SECTION (X3) PARA 08

2X NVG
DAGR
AN/VRC-90F



x18

2X NVG
DAGR
AN/VRC-90F



x15

X3 SSG 92F30 SECTION CHIEF M4
X6 SGT 92F20 PETRL HVY VEH OPR M4
X3 SGT 92F20 PETRL HVY VEH OPR M4
X3 SGT 92F20 PETRL HVY VEH OPR M4

X6 SPC 92F10 PETRL VEH OPR M4
X3 SPC 92F10 PETRL VEH OPR SAW
X6 SPC 92F10 PETRL VEH OPR M4
X3 SPC 92F10 PETRL VEH OPR SAW
X3 SPC 92F10 PETRL VEH OPR M4

WATER SECTION PARA 09

2X NVG
DAGR
M240B
AN/VRC-90F
MK19 MOD III
AN/UYQ-90(V)2



x5

SSG 92W30 WATER TRMT SUPV M4
SGT 92W20 WATER TRMT NCO M4
SGT 92W20 WATER TRMT NCO M4

X2 SPC 92W10 WATER TMT SP M4
X2 SPC 92W10 WATER TMT SP M4

PFC 92W10 WATER TRMT SP M4
PFC 92W10 WATER TRMT SP M4
PFC 92W10 WATER TRMT SP M249

2X NVG
DAGR
AN/VRC-90F

AN/UYQ-90(V)2
2X NVG
AN/VRC-90F



REMOVED FROM ABCT
Moved to EAB

2X NVG
DAGR
AN/VRC-90F

2X NVG
AN/VRC-90F



SGT 92W20 WATER TRMT NCO M4
SGT 92W20 WATER TRMT NCO M4
SGT 92W20 WATER TRMT NCO M4
SGT 92W20 WATER TRMT NCO M4
SPC 92W10 WATER TMT SP M4
SPC 92W10 WATER TMT SP M4
SPC 92W10 WATER TMT SP M4
SPC 92W10 WATER TMT SP M4
SPC 92W10 WATER TMT SP M4
PFC 92W10 WATER TRMT SP M4
PFC 92W10 WATER TRMT SP M4

REMOVED FROM ABCT
Moved to EAB

x2

x3

EQUIPMENT SUMMARY

WEAPONS

L69080	LAUNCHER GRENADE: M320A1	4
M09009	MACHINE GUN 5.56 MILLIMETER: M249	16
M39263	MACHINE GUN: LIGHT 5.56MM M249	4
M92362	MACHINE GUN GRENADE 40MM: MK19 MOD III	8
M92841	MACHINE GUN: 7.62MM M240B	13
P98152	PISTOL 9MM AUTOMATIC: M9	1
R97234	RIFLE 5 56 MILLIMETER: M4	139
Z00686	MACHINE GUN: CALIBER .50	10

VEHICLES, TRAILERS AND TRLR MTD SYSTEMS

G42238	GEN SET DED TM: 5KW 60HZ MTD ON M116A2 PU-797	1
S70517	SEMITRAILER LOW BED: 25 TON 4 WHEEL W/E	7
T32629	LOAD HANDLING SYS (LHS): 2000 GAL COMP WATER TANK-RACK (HIPPO)	16
T37588	TRUCK UTILITY EXPANDED CAPACITY ENHANCED: M1152A1	2
T49255	TRUCK LIFT FORK: DSL DRVN 4000 LB CAP ROUGH TERRAIN	1
T56383	TRUCK UTILITY EXPANDED CAPACITY ENHANCED 4X4: M1165A1	4
T58161	TRUCK TANK: FUEL SERVICING 2500 GALLON 8X8 HEAVY EXP MOB W/WINCH	3
T60081	TRUCK CARGO: 4X4 LMTV W/E	13
T61239	TRUCK TRACTOR: MTV W/E	7
T61908	TRUCK CARGO: MTV W/E	2
T73347	TRUCK LIFT: FORK VARIABLE REACH ROUGH TERRAIN	6
T87243	TRUCK TANK: FUEL SERVICING 2500 GALLON 8X8 HEAVY EXP MOB	3
T93761	TRAILER: PALLETIZED LOADING 8X20	39
T95555	TRAILER CARGO: MTV W/DROPSIDES M1095	1
T95924	TRAILER CARGO: HIGH MOBILITY 1-1/4 TON	2
T95992	LIGHT TACTICAL TRAILER: 3/4 TON	2
T96496	TRUCK CARGO: TACTICAL 8X8 HEAVY EXPANDED MOB W/LHS	34
T96564	TRAILER FLAT BED: M1082 TRLR CARGO LMTV W/DROPSIDES	13
Z36683	TRAILER TANK WATER (CAMEL): 800 GAL 5 TON W/E	1

NIGHT VISION/OBSERVATION

N05482	NIGHT VISION: GOGGLE	138
S90535	MEDIUM WEAPON THERMAL SIGHT (MWTS): AN/PAS-13(V)2	17
S90603	HEAVY WEAPON THERMAL SIGHT (HWTS): AN/PAS-13(V)3	18

COMMUNICATIONS AND ELECTRONICS

C18278	COMPUTER SYSTEM: DIGITAL AN/UUQ-90(V)2	43
C18378	COMPUTER SET: AN/UUK-128(V)3	5
C18684	COMPUTER SET: DIGITAL OL-604/TYQ	5
C27435	COMPUTER SYSTEM: DIGITAL AN/TYQ-129(V)2	1
C27707	COMPUTER SYSTEM: DIGITAL AN/TYQ-109(V)1	1
C78827	COMPUTER SET: DIGITAL OL-603/TYQ	1
C78851	COMPUTER SYSTEM: DIGITAL AN/UUQ-90(V)3	5
E08940	ENCRYPTION-DECRYPTION EQUIPMENT: TACLANE KG 175	1
J54771	INTERCONNECT GROUP: ON-721/V	1
N96248	NAVIGATION SET: SATELLITE SIGNALS AN/PSN-13	30
P99881	PROCESSOR GROUP SIG DATA: (CAISI 2.0) OL-701A/TYQ	4
R45543	RADIO SET: AN/VRC-92F(C)	2
R68044	RADIO SET: AN/VRC-90F(C)	66
Z00384	COMPUTER SYSTEM DIGITAL: AN/PYQ-10(C)	63
Z00712	COMPUTER SYSTEM DIGITAL: SAAS-MOD-ATHP	1
Z01320	RADIO SET: AN/PRC-148 (V) 4 URBAN JEM	10

MISC EQUIPMENT

B83002	BED CARGO: DEMOUNTABLE PLS 8X20	148
C05701	MONITOR CHEMICAL AGENT:	2
C84930	CONTAINER HANDLING: HEAVY EXP MOBIL TACT TRK (HEMTT)	6
F04898	FUEL SYSTEM SUPPLY POINT: FSSP TYPE 3 120K	1
F42612	FORWARD AREA WATER POINT SUPPLY SYSTEM: (FAW SS)	1
G11966	GEN SET: DED SKID MTD 5KW 60HZ	1
G12034	GEN SET: DED SKID MTD 60KW 50/60HZ	1
G18358	GEN SET: DED SKID MTD 3KW 60HZ	4
G74711	GEN SET: DED SKID MTD 10KW 60HZ	1
H94824	FORWARD AREA REFUELING EQUIPMENT: (FARE)	1
J00697	JOINT CHMCL AGENT: DETECTOR	6
M12986	MASK CHEMICAL BIOLOGICAL JOINT SERVICE GENERAL PURPOSE: FIELD M50	155
R20684	RADIAC SET: AN/VDR-2	6
R30925	RADIAC SET: AN/PDR-75	1
R31061	RADIAC SET: AN/UDR-13	14
S01359	SHELTER: TACTICAL EXPANDABLE TWOSIDE	2
T14017	TACTICAL WATER PURIFICATION SYSTEM (TWPS) 1500 GPH:	1
W30051	WATER: PURIFIER LIGHTWEIGHT	2
Z01279	COMMON REMOTELY OPERATED WPN STATION (CROWS):	12
Z01330	GEN SET DED 10KW 50/60HZ: SKID-MTD	1

FIELD MAINTENANCE COMPANY

43327R100
4/6/95/1/105

BSB, ABCT

COMPANY HEADQUARTERS PARA 01

Mission: To provide Field Level Maintenance support to a Heavy Brigade Support Battalion (BSB) for all automotive, ground support equipment, communications-electronic, armament peculiar systems, and limited recovery support.

AN/UYQ-90(V)2
FBCB2
ON-721/V
2X NVG
DAGR
AN/VRC-92F
HWTS
.50 CAL



CPT 90A91 CDR M4 M9

AN/UYQ-90(V)3
KOI-18/TSEC

2X NVG
AN/VRC-90F
HWTS
.50 CAL



1SG 94Z50 1SG M4
SPC 92Y10 SUPPLY SPEC M4

2X OL-701A/TYQ

AN/UYQ-90(V)2
FBCB2
2X NVG
DAGR
AN/VRC-90F



1LT 91A00 EXEC OFF M4

AN/VRC-90F



MAINT CONTROL SECTION AND PLT HQ PARA 02

2X NVG
AN/VRC-90F



1LT 91A00 MAINT CONTROL OFF M4
SFC 91X40 MAINT CONTROL SGT M4
PFC 92A10 EQUIP PARTS SP M4
PFC 92A10 EQUIP PARTS SP M4

2X NVG
OL-701A/TYQ
AN/VRC092F
KOI-18/TSEC



SGT 92A20 EQUIP PARTS SGT M4
SGT 92A20 EQUIP PARTS SGT M4

AN/UYQ-90(V)2
AN/UYQ-90(V)3
2X NVG
DAGR
AN/VRC-89F



SPC 92A10 EQUIP PARTS SP M4

2X NVG
AN/VRC-90F



SPC 92A10 EQUIP PARTS SP M249

FIELD MAINTENANCE COMPANY, BSB, ABCT

SERVICE/RECOVERY SECTION PARA 03

MAINTENANCE PLT HQ PARA 04

AN/UYQ-90(V)2
FBCB2
2X NVG
DAGR
AN/VRC-90F
HWTS
.50 CAL



x2

FBCB2
2X NVG
DAGR
AN/VRC-90F



AN/UYQ-90(V)2
FBCB2
M240B
2X NVG
DAGR
AN/VRC090F
MWTS



FBCB2
2X NVG
DAGR
AN/VRC-90F



2X NVG
AN/VRC-90F



CW2 914A0 ALLIED TRADES WO M4
SSG 91E30 RECOV VEH SUPV M4
PFC 91B10 RECOV VEH OPR M4
PFC 91B10 RECOV VEH OPR M4
SPC 91B10 RECOV VEH OPR M4
SGT 91B20 RECOV VEH OPR M4
SGT 91E20 ALLIED TRADES SP M4
PFC 91E10 ALLIED TRADES SP M4
PFC 91E10 ALLIED TRADES SP M4

AN/UYQ-90(V)2
FBCB2
2X NVG
DAGR
AN/VRC-92F



LT 91A00 PLT LDR M4
SFC 91X40 PLT SGT M4

FIELD MAINTENANCE SECTION PARA 05

AN/UYQ-90(V)2
FBCB2
2X NVG
DAGR
AN/VRC-90F



AN/UYQ-90(V)2
FBCB2
2X NVG
DAGR
AN/VRC-90F



AN/UYQ-90(V)2
FBCB2
2X NVG
DAGR
AN/VRC-90F



x5

AN/UYQ-90(V)2
FBCB2
2X NVG
DAGR
AN/VRC-90F

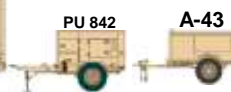

x2

AN/UYQ-90(V)2
FBCB2
2X NVG
DAGR
AN/VRC-90F



x2

2X NVG
AN/VRC-90F



AN/VRC-90F



CW2 915A0 UTO MAINT WO M4
SFC 91X40 MOTOR SGT M4
SSG 91B30 SHOP FOREMAN M4
SSG 91B30 SR MECH M4
SSG 91B30 SR MECH M4
SGT 91B20 WH VEH MECH M4
SGT 91B20 WH VEH MECH M4
SGT 91B20 WH VEH MECH M4
SGT 91B20 WH VEH MECH M4
SGT 91B20 WH VEH MECH M4
SGT 91B20 WH VEH MECH M4
SGT 91B20 WH VEH MECH M4
SGT 91B20 WH VEH MECH M4
SPC 91B10 WH VEH MECH M4
SPC 91B10 WH VEH MECH M4
SPC 91B10 WH VEH MECH M4
SPC 91B10 WH VEH MECH M4

SPC 91B10 WH VEH MECH M249
SPC 91B10 WH VEH MECH M249
SPC 91B10 WH VEH MECH M249
PFC 91B10 WH VEH MECH M4
PFC 91B10 WH VEH MECH M4
PFC 91B10 WH VEH MECH M4
PFC 91B10 WH VEH MECH M4
PFC 91B10 WH VEH MECH M4
PFC 91B10 WH VEH MECH M4
PFC 91B10 WH VEH MECH M4
PFC 91B10 WH VEH MECH M4
PFC 91B10 WH VEH MECH M4
PFC 91B10 WH VEH MECH M4
PFC 91B10 WH VEH MECH M4
PFC 91B10 WH VEH MECH M4
PFC 91B10 WH VEH MECH M4
PFC 91B10 WH VEH MECH M4

SGT 91B20 WH VEH MECH M4
SGT 91B20 WH VEH MECH M4
SPC 91B10 WH VEH MECH M4

AN/VRC-90F



x3

FIELD MAINTENANCE COMPANY, BSB, ABCT

GROUND SUPPORT EQUIPMENT REPAIR SECTION PARA 06

AN/UYQ-90(V)2
FBCB2
2X NVG
DAGR
AN/VRC-90F

AN/UYQ-90(V)2
FBCB2
2X NVG
DAGR
AN/VRC-90F

2X NVG
AN/VRC-90F

FBCB2
2X NVG
DAGR
AN/VRC-90F

FBCB2
2X NVG
DAGR
AN/VRC-90F



CW2 919A0 ENG EQUIP MAINT WO M4
SFC 91X40 SP PURP EQUIP REP SUPV M4
SSG 91C30 SR QM & CHEM EQ REP M4
SGT 91J20 QM/CHEM EQ REP M4
SPC 91J10 QM/CHEM EQ REP M4
SPC 91J10 QM/CHEM EQ REP M4
SPC 91C10 UTILITIES EQ REP M4
PFC 91J10 QM/CHEM EQ REP M4
PFC 91J10 QM/CHEM EQ REP M4

PFC 91D10 PWR-GEN EQ REP M4
PFC 91D10 PWR-GEN EQ REP M4
SPC 91D10 PWR-GEN EQ REP M4
SGT 91D20 PWR-GEN EQ REP M4

MISSILE ELECT REPAIR SECTION PARA 07

2X NVG
AN/VRC-90F

2X NVG
AN/VRC-90F

AN/ASM-147

PU 2101

NSMF

CW2 948B0 EL SYS MANT WO M4
CW2 948D0 EL-MSL SYS MNT WO M4
SFC 94W40 EL MAINT SUPV M4
SSG 94A30 LC ELECT MSL SYS FOREMAN M4
SPC 94A10 LC ELECT MSL SYS REP M4
PFC 94A10 LC ELECT MSL SYS REP M249
PFC 94A10 LC ELECT MSL SYS REP M249
SPC 94A10 LC ELECT MSL SYS REP M4
SPC 94E10 COMSEC/RADIO EQUIP RPR M4
SGT 94E20 SR COMSEC/RADIO RPR M4
SGT 15E20 UAS SYS REP/TM CH M4
SPC 15E10 UAS SYS REP M4
PFC 94E10 COMSEC/RADIO EQUIP RPR M4
SGT 94A10 LC ELECT MSL SYS REP M4
SPC 94F10 COMP/DET SYS REP M4

2X NVG
AN/VRC-90F

2X NVG
AN/VRC-90F

AN/ASM-146

2X NVG
AN/VRC-90F

PU 802

ARMAMENT REPAIR SECTION PARA 08

FBCB2
2X NVG
DAGR
AN/VRC-90F



2X NVG
AN/VRC-90F

2X NVG
AN/VRC-90F

NEXT GENERATION AUTOMATIC TEST SYSTEM (NGATS)



PU 806

x2

2X NVG
AN/VRC-90F



x2

CW2 913A0 ARMAMENT SYS MAINT WO M4
SSG 91K30 ARMT MAINT SUPV M4
SGT91F20 SMALL ARMS/ARTY REP M4
SGT91G20 FIRE CONTROL REP M4
SGT91G20 FIRE CONTROL REP M4
SPC 91G10 FIRE CONTROL REP M4
SPC 91G10 FIRE CONTROL REP M4
SPC 91G10 FIRE CONTROL REP M4
SPC 91G10 FIRE CONTROL REP M4
SPC 91G10 FIRE CONTROL REP M4
PFC 91G10 FIRE CONTROL REP M4
PFC 91G10 FIRE CONTROL REP M4
PFC 91G10 FIRE CONTROL REP M240
PFC 91F10 SMALL ARMS/ARTY REP M4

EQUIPMENT SUMMARY

WEAPONS

L69080	LAUNCHER GRENADE: M320A1	4
M09009	MACHINE GUN 5.56 MILLIMETER: M249	8
M39263	MACHINE GUN: LIGHT 5.56MM M249	4
M92362	MACHINE GUN GRENADE 40MM: MK19 MOD III	1
M92841	MACHINE GUN: 7.62MM M240B	5
P98152	PISTOL 9MM AUTOMATIC: M9	1
R97234	RIFLE 5 56 MILLIMETER: M4	80
Z00686	MACHINE GUN: CALIBER .50	5

VEHICLES, TRAILERS AND TRLR MTD SYSTEMS

G34805	DOLLY SET LIFT TRANSPORTABLE SHELTER: 2 1/2 TON	1
G53778	GENERATOR SET DIESEL ENGINE TM: PU-802	6
H01907	ELECTRONIC SHOP SHELTER MOUNTED AVIONICS: AN/ASM-146 LESS POWER	2
H01912	ELECTRONIC SHOP SHELTER MOUNTED AVIONICS: AN/ASM-147 LESS POWER	1
S01427	SHELTER: NONEXPANDABLE S250	3
S01495	SHELTER: NONEXPANDABLE S280	1
S25681	SHOP EQUIPMENT: CONTACT MAINTENANCE ORD/ENG TRUCK MOUNTING	3
S75175	SEMITRAILER VAN: SUPPLY 12 TON 4 WHEEL W/E	1
T15581	SHOP EQUIPMENT INSTRUMENT AND FIRE CONTROL REPAIR SHELTER MTD:	1
T37588	TRUCK UTILITY EXPANDED CAPACITY ENHANCED: M1152A1	8
T41135	TRUCK CARGO: MTV W/E W/W	1
T41271	TRUCK VAN: EXPANSIBLE MTV W/E M1087A1	1
T56383	TRUCK UTILITY EXPANDED CAPACITY ENHANCED 4X4: M1165A1	4
T60081	TRUCK CARGO: 4X4 LMTV W/E	1
T61239	TRUCK TRACTOR: MTV W/E	1
T61704	TRUCK CARGO: MTV LWB W/E	2
T61908	TRUCK CARGO: MTV W/E	11
T63093	TRUCK WRECKER: TACTICAL 8X8 HEAVY EXPANDED MOBILITY W/WINCH	2
T64244	TRUE RMS VOLTMETER: ME-545(J)G	1
T93484	TRUCK VAN: LMTV W/E	2
T94709	TRUCK WRECKER: MTV W/E W/W	2
T95555	TRAILER CARGO: MTV W/DROPSIDES M1095	7
T95924	TRAILER CARGO: HIGH MOBILITY 1-1/4 TON	1
T95992	LIGHT TACTICAL TRAILER: 3/4 TON	2
T96496	TRUCK CARGO: TACTICAL 8X8 HEAVY EXPANDED MOB W/LHS	1
T96564	TRAILER FLAT BED: M1082 TRLR CARGO LMTV W/DROPSIDES	1
W48391	SHOP EQUIPMENT: WELDING	1
Z01404	TRAILER-MTD: PU-2101/ 15 KW/ 50/60HZ/ M200A1	5
Z36683	TRAILER TANK WATER (CAMEL): 800 GAL 5 TON W/E	1

COMMUNICATIONS AND ELECTRONICS

C18278	COMPUTER SYSTEM: DIGITAL AN/UHQ-90(V)2	11
C18278	COMPUTER SYSTEM: DIGITAL AN/UHQ-90(V)2	2
C18378	COMPUTER SET: AN/UHQ-128(V)3	16
C19266	COUNTER ELECTRONIC DIGITAL READOUT: AN/USM-459	1
C78851	COMPUTER SYSTEM: DIGITAL AN/UHQ-90(V)3	2
J54771	INTERCONNECT GROUP: ON-721/V	1
N96248	NAVIGATION SET: SATELLITE SIGNALS AN/PSN-13	16
P99881	PROCESSOR GROUP SIG DATA: (CAISI 2.0) OL-701A/TYQ	3
R36178	RADIO TEST: SET AN/GRM-122	1
R44999	RADIO SET: AN/VRC-89F(C)	1
R45543	RADIO SET: AN/VRC-92F(C)	3
R68044	RADIO SET: AN/VRC-90F(C)	32
Z00384	COMPUTER SYSTEM DIGITAL: AN/PYQ-10(C)	21
Z01162	COMPUTER SYSTEM: DIGITAL AN/TYQ-139	4
Z01163	COMPUTER SYSTEM: DIGITAL AN/TYQ-140	1

MISC EQUIPMENT

C05701	MONITOR CHEMICAL AGENT:	1
G18358	GEN SET: DED SKID MTD 3KW 60HZ	4
G40175	GENERATOR SWEEP: SG-1206/U	1
G74711	GEN SET: DED SKID MTD 10KW 60HZ	1
J00697	JOINT CHMCL AGENT: DETECTOR	2
M12986	MASK CHEMCL BIOLOGICL JOINT SERVICE GENERAL PURPOSE: FIELD M50	88
R20684	RADIAC SET: AN/VDR-2	2
R31061	RADIAC SET: AN/UDR-13	6
T65312	SATS FIELD MAINTENANCE MODULE 1:	1

NIGHT VISION/OBSERVATION

N05482	NIGHT VISION: GOGGLE	72
S90535	MEDIUM WEAPON THERMAL SIGHT (MWTS): AN/PAS-13(V)2	9
S90603	HEAVY WEAPON THERMAL SIGHT (HWTS): AN/PAS-13(V)3	6

FORWARD SUPPORT COMPANY

(BEB), BSB, ABCT

63037R000
4/2/100//106

COMPANY HEADQUARTERS PARA 01

FIELD FEEDING SECTION PARA 02

DISTRIBUTION PLT HQ PARA 03

MISSION: To provide field maintenance including communication equipment and COMSEC equipment, field feeding, transportation and supply support to the Brigade Engineer Battalion.

FBCB2
x2 NVG
DAGR
AN/MRC-149
AN/VRC-92F
AN/UHQ-90(V)2
AN/UHQ-128(V)3



CPT 90A00 CDR M4 M9
SPC 92Y10 SUPPLY SP M4

ON-721/V
AN/UHQ-90(V)3
AN/VRC-90F

DAGR
X3 NVG
AN/GYK-61 (BCS3)
AN/VRC-90F
AN/TYQ-109(V)1
OL-701A/TYQ



1LT 88A00 EXEC OFF M4



1SG 91Z5M 1SG M4
SSG 92Y30 SUPPLY SGT M4

AN/VRC-90F



x3

ASSAULT
KITCHEN
AK

DAGR
AN/VRC-90F

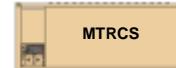

NOTE: Lift for MTRCS provided by Distr Sec

AN/VRC-90F



SFC 92G40 CULINARY MGMT NCO M4
X2 SSG 92G30 ADV CULINARY NCO M4

X2 SGT 92G20 CULINARY NCO M4

PC 92G10 FOOD OPS SP M4
X6 SPC 92G10 FOOD OPS SP M4

X2 PFC 92G10 FOOD OPS SP M4
X2 PFC 92G10 FOOD OPS SP M4

FBCB2
X2 NVG
DAGR

AN/VRC-92(V)2
AN/UHQ-90(V)3
AN/TYQ-129(V)2



PU - 798

1LT 92A00 PLT LDR M4
SFC 88M40 PLT SGT M4

DISTRIBUTION SECTION PARA 04

MAINTENANCE PLT HQ PARA 05

MAINTENANCE CONTROL SECTION PARA 06

M240B
2X NVG
DAGR
AN/VRC-90F
MWTS

M240B
2X NVG
DAGR
AN/VRC-90F
MWTS



x3



x3



x2 NVG
DAGR
AN/VRC-90F
AN/UHQ-128(V)3



1LT 91A00 PLT LEADER M4
SFC 91X40 PLT SGT M4

SSG 88M30 SECTION SGT M4
SGT 89B20 AMMO SGT M4
SGT 88M20 HVY VEH DRIVER M4
X2 SGT 92F20 PETRL HVY VEH OPR M4

SPC 88M10 HVY VEH DRIVER M4
SPC 88M10 HVY VEH DRIVER M249
X4 SPC 92F10 PETRL HVY VEH OPR M4
PFC 88M10 HVY VEH DRIVER M4

x2 NVG
DAGR
AN/VRC-90F
AN/UHQ-128(V)3



1LT 91A00 MAINT CONT OFF M4
SSG 88M30 MASTER DRVR TRNR M4

x2 NVG
DAGR
AN/VRC-90F
KOI-18/TSEC



PU-802

CW3 919A0 ENGR EQ MAINT WO M4
SPC 92A10 EQ REC/PARTS SP M4
PFC 92A10 EQ REC/PARTS SP M4

AN/TYQ-140
x2 NVG
DAGR
OL-701A/TYQ
AN/VRC-89F
OL-713(V)1
x2 AN/TYQ-139



SFC 91X40 MAINT CTRL SGT M4
SGT 92A20 EQ REC/PARTS SGT M4
PFC 92A10 EQ REC/PARTS SP M249

FORWARD SUPPORT COMPANY (BEB), BSB, ABCT

FIELD MAINTENANCE SECTION PARA 07

x2 NVG
DAGR
AN/VRC-90F
AN/UJK-128(V)3



x2 NVG
AN/VRC-90F
HWTS
.50 CAL



x2 NVG
DAGR
AN/VRC-90F



X2

x2 NVG
AN/VRC-90F



x2 NVG
AN/VRC-90F



x2 NVG
DAGR
AN/VRC-90F
AN/UJK-128(V)3



PU - 802

SFC 91X40 SECTION SGT M4
X2 SSG 91B30 SR MECH M4
SSG 91C30 SR UTIL EQ REP M4
SSG 91D30 SR PWR GEN EQ REP M4
SGT 91B20 WH VEH MECH M4
X2 SGT 91B20 WH VEH MECH M249
X2 SGT 91B20 WH VEH MECH M4
SGT 91B20 WH VEH MECH M4
SGT 91B20 WH VEH MECH M4
SGT 91C20 UTIL EQ REP M4

X2 SGT 91D20 PWR GEN REP M4
SGT 91F20 SML ARMS/ARTY REP M4
SGT 91H20 TRACK VEH MECH M4
SGT 91S20 STRYKER SYS MAINT M4
SGT 94F20 COMP/DET SYS REPAIRER M4

SPC 91B10 WH VEH MECH M4
X2 SPC 91B10 WH VEH MECH M4
X2 SPC 91B10 WH VEH MECH M4
SPC 91B10 WH VEH MECH M4
SPC 91B10 WH VEH MECH M4
SPC 91C10 UTIL EQ REP M4
X2 SPC 91D10 PWR-GEN EQ REP M4
SPC 91F10 SMALL ARMS/ARTY REP M4
SPC 91H10 TRACK VEH MECH M4
SPC 91J10 QM/CHEM EQ REP M4
SPC 91K10 ARMAMENT REP M4
SPC 91M10 BFVS MAINT M4
SPC 94E10 COMSEC/RADIO REP M4
SPC 94F10 COMP/DET SYS REP M4

PFC 91B10 WH VEH MECH M249
X5 PFC 91B10 WH VEH MECH M4
X2 PFC 91B10 WH VEH MECH M4
X2 PFC 91C10 UTILITIES REP M4
X3 PFC 91D10 PWR/GEN MECH M4
X2 PFC 91F10 SMALL ARMS/ARTY REP M4
PFC 91H10 TRACK VEH MECH M4
PFC 91M10 BFVS MAINT M4

SERVICE/RECOVERY SECTION PARA 08 FLD MAINT TM CBT EN CO PARA 09

x2 NVG DAGR
AN/VRC-90F
AN/UJK-128(V)3



SGT 91M20 RECOV VEH OPR M4
SPC 91M10 RECOV VEH OPR M4
SPC 91B10 RECOV VEH OPR M4

FBCB2 DAGR
2X NVG
AN/VRC-90F



SGT 91E20 ALLIED TRADES SP M4
PFC 91E10 ALLIED TRADES SP M4

x2 NVG DA
AN/VRC-90F
HWTS



SSG 91B30 RECOV VEH SUPV M4
SGT 91B20 RECOV VEH OPR M4

X2

x2 NVG DAGR
AN/VRC-90F
AN/UJK-128(V)3



x2 NVG DAGR
AN/VRC-90F
AN/UJK-128(V)3



FBCB2 DAGR
2X NVG
AN/VRC-90F



FBCB2 DAGR
2X NVG
AN/VRC-90F



SFC 91M40 BFVS SUPV M4
SSG 91M30 SR BFVS MAINT M4
SGT 91B20 WH VEH MECH M4
SGT 91L20 CONST EQ REP M4
SGT 91M20 RECOV VEH OPR M4
SGT 91M20 BFVS MAINT M4
SPC 91A10 ABRAMS TK SYS MAINT M4
SPC 91B10 WH VEH MECH M4
SPC 91M10 RECOV VEH OPR M4
SPC 91L10 CONST EQ REP M4
SPC 91M10 BFVS MAINT M4
SPC 92A EQ REC/PARTS SPC M4
PFC 91A10 ABRAMS TANK SYS MAINT M4
PFC 91L10 CONST EQ REP M4
PFC 91M10 BFVS MAINT M4

FLD MAINT TM CBT EN CO (W/CLEAR PLT) PARA 10

x2 NVG DAGR
AN/VRC-90F
AN/UJK-128(V)3



x2 NVG DAGR
AN/VRC-90F
AN/UJK-128(V)3



FBCB2 DAGR
2X NVG
AN/VRC-90F



FBCB2 DAGR
2X NVG
AN/VRC-90F



SFC 91X40 MOTOR SGT M4
SSG 91B30 SR MECH M4
SGT 91B20 REC VEH OPR M4
SGT 91B20 WH VEH MECH M4
SGT 91L20 CONST EQ REP M4
SGT 91B20 REC VEH OPR M4
SGT 91M20 BFVS MAINT M4
SPC 91A10 ABRAMS TK SYS MAINT M4
SPC 91B10 WH VEH MECH M4
SPC 91B10 REC VEH OPR M4
SPC 91L10 CONST EQUIP REP M4
SPC 91M10 BFVS MAINT M4
SPC 92A EQ REC/PARTS SPC M4
PFC 91A10 ABRAMS TK SYS MAINT M4
X2 PFC 91B10 WH VEH MECH M4
PFC 91L10 CONST EQUIP REP M4
PFC 91M10 BFVS MAINT M4

WEAPONS

LAUNCHER GRENADE: M3	4
MACHINE GUN 5.56MM M249	9
MACHINE GUN LIGHT 5.56MM M249	4
MACHINE GUN: CALIBER .50 (M2E2)	8
MACHINE GUN 7.62MM M240B	7
PISTOL 9MM AUTOMATIC M9	1
RIFLE 5.56MM M4 CARBINE	83

VEHICLES, TRAILERS, AND TRLR MTD SYSTEMS

CONTAINERIZED KITCHEN (CK)	1
FORWARD REPAIR SYSTEM: M7 (FRS)	1
GEN SET DED TM: 10KW 60HZ (PU-798)	1
GEN SET DED TM: 5KW 60HZ (PU-797)	1
GEN SET DIESEL ENGINE TM: 15KW 50/60HZ (PU-802)	2
SHOP EQUIPMENT: AUTOMOTIVE VEHICLE (TLR MTD) (SATS)	1
TRUCK LIFT FORK: DSL DRVN 4000LB CAP ROUGH TERR	1
TRUCK UTILITY EXP CAPACITY ENH 4X4: M1152A1	8
TRUCK VAN EXPANSIBLE MTV (M1087A1)	1
TRUCK UTILITY EXP CAPACITY ENH 4X4: M1165A1	3
TRUCK VAN LMTV (M1079)	1
TRUCK CARGO: MTV (M1083)	9
TRUCK CARGO: 4X4 LMTV (M1078)	2
TRUCK CARGO MTV LWB (M1085)	1
TRUCK WRECKER: TACTICAL 8X8 HEMTT (M984A1)	1
TRAILER: PLS 8X20 (M1076)	1
TRUCK WRECKER: MTV (M1089)	2
TRAILER CARGO: MTV W/ DROPSIDES (M1095)	8
LIGHT TACTICAL TRAILER: 3/4T (M1101)	4
TRUCK CARGO HEMTT LHS (M1120)	2
SHOP EQUIPMENT: WELDING TRAILER MTD	1
TRAILER TANK WATER (CAMEL) 800 GAL 5 TON	2
M88A2 IRV (HERCULES)	1

EQUIPMENT SUMMARY

COMMUNICATION-ELECTRONICS EQUIPMENT

ANTENNA GROUP: OE-254	4
COMPUTER SYSTEM DIGITAL: AN/UJK-90(V)2 (MTS)	32
COMP SET DIGITAL: AN/UJK-128(V)3 (FBCB2 BFT APPLIQUE)	5
BTL CMD SUSTAINMENT SPT SYSTEM: AN/GYK-61 (BCS3)	1
COMPUTER SYS DIGITAL: AN/TYQ-129(V)2 (TC-AIMS II WS)	1
COMPUTER SET DIGITAL: AN/TYQ-109(V)1 (GCSS-A (V1))	1
COMPUTER SYSTEM: DIGITAL AN/TYQ-139 (SAMS-1E V1)	3
COMPUTER SYSTEM: DIGITAL AN/TYQ-140 (SAMS/SAMS-1E V2)	1
COMPUTER SYSTEM DIGITAL: AN/UJK-90(V)3 (MTS-CS)	2
INTERCONNECTING GROUP: ON-721/V	1
TERM SAT COMMS: AN/TSC-183: (OL-713(V)1/TYQ CSS VSAT)	1
NAVIGATION SET: SATELLITE SIGNALS AN/PSN-13 (DAGR)	21
PROCESSOR GROUP SIGNAL DATA: (CAISI 2.0) OL-701A/TYQ	2
RADIAC SET: AN/VDR-2	3
RADIO SET: AN/VRC-89F	1
RADIO SET: AN/VRC-90F	50
RADIO SET: AN/VRC-92F	3
COMMS SYSTEM AN/MRC-149 (SOLDIER NETWORK EXTENSION)	1

NIGHT VISION/OBSERVATION EQUIPMENT

DRIVERS VISION ENHANCER: AN/VAS-5	12
NIGHT VISION GOGGLES: AN/PVS-7B	92
MEDIUM THERMAL WEAPONS SIGHT: AN/PAS-13(V2)	14
HEAVY THERMAL WEAPONS SIGHT: AN/PAS-13(V3)	12

MISCELLANEOUS EQUIPMENT

ASSAULT KITCHEN (AK)	4
BED CARGO: DEMOUNTABLE PLS 8X20	1
GEN SET: DED SKID MTD 3KW 60HZ (MEP-831A)	3
GEN SET DIESEL: 60HZ AC MEP-531A	1
GEN SET: DED SKID MTD 10KW 60HZ (MEP-803A)	2
ELECTRONICS SHOP SHEL MTD AVIONICS: AN/ASM-146	1
MULTI-TEMP REFRIGERATED CONTAINER SYS: MTRCS	1
SHOP EQUIP: CONTACT MAINT ORD/ENGR TRK MTD	3

FORWARD SUPPORT COMPANY, (CAV), BSB, ABCT

63327R100
5/1/123//129

COMPANY HEADQUARTERS PARA 01

FIELD FEEDING SECTION PARA 02

DISTRIBUTION PLT HQ PARA 03

MISSION: To provide Field Maintenance, transportation and supply support to the Cavalry Squadron in the ABCT.

AN/UYQ-90(V)2
FBCB2
2X NVG
DAGR
AN/VRC-92F

AN/UYQ-90(V)3
KG-175
OM-721/V
2X M240
2X MWTS
KOI-18/TSEC



2X NVG
DAGR
AN/VRC-90F

AN/GYK-61
AN/TYQ-109(V)1
OL-701A/TYQ



CPT 90A00 CDR M4 M9
1LT 88A00 XO M4
1SG 91Z5M 1SG M4
SPC 92Y10 SUPPLY SP M4
SSG 92Y30 SUPPLY SGT M4

2X NVG
AN/VRC-90F



2X NVG
AN/VRC-90F



2X NVG
AN/VRC-90F



2X NVG
DAGR
AN/VC-90F



x3

SFC 92G40 SR FOOD OPS SGT M4
SSG 92G30 FOOD OPS SGT M4
SSG 92G30 FOOD OPS SGT M4
SPC 92G10 FOOD OPS SP M4
SPC 92G10 FOOD OPS SP M4
SPC 92G10 FOOD OPS SP M4
SPC 92G10 FOOD OPS SP M4
SPC 92G10 FOOD OPS SP M4
SPC 92G10 FOOD OPS SP M4
PFC 92G10 FOOD OPS SP M4
PFC 92G10 FOOD OPS SP M4
SGT 92G20 FOOD OPS SGT M4
SGT 92G20 FOOD OPS SGT M4
SGT 92G20 FOOD OPS SGT M4
PFC 92G10 FOOD OPS SP M4
PFC 92G10 FOOD OPS SP M4

FBCB2
2X NVG
DAGR
AN/VRC-92(V)2
AN/UYQ-90(V)3
AN/TYQ-129(V)2



1LT 92A00 PLT LDR M4
SFC 88M40 PLT SGT M4
SPC 92A10 MAT CON/ACCTG SP M4

CLASS III SECTION PARA 04

2X NVG
DAGR
AN/VRC-90F



M240B
2X NVG
DAGR
AN/VRC-90F
MWTS



x3

MOVED TO EAB

SSG 92F30 SECTION CHIEF M4
x9 SGT 92F20 PETRL HVY VEH OPR M4
x12 SPC 92F10 PETRL HVY VEH OPR M4
x2 SPC 92F10 PETRL HVY VEH OPR SAW

GENERAL SUPPLY SECTION PARA 05

2X NVG
DAGR
AN/VRC-90F
AN/UYQ-90(V)2



x2

X2 NVG
DAGR
AN/VRC-90F
AN/UYQ-90(V);



x3

SSG 88M30 SQUAD LEADER M4
SSG 88M30 HEAVY VEH DRIVER M4
x4 SGT 88M20 HVY VEH DRIVER M4
x4 SPC 88M10 HVY VEH DRIVER M4
SPC 88M10 VEH DRIVER M249
X3 PFC 88M10 HVY VEH DRIVER M4

CLASS V SECTION PARA 06

X2 NVG
DAGR
AN/VRC-90F
AN/UYQ-90(V)2



x2

X2 NVG
DAGR
AN/VRC-90F
AN/UYQ-90(V)2



x3

SSG 88M30 SQUAD LEADER M4
SSG 88M30 HEAVY VEH DRIVER M4
x4 SGT 88M20 HVY VEH DRIVER M4
x5 SPC 88M10 HVY VEH DRIVER M4
PFC 88M10 HVY VEH DRIVER M249
X2 PFC 88M10 HVY VEH DRIVER M4

MAINT PLT HQ PARA 07

FBCB2
x2 NVG
DAGR
AN/VRC-92F



1LT 91A00 PLT LDR M4
SFC 91X40 PLT SGT M4

FORWARD SUPPORT COMPANY, (CAV), BSB, ABCT

MAINTENANCE CONTROL SECTION PARA 08

AN/TYQ-140
x2 NVG
DAGR
OL-701A/TYQ
AN/VRC-89F
OL-713(V)1
x2 AN/TYQ-139



KOI-18/TSEC
x2 NVG
DAGR
AN/VRC-90F



PU-802

x2 NVG
DAGR
AN/VRC-90F



1LT 91A00 MAINT CONT OFF M4
CW2 915A0 AUTO MAINT WO M4
SFC MAINT MGT NCO M4
SGT 92A20 EQUIP PARTS SGT M4
SPC 92A10 EQUIP PARTS SP M4
PFC 92A10 EQUIP PARTS SP M4
PFC 92A10 EQUIP PARTS SP M4

FIELD MAINTENANCE SECTION PARA 09

2X NVG
DAGR
AN/VRC-90F



2X NVG
DAGR
AN/VRC-90F



2X NVG
DAGR
AN/VRC-90F



2X NVG
DAGR
AN/VRC-90F



2X NVG
DAGR
AN/VRC-90F KOI-18/TSEC



2X NVG
DAGR
AN/VRC-90F



AN/ASM-146



PU-2101

2X NVG
DAGR
HWTS
AN/VRC-90F



SPC 94F10 COMP/DET SYS REP M4
PFC 91J10 QM/CHEM REP M4
SGT 91J20 QM/CHEM REP M4
PFC 91F10 SMALL ARMS/ARTY REP M4
SGT 91F20 SMALL ARMS/ARTY REP M4
SPC 91B10 WHL VEH MECH M4
SPC 91J10 QM/CHEM REP M4
PFC 94E10 COMSEC/RADIO REP M4

SFC 91X40 MOTOR SGT M4
SGT 91D20 PWR GEN EQUIP REP M4
SGT 91B20 WHL VEH MECH M4
SGT 91B20 WHL VEH MECH M4
SGT 91B20 WHL VEH MECH M4
SPC 91C10 UTILITIES EQUIP REP M4
SPC 91D10 PWR-GEN EQUIP REP M4
PFC 91B10 WHL VEH MECH M4
PFC 91B10 WHL VEH MECH M4
SPC 91L10 CONST EQUIP REP M4
PFC 91D10 PWR-GEN EQUIP REP M4
PFC 94E10 COMSEC/RDO REP M4
PFC 91B10 WHL VEH MECH M249
PFC 91B10 WHL VEH MECH M249
SPC 91F10 SMALL ARMS/ARTY REP M4
SPC 91B10 WHL VEH MECH M4
SPC 91B10 WHL VEH MECH M4
SPC 91B10 WHL VEH MECH M4
SSG 91B30 SR MECH M4

SERVICE/RECOVERY SECTION PARA 10

2X NVG
DAGR
AN/VRC-90F



SGT 91E20 ALLIED TRADES SPEC M4
PFC 91E10 ALLIED TRADES SPEC M249

2X NVG
DAGR
AN/VRC-90F
MWTS



SPC 91B10 RECOVERY VEH OPR M4
PFC 91B10 RECOVERY VEH OPR M4

2X NVG
DAGR
AN/VRC-90F
HWTS
.50 CAL



SGT 91B20 RECOVERY VEH OPR M4

2X NVG
DAGR
AN/VRC-90F
MWTS



SSG 91A30 RECOVERY VEH SUPV M4
X2 SGT 91A20 RECOVERY VEH OPR M4
X2 SPC 91M10 RECOVERY VEH OPR M4

FIELD MAINTENANCE TEAM (INF) PARA 11

2X NVG
DAGR
MWTS
AN/VRC-90F
AN/UYK-128(V)1



SFC 91M40 BFVS SUPV M4
SGT 91M20 BFVS MAINT M4
SGT 91B20 WH VEH MECH M4
SPC 91B10 WH VEH MECH M4

2X NVG
DAGR
MWTS
AN/VRC-90F
AN/TYQ-139



2X NVG
DAGR
AN/VRC-90F
AN/UYK-128(V)1



SPC 91M10 BFVS MAINT M4
PFC 91M10 BFVS MAINT M4
SPC 91H10 TRACK VEH MECH M4
SPC 92A10 EQ RCD/PARTS SP M249

2X NVG
DAGR
AN/VRC-90F
AN/UYK-128(V)1



SGT 91B20 RCYV VEH OPR M4
SPC 92A10 RCYV VEH OPR M4

EQUIPMENT SUMMARY

WEAPONS

L69080	LAUNCHER GRENADE: M320A1	4
M09009	MACHINE GUN 5.56 MILLIMETER: M249	9
M39263	MACHINE GUN: LIGHT 5.56MM M249	4
M92841	MACHINE GUN: 7.62MM M240B	9
P98152	PISTOL 9MM AUTOMATIC: M9	1
R97234	RIFLE 5 56 MILLIMETER: M4	76
Z00686	MACHINE GUN: CALIBER .50	6

VEHICLES, TRAILERS AND TRLR MTD SYSTEMS

A94943	ASSAULT KTCHN: (AK)	3
C27633	CONTAINERIZED KITCHEN: CK	1
F64544	FORWARD: REPAIR SYSTEM (FRS)	1
G53778	GENERATOR SET DIESEL ENGINE TM: PU-802	2
S25681	SHOP EQUIPMENT: CONTACT MAINTENANCE ORD/ENG TRUCK MOUNTING	3
T37588	TRUCK UTILITY EXPANDED CAPACITY ENHANCED: M1152A1	8
T41135	TRUCK CARGO: MTV W/E W/W	1
T41271	TRUCK VAN: EXPANSIBLE MTV W/E M1087A1	1
T49255	TRUCK LIFT FORK: DSL DRVN 4000 LB CAP ROUGH TERRAIN	1
T56383	TRUCK UTILITY EXPANDED CAPACITY ENHANCED 4X4: M1165A1	3
T60081	TRUCK CARGO: 4X4 LMTV W/E	2
T61704	TRUCK CARGO: MTV LWB W/E	1
T61908	TRUCK CARGO: MTV W/E	6
T63093	TRUCK WRECKER: TACTICAL 8X8 HEAVY EXPANDED MOBILITY W/WINCH	1
T93484	TRUCK VAN: LMTV W/E	1
T93761	TRAILER: PALLETIZED LOADING 8X20	8
T94709	TRUCK WRECKER: MTV W/E W/W	2
T95555	TRAILER CARGO: MTV W/DROPSIDES M1095	3
T95992	LIGHT TACTICAL TRAILER: 3/4 TON	4
T96496	TRUCK CARGO: TACTICAL 8X8 HEAVY EXPANDED MOB W/LHS	9
T96564	TRAILER FLAT BED: M1082 TRLR CARGO LMTV W/DROPSIDES	1
Z00206	MULTI-TEMPERATURE REFRIGERATED CONTAINER SYSTEM: MTRCS	1
Z00514	MODULAR FUEL SYSTEM - TANKRACK MODULE:	4
Z01404	TRAILER-MTD: PU-2101/ 15 KW/ 50/60HZ/ M200A1	2
Z01414	LTT TRAILER-MTD: PU-2002/ 10 KW/ 50/60HZ	1
Z01420	LTT TRAILER-MTD: PU-2001/ 5 KW/ 50/60HZ	1
Z36683	TRAILER TANK WATER (CAMEL): 800 GAL 5 TON W/E	2
	M88A2 IRV (HERCULES)	4

COMMUNICATIONS AND ELECTRONICS

C18278	COMPUTER SYSTEM: DIGITAL AN/UYQ-90(V)2	1
C18378	COMPUTER SET: AN/UYK-128(V)3	3
C18448	COMPUTER SYSTEM: DIGITAL AN/GYK-61	1
C27435	COMPUTER SYSTEM: DIGITAL AN/TYQ-129(V)2	1
C27707	COMPUTER SYSTEM: DIGITAL AN/TYQ-109(V)1	1
C78851	COMPUTER SYSTEM: DIGITAL AN/UYQ-90(V)3	3
J54771	INTERCONNECT GROUP: ON-721/V	1
N96248	NAVIGATION SET: SATELLITE SIGNALS AN/PSN-13	34
P99881	PROCESSOR GROUP SIG DATA: (CAISI 2.0) OL-701A/TYQ	2
R36178	RADIO TEST: SET AN/GRM-122	1
R44999	RADIO SET: AN/VRC-89F(C)	1
R45543	RADIO SET: AN/VRC-92F(C)	3
R68044	RADIO SET: AN/VRC-90F(C)	33
Z00384	COMPUTER SYSTEM DIGITAL: AN/PYQ-10(C)	29
Z00560	INTERFACE UNIT COMMUNICATION EQUIPMENT: OL-713(V)1/TYQ CSS VSAT	1
Z01162	COMPUTER SYSTEM: DIGITAL AN/TYQ-139	4
Z01163	COMPUTER SYSTEM: DIGITAL AN/TYQ-140	1

MISC EQUIPMENT

C05701	MONITOR CHEMICAL AGENT:	1
G18358	GEN SET: DED SKID MTD 3KW 60HZ	5
G36237	GENERATOR SET DIESEL: 60HZ AC MEP-531A	1
G74711	GEN SET: DED SKID MTD 10KW 60HZ	2
M12986	MASK CHEMICAL BIOLOGICAL JOINT SERVICE GENERAL PURPOSE: FIELD M50	85
R20684	RADIAC SET: AN/VDR-2	4
R30925	RADIAC SET: AN/PDR-75	1
R30993	RADIAC SET: AN/PDR-77()	1
R31061	RADIAC SET: AN/UDR-13	9
Z01330	GEN SET DED 10KW 50/60HZ: SKID-MTD	2
Z01404	TRAILER-MTD: PU-2101/ 15 KW/ 50/60HZ/ M200A1	2
Z01414	LTT TRAILER-MTD: PU-2002/ 10 KW/ 50/60HZ	1
Z01420	LTT TRAILER-MTD: PU-2001/ 5 KW/ 50/60HZ	1
	NIGHT VISION/OBSERVATION	
N05482	NIGHT VISION: GOGGLE	71
S90535	MEDIUM WEAPON THERMAL SIGHT (MWTS): AN/PAS-13(V)2	13
S90603	HEAVY WEAPON THERMAL SIGHT (HWTS): AN/PAS-13(V)3	6

FORWARD SUPPORT COMPANY, (CAB), BSB, ABCT

MISSION.

To provide field maintenance including communication equipment and COMSEC equipment, field feeding, transportation and supply support to the Combined Arms Battalions in the ABCT.

FORWARD SUPPORT COMPANY, (CAB), BSB, ABCT

63327R300
5/1/192//198

COMPANY HEADQUARTERS PARA 01

AN/UYQ-90(V)2
FBCB2
2X NVG
DAGR
AN/VRC-92F

AN/UYQ-90(V)3
KG-175
OM-721/V
2X M240
2X MWTS
KOI-18/TSEC



2X NVG
DAGR
AN/VRC-90F

AN/GYK-61
AN/TYQ-109(V)1
OL-701A/TYQ



CPT 90A00 CDR M4 M9
1LT 88A00 XO M4
1SG 91Z5M 1SG M4
SPC 92Y10 SUPPLY SP M4
SSG 92Y30 SUPPLY SGT M4

FIELD FEEDING SECTION PARA 02

2X NVG
AN/VRC-90F



2X NVG
AN/VRC-90F



2X NVG
AN/VRC-90F



2X NVG
DAGR
AN/VRC-90F

ASSAULT KITCHEN

AK

x4

SFC 92G40 SR FOOD OPS SGT M4
SSG 92G30 FOOD OPS SGT M4
SSG 92G30 FOOD OPS SGT M4
SPC 92G10 FOOD OPS SP M4
SPC 92G10 FOOD OPS SP M4
SPC 92G10 FOOD OPS SP M4
SPC 92G10 FOOD OPS SP M4
SPC 92G10 FOOD OPS SP M4
SPC 92G10 FOOD OPS SP M4
PFC 92G10 FOOD OPS SP M4
PFC 92G10 FOOD OPS SP M4
SGT 92G20 FOOD OPS SGT M4
SGT 92G20 FOOD OPS SGT M4
SGT 92G20 FOOD OPS SGT M4
SGT 92G20 FOOD OPS SGT M4
PFC 92G10 FOOD OPS SP M4
PFC 92G10 FOOD OPS SP M4

DISTRIBUTION PLT HQ PARA 03

FBCB2
2X NVG
DAGR
AN/VRC-92(V)2
AN/UYQ-90(V)3
AN/TYQ-129(V)2



1LT 92A00 PLT LDR M4
SFC 88M40 PLT SGT M4
SPC 92A10 MAT CON/ACCTG SP M4

CLASS III SECTION PARA 04

M240B
2X NVG
DAGR
AN/VRC-90F
MWTS



SGT 92F20 PETRL HVY VEH OPR M4
SPC 92F10 PETRL HVY VEH OPR M4

x2



x10

SSG 92F30 SECTION CHIEF M4
x7 SGT 92F20 PETRL HVY VEH OPR M4
x10 SPC 92F10 PETRL HVY VEH OPR M4
x2 SPC 92F10 PETRL HVY VEH OPR SAW



GENERAL SUPPLY SECTION PARA 05

2X NVG
DAGR
AN/VRC-90F
AN/UYQ-90(V)2



x2

X2 NVG
DAGR
AN/VRC-90F
AN/UYQ-90(V)2



x5

SSG 88M30 SQUAD LEADER M4
SSG 88M30 HEAVY VEH DRIVER M4
x4 SGT 88M20 HVY VEH DRIVER M4
x4 SPC 88M10 HVY VEH DRIVER M4
SPC 88M10 VEH DRIVER M249
X3 PFC 88M10 HVY VEH DRIVER M4

CLASS V SECTION PARA 06

X2 NVG
DAGR
AN/VRC-90F
AN/UYQ-90(V)2



x2

X2 NVG
DAGR
AN/VRC-90F
AN/UYQ-90(V)2



X2 NVG
DAGR
AN/VRC-90F
AN/UYQ-90(V)2



x4

SSG 88M30 SQUAD LEADER M4
SSG 88M30 HEAVY VEH DRIVER M4
x4 SGT 88M20 HVY VEH DRIVER M4
x5 SPC 88M10 HVY VEH DRIVER M4
PFC 88M10 HVY VEH DRIVER M249
X2 PFC 88M10 HVY VEH DRIVER M4

MAINTENANCE PLT HQ PARA 07

FBCB2
x2 NVG
DAGR
AN/VRC-92F



1LT 91A00 PLT LDR M4
SFC 91X40 PLT SGT M4

MAINTENANCE CONTROL SECTION PARA 08

AN/TYQ-140 KOI-18/TSEC
x2 NVG
DAGR
OL-701A/TYQ
AN/VRC-89F
OL-713(V)1
x2 AN/TYQ-139



x2 NVG
DAGR
AN/VRC-90F



1LT 91A00 MAINT CONT OFF M4
CW2 915A0 AUTO MAINT WO M4
SFC MAINT MGT NCO M4
SGT 92A20 EQUIP PARTS SGT M4
SPC 92A10 EQUIP PARTS SP M4
PFC 92A10 EQUIP PARTS SP M4
PFC 92A10 EQUIP PARTS SP M4

FORWARD SUPPORT COMPANY, (CAB), BSB, ABCT

FIELD MAINTENANCE SECTION PARA 09

2X NVG
DAGR
AN/VRC-90F



2X NVG
DAGR
AN/VRC-90F KOI-18/TSEC



x3

2X NVG
DAGR
HWTS
AN/VRC-90F



2X NVG
DAGR
AN/VRC-90F



2X NVG
DAGR
AN/VRC-90F



2X NVG
DAGR
AN/VRC-90F



AN/ASM-146

PU-802

x2

SPC 94F10 COMP/DET SYS REP M4
PFC 91J10 QM/CHEM REP M4
SGT 91J20 QM/CHEM REP M4
PFC 91F10 SMALL ARMS/ARTY REP M4
SGT 91F20 SMALL ARMS/ARTY REP M4
SPC 91B10 WHL VEH MECH M4
SPC 91J10 QM/CHEM REP M4
PFC 94E10 COMSEC/RADIO REP M4

2X NVG
DAGR
AN/VRC-90F



x2

SFC 91X40 MOTOR SGT M4
SGT 91D20 PWR GEN EQUIP REP M4
SGT 91B20 WHL VEH MECH M4
SGT 91B20 WHL VEH MECH M4
SGT 91B20 WHL VEH MECH M4
SPC 91C10 UTILITIES EQUIP REP M4
SPC 91D10 PWR-GEN EQUIP REP M4
PFC 91B10 WHL VEH MECH M4
PFC 91B10 WHL VEH MECH M4
SPC 91L10 CONST EQUIP REP M4
PFC 91D10 PWR-GEN EQUIP REP M4
PFC 94E10 COMSEC/RDO REP M4
PFC 91B10 WHL VEH MECH M249
PFC 91B10 WHL VEH MECH M249
SPC 91F10 SMALL ARMS/ARTY REP M4
SPC 91B10 WHL VEH MECH M4
SPC 91B10 WHL VEH MECH M4
SPC 91B10 WHL VEH MECH M4
SSG 91B30 SR MECH M4

SERVICE/RECOVERY SECTION PARA 10

2X NVG
DAGR
AN/VRC-90F



SGT 91E20 ALLIED TRADES SPEC M4
PFC 91E10 ALLIED TRADES SPEC M249

2X NVG
DAGR
AN/VRC-90F
HWTS
.50 CAL



SGT 91B20 RECOVERY VEH OPR M4

2X NVG
DAGR
AN/VRC-90F
MWTS



x2

X2 SGT 91M20 RECOVERY VEH OPR M4
X2 SPC 91A10 RECOVERY VEH OPR M4

2X NVG
DAGR
AN/VRC-90F
MWTS



x2

SPC 91B10 RECOVERY VEH OPR M4
PFC 91B10 RECOVERY VEH OPR M4

2X NVG
DAGR
AN/VRC-90F
MWTS



x2

SSG 91A30 RECOVERY VEH SUPV M4
X2 SGT 91A20 RECOVERY VEH OPR M4
X2 SPC 91M10 RECOVERY VEH OPR M4

FIELD MAINTENANCE TEAM (INF) PARA 11

2X NVG
DAGR
MWTS
AN/VRC-90F
AN/UJK-128(V)1



2X NVG
DAGR
AN/VRC-90F
AN/UJK-128(V)1



SGT 91B20 RCYV VEH OPR M4
SPC 92A10 RCYV VEH OPR M4

2X NVG
DAGR
MWTS
AN/VRC-90F
AN/TYQ-139



2X NVG
DAGR
AN/VRC-90F
AN/UJK-128(V)1



SFC 91M40 BFVS SUPV M4
SSG 91M30 SR BFVS MAINT M4
SGT 91M20 BFVS MAINT M4
SPC 91B10 WH VEH MECH M4

X2 SPC 91M10 BFVS MAINT M4
SPC 9192A10 EQ RCD/PART SP M4
PFC 91M10 BFVS MAINT M4
PFC 91M10 BFVS MAINT M249

x2

FIELD MAINTENANCE TEAM (ARMOR) PARA 12

M240B
2X NVG
DAGR
AN/VRC-90F
MWTS



2X NVG
DAGR
AN/VRC-90F



M240B
2X NVG
DAGR
AN/VRC-90F
MWTS



SGT 91B30 RCYV VEH SUPV M4
SPC 91B10 RCYV VEH OPR M4

M240B
2X NVG
DAGR
AN/VRC-90F
MWTS



x2

SGT 91A20 (RCYV VEH OPR) P
SFC 91A40 (ABRAMS TANK SYS SUPV) C
2 SGT 91A20 (SR ABRAMS TANK SYS MAINT) C
SP4 91K10 (ARMAMENT REP) C
PFC 91A10 (ABRAMS TANK SYS MAINT) C

SP4 91A10 (RCYV VEH OPR) P
SSG 91A30 (SR ABRAMS TANK SYS MAINT) C
2 SP4 91A10 (ABRAMS TANK SYS MAINT) C
SP4 92A10 (EQ RCD/PARTS SP) SAW
PFC 91A10 (ABRAMS TANK SYS MAINT) SAW

EQUIPMENT SUMMARY

WEAPONS

L69080	LAUNCHER GRENADE: M320A1	4
M09009	MACHINE GUN 5.56 MILLIMETER: M249	12
M39263	MACHINE GUN: LIGHT 5.56MM M249	4
M92362	MACHINE GUN GRENADE 40MM: MK19 MOD III	2
M92841	MACHINE GUN: 7.62MM M240B	10
P98152	PISTOL 9MM AUTOMATIC: M9	1
R97234	RIFLE 5 56 MILLIMETER: M4	102
Z00686	MACHINE GUN: CALIBER .50	8

VEHICLES, TRAILERS AND TRLR MTD SYSTEMS

A94943	ASSAULT KTCHN: (AK)	4
C27633	CONTAINERIZED KITCHEN: CK	1
F64544	FORWARD: REPAIR SYSTEM (FRS)	1
S25681	SHOP EQUIPMENT: CONTACT MAINTENANCE ORD/ENG TRUCK MOUNTING	2
T37588	TRUCK UTILITY EXPANDED CAPACITY ENHANCED: M1152A1	6
T41135	TRUCK CARGO: MTV W/E W/W	5
T41271	TRUCK VAN: EXPANSIBLE MTV W/E M1087A1	1
T49255	TRUCK LIFT FORK: DSL DRVN 4000 LB CAP ROUGH TERRAIN	1
T56383	TRUCK UTILITY EXPANDED CAPACITY ENHANCED 4X4: M1165A1	3
T60081	TRUCK CARGO: 4X4 LMTV W/E	13
T60149	TRUCK CARGO: 4X4 LMTV W/E W/W	2
T61704	TRUCK CARGO: MTV LWB W/E	2
T61908	TRUCK CARGO: MTV W/E	4
T63093	TRUCK WRECKER: TACTICAL 8X8 HEAVY EXPANDED MOBILITY W/WINCH	1
T93484	TRUCK VAN: LMTV W/E	1
T93761	TRAILER: PALLETIZED LOADING 8X20	4
T94709	TRUCK WRECKER: MTV W/E W/W	2
T95555	TRAILER CARGO: MTV W/DROPSIDES M1095	2
T95992	LIGHT TACTICAL TRAILER: 3/4 TON	5
T96496	TRUCK CARGO: TACTICAL 8X8 HEAVY EXPANDED MOB W/LHS	9
T96564	TRAILER FLAT BED: M1082 TRLR CARGO LMTV W/DROPSIDES	8
Z00206	MULTI-TEMPERATURE REFRIGERATED CONTAINER SYSTEM: MTRCS	1
Z00514	MODULAR FUEL SYSTEM - TANKRACK MODULE:	4
Z01404	TRAILER-MTD: PU-2101/ 15 KW/ 50/60HZ/ M200A1	3
Z01414	LTT TRAILER-MTD: PU-2002/ 10 KW/ 50/60HZ	1
Z01420	LTT TRAILER-MTD: PU-2001/ 5 KW/ 50/60HZ	1
Z36683	TRAILER TANK WATER (CAMEL): 800 GAL 5 TON W/E M88A2 IRV (HERCULES)	2
		6
	NIGHT VISION/OBSERVATION	
N05482	NIGHT VISION: GOGGLE	99
S90535	MEDIUM WEAPON THERMAL SIGHT (MWTS): AN/PAS-13(V)2	14
S90603	HEAVY WEAPON THERMAL SIGHT (HWTS): AN/PAS-13(V)3	10

COMMUNICATIONS AND ELECTRONICS

C18278	COMPUTER SYSTEM: DIGITAL AN/UHQ-90(V)2	14
C18378	COMPUTER SET: AN/UHQ-128(V)3	6
C18448	COMPUTER SYSTEM: DIGITAL AN/GYK-61	1
C27435	COMPUTER SYSTEM: DIGITAL AN/TYQ-129(V)2	1
C27707	COMPUTER SYSTEM: DIGITAL AN/TYQ-109(V)1	1
C67686	COMPUTE SYSTEM: DIGITAL AN/TYQ-140	1
C78851	COMPUTER SYSTEM: DIGITAL AN/UHQ-90(V)3	2
E08940	ENCRYPTION-DECRYPTION EQUIPMENT: TAFLANE KG 175	1
J54771	INTERCONNECT GROUP: ON-721/V	1
N96248	NAVIGATION SET: SATELLITE SIGNALS AN/PSN-13	33
P99881	PROCESSOR GROUP SIG DATA: (CAISI 2.0) OL-701A/TYQ	2
R36178	RADIO TEST: SET AN/GRM-122	1
R44999	RADIO SET: AN/VRC-89F(C)	1
R45543	RADIO SET: AN/VRC-92F(C)	3
R68044	RADIO SET: AN/VRC-90F(C)	45
T40405	TAPE READER GENERAL PURPOSE: KOI-18/TSEC	2
Z00384	COMPUTER SYSTEM DIGITAL: AN/PYQ-10(C)	41
Z00560	INTERFACE UNIT COMMUNICATION EQUIPMENT: OL-713(V)1/TYQ CSS VSAT	1
Z01162	COMPUTER SYSTEM: DIGITAL AN/TYQ-139	3

MISC EQUIPMENT

C05701	MONITOR CHEMICAL AGENT:	2
D03932	DETECTING SET: MINE AN/PSS-14	2
G18358	GEN SET: DED SKID MTD 3KW 60HZ	1
G36237	GENERATOR SET DIESEL: 60HZ AC MEP-531A	1
G74711	GEN SET: DED SKID MTD 10KW 60HZ	2
J00697	JOINT CHMCL AGENT: DETECTOR	3
M12986	MASK CHEMICAL BIOLOGICAL JOINT SERVICE GENERAL PURPOSE: FIELD M50	114
N96248	NAVIGATION SET: SATELLITE SIGNALS AN/PSN-13	33
R20684	RADIAC SET: AN/VDR-2	3
R30925	RADIAC SET: AN/PDR-75	1
R30993	RADIAC SET: AN/PDR-77()	1
R31061	RADIAC SET: AN/UDR-13	8
T40405	TAPE READER GENERAL PURPOSE: KOI-18/TSEC	2
W48391	SHOP EQUIPMENT: WELDING	1
Z01330	GEN SET DED 10KW 50/60HZ: SKID-MTD	1

FORWARD SUPPORT COMPANY, (FA), BSB, ABCT

MISSION.

**To provide field maintenance (ground)
and supply support
to the Fires Battalion in the ABCT.**

FORWARD SUPPORT COMPANY, (FA), BSB, ABCT

63327R600
5/1/123//129

COMPANY HEADQUARTERS PARA 01

AN/UYQ-90(V)2
FBCB2
2X NVG
DAGR
AN/VRC-92F
HWTS
.50 CAL

2X NVG
DAGR
AN/VRC-90F
HWTS
.50 CAL

AN/TYQ-109(V)1



AN/GYK-61
AN/UYQ-90(V)3
ON-721/V
OL-701Z/TYQ

CPT 90A00 CDR M4 M9
1LT 88A00 XO M4
1SG 91Z5M 1SG M4
SGT 92Y20 SUPPLY NCO M4
SPC 92Y10 SUPPLY SP M4



FIELD FEEDING SECTION PARA 02

2X NVG
DAGR
AN/VRC-90F



2X NVG
AN/VRC-90F



2X NVG
AN/VRC-90F



2X NVG
DAGR
AN/VRC-90F

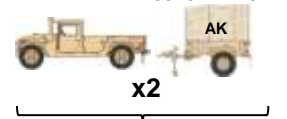

x2

SFC 92G40 SR FOOD OPNS SGT M4
SSG 92G30 FOOD OPNS SGT M4
SGT 92G20 FOOD OPNS SGT M4
SGT 92G20 FOOD OPNS SGT M4
SPC 92G10 FOOD OPS SP M4
SPC 92G10 FOOD OPS SP M4
SPC 92G10 FOOD OPS SP M4
SPC 92G10 FOOD OPS SP M4
SPC 92G10 FOOD OPS SP M4
PFC 92G10 FOOD OPS SP M249
PFC 92G10 FOOD OPS SP M249
PFC 92G10 FOOD OPS SP M249
SPC 92G10 FOOD OPS SP M4

DISTRIBUTION PLT HQ PARA 03

FBCB2
AN/UYQ-90(V)3
2X NVG
DAGR
AN/VRC-92(V)2

AN/TYQ-129(V)2



1LT 92A00 PLT LDR M4
SFC 88M40 PLT SGT M4
SPC 92A10 MAT CON/ACCTG SP M4

CLASS III SECTION PARA 04

2X NVG
DAGR
AN/VRC-90F
AN/UYQ-90(V)2
MWTS



x3

M240B
2X NVG
DAGR
AN/VRC-90F
AN/UYQ-90(V)2
MWTS



MOVED TO EAB

SSG 92F30 SECTION CHIEF M4
x3 SGT 92F20 PETRL HVY VEH OPR M4
x5 SPC 92F10 PETRL HVY VEH OPR M4
SPC 92F10 PETRL HVY VEH OPR SAW

GENERAL SUPPLY SECTION PARA 05

2X NVG
DAGR
AN/UYQ-90(V)2



x2



2X NVG
DAGR
AN/UYQ-90(V)2



x2

SSG 88M30 SQUAD LEADER M4
x2 SGT 88M20 HVY VEH DRIVER M4
x3 SPC 88M10 HVY VEH DRIVER M4
PFC 88M10 VEH DRIVER M249
PFC 88M10 HVY VEH DRIVER M4

CLASS V SECTION PARA 06

2X NVG
DAGR
AN/VRC-90F
AN/UYQ-90(V)2



x2

2X NVG
DAGR
AN/VRC-90F
AN/UYQ-90(V)2



x8

SSG 88M30 SECTION SGT M4
SPC 88M10 HVY VEH DRIVER M4
SPC 88M10 HVY VEH DRIVER M4
SPC 88M10 HVY VEH DRIVER M4
SPC 88M10 HVY VEH DRIVER M249
PFC 88M10 VEH DRIVER M4
PFC 88M10 VEH DRIVER M4
PFC 88M10 VEH DRIVER M4
PFC 88M10 VEH DRIVER M4

MAINTENANCE PLT HQ PARA 07

FBCB2
x2 NVG
DAGR
AN/VRC-92F



1LT 91A00 PLT LDR M4
SFC 91X40 PLT SGT M4

FORWARD SUPPORT COMPANY, (FA), BSB, ABCT

MAINTENANCE CONTROL SECTION PARA 08

x2 NVG
DAGR
AN/VRC-90F



x2 NVG
DAGR
AN/VRC-90F



AN/TYQ-140
x2 NVG
DAGR
OL-701A/TYQ
AN/VRC-89F
OL-713(V)1
x2 AN/TYQ

KOI-18/TSEC



1LT 91A00 MAINT CONT OFF M4
SFC MAINT MGT NCO M4
PFC 92A10 EQUIP PARTS SP M4



CW2 915A0 AUTO MAINT WO M4
SGT 92A20 EQUIP PARTS SGT M4
SPC 92A10 EQUIP PARTS SP M4
PFC 92A10 EQUIP PARTS SP M4

PU-802

FIELD MAINTENANCE SECTION PARA 09

2X NVG
DAGR
AN/VRC-90F



2X NVG
DAGR
AN/VRC-90F



2X NVG
DAGR
AN/VRC-90F



SP4 91J10 (QM & CHEM EQ REP) M4
SP4 91K10 (ARMAMENT REP) M4
SP4 94E10 (COMSEC/RADIO EQ REP) M4
SP4 94F10 (COMP/DET SYS REP) M4
X3 PFC 91B10 (WH VEH MECH) M4
PFC 91B10 (WH VEH MECH) M4
PFC 91D10 (PWR-GEN EQ REP) C
PFC 91D10 (PWR-GEN EQ REP) SAW
PFC 91F10 (SM ARMS/ARTY REP) M4
PFC 91H10 (TRACK VEH MECH) SAW

2X NVG
DAGR
AN/VRC-90F



2X NVG
DAGR
AN/VRC-90F



AN/ASM-146

PU-2101

HWTS

2X NVG
DAGR
AN/VRC-90F



x2

SFC 91X40 (MOTOR SGT) M4
SSG 91B30 (SR MECHANIC) M4
SSG 91D30 (SR PWR-GEN EQ REP) M4
X3 SGT 91B20 (WH VEH MECH) M4
SGT 91D20 (PWR-GEN EQ REP) M4
SGT 91H20 (TRACK VEH MECH) M4
X2 SP4 91B10 (WH VEH MECH) M4
SP4 91B10 (WH VEH MECH) SAW
SP4 91C10 (UTIL EQ REP) M4
X2 SP4 91D10 (PWR-GEN EQ REP) M4
SP4 91F10 (SM ARMS/ARTY REP) M4

SERVICE/RECOVERY SECTION PARA 10

2X NVG
DAGR
AN/VRC-90F



SGT 91E20 ALLIED TRADES SPEC M4
PFC 91E10 ALLIED TRADES SPEC M249

2X NVG
DAGR
AN/VRC-90F
MWTS
M240B



SPC 91B10 RECOVERY
VEH OPR M4

2X NVG
DAGR
AN/VRC-90F
HWTS
.50 CAL



SGT 91B20 RECOVERY
VEH OPR M4

M240B
2X NVG
DAGR
AN/VRC-90F
MWTS



SSG 91B30 RECOVERY VEH SUPV M4
SGT 91B20 RECOVERY VEH OPR M4
SPC 91B10 RECOVERY VEH OPR M4

FIELD MAINTENANCE TEAM (INF) PARA 11

M240B
2X NVG
DAGR
AN/VRC-90F
AN/TYQ-139
MWTS



2X NVG
DAGR
AN/VRC-90F



SGT 91P20 RCVY VEH OPR M4
SPC 91P10 RCVY VEH OPR M4

2X NVG
DAGR
AN/VRC-90F



2X NVG
DAGR
AN/VRC-90F



SFC 91P40 ARTY MECH SUPV M4
SSG 91P30 SR ARTY MAINT M4
SGT 91B20 WH VEH MECH M4
SGT 91P20 ARTY MECH M4
SPC 91B10 WH VEH MECH M4

x2

M240B
2X NVG
DAGR
AN/VRC-90F
MWTS



SPC 91H10 TRAC VEH MECH M4
X2 SPC 91P10 ARTY MECH M4
SPC 92A10 EQ RCD/PARTS SP M4
PFC 91P10 ARTY MECH M249

RADAR REPAIR TEAM PARA 12

AN/VRC-90F



SSG 94M20 RADAR REP M4
SPC 91D10 PWR GEN EQ REP M4
SPC 91M10 RADAR REP M4

EQUIPMENT SUMMARY

WEAPONS

L69080	LAUNCHER GRENADE: M320A1	4
M09009	MACHINE GUN 5.56 MILLIMETER: M249	9
M39263	MACHINE GUN: LIGHT 5.56MM M249	4
M92841	MACHINE GUN: 7.62MM M240B	7
P98152	PISTOL 9MM AUTOMATIC: M9	1
R97234	RIFLE 5 56 MILLIMETER: M4	77
Z00686	MACHINE GUN: CALIBER .50	5

VEHICLES, TRAILERS AND TRLR MTD SYSTEMS

A94943	ASSAULT KTCHN: (AK)	2
C27633	CONTAINERIZED KITCHEN: CK	1
F64544	FORWARD: REPAIR SYSTEM (FRS)	1
G53778	GENERATOR SET DIESEL ENGINE TM: PU-802	3
S25681	SHOP EQUIPMENT: CONTACT MAINTENANCE ORD/ENG TRUCK MOUNTING	3
T37588	TRUCK UTILITY EXPANDED CAPACITY ENHANCED: M1152A1	6
T41135	TRUCK CARGO: MTV W/E W/W	1
T58318	TRUCK TANK: WO/WINCH	3
T41271	TRUCK VAN: EXPANSIBLE MTV W/E M1087A1	1
T49255	TRUCK LIFT FORK: DSL DRVN 4000 LB CAP ROUGH TERRAIN	1
T56383	TRUCK UTILITY EXPANDED CAPACITY ENHANCED 4X4: M1165A1	2
T60081	TRUCK CARGO: 4X4 LMTV W/E	1
T61704	TRUCK CARGO: MTV LWB W/E	2
T61908	TRUCK CARGO: MTV W/E	7
T63093	TRUCK WRECKER: TACTICAL 8X8 HEAVY EXPANDED MOBILITY W/WINCH	1
T93484	TRUCK VAN: LMTV W/E	1
T93761	TRAILER: PALLETIZED LOADING 8X20	3
T94709	TRUCK WRECKER: MTV W/E W/W	2
T95555	TRAILER CARGO: MTV W/DROPSIDES M1095	4
T95992	LIGHT TACTICAL TRAILER: 3/4 TON	2
T96496	TRUCK CARGO: TACTICAL 8X8 HEAVY EXPANDED MOB W/LHS	7
T96564	TRAILER FLAT BED: M1082 TRLR CARGO LMTV W/DROPSIDES	1
Z00206	MULTI-TEMPERATURE REFRIGERATED CONTAINER SYSTEM: MTRCS	1
Z00514	MODULAR FUEL SYSTEM - TANKRACK MODULE:	3
Z01404	TRAILER-MTD: PU-2101/ 15 KW/ 50/60HZ/ M200A1	3
Z01414	LTT TRAILER-MTD: PU-2002/ 10 KW/ 50/60HZ	1
Z01420	LTT TRAILER-MTD: PU-2001/ 5 KW/ 50/60HZ	1
Z36683	TRAILER TANK WATER (CAMEL): 800 GAL 5 TON W/E	2
	M88A2 IRV (HERCULES)	3
	NIGHT VISION/OBSERVATION	
D41659	DRIVERS ENHANCERS: AN/VAS-5	6
N05482	NIGHT VISION: GOGGLE	63
S90535	MEDIUM WEAPON THERMAL SIGHT (MWTs): AN/PAS-13(V)2	11
S90603	HEAVY WEAPON THERMAL SIGHT (HWTS): AN/PAS-13(V)2	

COMMUNICATIONS AND ELECTRONICS

C18278	COMPUTER SYSTEM: DIGITAL AN/UHQ-90(V)2	11
C18378	COMPUTER SET: AN/UHK-128(V)3	2
C18448	COMPUTER SYSTEM: DIGITAL AN/GYK-61	2
C27435	COMPUTER SYSTEM: DIGITAL AN/TYQ-129(V)2	1
C27707	COMPUTER SYSTEM: DIGITAL AN/TYQ-109(V)1	1
C67686	COMPUTE SYSTEM: DIGITAL AN/TYQ-140	1
C78851	COMPUTER SYSTEM: DIGITAL AN/UHQ-90(V)3	2
H01907	ELECTRONIC SHOP SHELTER MOUNTED AVIONICS: AN/ASM-146 LESS POWER	2
J54771	INTERCONNECT GROUP: ON-721/V	1
N96248	NAVIGATION SET: SATELLITE SIGNALS AN/PSN-13	21
P99881	PROCESSOR GROUP SIG DATA: (CAISI 2.0) OL-701A/TYQ	2
R36178	RADIO TEST: SET AN/GRM-122	1
R45543	RADIO SET: AN/VRC-92F(C)	3
R68044	RADIO SET: AN/VRC-90F(C)	27
T40405	TAPE READER GENERAL PURPOSE: KOI-18/TSEC	2
Z00384	COMPUTER SYSTEM DIGITAL: AN/PYQ-10(C)	24
Z00560	INTERFACE UNIT COMMUNICATION EQUIPMENT: OL-713(V)1/TYQ CSS VSAT	1
Z01162	COMPUTER SYSTEM: DIGITAL AN/TYQ-139	4

MISC EQUIPMENT

C05701	MONITOR CHEMICAL AGENT:	1
D03932	DETECTING SET: MINE AN/PSS-14	2
G11966	GEN SET: DED SKID MTD 5KW 60HZ	1
G18358	GEN SET: DED SKID MTD 3KW 60HZ	4
G74711	GEN SET: DED SKID MTD 10KW 60HZ	2
J00697	JOINT CHMCL AGENT: DETECTOR	4
M12986	MASK CHEMICAL BIOLOGICAL JOINT SERVICE GENERAL PURPOSE: FIELD M50	86
R20684	RADIAC SET: AN/VDR-2	4
R30925	RADIAC SET: AN/PDR-75	1
R30993	RADIAC SET: AN/PDR-77()	1
R31061	RADIAC SET: AN/UDR-13	10
Z01328	GEN SET DED 5KW 50/60HZ: SKID-MTD	1
Z01330	GEN SET DED 10KW 50/60HZ: SKID-MTD	2

MEDICAL COMPANY, BSB, ABCT

MISSION.

To provide Echelon II medical care to supported maneuver battalions with organic medical platoons.

This company provides both Echelons I and II medical treatment on an area basis to those units without organic medical assets operating in the brigade support area (BSA).

MEDICAL COMPANY, BSB, ABCT

08329R000
15/0/66/81

COMPANY HEADQUARTERS PARA 01

FBCB2
AN/UJK-90(V)3
2X NVG
DAGR
EPLRS
AN/VRC-89F
AN/UJK-128(V)1

KOI-18/TSEC

2X NVG
DAGR
EPLRS
AN/VRC-89F



2X NVG
DAGR
EPLRS
AN/VRC-89F



FBCB2 AN/TYQ-107(V)1
2X NVG AN/TYQ-108(V)3
DAGR AN/TYQ-109(V)1
EPLRS OL-701A/TYQ
AN/VRC-90F



PU-798

MAJ 05A00 CDR M4 M9
CPT 70B67 EXEC OFF M4
1SG 68W5M 1SG M4
SGT 92Y20 SUPPLY NCO M4
SPC 92Y10 SUPPLY SP M4
SPC 74D10 CBRN SP M4
SPC 74D10 CBRN DECON SP M4
SPC 74D10 CBRN DECON SP M4

PREVENTIVE MEDICINE SECTION PARA 02

FBCB2 AN/TYQ-107(V)1
2X NVG AN/TYQ-105(V)1
DAGR
EPLRS
AN/VRC-90F



1LT 72D67 ENVIR SCIENCE OFF M4
SPC 68S10 PREVENTIVE MED SP M4

MENTAL HEALTH SECTION PARA 03

FBCB2 AN/TYQ-107(V)1
2X NVG 2X AN/TYQ-106(V)1
DAGR AN/TYQ-105(V)1
EPLRS
AN/VRC-90F



CPT 67D00 BEHAVORAL SCI OFF M4
CPT 67D00 BEHAVORAL SCI OFF M4
SGT 68X20 BEHAVORAL HLTH NCO M4
SPC 68X10 BEHAVORAL HLTH SP M4

MEDICAL TREATMENT PLT HQ PARA 04

FBCB2 2X AN/TYQ-107(V)2
2X NVG AN/TYQ-107(V)1
DAGR AN/TYQ-106(V)1
EPLRS 2X AN/TYQ-105(V)1
AN/VRC-90F OL-701A/TYQ



2X NVG
DAGR
AN/VRC-90F



1LT 70B67 FLD MED ASST M4
SFC 68W40 PLT SGT M4
SPC 68G10 PAT ADMIN SP M4

MEDICAL TREATMENT SQUAD PARA 05

FBCB2 AN/TYQ-106(V)1
AN/VAS-5 OL-701/TYQ
2X NVG
DAGR
EPLRS
AN/VRC-89F
AN/UJK-128(V)1

FBCB2 AN/TYQ-106(V)1
2X NVG OL-701/TYQ
DAGR
EPLRS
AN/VRC-89F
AN/UJK-128(V)1



FBCB2
AN/VAS-5
2X NVG
DAGR
EPLRS
AN/VRC-89F
AN/UJK-128(V)1



SSG 68W30 HLTH CARE SGT M4 AN/TYQ-105(V)1
SGT 68W20 HLTH CARE SGT M4 AN/TYQ-105(V)1
SPC 68W10 HLTH CARE SP M4 AN/TYQ-105(V)1
PFC 68W10 HLTH CARE SP M4 AN/TYQ-105(V)1

AREA SUPPORT SQUAD PARA 06

2X AN/TYQ-107(V)2
AN/TYQ-107(V)1
AN/TYQ-106(V)1
4X AN/TYQ-105(V)1
OL-701A/TYQ

CBPS



2X NVG
EPLRS
AN/VRC-90F



PU-803

CPT 63A00 DENTIST M9
CPT 65B00 PHY THERAPIST M4
SGT 68K20 MED LAB SGT M4
SGT 68P20 RADIOLOGY SGT M4
SGT 68W20 PHY THERAPY SGT M4
SPC 68E10 DENTAL SP M4
SPC 68K10 MED LAB SP M4
SPC 68P10 RADIOLOGY SP M4

MEDICAL TREATMENT SQUAD (AREA) PARA 07

FBCB2 AN/TYQ-106(V)1
AN/VAS-5 OL-701A/TYQ
2X NVG AN/TYQ-105(V)1
DAGR
EPLRS
AN/VRC-89F
AN/UJK-128(V)1

2X NVG
DAGR
AN/VRC-90F



x2



CPT 62B00 SURGEON M9 AN/TYQ-105(V)1
CPT 65D00 PA M9
SSG 68W30 HLTH CARE SGT M4 AN/TYQ-105(V)1
SGT 68W20 HLTH CARE SGT M4 AN/TYQ-105(V)1
SGT 68W20 HLTH CARE SGT M4 AN/TYQ-105(V)1
SPC 68W10 HLTH CARE SP M4 AN/TYQ-105(V)1
SPC 68W10 HLTH CARE SP M4 AN/TYQ-105(V)1
SPC 68W10 HLTH CARE SP M4 AN/TYQ-105(V)1
PFC 68W10 HLTH CARE SP M4 AN/TYQ-105(V)1
PFC 68W10 HLTH CARE SP M4 AN/TYQ-105(V)1
PFC 68W10 HLTH CARE SP M4 AN/TYQ-105(V)1

MEDICAL COMPANY, BSB, ABCT

PATIENT HOLDING SQUAD PARA 08

AN/TYQ-106(V)1



CBPS

X2 NVG
DAGR
AN/VRC-88



CPT 66H00 MED-SURGERY NURSE M4 AN/TYQ-105(V)1
SGT 68W20 HLTH CARE SGT M4 AN/TYQ-105(V)1
SGT 68W20 HLTH CARE SGT M4 AN/TYQ-105(V)1
SPC 68W10 HLTH CARE SP M4 N/TYQ-105(V)1
PFC 68W10 HLTH CARE SP M4 N/TYQ-105(V)1

EVACUATION PLT HQ PARA 09

FBCB2
AN/YTQ-90(V)3
X2 NVG
DAGR
EPLRS
AN/VRC-89F
AN/UYSK-128(V)1

OL-701A/TYQ
KOI-18/TSEC



1LT 70B67 PLT LDR M4 AN/TYQ-107(V)1
SFC 68W40 PLT SGT M4

EVACUATION SQUAD (FORWARD) PARA 10

FBCB2
AN/VAS-5
X2 NVG
DAGR
EPLRS
AN/VRC-90F
AN/UYSK-128(V)1



SSG 68W30 EMER CARE SGT M4
SGT 68W20 EMER CARE SGT M4
PFC 68W10 AMB DRIVER M4 AN/TYQ-105(V)1

x6

EVACUATION SQUAD (AREA) PARA 11

FBCB2
AN/VAS-5
X2 NVG
DAGR
EPLRS
AN/VRC-90F
AN/UYSK-128(V)1



FBCB2
AN/VAS-5
X2 NVG
DAGR
EPLRS
AN/VRC-90F
AN/UYSK-128(V)1



x2

SGT 68W20 EMER CARE SGT M4 AN/TYQ-105(V)1
SGT 68W20 EMER CARE SGT M4 AN/TYQ-105(V)1
PFC 68W10 AMB DRIVER M4 AN/TYQ-105(V)1
PFC 68W10 AMB DRIVER M4 AN/TYQ-105(V)1
SPC 68W10 AMB DRIVER M4 AN/TYQ-105(V)1
SPC 68W10 AMB DRIVER M4 AN/TYQ-105(V)1
PFC 68W10 AMB DRIVER AN/TYQ-105(V)1
PFC 68W10 AMB DRIVER AN/TYQ-105(V)1

BRIGADE MEDICAL SUPPLY OFFICE PARA 12

FBCB2
X2 NVG
DAGR
EPLRS
AN/VRC-90F

X2 NVG
AN/VRC-92F



X2 AN/TYQ-105(V)1
OL-701A/TYQ
AN/TYQ-139



1LT 70K67 HLTH SVC MAT OFF M4
SSG 68J30 MED LOG SGT M4
SGT 68A20 BIOMEDICAL EQUIP SGT M4 AN/TYQ-107(V)1
AN/TYQ-105(V)1
SGT 68J20 MED LOG SGT M4
SGT 68Q20 PHARMACY SGT M4 AN/TYQ-105(V)1
PFC 68J10 MED LOG SP M4
SPC 68J10 MED LOG SP M4

EQUIPMENT SUMMARY

WEAPONS

PISTOL 9MM AUTOMATIC M9----- 6
RIFLE 5.56MM M4 CARBINE----- 76

VEHICLES, TRAILERS, AND TRLR MTD SYSTEMS

CHEM AND BIO PROTECTED SHELTER SYS (CBPS)----- 4
CARRIER PERSONNEL FT ARMORED (RISE) (M113A3)----- 6
CARRIER COMMAND POST LT TRACKED: (M577A2)----- 2
GEN SET DIESEL ENGINE TM: 30KW 50/60 HZ (PU-803)----- 1
GEN SET DED TM: 10KW 60HZ (PU-798)----- 1
TRUCK UTILITY EXP CAPACITY ENH 4X4: M1152A1----- 6
TRUCK AMBULANCE: 4 LITTER HMMWV (M997)----- 6
TRUCK UTILITY EXP CAPACITY ENH 4X4: M1165A1----- 3
TRUCK CARGO: MTV (M1083)----- 6
TRAILER CARGO: MTV W/ DROPSIDES (M1095)----- 3
LIGHT TACTICAL TRAILER: 3/4T (M1101)----- 9
TRAILER TANK WATER (CAMEL) 800 GAL 5 TON----- 1

MISCELLANEOUS EQUIPMENT

DECON APPARATUS LT WEIGHT----- 2
GEN SET: DED SKID MTD 5 KW 60HZ (MEP-802A)----- 2
GEN SET: DED SKID MTD 3KW 60HZ (MEP-831A)----- 5

COMMUNICATION-ELECTRONICS EQUIPMENT

ANTENNA GROUP: OE-254----- 9
COMPUTER SYSTEM DIGITAL: AN/TYQ-107(V)2----- 4
COMPUTER SYSTEM DIGITAL: AN/TYQ-107(V)1----- 10
COMPUTER SYSTEM DIGITAL: AN/TYQ-106(V)1----- 9
COMPUTER SET: DIGITAL AN/UYSK-128(V)1 (FBCB2 APPLIQUE)----- 25
COMPUTER SYSTEM DIGITAL: AN/TYQ-105(V)1----- 56
COMPUTER SYS DIGITAL: AN/TYQ-108(V)3----- 1
COMPUTER SET DIGITAL: AN/TYQ-109(V)1 (GCSS-A (V)1)----- 1
COMPUTER SYSTEM: DIGITAL AN/TYQ-139 (SAMS-1E V1)----- 1
COMPUTER SYSTEM DIGITAL: AN/UYSK-90(V)3 (MTS-CS)----- 2
NAVIGATION SET: SATELLITE SIGNALS AN/PSN-13 (DAGR)----- 28
PJH SURFACE VEH RADIO SET: AN/VSQ-2(V)1 (EPLRS-V1)----- 25
PROCESSOR GROUP SIGNAL DATA: (CAISI 2.0) OL-701A/TYQ----- 9
RADIAC SET: AN/VDR-2----- 17
RADIO SET: AN/VRC-88F----- 1
RADIO SET: AN/VRC-89F----- 8
RADIO SET: AN/VRC-90F----- 20
RADIO SET: AN/VRC-92F----- 1
COMPUTER SET: DIGITAL AN/GYK-62B (BFT TOC KIT)----- 1

NIGHT VISION/OBSERVATION EQUIPMENT

DRIVERS VISION ENHANCER: AN/VAS-5----- 12
NIGHT VISION GOGGLES: AN/PVS-7B----- 72

PAGE INTENTIONALLY LEFT BLANK

MCoE SUPPLEMENTAL MANUAL 3-90

FORCE STRUCTURE REFERENCE DATA



STRYKER BRIGADE COMBAT TEAM

ANNEX C

SEPTEMBER 2013

FIRES BN TRAINING CONSOLIDATION IS NOT SHOWN, INSTEAD ALL FIRES SOLDIERS ARE SHOWN IN RED INDICATING THEIR INTENDED MTOE POSITION.



STRYKER BRIGADE COMBAT TEAM

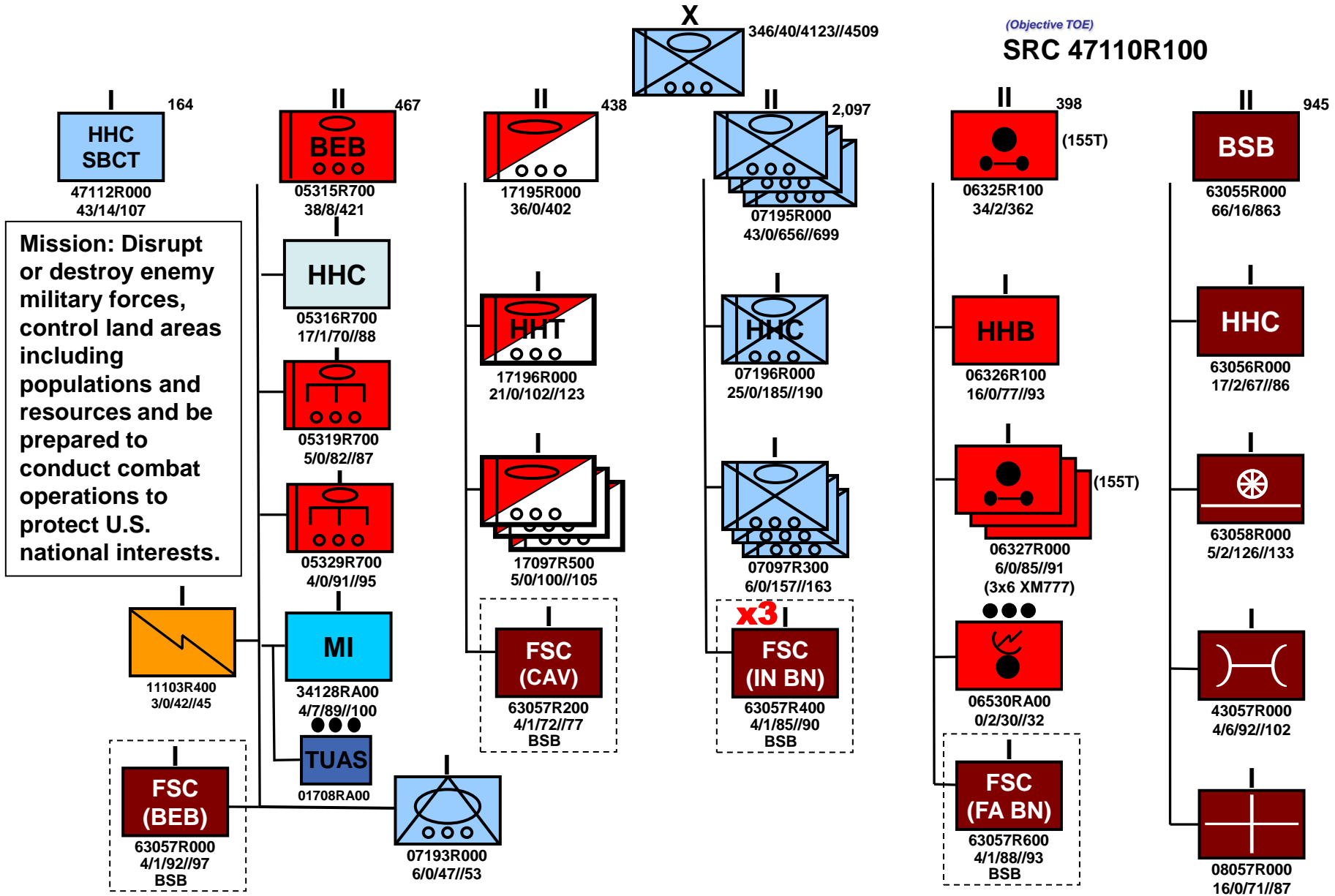

NOTE: AN/UYK-128(V)1 (EPLRS-BASED) FBCB2 IS SHOWN IN THIS ANNEX (SBCT). IF THE UNIT HAS BFT-BASED FBCB2 (AN/UYK-128(V)3), EPLRS DOES NOT APPLY, NOR IS THE BRIGADE SIGNAL COMPANY EPLRS NETWORK MANAGER AND GATEWAY PARAGRAPH (PARA 08) DOCUMENTED ON THE MTOE.

HQ, STRYKER BRIGADE

MISSION.

To plan, direct, control, provide information management and communications, and coordinate the Stryker brigades operations. It also provides support to specified brigade units listed below under capabilities.

HEADQUARTERS, SBCT

47112R000
39/14/109//164

BRIGADE COMMAND SECTION PARA 01

FBCB2 AN/VRC-106(V)1
AN/PYQ-6C AN/VRC-1-4(V)3
AN/VAS-5 HWTS
STORM .50 CAL
x2 NVG AN/UYK-128(V)1
AN/TYQ-137B(V)3 EPLRS-V1
x2 AN/VRC-92F AN/PAS-5



COL 02C00 CDR M4 M9 AN/VRC-119F
DAGR
SFC 11B40 ASST OPS SGT M4
AN/VRC-119F DAGR
SSG 11B30 IAV CDR M4 ILLUM
SPC 11B10 IAV DRIVER M4

FBCB2 x2X NVG
DAGR AN/VAS-5
EPLRS-V1 N/VRC-92F
AN/MRC-150 *COL 02C00 CDR M4 M9
AN/UYK-128(V)1 AN/VRC-119F DAGR
AN/TYQ-137B(V)3 PFC 25U10 DRIVER M4
*WHEN NOT MOUNTED IN CV



FBCB2 x2 NVG
DAGR AN/PSC-5
AN/VAS-5 EPLRS-V1
AN/VRC-92F AN/PYQ-6C
AN/UYK-128(V)1
AN/TYQ-137B(V)3



LTC 02C00 DEP CDR M4 M9
AN/PRC-119F
(GRADE PLATE DELETION)

FBCB2 AN/VRC-90F
AN/GYK-48(V)1 AN/VRC-106(V)1
AN/VAS-5 AN/VRC-104(V)3
x2 NVG AN/UYK-128(V)1
DAGR
EPLRS-V1
AN/VRC-92F
AN/PAS-5



MAJ 13A00 BDE FS COORD M9

DAGR FBCB2
x2 NVG AN/VAS-5
EPLRS-V1
AN/VRC-90F
AN/UYK-128(V)1



CSM 00T60 CSM M4 M9
SPC 11B10 OPS ASST M4
PFC 11B10 VEH DRIVER M4

CURRENT OPS SECTION PARA 2

FBCB2 AN/VAS-5
x2 NVG
DAGR
EPLRS-V1
AN/VRC-92F
AN/UYK-128(V)1



LTC 02B00 BDE EXEC OFF M9
MAJ 42H00 S1 M9
SSG 11B30 ASST OPS SGT M4
SPC 11B10 OPS ASST M4
PFC 11B10 DRIVER M4

FBCB2 x2 NVG
DAGR AN/PSC-5
AN/VAS-5 EPLRS-V1
AN/VRC-90F AN/VRC-106(V)1
AN/UYK-128(V)1 AN/TYQ-116(V)3
X2 AN/TYQ-137B(V)03

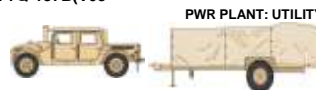

PWR PLANT: UTILITY

MAJ 35D00 S2 M9
MAJ 46A00 PAO M9
MAJ 27A00 SJA M9
CPT 11A00 ASST S3 M4
MSG 35X50 CHIEF INTEL SGT M4

CURRENT OPS - LNO PARA 03

FBCB2 AN/PYQ-6C
AN/VAS-5
x2 NVG
DAGR
EPLRS-V1
AN/VRC-90F
AN/VRC-106(V)1
AN/UYK-128(V)1



CPT 11A00 LNO M4
SSG 19K30 LN SGT M4

CURR OPS - FIRE SPT/TACP PARA 04

FBCB2 EPLRS-V1
AN/VAS-5 AN/VRC-92F
STORM HWTS
x2 NVG .50 CAL
AN/GYK-56 DAGR-V1
AN/UYK-128(V)1



MAJ 01A00 AIR FORCE STAFF OFF M4
SFC 00D40 AIR FORCE STAFF NCO M4
SSG 00D30 AIR FORCE STAFF NCO M4
SGT 11B20 IAV CDR M4
SPC 11B10 IAV DRIVER M4

USAF PERSONNEL - NOT ASSIGNED
TO UNIT

INTEL CELL S2X PARA 05

FBCB2 AN/TYQ-93
AN/VAS-5 AN/PYQ-7
x2 NVG AN/PYQ-3
X2 DAGR AN/TYQ-137B(V)3
EPLRS-V1 DAGR
AN/VRC-92F x2 AN/PSC-5
AN/VRC-90F
AN/UYK-128(V)1

PWR PLANT: UTILITY



CPT 35E00 TEAM CHIEF M4
CW2 351M0 HUMINT COLL TECH M9
CW2 125D0 GEOSPATIAL INFO TECH M4
CW2 351M0 HUMINT COLL TECH M4
SFC 12Y40 SR GEOSPATIAL ENG SGT M4
SSG 35G30 IMAGERY SGT M4
SGT 12Y20 GEOSPATIAL ENG SGT M
SGT 35L20 CI AGENT M9
SGT 35M2L HUMINT COLL M4
SPC 12Y10 GEOSPATIAL ENG M4
SPC 35G10 IMAGERY ANLST M4
PFC 12Y10 GEOSPATIAL ENG M4

AN/VAS-5 AN/PYQ-6C
x2 NVG AN/TYQ-67(V)
DAGR AN/TYQ-71
AN/VRC-90F
AN/VRC-106(V)1
AN/TSQ-67(V)DTSS-L



PU - 796

AN/VAS-5
x2 NVG
DAGR
AN/VRC-90F



PLANS CELL PARA 06

FBCB2 2X AN/PYQ-6C
AN/VAS-5
x2 NVG
DAGR
EPLRS-V1
AN/VRC-92F
AN/VRC-104(V)3
AN/UYK-128(V)1



CPP RWS

MED PWR PLANT

FBCB2 AN/VAS-5
x2 NVG
DAGR
EPLRS-V1
AN/VRC-92F
AN/UYK-104(V)3
AN/UYK-128(V)1



MAJ 02A00 PLANS OFF M9
CPT 02A00 PLANS OFF M4 (NEW)
CPT 12B00 PLANS OFF M4
CPT 90A00 LOG OFF M4
SFC 12B40- OPS SGT M4
SFC 11B40 ASST OPS SGT M4
SSG 35F30 INTEL SGT M4

FIRE SPT/PROTECT - NLOS PARA 07

FBCB2 AN/GYG1(V)3
AN/VAS-5 AN/TYQ-137B(V)3
2X NVG AN/GYK-48(V)1
DAGR AN/GYK-56
EPLRS-V1
AN/VRC-92F
AN/UYK-128(V)1



FBCB2 x2 NVG
DAGR AN/VAS-5
EPLRS-V1
AN/VRC-92F AN/GYK-48(V)1
AN/VRC-104(V)3 AN/GYK-58
AN/UYK-128(V)1 FHMUX



MED PWR PLANT

MAJ 30A00 INFO OPS OFF M9
CPT 27A00 OPLAW JA M4
CPT 35G00 ELEC WARFARE SPT OFF M4
CPT 38A00 CIVIL AFFAIRS OFF M9
SFC 38B40 CIVIL AFFAIRS NCO M4
SFC 37F40 SR PSYOPS SGT M4
SSG 25E30 ELECTRO SPECT NCO
SSG 13F30 TGT/EW NCO M4
SPC 13F10 FIRE SPT SP M4
CPT 13A00 ASST FIRE SPT OFF M4

CPT 29A00 EW OFF M4
CW2 131A0 TGT ANAL M4
CW2 290A0 EW TECH M4
MSG 29E50 EW SGT NCOIC M4
SFC 27D40 SR PARALEGAL NCO M4
SFC 29E40 EW SGT M4
SSG 29E30 EW SGT M4
SGT 13F20 FIRE SPT SGT M4

HEADQUARTERS, SBCT

FIRE SPT/PROT-ADAM/BAE PARA 08

FBCB2 AN/VAS-5
x2 NVG
DAGR
EPLRS-V1
AN/GRC-240
AN/VRC-92F
AN/PSC-5
AN/VRC-100(V)1
AN/UJK-128(V)1
AN/FSQ-211

FBCB2 AN/VAS-5
x2 NVG
DAGR
EPLRS-V1
AN/VRC-90F
AN/UJK-128(V)1

x2 DAGR AN/VRC-92F
AN/VRC-106(V)1
x2 AN/PRC-117F
EPLRS-V1 AN/USQ-140(V)2
AN/VRC-104(V)3
AN/FSQ-211

AN/TSQ-253

PU-798



MAJ 15B00 AVIATION OFF M9
CPT 15B00 ASST AVIATION OFF M9
CW3 153AI TAC OPS OFF M9
SSG 15P30 AVIATION OPS SGT M4
SGT 14G20 TEAM LDR M4
SPC 15P10 AVIATION OPS SP M4

MAJ 14A00 AD COORD OFF M9
CW4 150U0 UAS OPS OFF M4
SSG 14G30 SECT SGT M4
SGT 14G20 TEAM LDR M4
S[PC14G10 BLT SYS OPER M4

FIRE SPT/PROTECT-PAO PARA 09

FBCB2 2X NVG
DAGR EPLRS
AN/VAS-5 AN/PYQ-6C
AN/VRC-90F
AN/UJK-128(V)1
VIDEO ACQUISITION



SSG 46Q30 PUBLIC AFFAIRS NCO M4
SGT 48R20 PA BROADCAST SGT M4
SGT 46Q20 PBLIC AFFAIRS SGT M4

MVMT & MNVR CELL PARA 10

FBCB2 x2 NVG
DAGR AN/VAS-5
EPLRS-V1 AN/VRC-92F
AN/VRC-106(V)1 AN/UJK-128(V)1
MED PWR PLANT



CPT 11A00 OPS OFF M4
SFC 11B40 ASST OPS SGT M4

DAGR x2 NVG
AN/VAS-5 AN/VRC-90F



MSG 19Z50 OPS SGT M4
SFC 74D40 CBRN STAFF NCO M4

MVMT & MNVR/PROT-PMO PARA 11

FBCB2 x2 NVG
DAGR AN/VAS-5
EPLRS-V1 AN/VRC-92F
AN/VRC-106(V)1 AN/UJK-128(V)1
AN/TYQ-137B(V)3



CPT 31A00 PROVOST MARSHAL M9
SFC 31E40 I/R NCO M4 M9
SFC 31B40 OPS NCO M4

SUST S1 PARA 12

FBCB2 x2 NVG
DAGR AN/VAS-5
EPLRS-V1 OL-713(V)1
AN/VRC-90F AN/TSC-183
OL-701A/TYQ AN/VRC-106(V)1
AN/UJK-128(V)1
X8 AN/TYQ-116(V)3



1LT 42B00 STRENGTH MGR M4
CW2 42A00 HR TECH M4
MSG 42A50 SR HR SGT M4
SSG 42A30 HR SGT M4
SGT 42A20 HR SGT M4
SPC 42A10 HR SP M4
PFC 42A10 HR SP M4
PFC 42A10 HR SP M4
PFC 42A10 HR SP M4

SPC 42A10 HR SP M4? ?
SGT 42F20 HR INFO SYS MGT
SGT M4??
SPC 42F10 HR INFO SYS MGT SP
M4 ??

SUSTAINMENT - S4/MED PARA 13

FBCB2 AN/VAS-5
x2 NVG DAGR
EPLRS-V1 AN/VRC-92F
AN/UJK-128(V)1
AN/TYQ-107(V)1
X2 AN/TYQ-108(V)3
OL-701-A/TYQ

KOI-18/TSEC
AN/TYQ-107(V)1
AN/TYQ-108(V)3
AN/TYQ-109(V)2
2X OL-701A/TYQ
x4 AN/TYQ-129(V)2
X2 AN/GYK-61 (BCS3)

x2 AN/TYQ-9
x2 AN/GYK-651
AN/TYQ-109(V)1
AN/UJK-90(V)3

AN/VAS-5
2X NVG
DAGR
AN/VRC-92F



MED PWR PLANT

MAJ 62B00 SURGEON M9 AN/TYQ-105(V)1
CPT 79H67 MED OPS OFF M4
MSG 92Y50 SR SUPPLY SGT M4
SFC 678W40 HEALTH CARE NCO M4
SFC 88N40 TRANS LOG NCO M4
SFC 92Y40 PROP BOOK NCO M4 (NEW)
SGT 92Y20 PROP BOOK NCO M4

MAJ 90A00 S4 M9
CW2 882A0 MOB OFF M4
CW2 920A0 PROP ACCT TECH M4
CW2 922A0 FOOD ADV M4
MSG 92G50 SR FOOD OPS SGT M4
SGT 92Y20 SUPPLY NCO M4

SUSTAINMENT - S8 PARA 14

FBCB2
AN/PYQ-6C
AN/VAS-5
x2 NVG
DAGR
EPLRS-V1
AN/VRC-90F
AN/UJK-128(V)1



CPT 36A00 FIN MGMT OFF M4
SFC 36B40 FIN MGT NCO M4

UMT PARA 15

FBCB2
AN/PYQ-6C
AN/VAS-5
x2 NVG
DAGR
EPLRS-V1
AN/VRC-90F
AN/UJK-128(V)1



MAJ 56A00 CHAPLAIN
SSG 56M30 CHAPLAIN ASST M4

C4 OPS - S6 PARA 16

AN/VAS-5
x2 NVG
DAGR
EPLRS-V1
OB-123/T
AN/VRC-89F
AN/UJK-128(V)1

x2 NVG AN/TSQ-243
AN/TYQ-122 AN/GYK-62B
AN/VRC-90F x2 AN/PYQ-16
AN/VRC-104(V)3 AN/TYQ-137B(V)3
x2X AN/TYQ-155(V)1



PU-798

MAJ 25A00 S6 M9
CW3 255S0 NETWRK DEF TECH M4
CW2 255A0 INFO SVCS TECH M4
CW2 255N0 NETWRK MGMT TECH M4
MSG 25U50 SIG SPT SYS CHIEF M4
SFC 25B40 INFO SYS STAFF NCO M4
SFC 25B40 IA STAFF NCO M4
SFC 25E40 ELECT SPEC MGR M4
SSG 25B30 INFO TECH TM CH M4
SSG 25U30 SIG INFO SVC NCO M4
SSG 25S30 SATCOM OPNS NCO M4
SSG 25N30 NODAL OPS SYS NCO M4

AN/VAS-5
x2 NVG
AN/VRC-90F

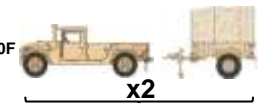

x2

FBCB2 x2 NVG
DAGR AN/VAS-5
EPLRS-V1 AN/VRC-90F
AN/USQ-165 AN/TSR-8(GRT)
AN/GYK-50B(ISYCON)(V)4
MED PWR PLANT



AN/VRC-90F
AN/TSC-188(V)1



PU 803

SSG 25B30 COMSEC CUSTODIAN M4
SSG 25Q30 XMSN SYS OPS NCO M4
SGT 25B20 SR INFO TECH SP M4
SGT 25B20 SR INFO SYS SP M4
SGT 25B20 IA STAFF ASST M4
SGT 25B20 ASST COMSEC CUST M4
SGT 25L20 SR CBL/ANT SYS SPL M4
SPC 25L10 CBL/ANT SYS SPL M4
PFC 25L10 CBL/ANT SYS SPL M4
PFC 25U10 SIG SPT SYS SP M4
SPC 5B10 INFO TECH SP M4
PFC 25B10 INFO TECH SP M4

HEADQUARTERS, SBCT

TAC CURRENT OPS 1 – OPS PARA 17

FBCB2
STORM
x2 NVG
DAGR
EPLRS-V1
x2 AN/VRC-92F
AN/PSC-5
AN/VRC-106(V)1
AN/VRC-104(V)3
HWTS
AN/MRC-150
AN/UYSK-128(V)1

FBCB2
STORM
x2 NVG
DAGR
EPLRS-V1
AN/VRC-92F
AN/PSC-5
AN/VRC-104(V)3
AN/UYSK-128(V)1
X4 AN/TYQ-137B(V)03
HWTS
FHMUX



LTC 02B00 S3 M9 M4 DAGR
SPC 11B10 IAV DVR M4

DAGR
AN/VRC-90F



CPT 35D00 ASST S2 M4
CPT 74A00 CBRN OFF M4
SGM 11Z60 OPS SGT M4

CPT 13A00 BDE BTL CPT M4 ??

DAGR
AN/TYQ-71
AN/VRC-92F



MAJ 12A00 BDE ENG OFF M4
SSG 12B30 RECON SGT M4

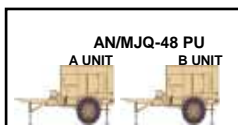

CPT 35D00 INTEL OFF M4
CPT 57A00 BATTLE CMD OFF M4
SFC 19K40 OPS SGT M4

TAC CURRENT OPS – FIRE SPT/TACP PARA 18

FBCB2
STORM
x2 NVG
DAGR
EPLRS-V1
AN/GYK-56
AN/VRC-92F
AN/UYSK-128(V)1



* MAJ 01A00 AIR FORCE STAFF OFF M4
* SFC 00D40 AIR FORCE STAFF NCO M4
* SSG 00D30 AIR FORCE STAFF NCO M4

SGT 11B20 IAV CDR M4
SPC 11B10 IAV DRIVER M4

*AIR FORCE PERSONNEL NOT ASSIGNED TO THE UNIT

TAC CURRENT OPS 2 – INTEL/S2 PARA 19

FBCB2
AN/VAS-5
x2 NVG
DAGR
EPLRS-V1
AN/VRC-92F
AN/PSC-5
AN/UYSK-128(V)1

AN/TYQ-93
AN/TYQ-93(V)2



CW2 350F0 ALL SOURCE INTEL TECH M4
SFC 11B40 SR INTEL SGT M4
SSG 35F30 INTEL SGT M4
SPC 35F10 INTEL ANLST M4
PFC 35F10 INTEL ANLST M4

TAC CURR OPS 2 – SUSTAIN PARA 20

FBCB2
AN/VAS-5
x2 NVG
DAGR
EPLRS-V1
AN/VRC-92F
AN/UYSK-128(V)1



CPT 90A00 ASST S4 M4
SPC 92Y10 SUPPLY SP M4

TAC CURRENT OPS 2 – C4 OPS PARA 21

FBCB2
AN/VAS-5
x2 NVG
DAGR
EPLRS-V1
AN/VRC-92F
AN/UYSK-128(V)1

AN/PYQ-16
AN/TSQ-243
AN/TSR-8
AN/GYK-50B(ISYSCON)(V)4
AN/GYK-62B



CPT 53A00 INFO SYS MGT OFF M4
SFC 25W40 NETWORK OPS CH M4
SPC 25B10 INFO TECH SPEC M4
SPC 25U10 SIGNAL SPT SYS MAINT M4

COMPANY HEADQUARTERS PARA 22

FBCB2
AN/VAS-5
x2 NVG
DAGR
EPLRS-V1
AN/VRC-90F
AN/UYSK-128(V)1



CPT 02A00 CDR M4 M9
PFC 92Y10 SUPPLY SP M4

FBCB2 2X NVG
DAGR HWTS
.50 CAL AN/VAS-5
EPLRS-V1 AN/VRC-87F
OL-701A/TYQ
AN/TYQ-109(V)1
AN/UYSK-128(V)1



1LT 02A00 CO EXEC OFF M4
1SG 11Z5M 1SG M4
SSG 92Y30 SUPPLY SGT M4
SPC 92Y10 SUPPLY SP M4 MP

MOVED TO FIRES BN

TAC CURRENT OPS 1 – FIRE SPT PARA 18

FBCB2
AN/VAS-5
x2 NVG
DAGR
EPLRS-V1
AN/VRC-92F
AN/VRC-106(V)1
AN/UYSK-128(V)1

AN/GYG1(V)3
X3 DAGR
AN/PSC-5
x2 AN/PRC-119F
AN/VRC-104(V)03
AN/GYK-56



MAJ 13A00 ASST FSO M9
MSG 13Z50 OPS SGT M4
SFC 13F40 FIRE SPT SGT M4
SFC 13F40 TGT NCO M4
SPC 13F10 FIRE SPT SP M4

COLT PARA 22 (DELETED)

FBCB2
AN/VAS-5
M249
x2 NVG
DAGR
EPLRS-V1
AN/VRC-92F
AN/PSC-5
AN/VRC-90F
AN/VRC-104(V)3
MWTS AN/UYSK-128(V)1

AN/PSG-14(V)1
AN/PED-1 (LLDR)



SGT 13F20 KNIGHT/COLT SGT M4 ILLUM NVG
PFC 13F10 RTO M4 ILLUM
SPC 13F10 FIRE SPT SP M4 ILLUM

x4

EQUIPMENT SUMMARY

WEAPONS

LAUNCHER GRENADE M320A1-----	18
MACHINE GUN .50: HVY FIXED TURRET TYPE M48-----	6
MACHINE GUN 5.56MM M249-----	14
MACHINE GUN LIGHT 5.56MM M249-----	8
MACHINE GUN GRENADE 40MM MK-19 MOD III-----	7
PISTOL 9MM AUTOMATIC M9-----	69
RIFLE 5.56MM M4 CARBINE-----	195
SHOTGUN: 12 GAUGE (MASS) M26-----	3
MACHINE GUN: CALIBER .50 (M2E2)-----	12

VEHICLES, TRAILERS, AND TRLR MTD SYSTEMS

ARMORED SECURITY VEHICLE: WHEELED (ASV) M1117-----	0
COMMAND SYSTEM: TACTICAL (CPP RWS) (MTD ON HMMWV)-----	4
COMMAND VARIANT VEHICLE: (CV) (M1130)-----	4
GEN SET DED TM: 10KW 60HZ (PU-798)-----	3
POWER PLANT: UTILITY, LARGE 35KW 12 TON ECU-----	1
POWER PLANT: UTILITY, MEDIUM 20KW 5 TON ECU-----	8
POWER PLANT: ELECTRIC TLR MTD AN/MJQ-48-----	1
KNIGHT: M707 FIRE SUPPORT VEHICLE-----	4
TRUCK UTILITY: ECV ARMAMENT CARRIER M1151A1-----	8
TRUCK CARGO: MTV (M1083)-----	4
TRUCK UTILITY EXP CAPACITY ENH 4X4: M1152A1-----	15
TRUCK UTILITY EXP CAPACITY ENH 4X4: M1165A1-----	19
TRAILER CARGO: MTV W/ DROPSIDES (M1095)-----	2
TRAILER HIGH MOBILITY 1-1/4T (M1102)-----	10
LIGHT TACTICAL TRAILER: 3/4T (M1101)-----	11
TRAILER TANK WATER (CAMEL) 800 GAL 5 TON-----	1

MISCELLANEOUS EQUIPMENT

GEN SET: DED SKID MTD 5 KW 60HZ (MEP-802A)-----	2
SMALL UNMANNED AIRCRAFT SYSTEM: (SUAS) RAVEN B-----	2

NIGHT VISION/OBSERVATION EQUIPMENT

DRIVERS VISION ENHANCER: AN/VAS-5-----	60
MINI EYESAFE LASER IR OBS SET: AN/PVS-6 (MELIOS)-----	19
MONOCULAR NIGHT VISION DEVICE: AN/PVS-14-----	35
NIGHT VISION GOGGLES: AN/PVS-7B-----	92
NIGHT VISION DEVICE: AN/PSQ-20 (ENVG)-----	14
RANGE FINDER-TGT DESIGNATOR: LASER AN/PED-1 (LLDR)-----	4
MEDIUM THERMAL WEAPONS SIGHT: AN/PAS-13(V2)-----	22
HEAVY THERMAL WEAPONS SIGHT: AN/PAS-13(V3)-----	19

COMMUNICATION-ELECTRONICS EQUIPMENT

ALL SOURCE ANALYSIS SYSTEM: AN/TYQ-93 (ASAS-LT)-----	4
ALL SOURCE ANALYSIS SYSTEM: AN/TYQ-93(V)2 (ASAS-IFS)-----	1
ANTENNA GROUP: OE-254-----	47
COMPUTER SYSTEM DIGITAL: AN/PSG-14(V)1 LFFED-----	4
COMPUTER SET: AN/GYK-58 (AFATDS - DUAL)-----	2
CENTER COMMUNICATIONS OPERATIONS: AN/TSQ-253 (COCS)-----	1
COMPUTER SET DIGITAL: AN/PYQ-7 (CI&I OPS WS)-----	1
COMPUTER SYSTEM DIGITAL: AN/TYQ-107(V)1-----	1
COMPUTER SET GENERAL: AN/GYK-33D-----	1
COMPUTER SYSTEM DIGITAL: AN/UYQ-90(V)2 (MTS)-----	8
COMPUTER SYSTEM DIGITAL: AN/PYQ-3 (CHATS)-----	1
COMP SET DIGITAL: AN/UYK-128(V)1 (FBCB2 APPLIQUE)-----	51
COMPUTER SYSTEM DIGITAL: (AMPS)-----	1
BTL CMD SUSTAINMENT SPT SYSTEM: AN/GYK-61 (BCS3)-----	2
COMPUTER SET DIGITAL: AN/PYQ-12 (MCS GATEWAY SVR)-----	2
COMP SYS DIGITAL (TBC MGMT CONSOLE): AN/PYQ-16-----	2
COMPUTER SYS DIGITAL: AN/TYQ-129(V)2 (TC-AIMS II WS)-----	4
COMPUTER SYSTEM DIGITAL: AN/TYQ-105(V)1-----	2
COMPUTER SYS DIGITAL: AN/TYQ-108(V)3-----	1
COMPUTER SET DIGITAL: AN/TYQ-109(V)1 (GCSS-A (V)1)-----	2
COMPUTER SET DIGITAL: AN/TYQ-109(V)2 (GCSS-A (V)2)-----	1
TAC BATTLE COMMAND (TBC) CLIENT: AN/TYQ-137B(V)3-----	14
COMMAND SYSTEM TACTICAL: AN/TYQ-155(V)1 (TCB SERVER)-----	4
COMMAND CENTER SYSTEM: AN/TSQ-243-----	2
COMPUTER: TACTICAL AN/GYQ-88 (ANDWS)-----	1
COMPUTER SYSTEM DIGITAL: AN/UYQ-90(V)3 (MTS-CS)-----	1
COMPUTER SET: GENERAL AN/GYK-49(V)2-----	1
COMPUTER SET FA GENERAL: AN/GYK-48(V)1 (FSCoord)-----	2
DIGITAL TOPOGRAPHIC SYSTEM: AN/TYQ-67(V)-----	1
DIGITAL TOPOGRAPHIC SUPPORT SYSTEM: AN/TYQ-71-----	1
FREQUENCY HOPPING MULTIPLEXER: TF-1456VRC (FHMUX)-----	4
TERM SAT COMMS : AN/TSC-183: (OL-713(V)1/TYQ CSS VSAT)-----	1
INTERROGATOR SET AN/TYQ-95 (TC-AIMS II INTERROGATOR)-----	2
NAVIGATION SET: SATELLITE SIGNALS AN/PSN-13 (DAGR)-----	62
PJH SURFACE VEH RADIO SET: AN/VSQ-2(V)1 (EPLRS-V1)-----	53
PROCESSOR GROUP SIGNAL DATA: (CAISI 2.0) OL-701A/TYQ-----	4
RADIAC SET: AN/VDR-2-----	28
RECEIVE SUITE: AN/TSR-8 (GRT)-----	2
RADIO SET: AN/USQ-140(V)2(C)-----	1
RADIO SET: AN/VRC-87F-----	1
RADIO SET: AN/VRC-89F-----	1
RADIO SET: AN/VRC-90F-----	24
RADIO SET: AN/VRC-91F-----	14
RADIO SET: AN/VRC-92F-----	33
RADIO SET: AN/VRC-104(V)3 150 WATT IK: PRC-150 HF RADIO-----	12
RADIO SET: AN/PRC-119F-----	5
RADIO SET: AN/PSC-5-----	15
RADIO SET: AN/VRC-106(V)1(C)-----	11
RADIO SET: AN/VRC-106(V)2(C)-----	1
RADIO SET: HIGH FREQ AN/VRC-100(V)1-----	1
RADIO SET: AN/PRC-117F TACSAT RADIO MANPACK-----	2
TELECONFERENCE SYSTEM: AN/TYQ-122-----	3
WORKSTATION: AIRSPACE OPERATION AN/FSQ-211 (TAIS AWS)-----	1
COMPUTER SET FA GENERAL: AN/GYK-56 (EMT)-----	4
COMPUTER SYSTEM DIGITAL: AN/GYK-50B (ISYSCON) (V4)-----	2
LAND MOBILE RADIO: (LMR)-----	26
COMPUTER SET: DIGITAL AN/GYK-62B (BFT TOC KIT)-----	2
RADIO SET: HAND-HELD RADIO-----	5
POINT OF PRESENCE (POP) B-KIT (AN/MRC-150)-----	2
NETWORK MANAGEMENT SYSTEM: AN/TSC-188 (V)1 (NOSC-B)-----	1
SWITCHING GROUP DIGITAL DATA: OB-123/T (MCN-B)-----	1
COMPUTER SYSTEM DIGITAL: AN/TYQ-116(V)3 (AHR5)-----	8
COMMUNICATIONS SUBSYSTEM: AN/USQ-165-----	1

HHC, BEB, SBCT

05316R700
17/170/88

COMMAND SECTION PARA 01

COMPANY HEADQUARTERS PARA 02

MISSION: The headquarters provides command, control, and supervision of the tactical operations of the Brigade Engineer Battalion (BEB) and attached units. The headquarters company provides unit administration, information management, and logistical support for the battalion staff sections. It also provides administrative and medical support to organic and attached units.

FBCB2
AN/VAS-5
x2 NVG
DAGR
EPLRS
AN/VRC-92F
AN/PRC-119F
AN/UYK-128(V)3



LTC 12A00 CDR M4 M9
SGT 12B20 VEH CDR M4
PFC 12B10 DRIVER M4

FNCN2
x2 NVG
DAGR
EPLRS
AN/VRC-92F
AN/UYK-128(V)3



*LTC 12A00 CDR M4 M9
CSM 12A60 CSM M4 M9
*WHEN NOT ON STRYKER

FNCN2
x2 NVG
DAGR
EPLRS
AN/VRC-92F
AN/UYK-128(V)3



MAJ 01A00 BN XO M4 M9
SPC 12B10 DRIVER M4

FBCB2
AN/VAS-5
x2 NVG
DAGR
EPLRS
AN/VRC-90F
AN/UYK-128(V)3



CPT 01A00 CDR M4 M9
SFC 12B40 OPS SGT
PFC 12B10 DRIVER M4

x2 NVG
DAGR
EPLRS
AN/VRC-90F
AN/TYQ-109(V)1
OL-701/TYQ



1LT 12A00 OPS OFF M4
1SG 12Z5M 1SG M4
SSG 92Y30 SUPPLY SGT M4
SPC 92Y10 SUPPLY SPC M4

SUSTAINMENT - S1 PARA 03

MAIN CP - INTEL/S2 PARA 04

MAIN CP OPS - OPS/S3 PARA 05

SUSTAINMENT - S4 PARA 06

x2 NVG
DAGR
EPLRS
AN/VRC-90F



CPT 42B00 CPT S1 OFF M4
SFC 42A40 SR HR SGT M4
SSG 42A30 HR SGT M4
SGT 27D20 PARALEGAL SGT M4
SGT 42A20 HR SGT M4
X2 SPC 42A10 HR SP M4
X2 PFC 42A10 HR SP M4

OL-701A/TYQ
x4 AN/TYQ-116(V)3

AN/VRC-92F
AN/VRC-104(V)3
AN/UYK-128(V)3
FBCB2
AN/VAS-5
x2 NVG
DAGR
EPLRS



CPT 35D00 INTEL OFF S2 M4
SFC 35F40 SR INTEL SGT M4
SSG 29E30 EW NCO M4
PFC 35F10 INTEL ANLST M4

FBCB2
2X NVG
DAGR
EPLRS
AN/VRC-92F

AN/TYQ-93
AN/UYK-128(V)3
AN/TYQ-137B(V)3
HWTS
.50 CAL



1LT 12A00 ASST S2 OFF M4
MSG 12Z50 INTEL SGT M4
SFC 74D40 CBRN STAFF NCO M4
SGT 29E20 ELEC WARFARE NCO M4
SPC 35F10 INTEL ANLST M4

AN/VRC-92F
AN/VRC-104(V)3
AN/UYK-128(V)3
FBCB2
AN/VAS-5
x2 NVG
DAGR
EPLRS



MAJ 12A00 S3 M4 M9
SFC 12B40 ASST OPS SGT M4
PFC 12B10 DRIVER M4
SSG 12B30 ASST PLANS SGT M4

x2 NVG FBCB2
x2 DAGR EPLRS
AN/VRC-91F

SSG 12T30 TECH EN SGT M4
SPC 12T10 TECH EN SPC M4

AN/VRC-92F
AN/VRC-90F
AN/UYK-128(V)3
x2 AN/TYQ-137B(V)3
AN/PRC-150 HF RADIO
FHMUX
KOI-18/TSEC
.AN/PSC-5



CPT 12A00 CONST ENGR M4
CPT 12A00 PLANS OFF M4
W2 120A0 CONST EN TECH M4
SSG 12N30 CONSTRUC FOREMAN M4

FBCB2
AN/VAS-5
x2 NVG
DAGR
AN/UYQ-90(V)3



CPT 01A00 ASST PLANS OFF M4
MSG 11Z50 OPS SGT M4
SFC 12H40 CONST SGT M4
SSG 12B30 RECON SGT M4
SSG 12H30 ASST CONST SGT M4

AN/VAS-5
x2 NVG
DAGR
AN/VRC-92F
AN/UYQ-90(V)3



1LT 12A00 RECON OFF M4
SSG 12B30 RECON SGT M4

DAGR
EPLRS
FBCB2
AN/VRC-92F



CPT 12A00 S4 OFF M4
SGT 92Y10 SUPPLY NCO M4

AN/TSC-183
KOI-18/TSEC
AN/TYQ-109(V)1
AN/UYQ-90(V)3

OL-701A/TYQ
x2 AN/TYQ-129(V)2
AN/TYQ-137B(V)3



SFC 92Y40 SR SUPPLY SGT M4
SPC 92Y10 SUPPLY SP M4

HHC, BEB, SBCT

SUSTAINMENT – C4 OPS/S6 PARA 07

SUST - MED SUPPORT SECT PARA 08

SUSTAINMENT – UMT PARA 09

CBRN RECCE PLATOON PARA 10

DAGR
AN/PYQ-12
AN/TSQ-243
AN/GYK-50A
AN/TSR-8 (GRT)
AN/TYQ-137B(V)3
AN/GYK-50B(SYSCON)(V)4
AN/TSQ-259
AN/GYK-62B



CPT 25A00 S6 OFF M4
SGT 25U20 FWD SIG SPT NCO M4

x2 NVG
DAGR
AN/VAS-5
AN/VRC-92F
AN/UUYQ-90(V)3



PU - 798
SFC 25U40 SECT CHIEF M4
SSG 25U30 SIG INFO SVE NCO M4
SPC 25U10 SIG SPT SYS SPC M4
PFC 25U10 SIG SPT SYS SPC M4
SPC 25B10 LAN MGR M4
PFC 25B10 LAN MGR M4

x2 NVG DAGR
EPLRS
AN/VRC-90F
AN/TYQ-107(V)1
AN/TYQ-106(V)1
x6 AN/TYQ-105(V)01
OL-701/TYQ



CPT 65D00 PHYSICIAN ASST M9
SFC 68W40 HEALTH CARE NCO M4
X2 SSG 68W30 HEALTH CARE SGT M4
X2 SPC 68W10 COMBAT MEDIC M9
PFC 68W10 HEALTH CARE SP M4

x2 NVG
DAGR
PLRS
AN/VRC-90F
AN/TYQ-128(V)3
x2 AN/TYQ-105(V)1



x2
SGT 68W20 EMER CARE SGT M9
SGT 68W20 EMER CARE SGT M9
X2 SPC 68W10 AMB AIDE/DRIVER M4
X2 PFC 68W10 AMB AIDE/DRIVER M4

x2 NVG
EPLRS
AN/VRC-90F



CPT 56A00 CHAPLAIN
SGT 56M20 CHAP ASST M4

FBCB2 x2 NVG
EPLRS FHMUX
AN/VRC-89F
AN/VRC-90F
AN/UYK-128(V)3
ON-721/V DAGR



x3

1LT 74A00 PLT LDR M4
SGT 74D20 ASST TM LDR M4
SPC 74D10 CBRN SP M249
PFC 74D10 CBRN SP M4

SFC 74D40 PLT SGT M4
SSG 74D30 TEAM LDR M4
X2 SGT 74D20 ASST TM LDR M4
X2 SPC 74D10 CBRN SPC M249
X2 PFC 74D10 CBRN SPC M4

EQUIPMENT SUMMARY

WEAPONS

L69080	LAUNCHER GRENADE: M320A1	4
L91701	MACHINE GUN CALIBER .50: HEAVY FIXED TURRET TYPE	6
M09009	MACHINE GUN 5.56 MILLIMETER: M249	6
M39263	MACHINE GUN: LIGHT 5.56MM M249	4
M92362	MACHINE GUN GRENADE 40MM: MK19 MOD III	1
M92841	MACHINE GUN: 7.62MM M240B	2
P98152	PISTOL 9MM AUTOMATIC: M9	10
R97234	RIFLE 5 56 MILLIMETER: M4	75
S40541	SHOTGUN: 12 GAGE	3
Z00686	MACHINE GUN: CALIBER .50	7

VEHICLES, TRAILERS AND TRLR MTD SYSTEMS

A93374	ARMORED SECURITY VEHICLE: WHEELED W/MOUNT (ASV)	6
G53778	GENERATOR SET DIESEL ENGINE TM: PU-798	1
P63462	POWER PLANT: UTILITY (MEDIUM)	2
T37588	TRUCK UTILITY EXPANDED CAPACITY ENHANCED: M1152A1	7
T38844	TRUCK AMBULANCE: 4 LITTER ARMD 4X4 W/E (HMMWV)	2
T41135	TRUCK CARGO: MTV W/E W/W	1
T56383	TRUCK UTILITY EXPANDED CAPACITY ENHANCED 4X4: M1165A1	8
T60081	TRUCK CARGO: 4X4 LMTV W/E	5
T61704	TRUCK CARGO: MTV LWB W/E	1
T61908	TRUCK CARGO: MTV W/E	3
T95924	TRAILER CARGO: HIGH MOBILITY 1-1/4 TON	1
T95992	LIGHT TACTICAL TRAILER: 3/4 TON	4
U31832	UNMANNED GROUND VEHICLE TRACKED: XM216	3
U65480	TRAILER TANK WATER (CAMEL): 400 GAL 5 TON W/E	2

VEHICLES, TRAILERS AND TRLR MTD SYSTEMS

NIGHT VISION/OBSERVATION

J03261	ILLUMINATOR: INFRARED	58
J68403	INTEGRATED LASER WHITE POINTER (ILWLP): AN/PEQ-14	42
M79678	MONOCULAR NIGHT VISION DEVICE: AN/PVS-14	15
N05482	NIGHT VISION: GOGGLE	88
N07848	NIGHT VISION DEVIC: AN/PSQ-20	14
S60356	SIGHT: THERMAL AN/PAS-13B(V)1	28
S90535	MEDIUM WEAPON THERMAL SIGHT (MWTS): AN/PAS-13(V)2	4
S90603	HEAVY WEAPON THERMAL SIGHT (HWTS): AN/PAS-13(V)3	8

NIGHT VISION/OBSERVATION

J03261	ILLUMINATOR: INFRARED	58
J68403	INTEGRATED LASER WHITE POINTER (ILWLP): AN/PEQ-14	42
M79678	MONOCULAR NIGHT VISION DEVICE: AN/PVS-14	15

COMMUNICATIONS AND ELECTRONICS

A35329	ALL SOURCE ANALYSIS SYSTEM: AN/TYQ-93	1
C18277	COMPUTER SET: DIGITAL AN/TYQ-107(V)1	1
C18278	COMPUTER SYSTEM: DIGITAL AN/UUYQ-90(V)2	13
C18345	COMPUTER SET: DIGITAL AN/TYQ-106(V)1	1
C18378	COMPUTER SET: AN/UYK-128(V)3	17
C18641	COMPUTER SYST DIGITAL: AN/PYQ-12	1
C19266	COUNTER ELECTRONIC DIGITAL READOUT: AN/USM-459	1
C27435	COMPUTER SYSTEM: DIGITAL AN/TYQ-129(V)2	1
C27503	COMPUTER SYSTEM: DIGITAL AN/TYQ-105(V)1	12
C27707	COMPUTER SYSTEM: DIGITAL AN/TYQ-109(V)1	2
C27963	COMPUTER SYSEM: DIGITAL	5
C61665	COMMAND CENTER SYSTEM: AN/TSQ-243	1
C78851	COMPUTER SYSTEM: DIGITAL AN/UUYQ-90(V)3	1
J54771	INTERCONNECT GROUP: ON-721/V	2
N96248	NAVIGATION SET: SATELLITE SIGNALS AN/PSN-13	30
P49587	PJH SURFACE VEHICLE RADIO SET: AN/VSQ-2(V)	36
P99881	PROCESSOR GROUP SIG DATA: (CAISI 2.0) OL-701A/TYQ	5
R36178	RADIO TEST: SET AN/GRM-122	1
R44999	RADIO SET: AN/VRC-89F(C)	4
R45543	RADIO SET: AN/VRC-92F(C)	8
R57606	RADIO SET: AN/PSC-5	1
R68044	RADIO SET: AN/VRC-90F(C)	13
R68146	RADIO SET: AN/VRC-91F(C)	3
R87139	RADIO ST: AN/VRC-104(V)3 150 WATT W/PRC-150 HF RADIO	2
R93169	RADIO TEST SET: AN/PRM-34)	3
T40405	TAPE READER GENERAL PURPOSE: KOI-18/TSEC	2
Z00384	COMPUTER SYSTEM DIGITAL: AN/PYQ-10(C)	29
Z00512	COMPUTER SYSTEM DIGITAL: AN/GYK-50A (ISYSCON) (V)4	1
Z00513	COMPUTER SYSTEM DIGITAL: AN/GYK-50B (ISYSCON) (V)4	1
Z00560	INTERFACE UNIT COMMUNICATION EQUIPMENT: OL-713(V)1/TYQ CSS VSAT	1
Z00930	COMMUNICATIONS SUBSYSTEM: AN/TSQ-259	1
Z01162	COMPUTER SYSTEM: DIGITAL AN/TYQ-139	1
Z01320	RADIO SET: AN/PRC-148 (V) 4 URBAN JEM	30
Z39781	ARMY H RESURCES: WRKSTATION	2

MISC EQUIPMENT

B49004	BAYONET MULTIPURPOSE SYSTEM: XM9	77
C05701	MONITOR CHEMICAL AGENT:	5
G18358	GEN SET: DED SKID MTD 3KW 60HZ	3
G40175	GENERATOR SWEEP: SG-1206/U	2
M12986	MASK CHEMICAL BIOLOGICAL JOINT SERVICE GENERAL PURPOSE: FIELD M50	82
M13236	MASK CHEMICAL-BL-GCL JNT SRV GNL PRPSE: CMBT VHL CRWMN M51	15
N83206	PERSONNEL IDENTIFICATION BAND KIT: W/COMP (PRISONER OF WAR USE)	4
Z01330	GEN SET DED 10KW 50/60HZ: SKID-MTD	2
T57382	SMALL UNMANNED AIRCRAFT SYSTEM (SUAS): RAVEN B (MIP)	1

ENGINEER COMPANY, SBCT

MISSION.

**To provide organic mobility, force protection,
limited countermobility, survivability and
sustainment engineering to the Brigade Combat
Teams.**

COMBAT ENGINEER COMPANY, BEB, SBCT

05319R700
4/0/91//95

COMPANY HEADQUARTERS PARA 01

FBCB2
STORM
X2 DAGR
EPLRS-V1
AN/VRC-92F
AN/UJK-128(V)1
HWTS
.50 CAL



CPT 12A00 CDR M4 M9 ILLUM NVG
AN/MRC-149
SGT 25U20 FWD SIG SPT NCO M4
NVG
SGT 12B20 VEH CDR M4 NVG
PFC 12B10 VEH DRIVER M4



1LT 12A00 EXEC OFF M4
NVG AN/PRC-119F
SFC 12B40 OPS SGT M4 NVG

FBCB2
STORM
DAGR
EPLRS-V1
AN/VRC-92F
AN/UJK-128(V)1
AN/TYQ-139
AN/TYQ-137B(V)3
OL-701A/TYQ

FBCB2
DAGR
EPLRS-V1
AN/VRC-90F
AN/PRC-119F
AN/UJK-128(V)1



*CPT 12A00 CDR M4 M9
1SG 12Z5M 1SG M4 NVG
*WHEN NOT MOUNTED
ON STRYKER
AN/VRC-90F
AN/TYQ-116(V)3



SSG 92Y30 SUPPLY SGT M4 NVG
SPC 92Y10 SUPPLY SP M4 NVG

COMBAT MOBILITY PLATOON PARA 02

FBCB2
STORM
X2 DAGR
EPLRS-V1
AN/VRC-91F
AN/VRC-90F
AN/PRC-119F
X2 AN/PRC-148(V)4



1LT 12A00 PLT LDR M4 ILLUM ENVG
SGT 12B20 VEH CDR M4 NVG
SPC 12B10 CBT ENG M4 NVG
SPC 12B10 HVY VEH DRR M4 NVG

x2



SPC 12B10 HVY VEH DRR M4 NVG



SPC 12B10 HVY VEH DRR M4 NVG

FBCB2
MK-19
DAGR
X2 EPLRS-V1
AN/VRC-89F
AN/PRC-119F
AN/UJK-128(V)1
HWTS



SFC 12B40 PLT SGT M4 ILLUM ENVG
SPC 12B10 GUNNER M4
PFC 12B10 DVR M4 NVG

x2



COMBAT ENGINEER SQUAD PARA 03

FBCB2
AN/VAS-5
STORM
M240L
x2 DAGR
x6 LMR
EPLRS-V1
AN/VRC-91F

LWTS
HWTS
.50 CAL
AN/PRC-148(V)4
AN/UJK-128(V)1



Talon Robot

SSG 12B30 SQD LDR M4 ILLUM ENVG
SGT 12B20 TEAM LDR M4 SHOTGUN ILLUM ENVG
SGT 12B20 TEAM LDR M4 SHOTGUN ILLUM ENVG
SGT 12B00 VEH CDR M4 ILLUM NVG
PFC 12B10 VEH DVR M4 ILLUM NVG
SPC 12B10 CBT ENG M4249 ILLUM ENVG
SPC 12B10 CBT ENG M4249 ILLUM ENVG
PFC 12B10 CBT ENG M4 ILLUM NVG
PFC 12B10 CBT ENG M4 ILLUM NVG

x6

BRIDGE SECTION PARA 04

FBCB2 X2 DAGR
AN/VAS-5 EPLRS-V1
AN/VRC-91F HWTS
AN/UJK-128(V)1
.50 CAL



SSG 12C30 SEC LDR M4 NVG
PFC 12C10 BRIDGE CREWMBR M4 NVG

X2 DAGR
EPLRS-V1
AN/VRC-91F



SGT 12C20 BGE CREW CHIEF M4 NVG
SPC 12C10 BGE CREWMBR M4 NVG

HORIZONTAL CONST SQUAD PARA 05

FBCB2 DAGR
EPLRS HWTS
AN/VRC-90F
AN/PRC-119F
AN/UJK-128(V)3



x2

SSG 12N30 SQUAD LDR M4 NVG
SGT 12N20 HVY VEH DRIVER M4 NVG
SPC 12N10 HORIZ CONST ENG M4 NVG
SPC 12N10 HORIZ CONST ENG M4 NVG AN/PRC-119F
PFC 12N10 HORIZ CONST ENG M4 NVG AN/PRC-119F
PFC 12N10 HORIZ CONST ENG M4 NVG AN/PRC-119F

DAGR
AN/PRC-119F



x2

AN/PRC-119F
DAGR



x2

SGT 12N20 HVY VEH DRIVER M4 NVG
X3 SPC 12B10 HVY VEH DRIVER M4 NVG
SGT 12N20 HORIZ CONST SGT M4 NVG AN/PRC-119F
SGT 12N20 HORIZ CONST SGT M4 NVG AN/PRC-119F
SPC 12N10 HORIZ CONST ENG M4 NVG AN/PRC-119F
SPC 12N10 HORIZ CONST ENG M4 NVG AN/PRC-119F

AN/VRC-90F
AN/UJK-128(V)3
DAGR



AN/PRC-119F
DAGR



EQUIPMENT SUMMARY

WEAPONS

C60750	COMMAND LAUNCH UNIT: (JAVELIN) 13305405-119	4
L69080	LAUNCHER GRENADE: M320A1	22
M09009	MACHINE GUN 5.56 MILLIMETER: M249	18
M92362	MACHINE GUN GRENADE 40MM: MK19 MOD III	4
M92454	MACHINE GUN 7.62 MILLIMETER: M240L	9
M92841	MACHINE GUN: 7.62MM M240B	4
P98152	PISTOL 9MM AUTOMATIC: M9	5
R97234	RIFLE 5 56 MILLIMETER: M4	120
S40541	SHOTGUN: 12 GAGE	18
Z00686	MACHINE GUN: CALIBER .50	14

VEHICLES, TRAILERS AND TRLR MTD SYSTEMS

B24592	BRIDGE FIXED: RAPIDLY	4
D30897	DISPENSER MINE: M139 (HTLD)	3
E02807	CHASSIS TRAILER: GENERATOR 2-1/2 TON 2 WHEEL W/E	6
J22626	INFANTRY CARRIER: VEHICLE (ICV)	1
J97621	ENGINEER SQUAD VEHICLE: (ESV)	12
L67342	LAUNCHER MINE CLEARING LINE CHARGE TRAILER MOUNTING: (MICLIC)	2
T34704	TRUCK UTILITY: ECV ARMAMENT CARRIER W/IAP ARMOR BODY M1151A1	1
T37588	TRUCK UTILITY EXPANDED CAPACITY ENHANCED: M1151A1	1
T41515	TRUCK CARGO: 5 TON WO/WINCH	2
H53576	HIGH MOBILITY ENG EXCAVATOR (HMEE): TYPE I	2
T76541	TRACTOR FULL TRACKED HIGH SPEED: DEPLOYABLE LT ENGINEER (DEUCE)	6
T91308	TRANSPORTER COMMON BRIDGE:	4
T93761	TRAILER: PALLETIZED LOADING 8X20	10
T95924	TRAILER CARGO: HIGH MOBILITY 1-1/4 TON	4
T96496	TRUCK CARGO: TACTICAL 8X8 HEAVY EXPANDED MOB W/LHS	6
Z36683	TRAILER TANK WATER (CAMEL): 800 GAL 5 TON W/E	1

NIGHT VISION/OBSERVATION

D41659	DRIVERS ENHANCERS: AN/VAS-5	19
J03261	ILLUMINATOR: INFRARED	88
J68653	ILLUMINATOR INTEGRATED: SMALL ARMS STORM MLRF	13
M79678	MONOCULAR NIGHT VISION DEVICE: AN/PVS-14	35
N05482	NIGHT VISION: GOGGLE	62
N07848	NIGHT VISION DEVIC: AN/PSQ-20	51
S60356	SIGHT: THERMAL AN/PAS-13B(V)1	9
S90535	MEDIUM WEAPON THERMAL SIGHT (MWTS): AN/PAS-13(V)2	13
S90603	HEAVY WEAPON THERMAL SIGHT (HWTS): AN/PAS-13(V)3	24

COMMUNICATIONS AND ELECTRONICS

C18345	COMPUTER SET: DIGITAL AN/TYQ-106(V)1	1
C18378	COMPUTER SET: AN/JYK-128(V)3	35
C27503	COMPUTER SYSTEM: DIGITAL AN/TYQ-105(V)1	4
C27707	COMPUTER SYSTEM: DIGITAL AN/TYQ-109(V)1	1
C27838	COMPUTER SYS DIGITAL: AN/TYQ-139	1
C60750	COMMAND LAUNCH UNIT: (JAVELIN) 13305405-119	4
C67436	COMPTER SYSTEM DIGITAL: AN/PYQ-6C	1
N96248	NAVIGATION SET: SATELLITE SIGNALS AN/PSN-13	64
P49587	PJH SURFACE VEHICLE RADIO SET: AN/VSQ-2(V)	35
P99881	PROCESSOR GROUP SIG DATA: (CAISI 2.0) OL-701A/TYQ	1
R44999	RADIO SET: AN/VRC-89F(C)	9
R45543	RADIO SET: AN/VRC-92F(C)	2
R68044	RADIO SET: AN/VRC-90F(C)	15
R68146	RADIO SET: AN/VRC-91F(C)	14
R83141	RADIO SET: AN/PRC-119F(C)	11
R93169	RADIO TEST SET: AN/PRM-34()	2
Z0062	TABLE READER GENERAL PURPOSE: KOI-18/TSEC	2
Z0062	COMPUTER SYSTEM DIGITAL: AN/PYQ-10(C)	49
Z0062	LAN MOBILE RADIO: (LMR)	58
Z0062	RADIO SET: AN/PRC-148 (V) 4 URBAN JEM	15
Z39781	ARMY H RESURCES: WRKSTATION	1

MISC EQUIPMENT

C05701	MONITOR CHEMICAL AGENT:	10
G11966	GEN SET: DED SKID MTD 5KW 60HZ	1
P10842	PLOW: MINE CLEARING	3
P15852	PLOW MINE CLEARING FOR ENG SQD VEHICLE: XM1132	3
R19752	ROLLER: MINE CLEARING	9
R20684	RADIAC SET: AN/VDR-2	15
R30925	RADIAC SET: AN/PDR-75	1
R31061	RADIAC SET: AN/UDR-13	17
S44890	STRAIGHT OBSTACLE BLADE FOR ENG SQD VECH: XM1132	3

COMBAT ENGINEER COMPANY, BEB, SBCT

05329R700
5/0/82//87

COMPANY HEADQUARTERS PARA 01

FBCB2 M257
MG 7.62 RH FEED
DAGR EPLRS
AN/VRC-92F
2X M:



CPT 12A00 CDR M4 M9
AN/PRC-119F
SFC 12B40 OPS SGT M4 NVG
PFC 12B10 VEH DRV M4
SGT 12B20 VEH CDR M4

AN/TYQ-109(V)1 DAGR
OL-701A/TYQ AN/VRC-90F
HWTS AN-700/TYQ
3X JAVELIN AN/PYQ-6C
KOI-18/TSEC

FBCB2 X2 NVG
M259 .50 CAL
DAGR EPLRS
AN/VRC-92F
HWTS



CPT 12B00 CDR M4 M9
1LT 12A00 OPS OFF M4
SGT 25U20 FWD SIG SPT NCO M4 NVG
*WHEN NOT MOUNTED ON STRYKER



1SG 12Z5M 1SG M4 NVG
SSG 92Y30 SUPPLY SGT M4 NVG
SPC 92Y10 SUPPLY SP M4 NVG

ENGINEER PLT HQ PARA 02

FBCB2 M257
MG 7.62 RH FEED
DAGR
EPLRS
AN/VRC-89F
2X M231
AN/PRC-148



1LT 12A00 PLT LDR M4
SGT 12B20 VEH CDR M4
X2 SPC 12B10 HVY VEH DRV M4
SPC 12B10 COMBAT ENGR M4

FBCB2 MK-19
DAGR
EPLRS
AN/VRC-89F
HWTS
AN/PRC-148(V)4



SFC 12B40 PLT SGT M4
PFC 12B10 DRIVER M4



SPC 12B10 HVY VEH DRR M4 NVG



SPC 12B10 HVY VEH DRR M4 NVG

ENGINEER SQUAD PARA 03

FBCB2 M257
MG 7.62 RH FEED
DAGR
EPLRS
AN/VRC-89F
2X M231
AN/PRC-148(V)4



SSG 12B30 SQD LDR M4 ILLUM ENVG
SGT 12B20 VEH CDR M4 NVG
SGT 12B20 TM LDR M4 ILLUM ENVG
SGT 12B20 TM LDR M4 ILLUM ENVG
X2 SPC 12B10 CBT ENG M4 ILLUM ENVG
X2 SPC 12B10 CBT ENG M320 ILLUM ENVG
PFC 12B10 VEH DRIVER M4 ILLUM ENVG

M240L
SHOTGUN
LWTS
MWTS
AN/PLQ-8

Talon Robot

x3

ENGR SUPPORT PLT HQ PARA 04

FBCB2 DAGR
EPLRS
AN/VRC-89F
AN/UJK-128(V)3
AN/PRC-148(V)4



2LT 12A00 PLT LDR M4 ILLUM ENVG
PFC 12B10 VEH DRIVER M4 NVG

FBCB2 DAGR
EPLRS
AN/VRC-89F
AN/UJK-128(V)3
AN/PRC-148(V)4



SFC 12B40 PLT SGT M4 ILLUM ENVG
PFC 12B10 VEH DRIVER M4 NVG

BRIDGE SECTION PARA 05

FBCB2 X2 DAGR
AN/VAS-5 EPLRS-V1
AN/VRC-91F HWTS
AN/UJK-128
.50 CAL



SSG 12C30 SEC LDR M4 NVG
PFC 12C10 BRIDGE CREWMBR M4 NVG

X2 DAGR
EPLRS-V1
AN/VRC-91F



SGT 12C20 BGE CREW CHIEF M4 NVG
SPC 12C10 BGE CREWMBR M4 NVG

HORIZONTAL SQUAD PARA 06

FBCB2 DAGR
EPLRS HWTS
AN/VRC-90F
AN/VRC-119F
AN/UJK-128(V)3



X2

AN/PRC-119F
DAGR



X2

SSG 12N30 SQUAD LDR M4 NVG
X2 SGT 12N20 HVY VEH DRIVER M4 NVG
X2 SGT 12N20 HORIZ CONST SGT M4 NVG AN/PRC-119F
X3 SPC 12N10 HVY VEH DRIVER M4 NVG
SPC 12N10 HORIZ CONST ENG M4 NVG AN/PRC-119F
X2 SPC 12N10 HORIZ CONST ENG M4 NVG AN/PRC-119F
X2 PFC 12N10 HORIZ CONST ENG M4 NVG AN/PRC-119F



AN/VRC-90F
AN/UJK-128(V)3
DAGR

AN/PRC-119F
DAGR



DAGR
AN/PRC-119F



X3



CLEARANCE PLT HQ PARA 07 (X2) CLEARANCE SQUAD PARA 08

FBCB2 DAGR
EPLRS
AN/VRC-91F
AN/UJK-128(V)3
AN/PRC-148(V)4



x2

2LT 12A00 PLT LDR M4 ILLUM ENVG
SFC 12B40 PLT SGT M4 ILLUM ENVG
X2 SPC 12B10 COMBAT ENGR M4 NVG
X2 PFC 12B00 VEH DRIVER M4 NVG



Talon Robot

FBCB2 DAGR
EPLRS
AN/VRC-91F



DAGR EPLRS
FBCB2
AN/VRC-90F



DAGR
AN/VRC-90F



DAGR
AN/VRC-90F



SSG 12B30 SQD LDR M4 ILLUM ENVG
SGT 12B20 TM LDR M4 ILLUM ENVG
SGT 12B20 TM LDR M4 ILLUM ENVG
SPC 12B10 VMMD OPR M4
SPC 12B10 CBT ENG M4 ILLUM ENVG
SPC 12B10 CBT ENG M4 ILLUM ENVG
PFC 12B10 VEH DRIVER M4 ILLUM ENVG
PFC 12B10 VEH DRIVER M4 ILLUM ENVG

x2

EQUIPMENT SUMMARY

WEAPONS

C60750	COMMAND LAUNCH UNIT: (JAVELIN) 13305405-119	4
L69080	LAUNCHER GRENADE: M320A1	22
M09009	MACHINE GUN 5.56 MILLIMETER: M249	18
M92362	MACHINE GUN GRENADE 40MM: MK19 MOD III	4
M92454	MACHINE GUN 7.62 MILLIMETER: M240L	9
M92841	MACHINE GUN: 7.62MM M240B	4
P98152	PISTOL 9MM AUTOMATIC: M9	5
R97234	RIFLE 5 56 MILLIMETER: M4	120
S40541	SHOTGUN: 12 GAGE	18
Z00686	MACHINE GUN: CALIBER .50	14

VEHICLES, TRAILERS AND TRLR MTD SYSTEMS

B24592	BRIDGE FIXED: RAPIDLY	4
D30897	DISPENSER MINE: M139 (HTLD)	3
E02807	CHASSIS TRAILER: GENERATOR 2-1/2 TON 2 WHEEL W/E	6
J22626	INFANTRY CARRIER: VEHICLE (ICV)	1
J97621	ENGINEER SQUAD VEHICLE: (ESV)	12
L67342	LAUNCHER MINE CLEARING LINE CHARGE TRAILER MOUNTING: (MICLIC)	2
T34704	TRUCK UTILITY: ECV ARMAMENT CARRIER W/IAP ARMOR BODY M1151A1	1
T37588	TRUCK UTILITY EXPANDED CAPACITY ENHANCED: M1151A1	1
T41515	TRUCK CARGO: 5 TON WO/WINCH	2
H53576	HIGH MOBILITY ENG EXCAVATOR (HMEE): TYPE I	3
T76541	TRACTOR FULL TRACKED HIGH SPEED: DEPLOYABLE LT ENGINEER (DEUCE)	6
T91308	TRANSPORTER COMMON BRIDGE:	4
T93761	TRAILER: PALLETIZED LOADING 8X20	10
T95924	TRAILER CARGO: HIGH MOBILITY 1-1/4 TON	4
T96496	TRUCK CARGO: TACTICAL 8X8 HEAVY EXPANDED MOB W/LHS	6
Z36683	TRAILER TANK WATER (CAMEL): 800 GAL 5 TON W/E	1

NIGHT VISION/OBSERVATION

D41659	DRIVERS ENHANCERS: AN/VAS-5	19
J03261	ILLUMINATOR: INFRARED	88
J68653	ILLUMINATOR INTEGRATED: SMALL ARMS STORM MLRF	13
M79678	MONOCULAR NIGHT VISION DEVICE: AN/PVS-14	35
N05482	NIGHT VISION: GOGGLE	62
N07848	NIGHT VISION DEVIC: AN/PSQ-20	51
S60356	SIGHT: THERMAL AN/PAS-13B(V)1	9
S90535	MEDIUM WEAPON THERMAL SIGHT (MWTS): AN/PAS-13(V)2	13
S90603	HEAVY WEAPON THERMAL SIGHT (HWTS): AN/PAS-13(V)3	24

COMMUNICATIONS AND ELECTRONICS

C18345	COMPUTER SET: DIGITAL AN/TYQ-106(V)1	1
C18378	COMPUTER SET: AN/JYK-128(V)3	35
C27503	COMPUTER SYSTEM: DIGITAL AN/TYQ-105(V)1	4
C27707	COMPUTER SYSTEM: DIGITAL AN/TYQ-109(V)1	1
C27838	COMPUTER SYS DIGITAL: AN/TYQ-139	1
C60750	COMMAND LAUNCH UNIT: (JAVELIN) 13305405-119	4
C67436	COMPTER SYSTEM DIGITAL: AN/PYQ-6C	1
N96248	NAVIGATION SET: SATELLITE SIGNALS AN/PSN-13	64
P49587	PJH SURFACE VEHICLE RADIO SET: AN/VSQ-2(V)	35
P99881	PROCESSOR GROUP SIG DATA: (CAISI 2.0) OL-701A/TYQ	1
R44999	RADIO SET: AN/VRC-89F(C)	9
R45543	RADIO SET: AN/VRC-92F(C)	2
R68044	RADIO SET: AN/VRC-90F(C)	15
R68146	RADIO SET: AN/VRC-91F(C)	14
R83141	RADIO SET: AN/PRC-119F(C)	11
R93169	RADIO TEST SET: AN/PRM-34()	2
Z0062	TABLE READER GENERAL PURPOSE: KOI-18/TSEC	2
Z0062	COMPUTER SYSTEM DIGITAL: AN/PYQ-10(C)	49
Z0062	LAN MOBILE RADIO: (LMR)	58
Z0062	RADIO SET: AN/PRC-148 (V) 4 URBAN JEM	15
Z39781	ARMY H RESURCES: WRKSTATION	1

MISC EQUIPMENT

C05701	MONITOR CHEMICAL AGENT:	10
G11966	GEN SET: DED SKID MTD 5KW 60HZ	1
P10842	PLOW: MINE CLEARING	3
P15852	PLOW MINE CLEARING FOR ENG SQD VEHICLE: XM1132	3
R19752	ROLLER: MINE CLEARING	9
R20684	RADIAC SET: AN/VDR-2	15
R30925	RADIAC SET: AN/PDR-75	1
R31061	RADIAC SET: AN/UDR-13	17
S44890	STRAIGHT OBSTACLE BLADE FOR ENG SQD VECH: XM1132	3

BRIGADE SIGNAL COMPANY, BEB, BCT 11307R100 3/0/42/145

COMPANY HEADQUARTERS PARA 01 SMALL CMD POST SUPPORT TM PARA 02 RETRANSMISSION TM PARA 03

MISSION: To provide 24-hour operational Command, Control, Communications, Computer, Intelligence, Surveillance, and Reconnaissance (C4ISR) signal systems network to the supported Brigade Combat Team, which includes deploying, installing, operating, and maintaining these systems.

FBCB2 AN/VAS-5
2X NVG DAGR
EPLRS MK-19
AN/VRC-92F
AN/VRC-104(V)3
HWTS
KOI-18/TSEC



CPT 25A00 CDR M4 M9
1SG 25U5M 1SG M4

FBCB2 X2 NVG
DAGR EPLRS
AN/VAS-5
AN/VRC-89F



SGT 25Q20 SR XMSN SYS OPR-MNT M4
SPC 25Q10 XMSN SYS OPR-MNT M4

FBCB2 x2 NVG
DAGR EPLRS
AN/VAS-5
X3 AN/VRC-92F



SGT 25U20 TEAM CHIEF M4
SPC 25U10 RETRANS OPR M4
PFC 25U10 RETRANS OPR M249

FBCB2 AN/VAS-5
MK-19
2X NVG
DAGR
EPLRS
AN/VRC-90F
HWTS



SGT 92Y20 SUPPLY NCO M4
SPC 92Y10 SUPPLY SP M320

AN/VAS-5
2X NVG
DAGR
AN/VRC-90F



SPC 25Q10 XMSN SYS OPR-MNT M4
SPC 25N10 NODAL NT SYS OPR-MNT M4
PFC 25N10 NODAL NT SYS OPR-MNT M4
PFC 25Q10 XMSN SYS OPR-MNT M249

x2 PLT HQ PARA 04

FBCB2 2X NVG
DAGR EPLRS
AN/VAS-5
AN/VRC-90F
AN/VRC-104(V)3
KOI-18/TSEC



1LT 25A00 PLT LDR M4
SFC 25W40 PLT SGT M4

x2

(X2) JOINT NTRWK NODE/SMART-T TM PARA 05

FBCB2 AN/VAS-5
2X NVG
DAGR
EPLRS
AN/VRC-90F



SGT 25N20 SR NODAL NT SYS OPR-MNT
PFC 25N10 NODAL NET SYS OPR M4

FBCB2 x2 NVG
AN/VAS-5 DAGR
EPLRS KSV-3
AN/VRC-90F
AN/TTC-59 (JNN)
AN/TYQ-122



SPC 25N10 NODAL NET SYS OPR-MNT M4

AN/VAS-5
2X NVG
DAGR
EPLRS
AN/VRC-90F



SPC 25S10 SATCOM SYS OPR-MNT M4
PFC 25S10 SATCOM SYS OPR-MNT M4

AN/VAS-5 2X NVG
AN/VRC-90F
MK-19 HWTS
AN/VRC-104(V)3



SPC 25Q10 RANGE EXT OPR M4

all Soldiers and equip x2

REPLACED BY WIN-T WHEN DOCUMENTED
HIGH CAP LINE OF SIGHT SECT PARA 06

AN/VAS-5 2X NVG
DAGR
AN/VRC-90F
AN/TRC-190(V)3



SGT 25Q20 SR XMSN SYS OPR M4
SPC 25Q10 XMSN SYS OPR M4
SPC 25Q10 XMSN SYS OPR M4
SPC 25Q10 XMSN SYS OPR M4
PFC 25Q10 XMSN SYS OPR M259

x2

RETRANSMISSION TEAM PARA 07

FBCB2
AN/VAS-5
DAGR
2X NVG
3X AN/VRC-92F



SGT 25U20 TEAM CHIEF M4
SPC 25U10 RETRANS OPR M4
PFC 25U10 RETRANS OPR M4

x2

EPLRS NETWORK MANAGER AND GATEWAY PARA 08

FBCB2 DAGR
X2 NVG EPLRS
AN/VAS-5 AN/VRC-90F
AN/GRC-229 KOI-18/TSEC
KOK-13/TSEC AN/TSQ-158



SGT 25C20 SR EGRU OPR M4
SP4 25C10 EGRU OPR M4

x2

Proposed upon deletion of EPLRS



SSG 25C30 ELPRS NCS SUPV M4
SP4 25C10 EPLRS NCS OPR M4
PFC 25C10 EPLRS NCS OPR M249

x2

NOTE: AN/UJK-128(V)1 (EPLRS-BASED) FBCB2 IS SHOWN IN THIS ANNEX (SBCT). IF THE UNIT HAS BFT-BASED FBCB2 (AN/UJK-128(V)3), EPLRS DOES NOT APPLY, NOR IS THE BRIGADE SIGNAL COMPANY EPLRS NETWORK MANAGER AND GATEWAY PARAGRAPH (PARA 08) DOCUMENTED ON THE MTOE.

EQUIPMENT SUMMARY

WEAPONS

L69080	LAUNCHER GRENADE: M320A1	8
M09009	MACHINE GUN 5.56 MILLIMETER: M249	6
M39263	MACHINE GUN: LIGHT 5.56MM M249	4
M92362	MACHINE GUN GRENADE 40MM: MK19 MOD III	4
P98152	PISTOL 9MM AUTOMATIC: M9	1
R97234	RIFLE 5 56 MILLIMETER: M4	50
Z00686	MACHINE GUN: CALIBER .50	2

VEHICLES, TRAILERS AND TRLR MTD SYSTEMS

C41314	COMMAND VARIANT VEH: (CV)	2
T37588	TRUCK UTILITY EXPANDED CAPACITY ENHANCED: M1152A1	16
T41515	TRUCK CARGO: 5 TON WO/WINCH	1
T56383	TRUCK UTILITY EXPANDED CAPACITY ENHANCED 4X4: M1165A1	8
T95924	TRAILER CARGO: HIGH MOBILITY 1-1/4 TON	2
T95992	LIGHT TACTICAL TRAILER: 3/4 TON	8
Z01414	LTT TRAILER-MTD: PU-2002/ 10 KW/ 50/60HZ	3
Z01420	LTT TRAILER-MTD: PU-2001/ 5 KW/ 50/60HZ	6
Z36683	TRAILER TANK WATER (CAMEL): 800 GAL 5 TON W/E	1

NIGHT VISION/OBSERVATION

A34938	AIMING LIGHT INFRARED: AN/PAQ-4	56
D41659	DRIVERS ENHANCERS: AN/VAS-5	25
J68653	ILLUMINATOR INTEGRATED: SMALL ARMS STORM MLRF	2
N05482	NIGHT VISION: GOGGLE	52
S90535	MEDIUM WEAPON THERMAL SIGHT (MWTS): AN/PAS-13(V)2	4
S90603	HEAVY WEAPON THERMAL SIGHT (HWTS): AN/PAS-13(V)3	6

COMMUNICATIONS AND ELECTRONICS

C18378	COMPUTER SET: AN/UUK-128(V)3	12
C27707	COMPUTER SYSTEM: DIGITAL AN/TYQ-109(V)1	1
E08940	ENCRYPTION-DECRYPTION EQUIPMENT: TACLANE KG 175	2
K47623	KY-99: MINTERM	2
N04580	NET CONTROL STATION: AN/TSQ-158	2
N96248	NAVIGATION SET: SATELLITE SIGNALS AN/PSN-13	20
P49587	PJH SURFACE VEHICLE RADIO SET: AN/VSQ-2(V)	16
P99881	PROCESSOR GROUP SIG DATA: (CAISI 2.0) OL-701A/TYQ	1
R44999	RADIO SET: AN/VRC-89F(C)	1
R45543	RADIO SET: AN/VRC-92F(C)	12
R68044	RADIO SET: AN/VRC-90F(C)	20
R78005	RADIO SET GRID REFERENCE UNIT: AN/VSQ-2 (N)4	2
R87139	RADIO ST: AN/VRC-104(V)3 150 WATT W/PRC-150 HF RADIO	6
R90451	RADIO TERMINAL: LINE OF SIGHT MULTI-C AN/TRC-190C(V)1	4
R90587	RADIO TERMINAL: LINE OF SIGHT MULTI-C AN/TRC-190C(V)3	2
R91580	RADIO TERMINAL SET: AN/GRC-229	6
S01373	SPEECH SECURITY EQUIPMENT: TSEC/KY-57	6
S24749	SWITCHING GROUP: DIGITAL DATA OA-9511/TYQ	2
T40405	TAPE READER GENERAL PURPOSE: KOI-18/TSEC	5
T43146	TELECONFERENCE SYS: AN/TYQ-122	2
T81733	TERMINAL: SATELLITE COMMUNICATION AN/TSC-154	2
Z00384	COMPUTER SYSTEM DIGITAL: AN/PYQ-10(C)	16
Z00562	JOINT NODE NETWORK (JNN) CENTRAL OFC TELEPHONE AUTOMATIC: AN/TTC	2
Z00564	BATTALION COMMAND POST(SWITCHING GROUP): OM-XXX	1
Z39781	ARMY H RESURCES: WRKSTATION	1
Z62433	REKEYING CONTROLER: KOK-13/TSEC	2
Z92849	TRANSEC MODULE: KSV-3	2

MISC EQUIPMENT

C05701	MONITOR CHEMICAL AGENT:	2
G18358	GEN SET: DED SKID MTD 3KW 60HZ	6
G36237	GENERATOR SET DIESEL: 60HZ AC MEP-531A	2
J00697	JOINT CHMCL AGENT: DETECTOR	12
M12986	MASK CHEMICAL BIOLOGICAL JOINT SERVICE GENERAL PURPOSE: FIELD M50	52
M13236	MASK CHEMICAL-BLGCL JNT SRV GNL PRPSE: CMBT VHL CRWMN M51	4
R20684	RADIAC SET: AN/VDR-2	14
R30925	RADIAC SET: AN/PDR-75	1
R31061	RADIAC SET: AN/UDR-13	12

MILITARY INTELLIGENCE COMPANY, BEB, BCT

34128RA00
4/5/64/ 73

COMPANY HEADQUARTERS PARA 01

MISSION.

To provide timely, relevant, accurate, and synchronized Intelligence, Surveillance, and Reconnaissance (ISR) support to the maneuver units within the Brigade Combat Team, and support the BCT commander, staff and subordinates during the planning, preparation, and execution of multiple, simultaneous decisive actions on a distributed battlefield.

X2 NVG HWTS FBCB2 AN/VRC-92F	DAGR EPLRS AN/VAS-5	2X NVG HWTS DAGR 40MM AN/VRC-90F	.50 CAL X2 NVG X4 M-249 MK93
			
CPT 35D00 CDR M4 M9 SPC 92Y10 SUPPLY SP M249	AN/NJQ-37	1LT 35D00 XO M4 1SG 35X5M 1SG M4 SGT 92Y20 SUPPLY NCO M4	

IEW SYSTEMS INTEGRATION SECTION PARA 02

INFO COLLECTION PLT HQ'S PARA 03

OPS MGMT TEAM PARA 04

CRYPTOLOGIC SUPPORT TEAM (CST) PARA 05

2X OL-701A/TYQ AN/VRC-90F	2X NVG AN/VRC-90F AN/ASM-146	AN/NJQ-37
		
CW2 353T0 IEW EQUIP TECH M4 SPC 35T10 MI SYS MNTR./INTGR M4	SGT 35T20 MI SYS MNTR./INTGR M4 SPC 35T10 MI SYS MNTR./INTGR M4 T10 MI SYS MNTR./INTGR M4	
2X NVG AN/VRC-90	AN/ASM-147	AN/NJQ-37
		
SGT 92A20 EQUIP REC/PARTS SGT M4 SPC 35T10 MI SYS MNTR./INTGR M249		

2X NVG AN/VRC-90F

2LT 35D00 PLT LDR M4 SFC 35F40 PLT SGT M4

DAGR 2X NVG MBTR AN/VAS-5 AN/VRC-91F	EPLRS AN/PYQ-3 AN/PYQ-8 AN/PS-5
	
CW2 351M0 HUMINT COLL TECH M4 M9 SSG 35M3L HUMINT COLL M4 M9 SPC 35M10 HUMINT COLLECTOR M4 M9 PFC 35M10 HUMINT COLLECTOR M4	



X2 NVG DAGR AN/VRC-90F AN/MSW-23	FBCB2 EPLRS AN/MSW-24 PROPHET-CTRL	2X NVG AN/VRC-90F AN/MSW-24
		
CW2 352N0 SIGINT ANLST TECH M4 SGT 35N20 SIGINT ANLST M4 SPC 35N10 SIGINT ANLST M4	SSG 35P30 SR CRYPT LNGST M4 SPC 35N10 SIGINT ANLST M4 PFC 35N10 SIGINT ANLST M4	

COMMON GROUND SENSOR (DCGS-A) PARA 06

RELEVANT ISR TO THE EDGE (RITE) PARA 07

SYNCHRONIZATION AND COLL MGMT SECTION PARA 08

DAGR 2X NVG AN/PSC-5 KOI-18/TSEC	EPLRS AN/VAS-5 AN/VRC-92F	2X NVG AN/VAS-5 AN/VSQ-2D(V)1 AN/TSQ-179
		
SSG 35G30 IMAGERY SGT M4 SPC 35G10 IMAGERY ANLST M4	SGT 35G20 IMAGERY ANLST M4 SPC 35G10 IMAGERY ANLST M4 PFC 35G10 IMAGERY ANLST M4 PFC 35G10 IMAGERY ANLST M249	

2X NVG AN/VAS-5 AN/VRC-90F	NVG AN/TSQ-190(V)2/3 (TROJAN SPIRIT)
	
SGT 35F20 INTEL ANLST M4 PFC 35F10 INTEL ANLST M4	SPC 35F10 INTEL ANLST M4

2X NVG FBCB2 AN/TYQ-93 AN/VRC-92F	DAGR EPLRS AN/TYQ-103	2X NVG DAGR AN/VRC-92E	M249 AN/VRC-90F	2X NVG DAGR AN/VRC-92E	M249 AN/VRC-90F
					
CW2 350F0 ALL SOURCE INTEL TECH M4 SSG 35F30 INTEL ANLST M4	CW2 350F0 ALL SOURCE INTEL TECH M4 SFC 35F40 SR INTEL SGT M4	PU-2003 x2 SGT 35F20 INTEL ANLST M4 X2 SPC 35F10 INTEL ANLST M4 X2 PFC 35F10 INTEL ANLST M4			

MULTI-FUNCTION PLT HQ PARA 09

EXPLOITATION TEAM PARA 10

BCT MfT SECTION PARA 11

STAFF WEATHER OFFICE PARA 12

DAGR EPLRS AN/VAS-5 AN/VRC-92F

1LT 35D00 PLT LDR M4 SFC 35M40 PLT SGT M4

FBCB2 2X NVG EPLRS AN/VRC-92F AN/PSC-5	AN/PYQ-7 AN/PYQ-3 DAGR KOI-18/TSEC
	
SGT 35F20 INTEL ANLST M4 SPC 35F10 INTEL ANLST M4 PFC 35F10 INTEL ANLST M4	

AN/VAS-5 2X NVG FBCB2 M240B EPLRS AN/PSC-5	AN/VRC-90F AN/PRC-119F HWTS DAGR AN/VRC-92F
	
SSG 35M30 HUMINT COLL SGT M4 M9 SGT 35M2L HUMINT COLLECTR M4 M9 SPC 35M10 HUMINT COLL SPC M4 M9 PFC 35M10 HUMINT COLL SPC M4 M9	

2X NVG DAGR EPLRS AN/VRC-90F	AN/MLQ-40(V)4 PROPHET-SENSOR
	
SGT 35P2L CRYPTO LINGUIST M4 SPC 35P1L CRYPTO LINGUIST M4 SPC 35P1L CRYPTO LINGUIST M4	

DAGR 2X NVG AN/VRC-90F	EPLRS AN/GMQ-36
	
*SSG 00D30 AIRFORCE STAFF NCO M4 SGT 00D20 AIR FORCE STAFF NCO M4 SGT 00D20 AIR FORCE STAFF NCO M4 SGT 00D20 AIR FORCE STAFF NCO M4	

x3

EQUIPMENT SUMMARY

WEAPONS

L69080	LAUNCHER GRENADE: M320A1	4
M09009	MACHINE GUN 5.56 MILLIMETER: M249	4
M39263	MACHINE GUN: LIGHT 5.56MM M249	7
M92362	MACHINE GUN GRENADE 40MM: MK19 MOD III	1
P98152	PISTOL 9MM AUTOMATIC: M9	17
R97234	RIFLE 5 56 MILLIMETER: M4	73
Z00686	MACHINE GUN: CALIBER .50	1

VEHICLES, TRAILERS AND TRLR MTD SYSTEMS

T34704	TRUCK UTILITY: ECV ARM CARR W/IAP ARMOR READY M1151A1	6
T37588	TRUCK UTILITY EXPDD CAPACITY ENHANCED: M1152A1	10
T41515	TRUCK CARGO: 5 TON WOWINCH	3
T56383	TRUCK UTIL EXPDD CAPACITY ENHANCED 4X4: M1165A1	6
T95924	TRAILER CARGO: HIGH MOBILITY 1-1/4 TON	6
T95992	LIGHT TACTICAL TRAILER: 3/4 TON	7
Z01385	TRAILER-MTD: PU-2103/60 KW/50/60HZ/M200A1	1
Z01405	LTT TRAILER-MTD: PU-2003/ 15 KW/ 50/60HZ	1
Z36683	TRAILER TANK WATER (CAMEL): 800 GAL 5 TON W/E	1

NIGHT VISION/OBSERVATION

D41659	DRIVERS ENHANCERS: AN/VAS-5	25
N05482	NIGHT VISION: GOGGLE	66
S90535	MEDIUM WEAPON THERMAL SIGHT (MWTS): AN/PAS-13(V)2	7
S90603	HEAVY WEAPON THERMAL SIGHT (HWTS): AN/PAS-13(V)3	2

MISC EQUIPMENT

C05701	MONITOR CHEMICAL AGENT:	8
J00697	JOINT CHMCL AGENT: DETECTOR	12
M12986	MASK CHEMICAL BIOLOGICAL JOINT SERVICE GENERAL PURPOSE: FIELD M50	77
R20684	RADIAC SET: AN/VDR-2	5
R30925	RADIAC SET: AN/PDR-75	1
R31061	RADIAC SET: AN/UDR-13	13
Z01330	GEN SET DED 10KW 50/60HZ: SKID-MTD	2

COMMUNICATIONS AND ELECTRONICS

A35329	ALL SOURCE ANALYSIS SYSTEM: AN/TYQ-93	5
A35397	ALL SOURCE ANALYSIS SYSTEM: AN/TYQ-93(V)2	1
A55606	ANALYZER DATA COMMUNICATIONS: TS-4281/G	2
A70285	ANALYZER SPECTRUM: AN/USM-677 (TEMOD)	2
C18176	COMPUTER SYSTEM: DIGITAL AN/TYQ-103	1
C18244	COMPUTER SYSTEM: DIGITAL AN/PYQ-7	1
C18312	COMPUTER SYSTEM: DIGITAL AN/PYQ-3	4
C18378	COMPUTER SET: AN/UUK-128(V)3	16
C27707	COMPUTER SYSTEM: DIGITAL AN/TYQ-109(V)1	1
C43331	CENTRAL: COMMUNICATIONS AN/TSQ226(V)2	2
C43399	CENTRAL: COMMUNICATIONS AN/TSQ-226(V)3	1
C77823	COMPUTER: SYSTEM DIGITAL AN/PYQ-8	5
E08940	ENCRYPTION-DECRYPTION EQUIPMENT: TACLANE KG 175	6
E94970	CONTROL RADIO SET: C-2299/VRC	1
J41800	INTEGRATED METEOROLOGICAL SYSTEM LIGHT: AN/GMQ-36	1
N96248	NAVIGATION SET: SATELLITE SIGNALS AN/PSN-13	19
P49587	PJH SURFACE VEHICLE RADIO SET: AN/VSQ-2(V)	16
P99881	PROCESSOR GROUP SIG DATA: (CAISI 2.0) OL-701A/TYQ	2
R44999	RADIO SET: AN/VRC-89F(C)	2
R45543	RADIO SET: AN/VRC-92F(C)	5
R57606	RADIO SET: AN/PSC-5	3
R57606	RADIO SET: AN/PSC-5	2
R68044	RADIO SET: AN/VRC-90F(C)	14
R68146	RADIO SET: AN/VRC-91F(C)	6
R87139	RADIO ST: AN/VRC-104(V)3 150 WATT W/PRC-150 HF RADIO	4
R93169	RADIO TEST SET: AN/PRM-34()	1
S01373	SPEECH SECURITY EQUIPMENT: TSEC/KY-57	1
T37036	TARGET ACQUISITION SUBSYSTEM: COMMON GROUND STATION AN/TSQ-179(V)	1
T40405	TAPE READER GENERAL PURPOSE: KOI-18/TSEC	1
Z00384	COMPUTER SYSTEM DIGITAL: AN/PYQ-10(C)	29
Z01247	COMPUTER SET: DIGITAL AN/UUK-128(V)1	5
Z01320	RADIO SET: AN/PRC-148 (V) 4 URBAN JEM	6
Z39781	ARMY H RESURCES: WRKSTATION	1

Tactical Unmanned Aircraft System (TUAS) Platoon, MI Company, BEB, SBCT

01708RB00
0/2/25/127

MISSION.

To provide airborne imagery intelligence support.

PLT HQ PARA 01

MSN PLNG & CTL SEC PARA 02

LAUNCH & RECOVERY SECTION PARA 03

AN/TYQ-151(V)2
AN/VRC-92F

CW3 150UB PLT LDR M4
SFC 15W40 PLT SGT M4
CW2 150U0 UAS OPS TECH M4

FBCB2
2X NVG
DAGR
EPLRS
COMPUTER SYS DIGITAL
AN/VAS-5
AN/VRC-92F

Ground Control
Station (TUAV-SHADOW)



AN/UYK-128(V)3
AN/TYQ-151(V)1
AN/TYQ-151(V)3
x2 AN/TYQ-150(V)1
x2 AN/VRC-89F
AN/VRC-92F
GDT TUAV-SHADOW



x2

SSG 15W30 UAV SGT M4
SGT 15W20 UAV OPR M4
SFC 15W10 UAS SYS REP M4
PFC 15W10 UAV OPR M4
SPC 15W10 UAV OPR M4
SGT 15W20 UAV OPR M4
PFC 15W10 UAV OPR M4
SPC 15W10 UAV OPR M4
SGT 15E20 UAS SYS TECH INSP M4

AN/TYQ-151(V)2
x5 AN/TYQ-151(V)1
x2 NVG

(EQUIP VEH)





x4

SFC 15E40 SR UAS SYS CHIEF M4
SSG 15W30 UAV SGT M4
SSG 15E30 UAS SYS TECH INSP M4
SGT 15E20 UAS SYS TEP TM CH M4
SGT 15W20 UAV OPR M4
SGT 15W20 UAV OPR M4

x2 OL-701A/TYQ
AN/VRC-89F
AN/TYQ-151(V)1 ULLS-A(E)
x2 NVG

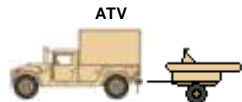
ATV



AN/VRC-89F
PGDT
AN/TYQ-151(V)1 ULLS-A(E)
x2 NVG

PGCS



x2 OL-701/TYQ
AN/VRC-89F
AN/TYQ-151(V)1 ULLS-A(E)
AN/TYQ-151(V)2
x2 NVG

MSMF



SGT 15E20 UAS SYS TECH INSP M4
PFC 15E10 UAS SYS REP M4
PFC 15W10 UAS SYS REP M4
PFC 15W10 UAV OPR M4
PFC 15W10 UAV OPR M249
SPC 15W10 UAV OPR M4
SPC 15E10 UAS SYS REP M4
SPC 15E10 UAS SYS REP M4
SPC 15W10 UAV OPR M4

EQUIPMENT SUMMARY

WEAPONS

MACHINE GUN 5.56MM M249 ----- 2
RIFLE 5.56MM M4 CARBINE----- 25

VEHICLES, TRAILERS, AND TRLR MTD SYSTEMS

TRUCK UTILITY EXP CAPACITY ENH 4X4: M1152A1----- 7
TRUCK CARGO: 4X4 LMTV (M1078)----- 1
TRAILER HIGH MOBILITY 1-1/4T (M1102)----- 4

MISCELLANEOUS EQUIPMENT

GEN SET DIESEL: 60HZ AC MEP-531A----- 8
GEN SET: DED SKID MTD 10KW 60HZ (MEP-803A)----- 2
SAW CHAIN: GAS DRVN BAR FRAME----- 2

TUAS SYSTEM EQUIPMENT

TACT UNMANNED AERIAL VEHICLE SYSTEM: (SHADOW)----- 1
PORTABLE GROUND DATA TERMINAL (PGDT)----- 1
MOBILE SECTION MULTI-FUNCTIONAL : (MSMF)----- 1
PORTABLE GROUND CONTROL STATION (PGCS)----- 1
TRUCK AIR VEHICLE TRANSPORTER: (AVT) (TUAV-SHADOW)----- 2
UNMANNED AERIAL VEHICLE (UAV): (TUAV-SHADOW)----- 4
UNMANNED AERIAL VEHICLE LAUNCHER: (TUAV-SHADOW)----- 2
GROUND CONTROL STATION (GCS): (TUAV-SHADOW)----- 2
TACTICAL AUTOMATED LANDING SYSTEM: (TALS)----- 2
GROUND DATA TERMINAL (GDT): (TUAV-SHADOW)----- 2

COMMUNICATION-ELECTRONICS EQUIPMENT

ANTENNA GROUP: OE-254----- 5
COMPUTER SET DIGITAL: AN/UYK-128 (FBCB2)----- 2
COMPUTER SYSTEM DIGITAL: (AMPS)----- 2
FREQUENCY HOPPING MULTIPLEXER: TF-1456VRC (FHMUX)----- 2
NAVIGATION SET: SATELLITE SIGNALS AN/PSN-13 (DAGR)----- 2
PJH SURFACE VEH RADIO SET: AN/VSQ-2(V)1 (EPLRS-V1)----- 2
PROCESSOR GROUP SIGNAL DATA: (CAISI 2.0) OL-701A/TYQ----- 2
RADIAC SET: AN/VDR-2----- 3
RADIO SET: AN/VRC-89F----- 7
RADIO SET: AN/VRC-92F----- 3
COMPUTER SET DIGITAL: AN/TYQ-151(V)1 ULLS-A(E)----- 10
COMPUTER SET DIGITAL: AN/TYQ-151(V)2----- 1
COMPUTER SET DIGITAL: AN/TYQ-151(V)3----- 2
COMPUTER SET DIGITAL: AN/TYQ-150(V)1 ULLS-A(E)----- 2

NIGHT VISION/OBSERVATION EQUIPMENT

NIGHT VISION GOGGLES: AN/PVS-7B----- 16

ANTIARMOR COMPANY, BEB, SBCT

07193R000
6/04/7//53

HEADQUARTERS SECTION PARA 01

MISSION: To provide accurate, long-range anti-armor fire support to enhance the Stryker Brigade Combat Team's (SBCT) lethality and survivability.

AN/VRC-92F
AN/UJK-128(V)1
DAGR
EPLRS-V1
AN/PED-1 (LLDR)
AN/MRC-149



CPT 11A00 CDR M4&M9
SGT 11B20 IAV CMDR M4
SP4 11B10 IAV DRIVER M4

AN/VRC-88F
AN/UJK-128(V)1
DAGR
EPLRS-V1



LT 11A00 EXEC OFF M4
SGT 25U20 FWD SGNL SPT NCO M4

AN/VRC-92F
AN/UJK-128(V)1
DAGR
EPLRS-V1
AN/TYQ-116(V)3



1SG 11Z5M FIRST SERGEANT M4
SP4 42A10 HUMAN RES SP M4

AN/VRC-90F
AN/UJK-128(V)1
AN/TYQ-109(V)1
DAGR
EPLRS-V1
OL-701A/TYQ



SGT 92Y20 SUPPLY NCO M4
SP4 92Y10 SUPPLY SP M4

ANTIARMOR PLATOON PARA 02

AN/VRC-91F
AN/UJK-128(V)1
DAGR
EPLRS-V1



LT 11A00 (PLT LDR) M4
SGT 11B20 (GUNNER) M4
SP4 11B10 (IAV DRIVER) M4
PFC 11B10 (ASST GUNNER) M4

AN/VRC-91F
AN/UJK-128(V)1
DAGR
EPLRS-V1



SFC 11B40 (PLT SGT) M4
SGT 11B20 (GUNNER) M4
SP4 11B10 (IAV DRIVER) M4
PFC 11B10 (ASST GUNNER) M4

AN/VRC-87F
AN/UJK-128(V)1
DAGR
EPLRS-V1



SSG 11B30 (SQUAD LDR) M4
SGT 11B20 (GUNNER) M4
SP4 11B10 (IAV DRIVER) M4
PFC 11B10 (ASST GUNNER) M4

X3

COMBAT MEDIC SECTION PARA 03

3 AN/TYQ-105(V)1

SSG 68W30 (SECTION NCO) M9
3 SP4 68W10 (COMBAT MEDIC) M9

FIRES SUPPORT TEAM PARA 04

2 AN/VRC-92F
AN/PRC-119F
2 AN/PSG-14 (V)1 LFED
AN/UJK-128(V)1
2 DAGR
EPLRS-V1
AN/PSC-5
AN/PED-1 (LLDR)
LRAS3 (FS3)



LT 13A00 (FIRE SPT OFF) M4
SSG 13F30 (FIRE SPT SGT) M4
SP4 13F10 (FIRE SPT SP) M4
PFC 13F10 (RATELO) M4

EQUIPMENT SUMMARY

WEAPONS

LAUNCHER GRENADE: M320A1----- 5
MACHINE GUN: CALIBER .50 (M2E2)----- 3
MACHINE GUN 7.62MM M240B----- 13
PISTOL 9MM AUTOMATIC M9----- 5
RIFLE 5.56MM M4 CARBINE----- 49

VEHICLES, TRAILERS, AND TRLR MTD SYSTEMS

ANTITANK GUIDED MISSILE VEHICLE: (ATGM) (M1134)----- 9
FIRE SUPPORT VEHICLE: (FSV) (M1131)----- 1
INFANTRY CARRIER VEHICLE: (ICV) (M1126)----- 1
TRUCK CARGO: MTV (M1083)----- 2
TRUCK UTILITY EXP CAPACITY ENH 4X4: M1165A1----- 1
TRAILER CARGO: MTV W/ DROPSIDES (M1095)----- 1
TRAILER TANK WATER (CAMEL) 800 GAL 5 TON----- 1

NIGHT VISION/OBSERVATION EQUIPMENT

DRIVERS VISION ENHANCER: AN/VAS-5----- 14
MONOCULAR NIGHT VISION DEVICE: AN/PVS-14----- 14
NIGHT VISION GOGGLES: AN/PVS-7B----- 43
RANGE FINDER-TGT DESIGNATOR: LASER AN/PED-1 (LLDR)----- 1
SURVEILLANCE SYS: SCOUT LONG RANGE AN/TAS-8 (LRAS3)----- 1
MEDIUM THERMAL WEAPONS SIGHT: AN/PAS-13(V2)----- 13
HEAVY THERMAL WEAPONS SIGHT: AN/PAS-13(V3)----- 3
LASER TARGET LOCATOR SYSTEM (LTL5)----- 8

COMMUNICATION-ELECTRONICS EQUIPMENT

ANTENNA GROUP: OE-254----- 3
COMPUTER SYSTEM DIGITAL: AN/PSG-14(V)1 LFED----- 2
COMP SET DIGITAL: AN/UJK-128(V)1 (FBCB2 APPLIQUE)----- 14
COMPUTER SYSTEM DIGITAL: AN/TYQ-105(V)1----- 3
COMPUTER SET DIGITAL: AN/TYQ-109(V)1 (GCSS-A (V)1)----- 1
NAVIGATION SET: SATELLITE SIGNALS AN/PSN-13 (DAGR)----- 15
PJH SURFACE VEH RADIO SET: AN/VSQ-2(V)1 (EPLRS-V1)----- 14
PROCESSOR GROUP SIGNAL DATA: (CAISI 2.0) OL-701A/TYQ----- 1
RADIAC SET: AN/VDR-2----- 11
RADIO SET: AN/VRC-87F----- 3
RADIO SET: AN/VRC-88F----- 1
RADIO SET: AN/VRC-90F----- 1
RADIO SET: AN/VRC-91F----- 6
RADIO SET: AN/VRC-92F----- 4
RADIO SET: AN/PSC-5----- 1
RADIO SET: AN/PRC-119F----- 1
COMMS SYSTEM AN/MRC-149 (SOLDIER NETWORK EXTENSION)----- 1
COMPUTER SYSTEM DIGITAL: AN/TYQ-116(V)3 (AHR5)----- 1

MISCELLANEOUS EQUIPMENT

GEN SET : DED SKID MTD 3KW 60HZ (MEP-831A)----- 1
MUNITION: NETWORK COMMAND (SPIDER)----- 1
ARMAMENT SUBSYSTEM: REMOTELY OPERATED----- 1
COMMON REMOTELY OPERATED WEAON STATION (CROWS)----- 1

EQUIPMENT SUMMARY

WEAPONS

L69080	LAUNCHER GRENADE: M320A1	5
M92841	MACHINE GUN: 7.62MM M240B	13
P98152	PISTOL 9MM AUTOMATIC: M9	5
R97234	RIFLE 5 56 MILLIMETER: M4	49
Z00686	MACHINE GUN: CALIBER .50	3

VEHICLES, TRAILERS AND TRLR MTD SYSTEMS

A83852	ANTI-TANK GUIDED MISSILE VEH: (ATGM)	9
F86821	FIRE SUPPORT VEHICLE: (FSV)	1
J22626	INFANTRY CARRIER: VEHICLE (ICV)	1
T56383	TRUCK UTILITY EXPANDED CAPACITY ENHANCED 4X4: M1165A1	1
T61908	TRUCK CARGO: MTV W/E	2
T95555	TRAILER CARGO: MTV W/DROPSIDES M1095	1
Z36683	TRAILER TANK WATER (CAMEL): 800 GAL 5 TON W/E	1

NIGHT VISION/OBSERVATION

D41659	DRIVERS ENHANCERS: AN/VAS-5	14
J03261	ILLUMINATOR: INFRARED	49
J68653	ILLUMINATOR INTEGRATED: SMALL ARMS STORM MLRF	1
M79678	MONOCULAR NIGHT VISION DEVICE: AN/PVS-14	14
N05482	NIGHT VISION: GOGGLE	39
S90535	MEDIUM WEAPON THERMAL SIGHT (MWTS): AN/PAS-13(V)2	13
S90603	HEAVY WEAPON THERMAL SIGHT (HWTS): AN/PAS-13(V)3	4
T27221	TARGET LOCATION AND OBSERVATION: AN/PLQ-8	10

COMMUNICATIONS AND ELECTRONICS

C04819	COMTER SYS DIG: AN/PSG-14(V)1 LFED	2
C18378	COMPUTER SET: AN/UYK-128(V)3	14
C27503	COMPUTER SYSTEM: DIGITAL AN/TYQ-105(V)1	4
C27707	COMPUTER SYSTEM: DIGITAL AN/TYQ-109(V)1	1
P49587	PJH SURFACE VEHICLE RADIO SET: AN/VSQ-2(V)	14
P99881	PROCESSOR GROUP SIG DATA: (CAISI 2.0) OL-701A/TYQ	1
R45543	RADIO SET: AN/VRC-92F(C)	4
R57606	RADIO SET: AN/PSC-5	1
R60282	RANGE FINDER-TARGET DESIGNATOR: LASER AN/PED-1	1
R67296	RADIO SET: AN/VRC-87F(C)	3
R67330	RADIO SET: AN/VRC-88F(C)	1
R68044	RADIO SET: AN/VRC-90F(C)	1
R68146	RADIO SET: AN/VRC-91F(C)	6
R83141	RADIO SET: AN/PRC-119F(C)	1
R93169	RADIO TEST SET: AN/PRM-34()	1
S02976	SURVEILLANCE SYSTEM: SCOUT LONG RANGE AN/TAS-8	1
T27221	TARGET LOCATION AND OBSERVATION: AN/PLQ-8	10
T40405	TAPE READER GENERAL PURPOSE: KOI-18/TSEC	2
Z00384	COMPUTER SYSTEM DIGITAL: AN/PYQ-10(C)	21
Z39781	ARMY H RESURCES: WRKSTATION	1

MISC EQUIPMENT

C05701	MONITOR CHEMICAL AGENT:	2
G18358	GEN SET: DED SKID MTD 3KW 60HZ	1
M12986	MASK CHEMICL BIOLOGICL JOINT SERVICE GENERAL PURPOSE: FIELD M50	8
M13236	MASK CHMICL-BLGCL JNT SRV GNL PRPSE: CMBT VHL CRWMN M51	45
R20684	RADIAC SET: AN/VDR-2	11
R30925	RADIAC SET: AN/PDR-75	1
R31061	RADIAC SET: AN/UDR-13	5

HHT, CAVALRY SQUADRON, SBCT

MISSION.

To provide command, control, and supervision of the tactical operations of the Cavalry Squadron and attached units; unit administration and logistical support for the squadron staff sections; and administrative and medical support to organic and attached units.

HHT, CAVALRY SQDRN, SBCT 17196R000 22/0/118/140

COMMAND GROUP PARA 01

CURRENT OPS – INTEL/S2 PARA 02

CURRENT OPS – OPS/S3 PARA 03

FBCB2
STORM
x2 NVG
DAGR
EPLRS-V1
AN/PYQ-12
AN/VRC-92F
AN/VRC-106(V)1@
AN/VRC-104(V)3
HWTS
AN/UJK-128(V)1

FBCB2
x2 NVG
DAGR
EPLRS-V1
AN/VRC-92F
AN/MRC-150
AN/UJK-128(V)1



*LTC 02B00 CDR M4 M9 ENVG
AN/PSC-5
MAJ 02B00 EXEC OFF M4 M9
PFC 19D10 DRIVER M4
**WHEN NOT MOUNTED IN STRYKER*

FBCB2 x2 NVG
DAGR EPLRS-V1
AN/VRC-90F AN/UJK-128(V)1



CSM 19Z60 CSM M4 M9
PFC 19D10 SCOUT M4



LTC 02B00 CDR M4 M9 ENVG
AN/PSC-5
SGT 19D20 IAV CDR M4
SPC 19D10 IAV DVR M4

FBCB2 x3 AN/TYQ-93
AN/TYQ-93(V)2 AN/VAS-5
x2 NVG DAGR
EPLRS-V1 AN/VRC-92F
AN/VRC-106(V)1 AN/TYQ-93(V)2
AN/VRC-104(V)3
AN/UJK-128(V)1



CPT 35D00 S2 M4 ENVG AN/PSC-5
1LT 35D00 TAC INTEL OFF M4
SFC 19D40 SR INTEL SGT M4
SSG 35F30 INTEL SGT M4
SGT 35F20 INTEL ANLST M4
SGT 35F20 INTEL ANLST M4
SGT 35F20 INTEL ANLST M4
SGT 35F20 ISR SYNCH MGR M4
SPC 35F10 INTEL ANLST M4
SPC 35F10 INTEL ANLST M4
PFC 35F10 INTEL ANLST M4
PFC 35F10 INTEL ANLST M4

FBCB2 STORM
x2 NVG DAGR
HWTS .50 CAL
AN/VAS-5 AN/PSC-5
EPLRS-V1 AN/VRC-92F
AN/VRC-91F AN/VRC-104(V)3
AN/UJK-128(V)1



MAJ 02B00 M4 M9
SFC 19D40 ASST OPS SGT M4
SSG 74D30 CBRN NCO M4
SPC 19D10 DVR M4

DAGR EPLRS-V1
AN/PSC-5 AN/VRC-92F
AN/VRC-104(V)3 AN/UJK-128(V)1



SGT 19D20 OPS ASST M4
AN/PSC-5
PFC 19D10 DVR M4

FBCB2 DAGR
EPLRS-V1 AN/PSC-5
AN/VRC-90F AN/MRC-149
x2 AN/VRC-92F AN/VRC-104(V)3
AN/UJK-128(V)1



*MAJ 02B00 S3 M4 M9
PFC 19D10 DVR M4
**WHEN NOT MOUNTED ON STRYKER*

FBCB2 DAGR
FHMUX EPLRS-V1
AN/PYQ-12 x2 AN/VRC-92F
AN/VRC-104(V)3 AN/VRC-106(V)1
AN/TYQ-137B AN/UJK-128(V)1



MED PWR PLANT
CPT 19C00 ASST S3 M4 AN/PSC-5
SGM 19Z60 OPS SGT M4

DAGR
AN/VRC-90F



CPT 19C00 ASST S3 M4 AN/PSC-5
SFC 19D40 ASST OPS SGT M4
SGT 19D20 OPS ASST M4

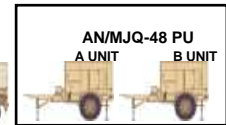

CURRENT OPS – FIRE SPT PARA 04

CURRENT OPS – FIRE SPT/TACP PARA 05

SUSTAINMENT – S1 PARA 06

SSG 29E30 EW SGT M4 ILLUM
SGT 29E20 EW SGT M4 ILLUM

FBCB2
AN/VAS-5
x2 NVG
X2 DAGR
FHMUX
EPLRS-V1
AN/GYK-56
X2 AN/VRC-92F
AN/VRC-104(V)3
AN/UJK-128(V)1
AN/GYK-48(V)1



X2 NGV
FBCB2
X2 DAGR
AN/GYK-57
EPLRS
AN/VRC-92F
AN/PSC-5
AN/VRC-106(V)1
AN/PRC-119F
AN/UJK-128(V)1



MED PWR PLANT

MOVED TO FIRES BN

CPT 13A00 EFFECTS COORD M4 ILLUM
AN/PRC-119F
1LT 13A00 ASST EFFECTS COORD M4
SFC 13F40 TGT NCO M4 ILLUM
SFC 13F40 EFFECTS NCO M4 ILLUM
SGT 13F20 FIRE SPT SGT M4 ILLUM
SPC 13F10 FIRE SPT SP M4 ILLUM
SPC 13F10 FIRE SPT SP M4 ILLUM

FBCB2
AN/VAS-5
STORM
2X NVG
DAGR
EPLRS-V1
AN/VRC-92F
AN/TYK-56
HWTS
.50 CAL
AN/UJK-128(V)1



SGT 19D20 IAV CDR M4
SPC 19D10 IAV DVR M4

*CPT 01A00 AIR FORCE STAFF OFFICER M4
*SSG 00D30 AIR FORCE STAFF NCO M4
*SPC 00D10 AIR FORCE STAFF ENLISTED M4

**USAF PERSONNEL NOT ASSIGNED TO THE UNIT*

FBCB2
AN/VAS-5
x2 NVG
DAGR
EPLRS-V1
AN/VRC-89F
OL-701A/TYQ
AN/UJK-128(V)1
X4 AN/TYQ-116(V)3



CPT 42B00 S1 M4 ENVG
SFC 42A40 SR HR SGT M4
SSG 42A30 HR SGT M4
SGT 42A20 HR SGT M4
SPC 42A10 HR SP M4
SPC 27D10 PARALEGAL M4
PFC 42A10 HR SP M4
PFC 42A10 HR SP M4

HHT, CAVALRY SQDRN, SBCT

SUSTAINMENT – S4 PARA 07

FBCB2
AN/VAS-5
x2 NVG
DAGR
EPLRS-V1
AN/VRC-92F
AN/VRC-104(V)3
AN/UYK-128(V)1

AN/VRC-90F
x2 AN/TYQ-129(V)2
AN/TYQ-109(V)1
AN/VRC-106(V)1(C)
AN/UYQ-90(V)3
AN/
KG-175
M240B
OL-701A/TYQ
MWTS
KOI-18/TSEC



CPT 19C00 S4 M4 ENVG



SFC 92Y40 SR SUPPLY SGT M4
SGT 92Y20 SUPPLY NCO M4

SUSTAINMENT – UMT TEAM PARA 08

FBCB2
AN/VAS-5
x2 NVG
DAGR
EPLRS-V1
AN/VRC-90F
AN/UYK-128(V)1



CPT 56A00 CHAPLAIN
SGT 56M20 CHAPLAIN ASST M4

SUSTAINMENT-C4 OPS/S6 PARA 09

FBCB2
AN/VAS-5
x2 NVG
DAGR
AN/VRC-92F
AN/UYK-128(V)1



CPT 25A00 S6 M4
SSG 25U30 SIG INFO SVC NCO M4

AN/VRC-90F



PU 798

DAGR
EPLRS-V1
AN/VRC-90F
AN/UYK-128(V)1

AN/VRC-90F
AN/VRC-106(V)2(C)
AN/UYK-128(V)1
AN/PYQ-12
AN/TSQ-243
DAGR
X2 EPLRS-V1
AN/TSR-8 (GRT)
AN/GYK-50B(ISYSCON)(V)4
AN/GYK-62B
AN/USQ-165
AN/TYQ-137B(V)3



SFC 25U40 SECT CH M4
SSG 25E30 ELECTRO SPECT NCO M4
SPC 25B10 LAN MGR M4
PFC 25B10 LAN MGR M4
SPC 25U10 SIG PST SYS MAINT M4
SPC 25U10 SIG SPT SP M4

BATTALION COMMAND POST
SWITCHING GROUP:OM-87A/T



SGT 25Q20 SR XMSN SYS OPR M4
SPC 25Q10 XMSN SYS OPR M4

MOVED TO FIRES BN

FIRES SUPPORT PLATOON PARA 10

FBCB2
AN/VAS-5
x2 NVG
DAGR
EPLRS-V1
AN/VRC-92F
AN/PED-1 (LLDR)
AN/VRC-91F
LRAS3 (FS3)
HWTS
.50 CAL
AN/UYK-128(V)1

AN/PLQ-8



1LT 13A00 FSO M4 ILLUM NVG
AN/PSG-14(V)1 AN/PRC-119F
SSG 13F30 FIRE SPT SGT M4 ILLUM NVG
SPC 13F10 FIRE SPT SP M4 ILLUM
PFC 13F10 FIRE SPT SP M4 ILLUM

RETRANSMISSION SECTION PARA 10

FBCB2
AN/VAS-5
STORM
x2 NVG
DAGR
X2 EPLRS-V1
X2 AN/VRC-92F
AN/MRC-149
HWTS
.50 CAL
AN/UYK-128(V)1



SSG 25U30 TM CH M4
SPC 25U10 RETRANS OPR M4
PFC 25U10 RETRANS OPR M4

FBCB2
AN/VAS-5
STORM
x2 NVG
DAGR
X2 EPLRS-V1
X2 AN/VRC-92F
AN/MRC-149
HWTS
.50 CAL
AN/UYK-128(V)1



SGT 25U20 TM CH M4
SPC RETRANS OPR M4
PFC RETRANS OPR M4

FBCB2
AN/VAS-5
STORM
x2 NVG
DAGR
X2 EPLRS-V1
X2 AN/VRC-92F
AN/MRC-149
HWTS
.50 CAL
AN/UYK-128(V)1



SGT 25U20 TM CH M4
SPC RETRANS OPR M4
PFC RETRANS OPR M4

X3

HHT, CAVALRY SQDRN, SBCT

TROOP HEADQUARTERS PARA 11

FBCB2
AN/VAS-5
2X NVG
DAGR
EPLRS
AN/VRC-92F
AN/UYK-128(V)1

FBCB2
AN/VAS-5
2X NVG
DAGR
EPLRS
AN/VRC-92F
AN/UYK-128(V)1

FBCB2
AN/VAS-5
2X NVG
DAGR
EPLRS
AN/VRC-90F
HWTS
.50 CAL
AN/UYK-128(V)1



CPT 19C00 CDR M4 M9
PFC 19D10 DRIVER M4



1LT 19C00 CO XO M4
1SG 19Z5M 1SG M4
PFC 19D10 DRIVER M4



SSG 92Y30 SUPPLY SGT M4

MEDICAL TREATMENT PLT HQ PARA 12

FBCB2
AN/VAS-5
x2 NVG
DAGR
EPLRS-V1
AN/VRC-89F
AN/TYQ-107(V)1
AN/TYQ-108(V)3
OL-701A/TYQ
AN/UYK-128(V)1



1LT 70B67 FIELD MED ASST M4
SPC 68W40 PLT SGT M4

MEDICAL TREATMENT SQUAD PARA 13

FBCB2
AN/VAS-5
2X NVG
DAGR
EPLRS
AN/VRC-90F
AN/UYK-128(V)1



CPT 62B00 SURGEON/PLT LDR M9
PFC 68W10 HLTH CARE SP M4

FBCB2
AN/VAS-5
2X NVG
DAGR
EPLRS
AN/VRC-89F
AN/UYK-128(V)1



SGT 68W20 HLTH CARE SGT M4
SPC 68W10 HLTH CARE SP M4
PFC 68W10 HLTH CARE SP M4

FBCB2
AN/VAS-5
2X NVG
DAGR
EPLRS
AN/VRC-89F
AN/UYK-128(V)1



CPT 65D00 PA M9
SSG 68W30 HLTH CARE SGT M4
SGT 68W20 HLTH CARE SGT M4

AMBULANCE SQUAD PARA 14

AN/UYK-128(V)3
3X AN/TYQ-105(V)1
AN/VAS-5
DAGR
2X NVG
EPLRS
AN/VRC-90F
AN/UYK-128(V)1



SGT 68W20 EMERG CARE SGT M4
SPC 68W10 AMBULANCE AIDE M4
PFC 68W10 AMBULANCE AIDE M4

x4

COMBAT MEDIC SECTION PARA 15

x11 AN/TYQ-105(V)1

x3 SGT 68W20 EMERG CARE SGT M4
x8 SPC 68W10 COMBAT MEDIC M9 NVG

EQUIPMENT SUMMARY

WEAPONS

L69080	LAUNCHER GRENADE: M320A1	7
M92841	MACHINE GUN: 7.62MM M240B	6
P98152	PISTOL 9MM AUTOMATIC: M9	16
R97234	RIFLE 5 56 MILLIMETER: M4	114
Z00686	MACHINE GUN: CALIBER .50	12

VEHICLES, TRAILERS AND TRLR MTD SYSTEMS

C41314	COMMAND VARIANT VEH: (CV)	6
F86821	FIRE SUPPORT VEHICLE: (FSV)	3
M30567	MEDICAL EVACUATION VEHICLE: (MEV)	4
P63462	POWER PLANT: UTILITY (MEDIUM)	2
T37588	TRUCK UTILITY EXPANDED CAPACITY ENHANCED: M1152A1	9
T41515	TRUCK CARGO: 5 TON WO/WINCH	6
T56383	TRUCK UTILITY EXPANDED CAPACITY ENHANCED 4X4: M1165A1	9
T95555	TRAILER CARGO: MTV W/DROPSIDES M1095	2
T95924	TRAILER CARGO: HIGH MOBILITY 1-1/4 TON	1
T95992	LIGHT TACTICAL TRAILER: 3/4 TON	8
Z01414	LTT TRAILER-MTD: PU-2002/ 10 KW/ 50/60HZ	1
Z01437	TRLR MTD: PP-3003/15 KW 50/60HZ	1
Z36683	TRAILER TANK WATER (CAMEL): 800 GAL 5 TON W/E	1

NIGHT VISION/OBSERVATION

D41659	DRIVERS ENHANCERS: AN/VAS-5	37
J03261	ILLUMINATOR: INFRARED	21
J68653	ILLUMINATOR INTEGRATED: SMALL ARMS STORM MLRF	6
M79678	MONOCULAR NIGHT VISION DEVICE: AN/PVS-14	6
N05482	NIGHT VISION: GOGGLE	85
N07848	NIGHT VISION DEVIC: AN/PSQ-20	4
R60282	RANGE FINDER-TARGET DESIGNATOR: LASER AN/PED-1	3
S02976	SURVEILLANCE SYSTEM: SCOUT LONG RANGE AN/TAS-8	3
S90535	MEDIUM WEAPON THERMAL SIGHT (MWTS): AN/PAS-13(V)2	6
S90603	HEAVY WEAPON THERMAL SIGHT (HWTS): AN/PAS-13(V)3	12

MISC EQUIPMENT

C05701	MONITOR CHEMICAL AGENT:	2
C79000	COLLECTIVE PROTECTION EQUIPMENT: NBC SIMPLIFIED M20	4
G18358	GEN SET: DED SKID MTD 3KW 60HZ	5
J00697	JOINT CHMCL AGENT: DETECTOR	17
M12986	MASK CHEMICAL BIOLOGICAL JOINT SERVICE GENERAL PURPOSE: FIELD M50	80
M13236	MASK CHEMICAL-BLGCCL JNT SRV GNL PRPSE: CMBT VHL CRWMM M51	46
R20684	RADIAC SET: AN/VDR-2	22
R30925	RADIAC SET: AN/PDR-75	1
R31061	RADIAC SET: AN/UDR-13	24
Z01328	GEN SET DED 5KW 50/60HZ: SKID-MTD	1
Z01330	GEN SET DED 10KW 50/60HZ: SKID-MTD	2

COMMUNICATIONS AND ELECTRONICS

A35329	ALL SOURCE ANALYSIS SYSTEM: AN/TYQ-93	3
A35397	ALL SOURCE ANALYSIS SYSTEM: AN/TYQ-93(V)2	1
C04819	COMTER SYS DIG: AN/PSG-14(V)1 LFED	6
C17936	COMPUTER SET: AN/GYG-1(V)1	1
C18277	COMPUTER SET: DIGITAL AN/TYQ-107(V)1	1
C18345	COMPUTER SET: DIGITAL AN/TYQ-106(V)1	2
C18378	COMPUTER SET: AN/UJK-128(V)3	34
C18641	COMPUTER SYST DIGITAL: AN/PYQ-12	3
C27435	COMPUTER SYSTEM: DIGITAL AN/TYQ-129(V)2	2
C27503	COMPUTER SYSTEM: DIGITAL AN/TYQ-105(V)1	21
C27639	COMPUTER SYSTEM: DIGITAL AN/TYQ-108(V)3	1
C27707	COMPUTER SYSTEM: DIGITAL AN/TYQ-109(V)1	2
C27963	COMPUTER SYSEM: DIGITAL	4
C40996	COMMAND SYSTEM: TACTICAL	2
C41314	COMMAND VARIANT VEH: (CV)	6
C61665	COMMAND CENTER SYSTEM: AN/TSQ-243	1
C67436	COMPTER SYSTEM DIGITAL: AN/PYQ-6C	12
C78851	COMPUTER SYSTEM: DIGITAL AN/UJQ-90(V)3	1
C79281	COMPUTER ST FIELD ARTILLERY GENERAL: AN/GYK-48(V)1	1
E08940	ENCRYPTION-DECRYPTION EQUIPMENT: TACLANE KG 175	1
N96248	NAVIGATION SET: SATELLITE SIGNALS AN/PSN-13	39
P49587	PJH SURFACE VEHICLE RADIO SET: AN/VSQ-2(V)	38
P98881	PROCESSOR GROUP SIG DATA: (CAISI 2.0) OL-701A/TYQ	5
R30658	RECEIVE SUITE: AN/TSR-8	1
R44999	RADIO SET: AN/VRC-89F(C)	4
R45543	RADIO SET: AN/VRC-92F(C)	26
R45710	RADIO SET: AN/VRC-106(V)2 (C)	1
R57606	RADIO SET: AN/PSC-5	10
R68044	RADIO SET: AN/VRC-90F(C)	14
R68146	RADIO SET: AN/VRC-91F(C)	4
R68566	RADIO SET: AN/VRC-106(V)1 (C)	5
R83141	RADIO SET: AN/PRC-119F(C)	4
R87139	RADIO ST: AN/VRC-104(V)3 150 WATT W/PRC-150 HF RADIO	8
R93169	RADIO TEST SET: AN/PRM-34()	4
T40405	TAPE READER GENERAL PURPOSE: KOI-18/TSEC	5
Z00129	COMPUTER SET FIELD ARTILLERY GENERAL: AN/GYK-56	2
Z00384	COMPUTER SYSTEM DIGITAL: AN/PYQ-10(C)	42
Z00512	COMPUTER SYSTEM DIGITAL: AN/GYK-50A (ISYSCON) (V)4	1
Z00513	COMPUTER SYSTEM DIGITAL: AN/GYK-50B (ISYSCON) (V)4	1
Z00564	BATTALION COMMAND POST(SWITCHING GROUP): OM-XXX	1
Z01247	COMPUTER SET: DIGITAL AN/UJK-128(V)1	34
Z01248	COMPUTER SET: DIGITAL AN/GYK-62B	2
Z39781	ARMY H RESOURCES: WRKSTATION	4
Z70024	COMMUNICATION SUBSYSTEM: AN/USQ-165	1

CAVALRY TROOP, CAV SQDN, SBCT

17097R500
5/0/87//92

TROOP HEADQUARTERS PARA 01

MISSION: To perform accurate and timely ground reconnaissance and surveillance in support of brigade operations, enabling the commander to employ his ground forces or joint fires precisely at the time and place of his choosing.

FBCB2 x2 NVG
X2 DAGR HWTS
.50 CAL AN/TAS-8
EPLRS-V1 AN/VASA-5
AN/VRC-92F AN/VRC-90F
AN/UYSK-128(V)1



CPT 19C00 CDR M4 M9 ENVG
AN/PRC-119F
SGT 19D20 OPS ASST M4
SPC 19D10 STRYKER DVR M4

FBCB2 x2 NVG
HWTS .50 CAL
DAGR AN/PYQ-3
AN/PSC-5 AN/TAS-8
AN/VASA-5 EPLRS-V1
AN/VRC-92F AN/VRC-90F
AN/VRC-104(V)3
AN/UYSK-128(V)1



1LT 19C00 EXEC OFF M4 ENVG
SPC 19D10 STRYKER DVR M4
SSG 19D30 OPS NCO M4
SGT 74D20 CBRN NCO M4
SGT 25U20 FWD SIG SPT NCO M4

FBCB2 x2 NVG
DAGR AN/VAS-5
EPLRS-V1 AN/VRC-92F
AN/UYSK-128(V)1



1SG 19Z5M 1SG M4 ENVG

FBCB2 x2 NVG
DAGR HWTS
.50 CAL AN/VAS-5
EPLRS-V1 AN/VRC-90F
OL-701A/TYQ
AN/UYSK-128(V)1
AN/TYQ-109(V)1

SSG 92Y30 SUPPLY SGT M4
SPC 92Y10 SUPPLY SP M4

SCOUT PLATOON PARA 02 AND 03

FBCB2 AN/PYQ-3
AN/VAS-5 M240L
x2 NVG JAVELIN
X3 DAGR AN/VRC-104(V)3
EPLRS-V1 50 CAL
AN/VRC-92F HWTS
AN/TAS-8 LRAS3
SHOTGUN AN/PRC-148(V)4
AN/UY



1LT 19C00 PLT LDR M4 ILLUM ENVG AN/PRC-119F
SGT 19D20 GUNNER M4 ILLUM
SPC 19D10 DRIVER M4 ILLUM
SPC 19D10 SCOUT M4 ILLUM ENVG LMR

FBCB2 M240L
AN/VAS-5 JAVELIN
x2 NVG AN/VRC-104(V)3
X3 DAGR 4XMK-19
EPLRS-V1 HWTS
AN/VRC-92F LRAS3
AN/TAS-8 AN/PRC-148(V)4
SHOTGUN AN/UYSK-128(V)1



SFC 19D40 PLT SGT M4 ENVG AN/PRC-119F
SGT 19D20 GUNNER M4 ILLUM
SPC 19D10 DRIVER M4 ILLUM

FBCB2 M240L
AN/VAS-5 JAVELIN
XX NVG AN/VRC-104(V)3
X2 DAGR 50 CAL
EPLRS-V1 HWTS
AN/VRC-92F LRAS3
AN/TAS-8 AN/PRC-148(V)4
SHOTGUN AN/UYSK-128(V)1



SSG 19D3G SECT LDR M4 ILLUM ENVG LMR
SGT 19D20 GUNNER M4 ILLUM
SPC 19D10 DRIVER M4 ILLUM
SGT 19D2G TM LDR M4 ILLUM ENVG LMR
SPC 19D10 SCOUT M4 ILLUM ENVG LMR
SPC 19D10 SCOUT M4 ILLUM ENVG LMR
PFC 19D10 SCOUT M4 ILLUM ENVG LMR
PFC 19D10 SCOUT M4 ILLUM ENVG LMR

FBCB2 M240L
AN/VAS-5 JAVELIN
2X NVG AN/VRC-104(V)3
X2 DAGR MK-19
EPLRS-V1 HWTS
AN/VRC-92F LRAS3
AN/TAS-8 AN/PRC-148(V)4
SHOTGUN AN/UYSK-128(V)1



SSG 19D3G SECT LDR M4 ILLUM ENVG LMR
SGT 19D20 GUNNER M4 ILLUM
SPC 19D10 DRIVER M4 ILLUM
SGT 19D2G TM LDR M4 ILLUM ENVG LMR
SPC 19D10 SCOUT M4 ILLUM ENVG LMR
SPC 19D10 SCOUT M4 ILLUM ENVG LMR
PFC 19D10 SCOUT M4 ILLUM ENVG LMR
PFC 19D10 SCOUT M4 ILLUM ENVG LMR

x3

MORTAR SECTION PARA 04

DAGR HWTS
.50 CAL X2 NVG
FBCB2 AN/VAS-5
EPLRS-V1 AN/VRC-92F
AN/UYSK-128(V)1



SFC 11C40 SECT LDR M4
PFC 11C10 DRIVER M4

M240B DAGR
MWTS X2 NVG
FBCB2 AN/VAS-5
EPLRS-V1 AN/VRC-91F
AN/UYSK-128(V)1
60MM MORTAR
120MM MORTAR



SSG 11C30 SQD LDR M4
SPC 11C10 DRIVER M4
SPC 11C10 GUNNER M4
PFC 11C10 A GUNNER M4
PFC 11C10 AMMO BEARER M4

x2

EQUIPMENT SUMMARY

WEAPONS

C60750	COMMAND LAUNCH UNIT: (JAVELIN) 13305405-119	12
L69080	LAUNCHER GRENADE: M320A1	10
M92362	MACHINE GUN GRENADE 40MM: MK19 MOD III	6
M92454	MACHINE GUN 7.62 MILLIMETER: M240L	12
M92841	MACHINE GUN: 7.62MM M240B	2
P98152	PISTOL 9MM AUTOMATIC: M9	1
R97234	RIFLE 5 56 MILLIMETER: M4	105
S40541	SHOTGUN: 12 GAGE	12
Z00686	MACHINE GUN: CALIBER .50	10

VEHICLES, TRAILERS AND TRLR MTD SYSTEMS

C41314	COMMAND VARIANT VEH: (CV)	1
M53369	MORTAR CARRIER VEHICLE: (MCV) W/60MM and 120MM	2
R62673	RECONNAISSANCE VEH: (RV)	13
T37588	TRUCK UTILITY EXPANDED CAPACITY ENHANCED: M1152A1	1
T41515	TRUCK CARGO: 5 TON WO/WINCH	1
T59584	TRUCK CARGO: W/MHE WO/WINCH	1
T95555	TRAILER CARGO: MTV W/DROPSIDES M1095	1
T95992	LIGHT TACTICAL TRAILER: 3/4 TON	1
Z36683	TRAILER TANK WATER (CAMEL): 800 GAL 5 TON W/E NIGHT VISION/OBSERVATION	1
D41659	DRIVERS ENHANCERS: AN/VAS-5	19
J03261	ILLUMINATOR: INFRARED	69
J68653	ILLUMINATOR INTEGRATED: SMALL ARMS STORM MLRF	1
M79678	MONOCULAR NIGHT VISION DEVICE: AN/PVS-14	12
N05482	NIGHT VISION: GOGGLE	38
N07848	NIGHT VISION DEVIC: AN/PSQ-20	48
S60356	SIGHT: THERMAL AN/PAS-13B(V)1	6
S90535	MEDIUM WEAPON THERMAL SIGHT (MWTS): AN/PAS-13(V)2	14
S90603	HEAVY WEAPON THERMAL SIGHT (HWTS): AN/PAS-13(V)3	28
T27221	TARGET LOCATION AND OBSERVATION: AN/PLQ-8	1

COMMUNICATIONS AND ELECTRONICS

C18312	COMPUTER SYSTEM: DIGITAL AN/PYQ-3	4
C18378	COMPUTER SET: AN/UYPK-128(V)3	19
C27707	COMPUTER SYSTEM: DIGITAL AN/TYQ-109(V)1	1
C77823	COMPUTER: SYSTEM DIGITAL AN/PYQ-8	6
N96248	NAVIGATION SET: SATELLITE SIGNALS AN/PSN-13	38
P49587	PJH SURFACE VEHICLE RADIO SET: AN/VSQ-2(V)	19
P99881	PROCESSOR GROUP SIG DATA: (CAISI 2.0) OL-701A/TYQ	1
R45543	RADIO SET: AN/VRC-92F(C)	10
R57606	RADIO SET: AN/PSC-5	1
R68044	RADIO SET: AN/VRC-90F(C)	3
R68146	RADIO SET: AN/VRC-91F(C)	8
R83141	RADIO SET: AN/PRC-119F(C)	7
R87139	RADIO ST: AN/VRC-104(V)3 150 WATT W/PRC-150 HF RADIO	13
R93169	RADIO TEST SET: AN/PRM-34()	1
Z00384	COMPUTER SYSTEM DIGITAL: AN/PYQ-10(C)	35
Z00862	LAND MOBILE RADIO: (LMR)	54
Z01006	TARGET LOCATOR MODULE:	12
Z01247	COMPUTER SET: DIGITAL AN/UYPK-128(V)1	19
Z01320	RADIO SET: AN/PRC-148 (V) 4 URBAN JEM	12

MISC EQUIPMENT

C05701	MONITOR CHEMICAL AGENT:	2
G11966	GEN SET: DED SKID MTD 5KW 60HZ	2
J00697	JOINT CHMCL AGENT: DETECTOR	15
M12986	MASK CHEMICAL BIOLOGICAL JOINT SERVICE GENERAL PURPOSE: FIELD M50	5
M13236	MASK CHEMICAL-BLGCCL JNT SRV GNL PRPSE: CMBT VHL CRWMN M51	100
R20684	RADIAC SET: AN/VDR-2	17
R30925	RADIAC SET: AN/PDR-75	1
R31061	RADIAC SET: AN/UDR-13	12
Z01006	TARGET LOCATOR MODULE:	12
Z01328	GEN SET DED 5KW 50/60HZ: SKID-MTD	1

HHC, INFANTRY BN, SBCT

07196R000
25/0/180/205

COMMAND GROUP PARA 01

MISSION: To provide command, control, and supervision of the tactical operations of the Infantry Battalion and attached units; unit administration and logistical support for the battalion staff sections; and indirect mortar fire support, reconnaissance, and administrative and medical support to organic and attached units.

FBCB2
AN/VAS-5
STORM
X2 DAGR
EPLRS-V1
AN/VRC-92F
AN/VRC-90F
AN/VRC-106(V)1
AN/VRC-104(V)3
HWTS
FHMUX
.50 CAL
AN/UYK-128(V)1
AN/TYQ-137B(V)3



LTC 02B00 CDR M4 M9 ILLUM ENVG AN/PRC-119F
SGT 11B20 IAV CDR M4 ILLUM NVG
SPC 11B10 IAV DVR M4 ILLUM NVG
PFC 11B10 RTO M4 ILLUM NVG

FBCB2
AN/VAS-5
X2 DAGR
EPLRS-V1
AN/VRC-92F
AN/MRC-150
AN/UYK-128(V)1



*LTC 02B00 CDR M4 M9 ILLUM ENVG AN/PRC-119F
MAJ 02B00 BN XO M4 M9 ILLUM ENVG N/PRC-119F
PFC 11B10 DRIVER M4 ILLUM NVG
PFC 11B10 RTO M4 ILLUM NVG

**WHEN NOT MOUNTED IN CV*

FBCB2
AN/VAS-5
DAGR
EPLRS-V1
AN/VRC-92F
AN/UYK-128(V)1



CSM 00Z50 CSM M4 M9 ILLUM NVG
PFC 11B10 RIFLEMAN M4 ILLUM NVG

CURRENT OPS – INTEL/S2 PARA 02

FBCB2
AN/VAS-5
X2 DAGR
EPLRS-V1
AN/VRC-92F
AN/VRC-106(V)1
AN/UYK-128(V)1

X2 AN/TYQ-93
AN/TYQ-93(V)2
KOI-18/TSEC



CPT 35D00 S2 M4 ILLUM NVG
SFC 11B40 SR INTEL SGT M4 ILLUM NVG
1LT 35D00 TAC INTEL OFF M4 ILLUM NVG
SSG 35F30 INTEL SGT M4 ILLUM NVG
SGT 35F20 INTEL ANLST M4 ILLUM NVG
SPC 35F10 INTEL ANLST M4 ILLUM NVG
SSG 35F30 INTEL SGT M4 ILLUM NVG
SGT 35F20 INTEL ANLST M4 ILLUM NVG
SGT 35F20 INTEL ANLST M4 ILLUM NVG
SGT 35F20 INTEL ANLST M4 ILLUM NVG
PFC 35F10 INTEL ANLST M4 ILLUM NVG

CURRENT OPS – OPS/S3 PARA 03

FBCB2
AN/VAS-5
STORM
X2 DAGR
EPLRS-V1
AN/VRC-92F
AN/VRC-106(V)1
AN/VRC-104(V)3
HWTS
.50 CAL
AN/UYK-128(V)1



MAJ 02B00 S3 M4 M9 ILLUM ENVG AN/PRC-119F
SGT 11B20 IAV CDR M4 ILLUM NVG
SPC 11B10 IAV DVR M4 ILLUM NVG
SFC 11B40 A OPS SGT M4 ILLUM NVG

FBCB2 AN/VAS-5
DAGR
EPLRS-V1
AN/VRC-92F
AN/MRC-149
AN/UYK-128(V)1



*MAJ 02B00 S3 M4 M9 ILLUM ENVG AN/PRC-119F
PFC 11B10 DVR M4 ILLUM NVG

**WHEN NOT MOUNTED IN CV*

AN/VAS-5
DAGR
EPLRS-V1
AN/VRC-90F
AN/VRC-92F
AN/VRC-104(V)3
AN/VRC-106(V)1(C)
AN/UYK-128(V)1
AN/TYQ-137B(V)3
HWTS
.50 CAL



CPT 02B00 A S3 M4 ILLUM NVG AN/PVS-5
SGM 11Z50 OPS SGT M4 ILLUM NVG
SFC 11B40 A OPS SGT M4 ILLUM NVG
SSG 11B30 A OPS SGT M4 ILLUM NVG
SSG 74D30 CBRN NCO M4 ILLUM NVG
SGT 11B20 A OPS SGT M4 ILLUM NVG
SPC 74D10 CBRN SP M4 ILLUM NVG
SPC 11B10 OPS ASST M4 ILLUM NVG
PFC 11B10 DVR M4 ILLUM NVG

DAGR
AN/VRC-90F



SPC 74D10 CBRN SP M4 ILLUM NVG
PFC 74D10 CBRN SP M4 ILLUM NVG

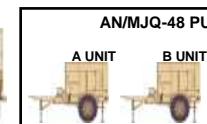

AN/MJQ-48 PU

A UNIT B UNIT

HHC, INFANTRY BN, SBCT

CURRENT OPS – FIRE SPT PARA 4

FBCB2
X2 DAGR
EPLRS-V1
AN/VR-92F
AN/PED-1 (LLDR)
AN/GYK-48(V)1
AN/PLQ-8
AN/UYK-128(V)1



MSG 29E50 EW SGT NCOIC M4 AN/PRC-119F
SSG 29E30 EW SGT M4 ILLUM NVG
SGT 29E20 EW SGT M4 ILLUM NVG
SSG 25E30 ELECTRO SPE NCO M4 ILLUM NVG

FBCB2
AN/VAS-5
DAGR
AN/PSC-5
EPLRS-V1
AN/VR-90F
AN/VR-92F
AN/VR-104(V)3
AN/VR-106(V)1(C)
AN/UYK-128(V)1
AN/GYK-5



MOVED TO FIRES BN

CPT 13A00 EFFECTS COORD M4 ILLUM NVG
AN/PRC-119F
1LT 13A00 A EFFECTS COORD M4 ILLUM NVG
AN/PRC-119F
SFC 13F40 TGT NCO M4 ILLUM NVG
SFC 13F40 EFFECTS NCO M4 ILLUM NVG
SGT 13F20 FIRE SPT SGT M4 ILLUM NVG
SPC 13F10 FIRE SPT SP M4 ILLUM NVG
SPC 13F10 FIRE SPT SP M4 ILLUM NVG

CURRENT OPS – FIRE SPT/TACP PARA 5

FBCB2
AN/VAS-5
STORM
DAGR
EPLRS-V1
AN/VR-92F
HWTS
AN/GYK-56
.50 CAL
ANUYK-128(V)1



SGT 11B20 IAV CDR M4 ILLUM NVG
SPC 11B10 IAV DVR M4 ILLUM NVG

*CPT 01A00 AIR FORCE STAFF OFF M4 ILLUM NVG
*SSG 00D30 AIR FORCE STAFF NCO M4 ILLUM NVG
*SPC 00D10 AIR FORCE STAFF ENLISTED M4 ILLUM NVG

**USAF PERSONNEL NOT ASSIGNED TO UNIT*

CURRENT OPS – LNO PARA 6

FBCB2
AN/VAS-5
DAGR
EPLRS-V1
AN/VR-90F
AN/UYK-128(V)1



1LT 11A00 LNO M4 ILLUM NVG
PFC 11B10 DRIVER M4 ILLUM NVG

SUSTAINMENT – S1 PARA 7

FBCB2
AN/VAS-5
DAGR
EPLRS-V1
AN/VR-90F
AN/UYK-128(V)1
OL-701A/TYQ
X5 AN/TYQ—116(V)3



CPT 42B00 S1 M4 ILLUM NVG
PFC 42A10 HR SP M4 ILLUM NVG
SFC 42A40 SR HR SGT M4 ILLUM NVG
SSG 42A30 HR SGT M4 ILLUM NVG
SGT 27D20 PARALEGAL M4 ILLUM NVG
SGT 42A20 HR SGT M4 ILLUM NVG
SPC 42A10 HR SP M4 ILLUM NVG
SPC 42A10 HR SP M4 ILLUM NVG
PFC 42A10 HR SP M4 ILLUM NVG

SUSTAINMENT – S4 PARA 8

FBCB2
AN/VAS-5
DAGR
EPLRS-V1
AN/VR-92F
AN/UYQ-128(V)1



CPT 11A00 S4 M4 ILLUM NVG
PFC 92Y10 SUPPLY SP M4 ILLUM NVG

FBCB2
AN/VAS-5
DAGR
EPLRS-V1
AN/VR-92F
AN/VR-90F
AN/UYK-128(V)1

X2 AN/TYQ-129(V) 2
AN/TYQ-109(V)1
AN/TYQ-137B(V)3
AN/PYQ-6C
AN/UYQ-90(V)3
KOI-18/TSEC
OL-701A/TYQ



SFC 92Y40 SR SUPPLY SGT M4 ILLUM NVG
SGT 92Y20 SUPPLY NCO M4 ILLUM NVG
SPC 92Y10 SUPPLY SP M4 ILLUM NVG

SUSTAINMENT – UMT PARA 9

FBCB2
AN/VAS-5
DAGR
EPLRS-V1
AN/VR-90F
AN/UYK-128(V)1



CPT 56A00 CHAPLAIN
SGT 56M20 CHAPLAIN ASST M4 NVG

SUSTAINMENT – C3 OPS/S6 PARA 10

FBCB2
AN/VAS-5
DAGR
EPLRS-V1
AN/VR-92F
AN/UYK-128(V)1



CPT 25A00 S6 M4 ILLUM NVG
SPC 25U10 SIG SPT SYS SP M4 ILLUM NVG

FBCB2
AN/VAS-5
DAGR
X2 EPLRS-V1
AN/VR-106(V)1
AN/VR-90F
AN/UYK-128(V)1

AN/PYQ-12
AN/TYQ-137B(V)3
AN/TSQ-243
AN/PYQ-6C
EPLRS-V1
AN/TSR-8 (GRT)
AN/GYK-50B
AN/GYK-62B
AN/USQ—165



FBCB2
AN/VAS-5
DAGR
EPLRS-V1
AN/VR-90F
AN/UYK-128(V)1



SSG 25E30 EL SPEC NCO
M4 ILLUM NVG
SPC 25U10 SIG SPT SYS
M4 ILLUM NVG

SFC 25U40 SECT CH M4 ILLUM NVG
SPC 25B10 LAN MGR M4 ILLUM NVG
SPC 25U10 SIG INFO SVC SP M4
ILLUM NVG
PFC 25B10 LAN MGR M4 ILLUM NVG

AN/VAS-5
DAGR
AN/VR-90F

BCP (SWITCHING GROUP):
OM-87A/T

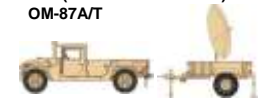

SGT SR XMSN SYS OPR
M4 ILLUM NVG
SPC 25Q10 XMSN SYS OPR
M4 ILLUM NVG

HHC, INFANTRY BN, SBCT

MOVED TO FIRES BN

FIRES SUPPORT PLATOON PARA 11

FBCB2
AN/VAS-5
X2 DAGR
EPLRS-V1
AN/PED-1
X2 AN/VRC-91F
AN/TAS-8
HWTS
.50 CAL
AN/UYK-128(V)1

AN/GYK-37V1
AN/PSC-5
AN/PSG-10(V) PFED



1LT 13A00 FSO M4 ILLUM NVG AN/PSG-14(V)1
AN/PSG-11(V)1 AN/PRC-119F
SSG 13F30 FS SGT M4 ILLUM NVG
SPC 13F10 FIRE SPT SP M4 ILLUM NVG
PFC 13F10 FIRE SPT SP M4 ILLUM NVG

x3

SGT 13F20 FO M4 ILLUM NVG AN/PSG-14(V)1
AN/PSG-11(V)1 AN/PSC-5 AN/PRC-119F

x9

RETRANSMISSION SECTION PARA 11

FBCB2
AN/VAS-5
STORM
DAGR
X2 EPLRS-V1
X2 AN/VRC-92F
HWTS
.50 CAL
AN/UYK-128(V)1
AN/MRC-149



SSG 25U30 TEAM CHIEF M4 ILLUM NVG
SPC 25U10 RETRANS OPR M4 ILLUM
SPC 25U10 RETRANS OPR M4 ILLUM NVG

FBCB2
AN/VAS-5
STORM
DAGR
X2 EPLRS-V1
X2 AN/VRC-92F
HWTS
.50 CAL
AN/UYK-128(V)1
AN/MRC-149



SGT 25U20 TEAM CHIEF M4 ILLUM NVG
SPC 25U10 RETRANS OPR M4 ILLUM
SPC 25U10 RETRANS OPR M4 ILLUM NVG

COMPANY HEADQUARTERS PARA 12

FBCB2
AN/VAS-5
DAGR
EPLRS-V1
AN/VRC-92F
AN/UYK-128(V)1



CPT 11A00 CDR M4 M9 ILLUM NVG
PFC 11B10 DVR M4 ILLUM NVG

FBCB2
AN/VAS-5
DAGR
EPLRS-V1
AN/VRC-88F
AN/UYK-128(V)1



1LT 11A00 EXEC OFF M4 ILLUM NVG
PFC 11B10 DVR M4 ILLUM NVG
1SG 11Z5M 1SG M4 ILLUM NVG

FBCB2
AN/VAS-5
DAGR
EPLRS-V1
AN/VRC-88F
HWTS
.50 CAL
AN/UYK-128(V)1



SSG 92Y30 SUPPLY SGT M4 ILLUM NVG
PFC 92Y10 SUPPLY SP M4 ILLUM NVG
SPC 92Y10 SUPPLY SP M4 ILLUM NVG

X2 DAGR
AN/PRC-119F
X5 LMR

FBCB2
AN/VAS-5
X2 DAGR
EPLRS-V1
AN/VRC-92F
AN/TAS-8
SHOTGUN
AN/UYK-128(V)1
M240B
MWTS
.50 CAL
HWTS
LRAS3



1LT 11A00 PLT LDR M4 ILLUM NVG
DAGR AN/PRC-119F AN/PRC-148(V)4
SPC 11B10 IAV DVR M4 ILLUM NVG
PFC 11B10 IAV CREW M4 ILLUM NVG

FBCB2
AN/VAS-5
X2 DAGR
EPLRS-V1
AN/VRC-92F
AN/TAS-8
SHOTGUN
AN/UYK-128(V)1
M240B
MWTS
MK-19
HWTS
LRAS3



SFC 11B4G PLT SGT M4 ILLUM NVG
DAGR AN/PRC-119F AN/PRC-148(V)1
SPC 11B10 IAV DVR M4 ILLUM NVG

FBCB2
AN/VAS-5
DAGR
EPLRS-V1
AN/VRC-92F
AN/TAS-8
SHOTGUN
AN/UYK-128(V)1
AN/PRC-119F
M240B
MWTS
.50 CAL
HWTS
LRAS3



SGT 11B20 IAV CDR M4 ILLUM NVG
SPC 11B10 IAV DVR M4 ILLUM NVG

FBCB2
AN/VAS-5
DAGR
EPLRS-V1
AN/VRC-92F
AN/TAS-8
SHOTGUN
AN/UYK-128(V)1
AN/PRC-119F
M240B
MWTS
MK-19
HWTS
LRAS3



SGT 11B20 IAV CDR M4 ILLUM NVG
SPC 11B10 IAV DVR M4 ILLUM NVG

SSG 11B30 TEAM LDR M4 ILLUM NVG DAGR
AN/PRC-119F LMR
SGT 11B20 A TEAM LDR M4 ILLUM NVG DAGR
AN/PRC-148(V)1 LMR LWTS
SPC 11B10 SCOUT M4 ILLUM NVG LMR LWTS
PFC 11B10 M4 ILLUM NVG LMR
PFC 11B10 SCOUT M4 ILLUM NVG LMR

x3

SCOUT PLATOON PARA 13

HHC, INFANTRY BN, SBCT

MORTAR PLT HQ PARA 14

FBCB2
AN/VAS-5
X2 DAGR
EPLRS-V1
AN/VRC-92F
AN/UYK-128(V)1



1LT 11A00 PLT LDR M4 ILLUM NVG DAGR
AN/PRC-119F
SGT 11C20 FIRE DIR COMP M4 ILLUM NVG
PFC 11C10 VEH DRV M4 ILLUM NVG

FBCB2
AN/VAS-5
M151 MFCS
DAGR
EPLRS
AN/VRC-91F
AN/UYK-128(V)1



SFC 11C40 PLT SGT M4 ILLUM NVG DAGR
AN/PRC-119F
SSG 11C30 SEC LDR M4 ILLUM NVG
SGT 11C20 FIRE DIR COMP M4 ILLUM NVG
PFC 11C10 VEH DVR M4 ILLUM NVG

MORTAR SQUAD PARA 15

M240B FBCB2
AN/VAS-5 X2 DAGR
EPLRS-V1 AN/VRC-91F
AN/UYK-128(V)1 81MM MORTAR
120MM MORTAR



SSG 11C30 SQD LDR M4 ILLUM NVG DAGR
SPC 11C10 GUNNER M4 ILLUM NVG
SPC 11C10 DRIVER M4 ILLUM NVG
PFC 11C10 A GUNNER M4 ILLUM NVG
PFC 11C10 AMMO BEARER M4 ILLUM NVG

X4

SNIPER SQUAD PARA 16

FBCB2 X2 DAGR
AN/VAS-5 EPLRS-V1
AN/VRC-88F AN/UYK-128(V)1



SSG 11B30 SQD LDR M4 ILLUM NVG DAGR
AN/PRC-119F

DAGR
AN/PRC-119F

SGT 11B20 SR SNIPER M9 ENVG STORM DAGR
M110 RIFLE AN/PRC-119F AN/PVS-29 AN/PVS-10
ILLUM M107 RIFLE LWTS
SPC 11B10 SNIPER M4 ILLUM NVG
SPC 11B10 SNIPER M203 ILLUM ENVG

X2

MEDICAL TREATMENT PLT HQ PARA 17

FBCB2 AN/TYQ-107(V)1
AN/VAS-5 AN/TYQ-106(V)1
DAGR X8 AN/TYQ-105(V)1
EPLRS-V1 OL-701A/TYQ
AN/VRC-89F
AN/UYK-128(V)1



1LT 70B67 FIELD MED ASST M4 NVG
SFC 68W40 PLT SGT M4 NVG

MEDICAL TREATMENT SQD PARA 18

FBCB2
AN/VAS-5
DAGR
EPLRS-V1
AN/VRC-88F
AN/UYK-128(V)1
OL-701A/TYQ



CPT 62B00 SURGEON M4 NVG
SPC 68W10 HLTH CARE SP M4 NVG

FBCB2
AN/VAS-5
DAGR
EPLRS-V1
AN/VRC-89F
AN/TYQ-106(V)1
AN/UYK-128(V)1
X4 AN/TYQ-105(V)1



CPT 65D00 PHYSICIAN ASST M9 NVG
SGT 68W20 HLTH CARE SGT M4 NVG
PFC 68W10 HLTH CARE SP M4 NVG

FBCB2
AN/VAS-5
DAGR
EPLRS-V1
AN/VRC-89F
AN/TYQ-106(V)1
X4 AN/TYQ-105(V)1
AN/UYK-128(V)1



SSG 68W30 HLTH CARE SGT M4 NVG
SGT 68W20 HLTH CARE SGT M4 NVG
PFC 68W10 HLTH CARE SP M4 NVG

(x2) MEDICAL EVACUATION SQD PARA 19

FBCB2
AN/VAS-5
DAGR
EPLRS-V1
AN/VRC-90F
AN/UYK-128(V)1
X2 AN/TYQ-105(V)1



SGT 68W20 EMER CARE SGT M4 NVG
PFC 68W10 AMB DRIVER M4 NVG
SPC 68W10 DRIVER M4 NVG

x4

COMBAT MEDIC SECTION PARA 20

X14 AN/TYQ-105(V)1

x3 SGT 68W20 EMERG CARE SGT M9
x11 SPC 68W10 COMBAT MEDIC M9 NVG

EQUIPMENT SUMMARY

WEAPONS

L69080	LAUNCHER GRENADE: M320A1	12
M02114	MORTAR 81 MILLIMETER: M252	4
M92362	MACHINE GUN GRENADE 40MM: MK19 MOD III	4
M92841	MACHINE GUN: 7.62MM M240B	12
P98152	PISTOL 9MM AUTOMATIC: M9	23
R45351	RIFLE SNIPER .50 CALIBER: M107	2
R45601	RIFLE SNIPER: M110	2
R97234	RIFLE 5 56 MILLIMETER: M4	189
S40541	SHOTGUN: 12 GAGE	8
Z00686	MACHINE GUN: CALIBER .50	13

VEHICLES, TRAILERS AND TRLR MTD SYSTEMS

C41314	COMMAND VARIANT VEH: (CV)	5
F86821	FIRE SUPPORT VEHICLE: (FSV)	3
M30567	MEDICAL EVACUATION VEHICLE: (MEV)	4
M53369	MORTAR CARRIER VEHICLE: (MCV) W/60MM AND 120MM	4
P63462	POWER PLANT: UTILITY (MEDIUM)	2
R62673	RECONNAISSANCE VEH: (RV)	4
T37588	TRUCK UTILITY EXPANDED CAPACITY ENHANCED: M1152A1	10
T41515	TRUCK CARGO: 5 TON WO/WINCH	5
T56383	TRUCK UTILITY EXPANDED CAPACITY ENHANCED 4X4: M1165A1	12
T95555	TRAILER CARGO: MTV W/DROPSIDES M1095	1
T95992	LIGHT TACTICAL TRAILER: 3/4 TON	11
Z01414	LTT TRAILER-MTD: PU-2002/ 10 KW/ 50/60HZ	1
Z01437	TRLR MTD: PP-3003/15 KW 50/60HZ	1
Z36683	TRAILER TANK WATER (CAMEL): 800 GAL 5 TON W/E	2

NIGHT VISION/OBSERVATION

D41659	DRIVERS ENHANCERS: AN/VAS-5	47
J03261	ILLUMINATOR: INFRARED	170
J68653	ILLUMINATOR INTEGRATED: SMALL ARMS STORM MLRF	7
M79678	MONOCULAR NIGHT VISION DEVICE: AN/PVS-14	37
N05482	NIGHT VISION: GOGGLE	149
N07848	NIGHT VISION DEVIC: AN/PSQ-20	22
S60342	SIGHT NIGHT VISION (SNS): AN/PVS-29	2
S60356	SIGHT: THERMAL AN/PAS-13B(V)1	8
S90535	MEDIUM WEAPON THERMAL SIGHT (MWTS): AN/PAS-13(V)2	12
S90603	HEAVY WEAPON THERMAL SIGHT (HWTS): AN/PAS-13(V)3	17
S90603	HEAVY WEAPON THERMAL SIGHT (HWTS): AN/PAS-13(V)3	2

COMMUNICATIONS AND ELECTRONICS

A35329	ALL SOURCE ANALYSIS SYSTEM: AN/TYQ-93	2
A35397	ALL SOURCE ANALYSIS SYSTEM: AN/TYQ-93(V)2	1
C04819	COMTER SYS DIG: AN/PSG-14(V)1 LFED	6
C17936	COMPUTER SET: AN/GYG-1(V)1	1
C18277	COMPUTER SET: DIGITAL AN/TYQ-107(V)1	1
C18345	COMPUTER SET: DIGITAL AN/TYQ-106(V)1	2
C18378	COMPUTER SET: AN/UJK-128(V)3	44
C18641	COMPUTER SYST DIGITAL: AN/PYQ-12	1
C27435	COMPUTER SYSTEM: DIGITAL AN/TYQ-129(V)2	2
C27503	COMPUTER SYSTEM: DIGITAL AN/TYQ-105(V)1	29
C27707	COMPUTER SYSTEM: DIGITAL AN/TYQ-109(V)1	2
C27963	COMPUTER SYSEM: DIGITAL	4
C40996	COMMAND SYSTEM: TACTICAL	2
C41314	COMMAND VARIANT VEH: (CV)	5
C61665	COMMAND CENTER SYSTEM: AN/TSQ-243	1
C67436	COMPTER SYSTEM DIGITAL: AN/PYQ-6C	10
C78851	COMPUTER SYSTEM: DIGITAL AN/UJK-90(V)3	1
C79281	COMPUTER ST FIELD ARTILLERY GENERAL: AN/GYK-48(V)1	1
N96248	NAVIGATION SET: SATELLITE SIGNALS AN/PSN-13	82
P49587	PJH SURFACE VEHICLE RADIO SET: AN/VSQ-2(V)	47
P99881	PROCESSOR GROUP SIG DATA: (CAISI 2.0) OL-701A/TYQ	5
R30658	RECEIVE SUITE: AN/TSR-8	1
R44999	RADIO SET: AN/VRC-89F(C)	3
R45543	RADIO SET: AN/VRC-92F(C)	23
R45710	RADIO SET: AN/VRC-106(V)2 (C)	1
R57606	RADIO SET: AN/PSC-5	14
R60282	RANGE FINDER-TARGET DESIGNATOR: LASER AN/PED-1	4
R67330	RADIO SET: AN/VRC-88F(C)	4
R68044	RADIO SET: AN/VRC-90F(C)	15
R68146	RADIO SET: AN/VRC-91F(C)	12
R68566	RADIO SET: AN/VRC-106(V)1 (C)	5
R83141	RADIO SET: AN/PRC-119F(C)	31
R87139	RADIO ST: AN/VRC-104(V)3 150 WATT W/PRC-150 HF RADIO	4
S02976	SURVEILLANCE SYSTEM: SCOUT LONG RANGE AN/TAS-8	7
Z00058	COMPUTER SYSTEM DIGITAL: AN/PSG-10(V)	9
Z00129	COMPUTER SET FIELD ARTILLERY GENERAL: AN/GYK-56	1
Z00384	COMPUTER SYSTEM DIGITAL: AN/PYQ-10(C)	88
Z00512	COMPUTER SYSTEM DIGITAL: AN/GYK-50A (ISYSCON) (V)4	1
Z00513	COMPUTER SYSTEM DIGITAL: AN/GYK-50B (ISYSCON) (V)4	1
Z00564	BATTALION COMMAND POST(SWITCHING GROUP): OM-XXX	1
Z00862	LAND MOBILE RADIO: (LMR)	15
Z01247	COMPUTER SET: DIGITAL AN/UJK-128(V)1	44
Z01248	COMPUTER SET: DIGITAL AN/GYK-62B	1
Z01279	COMMON REMOTELY OPERATED WPN STATION (CROWS):	4
Z01320	RADIO SET: AN/PRC-148 (V) 4 URBAN JEM	8
Z39781	ARMY H RESURCES: WRKSTATION	5
Z70024	COMMUNICATION SUBSYSTEM: AN/USQ-165	1
	MISC EQUIPMENT	
C05701	MONITOR CHEMICAL AGENT:	4
G18358	GEN SET: DED SKID MTD 3KW 60HZ	5
J00697	JOINT CHMCL AGENT: DETECTOR	24
M12986	MASK CHEMICL BIOLOGICL JOINT SERVICE GENERAL PURPOSE: FIELD M50	131
M13236	MASK CHMCL-BLGCL JNT SRV GNL PRPSE: CMBT VHL CRWMN M51	77
Z01328	GEN SET DED 5KW 50/60HZ: SKID-MTD	1

RIFLE COMPANY, INFANTRY BN, SBCT

07097R300
6/0/157/163

COMPANY HEADQUARTERS PARA 01

SNIPER TEAM PARA 02

MISSION: To close with the enemy by means of fire and maneuver to destroy or capture, or to repel his assault by fire, close combat, and counterattack.

FBCB2
AN/VAS-5
STORM
X2 DAGR
EPLRS-V1
AN/VRC-92F
AN/VRC-90F
HWTS
.50 CAL
AN/UYK-128(V)1



CPT 11A00 CDR M4 M9 ENVG
DAGR AN/PRC-119F HWTS
SGT 11B20 IAV CDR
M4 ILLUM NVG
SPC 11B10 IAV DVR
M4 ILLUM NVG

AN/VAS-5
DAGR
AN/VRC-92F
AN/MRC-149



*CPT 11A00 CDR M4 M9 ENVG
DAGR AN/PRC-119F HWTS
PFC 11B10 RTO M4 ILLUM NVG
*WHEN NOT MOUNTED IN ICV

FBCB2
AN/VAS-5
STORM
X2 DAGR
EPLRS-V1
AN/VRC-91F
HWTS
.50 CAL
AN/UYK-128(V)1



1LT 11A00 CO XO M4 ILLUM NVG
DAGR AN/PRC-119F
SGT 11B20 IAV CDR M4 ILLUM NVG
SPC 11B10 IAV DVR M4 ILLUM NVG
PFC 11B10 RTO M4 ILLUM NVG

FBCB2
AN/VAS-5
DAGR
EPLRS-V1
AN/VRC-90F
HWTS
.50 CAL
AN/UYK-128(V)1
AN/TYQ-109(V)1
OL-701A/TYQ



1SG 11Z5M 1SG M4 ILLUM NVG
SPC 92Y10 SUPPLY SP M4
ILLUM NVG

FBCB2
AN/VAS-5
DAGR
EPLRS-V1
AN/VRC-90F
AN/UYK-128(V)1



SSG 92Y30 SUPPLY SGT
M4 ILLUM NVG
SGT 25U20 FWD SIG SPT NCO
M4 ILLUM NVG

FBCB2
AN/VAS-5
X3 DAGR
EPLRS-V1
AN/VRC-91F
AN/UYK-128(V)1



SGT 11B20 SR SNIPER M9 ENVG AN/PRC-119F
ILLUM STORM M107 RIFLE M110RIFLE
AN/PVS-29 HWTS AN/PLQ-8
SPC 11B10 SNIPER M203 ILLUM NVG
SPC 11B10 SNIPER M4 ILLUM NVG

RIFLE PLT HQ PARA 03

RIFLE PLT MOUNTED ELEMENT PARA 04

RIFLE SQUAD PARA 05

WEAPONS SQUAD PARA 06

X2 DAGR
X2 AN/PRC-119F

1LT 11A00 PLT LDR M4 ILLUM NVG
DAGR AN/PRC-119F HWTS
AN/PRC-148(V)4
SFC 11B4G PLT SGT M4 ILLUM NVG
DAGR AN/PRC-119F AN/PRC-148(V)4
PFC 11B10 RTO M4 ILLUM NVG

x2

FBCB2
AN/VAS-5
STORM
DAGR
EPLRS-V1
AN/VRC-91F
AN/UYK-128(V)1
HWTS



SGT 11B20 IAV CDR M4 ILLUM NVG
SPC 11B10 IAV DVR M4 ILLUM NVG

x8

DAGR
X9 LMR

SSG 11B30 SQD LDR M4 ILLUM NVG DAGR HWTS
AN/PLQ-8 LMR AN/PRC-148(V)4
SGT 11B20 TM LDR M4 ILLUM NVG LMR
SGT 11B20 TM LDR M4 ILLUM NVG LMR
SPC 11B10 AUTO RIFLEMAN M249 ILLUM NVG MWTS LMR
SPC 11B10 AUTO RIFLEMAN M249 ILLUM NVG MWTS LMR
SPC 11B10 GRENADIER M320 ILLUM NVG LMR
SPC 11B10 GRENADIER M320 ILLUM NVG LMR
PFC 11B10 RIFLEMAN M4 ILLUM NVG LMR
PFC 11B10 RIFLEMAN M4 ILLUM NVG LMR JAVELIN

x6

DAGR
X9 LMR

SSG 11B30 SQD LDR M4 ILLUM NVG DAGR
HWTS AN/PLQ-8 LMR AN/PRC-148(V)4
SPC 11B10 MACHINEGUNNER M240B M9 ILLUM NVG LMR
SPC 11B10 MACHINEGUNNER M240B M9 ILLUM NVG LMR
PFC 11B10 A SST GUNNER M4 ILLUM NVG LMR
PFC 11B10 A SST GUNNER M4 ILLUM NVG LMR

x2

RIFLE COMPANY, INFANTRY BN, SBCT

RIFLE PLT HQ PARA 07

X2 AN/PRC-119F
2 DAGR

1LT 11A00 PLT LDR M4 ILLUM ENVG
DAGR AN/PRC-119F HWTS
AN/PRC-148(V)4
SFC 11B4G PLT SGT M4 ILLUM ENVG
DAGR AN/PRC-119F AN/PRC-148(V)4
PFC 11B10 RTO M4 ILLUM NVG

RIFLE PLT MOUNTED ELEMENT PARA 08

FBCB2
AN/VAS-5
STORM
DAGR
EPLRS-V1
AN/VRC-91F
AN/UJK-128(V)1
HWTS
.50 CAL



SGT 11B20 IAV CDR M4 ILLUM NVG
SPC 11B10 IAV DVR M4 ILLUM NVG

FBCB2
AN/VAS-5
STORM
DAGR
EPLRS-V1
AN/VRC-91F
AN/UJK-128(V)1
HWTS
MK-19



SGT 11B20 IAV CDR M4 ILLUM NVG
SPC 11B10 IAV DVR M4 ILLUM NVG

X2

RIFLE SQUAD PARA 09

DAGR
X9 LMR

SSG 11B30 SQD LDR M4 ILLUM ENVG DAGR HWTS
AN/PLQ-8 LMR AN/PRC-148(V)4
SGT 11B20 TM LDR M4 ILLUM ENVG LMR
SGT 11B20 TM LDR M4 ILLUM ENVG LMR
SPC 11B10 AUTO RIFLEMAN M249 ILLUM NVG MWTS LMR
SPC 11B10 AUTO RIFLEMAN M249 ILLUM NVG MWTS LMR
SPC 11B10 GRENADIER M320 ILLUM ENVG LMR
SPC 11B10 GRENADIER M320 ILLUM ENVG LMR
PFC 11B10 RIFLEMAN M4 ILLUM NVG LMR
PFC 11B10 RIFLEMAN M4 ILLUM NVG LMR JAVELIN

x2

RIFLE SQUAD PARA 10

DAGR
x9 LMR

SSG 11B30 SQD LDR M4 ILLUM ENVG DAGR
HWTS AN/PLQ-8 LMR AN/PRC-148(V)4
SGT 11B20 FIRE TEAM LEADER M4
SGT 11B20 FIRE TEAM LEADER M4
SPC 11B10 AUTO RIFLEMAN M249 ILLUM
NVG MWTS LMR
SPC 11B10 AUTO RIFLEMAN M249 ILLUM
NVG MWTS LMR
SPC 11B10 GRENADIER M203
SPC 11B10 GRENADIER M203
PFC 11B10 A RIFLEMAN M4 ILLUM NVG LMR
PFC 11B10 A RIFLEMAN M4 ILLUM NVG LMR

WEAPONS SQUAD PARA 11

DAGR
X9 LMR

SSG 11B30 SQD LDR M4 ILLUM ENVG DAGR
HWTS AN/PLQ-8 LMR AN/PRC-148(V)4
SPC 11B10 MACHINEGUNNER M240B M9
ILLUM ENVG LMR
SPC 11B10 MACHINEGUNNER M240B M9
ILLUM ENVG LMR
PFC 11B10 ASST GUNNER M4 ILLUM NVG
LMR
PFC 11B10 ASST GUNNER M4 ILLUM NVG
LMR

MORTAR SECTION PARA 12

M240B MWTS
FBCB2 X2 DAGR
AN/VAS-5 EPLRS-V1
AN/VRC-91F M32 LHMBC
AN/UJK-128(V)1
60MM MORTAR
120MM MORTAR



SSG 11C30 SECT LDR M4 ILLUM NVG
SPC 11C10 GNR M4 ILLUM NVG
SPC 11C10 IAV DVR M4 ILLUM NVG
PFC 11C10 A GNR M4 ILLUM NVG
PFC AMMO BEARER M4 ILLUM NVG

M240B MWTS
FBCB2 X2 DAGR
AN/VAS-5 EPLRS-V1
AN/VRC-91F M32 LHMBC
AN/UJK-128(V)1
60MM MORTAR
120MM MORTAR



SGT 11C20 SQD LDR M4 ILLUM NVG
SPC 11C10 GNR M4 ILLUM NVG
SPC 11C10 IAV DVR M4 ILLUM NVG
PFC 11C10 A GNR M4 ILLUM NVG
PFC AMMO BEARER M4 ILLUM NVG

MOBILE GUN SYS PLATOON PARA 13

FBCB2
AN/VAS-5
MG 7.62MM RH FEED
DAGR
EPLRS-V1
AN/VRC-89F
HWTS
.50 CAL
AN/UJK-128(V)1
2X M4 RIFLE



1LT 19B00 PLT LDR M9 ILLUM NVG
SGT 19K20 GUNNER M9 ILLUM NVG
SPC 19K10 DRIVER M9 ILLUM NVG

FBCB2
AN/VAS-5
MG 7.62MM RH FEED
DAGR
EPLRS-V1
AN/VRC-89F
HWTS
.50 CAL
AN/UJK-128(V)1
2X M4 RIFLE



SFC 19K40 M9 ILLUM NVG
SGT 19K20 GUNNER M9 ILLUM NVG
SPC 19K10 DRIVER M9 ILLUM NVG

FBCB2
AN/VAS-5
MG 7.62MM RH FEED
DAGR
EPLRS-V1
AN/VRC-89F
HWTS
.50 CAL
AN/UJK-128(V)1
2X M4 RIFLE



SSG 19K30 MGS CDR M9 ILLUM NVG
SGT 19K20 GUNNER M9 ILLUM NVG
SPC 19K10 DRIVER M9 ILLUM NVG

EQUIPMENT SUMMARY

WEAPONS			COMMUNICATIONS AND ELECTRONICS		
C60750	COMMAND LAUNCH UNIT: (JAVELIN) 13305405-119	9	C18378	COMPUTER SET: AN/UYPK-128(V)3	22
L69080	LAUNCHER GRENADE: M320A1	19	C27707	COMPUTER SYSTEM: DIGITAL AN/TYQ-109(V)1	1
M09009	MACHINE GUN 5.56 MILLIMETER: M249	18	N96248	NAVIGATION SET: SATELLITE SIGNALS AN/PSN-13	47
M67939	MORTAR 60 MILLIMETER: ON MOUNT M170 CANNON M225 W/E	2	P49587	PJH SURFACE VEHICLE RADIO SET: AN/VSQ-2(V)	22
M92362	MACHINE GUN GRENADE 40MM: MK19 MOD III	7	P99881	PROCESSOR GROUP SIG DATA: (CAISI 2.0) OL-701A/TYQ	1
M92420	MACHINE GUN 7.62 MILLIMETER: FIXED RH FEED	3	R44999	RADIO SET: AN/VRC-89F(C)	3
M92454	MACHINE GUN 7.62 MILLIMETER: M240L	6	R45543	RADIO SET: AN/VRC-92F(C)	2
M92841	MACHINE GUN: 7.62MM M240B	2	R68044	RADIO SET: AN/VRC-90F(C)	3
P98152	PISTOL 9MM AUTOMATIC: M9	17	R68146	RADIO SET: AN/VRC-91F(C)	16
R45351	RIFLE SNIPER .50 CALIBER: M107	1	R83141	RADIO SET: AN/PRC-119F(C)	10
R45601	RIFLE SNIPER: M110	1	T40405	TAPE READER GENERAL PURPOSE: KOI-18/TSEC	1
R97234	RIFLE 5 56 MILLIMETER: M4	135	Z00384	COMPUTER SYSTEM DIGITAL: AN/PYQ-10(C)	48
S40541	SHOTGUN: 12 GAGE	18	Z00862	LAND MOBILE RADIO: (LMR)	96
S45729	SIGHT BORE OPTICAL: M150	53	Z01247	COMPUTER SET: DIGITAL AN/UYPK-128(V)1	22
Z00686	MACHINE GUN: CALIBER .50	12	Z01320	RADIO SET: AN/PRC-148 (V) 4 URBAN JEM	18
VEHICLES, TRAILERS AND TRLR MTD SYSTEMS			MISC EQUIPMENT		
J22626	INFANTRY CARRIER: VEHICLE (ICV)	14	C05701	MONITOR CHEMICAL AGENT:	2
M53369	MORTAR CARRIER VEHICLE: (MCV) W/60MM AND 120MM	2	G18358	GEN SET: DED SKID MTD 3KW 60HZ	1
M57720	MOBILE GUN SYSTEM: (MGS)	3	M12986	MASK CHEMICAL BIOLOGICAL JOINT SERVICE GENERAL PURPOSE: FIELD M50	112
T37588	TRUCK UTILITY EXPANDED CAPACITY ENHANCED: M1152A1	1	M13236	MASK CHEMICAL-BLGCAL JNT SRV GNL PRPSE: CMBT VHL CRWMN M51	51
T41515	TRUCK CARGO: 5 TON WO/WINCH	2	M32043	M32 LIGHTWEIGHT HAND-HELD: MORTAR BALLISTIC COMPUTER (LHMBC)	2
T56383	TRUCK UTILITY EXPANDED CAPACITY ENHANCED 4X4: M1165A1	1			
T95992	LIGHT TACTICAL TRAILER: 3/4 TON	1			
Z36683	TRAILER TANK WATER (CAMEL): 800 GAL 5 TON W/E	2			
NIGHT VISION/OBSERVATION					
D41659	DRIVERS ENHANCERS: AN/VAS-5	23			
J03261	ILLUMINATOR: INFRARED	163			
J68653	ILLUMINATOR INTEGRATED: SMALL ARMS STORM MLRF	15			
M79678	MONOCULAR NIGHT VISION DEVICE: AN/PVS-14	63			
N05482	NIGHT VISION: GOGGLE	53			
N07848	NIGHT VISION DEVIC: AN/PSQ-20	65			
S60342	SIGHT NIGHT VISION (SNS): AN/PVS-29	1			
S60356	SIGHT: THERMAL AN/PAS-13B(V)1	18			
S90535	MEDIUM WEAPON THERMAL SIGHT (MWTS): AN/PAS-13(V)2	26			
S90603	HEAVY WEAPON THERMAL SIGHT (HWTS): AN/PAS-13(V)3	35			
T27221	TARGET LOCATION AND OBSERVATION: AN/PLQ-8	13			

RIFLE COMPANY, INFANTRY BN, SBCT

HHB, FIRES BN, SBCT

06326R100
16/076/92

COMMAND SECTION PARA 01

CURRENT OPS – INTEL/S2 PARA 02

CURRENT OPS – OPS/S3 PARA 03

MISSION: To provide command, control and administrative supervision of organic and attached Field Artillery units

FBCB2
AN/GYK-48(V)1
AN/VAS-5
STORM
2X NVG
DAGR
EPLRS
AN/VRC-92F
AN/VRC-106(V)1
HWTS
.50 CAL



LTC 13A00 CDR M4 M9
PFC 13D10 DRIVER M4

FBCB2
AN/VAS-5
2X NVG
DAGR
EPLRS
AN/VRC-92F
AN/UYK-128(V)1



MAJ 13A00 BN XO M4 M9
CSM 00Z50 CSM M4 M9
SPC 13D10 FATDS SP M4

FBCB2
AN/VAS-5
2X NVG
DAGR
EPLRS
AN/VRC-92F
AN/UYK-128(V)1
AN/GYK-56



CPT 35D00 M4
SPC 35F10 INTEL ANLST M4
MSG 13Z50 INTEL SGT M4
PFC 35F10 INTEL ANLST M4

FBCB2
AN/VAS-5
2X NVG
DAGR
EPLRS
AN/VRC-92F
AN/PSC-5
AN/VRC-106(V)1
AN/VRC-104(V)3
AN/UYK-128(V)1





AN/TYQ-93
M240B
MWTS

AN/GYG-1(V)1
AN/TYQ-129(V)2
COMPUTER SYS DIGITAL
AN/GYK-48(V)1
M240B
MWTS
KOI-18/TSEC

2X NVG
DAGR
AN/VRC-90F

FBCB2
AN/VAS-5
2X NVG
DAGR
EPLRS
3X AN/VRC-92F
AN/VRC-106(V)1
AN/VRC-104(V)3
AN/UYK-128(V)1



CPP RWS
MED PWR PLANT

MAJ 13A00 S3 M4 M9
SPC 13D10 FATDS SP M4
CPT 13A00 OPS OFF M4
1LT 74A00 CHEM OFF M4
MSG 13Z50 OPS SGT M4
SSG 13T30 CHIEF OF PARTY M4
SSG 29E30 EW SGT M4
SSG 74D30 CBRN NCO M4
SGT 29E20 EW SGT M4

AN/MJQ-48 PU
PU 805 A UNIT
PU 805 B UNIT



SGT 74D20 CBRN NCO M4
SPC 74D10 CBRN DECON SP M4
PFC 13D10 FATDS SP M4
SPC 13D10 FATDS SP M4
PFC 13D10 FATDS SP M4
SFC 13B40 OPS SGT M4

CURRENT OPS – FDC PARA 04

SUSTAINMENT – S1 PARA 05 SUSTAINMENT – S4 PARA 06

SUSTAINMENT – UMT PARA 07

FBCB2
AN/VAS-5
2X NVG
EPLRS
AN/VRC-92F
AN/PSC-5
AN/UYK-128(V)1



HWTS
.50 CAL
KOI-18/TSEC

CPT 13A00 FIRE DIR OFF M4
PFC 13D10 FATDS SP M4

AN/VAS-5
2X NVG
DAGR
AN/VRC-90F



SFC 13D40 CH FIRE CONTROL SGT M4
SSG 13D30 FIRE CONT SGT M4
SGT 13D20 FIRE CONT SGT M4
SPC 13D10 FATDS SP M4
SPC 13D10 FATDS SP M4

AN/GYG-1(V)3 M240B
2X AN/PYQ-1 MWTS
AN/VAS-5 AN/VRC-104(V)3
2X NVG
DAGR
AN/VRC-92F



PFC 13D10 FATDS SP M4

FBCB2
2X NVG
DAGR
AN/VRC-90F
AN/UYK-128(V)1



M240B
OL-701A/TYQ
MWTS
HWTS
.50 CAL
4X ARMY HR
WORKSTATIONS

CPT 42B00 S1 M4
SFC 42A40 SR HR SGT M4
SSG 42A30 HR SGT M4
SGT 42A20 HR SGT M4
SPC 27D10 PARALEGAL M4
SPC 42A10 HR SP M4
SPC 42A10 HR SP M4
PFC 42A10 HR SP M4
PFC 42A10 HR SP M4

AN/TYQ-129(V)2
AN/TYQ-109(V)1
AN/UYQ-90(V)3
AN/VAS-5
2X NVG
DAGR
AN/VRC-92F
AN/VRC-90F



COMPUTER SYS DIGITAL
M240B
OL-701A/TYQ
AN/VRC-104(V)3
MWTS
HWTS
KOI-18/TSEC
.50 CAL

SFC 92Y40 SR SUPPLY SGT M4
SPC 92Y10 SUPPLY SP M4
SGT 92Y20 SUPPLY NCO M4

FBCB2
AN/VAS-5
2X NVG
DAGR
EPLRS
AN/VRC-90F
AN/UYK-128(V)1



MED PWR PLANT

1LT 13A00 AMMO OFF M4
CPT 13A00 S4 M4
SFC 13B40 AMMO NCO M4

FBCB2
AN/VAS-5
2X NVG
DAGR
EPLRS
AN/VRC-90F
AN/UYK-128(V)1



CPT 56A CHAPLAIN
SPC 56M1- CHAPLAIN ASST M4

HHB, FIRES BN, SBCT

SUSTAINMENT – C4 OPS/S6 PARA 08

FBCB2
AN/VAS-5
2X NVG
DAGR
EPLRS
AN/VRC-92F
2X AN/UYK-128(V)1

M240B
MWTS
KOI-18/TSEC
AN/GYK-62B



CPT 25A00 S6 M4
PFC 25U10 SIG SPT SYS SP M4
SFC 25U40 SECT CH M4
SPC 25U10 SIG INFO SVC SP M4
PFC 25U10 SIG SPT SYS MAINT M4

NETWORK MANAGEMENT TEAM PARA 09

FBCB2
AN/VAS-5
2X NVG
DAGR
EPLRS
AN/VRC-90F
AN/UYK-128(V)1

AN/TSQ-243
EPLRS
AN/USQ-165



SPC 25B10 LAN MGR M4
PFC 25B10 LAN MGR M4

NETWORK OPERATIONS PARA 10

FBCB2
AN/VAS-5
2X NVG
DAGR
EPLRS
AN/VRC-90F
AN/UYK-128(V)1

AN/PYQ-12
AN/TSR-8
AN/VRC-106(V)2
AN/GYK-50B



PU 798

FBCB2
AN/VAS-5
2X NVG
DAGR
EPLRS
AN/VRC-90F

BCP (SWITCHING GP):
OM-87A/T



SGT 25Q20 SR XMSN SYS OPR M4
SPC 25Q10 XMSN SYS OPR M4

RETRANSMISSION SECTION PARA 11

FBCB2
AN/VAS-5
2X NVG
DAGR
EPLRS
2X AN/VRC-92F
AN/UYK-128(V)1

M249
MWTS



SSG 25U30 TM CH M4
PFC 25U10 RETRANS OPR M4
SPC 25U10 RETRANS OPR M4

FBCB2
AN/VAS-5
2X NVG
DAGR
MWTS
EPLRS
2X AN/VRC-92F
AN/UYK-128(V)1



SGT 25U20 TM CH M4
PFC 25U10 RETRANS OPR M4
SPC 25U10 RETRANS OPR M249

BATTERY HEADQUARTERS PARA 12

FBCB2
AN/VAS-5
2X NVG
DAGR
EPLRS
AN/VRC-91F
AN/UYK-128(V)1



CPT 13A00 CDR M4 M9
PFC 13D10 DRIVER M4

AN/VAS-5
2X NVG
DAGR
AN/VRC-89F
AN/UYK-128(V)1



1LT 13A00 EXEC OFF M4
1SG 13Z5M 1SG M4
SPC 13D10 FATDS SP M4

BATTERY SUPPLY SECTION PARA 13

OL-701A/TYQ
HWTS
.50 CAL



SSG 92Y30 SUPPLY SGT M4
SPC 92Y10 SUPPLY SP M4

FBCB2
2X NVG
DAGR
AN/VRC-90F
AN/UYK-128(V)1

DECON



x2

MEDICAL PLT HQ PARA 14

FBCB2
AN/VAS-5
2X NVG
DAGR
EPLRS
AN/VRC-89F
AN/UYK-128(V)1



1LT 70B67 FIELD MED ASST M4
SFC 68W40 PLT SGT M4

MEDICAL TREATMENT TEAM PARA 15

FBCB2
AN/VAS-5
2X NVG
DAGR
EPLRS
AN/VRC-90F
AN/UYK-128(V)1

AN/TYQ-106(V)1
4X AN/TYQ-105(V)1
OL-701A/TYQ



CPT 65D00 PA M9
SPC 68W10 HLTH CARE SP M4

FBCB2
AN/VAS-5
2X NVG
DAGR
EPLRS
AN/VRC-90F
AN/UYK-128(V)1



SSG 68W30 HLTH CARE SGT M4
PFC 68W10 HLTH CARE SP M4

AMBULANCE TEAM PARA 16

FBCB2
AN/VAS-5
2X NVG
DAGR
EPLRS
AN/VRC-90F
AN/UYK-128(V)1



SGT 68W20 ER CARE SGT M4 AN/TYQ-105(V)1
SPC 68W10 AMB AIDE/DRIVER M4
PFC 68W10 DRIVER M4 AN/TYQ-105(V)1

x3

COMBAT MEDIC SECTION PARA 17

x6 AN/TYQ-105(V)1

SPC 68W10 COMBAT MEDIC M9

x6

EQUIPMENT SUMMARY

WEAPONS			COMMUNICATIONS AND ELECTRONICS		
L69080	LAUNCHER GRENADE: M320A1	4	A35329	ALL SOURCE ANALYSIS SYSTEM: AN/TYQ-93	1
M39263	MACHINE GUN: LIGHT 5.56MM M249	2	C17936	COMPUTER SET: AN/GYG-1(V)1	1
M92362	MACHINE GUN GRENADE 40MM: MK19 MOD III	2	C18004	COMPUTER SET: AN/GYG-1(V)3	1
M92841	MACHINE GUN: 7.62MM M240B	6	C18277	COMPUTER SET: DIGITAL AN/TYQ-107(V)1	1
P98152	PISTOL 9MM AUTOMATIC: M9	9	C18345	COMPUTER SET: DIGITAL AN/TYQ-106(V)1	2
R97234	RIFLE 5 56 MILLIMETER: M4	82	C18378	COMPUTER SET: AN/UYPK-128(V)3	24
Z00686	MACHINE GUN: CALIBER .50	5	C18641	COMPUTER SYST DIGITAL: AN/PYQ-12	1
VEHICLES, TRAILERS AND TRLR MTD SYSTEMS			C27435	COMPUTER SYSTEM: DIGITAL AN/TYQ-129(V)2	2
C41314	COMMAND VARIANT VEH: (CV)	1	C27503	COMPUTER SYSTEM: DIGITAL AN/TYQ-105(V)1	13
P63462	POWER PLANT: UTILITY (MEDIUM)	2	C27707	COMPUTER SYSTEM: DIGITAL AN/TYQ-109(V)1	2
T37588	TRUCK UTILITY EXPANDED CAPACITY ENHANCED: M1152A1	8	C27963	COMPUTER SYSEM: DIGITAL	4
T38844	TRUCK AMBULANCE: 4 LITTER ARMD 4X4 W/E (HMMWV)	3	C40996	COMMAND SYSTEM: TACTICAL	2
T41515	TRUCK CARGO: 5 TON WOWINCH	6	C41314	COMMAND VARIANT VEH: (CV)	1
T56383	TRUCK UTIL EXPANDED CAPACITY ENHANCED 4X4: M1165A1	12	C53293	CT SY D: AN/PYG-1	2
T61908	TRUCK CARGO: MTV W/E	1	C61665	COMMAND CENTER SYSTEM: AN/TSQ-243	1
T95555	TRAILER CARGO: MTV W/DROPSIDES M1095	3	C78851	COMPUTER SYSTEM: DIGITAL AN/UYPK-90(V)3	1
T95924	TRAILER CARGO: HIGH MOBILITY 1-1/4 TON	8	C79281	COMPUTER ST FIELD ARTILLERY GENERAL: AN/GYK-48(V)1	2
Z01414	LTT TRAILER-MTD: PU-2002/ 10 KW/ 50/60HZ	1	N96248	NAVIGATION SET: SATELLITE SIGNALS AN/PSN-13	31
Z01437	TRLR MTD: PP-3003/15 KW 50/60HZ	1	P49587	PJH SURFACE VEHICLE RADIO SET: AN/VSQ-2(V)	25
Z36683	TRAILER TANK WATER (CAMEL): 800 GAL 5 TON W/E	1	P99881	PROCESSOR GROUP SIG DATA: (CAISI 2.0) OL-701A/TYQ	5
NIGHT VISION/OBSERVATION			R44999	RADIO SET: AN/VRC-89F(C)	2
D41659	DRIVERS ENHANCERS: AN/VAS-5	27	R45543	RADIO SET: AN/VRC-92F(C)	18
J68653	ILLUMINATOR INTEGRATED: SMALL ARMS STORM MLRF	1	R45710	RADIO SET: AN/VRC-106(V)2 (C)	1
N05482	NIGHT VISION: GOGGLE	65	R57606	RADIO SET: AN/PSC-5	2
S90535	MEDIUM WEAPON THERMAL SIGHT (MWTS): AN/PAS-13(V)2	8	R67296	RADIO SET: AN/VRC-87F(C)	1
S90603	HEAVY WEAPON THERMAL SIGHT (HWTS): AN/PAS-13(V)3	7	R68044	RADIO SET: AN/VRC-90F(C)	16
MISC EQUIPMENT			R68146	RADIO SET: AN/VRC-91F(C)	1
C05701	MONITOR CHEMICAL AGENT:	2	R68566	RADIO SET: AN/VRC-106(V)1 (C)	3
C79000	COLLECTIVE PROTECTION EQUIPMENT: NBC SIMPLIFIED M20	4	R87139	RADIO SET: AN/VRC-104(V)3 W/PRC-150 HF RADIO	5
D82404	DECONTAMINATING APPARATUS: PWR DRVN LT WT	2	R93169	RADIO TEST SET: AN/PRM-34()	4
G18358	GEN SET: DED SKID MTD 3KW 60HZ	5	T40405	TAPE READER GENERAL PURPOSE: KOI-18/TSEC	4
J00697	JOINT CHMCL AGENT: DETECTOR	8	Z00129	COMPUTER SET FIELD ARTILLERY GENERAL: AN/GYK-56	1
J01197	JOINT SERVICE: TRANSPORTABLE DECONTAMINATION	2	Z00384	COMPUTER SYSTEM DIGITAL: AN/PYQ-10(C)	34
M12986	MASK CHEMICAL BIOLOGICAL JOINT SERVICE GENERAL PURPOSE: FIELD M50	75	Z00513	COMPUTER SYSTEM DIGITAL: AN/GYK-50B (ISYSCON) (V)4	1
M13236	MASK CHEMICAL-BLGCCL JNT SRV GNL PRPSE: CMBT VHL CRWMN M51	11	Z00564	BATTALION COMD POST(SWITCHING GROUP): OM-XXX	1
R20684	RADIAC SET: AN/VDR-2	10	Z01247	COMPUTER SET: DIGITAL AN/UYPK-128(V)1	22
R30925	RADIAC SET: AN/PDR-75	1	Z01248	COMPUTER SET: DIGITAL AN/GYK-62B	1
R31061	RADIAC SET: AN/UDR-13	11	Z39781	ARMY H RESURCES: WRKSTATION	5
			Z70024	COMMUNICATION SUBSYSTEM: AN/USQ-165	1

SBCT Fires Battalion, (3x6)
155T
(CONSOLIDATION FOR TRAINING)

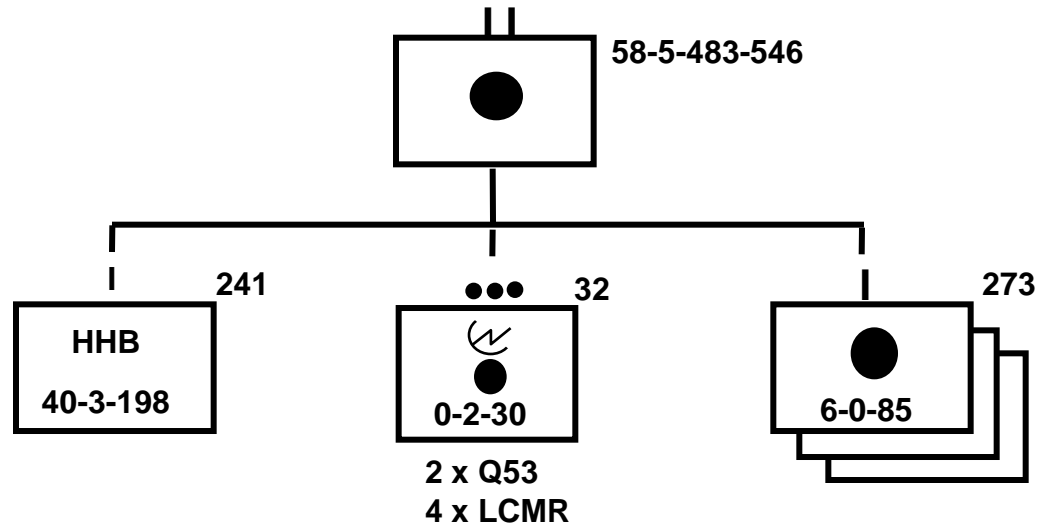

HHB, Fires Battalion, 155T (CONSOLIDATION FOR TRAINING)

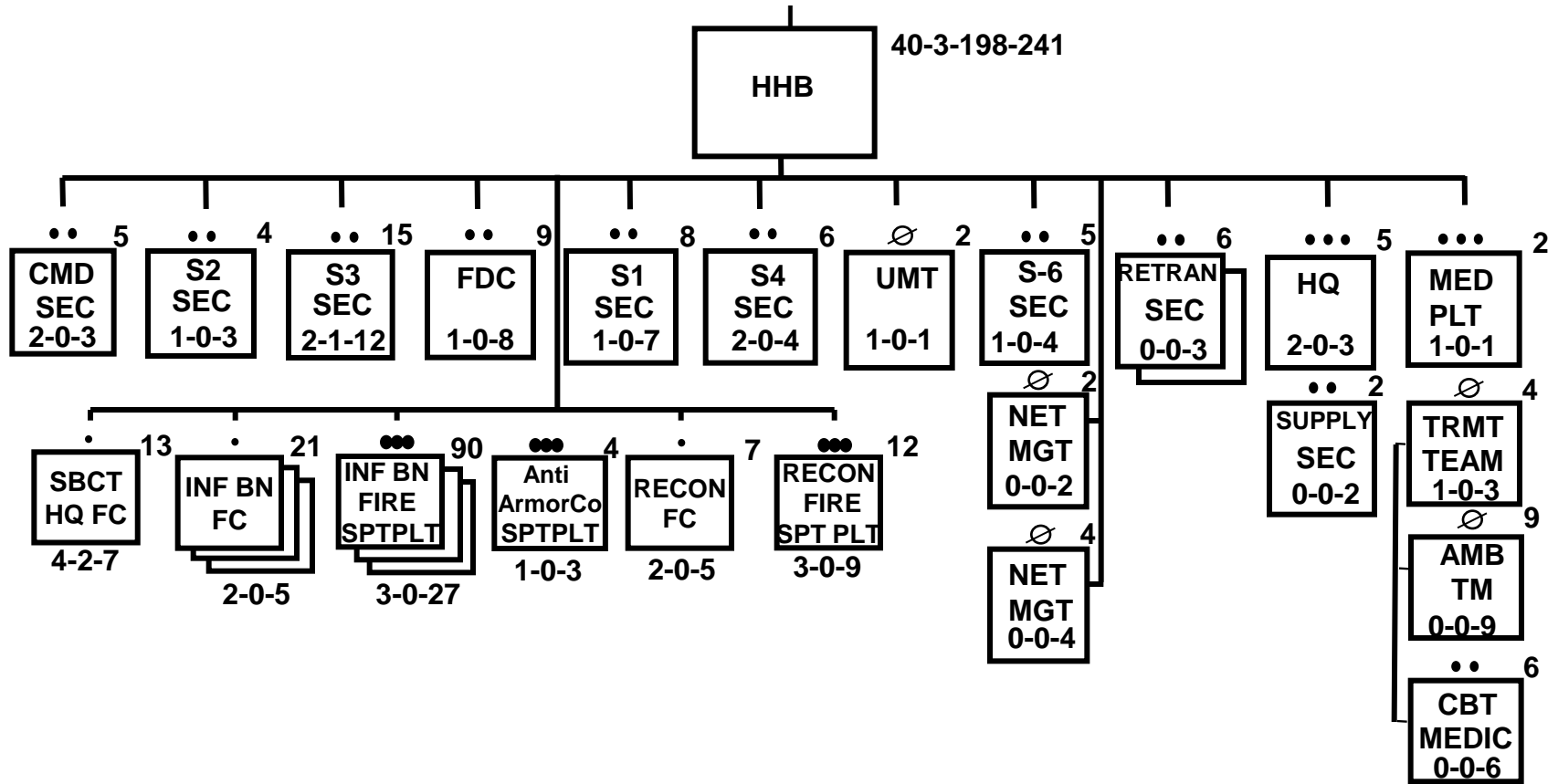

FIRES BATTERY, FIRES BN, SBCT

06327R000
5/0/85/90

BATTERY HEADQUARTERS PARA 01

SUPPLY SECTION PARA 02

FIRING PLATOON HEADQUARTERS PARA 03

**MISSION: To
destroy, neutralize
or suppress
the enemy with
cannon fire.**

FBCB2
AN/VAS-5
2X NVG
DAGR
EPLRS-V1
AN/VRC-92F
2X AN/UYK-128(V)1



CPT 13A00 CDR M4 M9
PFC 13D10 DRIVER M4
1SG 13Z5M 1SG M4
SSG 25U30 FWD SIG SPT NCO M4

FBCB2 AN/TYQ=109(V)1
AN/VAS-5 OL-701A/TYQ
2X NVG
EPLRS-V1
DAGR
AN/VRC-90F
AN/UYK-128(V)1



SGT 92Y20 SUPPLY NCO M4
SPC 92Y10 SUPPLY SP M4

FBCB2
AN/VAS-5
2X NVG
DAGR
EPLRS-V1
AN/VRC-92F
2X AN/UYK-128(V)1



1LT 13A00 PLT LDR M4
SFC 13B40 GUNNERY SGT M4

FBCB2
AN/VAS-5
2X NVG
DAGR
EPLRS-V1
AN/VRC-92F
2X AN/UYK-128(V)1



SFC 13B40 PLT SGT M4
SPC 12D10 FA WPNS MECH M4

x2

FIRE DIRECTION CENTER (FDC) PARA 04

HOWITZER SECTION (155T) PARA 05

AN/PYG-1
AN/VRC-90F



1ILT 13A00 FIRE DIR OFF M4
SGT 13D20 FIRE CONT SGT M4
SPC 13D10 FATDS SP M4
PFC 13D10 FATDS SP M4

AN/PYG-1
FBCB2
X2 NVG
DAGR
FHMUX
EPLRS-V1
AN/VRC-90F
X2 AN/VRC-92F
AN/VRC-104(V)3
AN/UYK-128(V)1



SSG 13D30 FIRE CONT SGT M4
SPC 13D10 FATDS SP M4
SPC 13D10 FATDS SP M4
PFC 13D10 FATDS SP M4

x2

FBCB2
AN/VAS-5
X2 NVG
DAGR
EPLRS-V1
HWTS
AN/VRC-91F
AN/UYK-128(V)01



SSG 13B30 SECT CH M4
SGT 13B20 GUNNER M4
SPC 13B10 ASST GUNNER M4
SPC 13B10 PRIME MOVER DRIVER M4
PFC 13B10 CANNONEER M4
PFC 13B10 CANNONEER M4

FBCB2
AN/VAS-5
X2 NVG
DAGR
EPLRS-V1
AN/VRC-90F
HWTS
AN/UYK-128(V)1



SGT 13B20 GUNNER/AMMO TM CH M4
SPC 13B10 CANNONEER M4
SPC 13B10 CANNONEER M4
PFC 13B10 CANNONEER M4

x6

EQUIPMENT SUMMARY

WEAPONS

L69080	LAUNCHER GRENADE: M320A1	10
M92362	MACHINE GUN GRENADE 40MM: MK19 MOD III	8
M92841	MACHINE GUN: 7.62MM M240B	10
P98152	PISTOL 9MM AUTOMATIC: M9	1
R97234	RIFLE 5 56 MILLIMETER: M4	89
Z00686	MACHINE GUN: CALIBER .50	7

VEHICLES, TRAILERS AND TRLR MTD SYSTEMS

H57916	HOWITZER MEDIUM TOWED: M777	6
T37588	TRUCK UTIL EXPANDED CAPACITY ENHANCED: M1152A1	4
T41447	TRUCK CARGO: 5 TON W/WINCH	6
T41515	TRUCK CARGO: 5 TON WO/WINCH	1
T56383	TRUCK UTIL EXPANDED CAPACITY ENHANCED 4X4: M1165A1	5
T59584	TRUCK CARGO: W/MHE WO/WINCH	6
T61908	TRUCK CARGO: MTV W/E	1
T95555	TRAILER CARGO: MTV W/DROPSIDES M1095	6
T95924	TRAILER CARGO: HIGH MOBILITY 1-1/4 TON	3
Z36683	TRAILER TANK WATER (CAMEL): 800 GAL 5 TON W/E	1

NIGHT VISION/OBSERVATION

N05482	NIGHT VISION: GOGGLE	54
S90535	MEDIUM WEAPON THERMAL SIGHT (MWTS): AN/PAS-13(V)2	10
S90603	HEAVY WEAPON THERMAL SIGHT (HWTS): AN/PAS-13(V)3	15

COMMUNICATIONS AND ELECTRONICS

C17936	COMPUTER SET: AN/GYG-1(V)1	2
C18378	COMPUTER SET: AN/UYPK-128(V)3	20
C27707	COMPUTER SYSTEM: DIGITAL AN/TYQ-109(V)1	1
C53293	CT SY D: AN/PYG-1	4
F99520	FREQ HOPING MULTIPLEX: TD-1456VRC	2
N96248	NAVIGATION SET: SATELLITE SIGNALS AN/PSN-13	25
P49587	PJH SURFACE VEHICLE RADIO SET: AN/VSQ-2(V)	20
P99881	PROCESSOR GRP SIG DATA: (CAISI 2.0) OL-701A/TYQ	1
Q77755	RADIO SET CONTROL: C-2328/GRA-39	8
R20758	RADAR CHRONOGRAPH SET: MVS CONVENTIONAL	6
R44999	RADIO SET: AN/VRC-89F(C)	2
R45543	RADIO SET: AN/VRC-92F(C)	7
R68044	RADIO SET: AN/VRC-90F(C)	11
R68146	RADIO SET: AN/VRC-91F(C)	6
R87139	RADIO SET: AN/VRC-104(V)3 W/PRC-150 HF RADIO	2
R93169	RADIO TEST SET: AN/PRM-34()	1
T40405	TAPE READER GENERAL PURPOSE: KOI-18/TSEC	1
Z00384	COMPUTER SYSTEM DIGITAL: AN/PYQ-10(C)	26
Z01247	COMPUTER SET: DIGITAL AN/UYPK-128(V)1	26

MISC EQUIPMENT

C05701	MONITOR CHEMICAL AGENT:	6
G36169	GENERATOR SET DIESEL: 28V DC MEP-501A	1
J00697	JOINT CHMCL AGENT: DETECTOR	3
M12986	MASK CHEMICAL BIOLOGICAL JOINT SERVICE GENERAL PURPOSE: FIELD M50	84
M13236	MASK CHEMICAL-BIOLOGICAL JOINT SERVICE GENERAL PURPOSE: CMBT VHL CRWMN M51	6
R20684	RADIAC SET: AN/VDR-2	5
R30925	RADIAC SET: AN/PDR-75	3
R31061	RADIAC SET: AN/UDR-13	4
Z00384	COMPUTER SYSTEM DIGITAL: AN/PYQ-10(C)	26
Z01247	COMPUTER SET: DIGITAL AN/UYPK-128(V)1	26

FIRES BATTERY, FIRES BN, SBCT

Target Acquisition PLT

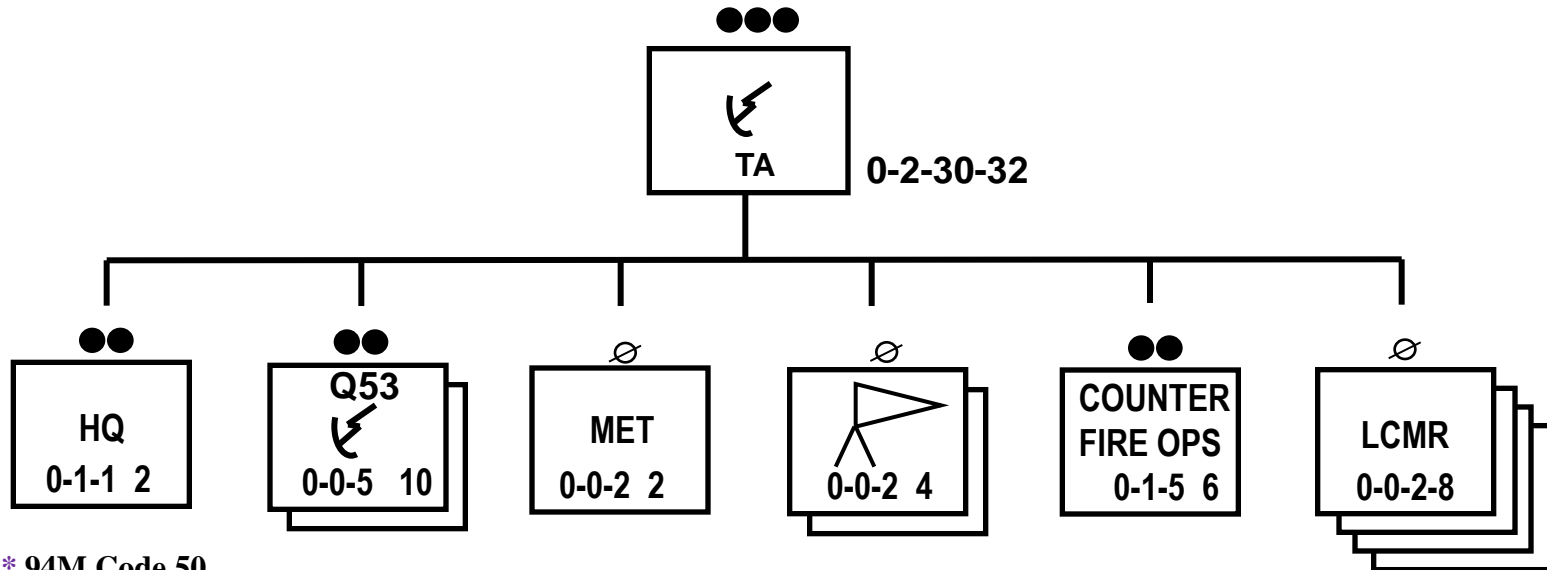

* 94M Code 50

* Code 50 accounted for on SRC 63 not included in total

TARGET ACQUISITION PLATOON, FIRES BN, SBCT

MISSION.

06530RA00
0/1/1/2

To provide command and control for organic or assigned Field Artillery target acquisition assets.

TARGET ACQUISITION PLATOON HQ PARA 01

FBCB2 AN/PSG-14(V)1
AN/VAS-5 M240B
x2 NVG MWTS
DAGR KOI-18/TSEC
AN/VRC-92F



CW2 131A0 PLT LDR M4
SFC 13R40 PLT SGT M4

EQUIPMENT SUMMARY

WEAPONS

LAUNCHER GRENADE: M320A1----- 1
MACHINE GUN 7.62MM M240B----- 1
RIFLE 5.56MM M4 CARBINE----- 2

VEHICLES, TRAILERS, AND TRLR MTD SYSTEMS

TRUCK UTILITY EXP CAPACITY ENH 4X4: M1165A1----- 1
TRAILER HIGH MOBILITY 1-1/4T (M1102)----- 1

NIGHT VISION/OBSERVATION EQUIPMENT

DRIVERS VISION ENHANCER: AN/VAS-5----- 1
NIGHT VISION GOGGLES: AN/PVS-7B----- 2
SIGHT THERMAL: AN/PAS-13B(V)2 MEDIUM TWS----- 1

COMMUNICATION-ELECTRONICS EQUIPMENT

ANTENNA GROUP: OE-254----- 1
COMPUTER SYSTEM DIGITAL: AN/PSG-14(V)1 LFED----- 1
COMP SET DIGITAL: AN/UJK-128(V)3 (FBCB2 BFT APPLIQUE)----- 1
NAVIGATION SET: SATELLITE SIGNALS AN/PSN-13 (DAGR)----- 1
RADIAC SET: AN/VDR-2----- 1
RADIO SET: AN/VRC-92F----- 1

WLRS, (TPQ-36), FIRES BN, SBCT

MISSION.

06530RB00
0/0/4/4

To locate enemy mortar firing positions in the area of operations.

WEAPONS LOCATING RADAR SECTION (TPQ-36) PARA 01

FBCB2 M240B FBCB2
AN/VAS-5 MWTS AN/VAS-5
x2 NVG
DAGR
AN/VRC-92F
AN/VRC-90F AN/VRC-90F



SSG 13R30 SECT CH M4
PFC 13R10 FF RADAR OPR M4



SGT 13R20 SR FF RADAR OPR M4

AN/VAS-5
x2 NVG
DAGR
AN/VRC-90F



SPC 13R10 FF RADAR OPR M4

AN/PU 799

EQUIPMENT SUMMARY

WEAPONS

LAUNCHER GRENADE: M320A1----- 1
MACHINE GUN 7.62MM M240B----- 1
RIFLE 5.56MM M4 CARBINE----- 4

VEHICLES, TRAILERS, AND TRLR MTD SYSTEMS

GENERATOR SET: DED TM: 10KW 400HZ PU-799----- 1
TRUCK UTILITY EXP CAPACITY ENH 4X4: M1152A1----- 3

MISCELLANEOUS EQUIPMENT

GEN SET: DED SKID MTD 10KW 400HZ (MEP -813A)----- 1
RADAR SET: AN/TPQ-36(V)10----- 1

COMMUNICATION-ELECTRONICS EQUIPMENT

ANTENNA GROUP: OE-254----- 2
COMP SET DIGITAL: AN/UJK-128(V)3 (FBCB2 BFT APPLIQUE)----- 1
NAVIGATION SET: SATELLITE SIGNALS AN/PSN-13 (DAGR)----- 3
RADIAC SET: AN/VDR-2----- 1
RADIO SET: AN/VRC-90F----- 3
RADIO SET: AN/VRC-92F----- 1

NIGHT VISION/OBSERVATION EQUIPMENT

DRIVERS VISION ENHANCER: AN/VAS-5----- 3
NIGHT VISION GOGGLES: AN/PVS-7B----- 6
MEDIUM WEAPON THERMAL SIGHT (MWTS): AN/PAS-13(V)2----- 1

WLRS, (TPQ-37), FIRES BN, SBCT

06530RC00
0/0/10/10

MISSION. To locate enemy artillery and rocket firing positions.

WEAPONS LOCATING RADAR SECTION (TPQ-37) PARA 01

FBCB2
AN/VAS-5
2X NVG
DAGR
EPLRS
AN/VRC-92F
AN/VRC-90F
AN/UYK-128(V)1

M240B
MWTS
60 KW GENERATOR
AN/VRC-90F
AN/TPQ-37(V)9

AN/VRC-90F

AN/VRC-90F



SFC 13R40 SR FA TGT NCO M4
SSG 13R30 SECT CH M4
PFC 13R10 FF RADAR OPR M4
PFC 13R10 FF RADAR OPR M4
PFC 13R10 FF RADAR OPR M4
SGT 13R20 SR FF RADAR OPR
SPC 13R10 FF RADAR OPR M4
SPC 13R10 FF RADAR OPR M4
PFC 13R10 FF RADAR OPR M4
SGT 13R20 SR FF RADAR OPR M4

EQUIPMENT SUMMARY

WEAPONS

L69080	LAUNCHER GRENADE: M320A1	1
M92841	MACHINE GUN: 7.62MM M240B	1
R97234	RIFLE 5 56 MILLIMETER: M4	10

VEHICLES, TRAILERS AND TRLR MTD SYS

A41666	RADAR SET: AN/TPQ-37(V)9	1
T37588	TRUCK UTIL EXPANDED CAP ENHANCED: M1152A1	1
T41515	TRUCK CARGO: 5 TON WO/WINCH	1
T56383	TRUCK UTIL EXPD CAP ENHANCED 4X4: M1165A1	2
Z01381	TRAILER-MTD: PU-2113/60 KW/400HZ/ M200A1	1

NIGHT VISION/OBSERVATION

D41659	DRIVERS ENHANCERS: AN/VAS-5	2
N05482	NIGHT VISION: GOGGLE	8
S90535	MED WPN THERMAL SIGHT (MWTS): AN/PAS-13(V)2	1

COMMUNICATIONS AND ELECTRONICS

C18378	COMPUTER SET: AN/UYK-128(V)3	1
N96248	NAVIGATION SET: SATELLITE SIGNALS AN/PSN-13	2
P49587	PJH SURFACE VEHICLE RADIO SET: AN/VSQ-2(V)	1
R45543	RADIO SET: AN/VRC-92F(C)	1
R68044	RADIO SET: AN/VRC-90F(C)	2
Z00384	COMPUTER SYSTEM DIGITAL: AN/PYQ-10(C)	2
Z01247	COMPUTER SET: DIGITAL AN/UYK-128(V)1	2

MISC EQUIPMENT

M12986	MASK CHEMICAL BIOLOGICAL JOINT SERVICE GENERAL PURPOSE: FIELD M50	10
R20684	RADIAC SET: AN/VDR-2	1
R31061	RADIAC SET: AN/UDR-13	1
Z01339	GEN SET DED 60KW 400HZ: SKID-MTD	1
Z01381	TRAILER-MTD: PU-2113/60 KW/400HZ/ M200A1	1

METEOROLOGICAL TEAM, FIRES BN, SBCT

06530RD00
0/0/2/1/2

MISSION.

Provide meteorological data for
Field Artillery technical fire direction.

METEOROLOGICAL TEAM PARA 01

FBCB2
AN/VAS-5
x2 NVG
DAGR
AN/VRC-92F
AN/VRC-90F

M240B
MWTS
AN/TSR-8
KOI-18/TSEC

AN/TMQ-52



SGT 13T20 METRO EQUIP REP M4
SPC 13T10 FA METRO SP M4

EQUIPMENT SUMMARY

WEAPONS

MACHINE GUN 7.62MM M240B----- 1
RIFLE 5.56MM M4 CARBINE----- 2

VEHICLES, TRAILERS, AND TRLR MTD SYSTEMS

TRUCK UTILITY EXP CAPACITY ENH 4X4: M1152A1----- 1
TRAILER HIGH MOBILITY 1-1/4T (M1102)----- 1

MISCELLANEOUS EQUIPMENT

METEOROLOGICAL MEASURING SET: PROFILER AN/TMQ-52----- 1

COMMUNICATION-ELECTRONICS EQUIPMENT

ANTENNA GROUP: OE-254----- 1
NAVIGATION SET: SATELLITE SIGNALS AN/PSN-13 (DAGR)----- 1
RADIAC SET: AN/VDR-2----- 1
RECEIVE SUITE: AN/TSR-8 (GRT)----- 1
RADIO SET: AN/VRC-90F----- 1
RADIO SET: AN/VRC-92F----- 1

NIGHT VISION/OBSERVATION EQUIPMENT

DRIVERS VISION ENHANCER: AN/VAS-5----- 1
NIGHT VISION GOGGLES: AN/PVS-7B----- 2
MEDIUM THERMAL WEAPONS SIGHT: AN/PAS-13(V2)----- 1

SURVEY TEAM, FIRES BN, SBCT

06530RE00
0/0/2/1/2

MISSION.

Provide survey control points and other data for
precise locating and orientation of radars and
meteorological sets.

(X2) FA SURVEY TEAM PARA 01

FBCB2
AN/VAS-5
x2 NVG
DAGR
AN/VRC-92F

AN/PSG-14(V)1
M249
MWTS



SGT 13T20 SURVEYOR COMPUTER/PADS TEAM CHIEF M4
SPC 13T10 FA SURVEYOR/PADS VEH DRIVER M4

EQUIPMENT SUMMARY

WEAPONS

LAUNCHER GRENADE: M320A1----- 1
MACHINE GUN LIGHT 5.56MM M249----- 1
RIFLE 5.56MM M4 CARBINE----- 2

VEHICLES, TRAILERS, AND TRLR MTD SYSTEMS

TRUCK UTILITY EXP CAPACITY ENH 4X4: M1152A1----- 1

MISCELLANEOUS EQUIPMENT

IMPROVED POSN AND AZIMUTH DETERMINING SYS: (IPADS)----- 1

COMMUNICATION-ELECTRONICS EQUIPMENT

COMPUTER SYSTEM DIGITAL: AN/PSG-14(V)1 LFED----- 1
NAVIGATION SET: SATELLITE SIGNALS AN/PSN-13 (DAGR)----- 1
RADIAC SET: AN/VDR-2----- 1
RADIO SET: AN/VRC-92F----- 1

NIGHT VISION/OBSERVATION EQUIPMENT

DRIVERS VISION ENHANCER: AN/VAS-5----- 1
MINI EYESAFE LASER INFR OBSN DEVICE: (MELIOS): AN/PVS-6----- 1
NIGHT VISION GOGGLES: AN/PVS-7B----- 2
MEDIUM THERMAL WEAPONS SIGHT: AN/PAS-13(V2)----- 1

COUNTERFIRE OPERATIONS SECTION, FIRES BN, SBCT

MISSION.

06530RF00
0/1/5/1/6

To provide target processing
and targeting data for attack by lethal means.

COUNTERFIRE OPERATIONS SECTION, FIRES BN (IBCT) PARA 01

FBCB2
x2 NVG
DAGR
AN/VRC-92F

AN/PSC-5
AN/GYK-56



CW2 131A0 TARGETING OFF M4 S
SFC 13R40 SR FA TARGETING NCO M4
SSG 13F30 TARGETING NOC M4
SGT 13F20 TGT NCO M4
SPC 13F10 TGT PROC SP M4
PFC 13F10 TGT PROC SP M4

EQUIPMENT SUMMARY

WEAPONS

RIFLE 5.56MM M4 CARBINE----- 6

VEHICLES, TRAILERS, AND TRLR MTD SYSTEMS

TRUCK UTILITY EXP CAPACITY ENH 4X4: M1165A1----- 1

LIGHT TACTICAL TRAILER: 3/4T (M1101)----- 1

COMMUNICATION-ELECTRONICS EQUIPMENT

NAVIGATION SET: SATELLITE SIGNALS AN/PSN-13 (DAGR)----- 1

RADIO SET: AN/VRC-92F----- 1

RADIO SET: AN/PSC-5----- 1

COMPUTER SET FA GENERAL: AN/GYK-56 (EMT)----- 1

NIGHT VISION/OBSERVATION EQUIPMENT

NIGHT VISION GOGGLES: AN/PVS-7B----- 2

LIGHTWEIGHT COUNTER MORTAR RADAR SECTION, (TPQ-48) FIRES BN, SBCT

MISSION.

06530RG00
0/0/10/1/10

To locate enemy mortar firing
positions in the area of operations.

SSG 13R30 SECT CH M4
SPC 13R10 LCMR RADAR OPR M4

LCMR SECTION PARA 01

FBCB2
x2 NVG
DAGR
AN/VRC-89F

PU 797



X5

SSG 13R30 SECT CH M4
SGT 13R20 SR LCMR RADAR OPR M4
SGT 12R20 SR LCMR RADAR OPR M4
SPC 13R10 LCMR RADAR OPR M4
SPC 13R10 LCMR RADAR OPR M4
SPC 13R10 LCMR RADAR OPR M4
SPC 13R10 LCMR RADAR OPR M4
SPC 13R10 LCMR RADAR OPR M4
PFC 13R10 LCMR RADAR OPR M4
PFC 13R10 LCMR RADAR OPR M4
PFC 13R10 LCMR RADAR OPR M4

EQUIPMENT SUMMARY

WEAPONS

LAUNCHER GRENADE: M320A1----- 4

RIFLE 5.56MM M4 CARBINE----- 8

VEHICLES, TRAILERS, AND TRLR MTD SYSTEMS

GEN SET DED TM: 5KW 60HZ (PU-797)----- 4

TRUCK UTILITY EXP CAPACITY ENH 4X4: M1152A1----- 4

MISCELLANEOUS EQUIPMENT

LIGHTWEIGHT COUNTER MORTAR RADAR: AN/TPQ-50----- 4

COMMUNICATION-ELECTRONICS EQUIPMENT

ANTENNA GROUP: OE-254----- 4

NAVIGATION SET: SATELLITE SIGNALS AN/PSN-13 (DAGR)----- 4

RADIO SET: AN/VRC-89F----- 4

NIGHT VISION/OBSERVATION EQUIPMENT

NIGHT VISION GOGGLES: AN/PVS-7B----- 8

HHC, BRIGADE SUPPORT BN, SBCT

MISSION.

Provides command and control, staff planning and supervision and food service support for all organic and units assigned or attached to the Brigade Support Battalion (BSB).

HHC, BSB, SBCT

63056R000
17/2/67/86

COMMAND SECTION PARA 01 CURR OPS-INTEL/S2 PARA 02 CURRENT OPS-OPS/S3 PARA 03 SUSTAINMENT 1-S4 PARA 05 SUSTAINMENT 1-S1 PARA 04

AN/TYQ-90(V)2
FBCB2
2X NVG
DAGR
ON-721/V
AN/VRC-92F



LTC 90A00 CDR M4 M9
SPC 88M10 DRIVER M4

AN/UYQ-90(V)2
FBCB2
2X NVG
DAGR
AN/VRC-90F



MAJ 90A00 XO M4 M9
CSM 00L60 CSM M4 M9

2X NVG
DAGR
AN/TYQ-93
AN/VRC-90F



CPT 35D00 S2 M4
SGT 35F20 INTEL ANLST M4
SPC 35F10 INTEL ANLST M4

2X NVG
DAGR
AN/VRC-92F
AN/VRC-104(V)3

COMPUTER SYS DIGITAL
AN/PYQ-6C



FBCB2
AN/GYK-61
2X NVG
AN/VRC-90F

CPP RWS



MED PWR PLANT

2X NVG DAGR
AN/VRC-92F
AN/VRC-104(V)3



x2



AN/MJQ-40 PU
PU 805 A UNIT
PU 805 B UNIT

CPT 90A00 S3 M4 M9
CPT 90A00 OPS OFF M4
CPT 90A00 PLANS OFF M4
MSG 92A50 OPS SGT M4
SSG 29E30 EW SGT M4
SGT 29E20 EW SGT M4
SSG 74D30 CBRN NCO M4
SGT 74D20 CBRN NCO M4
SPC 74D10 CBRN SP M4

AN/GYK-61
AN/TYQ-109(V)1
AN/UYQ-90(V)3
2X NVG
DAGR
AN/VRC-90F



MED PWR PLANT

2X NVG
DAGR
AN/VRC-90F



CPT 90A00 S4 M4
SFC 92Y40 SR SUPPLY SGT M4
SGT 92Y20 SUPPLY NCO M4
SPC 92Y10 SUPPLY SPEC M4

2X NVG
DAGR
AN/VRC-90F

COMPUTER SYS DIGITAL
OL-701A/TYQ
4X ARMY HR WORKSTATION



CPT 42B00 S1 M4
SFC 42A40 SR HR SGT M4
SSG 42A30 HR SGT M4
SGT 42A20 HR SGT M4
SGT 27D20 PARALEGAL M4
SPC 42A10 HR SP M4
PFC 42A10 HR SP M4
PFC 42A10 HR SP M4

SUSTAINMENT 1-C4OPS/S6 PARA 06

2X NVG
AN/VRC-92F
AN/TSQ-243
AN/TSR-8
AN/TSQ-259
AN/GYK-62B

DAGR
AN/PYQ-12
2X KG-175
AN/GYK-50B



2X NVG
DAGR
AN/VRC-90F



MED PWR PLANT

2X NVG
DAGR
AN/VRC-90F



PU 798

CPT 25A00 S6 M4
SFC 25U40 SECTION CHIEF M4
SSG 25E30 ELECTRO SPECT NCO M4
SPC 25B10 LAN MGR M4
SPC 25N10 NODAL NT SYS OPR-MNT
SPC 25Q10 XMSN SYS OPR M4
SPC 25U10 SIG SPT SYS MAINT M4
SPC 25U10 SIG INFO SVC SP M4
SPC 25U10 SIG SPT SYS MAINT M4
PFC 25B10 LAN MGR M4
PFC 25U10 SIG SPT SYS SP M4

2X NVG
DAGR
AN/VRC-90F

BATTALION COMMAND
POST SWITCHING



SUSTMNT 1-UMT PARA 7

2X NVG
DAGR
AN/VRC-90F



CPT 56A00 CHAPLAIN
PFC 56M10 CHAPLAIN ASST M4

SUSTAINMENT 2-SUPPORT OPERATIONS PARA 08

AN/UYQ-90(V)2
FBCB2
2X NVG
DAGR
AN/VRC-92F



2X NVG
DAGR
AN/VRC-90F



x3

2X AN/UYQ-90(V)2
OL-608/TYQ
COMPUTER SYS DIGITAL
2X AN/UYQ-90(V)3
KG-175
AN/TYQ-141



2X NVG
DAGR
AN/VRC-90F



AN/TYQ-106(V)1
AN/GYK-61
AN/TYQ-105(V)1
OL-701A/TYQ
AN/VRC-90F
OL-713/TYQ

FBCB2
AN/TYQ-129(V)2
2X NVG
AN/VRC-89F
AN/VRC-104(V)3



MED PWR PLANT

MAJ 90A00 SPT OPS OFF M4 M9
CPT 90A00 OPS OFF M4
CPT 9088 TRANS OFF M4
CPT 70H67 MED OPS OFF M4
CPT 70K67 MED LOG OFF M4
CPT 90A91 AMMO OFF M4
CW4 915E0 SR ORD GRD MAINT WO M4

MSG 92A50 OPS SGT M4
X2 SFC 68W40 OPS SGT M4
SFC 88N40 TRANS OFF M4
SFC 89B40 AMMO LOG SGT M4
SFC 91X40 MAINT MGT NCO M4
SSG 89B30 AMMO INSP M4
SSG 92A30 MAT MGMT NCO M4
SSG 92M30 MORTUARY AFFAIRS NCO M4
SGT 88N20 TRANS MGMT NCO M4

SUSTAIN 2-C4OPS/CSSAMO PARA 09

2X NVG
DAGR
AN/VRC-90F



CW2 251A0 INFO SVCS TECH M4
MSG 25B50 INFO SYS CHIEF M4
SSG 92A30 MAT MGMT NCO M4
SSG 92Y30 SUPPLY SGT M4
SGT SR INFO SYS SP M4
SGT 68G20 PAT SVCS NCO M4
SGT 68J20 MED LOG SGT M4
SGT 92A20 MAT MGT NCO M4
SGT 92Y20 SUPPLY NCO M4
SPC 25B10 INFO SYS SP M4
PFC 25B10 INFO SYS SP M4

AN/TYQ-107(V)1
AN/TYQ-109(V)2
AN/TYQ-107(V)1
AN/TYQ-120(V)2
AN/TYQ-108(V)3
OL-603/TYQ
DGR
AN/VRC-90F
AN/TYQ-141



COMPANY HEADQUARTERS PARA 10

AN/UYQ-90(V)2
FBCB2
2X NVG
DAGR
AN/VRC-92F



CPT 90A00 CDR M4 M9

2X NVG
DAGR
AN/VRC-90F



SSG 92Y30 SUPPLY NCO M4
SPC 92Y10 SUPPLY SPEC M4

OL-701A/TYQ
RAVEN
.50 CAL
HWTS



1SG 92A5M 1SG M4

DECON

FIELD FEEDING SECTION PARA 11

2X NVG
AN/VRC-90F



ASSAULT KITCHEN

2X NVG
AN/VRC-90F



2X NVG
AN/VRC-90F



2X NVG
AN/VRC-90F



MTRCS

SFC 92G40 SR FOOD OPNS SGT M4
SSG 92G30 FOOD OPS MGR M4
X3 SGT 92G20 FOOD OPS NCO M4
X2 SPC 92G10 FOOD OPS SP M4
SPC 92G10 FOOD OPS SP M4
SPC 92G10 FOOD OPS SP M4
X2 PFC 92G10 FOOD OPS SP M249
PFC 92G10 FOOD OPS SP M4

EQUIPMENT SUMMARY

WEAPONS

L69080	LAUNCHER GRENADE: M320A1	4
M09009	MACHINE GUN 5.56 MILLIMETER: M249	17
M39263	MACHINE GUN: LIGHT 5.56MM M249	4
M92362	MACHINE GUN GRENADE 40MM: MK19 MOD III	2
M92841	MACHINE GUN: 7.62MM M240B	4
P98152	PISTOL 9MM AUTOMATIC: M9	8
R97234	RIFLE 5 56 MILLIMETER: M4	85
Z00686	MACHINE GUN: CALIBER .50	10

VEHICLES, TRAILERS AND TRLR MTD SYSTEMS

A94943	ASSAULT KTCHN: (AK)	16
C27633	CONTAINERIZED KITCHEN: CK	7
C84541	CONTAINER ASSEMBLY REFRIGERATED: 8X8X20 W/9000 BTU REF UNIT	7
T07679	TRUCK UTILITY: HEAVY VARIANT HMMWV 4X4 10000 GVW W/E	2
T37588	TRUCK UTILITY EXPANDED CAPACITY ENHANCED: M1152A1	30
T41515	TRUCK CARGO: 5 TON WO/WINCH	20
T55054	TRUCK PALLETIZED (LHS): M1120A4	7
T56383	TRUCK UTILITY EXPANDED CAPACITY ENHANCED 4X4: M1165A1	8
T67136	TRUCK: EXPANDABLE VAN WO/WINCH	1
T93761	TRAILER: PALLETIZED LOADING 8X20	7
T95555	TRAILER CARGO: MTV W/DROPSIDES M1095	3
T95924	TRAILER CARGO: HIGH MOBILITY 1-1/4 TON	6
T95992	LIGHT TACTICAL TRAILER: 3/4 TON	19
Z00206	MULTI-TEMPERATURE REFRIGERATED CONTAINER SYSTEM: MTRCS	6
Z01398	TRAILER-MTD: PP-3105/ 30 KW/ 50/60HZ 2M200A1	1
Z01414	LTT TRAILER-MTD: PU-2002/ 10 KW/ 50/60HZ	1
Z36683	TRAILER TANK WATER (CAMEL): 800 GAL 5 TON W/E	8

NIGHT VISION/OBSERVATION

D41659	DRIVERS ENHANCERS: AN/VAS-5	60
N05482	NIGHT VISION: GOGGLE	86
S90535	MEDIUM WEAPON THERMAL SIGHT (MWTS): AN/PAS-13(V)2	8
S90603	HEAVY WEAPON THERMAL SIGHT (HWTS): AN/PAS-13(V)3	12

MISC EQUIPMENT

C05701	MONITOR CHEMICAL AGENT:	2
J00697	JOINT CHMCL AGENT: DETECTOR	3
J01197	JOINT SERVICE: TRANSPORTABLE DECONTAMINATION	2
M12986	MASK CHEMICAL BIO JOINT SERVICE GEN PURPOSE: FIELD M50	96
R20684	RADIAC SET: AN/VDR-2	1
R30925	RADIAC SET: AN/PDR-75	1
R31061	RADIAC SET: AN/UDR-13	3
Z01330	GEN SET DED 10KW 50/60HZ: SKID-MTD	8

COMMUNICATIONS AND ELECTRONICS

A35329	ALL SOURCE ANALYSIS SYSTEM: AN/TYQ-93	1
C18277	COMPUTER SET: DIGITAL AN/TYQ-107(V)1	1
C18278	COMPUTER SYSTEM: DIGITAL AN/UYQ-90(V)2	6
C18345	COMPUTER SET: DIGITAL AN/TYQ-106(V)1	2
C18378	COMPUTER SET: AN/UYK-128(V)3	19
C18448	COMPUTER SYSTEM: DIGITAL AN/GYK-61	4
C18641	COMPUTER SYST DIGITAL: AN/PYQ-12	2
C27435	COMPUTER SYSTEM: DIGITAL AN/TYQ-129(V)2	5
C27503	COMPUTER SYSTEM: DIGITAL AN/TYQ-105(V)1	1
C27639	COMPUTER SYSTEM: DIGITAL AN/TYQ-108(V)3	1
C27707	COMPUTER SYSTEM: DIGITAL AN/TYQ-109(V)1	2
C27775	COMPUTER SYSTEM: DIGITAL AN/TYQ-109(V)2	1
C27823	COMPUTER SET: DIGITAL OL-608/TYQ	2
C27906	COMPUTER SYS DIGITAL: AN/TYQ-141	2
C27963	COMPUTER SYSEM: DIGITAL	2
C40996	COMMAND SYSTEM: TACTICAL	2
C61665	COMMAND CENTER SYSTEM: AN/TSQ-243	1
C78827	COMPUTER SET: DIGITAL OL-603/TYQ	1
C78851	COMPUTER SYSTEM: DIGITAL AN/UYQ-90(V)3	2
N96248	NAVIGATION SET: SATELLITE SIGNALS AN/PSN-13	61
P49587	PJH SURFACE VEHICLE RADIO SET: AN/VSQ-2(V)	20
R20684	RADIAC SET: AN/VDR-2	1
R30658	RECEIVE SUITE: AN/TSR-8	1
R45543	RADIO SET: AN/VRC-92F(C)	9
R45710	RADIO SET: AN/VRC-106(V)2 (C)	1
R57606	RADIO SET: AN/PSC-5	1
R68044	RADIO SET: AN/VRC-90F(C)	56
R68566	RADIO SET: AN/VRC-106(V)1 (C)	3
R87139	RADIO SET: AN/VRC-104(V)3 150 WATT W/PRC-150 HF RADIO	3
R93169	RADIO TEST SET: AN/PRM-34()	4
T43146	TELECONFERENCE SYS: AN/TYQ-122	1
Z00384	COMPUTER SYSTEM DIGITAL: AN/PYQ-10(C)	47
Z00513	COMPUTER SYSTEM DIGITAL: AN/GYK-50B (ISYSCON) (V)4	1
Z00560	INTERFACE UNIT COMM EQUIPMENT: OL-713(V)1/TYQ CSS VSAT	2
Z00564	BATTALION COMMAND POST(SWITCHING GROUP): OM-XXX	1
Z00862	LAND MOBILE RADIO: (LMR)	34
Z01248	COMPUTER SET: DIGITAL AN/GYK-62B	1
Z39781	ARMY H RESOURCES: WRKSTATION	5
Z70024	COMMUNICATION SUBSYSTEM: AN/USQ-165	1

HHC, BSB, SBCT

DISTRIBUTION COMPANY, BSB, SBCT

63058R000
5/2/126//133

COMPANY HEADQUARTERS PARA 01

TRANS PLT HQ PARA 02

TRUCK SQUAD PARA 03

MISSION: To provide transportation and supply support to the Stryker Brigade Combat Team (SBCT).

FBCB2 X2 NVG AN/VAS-5 2X NVG
2X NVG DAGR DAGR EPLRS HWTS
EPLRS AN/VRC-90F
AN/VA S-5 AN/TYQ-109(V)1
AN/VRC-92F .50 CAL



CPT 90A00 CDR M4 M9
SPC 92Y10 SUP SPEC M4
1SG 92A5M 1SG M4
SSG 92Y30 SUPPLY SGT M4

FBCB2 AN/UYQ-90(V)3
AN/VAS-5 OL-701A/TYQ
2X NVG KOI-18/TSEC
DAGR HWTS
EPLRS .50 CAL
AN/VRC-90F



1LT 92A00 OPS OFF M4
SFC 88M40 TRUCKMASTER M4

FBCB2 X2 NVG
DAGR EPLRS
AN/VAS-5
EPLRS
AN/VRC-90F
AN/UYQ-90(V)2



1LT 88A00 PLT LDR M4
SFC 88M40 PLT SGT M4

X2 NVG DAGR
FBCB2 LMR
HWTS MK-19
AN/VAS-5
EPLRS-V1
AN/VRC-90F
AN/UYQ-90(V)2
AN/UYK-128(V)1



SSG 88M30 SQD LEADER M4
SGT 88M20 HVY VEH DRVR M4
SPC 88M10 HVY VEH DRVR M4
SPC 88M10 HVY VEH DRVR M249
PFC 88M10 HVY VEH DRVR M4
SGT 88M20 HVY VEH DRVR M4
SGT 88M20 HVY VEH DRVR M4
SPC 88M10 HVY VEH DRVR M4
PFC 88M10 HVY VEH DRVR M4

x4

SUPPLY PLATOON HEADQUARTERS PARA 04

GENERAL SUPPLY AND CLASS IX SECTION PARA 05

AN/UYQ-90(V)2 AN/UYQ-90(V)2
FBCB2 FBCB2
OL-603/TYQ OL-603/TYQ
AN/UYQ-90(V)3 AN/UYQ-90(V)3
AN/VAS-5 AN/VAS-5
2X NVG 2X NVG
DAGR DAGR
EPLRS EPLRS
OL-701A/TYQ OL-701A/TYQ
AN/VRC-90F AN/VRC-90F



1LT 92A00 PLT LDR M4
CW2 920B0 SUPPLY SYS TECH M4
SFC 92A40 PLT SGT M4
SGT 92A20 MAT CON ACCTG NCO M4
SPC 92A10 MAT CON/ACCTG SP M249
SPC 92A10 MAT CON/ACCTG SP M4
PFC 92A10 MAT CON/ACCTG SP M4
PFC 92A10 MAT CON/ACCTG SP M4

FBCB2 AN/VAS-5
AN/VAS-5 X2 NVG
X2 NVG AN/VRC-90F
DAG LMR
EPLRS-V1
AN/VRC-90F
AN/UYK-128(V)1
LMR



SSG 92A30 MAT MGMT SUPV M4
PFC 92A10 MAT HDLG SP M4

x2

AN/VAS-5
X2 NVG
AN/VRC-90F
LMR



x3

X5 OL-604/TYQ

S-785G SHELTER

AN/VAS-5
X2 NVG
AN/VRC-90F
LMR



x3

AN/VAS-5
WX NVG
AN/VRC-90F
LMR



x4

x5

X3 SGT 92A20 MAT HDLG SGT M4
X3 SGT 92A20 MAT HDLG SGT M4
SGT 92A20 MAT HDLG SGT M4
SPC 92A10 MAT HDLG SP M4
SPC 92A10 MAT HDLG SP M4
SPC 92A10 MAT HDLG SP M4
X3 SPC 92A10 MAT HDLG SP M4
SPC 92A10 SUBSTANCE SUP SP M4

SPC 92A10 MAT HDLG SP M4
SPC 92A10 MAT HDLG SP M4
PFC 92A10 MAT HDLG SP M4
PFC 92A10 MAT HDLG SP M4
X2 PFC 92A10 MAT HDLG SP M4
PFC 92A10 MAT HDLG SP M4
X3 PFC 92A10 MAT HDLG SP M4
PFC 92A10 SUBSTANCE SUP SP M4

EQUIPMENT SUMMARY

WEAPONS

L69080	LAUNCHER GRENADE: M320A1	4
M09009	MACHINE GUN 5.56 MILLIMETER: M249	16
M39263	MACHINE GUN: LIGHT 5.56MM M249	4
M92362	MACHINE GUN GRENADE 40MM: MK19 MOD III	7
M92841	MACHINE GUN: 7.62MM M240B	15
P98152	PISTOL 9MM AUTOMATIC: M9	1
R97234	RIFLE 5 56 MILLIMETER: M4	142
Z00686	MACHINE GUN: CALIBER .50	9

VEHICLES, TRAILERS AND TRLR MTD SYSTEMS

S01359	SHELTER: TACTICAL EXPANDABLE TWOSIDE	2
S70517	SEMITRAILER LOW BED: 25 TON 4 WHEEL W/E	7
T14017	TACTICAL WATER PURIFICATION SYSTEM (TWPS) 1500 GPH:	1
T32629	LOAD HANDLING SYS (LHS): 2000 GL COMP WATER TANK-RACK (HIPPO)	20
T37588	TRUCK UTILITY EXPANDED CAPACITY ENHANCED: M1152A1	3
T41515	TRUCK CARGO: 5 TON WO/WINCH	4
T55054	TRUCK PALLETIZED (LHS): M1120A4	42
T56383	TRUCK UTIL EXPANDED CAPACITY ENHANCED 4X4: M1165A1	4
T58318	TRUCK TANK: WO/WINCH	15
T61375	TRUCK TRACTOR: M1088A1P2 W/WINCH	1
T73347	TRUCK LIFT: FORK VARIABLE REACH ROUGH TERRAIN	7
T88983	TRUCK TRACTOR: WO/WINCH	6
T93761	TRAILER: PALLETIZED LOADING 8X20	56
T95555	TRAILER CARGO: MTV W/DROPSIDES M1095	3
T95924	TRAILER CARGO: HIGH MOBILITY 1-1/4 TON	5
W30051	WATER: PURIFIER LIGHTWEIGHT	2
Z00514	MODULAR FUEL SYSTEM - TANKRACK MODULE:	15
Z36683	TRAILER TANK WATER (CAMEL): 800 GAL 5 TON W/E	1

NIGHT VISION/OBSERVATION

D41659	DRIVERS ENHANCERS: AN/VAS-5	74
N05482	NIGHT VISION: GOGGLE	157
S90535	MEDIUM WEAPON THERMAL SIGHT (MWTS): AN/PAS-13(V)2	19
S90603	HEAVY WEAPON THERMAL SIGHT (HWTS): AN/PAS-13(V)3	16

COMMUNICATIONS AND ELECTRONICS

A04334	AUTHORIZD STOCKAGE LIST MOBILITY SYSTEM: ASLMS	3
C18278	COMPUTER SYSTEM: DIGITAL AN/JYQ-90(V)2	55
C18378	COMPUTER SET: AN/UYK-128(V)3	14
C18684	COMPUTER SET: DIGITAL OL-604/TYQ	5
C27435	COMPUTER SYSTEM: DIGITAL AN/TYQ-129(V)2	1
C27707	COMPUTER SYSTEM: DIGITAL AN/TYQ-109(V)1	1
C40995	CMPUTER SYSTEM DIGITAL: SAAS-MOD-ATHP	1
C78827	COMPUTER SET: DIGITAL OL-603/TYQ	1
C78851	COMPUTER SYSTEM: DIGITAL AN/JYQ-90(V)3	5
J99233	INTERROGATOR SET: AN/TYX-1	1
N96248	NAVIGATION SET: SATELLITE SIGNALS AN/PSN-13	15
P49587	PJH SURFACE VEHICLE RADIO SET: AN/VSQ-2(V)	14
P99881	PROCESSOR GROUP SIG DATA: (CAISI 2.0) OL-701A/TYQ	3
R45543	RADIO SET: AN/VRC-92F(C)	1
R68044	RADIO SET: AN/VRC-90F(C)	73

T40405	TAPE READER GENERAL PURPOSE: KOI-18/TSEC	1
Z00384	COMPUTER SYSTEM DIGITAL: AN/PYQ-10(C)	22
Z00862	LAND MOBILE RADIO: (LMR)	63

MISC EQUIPMENT

C05701	MONITOR CHEMICAL AGENT:	2
C27294	CONTAINER HANDLING:	7
E92641	PRESSURE ASSEMBLY CONTROL: W/MULTIPLE COMPONENTS	2
F04898	FUEL SYSTEM SUPPLY POINT: FSSP TYPE 3 120K	1
G18358	GEN SET: DED SKID MTD 3KW 60HZ	5
R20684	RADIAC SET: AN/VDR-2	6
R30925	RADIAC SET: AN/PDR-75	1
R31061	RADIAC SET: AN/UDR-13	12
T32629	LOAD HANDLING SYS (LHS): 2000 GAL COMP WATER TANK-RACK (HIPPO)	20
Z01328	GEN SET DED 5KW 50/60HZ: SKID-MTD	2
Z01330	GEN SET DED 10KW 50/60HZ: SKID-MTD	2
Z01336	GEN SET DED 60KWW 50/60HZ: SKID-MTD	1

DISTRIBUTION COMPANY, BSB, SBCT

FIELD MAINTENANCE COMPANY, BSB, SBCT

43057R000
4/7/91/102

COMPANY HQ PARA 01

MISSION: To provide Field Maintenance Support to a Stryker Brigade Combat Team (SBCT).

AN/VRC-89F
FBCB2
DAGR
EPLRS-V1



CPT 91A00 COMMANDER M9 M4
PFC 92Y10 SUPPLY SPEC M4

AN/VRC-92F
FBCB2
AN/TYQ-109(V)1
DAGR
EPLRS-V1
CAISI 2.0



LT 91A00 EXEC OFF M4

AN/VRC-90F



1SG 91Z5M FIRST SERGEANT M4
SSG 92Y30 SUPPLY SGT M4

MAINTENANCE CONTROL SECTION / PLATOON HQ PARA 02

AN/VRC-89F
FBCB2
DAGR
EPLRS-V1



LT 91A00 MAINT CONT OFF M4
SSG 88M30 MASTER DRVR TRNR M4

AN/VRC-90F



MSG 91Z50 SR MAINT SUPV M4
SPC 92A10 EQ RCD/PARTS SP M4

AN/VRC-90F
2 AN/TYQ-139
AN/TYQ-140



SGT 92A20 EQ RCD/PARTS SGT M4
SPC 92A10 EQ RCD/PARTS SP M4
PFC 92A10 EQ RCD/PARTS SP M4

AN/VRC-90F
FBCB2
DAGR
EPLRS-V1
6 AN/TYQ-139



SPC 92A10 EQ RCD PARTS SP M249
PFC 92A10 EQ RCD/PARTS SP M4

SERVICE / RECOVERY SECTION PARA 03

AN/VRC-90F
FBCB2
DAGR
EPLRS-V1



CW2 91A40 ALLIED TRADES WO M40
PFC 91E10 ALLIED TRADES SPEC M4

AN/VRC-90F
FBCB2
DAGR
EPLRS-V1



x3 SGT 91E20 ALLIED TRADES SPEC M4
X2 SPC 91E10 ALLIED TRADES SPEC M4
X3 PFC 91E10 ALLIED TRADES SPEC M4

AN/VRC-90F
FBCB2
DAGR
EPLRS-V1



x4
SSG 91S30 RCYV VEH SUPV M4
SGT 91S20 RCYV VEH OPR M4
SPC 91S10 RCYV VEH OPR M4
x2 PFC 91S10 RCYV VEH OPR M249

WHEEL VEHICLE REPAIR SECTION PARA 04

FBCB2
DAGR
EPLRS-V1
AN/VRC-90F



x2

FBCB2
DAGR
EPLRS-V1
AN/VRC-90F



x3

AN/VRC-90F



x2

FBCB2
DAGR
EPLRS-V1
AN/VRC-90F



CW3 915A0 AUTO MAINT WO M4
SFC 91X40 SECTION SGT M4
x3 SSG 91B30 SR MECHANIC M4
x8 SGT 91B20 WH VEH MECH M4
SGT 91B20 REC VEH OPR M4

x3 SPC 91B10 WH VEH MECH M4
x3 SPC 91B10 WH VEH MECH M4
SP4 91B10 WH VEH MECH M4
SP4 91B10 WH VEH MECH M4
SP4 91B10 WH VEH MECH M4

x2 PFC 91B10 WH VEH MECH M4
x2 PFC 91B10 WH VEH MECH M249
x2 PFC 91B10 WH VEH MECH M4
PFC 91B10 WH VEH MECH M4
x2 PFC 91B10 WH VEH MECH M4
x2 PFC 91B10 WH VEH MECH M249
PFC 91B10 WH VEH MECH M4

AN/VRC-90F



x2

AN/VRC-90F



x4

FIELD MAINTENANCE COMPANY, BSB, SBCT

MAINTENANCE SUPPORT PLATOON HQ PARA 05

AN/VRC-89F
FBCB2
DAGR
EPLRS-V1
OL-713(V)1/TYQ CSS VSAT



LT 91A00 PLT LDR M4
SFC 91X40 PLT SGT M4

ARMAMENT REPAIR SECTION PARA 06

AN/VRC-90F
FBCB2
DAGR
EPLRS-V1



CW2 913A0 ARMT SYS MAINT WO M4
PFC 91F10 FIRE CNTL REPAIRER M4

AN/VRC-90F
DAGR
EPLRS-V1



SFC 91X40 SECTION SGT M4
SSG 91F30 ARMT MAINT SUPV M4
SGT 91F20 SM ARMS/ARTY REP M4

AN/VRC-90F



x2

SPC 91G10 FIRE CONTROL REP M4
PFC 91F10 SM ARMS/ARTY REP M249

GROUND SUPPORT EQUIPMENT REPAIR SECTION PARA 07

AN/VRC-90F
FBCB2
DAGR
EPLRS-V1



CW2 919A0 ENGR EQ MAINT WO M4
PFC 91J10 QM/CHEM EQ REP M4

AN/VRC-90F



AN/VRC-90F
FBCB2
DAGR
EPLRS-V1



x3

SFC 91X40 SP PURP EQ REP SUPV M4
SSG 91C30 SR UTILITIES EQ REP M4
SSG 91D30 SR PWR-GEN EQ REP M4

SGT 91C20 UTILITIES EQ REP M4
SGT 91D20 PWR-GEN EQ REP M4
SGT 91J20 QM/CHEM EQ REP M4

AN/VRC-90F



x3

x2

SPC 91C10 UTILITIES EQ REP M4
SPC 91D10 PWR-GEN EQ REP M4
SPC 91J10 QM/CHEM EQ REP M4

PFC 91C10 UTILITIES EQ REP M4
PFC 91D10 PWR-GEN EQ REP M4
PFC 91D10 PWR-GEN EQ REP M4
PFC 91J10 QM/CHEM EQ REP M249

PU 803



AN/VRC-90F



MSL/ELECT REPAIR SECTION PARA 08

AN/VRC-90F
FBCB2
DAGR
EPLRS-V1



CW3 948D0 EL-MSL SYS MAINT WO M4
PFC 94A10 LC ELECT MSL SYS REP M4

AN/VRC-90F
FBCB2
DAGR
EPLRS-V1



x2

AN/VRC-90F



x5

AN/TSM-153 ICSS

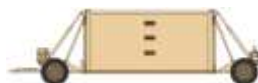

AN/VRC-90F



x5

CW2 948B0 EL SYS MAINT WO M4
SFC 94W40 ELECT MAINT SUPV M4
SSG 94A30 LC ELECT MSL SYS FRMAN M4
SSG 94E30 COMSEC/RADIO SUPV M4
SGT 94A20 LC ELECT MSL SYS REP M4
SGT 94E20 SR COMSEC/RADIO RPR M4

SPC 94A10 LC ELECT MSL SYS REP M4
X2 SPC 94E10 COMSEC/RADIO RPR M4
SPC 94E10 COMP/DET SYS REPAIRER M4
SPC 94M10 RADAR REPAIRER M4
X2 PFC 94E10 COMSEC/RADIO RPR M249

EQUIPMENT SUMMARY

WEAPONS

LAUNCHER GRENADE (M320A1)-----	4
MACHINE GUN 5.56MM M249-----	31
MACHINE GUN LIGHT 5.56MM M249-----	4
MACHINE GUN GRENADE 40MM MK-19 MOD III-----	2
MACHINE GUN 7.62MM M240B-----	5
PISTOL 9MM AUTOMATIC M9-----	1
RIFLE 5.56MM M4 CARBINE-----	299
MACHINE GUN: CALIBER .50 (M2E2)-----	33

VEHICLES, TRAILERS, AND TRLR MTD SYSTEMS

DOLLY SET LIFT TRANSPORTABLE SHELTER: 7 ½ TON-----	1
FORWARD REPAIR SYSTEM: M7 (FRS)-----	12
GEN SET DIESEL ENGINE TM: 30KW 50/60 HZ (PU-803)-----	2
GEN SET DIESEL ENGINE TM: 15KW 50/60HZ (PU-802)-----	12
SHOP EQUIPMENT: AUTOMOTIVE VEHICLE (TLR MTD) (SATS)-----	2
TOOL OUTFIT HYD SYS: TEST & REP 3/4T TLR MTD (HYSTRU)---	1
TRUCK UTILITY EXP CAPACITY ENH 4X4: M1152A1-----	45
TRUCK UTILITY EXP CAPACITY ENH 4X4: M1165A1-----	4
TRUCK CARGO: MTV (M1083)-----	32
TRUCK CARGO MTV LWB (M1085)-----	9
TRUCK VAN LMTV (M1079)-----	4
TRUCK LIFT: FORK VARIABLE REACH RT (ATLAS)-----	1
TRUCK WRECKER: TACTICAL 8X8 HEMTT (M984A1)-----	17
TRAILER: PLS 8X20 (M1076)-----	5
TRAILER CARGO: MTV W/ DROPSIDES (M1095)-----	13
TRAILER HIGH MOBILITY 1-1/4T (M1101)-----	21
LIGHT TACTICAL TRAILER: 3/4T (M1102)-----	13
TRUCK CARGO HEMTT LHS (M1120)-----	13
SHOP EQUIPMENT: WELDING TRAILER MTD-----	3
TRAILER TANK WATER (CAMEL) 800 GAL 5 TON-----	1

COMMUNICATION-ELECTRONICS EQUIPMENT

ANTENNA GROUP: OE-254-----	3
COMPUTER SET DIGITAL: AN/UUK-128 (FBCB2)-----	69
COMPUTER SET DIGITAL: AN/TYQ-109(V)1 (GCSS-A (V)1)-----	1
NAVIGATION SET: SATELLITE SIGNALS AN/PSN-13 (DAGR)-----	71
PJH SURFACE VEH RADIO SET: AN/VSQ-2(V)1 (EPLRS-V1)-----	67
PROCESSOR GROUP SIGNAL DATA: (CAISI 2.0) OL-701A/TYQ-----	1
RADIAC SET: AN/VDR-2-----	5
RADIO SET: AN/VRC-89F-----	4
RADIO SET: AN/VRC-90F-----	115
RADIO SET: AN/VRC-92F-----	1
INTERFACE UNIT COMM EQ: OL-713(V)1/TYQ CSS VSAT-----	7
COMPUTER SYSTEM: DIGITAL AN/TYQ-139 (SAMS-1E V1)-----	13
COMPUTER SYSTEM: DIGITAL AN/TYQ-140 (SAMS/SAMS-1E V2)-----	1

NIGHT VISION/OBSERVATION EQUIPMENT

DRIVERS VISION ENHANCER: AN/VAS-5-----	107
NIGHT VISION GOGGLES: AN/PVS-7B-----	249
SIGHT THERMAL: AN/PAS-13B(V)2 MEDIUM TWS-----	9
SIGHT THERMAL: AN/PAS-13B(V)3 HEAVY TWS-----	35

MISCELLANEOUS EQUIPMENT

BED CARGO: DEMOUNTABLE PLS 8X20-----	1
CONTAINER HANDLING: HVY EXP MOBIL TACT TRK (HEMTT)-----	1
GEN SET: DED SKID MTD 5 KW 60HZ (MEP-802A)-----	14
GEN SET : DED SKID MTD 3KW 60HZ (MEP-831A)-----	2
GEN SET DIESEL: 60HZ AC MEP-531A-----	3
GEN SET: DED SKID MTD 10KW 60HZ (MEP-803A)-----	2
ELECTRONICS SHOP SHEL MTD AVIONICS: AN/ASM-146-----	9
ELECTRONICS SHOP SHEL MTD AVIONICS: AN/ASM-147-----	6
SHELTER: TACTICAL EXPANDABLE TWOSIDE S785G-----	1
SHELTER: NONEXPANDABLE S250-----	8
SHELTER: NONEXPANDABLE S280-----	1
SHOP EQUIP NIGHT SIGHT MAINT FACILITY: (NSMF)-----	1
SHOP EQUIP: CONTACT MAINT ORD/ENGR TRK MTD-----	17

FIELD EQUIPMENT COMPANY, BSB, SBCT

FORWARD SUPPORT COMPANY

(BEB), BSB, SBCT

63057R000
4/1/92/97

COMPANY HEADQUARTERS PARA 01

FIELD FEEDING SECTION PARA 02

MISSION: To provide field maintenance including communication and COMSEC equipment, field feeding, transportation and supply support to the Brigade Engineer Battalion.

FBCB2
x2 NVG
DAGR
AN/MRC-149
AN/VRC-92F
AN/UYQ-90(V)2
AN/UYK-128(V)3



DAGR X3 NVG
.50 CAL X3 M240B
AN/GYK-61 (BCS3)
AN/VRC-90F
AN/TYQ-109(V)1
OL-701A/TYQ



1LT 88A00 EXEC OFF M4
1SG 91Z5M 1SG M4
SGT 92Y20 SUPPLY SGT M4

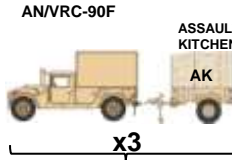

x3

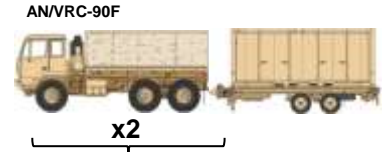

x2

DAGR .50 CAL
AN/VRC-90F



SFC 92G40 SR FOOD OPS SGT M4
SSG 92G30 FOOD OPS MGR M4
x3 SGT 92G20 FOOD OPS SGT M4

x5 SPC 92G10 FOOD OPS SP M4
SPC 92G10 FOOD OPS SP M4
PFC 92G10 FOOD OPS SP M4
PFC 92G10 FOOD OPS SP M4
PFC 92G10 FOOD OPS SP M4
PFC 92G10 FOOD OPS SP M249



NOTE: Lift for MTRCS provided by Distr Sec

DISTRIBUTION PLT HQ PARA 03

DISTRIBUTION SECTION PARA 04

MAINTENANCE CONTROL & PLT HQ PARA 05

FBCB2
X2 NVG
DAGR
AN/VRC-92(V)2
AN/UYQ-90(V)3
AN/TYQ-129(V)2



1LT 92A00 PLT LDR M4
SFC 88M40 PLT SGT M4

X2 M240B
MK19 MOD III
.50 CAL
X2 NVG
DAGR
AN/VRC-90F
MWTS



x2

M240B
2X NVG
DAGR
AN/VRC-90F
MWTS



x5

SSG 88M30 SECTION SGT M4
SSG 88M30 HVY VEH DRIVER M4
SGT 88M20 HVY VEH DRIVER M4
SGT 88M20 HVY VEH DRIVER M4
SGT 89B20 AMMO SGT M4
SGT 92F20 PETRL HVY VEH OPR M4
X3 SPC 88M10 HVY VEH DRIVER M4
X3 SPC 92F10 PETRL HVY VEH OPR M249
PFC 88M10 HVY VEH DRIVER M4
PFC 88M10 HVY VEH DRIVER M4



x2 NVG
DAGR
AN/VRC-90F
AN/UYK-128(V)3



1LT 91A00 MAINT CONT OFF M4
SSG 88M30 MASTER DRVR TRNR M4

x2 NVG
DAGR
AN/VRC-90F
KOI-18/TSEC



CW3 919A0 EN EQ MNT WO M4
SGT 92A20 EQ REC/PARTS SGT M4
PFC 92A10 EQ REC/PARTS SP M249

AN/TYQ-140
x2 NVG
DAGR
OL-701A/TYQ
AN/VRC-89F
OL-713(V)1
x2 AN/TYQ-139



SFC 91X40 MAINT MGT NCO M4
X3 SPC 92A10 EQ REC/PARTS SP M4
PFC 92A10 EQ REC/PARTS SP M4
PFC 92A10 EQ REC/PARTS SP M4

FORWARD SUPPORT COMPANY (BEB), BSB, SBCT

FIELD MAINTENANCE SECTION PARA 06

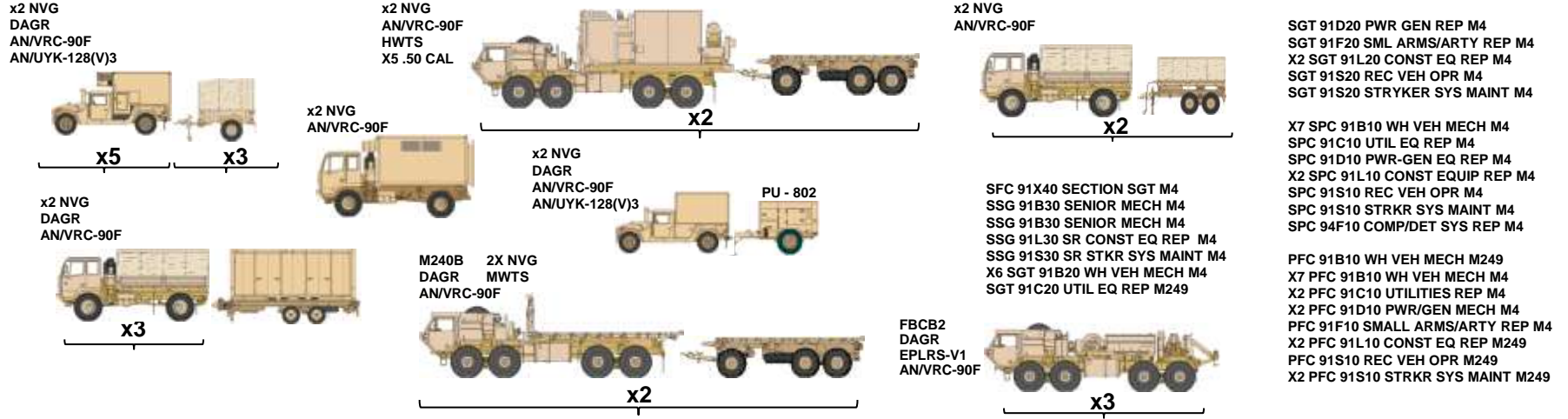

EQUIPMENT SUMMARY

WEAPONS

LAUNCHER GRENADE: M320A1	4
MACHINE GUN 5.56MM M249	9
MACHINE GUN LIGHT 5.56MM M249	4
MACHINE GUN: CALIBER .50 (M2E2)	8
MACHINE GUN 7.62MM M240B	7
PISTOL 9MM AUTOMATIC M9	1
RIFLE 5.56MM M4 CARBINE	97

VEHICLES, TRAILERS, AND TRLR MTD SYSTEMS

CONTAINERIZED KITCHEN (CK)	1
FORWARD REPAIR SYSTEM: M7 (FRS)	1
GEN SET DED TM: 10KW 60HZ (PU-798)	1
GEN SET DED TM: 5KW 60HZ (PU-797)	1
GEN SET DIESEL ENGINE TM: 15KW 50/60HZ (PU-802)	2
SHOP EQUIPMENT: AUTOMOTIVE VEHICLE (TLR MTD) (SATS)	1
TRUCK LIFT FORK: DSL DRVN 4000LB CAP ROUGH TERR	1
TRUCK UTILITY EXP CAPACITY ENH 4X4: M1152A1	8
TRUCK VAN EXPANSIBLE MTV (M1087A1)	1
TRUCK UTILITY EXP CAPACITY ENH 4X4: M1165A1	3
TRUCK VAN LMTV (M1079)	1
TRUCK CARGO: MTV (M1083)	9
TRUCK CARGO: 4X4 LMTV (M1078)	2
TRUCK CARGO MTV LWB (M1085)	1
TRUCK WRECKER: TACTICAL 8X8 HEMTT (M984A1)	1
TRAILER: PLS 8X20 (M1076)	1
TRUCK WRECKER: MTV (M1089)	2
TRAILER CARGO: MTV W/ DROPSIDES (M1095)	8
LIGHT TACTICAL TRAILER: 3/4T (M1101)	4
TRUCK CARGO HEMTT LHS (M1120)	2
SHOP EQUIPMENT: WELDING TRAILER MTD	1
TRAILER TANK WATER (CAMEL) 800 GAL 5 TON	2
M88A2 IRV (HERCULES)	1

COMMUNICATION-ELECTRONICS EQUIPMENT

ANTENNA GROUP: OE-254	4
COMPUTER SYSTEM DIGITAL: AN/UJK-90(V)2 (MTS)	32
COMP SET DIGITAL: AN/UJK-128(V)3 (FBCB2 BFT APPLIQUE)	5
BTL CMD SUSTAINMENT SPT SYSTEM: AN/GYK-61 (BCS3)	1
COMPUTER SYS DIGITAL: AN/TYQ-129(V)2 (TC-AIMS II WS)	1
COMPUTER SET DIGITAL: AN/TYQ-109(V)1 (GCSS-A (V)1)	1
COMPUTER SYSTEM: DIGITAL AN/TYQ-139 (SAMS-1E V1)	3
COMPUTER SYSTEM: DIGITAL AN/TYQ-140 (SAMS/SAMS-1E V2)	1
COMPUTER SYSTEM DIGITAL: AN/UJK-90(V)3 (MTS-CS)	2
INTERCONNECTING GROUP: ON-721/V	1
TERM SAT COMMS : AN/TSC-183: (OL-713(V)1/TYQ CSS VSAT)	1
NAVIGATION SET: SATELLITE SIGNALS AN/PSN-13 (DAGR)	21
PROCESSOR GROUP SIGNAL DATA: (CAISI 2.0) OL-701A/TYQ	2
RADIAC SET: AN/VDR-2	3
RADIO SET: AN/VRC-89F	1
RADIO SET: AN/VRC-90F	50
RADIO SET: AN/VRC-92F	3
COMMS SYSTEM AN/MRC-149 (SOLDIER NETWORK EXTENSION)	1

NIGHT VISION/OBSERVATION EQUIPMENT

DRIVERS VISION ENHANCER: AN/VAS-5	12
NIGHT VISION GOGGLES: AN/PVS-7B	92
MEDIUM THERMAL WEAPONS SIGHT: AN/PAS-13(V2)	14
HEAVY THERMAL WEAPONS SIGHT: AN/PAS-13(V3)	12

MISCELLANEOUS EQUIPMENT

ASSAULT KITCHEN (AK)	4
BED CARGO: DEMOUNTABLE PLS 8X20	1
GEN SET : DED SKID MTD 3KW 60HZ (MEP-831A)	3
GEN SET DIESEL: 60HZ AC MEP-531A	1
GEN SET: DED SKID MTD 10KW 60HZ (MEP-803A)	2
ELECTRONICS SHOP SHEL MTD AVIONICS: AN/ASM-146	1
MULTI-TEMP REFRIGERATED CONTAINER SYS: MTRCS	1
SHOP EQUIP: CONTACT MAINT ORD/ENGR TRK MTD	3

FORWARD SUPPORT COMPANY (CAV), BSB, SBCT

63057R200
4/172/177

MISSION: To provide Field Maintenance, transportation and supply support to the Cavalry Squadron in the SBCT.

COMPANY HEADQUARTERS PARA 01

FBCB2
x2 NVG
DAGR
AN/MRC-149
AN/VRC-92F
AN/UYQ-90(V)2
AN/UYK-128(V)3



DAGR X3 NVG
.50 CAL X3 M240B
AN/GYK-61 (BCS3)
AN/VRC-90F
AN/TYQ-109(V)1
OL-701A/TYQ



1LT 88A00 EXEC OFF M4
1SG 91Z5M 1SG M4
SGT 92Y20 SUPPLY SGT M4

FIELD FEEDING SECTION PARA 02

AN/VRC-90F

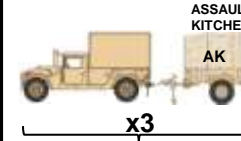

x3

AN/VRC-90F



x2

DAGR .50 CAL
AN/VRC-90F



NOTE: Lift for MTRCS
provided by Distr Sec

SFC 92G40 SR FOOD OPS SGT M4
SSG 92G30 FOOD OPS MGR M4
SGT 92G20 FOOD OPS SGT M4
SGT 92G20 FOOD OPS SGT M4
SPC 92G10 FOOD OPS SP M4
SPC 92G10 FOOD OPS SP M4
SPC 92G10 FOOD OPS SP M4
SPC 92G10 FOOD OPS SP M4
SPC 92G10 FOOD OPS SP M4
SPC 92G10 FOOD OPS SP M4
PFC 92G10 FOOD OPS SP M4
PFC 92G10 FOOD OPS SP M4
PFC 92G10 FOOD OPS SP M249

DISTRIBUTION PLT HQ PARA 03

FBCB2
X2 NVG
DAGR
AN/VRC-92(V)2
AN/UYQ-90(V)3
AN/TYQ-129(V)2



1LT 92A00 PLT LDR M4
SFC 88M40 PLT SGT M4

DISTRIBUTION SECTION PARA 04

X2 M240B
MK19 MOD III
.50 CAL
X2 NVG
DAGR
AN/VRC-90F
MWTS

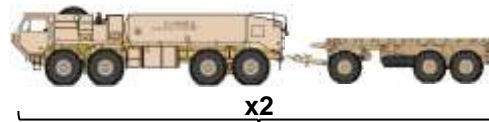

x2

M240B
2X NVG
DAGR
AN/VRC-90F
MWTS

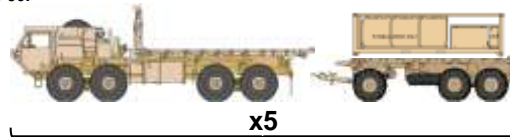

x5

SSG 88M30 SECTION SGT M4
SSG 88M30 HVY VEH DRIVER M4
SGT 88M20 HVY VEH DRIVER M4
SGT 88M20 HVY VEH DRIVER M4
SGT 88M20 HVY VEH DRIVER M4
SGT 89B20 AMMO SGT M4
SGT 92F20 PETRL HVY VEH OPR M4
X3 SPC 88M10 HVY VEH DRIVER M4
X3 SPC 92F10 PETRL HVY VEH OPR M4
PFC 88M10 HVY VEH DRIVER M249
PFC 88M10 HVY VEH DRIVER M249



MAINTENANCE CONTROL & PLT HQ PARA 05

x2 NVG
DAGR
AN/VRC-90F
AN/UYK-128(V)3



1LT 91A00 MAINT CONT OFF M4
SSG 88M30 MASTER DRVR TRNR M4

x2 NVG
DAGR
AN/VRC-90F
KOI-18/TSEC



CW3 915A0 AUTO MAINT WO M4
SGT 915A0 EQ REC/PARTS SGT M4
PFC 92A10 EQUIP REC/PARTS SP M249

AN/TYQ-140
x2 NVG
DAGR
OL-701A/TYQ
AN/VRC-89F
OL-713(V)1
x2 AN/TYQ-139



SFC 91X40 MAINT MGT NCO M4
SPC 92A10 EQUIP REC/PARTS SP M4
SPC 92A10 EQUIP REC/PARTS SP M4
SPC 92A10 EQUIP REC/PARTS SP M4
PFC 92A10 EQUIP REC/PARTS SP M4
PFC 92A10 EQUIP REC/PARTS SP M4

FORWARD SUPPORT COMPANY (CAV), BSB, SBCT

FIELD MAINTENANCE SECTION PARA 06

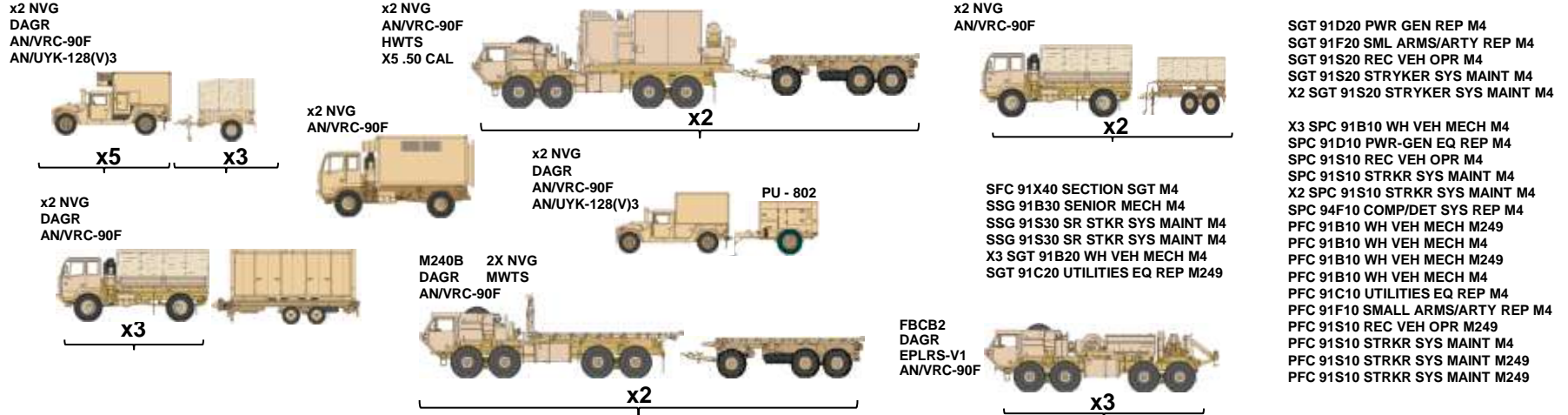

EQUIPMENT SUMMARY

WEAPONS

LAUNCHER GRENADE: M320A1	4
MACHINE GUN 5.56MM M249	9
MACHINE GUN LIGHT 5.56MM M249	4
MACHINE GUN: CALIBER .50 (M2E2)	3
MACHINE GUN 7.62MM M240B	7
PISTOL 9MM AUTOMATIC M9	1
RIFLE 5.56MM M4 CARBINE	77

VEHICLES, TRAILERS, AND TRLR MTD SYSTEMS

CONTAINERIZED KITCHEN (CK)	1
FORWARD REPAIR SYSTEM: M7 (FRS)	1
GEN SET DED TM: 10KW 60HZ (PU-798)	1
GEN SET DED TM: 5KW 60HZ (PU-797)	1
GEN SET DIESEL ENGINE TM: 15KW 50/60HZ (PU-802)	2
SHOP EQUIPMENT: AUTOMOTIVE VEHICLE (TLR MTD) (SATS)	1
TRUCK LIFT FORK: DSL DRVN 4000LB CAP ROUGH TERR	1
TRUCK UTILITY EXP CAPACITY ENH 4X4: M1152A1	8
TRUCK VAN EXPANSIBLE MTV (M1087A1)	1
TRUCK UTILITY EXP CAPACITY ENH 4X4: M1165A1	3
TRUCK VAN LMTV (M1079)	1
TRUCK CARGO: MTV (M1083)	9
TRUCK CARGO: 4X4 LMTV (M1078)	2
TRUCK CARGO MTV LWB (M1085)	1
TRUCK WRECKER: TACTICAL 8X8 HEMTT (M984A1)	1
TRAILER: PLS 8X20 (M1076)	1
TRUCK WRECKER: MTV (M1089)	2
TRAILER CARGO: MTV W/ DROPSIDES (M1095)	8
LIGHT TACTICAL TRAILER: 3/4T (M1101)	4
TRUCK CARGO HEMTT LHS (M1120)	1
SHOP EQUIPMENT: WELDING TRAILER MTD	2
TRAILER TANK WATER (CAMEL) 800 GAL 5 TON	2
M88A2 IRV (HERCULES)	1

COMMUNICATION-ELECTRONICS EQUIPMENT

ANTENNA GROUP: OE-254	4
COMPUTER SYSTEM DIGITAL: AN/UJYQ-90(V)2 (MTS)	32
COMP SET DIGITAL: AN/UJK-128(V)3 (FCB2 BFT APPLIQUE)	5
BTL CMD SUSTAINMENT SPT SYSTEM: AN/GYK-61 (BCS3)	1
COMPUTER SYS DIGITAL: AN/TYQ-129(V)2 (TC-AIMS II WS)	1
COMPUTER SET DIGITAL: AN/TYQ-109(V)1 (GCSS-A (V)1)	1
COMPUTER SYSTEM: DIGITAL AN/TYQ-139 (SAMS-1E V1)	3
COMPUTER SYSTEM: DIGITAL AN/TYQ-140 (SAMS/SAMS-1E V2)	1
COMPUTER SYSTEM DIGITAL: AN/UJYQ-90(V)3 (MTS-CS)	2
INTERCONNECTING GROUP: ON-721/V	1
TERM SAT COMMS : AN/TSC-183: (OL-713(V)1/TYQ CSS VSAT)	1
NAVIGATION SET: SATELLITE SIGNALS AN/PSN-13 (DAGR)	21
PROCESSOR GROUP SIGNAL DATA: (CAISI 2.0) OL-701A/TYQ	2
RADIAC SET: AN/VDR-2	3
RADIO SET: AN/VRC-89F	1
RADIO SET: AN/VRC-90F	50
RADIO SET: AN/VRC-92F	3
COMMS SYSTEM AN/MRC-149 (SOLDIER NETWORK EXTENSION)	1

NIGHT VISION/OBSERVATION EQUIPMENT

DRIVERS VISION ENHANCER: AN/VAS-5	12
NIGHT VISION GOGGLES: AN/PVS-7B	92
MEDIUM THERMAL WEAPONS SIGHT: AN/PAS-13(V2)	14
HEAVY THERMAL WEAPONS SIGHT: AN/PAS-13(V3)	12

MISCELLANEOUS EQUIPMENT

ASSAULT KITCHEN (AK)	4
BED CARGO: DEMOUNTABLE PLS 8X20	1
GEN SET : DED SKID MTD 3KW 60HZ (MEP-831A)	3
GEN SET DIESEL: 60HZ AC MEP-531A	1
GEN SET: DED SKID MTD 10KW 60HZ (MEP-803A)	2
ELECTRONICS SHOP SHEL MTD AVIONICS: AN/ASM-146	1
MULTI-TEMP REFRIGERATED CONTAINER SYS: MTRCS	1
SHOP EQUIP: CONTACT MAINT ORD/ENGR TRK MTD	3

FORWARD SUPPORT COMPANY (IN), BSB, SBCT

63057R200
4/1/85/90

MISSION: To provide Field Maintenance, transportation and supply support to the Infantry Battalions in the SBCT.

COMPANY HEADQUARTERS PARA 01

FBCB2
x2 NVG
DAGR
AN/MRC-149
AN/VRC-92F
AN/UYQ-90(V)2
AN/UYK-128(V)3



CPT 90A00 CDR M4 M9
SPC 92Y10 SUPPLY SPEC M249

DAGR X3 NVG
X3 .50 CAL X3 M240B
MK19 MOD III
AN/GYK-61 (BCS3)
AN/VRC-90F
AN/TYQ-109(V)1
OL-701A/TYQ



1LT 88A00 EXEC OFF M4
1SG 91Z5M 1SG M4
SGT 92Y20 SUPPLY SGT M4

FIELD FEEDING SECTION PARA 02

AN/VRC-90F



x3

DAGR .50 CAL
AN/VRC-90F



DAGR .50 CAL
AN/VRC-90F



x5

AN/VRC-90F



x2

SFC 92G40 SR FOOD OPS SGT M4
SSG 92G30 FOOD OPS MGR M4
SGT 92G20 FOOD OPS SGT M4
SGT 92G20 FOOD OPS SGT M4
SGT 92G20 FOOD OPS SGT M4

X4 SPC 92G10 FOOD OPS SP M4
SPC 92G10 FOOD OPS SP M4
X2 PFC 92G10 FOOD OPS SP M4
PFC 92G10 FOOD OPS SP M4
PFC 92G10 FOOD OPS SP M249

DISTRIBUTION PLT HQ PARA 03

FBCB2
X2 NVG
DAGR
AN/VRC-92(V)2
AN/UYQ-90(V)3
AN/TYQ-129(V)2



1LT 92A00 PLT LDR M4
SFC 88M40 PLT SGT M4

DISTRIBUTION SECTION PARA 04

X2 M240B
MK19 MOD III
.50 CAL
X2 NVG
DAGR
AN/VRC-90F
MWTS



x2

M240B
2X NVG
DAGR
AN/VRC-90F
MWTS



x5

SSG 88M30 SECTION SGT M4
SSG 88M30 HVY VEH DRIVER M4
SGT 88M20 HVY VEH DRIVER M4
SGT 88M20 HVY VEH DRIVER M4
SGT 89B20 AMMUNITION SGT M4
SGT 92F20 PETRL HVY VEH OPR M4
X3 SPC 88M10 HVY VEH DRIVER M4
X3 SPC 92F10 PETRL HVY VEH OPR M4
PFC 88M10 HVY VEH DRIVER M249
PFC 88M10 HVY VEH DRIVER M249



MAINTENANCE CONTROL & PLT HEADQUARTERS PARA 05

x2 NVG
DAGR
AN/VRC-90F
AN/UYK-128(V)3



1LT 91A00 MAINT CONTROL OFF M4
SSG 88M30 MASTER DRVR TRNR M4

x2 NVG
DAGR
AN/VRC-90F
KOI-18/TSEC



CW3 915A0 AUTO MAINT WO M4
SGT 915A0 EQ REC/PARTS SGT M4
PFC 92A10 EQ REC/PARTS SP M249

AN/TYQ-140
x2 NVG
DAGR
OL-701A/TYQ
AN/VRC-89F
OL-713(V)1
x2 AN/TYQ-139



SFC 91X40 MAINT MGT NCO M4
SPC 92A10 EQ REC/PARTS SP M4
SPC 92A10 EQ REC/PARTS SP M4
SPC 92A10 EQ REC/PARTS SP M4
PFC 92A10 EQ REC/PARTS SP M4
PFC 92A10 EQ REC/PARTS SP M4

FORWARD SUPPORT COMPANY (IN), BSB, SBCT

FIELD MAINTENANCE SECTION PARA 06

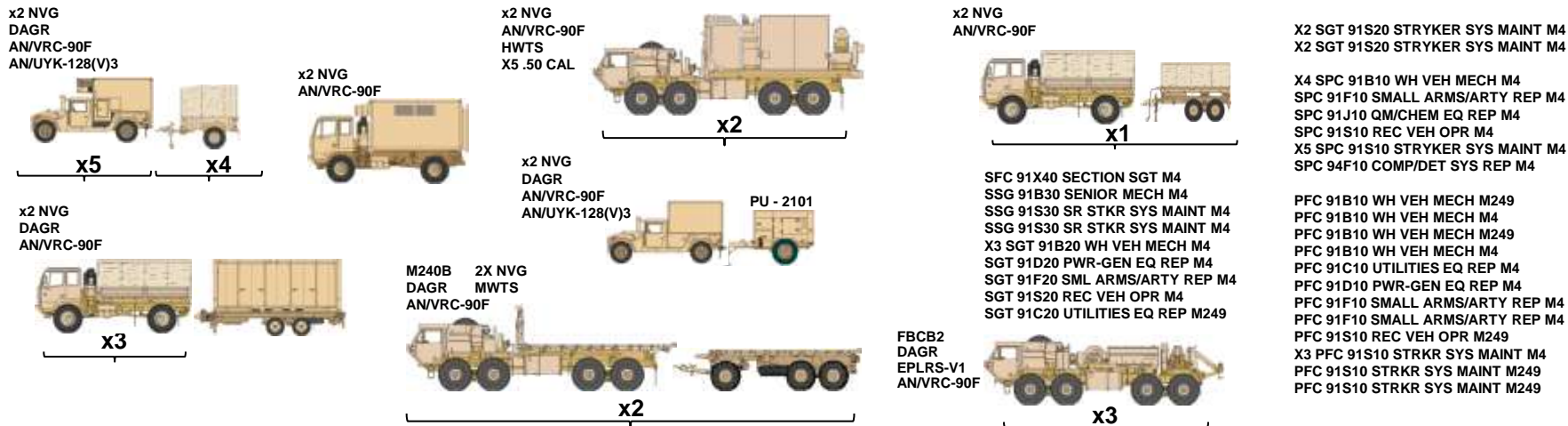

EQUIPMENT SUMMARY

WEAPONS

LAUNCHER GRENADE: M320A1	4
MACHINE GUN 5.56MM M249	9
MACHINE GUN LIGHT 5.56MM M249	4
MACHINE GUN: CALIBER .50 (M2E2)	3
MACHINE GUN 7.62MM M240B	7
PISTOL 9MM AUTOMATIC M9	1
RIFLE 5.56MM M4 CARBINE	77

VEHICLES, TRAILERS, AND TRLR MTD SYSTEMS

CONTAINERIZED KITCHEN (CK)	3
FORWARD REPAIR SYSTEM: M7 (FRS)	1
GEN SET DED TM: 10KW 60HZ (PU-798)	1
GEN SET DED TM: 5KW 60HZ (PU-797)	1
GEN SET DIESEL ENGINE TM: 15KW 50/60HZ (PU-802)	2
SHOP EQUIPMENT: AUTOMOTIVE VEHICLE (TLR MTD) (SATS)	1
TRUCK LIFT FORK: DSL DRVN 4000LB CAP ROUGH TERR	1
TRUCK UTILITY EXP CAPACITY ENH 4X4: M1152A1	8
TRUCK VAN EXPANSIBLE MTV (M1087A1)	1
TRUCK UTILITY EXP CAPACITY ENH 4X4: M1165A1	3
TRUCK VAN LMTV (M1079)	1
TRUCK CARGO: MTV (M1083)	9
TRUCK CARGO: 4X4 LMTV (M1078)	2
TRUCK CARGO MTV LWB (M1085)	1
TRUCK WRECKER: TACTICAL 8X8 HEMTT (M984A1)	1
TRAILER: PLS 8X20 (M1076)	1
TRUCK WRECKER: MTV (M1089)	2
TRAILER CARGO: MTV W/ DROPSIDES (M1095)	8
LIGHT TACTICAL TRAILER: 3/4T (M1101)	4
TRUCK CARGO HEMTT LHS (M1120)	2
SHOP EQUIPMENT: WELDING TRAILER MTD	1
TRAILER TANK WATER (CAMEL) 800 GAL 5 TON	1
M88A2 IRV (HERCULES)	1

COMMUNICATION-ELECTRONICS EQUIPMENT

ANTENNA GROUP: OE-254	4
COMPUTER SYSTEM DIGITAL: AN/UYQ-90(V)2 (MTS)	32
COMP SET DIGITAL: AN/UYK-128(V)3 (FBCB2 BFT APPLIQUE)	5
BTL CMD SUSTAINMENT SPT SYSTEM: AN/GYK-61 (BCS3)	1
COMPUTER SYS DIGITAL: AN/TYQ-129(V)2 (TC-AIMS II WS)	1
COMPUTER SET DIGITAL: AN/TYQ-109(V)1 (GCSS-A (V)1)	1
COMPUTER SYSTEM: DIGITAL AN/TYQ-139 (SAMS-1E V1)	3
COMPUTER SYSTEM: DIGITAL AN/TYQ-140 (SAMS/SAMS-1E V2)	1
COMPUTER SYSTEM DIGITAL: AN/UYQ-90(V)3 (MTS-CS)	2
INTERCONNECTING GROUP: ON-721/V	1
TERM SAT COMMS : AN/TSC-183: (OL-713(V)1/TYQ CSS VSAT)	1
NAVIGATION SET: SATELLITE SIGNALS AN/PSN-13 (DAGR)	21
PROCESSOR GROUP SIGNAL DATA: (CAISI 2.0) OL-701A/TYQ	2
RADIAC SET: AN/VDR-2	3
RADIO SET: AN/VRC-89F	1
RADIO SET: AN/VRC-90F	50
RADIO SET: AN/VRC-92F	3
COMMS SYSTEM AN/MRC-149 (SOLDIER NETWORK EXTENSION)	1

NIGHT VISION/OBSERVATION EQUIPMENT

DRIVERS VISION ENHANCER: AN/VAS-5	12
NIGHT VISION GOGGLES: AN/PVS-7B	92
MEDIUM THERMAL WEAPONS SIGHT: AN/PAS-13(V2)	14
HEAVY THERMAL WEAPONS SIGHT: AN/PAS-13(V3)	12

MISCELLANEOUS EQUIPMENT

ASSAULT KITCHEN (AK)	4
BED CARGO: DEMOUNTABLE PLS 8X20	1
GEN SET : DED SKID MTD 3KW 60HZ (MEP-831A)	3
GEN SET DIESEL: 60HZ AC MEP-531A	1
GEN SET: DED SKID MTD 10KW 60HZ (MEP-803A)	2
ELECTRONICS SHOP SHEL MTD AVIONICS: AN/ASM-146	1
MULTI-TEMP REFRIGERATED CONTAINER SYS: MTRCS	1
SHOP EQUIP: CONTACT MAINT ORD/ENGR TRK MTD	3

FORWARD SUPPORT COMPANY (FA), BSB, SBCT

63057R600
4/1/88/93

COMPANY HEADQUARTERS PARA 01

MISSION: To provide Field Maintenance, transportation and supply support to the Fires Battalion in the SBCT.

FBCB2
x2 NVG
DAGR
AN/MRC-149
AN/VRC-92F
AN/UYQ-90(V)2
AN/UYK-128(V)3



CPT 90A00 CDR M4 M9
SPC 92Y10 SUPPLY SPEC M249

DAGR X3 NVG
X3 .50 CAL X3 M240B
MK19 MOD III
AN/GYK-61 (BCS3)
AN/VRC-90F
AN/TYQ-109(V)1
OL-701A/TYQ



1LT 88A00 EXEC OFF M4
1SG 91Z5M 1SG M4
SGT 92Y20 SUPPLY SGT M4

FIELD FEEDING SECTION PARA 02

AN/VRC-90F



x3

ASSAULT
KITCHEN
AK

AN/VRC-90F



x2

SFC 92G40 SR FOOD OPS SGT M4
SSG 92G30 FOOD OPS MGR M4
SGT 92G20 FOOD OPS SGT M4
SGT 92G20 FOOD OPS SGT M4

DAGR .50 CAL
AN/VRC-90F



X4 SPC 92G10 FOOD OPS SP M4
SPC 92G10 FOOD OPS SP M4
PFC 92G10 FOOD OPS SP M4
PFC 92G10 FOOD OPS SP M4
PFC 92G10 FOOD OPS SP M4

DAGR
AN/VRC-90F



MTRCS

DISTRIBUTION PLT HQ PARA 03

DISTRIBUTION SECTION PARA 04

MAINTENANCE CONTROL & PLT HEADQUARTERS PARA 05

FBCB2
X2 NVG
DAGR
AN/VRC-92(V)2
AN/UYQ-90(V)3
AN/TYQ-129(V)2



PU - 2002

1LT 92A00 PLT LDR M4
SFC 88M40 PLT SGT M4

X2 M240B
MK19 MOD III
.50 CAL
X2 NVG
DAGR
AN/VRC-90F
MWTS



x2

M240B
2X NVG
DAGR
AN/VRC-90F
MWTS



x6

SSG 88M30 SECTION SGT M4
SGT 88M20 HVY VEH DRIVER M4
SGT 88M20 HVY VEH DRIVER M4
SGT 88M20 HVY VEH DRIVER M4
SGT 88M20 HVY VEH DRIVER M4
SGT 88M20 HVY VEH DRIVER M4
SGT 88M20 HVY VEH DRIVER M4
SGT 89B20 AMMUNITION SGT M4
SGT 92F20 PETRL HVY VEH OPR M4
X5 SPC 88M10 HVY VEH DRIVER M4
X3 SPC 92F10 PETRL HVY VEH OPR M249



x2 NVG
DAGR
AN/VRC-90F
AN/UYK-128(V)3



1LT 91A00 MAINT CONTROL OFF M4
SSG 88M30 MASTER DRVR TRNR M4

AN/TYQ-140
x2 NVG
DAGR
OL-701A/TYQ
AN/VRC-89F
OL-713(V)1
x2 AN/TYQ-139



x2 NVG DAGR
.50 CAL
MK19 MOD III
AN/VRC-90F
KOI-18/TSEC



PU-2101

CW3 915A0 AUTO MAINT WO M4
SGT 915A0 EQ REC/PARTS SGT M4
PFC 92A10 EQ REC/PARTS SP M249

SFC 91X40 MAINT MGT NCO M4
SPC 92A10 EQ REC/PARTS SP M4
SPC 92A10 EQ REC/PARTS SP M4
SPC 92A10 EQ REC/PARTS SP M4
PFC 92A10 EQ REC/PARTS SP M249
PFC 92A10 EQ REC/PARTS SP M249

FORWARD SUPPORT COMPANY (FA), BSB, SBCT

FIELD MAINTENANCE SECTION PARA 06

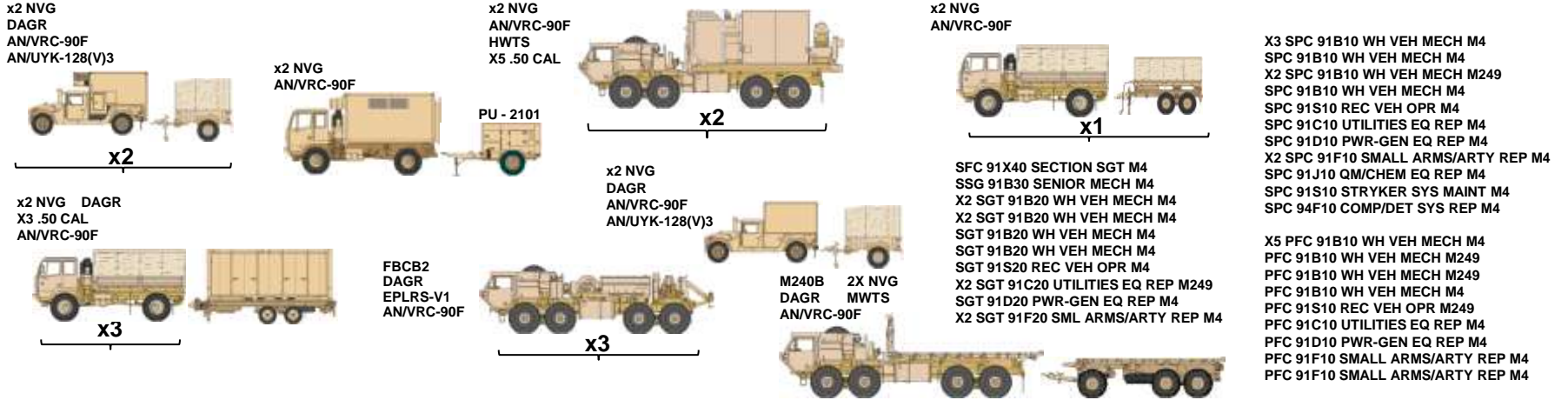

RADAR REPAIR TEAM PARA 07



EQUIPMENT SUMMARY

WEAPONS

LAUNCHER GRENADE: M320A1	4
MACHINE GUN 5.56MM M249	9
MACHINE GUN LIGHT 5.56MM M249	4
MACHINE GUN: CALIBER .50 (M2E2)	3
MACHINE GUN 7.62MM M240B	7
PISTOL 9MM AUTOMATIC M9	1
RIFLE 5.56MM M4 CARBINE	77

VEHICLES, TRAILERS, AND TRLR MTD SYSTEMS

CONTAINERIZED KITCHEN (CK)	3
FORWARD REPAIR SYSTEM: M7 (FRS)	1
GEN SET DED TM: 10KW 60HZ (PU-798)	1
GEN SET DED TM: 5KW 60HZ (PU-797)	1
GEN SET DIESEL ENGINE TM: 15KW 50/60HZ (PU-802)	2
SHOP EQUIPMENT: AUTOMOTIVE VEHICLE (TLR MTD) (SATS)	1
TRUCK LIFT FORK: DSL DRVN 4000LB CAP ROUGH TERR	1
TRUCK UTILITY EXP CAPACITY ENH 4X4: M1152A1	8
TRUCK VAN EXPANSIBLE MTV (M1087A1)	1
TRUCK UTILITY EXP CAPACITY ENH 4X4: M1165A1	3
TRUCK VAN LMTV (M1079)	1
TRUCK CARGO: MTV (M1083)	9
TRUCK CARGO: 4X4 LMTV (M1078)	2
TRUCK CARGO MTV LWB (M1085)	1
TRUCK WRECKER: TACTICAL 8X8 HEMTT (M984A1)	1
TRAILER: PLS 8X20 (M1076)	1
TRUCK WRECKER: MTV (M1089)	2
TRAILER CARGO: MTV W/ DROPSIDES (M1095)	8
LIGHT TACTICAL TRAILER: 3/4T (M1101)	4
TRUCK CARGO HEMTT LHS (M1120)	2
SHOP EQUIPMENT: WELDING TRAILER MTD	1
TRAILER TANK WATER (CAMEL) 800 GAL 5 TON	1
M88A2 IRV (HERCULES)	1

COMMUNICATION-ELECTRONICS EQUIPMENT

ANTENNA GROUP: OE-254	4
COMPUTER SYSTEM DIGITAL: AN/UYQ-90(V)2 (MTS)	32
COMP SET DIGITAL: AN/UYK-128(V)3 (FBCB2 BFT APPLIQUE)	5
BTL CMD SUSTAINMENT SPT SYSTEM: AN/GYK-61 (BCS3)	1
COMPUTER SYS DIGITAL: AN/TYQ-129(V)2 (TC-AIMS II WS)	1
COMPUTER SET DIGITAL: AN/TYQ-109(V)1 (GCSS-A (V)1)	1
COMPUTER SYSTEM: DIGITAL AN/TYQ-139 (SAMS-1E V1)	3
COMPUTER SYSTEM: DIGITAL AN/UYQ-140 (SAMS/SAMS-1E V2)	1
COMPUTER SYSTEM DIGITAL: AN/UYQ-90(V)3 (MTS-CS)	2
INTERCONNECTING GROUP: ON-721/V	1
TERM SAT COMMS : AN/TSC-183: (OL-713(V)1/TYQ CSS VSAT)	1
NAVIGATION SET: SATELLITE SIGNALS AN/PSN-13 (DAGR)	21
PROCESSOR GROUP SIGNAL DATA: (CAISI 2.0) OL-701A/TYQ	2
RADIAC SET: AN/VDR-2	3
RADIO SET: AN/VRC-89F	1
RADIO SET: AN/VRC-90F	50
RADIO SET: AN/VRC-92F	3
COMMS SYSTEM AN/MRC-149 (SOLDIER NETWORK EXTENSION)	1

NIGHT VISION/OBSERVATION EQUIPMENT

DRIVERS VISION ENHANCER: AN/VAS-5	12
NIGHT VISION GOGGLES: AN/PVS-7B	92
MEDIUM THERMAL WEAPONS SIGHT: AN/PAS-13(V2)	14
HEAVY THERMAL WEAPONS SIGHT: AN/PAS-13(V3)	12

MISCELLANEOUS EQUIPMENT

ASSAULT KITCHEN (AK)	4
BED CARGO: DEMOUNTABLE PLS 8X20	1
GEN SET : DED SKID MTD 3KW 60HZ (MEP-831A)	3
GEN SET DIESEL: 60HZ AC MEP-531A	1
GEN SET: DED SKID MTD 10KW 60HZ (MEP-803A)	2
ELECTRONICS SHOP SHEL MTD AVIONICS: AN/ASM-146	1
MULTI-TEMP REFRIGERATED CONTAINER SYS: MTRCS	1
SHOP EQUIP: CONTACT MAINT ORD/ENGR TRK MTD	3

MEDICAL COMPANY, BSB, SBCT





MISSION.

To provide brigade-level Combat Health Support (CHS) to organizations subordinate to the brigade, and to non-brigade organizations operating in the brigade area. This support includes the employment/coordination of corps level Force Health Protection (FHP) assets attached to the Brigade Combat Team (BCT) for operations.

MEDICAL COMPANY, BSB, SBCT

08108R000
16/072/88

COMPANY HEADQUARTERS PARA 01

<p>FBCB2 2X NVG DAGR EPLRS AN/VRC-89F AN/UJK-128(V)1</p>  <p>x2</p> <p>MAJ 05A00 CDR M4 M9 SPC 74D10 CBRN DECON SP M4</p>	<p>FBCB2 2X NVG DAGR EPLRS AN/VRC-89F</p>  <p>x2</p> <p>CPT 70B67 CO XO M4 1SG 68W5M 1SG M4 SPC 74D10 CBRN SP M4 PFC 68J10 MED LOG SP M4</p>	<p>PU 2002</p> 	<p>FBCB2 2X NVG DAGR EPLRS AN/VRC-90F AN/VRC-104(V)3</p> 	<p>AN/TYQ-106(V)1 X3 AN/TYQ-105(V)1 AN/GYK-62B AN/TYQ-107(V)1 AN/TYQ-108(V)3 AN/TYQ-139</p>
<p>2X NVG AN/VRC-90F AN/TYQ-109(V)1</p>  <p>SPC 92Y10 SUPPLY SP M4 SGT 92Y20 SUPPLY NCO M4</p>	<p>1LT 70K67 HEALTH SVC MAT OFF M4 SSG 68J30 MED LOG SGT M4 SGT 68A20 BIOMED EQ SGT M4 SGT 68J20 MED LOG SGT M4 SPC 68J10 MED LOG SP M4 SPC 74D10 CBRN DECON SP M4 SPC 68A10 BIOMEDICAL EQUIP SP M4</p>			

PREVENTIVE MED SECTION PARA 02 MENTAL HEALTH SECTION PARA 03 MED TREATMENT PLT HQ PARA 04

<p>FBCB2 2X NVG DAGR EPLRS AN/VRC-90F</p>  <p>1LT 72D67 ENVIR SCI OFF M4 SPC 68S10 PREV MED SP M4</p>	<p>AN/TYQ-107(V)1</p>	<p>FBCB2 2X NVG DAGR EPLRS AN/VRC-90F</p>  <p>CPT 67D00 BEHAVIORAL SCI OFF M4 AN/TYQ-105(V)1 CPT 67D00 BEHAVIORAL SCI OFF M4 AN/TYQ-105(V)1 SGT 68X20 BEHAVIORAL HLTH NCO M4 SPC 68X10 BEHAVIORAL HLTH SP M4</p>	<p>FBCB2 2X NVG DAGR EPLRS AN/VRC-90F AN/UJK-128(V)1</p>  <p>1LT 70B67 FLD MED ASST M4 SFC 68W40 PLT SGT M4</p>	<p>FBCB2 2X NVG DAGR EPLRS AN/VRC-90F AN/TYQ-107(V)1 AN/TYQ-106(V)1 OL-701A/TYQ</p>	<p>FBCB2 2X NVG DAGR EPLRS AN/VRC-90F AN/VRC-90F</p>  <p>SPC 68G10 PAT ADMIN SP M4</p>
---	-----------------------	---	--	---	---

MEDICAL SECTION PARA 05

FBCB2
AN/VAS-5
2X NVG
DAGR
EPLRS
AN/VRC-89F
OL-701A/TYQ
AN/UJK-128(V)1



AN/TYQ-106(V)1
FBCB2
AN/VAS-5
2X NVG
DAGR
EPLRS
AN/VRC-89F
AN/UJK-128(V)1



x3

CPT 65D00 PA M9 AN/TYQ-105(V)1
CPT 62B00 SURGEON/PLT LDR M9 AN/TYQ-105(V)1
CPT 65D00 PA M9 AN/TYQ-105(V)1
SSG 68W30 HLTH CARE SGT M4 AN/TYQ-105(V)1
SSG SSG 68W30 HLTH CARE SGT M4 AN/TYQ-105(V)1
SGT 68W20 HLTH CARE SGT M4 AN/TYQ-105(V)1
SGT HLTH CARE SGT M4 AN/TYQ-105(V)1
SPC HLTH CARE SP M4 AN/TYQ-105(V)1
SPC 68W10 HLTH CARE SP M4 AN/TYQ-105(V)1
PFC 68W10 HLTH CARE SP M4 AN/TYQ-105(V)1
PFC HLTH CARE SP M4 AN/TYQ-105(V)1
PFC 68W10 HLTH CARE SP M4 AN/TYQ-105(V)1

AREA SUPPORT SQUAD PARA 06

FBCB2
2X NVG
DAGR
EPLRS
AN/VRC-90F



PU 803

CPT 63A00 DENTAL OFF M9
CPT 65B00 PHYSICAL THERAPIST M4
SGT 68K20 MED LAB SGT M4
SGT 68W20 PHYSICAL THERAPY SGT M4
SGT 68P20 RADIOLOGY SGT M4
SPC 68E10 DENTAL SP M4
SPC 68K10 MED LAB SP M4
SPC RADIOLOGY SP M4

MEDICAL TREATMENT SQUAD (AREA) PARA 07 PATIENT HOLDING SQUAD PARA 08

AN/TYQ-106(V)1
FBCB2
2X NVG
DAGR
EPLRS
OL-701A/TYQ
AN/VRC-89F
AN/UJK-128(V)1



x2

FBCB2
2X NVG
DAGR
EPLRS
AN/VRC-90F
AN/UJK-128(V)1



MAJ 62B00 SURGEON M9 AN/TYQ-105(V)1
MAJ 65D00 SR PA M9 AN/TYQ-105(V)1
SSG 68W30 HLTH CARE SGT M4 AN/TYQ-105(V)1
SGT 68W20 HLTH CARE SGT M4 AN/TYQ-105(V)1
SGT 68W20 HLTH CARE SGT M4 AN/TYQ-105(V)1
SPC 68W10 HLTH CARE SP M4 AN/TYQ-105(V)1
PFC 68W10 HLTH CARE SP M4 AN/TYQ-105(V)1
PFC 68W10 HLTH CARE SP M4 AN/TYQ-105(V)1

FBCB2
2X NVG
DAGR
EPLRS
AN/VRC-90F
AN/TYQ-106(V)1
AN/TYQ-106(V)1
X5 AN/TYQ-105(V)1



CPT 66H00 MED-SURGICAL NURSE M4
SGT 68W20 HLTH CARE SGT M4
SGT 68W20 HLTH CARE SGT M4
SPC 68W10 HLTH CARE SP M4
PFC 68W10 HLTH CARE SP M4

MEDICAL COMPANY, BSB, SBCT

EVACUATION PLT HQ PARA 09

FBCB2 AN/TYQ-107(V)1
2X NVG OL-701A/TYQ
DAGR
EPLRS
AN/VRC-89F
AN/UYK-128(V)1



1LT 70B67 PLT LDR M4
SFC 68W40 PLT SGT M4

EVACUATION SQUAD (FORWARD) PARA 10

FBCB2 AN/VAS-5
2X NVG
DAGR
EPLRS
AN/VRC-90F
AN/UYK-128(V)1
X2 AN/TYQ-105(V)1



SGT 68W20 ER CARE SGT M4
SPC 68W10 DRIVER 4M
PFC 68W10 DRIVER M4

FBCB2 AN/VAS-5
2X NVG
DAGR
EPLRS
AN/VRC-90F
AN/UYK-128(V)1
X2 AN/TYQ-105(V)1



SPC 68W10 DRIVER 4M
SPC 68W10 DRIVER 4M
PFC 68W10 DRIVER M4

x3

EVACUATION SQUAD (AREA) PARA 11

FBCB2 AN/VAS-5
2X NVG
DAGR
EPLRS
AN/VRC-90F
AN/UYK-128(V)1
X2 AN/TYQ-105(V)1



SGT 68W20 ER CARE SGT M4
SPC 68W10 DRIVER 4M
PFC 68W10 DRIVER M4

FBCB2 AN/VAS-5
2X NVG
DAGR
EPLRS
AN/VRC-90F
AN/UYK-128(V)1
X2 AN/TYQ-105(V)1



SPC 68W10 DRIVER 4M
SPC 68W10 DRIVER 4M
PFC 68W10 DRIVER M4

x2

EQUIPMENT SUMMARY

WEAPONS

P98152 PISTOL 9MM AUTOMATIC: M9 7
R97234 RIFLE 5 56 MILLIMETER: M4 70

VEHICLES, TRAILERS AND TRLR MTD SYSTEMS

T37588 TRUCK UTILITY EXPANDED CAPACITY ENHANCED: M1152A1 6
T38844 TRUCK AMBULANCE: 4 LITTER ARMD 4X4 W/E (HMMWV) 5
T38844 TRUCK AMBULANCE: 4 LITTER ARMD 4X4 W/E (HMMWV) 10
T41515 TRUCK CARGO: 5 TON WO/WINCH 6
T56383 TRUCK UTILITY EXPANDED CAPACITY ENHANCED 4X4: M1165A1 3
T95555 TRAILER CARGO: MTV W/DROPSIDES M1095 4
T95992 LIGHT TACTICAL TRAILER: 3/4 TON 17
Z01395 TRAILER-MTD: PU-2102/ 30 KW/ 50/60HZ/ M200A1 1
Z01414 LTT TRAILER-MTD: PU-2002/ 10 KW/ 50/60HZ 1
Z36683 TRAILER TANK WATER (CAMEL): 800 GAL 5 TON W/E 1

NIGHT VISION/OBSERVATION

D41659 DRIVERS ENHANCERS: AN/VAS-5 15
N05482 NIGHT VISION: GOGGLE 60

COMMUNICATIONS AND ELECTRONICS

C18209 COMPUTER SET: DIGITAL AN/TYQ-107(V)2 1
C18277 COMPUTER SET: DIGITAL AN/TYQ-107(V)1 8
C18345 COMPUTER SET: DIGITAL AN/TYQ-106(V)1 12
C18378 COMPUTER SET: AN/UYK-128(V)3 29
C27503 COMPUTER SYSTEM: DIGITAL AN/TYQ-105(V)1 58
C27639 COMPUTER SYSTEM: DIGITAL AN/TYQ-108(V)3 3
C27707 COMPUTER SYSTEM: DIGITAL AN/TYQ-109(V)1 1
C27838 COMPUTER SYS DIGITAL: AN/TYQ-139 1
N96248 NAVIGATION SET: SATELLITE SIGNALS AN/PSN-13 29
P49587 PJH SURFACE VEHICLE RADIO SET: AN/VSQ-2(V) 29
P99881 PROCESSOR GROUP SIG DATA: (CAISI 2.0) OL-701A/TYQ 7
R44999 RADIO SET: AN/VRC-89F(C) 11
R68044 RADIO SET: AN/VRC-90F(C) 19
R87139 RADIO ST: AN/VRC-104(V)3 150 WATT W/PRC-150 HF RADIO 1
Z00384 COMPUTER SYSTEM DIGITAL: AN/PYQ-10(C) 29
Z01247 COMPUTER SET: DIGITAL AN/UYK-128(V)1 20
Z01248 COMPUTER SET: DIGITAL AN/GYK-62B 1

MISC EQUIPMENT

A27104 ANALYZER NON-INVAS BLOOD PRESS: (ANBP) 1
A83359 ANALYZER BLOOD: (AB) 2
A83433 ANALYZER DEFIBRILLATOR-ELECTROCARDIOGRAPH TRANSCUTANEOUS: 1
C05701 MONITOR CHEMICAL AGENT: 3
D39478 DES DENTAL X-RAY FIELD: 1
D43802 DENTAL EQUIPMENT SET: COMPREHENSIVE DENTISTRY FIELD 1
D44052 DENTAL FIELD TREATMENT AND OPERATING SYSTEM (DEFTO): 1
D44302 DENTAL FILMLESS IMAGING SYSTEM (DFIS): 1
D82404 DECONTAMINATING APPARATUS: PWR DRVN LT WT 2
D86072 DEFIBRILLATOR MONITOR RECRDR: 120/230V 50/60HZ AC OR DC 1
D95343 DENTAL EQUIPMENT SET DENTAL SUPPORT: 1
F95504 DENTAL INSTRUMENT AND SUPPLY SET EMER TREATMENT FIELD: 1
F95778 DENTAL SUPPLY SET EMERGENCY DENTURE REPAIR: 1
G18358 GEN SET: DED SKID MTD 3KW 60HZ 5
H10793 ENTOMOLOGICAL COLLECTING KIT FIELD: 1
J00697 JOINT CHMCL AGENT: DETECTOR 7
J01197 JOINT SERVICE: TRANSPORTABLE DECONTAMINATION 2
J24245 INFUSION: PUMP ANALYZER (IPU) 1
M12986 MASK CHEMICAL BIO JOINT SERVICE GEN PURPOSE: FIELD M50 46
M13236 MASK CHEMICAL-BIO JNT SRV GNL PRPSE: CMBT VHL CRWMN M51 30
M23673 MEDICAL EQUIP SET CHEMICAL AGENT PATIENT TREATMENT: 5
M25865 MEDICAL EQUIPMENT SET CHEM AGENTS PATIENT DECON: 3
M26413 MEDICAL EQUIPMENT SET GROUND AMBULANCE: 1
M28909 MEDICAL EQUIPMENT SET INDUSTRIAL HYGIENE SURVEY: FIELD 1
M29159 MEDICAL EQUIPMENT SET LABORATORY FIELD LIGHTWEIGHT: 1
M29633 MEDICAL EQUIP SET PATIENT HOLDING SQD FLD LIGHTWEIGHT: 1
M29701 MEDICAL EQUIP SET PRIMARY GYNECOLOGICAL CARE AUGMENTATION: 1
M30156 MEDICAL EQUIPMENT SET SICK CALL FIELD: 5
M30499 MEDICAL EQUIPMENT SET TACTICAL COMBAT MEDICAL CARE: 5
M30817 MEDICAL FILMLESS IMAGING SYS: 1
M45613 MEDICAL EQUIPMENT SET X-RAY FIELD LIGHTWEIGHT: 1
M66626 MONITOR PATIENT VITAL SIGNS: (MVS) 3
P16161 PUMP INTRAVENOUS INFUSION PIV: 2
P40750 POWER SUPPLY: PP-6224/U 7
P43667 OSCILLOSCOPE DIGITAL HANDHELD (ODHH): 1
X38819 X-RAY: APPARATUS DEN 1
X90968 X-RAY APPARATUS: LOW CAPACITY PORT 1
Y36849 MEDICAL EQUIPMENT SET WATER QUAL ANALYSIS PREVENTIVE MEDICINE: 1