

MODELA

MDX-50

User's Manual

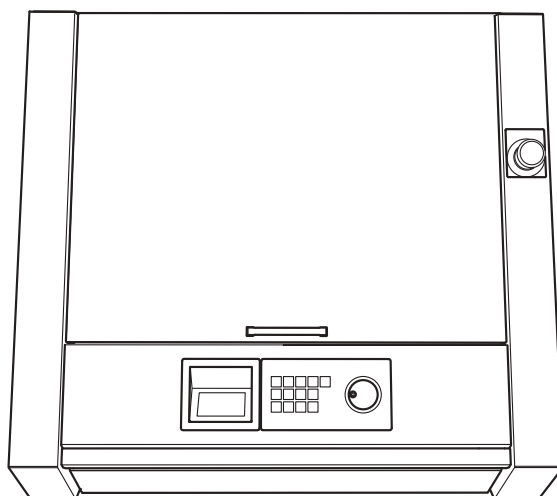

Thank you very much for purchasing this product.

- To ensure correct and safe usage with a full understanding of this product's performance, be sure to read through this document completely and store it in a safe location.
- Unauthorized copying or transferal, in whole or in part, of this document is prohibited.
- The contents of this document and the specifications of this product are subject to change without notice.
- This product and this document have been prepared and tested as much as possible. If you find any misprints or errors, please inform us.
- Roland DG Corporation assumes no responsibility for any direct or indirect loss or damage that may occur through use of this product, regardless of any failure to perform on the part of this product.
- Roland DG Corporation assumes no responsibility for any direct or indirect loss or damage that may occur with respect to any article made using this product.

Roland DG Corporation

<http://www.rolanddg.com/>



Company names and product names are trademarks or registered trademarks of their respective holders.

Copyright © 2016-2017 Roland DG Corporation

Roland DG Corporation has licensed the MMP technology from the TPL Group.

Contents

Contents.....	1
1. Built-in Panel Operation (Basic).....	3
Built-in Panel Screen and Functions.....	4
What Is the Built-in Panel?.....	4
Built-in Panel Function List.....	5
2. VPanel Operation (Basic).....	6
VPanel Basic Operation.....	7
What Is VPanel?.....	7
Displaying VPanel.....	7
VPanel Display in the Task Tray.....	8
Exiting VPanel.....	8
Top Window.....	9
Top Window.....	9
3. Cutting (One Side Cutting).....	11
Performing an Emergency Stop on This Machine.....	12
Emergency Stop.....	12
Emergency Stop or Pause Due to Opening or Closing the Cover.....	13
Emergency Stop Due to Opening or Closing the Cover.....	13
Pause Due to Opening or Closing the Cover.....	14
Machine Statuses Indicated by Status Light Color.....	15
What Is the Status Light?.....	15
1. Checking the Cutting Area.....	16
Cuttable Workpiece (Cutting Material) Size.....	16
2. Items Necessary for Cutting.....	17
Cutter.....	17
Workpiece (Cutting Material).....	17
Scrap Board.....	17
3. Cutting.....	18
Step 1 : Preparing the Tool Bur.....	18
Step 2 : Loading the Tool Bur on the Machine.....	20
Step 3 : Mounting the Workpiece on the Machine.....	21
Step 4 : Setting the XY Origin.....	22
Step 5 : Setting the Z Origin (Using the Z0 Sensor).....	24
Step 6 : Outputting Cutting Data.....	27
Adjusting the Feeding Speed/Spindle Rotating Speed during Cutting.....	28
4. Maintenance.....	29
Maintenance Precautions.....	30
Maintenance Precautions.....	30
Daily Maintenance.....	31
Cleaning after Cutting Finishes.....	31
Periodic Maintenance.....	33
Situations Requiring Maintenance.....	33
Replacing Consumable Parts.....	33
Spindle Run-in (Warm-up).....	34
Correcting the Cutting Machine (Automatic Correction).....	35
Retightening the Collet.....	37
5. Built-in Panel Operation (Practical Use).....	40
Built-in Panel Functions.....	41
Using Hand-wheel Operations to Move the Tool Bur (Hand-wheel Feed).....	41
Quickly Moving to a Specific Position.....	42
Changing the Coordinate System.....	43
Starting and Stopping Spindle Rotation.....	44
Setting the Origin.....	44

Setting the Z Origin Using the Z0 Sensor	44
Operation of the Tool Bur Replacement Function (Auto Tool Changer)	45
How to Set Overrides	46
Checking Job/Tool Bur Information during Cutting	46
Pausing/Resuming/Canceling Cutting	47
Recovering from Errors	48
Turning Off the Status Lights during Cutting	49
Changing the Blower Strength during Cutting	49
6. VPanel Operation (Practical Use)	50
 "Settings" Dialog Box	51
"Preferences" Tab	51
"Machine" Tab	51
"Correction" Tab	52
"Origin" Tab	53
"Maintenance" Tab	55
"Mail" Tab	56
"Operation" Tab	57
"NC code setting" Dialog Box	58
"Attach/detach tool" Dialog Box	59
"Sensing Z origin" Dialog Box	59
"Spindle maintenance" Dialog Box	60
"Automatic correction" Dialog Box	60
"Manual correction" Dialog Box	61
"Move to user specified location" Dialog Box	62
 "Cutter management" Dialog Box	63
"Cutter management" Dialog Box	63
"Cutter registration" Dialog Box	64
 "Cut" Dialog Box	66
"Cut" Dialog Box	66
"Test cut" Dialog Box	67
7. Troubleshooting	68
Machine/VPanel Problems	69
The Power Does Not Turn On	69
Initial Operations Are Not Performed or Fail	69
VPanel Doesn't Start Correctly	69
Operations Are Ignored	70
Detection with the Z0 Sensor Fails	70
Automatic Correction Fails	71
Abnormal Cutting Is Performed	71
When the Machine Stops with the Tool Bur Inserted in the Workpiece	71
No Data Can Be Output to the Machine or the Machine Does Not Operate Even Though Data Is Being Output	72
Misaligned Origins	72
Quality Problems	73
The Cutting Results Are Not Attractive	73
Installation Problems	74
Installing the Driver Separately	74
Installing the Software and the Electronic-format Manuals Separately	76
Driver Installation Is Impossible	77
Uninstalling the Driver	78
Uninstalling VPanel	79
An Error Message Appears	80
8. NC Code Specifications	87
NC Code Specifications	88
List of Settings Related to NC Codes	88
Interpretations When NC Codes Are Omitted	89
List of Words Supported by This Machine	90

1. Built-in Panel Operation (Basic)

Built-in Panel Screen and Functions	4
What Is the Built-in Panel?	4
Built-in Panel Function List	5

Built-in Panel Screen and Functions

What Is the Built-in Panel?

The built-in panel contains the frequently used functions. You can use it to perform operations while checking the machine's internal behavior.

☞ P. 5 "Built-in Panel Function List"

Display Screen (Top Window)

This displays the currently selected coordinate system. The coordinate system is related to the display of the tool bur position and to the origin setting.

This displays the current tool bur position. The item being operated by the hand-wheel is indicated by the "▶."

This displays the hand-wheel feed precision.

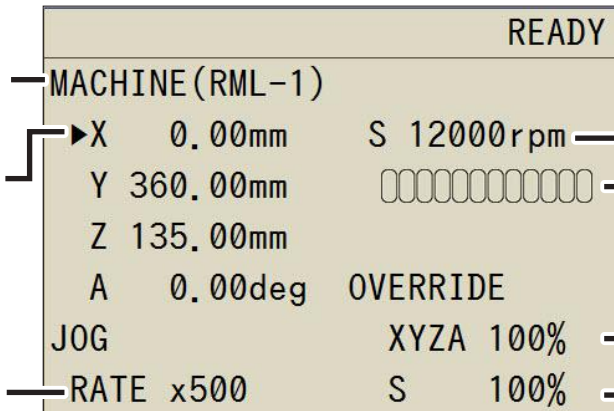

The value displayed here is the currently set spindle rotation speed with the override taken into account.

This displays the current spindle load.





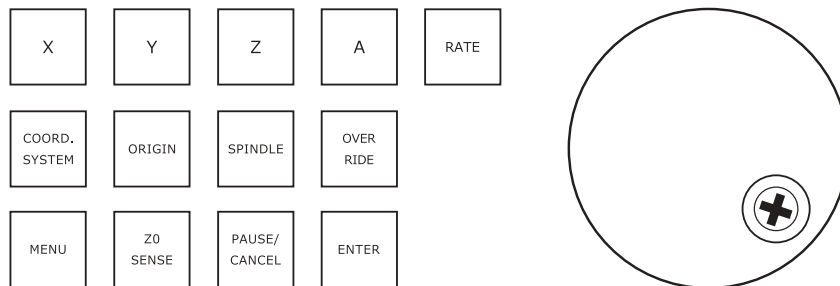

This displays the feeding speed override value.

This displays the spindle override value.

Operation Keys



Part	Name	Details	Notation used in this document
	Axis selection keys	Select the axis to use as the target for hand-wheel feed and origin settings. Use the [A] key when the optional rotary axis unit is attached.	[X] [Y] [Z] [A]
	Rate key	Select the level of precision of the hand-wheel feed. Lower scaling factors produce correspondingly slower movement, enabling you to accomplish precise positioning.	[RATE]
	Coordinate system selection key	Press this key to change the coordinate system. The coordinate system is related to the display of the tool bur position and to the origin setting.	[COORD.SYSTEM]
	Origin setting key	Hold down this key to set the origin to the current tool bur position of the selected axis.	[ORIGIN]
	Spindle key	Start and stop the rotation of the spindle. Tap this key to select the spindle, and hold down this key to rotate the spindle.	[SPINDLE]

Part	Name	Details	Notation used in this document
	Override key	Select the feeding speed override and the spindle rotating speed override.	[OVER RIDE]
	Menu key	Call up the submenu.	[MENU]
	Z0 sensor key	Use this key when you use a Z0 sensor to set the Z origin.	[Z0 SENSE]
	Pause/cancel key	Pauses and resumes cutting. When you press this key with cutting paused, you will be given the option of resuming or canceling cutting.	[PAUSE/CANCEL]
	Enter key	Confirms operations.	[ENTER]
	Hand-wheel	Set the hand-wheel feed for each axis and increase/decrease setting values.	

Built-in Panel Function List

CAUTION: Never operate the built-in panel and VPanel simultaneously.

Function	Page
"Using Hand-wheel Operations to Move the Tool Bur (Hand-wheel Feed)"	P.41
"Quickly Moving to a Specific Position"	P.42
"Changing the Coordinate System"	P.43
"Starting and Stopping Spindle Rotation"	P.44
"Setting the Origin"	P.44
"Setting the Z Origin Using the Z0 Sensor"	P.44
"Operation of the Tool Bur Replacement Function (Auto Tool Changer)"	P.45
"How to Set Overrides"	P.46
"Checking Job/Tool Bur Information during Cutting"	P.46
"Pausing/Resuming/Canceling Cutting"	P.47
"Recovering from Errors"	P.48
"Turning Off the Status Lights during Cutting"	P.49
"Changing the Blower Strength during Cutting"	P.49

2. VPanel Operation (Basic)

VPanel Basic Operation	7
What Is VPanel?	7
Displaying VPanel	7
VPanel Display in the Task Tray	8
Exiting VPanel	8
Top Window	9
Top Window	9

VPanel Basic Operation

What Is VPanel?

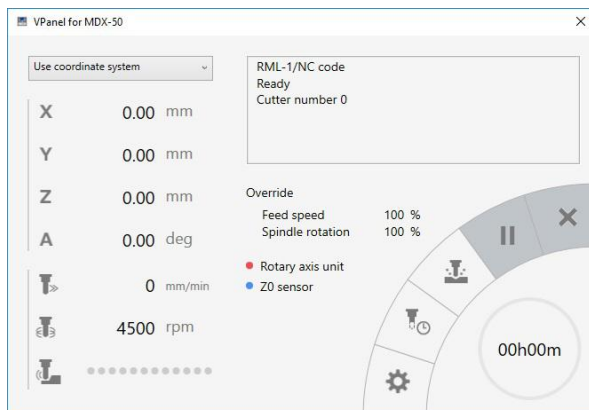

VPanel is an application that can be used to operate this cutting machine from a computer screen. It has functions for outputting cutting data, performing maintenance, and making various corrections. It also displays information such as the cutting machine status and errors.

⇨ "Setup Guide" ("Installing the Software")

Displaying VPanel

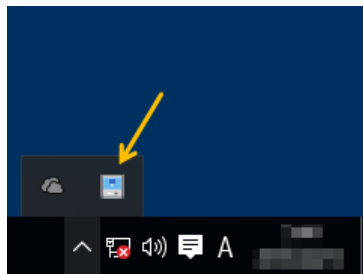

Click  (the VPanel icon) in the task tray on the desktop.

The top window of VPanel will appear. If you cannot find  in the task tray, start the program from the Windows [Start] screen (or the [Start] menu).

Starting from the Windows [Start] Screen (or [Start] Menu)



Windows 10 and 7

From the [Start] menu, click [All apps] (or [All Programs]), [VPanel for MDX-50], and then click [VPanel for MDX-50].

Windows 8.1

Click  on the [Start] screen, and then from the Apps screen, click the [VPanel for MDX-50] icon under [VPanel for MDX-50].



It is useful to set VPanel as resident software.

VPanel is a piece of resident software that is constantly working to manage the cutting machine and send e-mails.* It is useful to configure VPanel so that it starts automatically when the computer starts. (⇨ P. 57 "Operation" Tab) Clicking the Close button () in the upper right of the top window will minimize the window to the task tray. The window will disappear from the screen, but the program will not be exited. While VPanel is running,  is constantly displayed in the task tray.

* E-mails are sent to notify the user of cutting completion or errors that occur. (⇨ P. 56 "Mail" Tab)

VPanel Display in the Task Tray

When the VPanel icon is displayed in the task tray, the status of the connected cutting machine is always monitored. The display of the VPanel icon changes depending on the status of the cutting machine. The meanings of the displays are shown below.

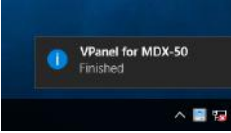
	Indicates that the cutting machine is on (is online).
	Indicates that the cutting machine is off.
	Indicates that an error has occurred on the cutting machine.
	Messages are displayed automatically if an error occurs, during cutting, and in similar situations. Even after the message disappears, if you hover the mouse pointer over this icon, the status of the machine (such as Ready, Cutting, Finished, Completed, or Offline) will be displayed.

Exiting VPanel



Right-click  in the task tray, and then click [Exit].

MEMO

Even if you click the Close button ([x]) to close the top window, you will not exit VPanel.

Top Window





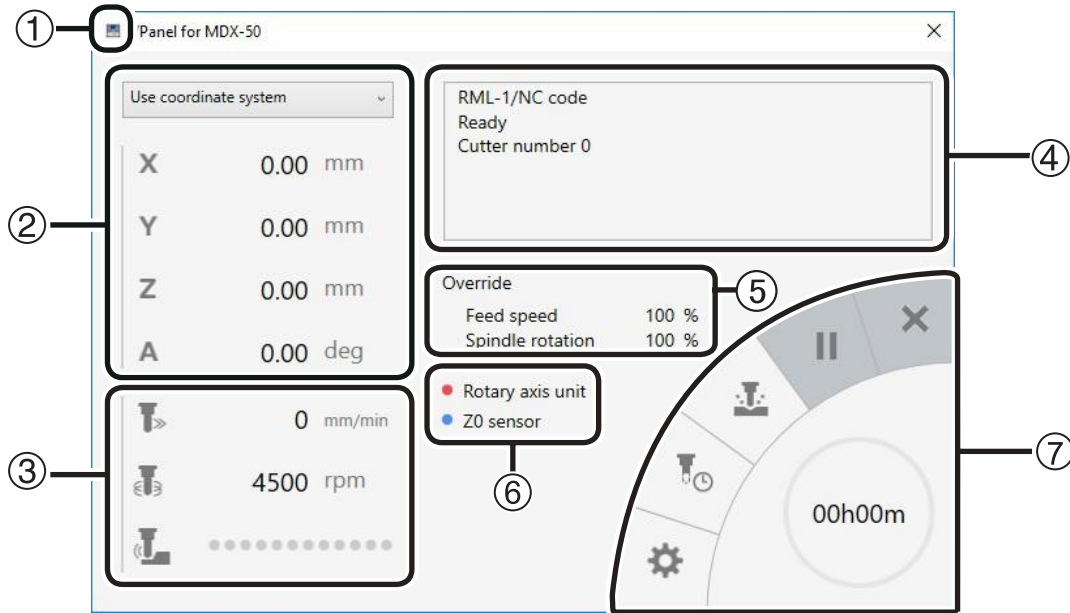

Top Window

The top window is used to display the status of the cutting machine, to set operations, and to manage jobs. Use the machine's built-in panel for operations that are directly connected to the running of the machine such as moving tool burs and adjusting override values.

☞ P. 4 "What Is the Built-in Panel?"



No.	Item	Details
①		Performs window operations and displays the version.
②	Coordinate system	Select the coordinate system to display for [X], [Y], and [Z]. > RML-1: "Machine coordinate system" or "User coordinate system" > NC: "Machine coordinate system," "EXOFS," or "G54" to "G59"
	X Y Z	This displays the current position (coordinate value) of each axis. The display unit can be changed. > Display digits: 0.01 [mm] ☞ P. 51 "Unit"
	A	This displays the current position (rotation angle) of the rotary axis. This is only enabled when the (optional) rotary axis unit is attached. > Display digits: 0.01 [deg]
③		This displays the current feeding speed. > Unit: [mm/min]
		This displays the currently set spindle rotating speed. Use the machine's panel to start and stop rotation and to adjust the rotating speed.
		The current cutting load is displayed as a bar graph. As the load increases, the bars become larger and the color shifts from blue to yellow and from yellow to red.
④	Status	This displays the current operation status of the machine. The displayed details change depending on CAM. > Items: Command set, operation status, tool bur number, cutting time, error
⑤	Override	This displays the override setting values. Use the built-in panel to change the settings.

No.	Item	Details
⑥	Rotary axis unit	This displays the connection and automatic correction statuses of the rotary axis unit. The color changes to gray (the base color) when the unit is not connected, to red when the unit is connected, and to blue when automatic correction is complete.
	Z0 sensor	This displays the connection status of the Z0 sensor. The color changes to gray (the base color) when the sensor is not connected and to green when the sensor is connected.
⑦		Configures the operation settings of the cutting machine. The "Settings" dialog box appears. When the machine is offline, you can only select the [Environment], [Maintenance], and [Notification] tabs on the "Settings" dialog box. ☞ P. 47 "Settings" Dialog Box"
		Manages tool burs. The "Cutter management" dialog box appears. ☞ P. 63 "Cutter management" Dialog Box"
		Outputs the cutting job. The "Cut" dialog box appears. ☞ P. 66 "Cut" Dialog Box"
		Pauses cutting. Click this when cutting is paused to resume cutting.
		Cutting will be canceled.
		The blue part of the circle graph indicates the cutting progress. The remaining cutting time is shown inside the circle.

3. Cutting (One Side Cutting)

Performing an Emergency Stop on This Machine...	12
Emergency Stop	12
Emergency Stop or Pause Due to Opening or Closing the Cover ..	13
Emergency Stop Due to Opening or Closing the Cover	13
Pause Due to Opening or Closing the Cover.....	14
Machine Statuses Indicated by Status Light Color..	15
What Is the Status Light?.....	15
1. Checking the Cutting Area.....	16
Cuttable Workpiece (Cutting Material) Size	16
2. Items Necessary for Cutting	17
Cutter	17
Workpiece (Cutting Material)	17
Scrap Board.....	17
3. Cutting	18
Step 1 : Preparing the Tool Bur.....	18
Step 2 : Loading the Tool Bur on the Machine	20
Step 3 : Mounting the Workpiece on the Machine	21
Step 4 : Setting the XY Origin	22
Step 5 : Setting the Z Origin (Using the Z0 Sensor)	24
Step 6 : Outputting Cutting Data	27
Adjusting the Feeding Speed/Spindle Rotating Speed during Cutting..	28

Performing an Emergency Stop on This Machine

Emergency Stop

When you press the emergency stop button, operation stops immediately.

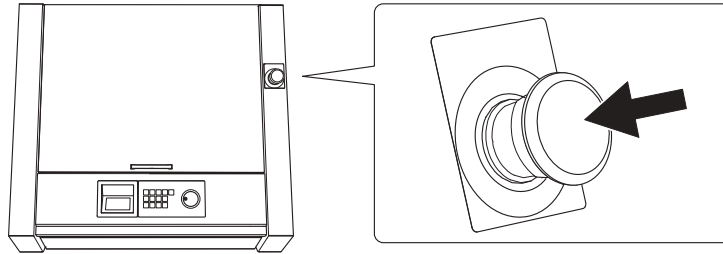

Canceling an Emergency Stop

Procedure

- 1 Switch off the power switch.

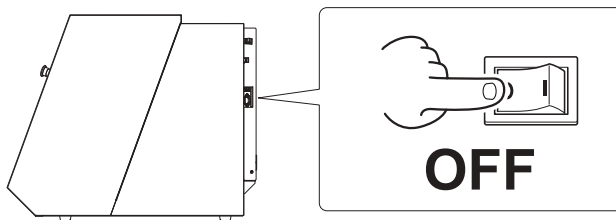

- 2 Turn the button in the direction of the arrows.

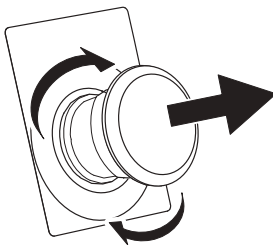

- 3 Switch on the power switch.

Emergency Stop or Pause Due to Opening or Closing the Cover

Emergency Stop Due to Opening or Closing the Cover

To ensure safety, opening the front cover or the dust box cover during cutting or spindle rotation causes this machine to perform an emergency stop. Follow the displayed messages to cancel the emergency stop.

Canceling an Emergency Stop

Procedure

- 1 When you close the cover, a message is displayed on the built-in panel.

Example)

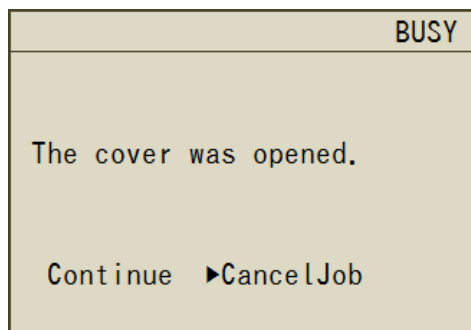

Example)

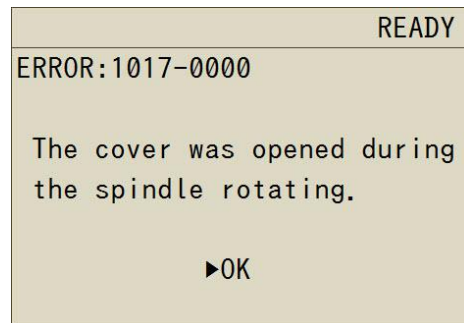

- 2 When a screen is displayed asking you to select either "Continue" or "Abort Cutting," select and then press [ENTER].

The selection screen may not be displayed. In that situation, press [ENTER].

Important

When an emergency stop occurs due to the cover being opened during cutting, selecting "Continue" to continue cutting may affect the cutting results.

If you want to open the cover during cutting

If you want to open the cover during cutting, press [PAUSE/CANCEL] to pause the cutting, wait for the operations to stop, and then open the cover. However, when you have disabled the "Tool up in pause" function in VPanel, the spindle will not pause. Before opening the cover, hold down [SPINDLE] on the built-in panel to stop the spindle.

☞ P.51 ""Machine" Tab"

Pause Due to Opening or Closing the Cover

To ensure safety, opening the front cover or the dust box cover during standby, when operations are paused, or in other situations when the spindle is not rotating will cause the machine to pause its operations and display a message. When you clear the message using the following procedure, the machine will return to the previous screen.

Canceling a Pause

Procedure

- 1** A message is displayed on the built-in panel.

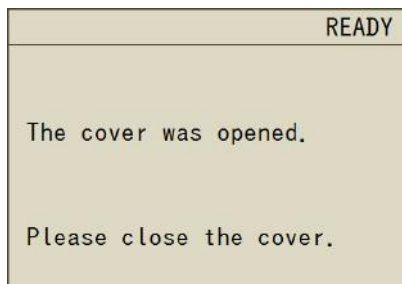

- 2** Close the cover, and then press [ENTER].

The machine returns to the state that it was in prior to the cover being opened. If the machine was performing automatic correction or Z0 sensing, it completes the operation and moves to the view position.

Machine Statuses Indicated by Status Light Color

What Is the Status Light?

Lights are installed inside this machine. The color of the lights changes depending on the status of the machine. You can also turn off the lights during cutting.

☞ P.49 "Turning Off the Status Lights during Cutting"

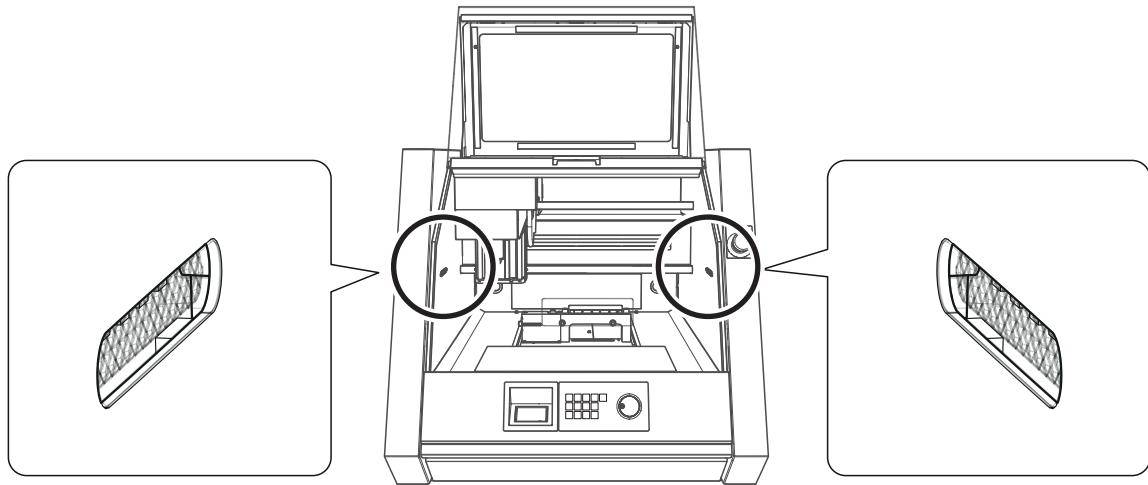

Blue	Lit	The machine is in standby.
	Flashing	Initialization is in progress.
White	Lit	The machine is cutting or a cover has been opened.
	Flashing	Cutting warm up is in progress.
Yellow	Lit	An error for which it is possible to resume cutting occurred. The machine has paused. Check the error details shown on the built-in panel or in VPanel. ☞ P.80 "An Error Message Appears"
Red	Lit	An error for which it is not possible to resume cutting occurred. Cutting will stop. Check the error details shown on the built-in panel or in VPanel. ☞ P.80 "An Error Message Appears"
	Flashing	An error for which it is not possible to resume cutting occurred. Cutting will stop. Turn off the power, and then restart the machine.
Off	The status lights are off.	

1. Checking the Cutting Area

Cutable Workpiece (Cutting Material) Size

XY Directions

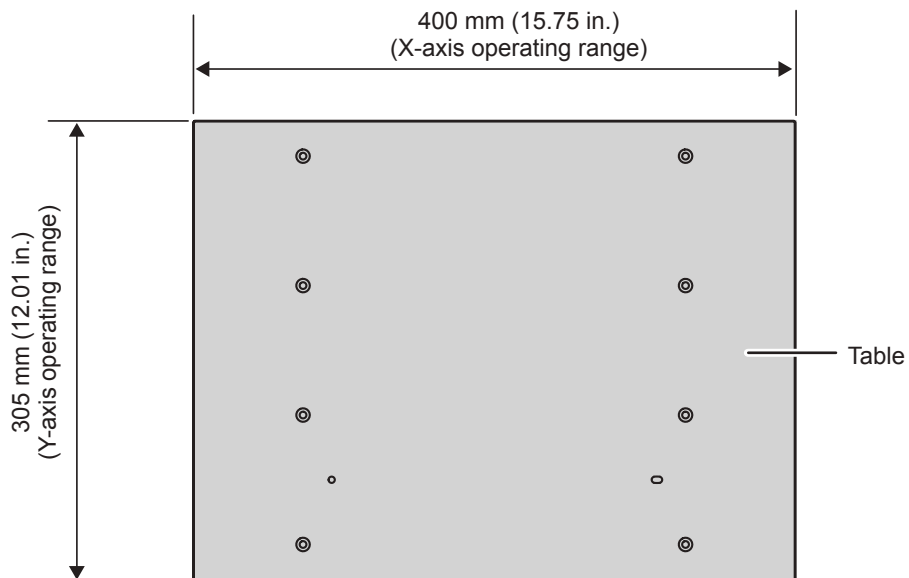

Z Direction

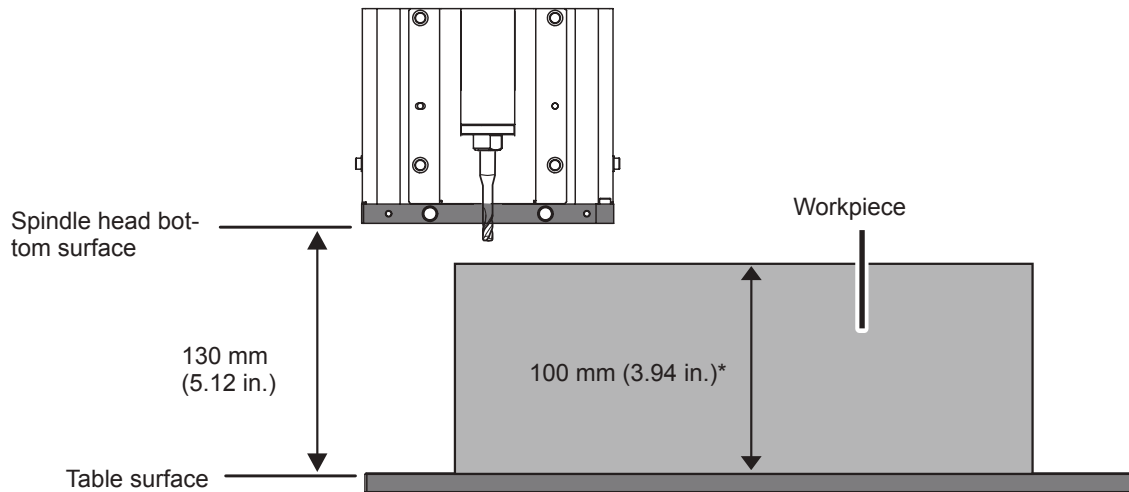

- * Note that a distance exceeding 100 mm (3.94 in.) may lead to interference with the tool bur.
- * When using a scrap board, ensure that the distance from the table (including the thickness of the scrap board) is 100 mm (3.94 in.) or less.

☞ P.17 "Scrap Board"

2. Items Necessary for Cutting

Cutter

Select a tool bur matched to the purpose. We recommend that you use the tool burs selectively to match different work processes (such as roughing and finishing). Contact your authorized Roland DG Corp. dealer or visit the Roland DG Corp. website (<http://www.rolanddg.com/>) to purchase tool burs.

Loadable Tool Bur Conditions

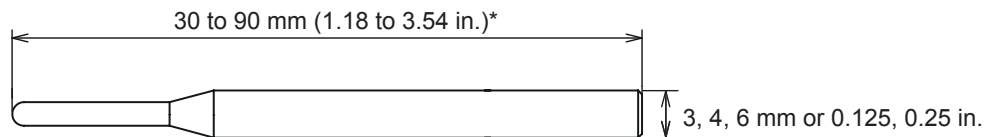

☞ P.18 "Step 1 : Preparing the Tool Bur"

* 30 to 80 mm (1.18 to 3.15 in.) when using a rotary axis (optional)

Workpiece (Cutting Material)

There is a wide variety of workpieces. Use workpieces selectively according to the object to create.

* Never use this machine to cut metal.

Scrap Board

A scrap board is a board that is placed under the workpiece when cutting it so that the table is not cut. It is used as a temporary, subsidiary material in situations such as when cutting out the workpiece and when drilling holes for positioning when cutting.

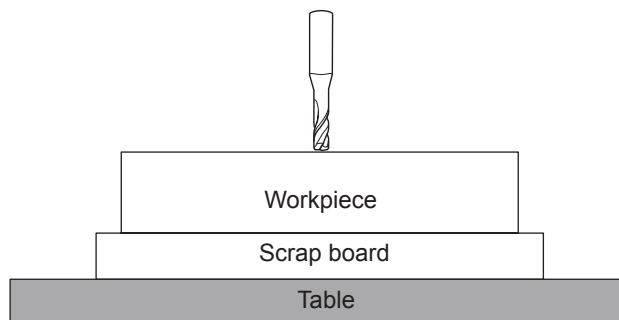



3. Cutting

⚠️ WARNING Do not inadvertently touch the computer or the built-in panel while performing this task.
Unintended operation of the machine may lead to you being caught in the machine.

Step 1 : Preparing the Tool Bar

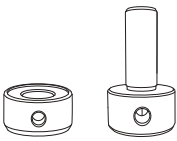
Required Items

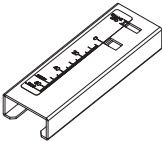
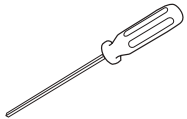
				
Tool bur	Tool holder *	Mounting screw	Tool positioner	Hexagonal screwdriver

* For attachable tool, refer to the " Setup Guide"

The tool holder to use differs depending on the shank diameter of the tool bur.



Shank diameter

- mm specifications : 6 mm
- inch specifications : 0.25 in.

Shank diameter

- mm specifications : 3, 4 mm
- inch specifications : 0.125 in.

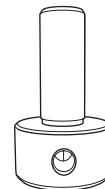
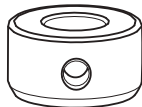

Procedure

1 Load the tool holder in the tool positioner.

Place the tool positioner by aligning the holes as shown in the following figure.

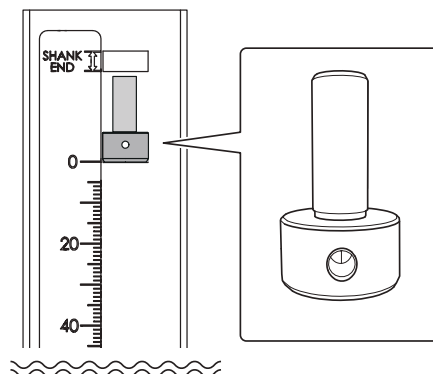
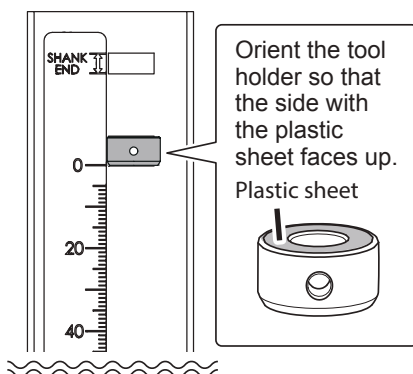

2 Load the tool bur.

CAUTION

If you load a tool bur with a length that is longer than that which can be used by this machine, an error will occur.

When using the included table

- ① Pass the tool bur through the tool holder with the orientation shown in the following figure and ensure that the shank part is within the range indicated with "SHANK END."
- ② Load the tool bur such that it does not extend past the "TABLE" line.

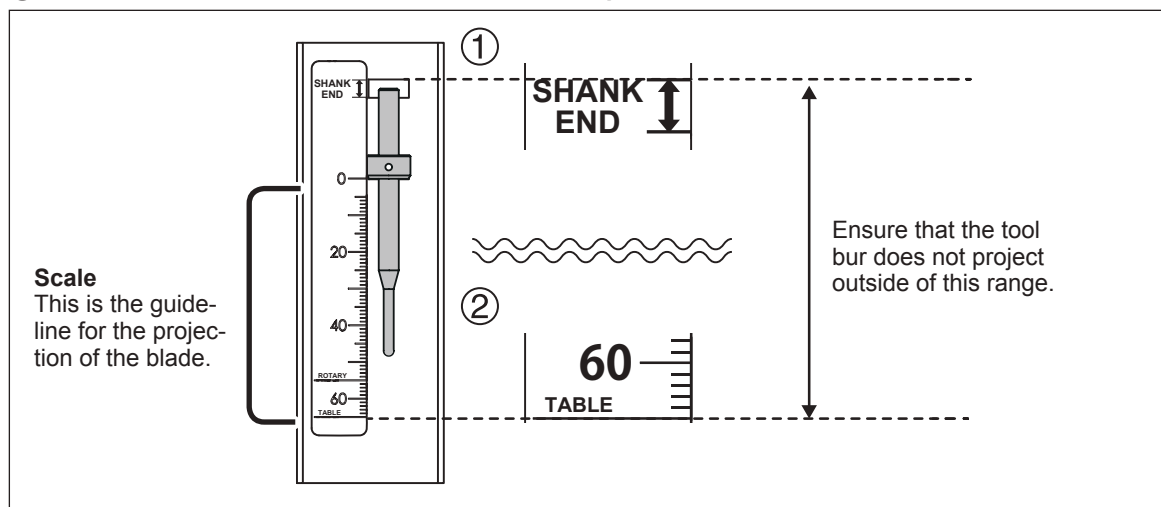

When a rotary axis (option) has been installed

- ① Pass the tool bur through the tool holder with the orientation shown in the following figure and ensure that the shank part is within the range indicated with "SHANK END."
- ② Load the tool bur such that it does not extend past the "ROTARY" line.

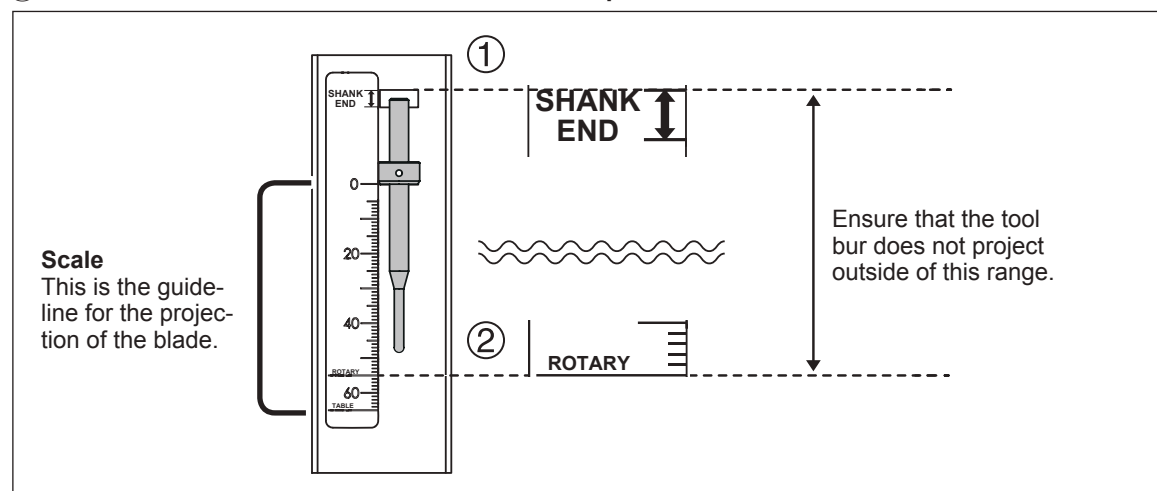

CAUTION

When using the 3 mm, 4 mm (0.12 in., 0.16 in.) tool holder, insert the tool bur 10 mm (0.39 in.) or more from the bottom of the tool holder.

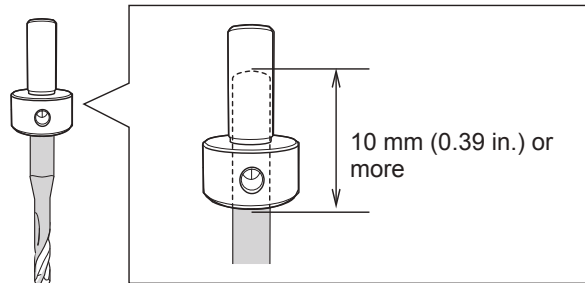

- 3 Use the hexagonal screwdriver to secure the mounting screw.

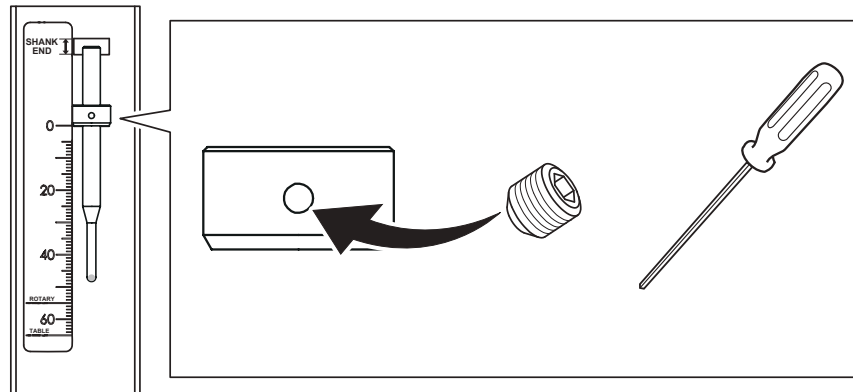

Step 2 : Loading the Tool Bur on the Machine

⚠ WARNING

Securely fasten the cutting tool and workpiece in place. After securing in place, make sure no wrenches or other articles have inadvertently been left behind.

If you do not check for these articles, they may be thrown from the machine with force, posing a risk of injury.

⚠ CAUTION

Be careful around the cutting tool.

The cutting tool is sharp. Broken cutting tools are also dangerous. To avoid injury, exercise caution.

Procedure

- 1 Perform movement to the view position.

Move the table to the front to make this work easier.

☞ P.42 "Quickly Moving to a Specific Position"

- 2 Open the front cover.

- 3 Check that there is no cutting waste or other debris in the stoker, and then load the tool bur. Firmly insert the tool bur as far as possible. Up to 6 tool burs can be loaded.

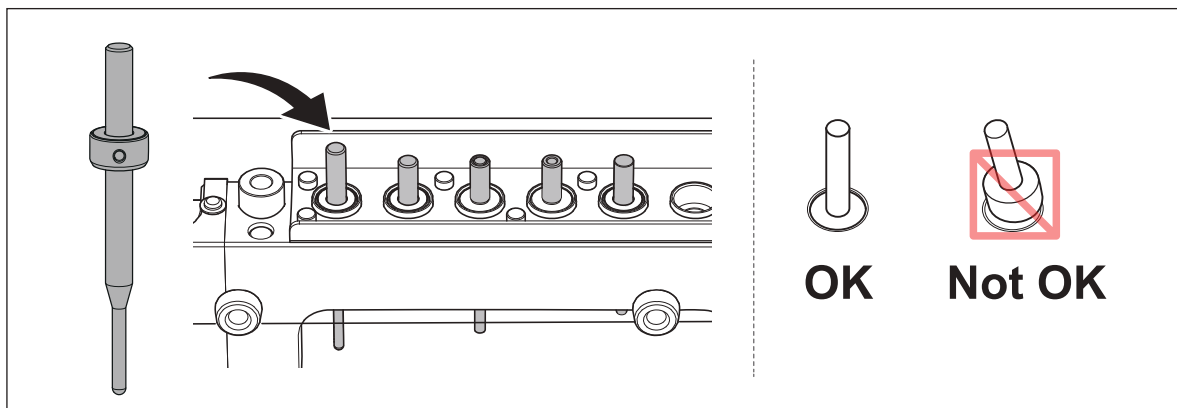

MEMO

If you register the tool bur information in VPanel, you can record the work time of the actually used tool burs and check the estimated replacement periods.

☞ P.65 "Registering Tool Bur Information"

Step 3 : Mounting the Workpiece on the Machine

Procedure

- 1 Affix double-stick tape to the workpiece.
If necessary, affix a scrap board to the workpiece, and then mount it on the machine.
- 2 Mount the workpiece on the table.

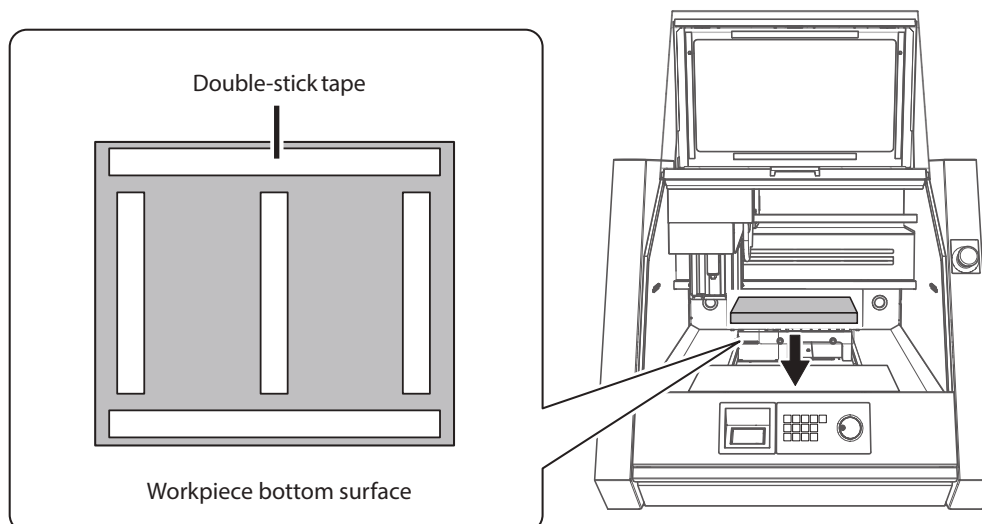

- 3 Close the front cover.
- 4 Press [ENTER].

Step 4 : Setting the XY Origin

Origin

The origin is the starting point of the coordinates. It is the position where the X, Y, and Z coordinates are all "0." You can freely set the origin position. It is a good idea to match the origin with the position where you want to start cutting. However, you cannot set the origin when you select "Machine coordinate system" for the coordinate system.

User Coordinate System and Machine Coordinate System

The coordinate system in which the origin position can be freely changed is known as the "user coordinate system." On the other hand, the coordinate system in which the origin position is fixed and cannot be changed is known as the "machine coordinate system." Basically, the user coordinate system is the one that is used during actual work. When you want to know the absolute position of the tool bur, use the machine coordinate system. With this machine, coordinates can be displayed with both the user coordinate system and the machine coordinate system.

- Machine coordinate system origins of this machine
 - X, Y: Front-left part of the table, Z: Uppermost position of the spindle

Procedure

- 1 **Select and retain the tool bur.**
 - ① Press [MENU] several times to select "ATC Tool Bur."
 - ② Turn the hand-wheel to select the tool bur to retain.
 - ③ Press [ENTER].

The machine operates, and the tool bur is retained. Press [MENU] several times to return to the top window.

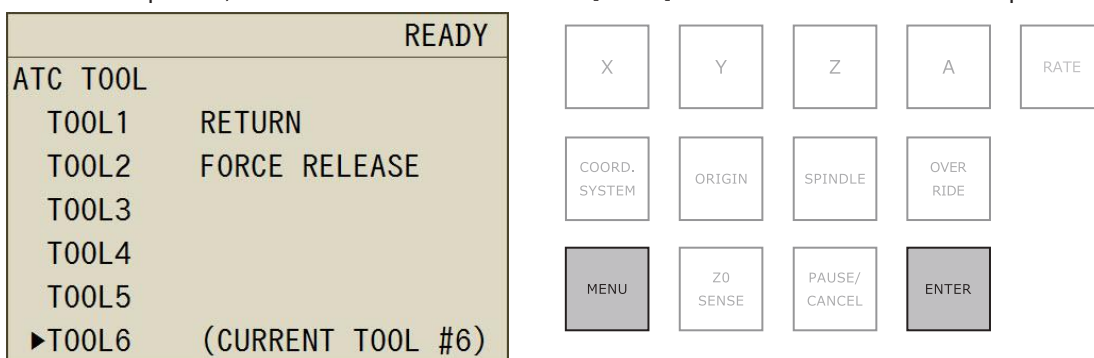

- 2 **Move the tool bur to the position where you want to set the origin.**
 - ☞ P.41 "Using Hand-wheel Operations to Move the Tool Bur (Hand-wheel Feed)"
- 3 **Press [COORD. SYSTEM] several times to select the coordinate system.**

When using SRP PLAYER, which is included with this machine: Select "User coordinate system." Check the coordinate system on the screen of the built-in panel.

CAUTION

- If you select "Machine coordinate system," you will not be able to set the origins.
- If you are using an application that uses NC codes, switch the command set from "RML-1" to "NC code."

☞ P.58 ""NC code setting" Dialog Box"

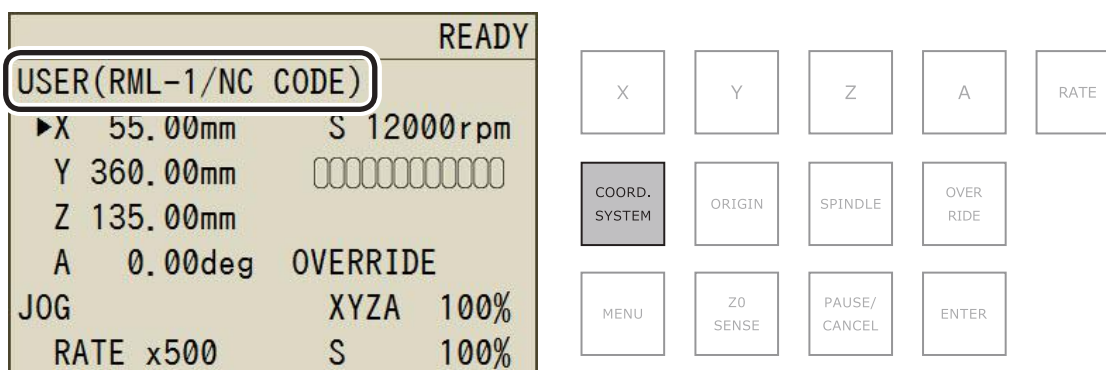

4 Press the button corresponding to the axis whose origin you want to set.

Check that ▶ is displayed next to the axis whose origin you want to set.

* A can only be used when the (optional) rotary axis unit is attached.

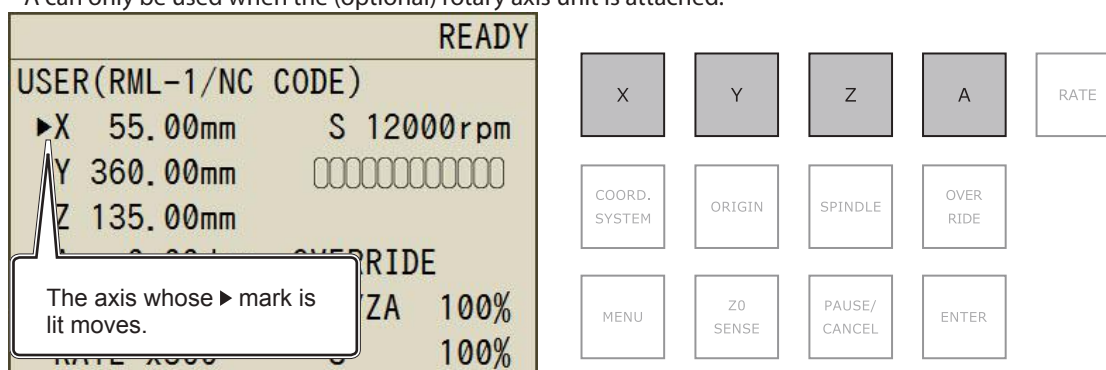

5 Hold down [ORIGIN].

This sets the origin. When the origin is set, its coordinate value becomes "0."

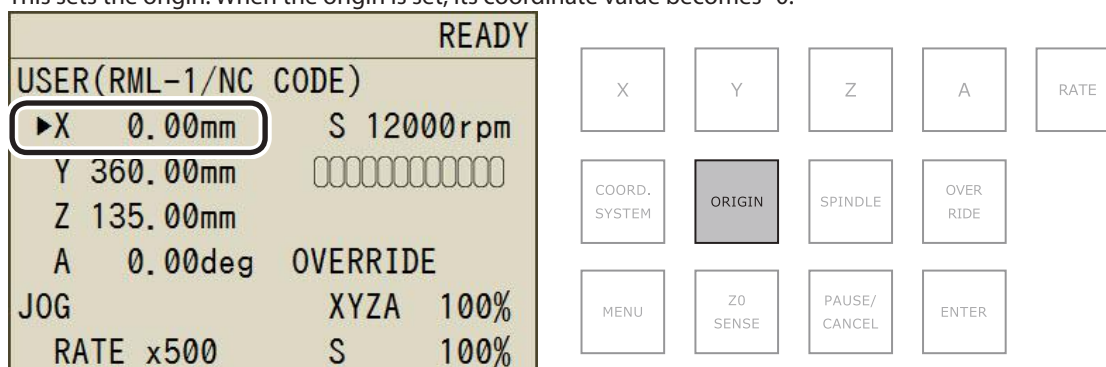

Coordinate Systems in RML-1 Mode



- USER: User coordinate system

Coordinate Systems in NC Code Mode

- G54: Workpiece coordinate system 1
- G55: Workpiece coordinate system 2
- G56: Workpiece coordinate system 3
- G57: Workpiece coordinate system 4
- G58: Workpiece coordinate system 5
- G59: Workpiece coordinate system 6
- EXOFS

Step 5 : Setting the Z Origin (Using the Z0 Sensor)

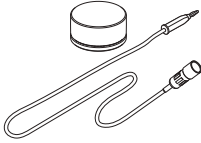
This function is useful when you want to set the Z origin on the upper surface of the workpiece.

 <p>Z0 sensor</p>	 <p>Detection pin</p>	<p>MEMO</p> <p>You can use not only the detection pin but also the tool bur to set the Z origin with the Z0 sensor. However, using a thin tool bur may lead to it being damaged. Also note that you cannot use the Z0 sensor with tool burs made of a coated non-conductive material. This section explains how to perform detections using a detection pin.</p>
--	--	---

1. Load the detection pin.

1 If the Z0 sensor, detection pin, or workpiece is dirty with cutting waste or similar debris, clean it. If any of these are dirty, it will not be possible to perform correct measurements, which may make it impossible to perform cutting as intended.

2 Load the detection pin in the number 6 stocker.

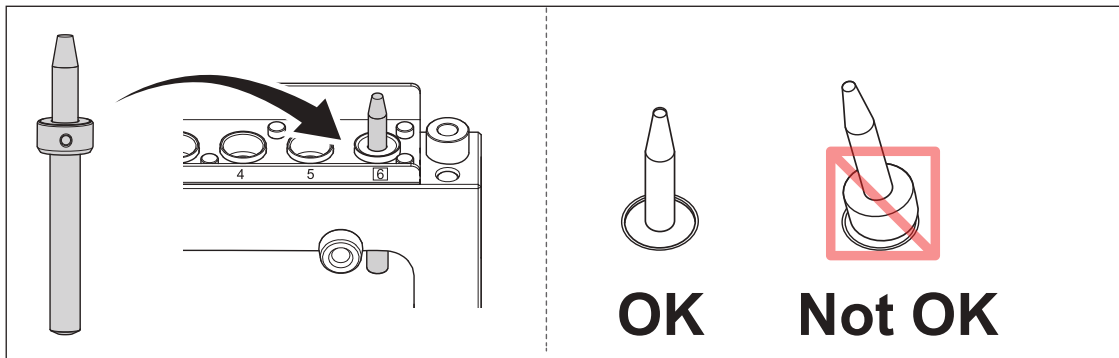

2. Load the Z0 sensor.

1 Connect the Z0 sensor cable.

1 Remove the protective "Z0 SENSOR/ROTARY" cap.

2 Connect the Z0 sensor cable.

Orient the cable so that its arrow mark is as shown in the following figure, and then insert the cable until you hear it click.

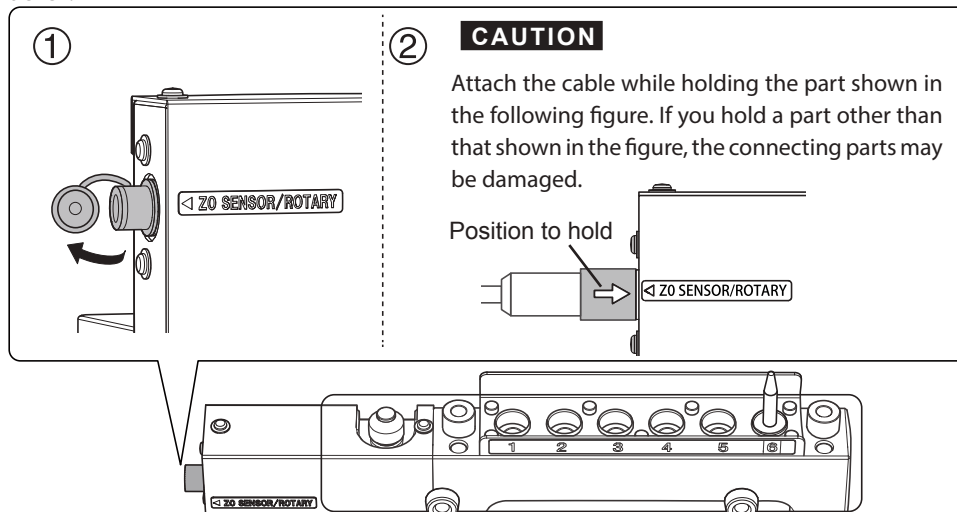

2 Place the Z0 sensor in the position where you want to set the Z origin.

Orient the Z0 sensor so that its side without screw threads faces upward.

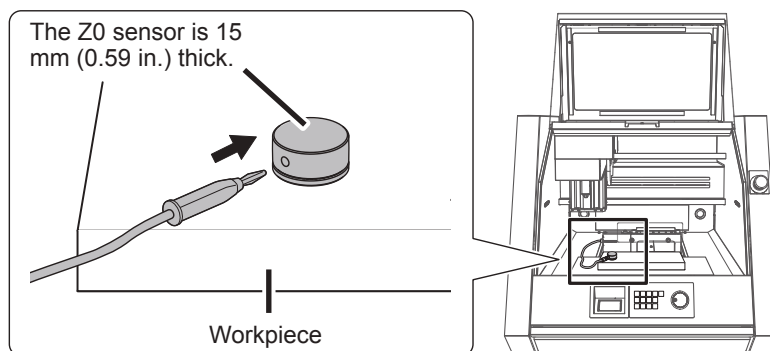

3 Close the front cover.

4 Press [ENTER].

3. Set the Z0 origin.

1 Select and retain the detection pin.

① Press [MENU] several times to select "ATC Tool Bur."

② Turn the hand-wheel to select "Tool Bur 6."

③ Press [ENTER].

The machine operates, and the detection pin is retained. Press [MENU] several times to return to the top window.

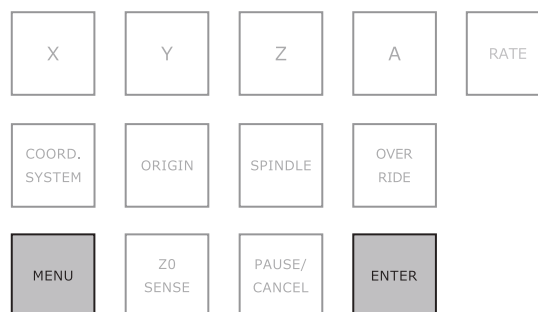
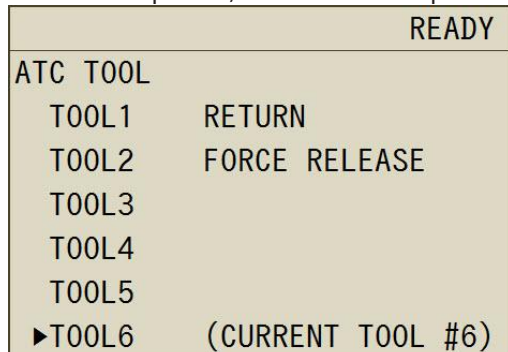

2 Move the detection pin above the Z0 sensor.

☞ P.41 "Using Hand-wheel Operations to Move the Tool Bur (Hand-wheel Feed)"

3 Press [COORD. SYSTEM] several times to select the coordinate system.

If you select [MACHINE], you will not be able to set the origins.

4 Press [Z0 SENSE].

The screen shown in the following figure is displayed.

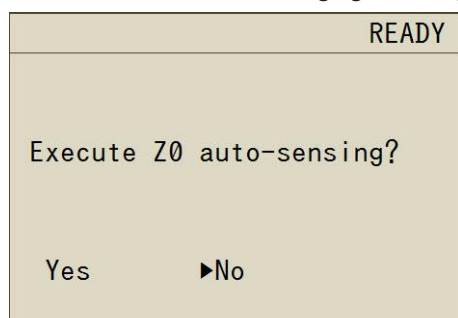

MEMO

The screen shown in the figure on the left is not displayed when:

- The tool bur is not retained.
- The spindle is rotating.

5 Turn the hand-wheel to select "Yes."

6 Press [ENTER].

The tool bur slowly descends to touch the sensor. The tool bur then ascends. When it stops moving, the setting is complete.

Canceling the detection operation

If you want to stop the tool bur while it is descending, press [ENTER].

4. Remove the Z0 sensor and the detection pin.

1 Return the detection pin.

① Press [MENU] several times to select "ATC Tool Bur."

② Turn the hand-wheel to select "Return Tool Bur."

③ Press [ENTER].

The machine operates, and the detection pin is returned. Press [MENU] several times to return to the top window.

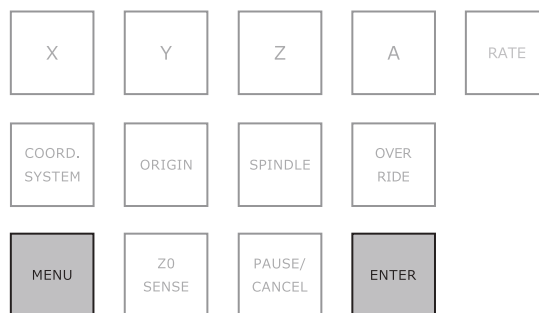
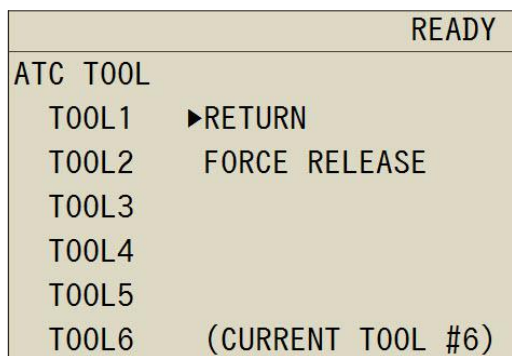

2 Remove the Z0 sensor.

① Open the front cover.

② Remove the Z0 sensor.

③ Attach the protective "Z0 SENSOR/ROTARY" cap.

CAUTION

Remove the cable while holding the part shown in the following figure. If you hold a part other than that shown in the figure, the connecting parts may be damaged.

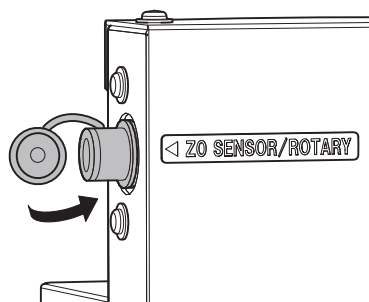
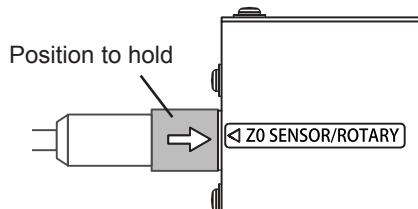

3 Close the front cover.

4 Press [ENTER].

Coordinate System in RML-1 Mode

➤ USER: User coordinate system

Coordinate Systems in NC Code Mode

➤ G54: Workpiece coordinate system 1 ➤ G57: Workpiece coordinate system 4 ➤ EXOFS
 ➤ G55: Workpiece coordinate system 2 ➤ G58: Workpiece coordinate system 5
 ➤ G56: Workpiece coordinate system 3 ➤ G59: Workpiece coordinate system 6

Step 6 : Outputting Cutting Data

Important

Before starting cutting, check the points listed below. If there are problems with any of these, the machine may operate unexpectedly, which may waste the workpiece or damage the machine.

- Is the output file correct?
- Is the origin location correct?
- Do the cutting conditions match the type of workpiece?
- Cutting waste and workpieces are flammable.
- Never attempt to cut magnesium or any other such flammable material.

Procedure

① Check that the front cover and dust box cover are closed.

② Click .

The VPanel "Cut" dialog box appears.

③ Output the cutting data.

① Click [Add] to add an output file.

② Click [Output].

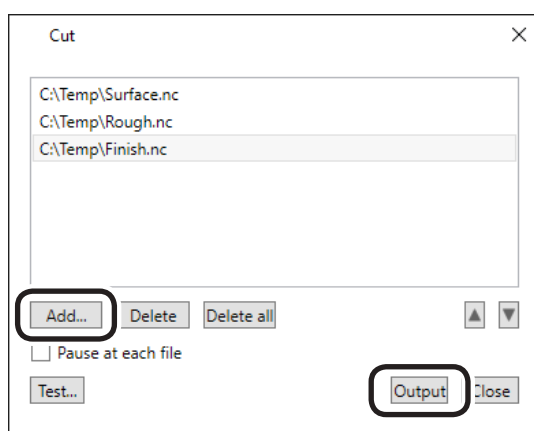

The cutting starts.

MEMO

You can click [Test] to execute the program one line at a time. (Only when the output file is in NC code)

☞ P.66 ""Cut" Dialog Box"

When the sending of the cutting data is complete, you can disconnect this machine from the PC.

The machine can temporarily save in its internal memory the cutting data sent from the PC. Therefore, when the sending of the cutting data is complete, you can use the PC with the USB cable disconnected.

CAUTION

Do not disconnect the machine and the PC when  is displayed on the built-in panel.

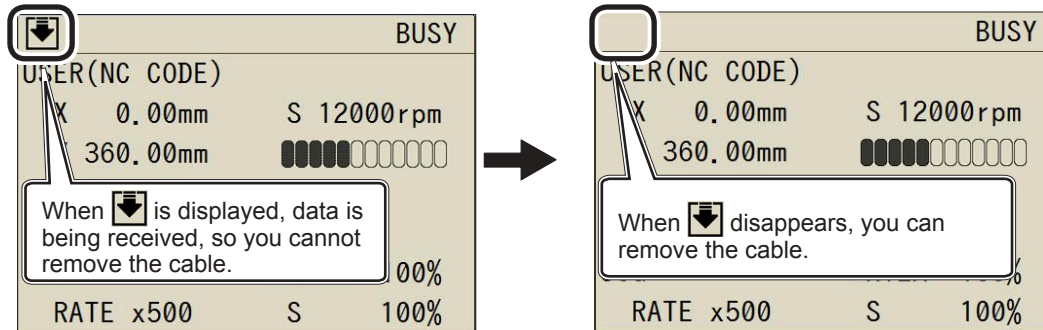

Adjusting the Feeding Speed/Spindle Rotating Speed during Cutting

You can use the built-in panel to adjust the feeding speed and the number of rotations of the spindle during cutting.

Built-in panel

☞ P.46 "How to Set Overrides"

4. Maintenance

- Maintenance Precautions 30
 - Maintenance Precautions 30
- Daily Maintenance 31
 - Cleaning after Cutting Finishes..... 31
- Periodic Maintenance 33
 - Situations Requiring Maintenance 33
 - Replacing Consumable Parts 33
 - Spindle Run-in (Warm-up) 34
 - Correcting the Cutting Machine (Automatic Correction) 35
 - Retightening the Collet 37

Maintenance Precautions

Maintenance Precautions

- ⚠️ WARNING** **Never use a pneumatic blower.**
This machine is not compatible with pneumatic blowers. Cutting waste may get inside the machine and cause fire or electrical shock.
- ⚠️ WARNING** **Never use a solvent such as gasoline, alcohol, or thinner to perform cleaning.**
Doing so may cause fire.
- ⚠️ WARNING** **Be sure to perform operations as specified by the instructions, and never touch any area not specified in the instructions.**
Sudden movement of the machine may cause injury or burns.
- ⚠️ WARNING** **When using a dust collector to take up cutting waste, exercise caution to prevent fire and explosions of dust.**
Taking up fine cuttings using an ordinary dust collector may result in fire or explosion. Check with the manufacturer of the dust collector. When the safety of use cannot be determined, clean the machine using a brush or the like, without using a dust collector.
- ⚠️ WARNING** **Caution: High Temperature. Do not touch the spindle unit or the surrounding areas immediately after cutting has ended.**
Doing so may result in burns.
- ⚠️ CAUTION** **Be sure to remove the cutting tool before performing maintenance.**
Contact with the blade may result in injury.
- This machine is a precision device. Carry out daily care and maintenance.
 - Carefully clean away cutting waste. Operating the machine with cutting waste present may cause a malfunction.
 - Never use silicone substances (oil, grease, sprays, etc.). Doing so may cause poor switch contact.

Daily Maintenance

Cleaning after Cutting Finishes

After cutting finishes, clean the inside of the machine using a commercially available brush or dust collector. Also clean the tool bur.

- ⚠ WARNING** Do not inadvertently touch the computer or the operating panel while performing this task.
Unintended operation of the machine may lead to you being caught in the machine.

1. Clean the inside of the machine.

- 1 Remove the workpiece that has been cut and return the tool bur to the ATC magazine.**
If the material cannot be peeled off cleanly, use a tool such as a spatula to remove it.
- 2 Move the spindle and the table to the cleaning position.**
☞ P. 42 "Quickly Moving to a Specific Position"
- 3 Clean the inside of the machine.**
Brush off the cutting waste that has fallen on the X- and Z-axes and around the table using a commercially available brush.

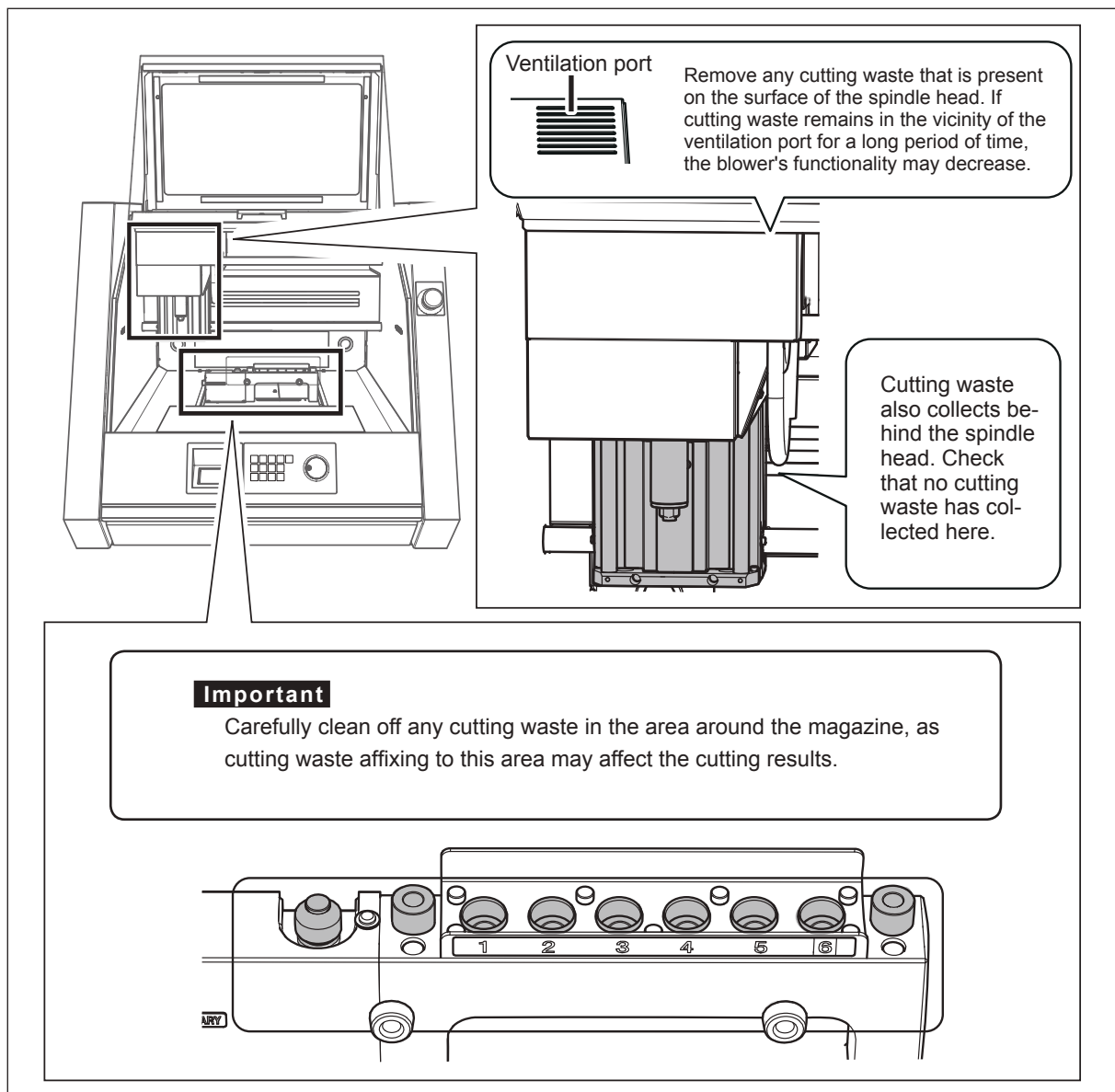

- 4** Discard the cutting waste that has gathered in the dust box.
Open the dust box cover, and then pull out the dust box.

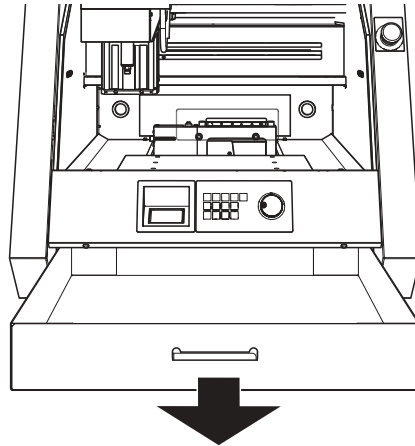

2. Clean the tool bur.

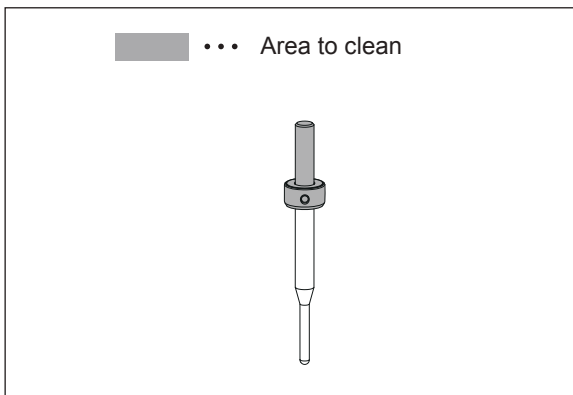

Use the included cloth for care to wipe off any dirt from the portion indicated in the figure.

Periodic Maintenance

Situations Requiring Maintenance

When installing the machine	→	<ul style="list-style-type: none"> ☞ P. 34 "Spindle Run-in (Warm-up)" ☞ P. 35 "Correcting the Cutting Machine (Automatic Correction)"
When replacing the spindle unit		
When the machine has not been used for a prolonged period	→	☞ P. 34 "Spindle Run-in (Warm-up)"
Before cutting on days when the ambient temperature is low		
When moving the machine to a different installation site	→	☞ P. 35 "Correcting the Cutting Machine (Automatic Correction)"
When ATC tool burs cannot be held		
Once a month	→	☞ P. 37 "Retightening the Collet"
When the working time of the spindle exceeds 200 hours		

Replacing Consumable Parts

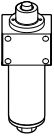
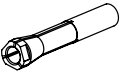
Part name	Replacement time/Guideline
 <p>Spindle unit</p>	<p>When the working time of the spindle exceeds 2,000 hours (with slight variation depending on the work situation).</p> <p>You can use VPanel to view the working time of the spindle.</p> <p>☞ P. 55 ""Maintenance" Tab"</p> <p>* The replacement spindle unit comes with a collet and belt.</p>
 <p>Collet</p>	<p>If the collet is deformed.</p> <p>If an overload error or other error occurs, the collet may be deformed.</p>

Spindle Run-in (Warm-up)

Spindle run-in (warm-up) may be required to stabilize the rotation of the spindle.

Situations Requiring This Work

- When installing the machine
- When replacing the spindle unit
- When the machine has not been used for a prolonged period
- Before use on days when the ambient temperature is low

Procedure

- 1 Close the front cover and the dust box cover.
- 2 Switch on the power.
- 3 Display VPanel.
☞ P. 7 "Displaying VPanel"
- 4 Click , the [Maintenance] tab, and then click [Spindle...].
The VPanel "Spindle maintenance" dialog box appears.

- 5 Click [Start] next to "Run-in."

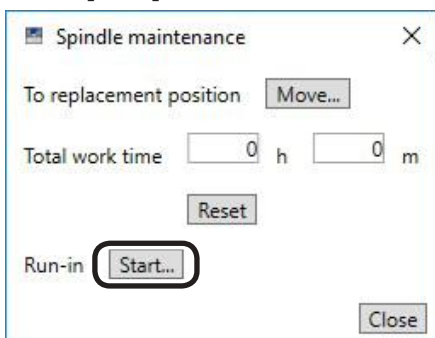

- 6 When the window shown in the following figure appears, click [OK].

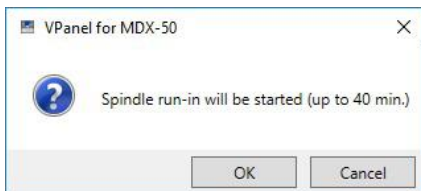

Run-in will begin. (It takes approximately 40 minutes.)

- 7 When the window shown in the following figure appears, click [OK].



Correcting the Cutting Machine (Automatic Correction)

The accuracy of the cutting machine may change if it is used for a long period of time or the surrounding environment changes. Performing automatic correction will correct the ATC magazine and rotary axis positions.

Situations Requiring This Work

- When installing the machine
- When replacing the spindle unit
- When the cutting position is misaligned (when an optional rotary axis is connected)
- When a failure occurs during tool bur acquisition or returning

Required Items

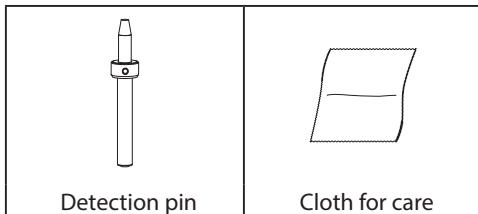

1. Install the detection pin.

- 1 Clean off any cutting waste around the ATC magazine.

☞ P. 31 "Cleaning after Cutting Finishes"

- 2 Use the included cloth for care to wipe clean the detection pin and the protrusions on the left and right of the ATC magazine.

If any dirt is present in these locations, it may not be possible to perform the correction properly.

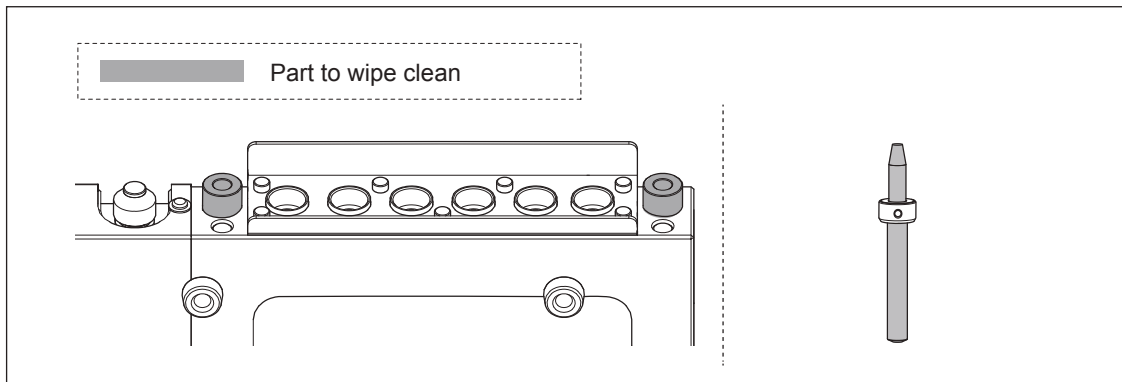

- 3 Load the detection pin in the ATC magazine's number 6 position.

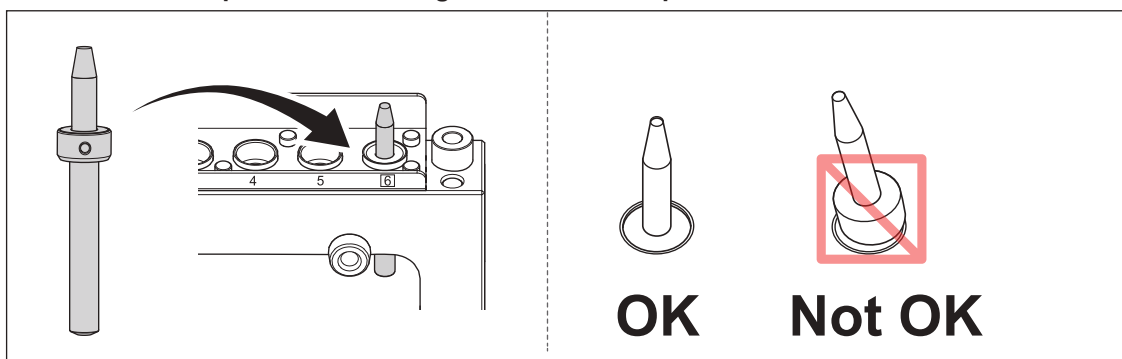

- 4 Close the front cover.
- 5 Press [ENTER].

2. Perform automatic correction.

1 Display VPanel.

☞ P. 7 "Displaying VPanel"

- 2 Click , the [Correction] tab, and then click [Automatic correction].
The VPanel "Automatic correction" dialog box appears.

- 3 Select the [Magazine] check box, and then click [Start Correction].
You can use the [Rotary axis unit] check box when you are using the optional rotary axis unit.

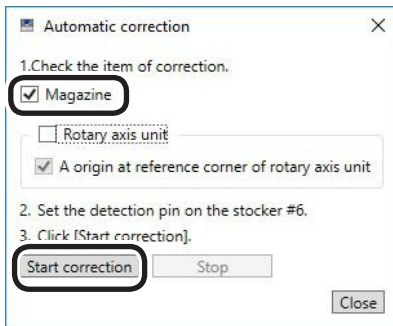

Automatic correction starts.

- 4 When the window shown in the following figure appears, click [OK].

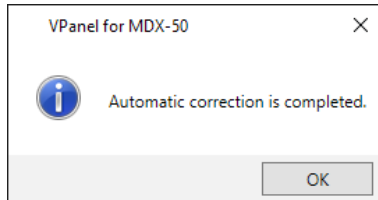

- 5 Once automatic correction is complete, return the detection pin to the ATC magazine.

Retightening the Collet

Continuous cutting will cause the collet to become loose, making it easy for the tool bur to come off. Periodically retighten the collet.

Recommended Interval for This Work

- **Once a month, or when the working time of the spindle exceeds 200 hours since the previous retightening (with slight variation depending on the work situation).**

☞ P. 60 "Spindle maintenance" Dialog Box"

Required Items

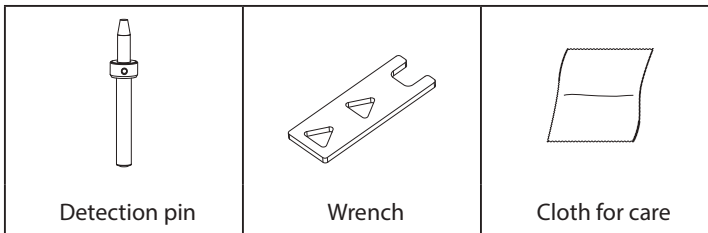

1. Open the collet.

- 1 Remove the workpiece and return the tool bur to the ATC magazine.**

☞ P. 45 "Operation of the Tool Bur Replacement Function (Auto Tool Changer)"

- 2 Clean off any cutting waste around the spindle.**

☞ P. 31 "Cleaning after Cutting Finishes"

- 3 Display VPanel.**

☞ P. 7 "Displaying VPanel"

- 4 Click  and then the [Maintenance] tab.**

The VPanel "Maintenance" tab appears.

- 5 Click [Open collet].**

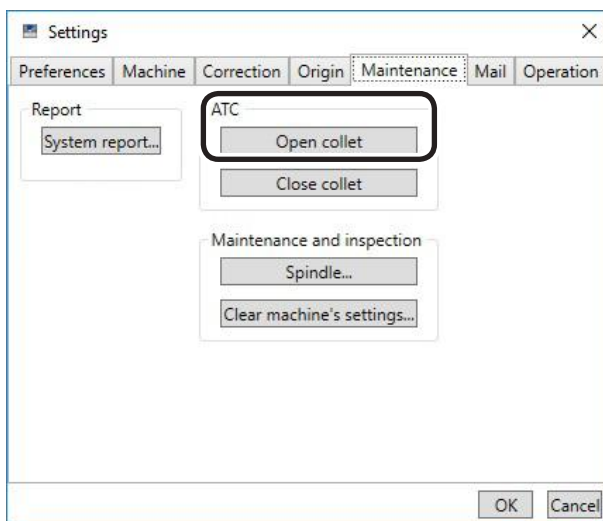

- 6 Check that the work displayed on the screen is complete, and then click [OK].
The spindle unit will move, which will open the collet.

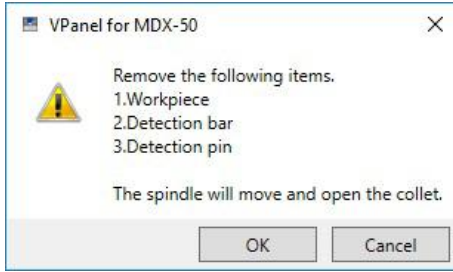

- 7 When the window shown in the figure appears, click [OK].

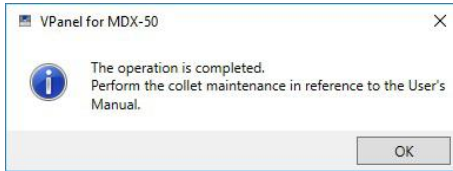

2. Retighten the collet.

- 1 Tighten the collet.
- ① Fit the wrench onto the collet.
Use the center triangular hole.
 - ② Insert the detection pin into the collet.
If the detection pin cannot be inserted, repeat the operations in steps ④ to ⑦ under "1. Open the collet."
 - ③ Turn the wrench in the direction indicated in the following figure.

Point

Tightening is sufficient once the wrench and the tip of the spindle unit begin to rotate together.

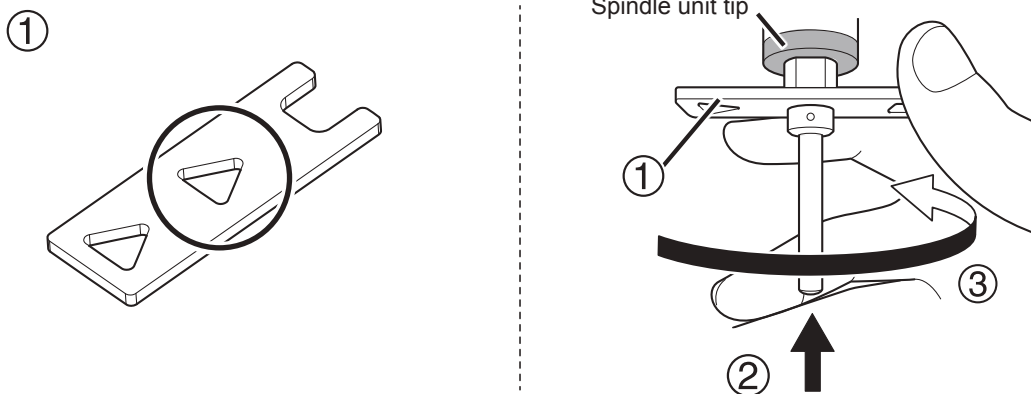

CAUTION

Use the included wrench and keep the detection pin inserted. If the detection pin is not inserted, the collet may be deformed, resulting in lower cutting accuracy.

- ② Remove the detection pin and the wrench.
- ③ Close the front cover.
- ④ Press [ENTER].

3. Close the collet.

- ① Click [Close collet] in VPanel.
- ② When the window shown in the following figure appears, click [OK].

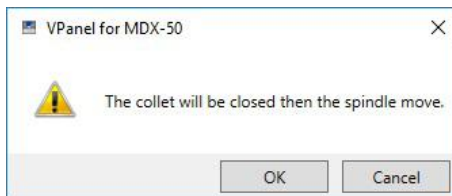

The spindle unit moves and closes the collet.

- ③ When the window shown in the following figure appears, click [OK].

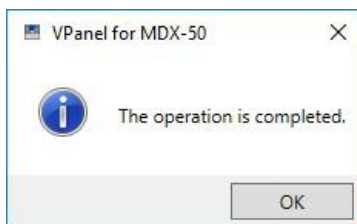

5. Built-in Panel Operation (Practical Use)

Built-in Panel Functions.....	41
Using Hand-wheel Operations to Move the Tool Bur (Hand-wheel Feed) .	41
Quickly Moving to a Specific Position	42
Changing the Coordinate System.....	43
Starting and Stopping Spindle Rotation.....	44
Setting the Origin	44
Setting the Z Origin Using the Z0 Sensor	44
Operation of the Tool Bur Replacement Function (Auto Tool Changer) ..	45
How to Set Overrides.....	46
Checking Job/Tool Bur Information during Cutting	46
Pausing/Resuming/Canceling Cutting	47
Recovering from Errors.....	48
Turning Off the Status Lights during Cutting.....	49
Changing the Blower Strength during Cutting	49

Built-in Panel Functions

Using Hand-wheel Operations to Move the Tool Bur (Hand-wheel Feed)

You can turn the hand-wheel to move the tool bur. Select the axis to move, and then move the axes one at a time. This operation is not possible in the following cases.

- When the front cover or dust box cover is open
- During cutting operation

⚠ WARNING

This procedure makes the machine operate.

Before you perform this procedure, check to make sure that operation of the machine will not create any hazard or danger.

Procedure

- 1 Press [MENU] to display the following screen.
- 2 Press the key corresponding to the axis that you want to move.

* A can only be used when the (optional) rotary axis unit is attached.

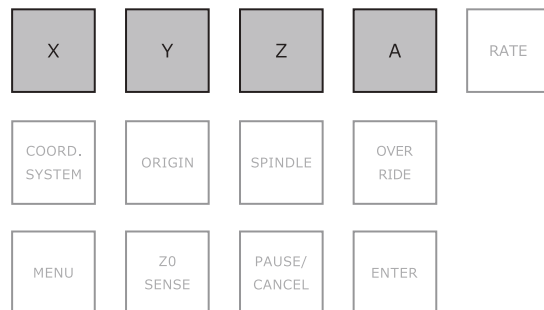
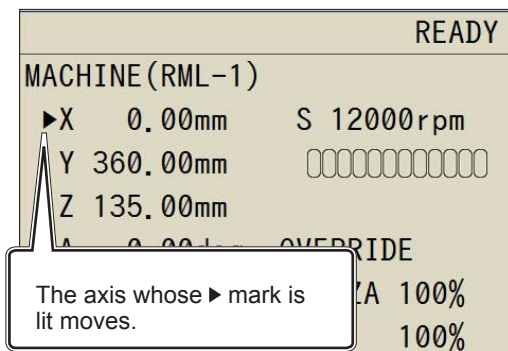

- 3 Turn the hand-wheel.
The selected axis moves.

Changing the Hand-wheel's Movement Steps

You can set the number of steps of movement for each click of the hand wheel. Lower rates produce correspondingly lower amounts of movement, enabling you to perform precise positioning.

Procedure

- 1 Press [RATE].

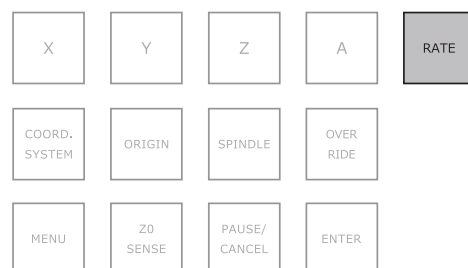
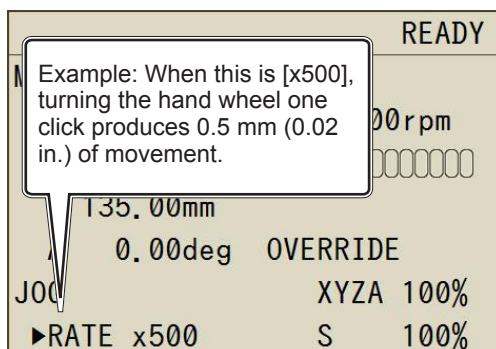

Quickly Moving to a Specific Position

Use this procedure to quickly move to the view position or to the origin. The tool bur is always kept in the highest position along the Z axis and only moves to the specified position along the X and Y axes. You cannot perform this operation during cutting or while cutting is paused.

⚠ WARNING This procedure makes the machine operate. Before you perform this procedure, check to make sure that operation of the machine will not create any hazard or danger.

Procedure

- 1 Press [MENU] several times to display the following screen.
- 2 Use the hand-wheel to select the movement destination.
The display differs depending on the selected command set.

RML mode

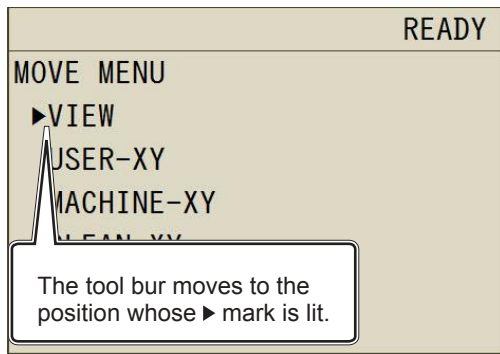

Display	Function
View	The spindle head moves to the left edge and the table moves to the front.
User - XY	Moves the tool bur to the XY origin in the user coordinate system.
Machine Coordinates - XY	Moves the tool bur to the XY origin in the machine coordinate system.
Cleaning - XY	The spindle head moves to the right edge and the table moves to the back.
Rotation A	The rotary axis unit rotates. This can only be used when the (optional) rotary axis unit is attached.

NC mode

READY	
MOVE MENU	
VIEW	G59-XY
►G54-XY	EXOFS-XY
G55-XY	MACHINE-XY
G56-XY	CLEAN-XY
G57-XY	ROTATE-A
G58-XY	

AUTO mode

READY	
MOVE MENU	
VIEW	G59-XY
G54-XY	EXOFS-XY
G55-XY	►MACHINE-XY
G56-XY	CLEAN-XY
G57-XY	ROTATE-A
G58-XY	

Display	Function	Display	Function
View	View position	G59-XY	Workpiece coordinate system origin 6
G54-XY	Workpiece coordinate system origin 1	EXOFS-XY	Position specified by EXOFS
G55-XY	Workpiece coordinate system origin 2	User Coordinates - XY*	User coordinate system origin
G56-XY	Workpiece coordinate system origin 3	Machine Coordinates - XY	Machine coordinate system origin

G57-XY	Workpiece coordinate system origin 4	Cleaning - XY	This function is used for cleaning. The spindle and table move.
G58-XY	Workpiece coordinate system origin 5	Rotation A	The rotary axis unit rotates. This can only be used when the (optional) rotary axis unit is attached.

* In NC mode, "User Coordinates - XY" is not displayed.

3 Press [ENTER].

The operation starts. Press [MENU] several times to return to the top window.

Changing the Coordinate System

☞ P. 22 "User Coordinate System and Machine Coordinate System"

- User coordinate system: You can freely set the origin.
- Machine coordinate system: The origin position is fixed, so you cannot change the origin setting.

Procedure

1 Press [MENU] several times to display the following screen.

2 Press [COORD.SYSTEM] to select the coordinate system.

This displays the current tool bur position. (Unit: mm)

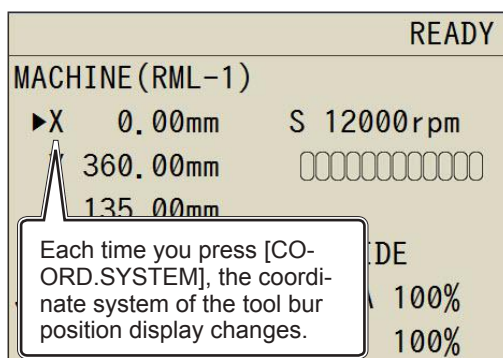

Coordinate Systems in RML-1 Mode

- User Coordinates: User coordinate system
- Machine Coordinates: Machine coordinate system

Coordinate Systems in NC Code Mode

- G54 : Workpiece coordinate system 1
- G55 : Workpiece coordinate system 2
- G56 : Workpiece coordinate system 3
- G57 : Workpiece coordinate system 4
- G58 : Workpiece coordinate system 5
- G59 : Workpiece coordinate system 6
- EXFOS : Coordinate system specified by EXOFS
- Machine Coordinates: Machine coordinate system

Starting and Stopping Spindle Rotation

You can start and stop spindle rotation as well as specify the spindle's rotation speed. You cannot perform this operation during cutting.

⚠ WARNING This procedure makes the machine operate.
Before you perform this procedure, check to make sure that operation of the machine will not create any hazard or danger.

Procedure

1 Press [MENU] several times to display the following screen.

2 Press [SPINDLE].

Tap: Specify the rotation speed.

Hold down (for 1 second): Start or stop the spindle rotation.

3 Turn the hand-wheel.

The spindle rotating speed changes.

When the triangle mark (▶) lights next to "S," operation is possible.

Setting the Origin

- ☞ P. 22 "Step 4 : Setting the XY Origin"
- ☞ P. 24 "Step 5 : Setting the Z Origin (Using the Z0 Sensor)"

Setting the Z Origin Using the Z0 Sensor

- ☞ P. 24 "Step 5 : Setting the Z Origin (Using the Z0 Sensor)"

Operation of the Tool Bur Replacement Function (Auto Tool Changer)

You can use the built-in panel to switch tool burs. This operation is not possible in the following cases.

- When the front cover or dust box cover is open
- When cutting is paused and during cutting

Procedure

1 Press [MENU] several times to display the following screen.

2 Turn the hand-wheel to select the function.

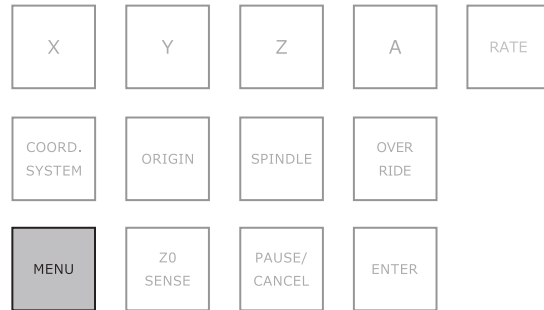
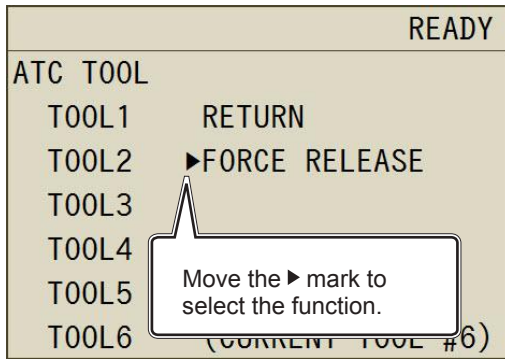

Display	Function
Tool Bur 1 to Tool Bur 6	Obtain the tool bur of the selected number. If a tool bur with a different number from the selected one is currently being held, the held tool will be returned, and then the selected tool bur will be obtained.
Return Tool Bur	Return the tool bur to the magazine.
Forced Release	The retained tool bur is released above its stocker. Follow the messages displayed on the built-in panel to take action accordingly.

3 Press [ENTER].

The machine operates. Press [MENU] several times to return to the top window.

How to Set Overrides

You can set the spindle's feeding speed and rotation speed.

Procedure

- 1 Press [OVER RIDE].
 XYZA : Spindle feeding speed
 S : Spindle rotation speed

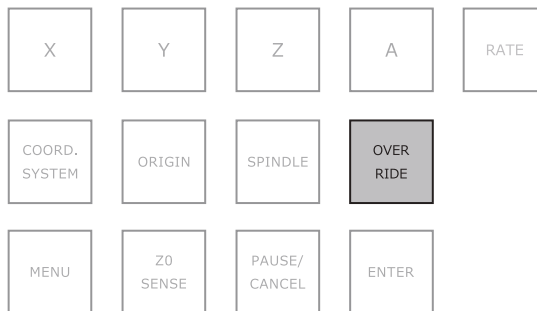
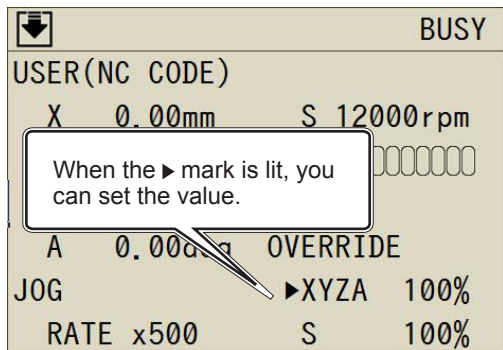

- 2 Turn the hand-wheel.
 The spindle's feeding speed or number of rotations changes.

Checking Job/Tool Bur Information during Cutting

Procedure

- 1 During cutting, press [MENU] several times to display the following screen.
 The job name and the estimated remaining time are only displayed when they are embedded in the cutting data sent from the PC.

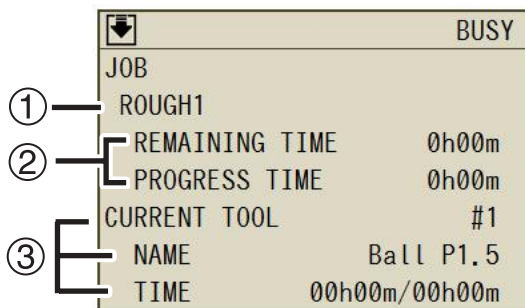

No.	Detail
①	This displays the name of the job being cut. The job name of processing data that is output from the SRP Player is converted to a name in accordance with the type of process. The number assigned to the output order is added to the job name. Example: - On SRP Player: Roughing1, Finishing23, Finishing1, ... - On the panel: ROUGH1, FINISH1, FINISH2, ...
②	This displays the estimated time remaining and the elapsed time for the data being cut.
③	This displays the information of the tool bur being used. The tool bur is displayed with its stocker number. "Name" and "Time" are displayed according to the details registered for the tool bur in VPanel and can be used to check the tool bur's work time.

Pausing/Resuming/Canceling Cutting

This procedure pauses the cutting operation. You can also resume cutting from the location where you paused it.

Procedure

1 Press [PAUSE/CANCEL].

This pauses the machine.

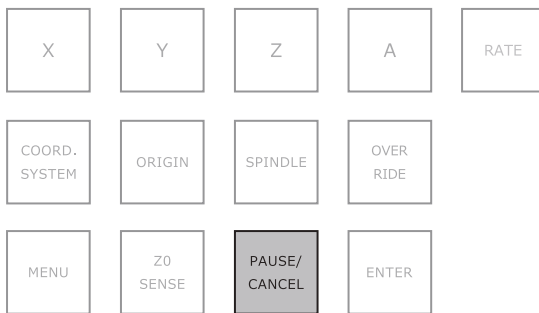

MEMO

You can set the tool bur operation when the machine is paused.

☞ P. 52 "Tool up in pause"

2 Press [PAUSE/CANCEL].

The screen shown in the figure appears.

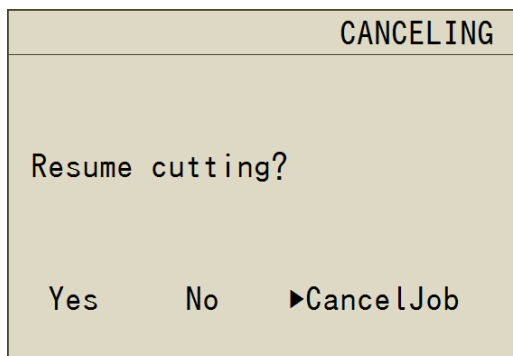

Yes : Resume cutting.

No : Continue to pause cutting.

Cancel job : Cancel cutting.

3 Use the hand-wheel to select the desired item.

4 Press [ENTER].

Functions That Can Be Operated While Cutting Is Paused (Built-in Panel)

- Hand-wheel feeding
- Starting and stopping spindle rotation
- Setting overrides
- Aborting cutting
- Resuming cutting

Recovering from Errors

Recoverable errors can be cleared from the built-in panel. Check the message displayed on the panel. Eliminate the cause of the error by using P. 80 "An Error Message Appears" as a reference.

When an Error That Has Options Occurs

Procedure

- 1 Turn the hand-wheel to select "Continue" or "Cancele Job."

Continue: Resume cutting.

Cancele Job: Cancel cutting.

Example) Error : 1023-0000

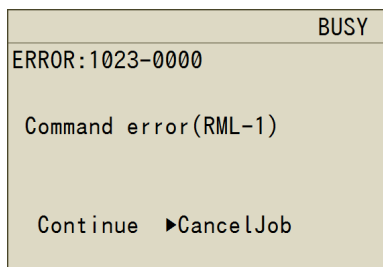

- 2 Press [ENTER].

The machine recovers from the error.

When an Error That Does Not Have Options Occurs (Recoverable)

Procedure

- 1 Press [ENTER].

The machine recovers from the error. You can only select "OK."

Example) Error : 1006-0204

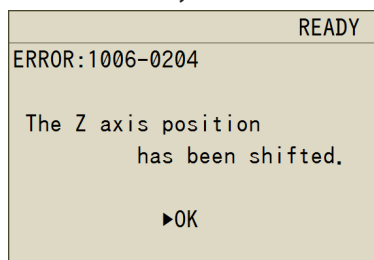

When an Error That Does Not Have Options Occurs (Non-recoverable)

Check the displayed message, and then see P. 80 "An Error Message Appears" and follow the countermeasures listed there.

Example) Error : 102A-0000

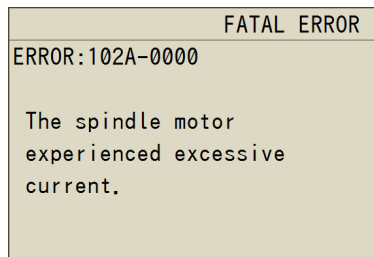

Turning Off the Status Lights during Cutting

Procedure

- 1 Display the following screen.
 - ① Press [MENU] several times to display the "Set" screen.
 - ② Select "Lights during Cutting," and then press [ENTER].

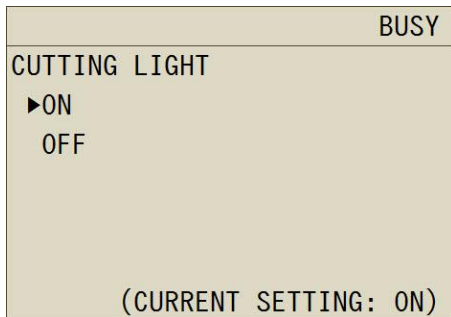

- 2 Turn the hand-wheel to select "Off."
- 3 Press [ENTER].

MEMO

When the power is turned off, this returns to the default value ("On").

Changing the Blower Strength during Cutting

This machine is equipped with an air blower. It activates automatically during tool burr replacement to clear away the cutting waste from the top of the magazine. You can also activate the air blower during cutting. However, the air blower is activated during cutting, cutting waste is more likely go outside of the machine. In the following cases, set the air blower setting to "off."

- Using the material which is powderised when you cut.
- When the cutting waste go outside of the machine.
- * When the tool bur is replaced, this setting is always set to "Strong."

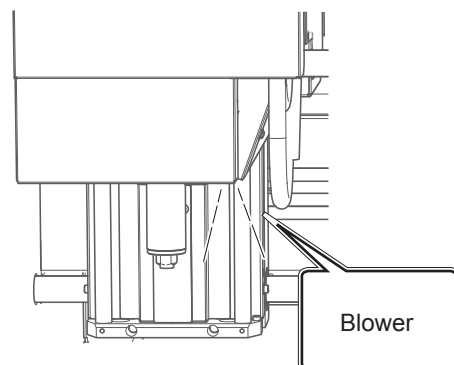
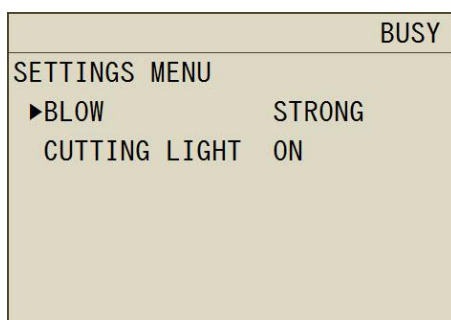

Procedure

- 1 Display the following screen.
 - ① Press [MENU] several times to display the "Set" screen.
 - ② Select "Blower," and then press [ENTER].



- 2 Turn the hand-wheel to select the blower setting.
- 3 Press [ENTER].

6. VPanel Operation (Practical Use)

-  "Settings" Dialog Box 51
 - "Preferences" Tab 51
 - "Machine" Tab 51
 - "Correction" Tab 52
 - "Origin" Tab 53
 - "Maintenance" Tab 55
 - "Mail" Tab 56
 - "Operation" Tab 57
 - "NC code setting" Dialog Box 58
 - "Attach/detach tool" Dialog Box 59
 - "Sensing Z origin" Dialog Box 59
 - "Spindle maintenance" Dialog Box 60
 - "Automatic correction" Dialog Box 60
 - "Manual correction" Dialog Box 61
 - "Move to user specified location" Dialog Box 62
-  "Cutter management" Dialog Box 63
 - "Cutter management" Dialog Box 63
 - "Cutter registration" Dialog Box 64
-  "Cut" Dialog Box 66
 - "Cut" Dialog Box 66
 - "Test cut" Dialog Box 67



"Settings" Dialog Box

Click  on the top window to display the "Settings" dialog box. You can use this dialog box to configure the operation settings of the connected machine. When the machine is offline, you can only select the "Environment", "Maintenance", and "Notification" tabs.

"Preferences" Tab

You can use this tab to set the language and units that are displayed in VPanel.

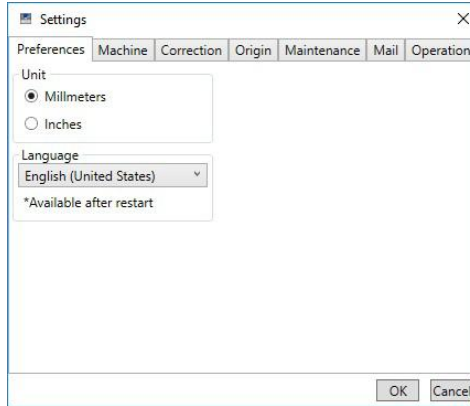

Unit	Select the unit to use for coordinate values and lengths. ➤ Initial setting: Millimeters
Language	Select the language to display on the screen. After you select the language, restart VPanel to enable this setting. ⇨ P. 8 "Exiting VPanel"

"Machine" Tab

You can use this tab to configure settings related to VPanel auto-startup and NC codes. You cannot select this tab when the machine is offline.

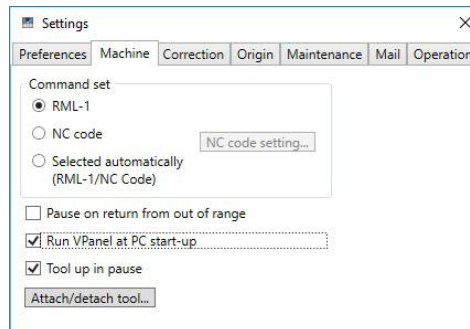

Command set	Select the command set. ➤ Initial setting: Automatic switching between RML-1 and NC code	
	RML-1	Select this option when using the software included with this machine.
	NC code	Select this option when you want to use NC codes. For details on NC codes, see P. 88 "NC Code Specifications" and the "NC Code Reference Guide" (electronic-format manual) included with this machine.
	Selected automatically (RML-1/ NC code)	Select this option to enable this machine to receive cutting programs that use either the RML-1 or NC code command set.
	NC code setting	Click this button to display the "NC code setting" dialog box. Use this dialog box to configure NC code settings. This button is only enabled when "NC code" or "Automatic switching between RML-1 and NC code" is selected. ⇨ P. 58 ""NC code setting" Dialog Box"

Pause on return from out of range	When this check box is selected, the machine will pause when it returns within the moveable range after performing a movement instruction outside of the moveable range. ➤ Initial setting: Cleared
Run VPanel at PC start-up	When this check box is selected, VPanel will start automatically when Windows starts, and the VPanel icon will be displayed in the task tray. ➤ Initial setting: Cleared
Tool up in pause	When this check box is selected, pausing operation will cause the machine to decelerate and stop, raise the tool bur to its upper limit, and stop the spindle. When this check box is cleared, the tool bur will stop wherever it is with the spindle still rotating. ➤ Initial setting: Selected
Attach/detach tool	Attach or detach the tool bur. Click this button to display the "Attach/detach tool" dialog box. ☞ P. 59 ""Attach/detach tool" Dialog Box"

"Correction" Tab

You can use this tab to configure settings related to cutting accuracy such as correcting the position of the cutting machine.

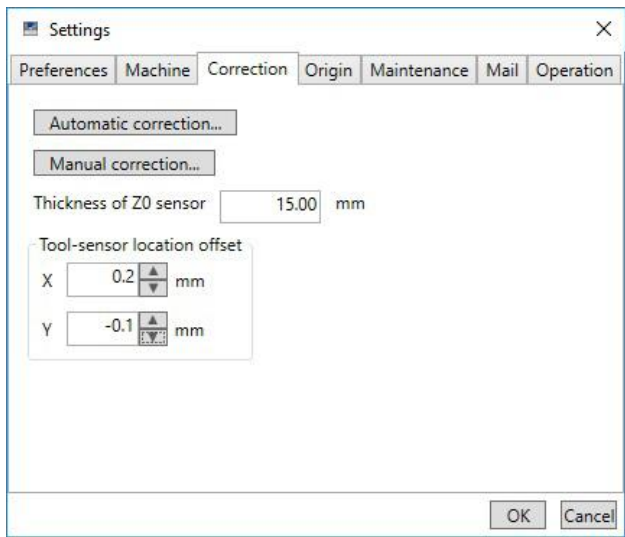







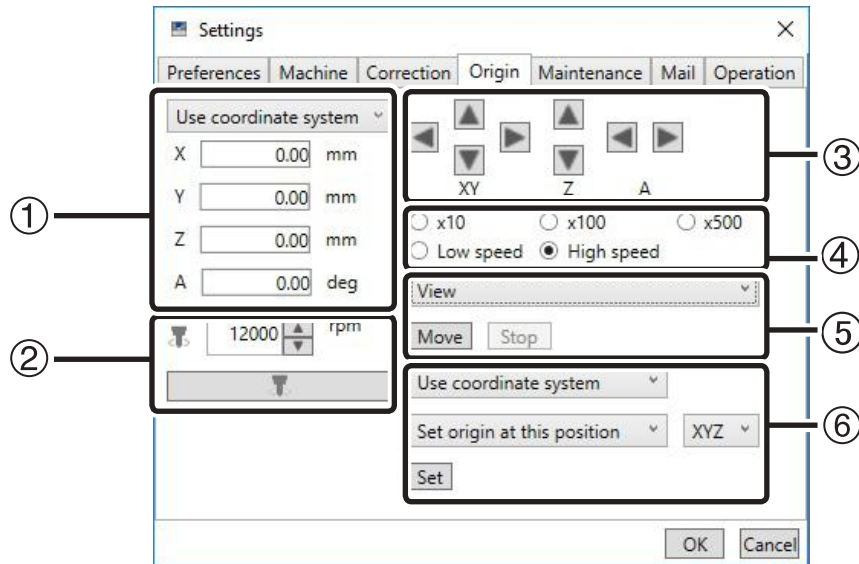



Automatic correction	Correct the ATC magazine position or the rotary axis position. Click this button to display the "Automatic correction" dialog box. Normally use [Automatic correction]. ☞ P. 60 ""Automatic correction" Dialog Box"
Manual correction	Correct the ATC magazine position or the rotary axis position. Click this button to display the "Manual correction" dialog box. ☞ P. 61 ""Manual correction" Dialog Box"
Thickness of Z0 sensor	Set the Z0 sensor thickness. ➤ Unit: [mm] only ➤ Initial setting: 15 mm
Tool-sensor location offset	Adjust the descended position of the tool bur when measuring the tool bur position with the tool sensor. In situations such as when the tool sensor is damaged, you can measure the tool bur length while avoiding the damage. If you perform automatic correction, these values are set to "0." ➤ Range: 0.0 mm (prescribed position) ± 3.0 mm, step: 0.1 mm ➤ Initial value: 0.0 mm

"Origin" Tab

You can use this tab to set the origins. You can also use this screen to perform tool bur movement and similar operations that are necessary to set the origins.



①	Coordinate system	Select the coordinate system to display for coordinate values.	RML-1: "Machine coordinate system" or "User coordinate system" NC: "Machine coordinate system," "EXOFS," or "G54" to "G59"
	X, Y, Z	This displays the current position (coordinate value) of each axis. ☞ P. 51 "Preferences" Tab	
	A	This displays the current position (rotation angle) of the rotary axis. This is only enabled when the (optional) rotary axis unit is attached. > Display digits: 0.01	
②		This displays the current spindle rotating speed. [rpm] You can use the spin box to adjust the rotating speed. (It is adjusted in units of 100 rpm.)	
		This starts and stops spindle rotation.	
③	XY	 Move the tool bur to the left (X-).	 Move the tool bur to the back (Y+).
		 Move the tool bur to the right (X+).	 Move the tool bur to the front (Y-).
	Z	 Move the tool bur up (Z+).	 Move the tool bur down (Z-).
	A	 Turn the rotary axis to the front (A+).	 Turn the rotary axis to the back (A-).
④	Step/speed	Select the number of steps and the speed of cursor movement. When you select "Low speed" or "High speed," the tool bur will only move when you hold down the button and will stop moving when you release the button. > Options: "x10," "x100," "x500," "Low speed," "High speed" (1 = 0.01 mm)	

⑤	Movement destination	View	The spindle is stopped before movement.	The spindle head moves to the left edge and the table moves to the frontmost position. This position is called the "view position." Use this position when loading or removing the cutting tool or the cutting material.
		xxx origin		Moves the tool bur to the origin in the selected coordinate system.
		A origin		Use this when the optional rotary axis unit is attached.
		Center of rotation		Move the tool bur tip to the center of rotation. You can only select this option when the rotary axis unit is attached.
		Specified location		Select this to open the "Move to user specified location" dialog box. ☞ P. 62 "Move to user specified location" Dialog Box"
Move	Move the tool bur to the selected movement destination. This button is disabled during tool bur movement.			
Stop	Stop the tool bur. This button is only enabled during tool bur movement.			
⑥	Coordinate system	Select the coordinate system of the origin to set. The options are the same as the coordinate system for ①.		
	Origin setting position/ coordinate axis	Set user origin here	"X," "Y," "Z," "XY," "XYZ," "A"*	Set the user origin to the current position. (For RML-1)
		Set EXOFS here	"X," "Y," "Z," "XY," "XYZ," "A"*	Set the EXOFS to the current position. (For NC)
		Set Gxx origin here (xx: 54 to 59)	"X," "Y," "Z," "XY," "XYZ," "A"*	Set the G54 to G59 origin to the current position. (For NC)
		Set origin using Z0 sensor	"Z"	Use the Z0 sensor to set the user Z origin. The "Sensing Z origin" dialog box appears. ☞ P. 59 "Sensing Z origin" Dialog Box"
		Set origin at center of rotation	"Y," "Z," "YZ"	Set the user origin to the center of rotation. The origin is returned to the position that was detected with the [Correction] tab. This is only enabled when the (optional) rotary axis unit is attached. Before configuring this setting, you have to perform automatic correction.
		Set origin at the left edge of workpiece	"X"	Set the user origin to the left edge of the workpiece. The origin is returned to the position that was detected with the [Correction] tab. This is only enabled when the (optional) rotary axis unit is attached. Before configuring this setting, you have to perform automatic correction.
Set	Set the selected origin.			

* You can select "A" when the optional rotary axis unit is attached.

"Maintenance" Tab

You can use this tab to perform operations related to maintenance such as making machine system reports and replacing the spindle.

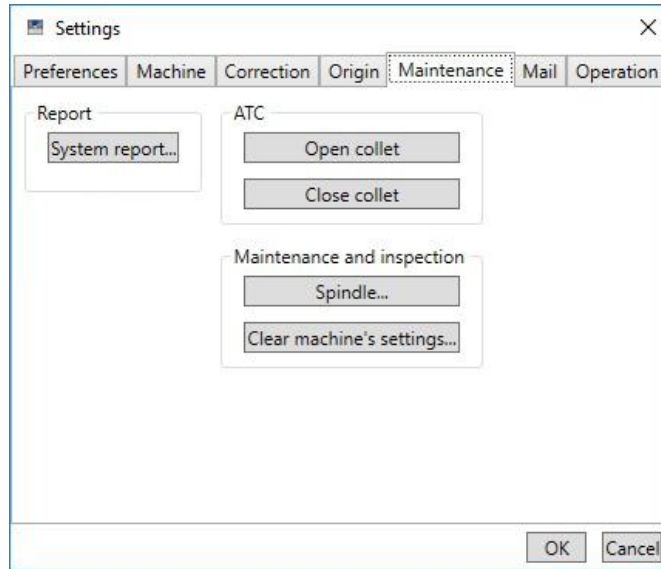

Report	System report	Display a system report. The "System report" dialog box appears.
ATC	Open collet	Open the collet. Use this button when performing collet maintenance (when retightening or replacing it).
	Close collet	Close the collet.
Maintenance and inspection	Spindle maintenance	Replace and perform maintenance on the spindle. The "Spindle maintenance" dialog box appears. ☞ P. 60 ""Spindle maintenance" Dialog Box"
	Clear machine's settings	Return all the machine settings to their factory default values.

"Mail" Tab

Settings in this tab can be configured so that a notification email is sent when cutting finishes, when an error occurs, or when maintenance is complete.

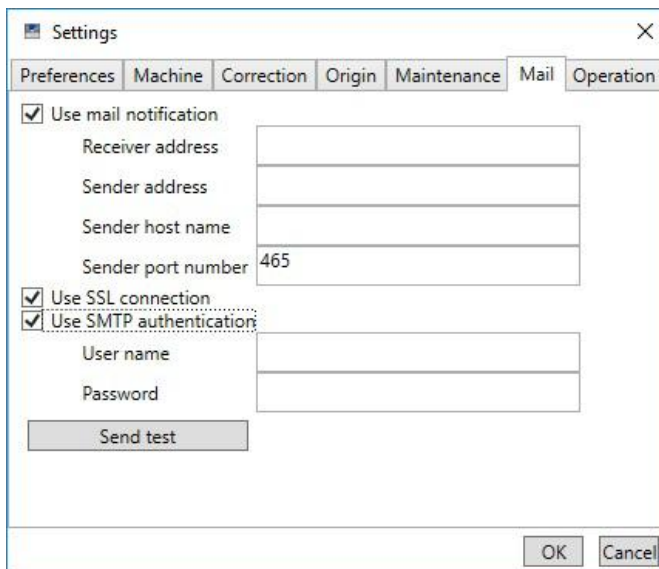

Use mail notification	Select this check box to enter each item.
Receiver address	Enter the receiver's email address. You can enter multiple addresses by separating them with commas.
Sender address	This is the sender's email address. Enter the email address being used on the computer on which VPanel is installed.
Sender host name	Enter the name of the outgoing mail server (SMTP server name) for the email address entered for the sender's address.
Sender port number	Enter the port number of the outgoing mail server for the email address entered for the sender's address.
Use SSL connection	Select this check box to use a security-protected connection (SSL). Select or clear this check box according to the settings of the outgoing mail server for the email address entered for the sender's address.
Use SMTP authentication User name/Password	Select this check box to use authentication when sending emails. Enter the user name and password for authentication. Select or clear this check box according to the settings of the outgoing mail server for the email address entered for the sender's address.
Send test	<p>Send a test email. If the following email is received at the address specified with "Receiver address," the configuration of the settings is complete.</p> <div style="border: 1px solid black; padding: 5px; width: fit-content; margin: 10px auto;"> Subject: <Machine name> Body: Test </div> <p>If the sending of the email fails, the message "The email could not be sent." will be displayed. Review the content in the input fields.</p>

Important

- * It may be impossible to send emails because of the settings of software such as security software. If emails cannot be sent, check the settings of the security software being used as anti-virus software or for a similar purpose.
- * For detailed information about the email settings, consult your network administrator.
- * VPanel does not support SMTP over SSL (SMTPs).

"Operation" Tab

This machine is equipped with an air blower. It activates automatically during tool burr replacement to clear away the cutting waste from the top of the magazine. You can also activate the air blower during cutting. However, the air blower is activated during cutting, cutting waste is more likely go outside of the machine. In the following cases, set the air blower setting to "off"

- Using the material which is powderised when you cut.
- When the cutting waste go outside of the machine.

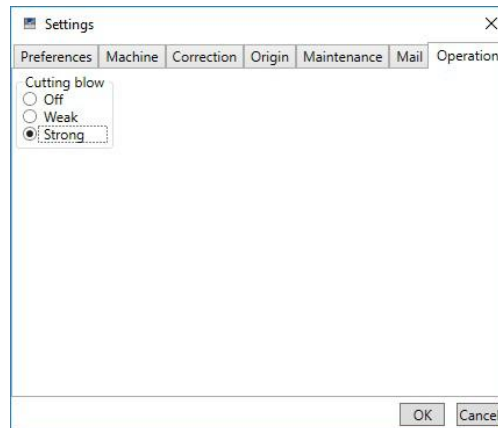

Cutting blow	<p>If you change this setting during cutting, the new setting will be the initial value the next time cutting is performed.</p> <p>* When the tool bur is replaced, this setting is always set to "Strong."</p> <p>➤ Initial value: Off</p>
---------------------	---

"NC code setting" Dialog Box

 - [Cutting Machine] tab - [NC code]

[NC code] Tab

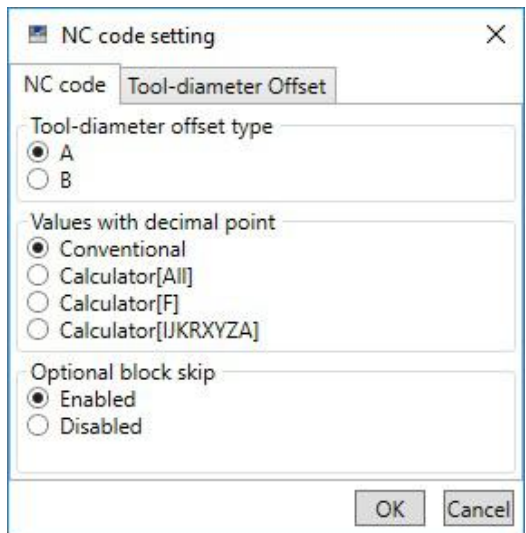

Tool-diameter offset type	Select the tool diameter correction type. You can select "A" or "B." ➤ Initial value: A
Values with decimal point	Select how to interpret real numbers. If you select "calculator interpretation," also select the scope of the application. ➤ Initial value: Conventional
Optional block skip	Select whether to skip optional blocks. ➤ Initial value: Enabled

[Tool-diameter Offset] Tab

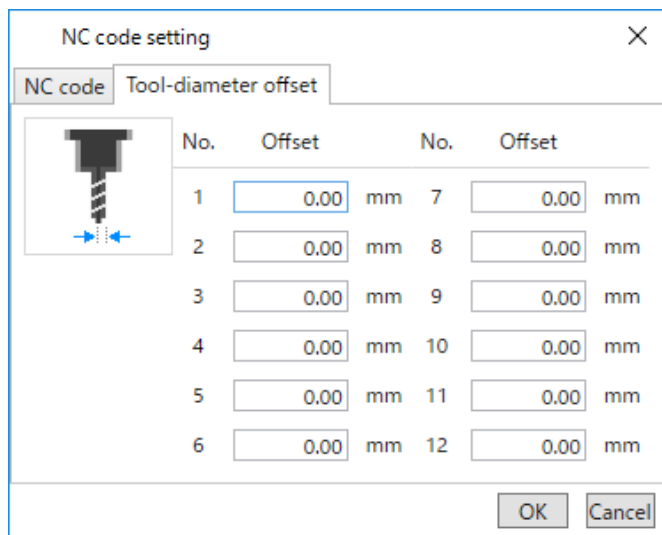

No.	Displays the number of the tool diameter correction value. (1 to 12) * These are not related to the ATC magazine stocker numbers. ➤ Initial value: 0
Offset	Set the tool diameter correction value. ➤ Unit: [mm], [inch]

"Attach/detach tool" Dialog Box

 - [Cutting Machine] tab - [Attach/detach tool]

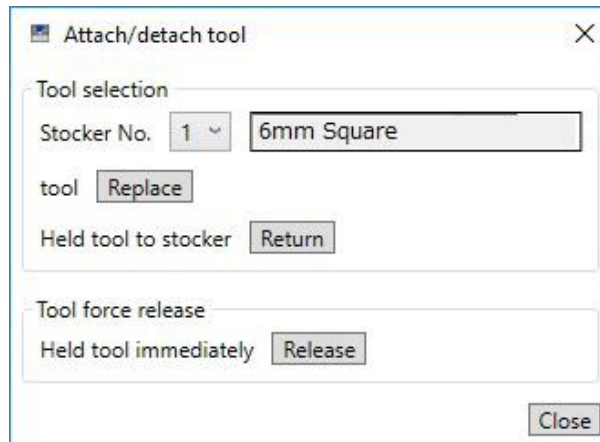

Tool selection	Stocker No.	Select the ATC magazine stocker number of the tool bur to grasp. The name of the tool bur whose number is selected is displayed in the box on the right.
	Replace	Obtain the tool bur from the ATC magazine. If the spindle is holding a tool bur, this tool bur is returned to its stocker, and then the tool bur of the selected stocker is obtained.
	Return	Return the tool bur to the ATC magazine.
Tool force release	Release	Click this to forcibly release the tool bur in an emergency. Check whether it is OK to release the tool bur once more. The retained tool bur is released above its stocker.

"Sensing Z origin" Dialog Box

 - [Origin] tab - [Set origin using Z0 sensor] - [Set]

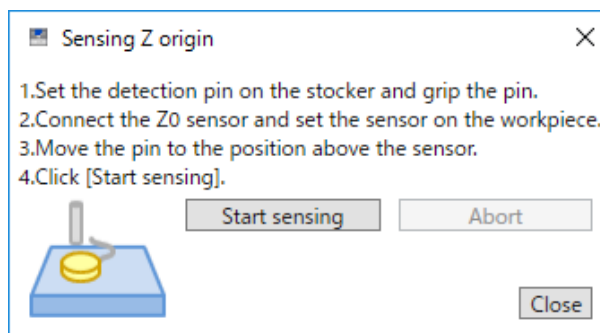

Start sensing	Start the detection of the Z origin. When the origin is detected correctly, the tool bur raises to its upper limit and moves to the standby position.
Abort	Cancel the detection of the Z origin. The previous Z origin is retained.

"Spindle maintenance" Dialog Box

 - [Maintenance] tab - [Spindle maintenance]

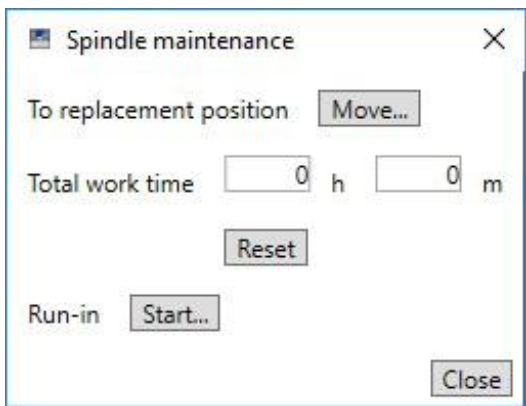

Move	Move the spindle to the replacement position.
Total work time	This displays the total working time of the spindle. You cannot enter the value.
Reset	After replacing the spindle unit, click [Reset] to reset the value to 0.
Start	Start spindle run-in. (This takes approximately 40 minutes.)

"Automatic correction" Dialog Box

 - [Correction] tab - [Automatic correction]

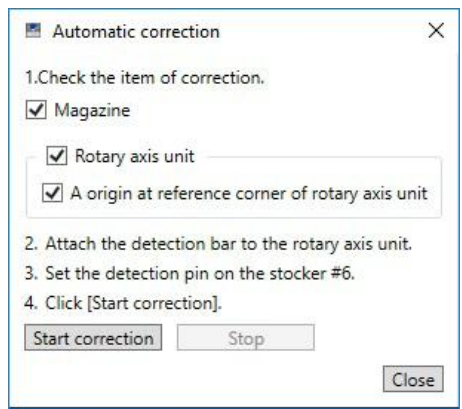

Magazine	Select this check box to detect the magazine and correct its position.
Rotary axis unit	Select this check box to detect the rotary axis and correct its position.
A origin at reference corner of rotary axis unit	Select this check box to set the user origin to the position where the clamp becomes level.
Start Correction	Start automatic correction. This button is disabled during correction.
Stop	Cancel automatic correction. This button is only enabled during correction.

"Manual correction" Dialog Box

 - [Correction] tab - [Manual correction]

Manual correction [X]

 This setting is affected by the cutting precision.
Use care when making this setting.

Distance

X %

Y %

Z %

A axis back side

A deg

Axis angle correction for the center of rotation

Point1-X mm

Amount of offset at point1

Y mm

Z mm

Point2-X mm

Amount of offset at point2

Y mm

Z mm

OK Cancel

Distance	Set the distance correction values.	
	X, Y, Z	Set the correction value (scaling) for each axis.
A axis back side	Detect the rotary axis and correct its position and orientation. This is only enabled when the (optional) rotary axis unit is attached.	
	A	Set the A-axis inversion correction value.
Axis angle correction for the center of rotation	Set the rotary axis tilt correction value. This is only enabled when the (optional) rotary axis unit is attached. See the user's manual included with the rotary axis unit.	
	Point1-X/Point2-X	Set the numeric values.

"Move to user specified location" Dialog Box

⚙️ - [Origin] tab - [Move]

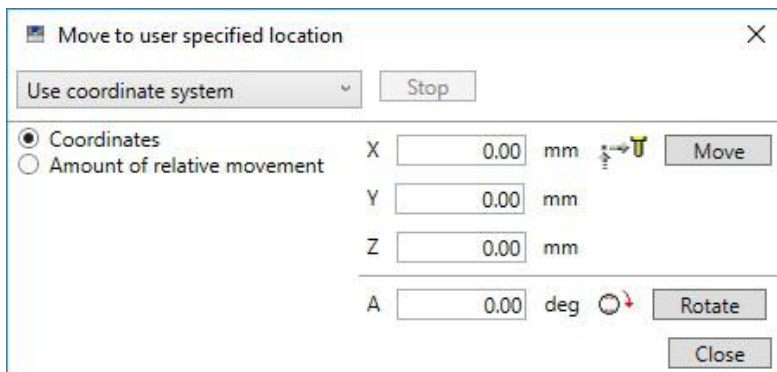

Coordinate system	Select the coordinate system to use when specifying coordinate values. This is disabled when "Amount of relative movement" is selected. Select one of the following options. ➤ "Machine coordinate system" ➤ "User coordinate system" (when RML-1 is selected) ➤ "G54" to "G59" or "EXOFS" (when NC code is selected)
Stop	Stop the tool bur movement. This button is only enabled during tool bur movement.
Coordinates	Specify the coordinate value to move to. (Absolute specification)
Amount of relative movement	Specify the amount of movement from the current position. (Relative specification)
X, Y, Z	Enter the coordinate value of the movement destination or the movement amount. ➤ Unit: [mm], [inch]
Move	Move the tool bur to the specified position or by the specified amount (X, Y, and Z).
A	Enter the angle or the amount of rotation of the rotary axis. This is only enabled when the (optional) rotary axis unit is attached. ➤ Unit: Degrees
Rotate	Rotate the rotary axis (A) to the specified angle or by the amount of rotation.





"Cutter management" Dialog Box

Click  on the top window to display the "Cutter management" dialog box.

"Cutter management" Dialog Box

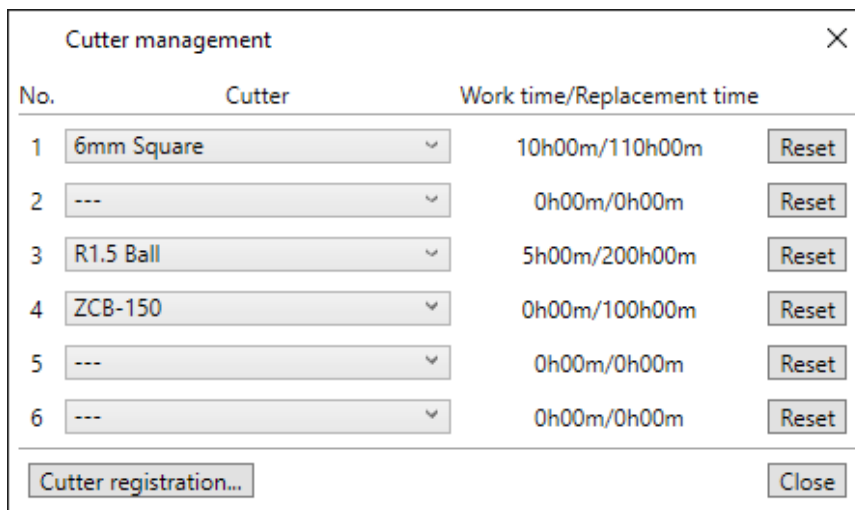
By using this dialog box to select tool burs to be used, the work time of the selected tool burs will be recorded automatically. In addition, when the bur reaches the preset replacement time, a warning message will be displayed.

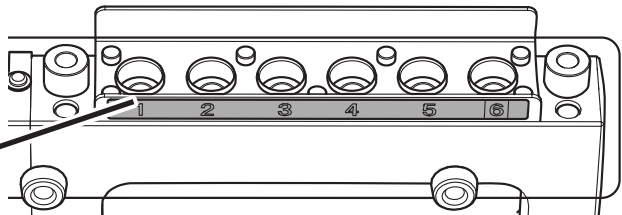

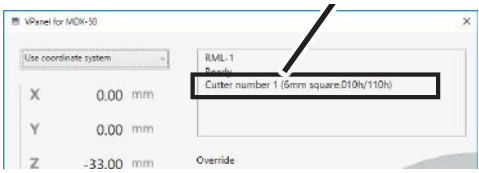
<p>No.</p>	<p>Register tool bur information to match the machine's ATC magazine stocker numbers. ⇨ P. 64 "Cutter registration" Dialog Box</p>  <p>Stocker number</p>
<p>Cutter</p>	<p>Click  to display the tool burs that have been registered. Select the name of a tool bur that has been loaded in a stocker to display the name on the VPanel top window. However, you cannot select or change tool burs from the Cutter management screen for the stocker whose tool bur currently holds the spindle. Also, the "Work time" will not be counted if you do not select a tool bur. ⇨ P. 64 "Cutter registration" Dialog Box</p>  <p>Tool bur information</p>
<p>Work time/Replacement time</p>	<p>Displays the work time and replacement time of the selected tool bur. When the bur reaches the preset replacement time, a warning message will be displayed. Click "Cutter registration" to change the replacement time. ⇨ P. 64 "Cutter registration" Dialog Box</p>
<p>Reset</p>	<p>After replacing the tool bur with a new one, click [Reset] to set the work time to "0."</p>
<p>Cutter registration</p>	<p>Click this button to register a tool bur whose work time you want to manage or to remove burs you no longer want to manage. The "Cutter registration" dialog box appears. ⇨ P. 64 "Cutter registration" Dialog Box</p>

"Cutter registration" Dialog Box

You can change a tool bur's registration information in order to change the work time or the replacement time.

 - [Cutter registration]

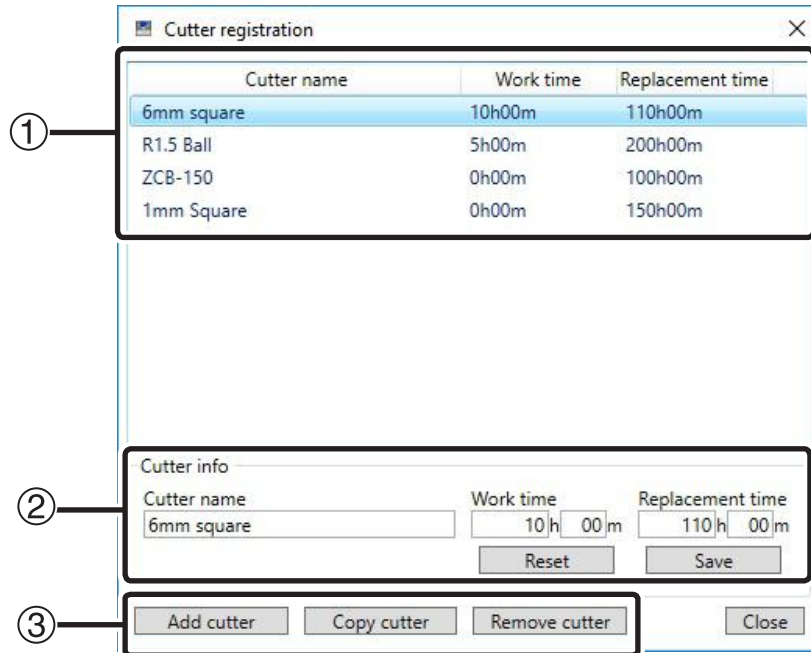

①	Tool bur list	Displays the names, work times, and replacement times of the registered tool burrs.	
②	Tool bur information	Cutter name	Displays the tool bur name. You can also set the name.
		Work time	Displays the tool bur work time. You can also set the work time.
		Replacement time	Displays the tool bur replacement time. You can also set the replacement time. If you set this to "0," the warning message when the replacement time is reached will not be displayed. ➤ Initial value: 0
		Reset	Reset the work time of the tool bur to "0."
		Save	You can edit the name, work time, and replacement time of the tool bur selected in the list. Click [Save] to save the edited content (the existing content is overwritten). Because replacement times depend on the type of tool bur or workpiece as well as the cutting conditions, adjust the replacement time value as necessary.
③	Add cutter	Registers an additional tool bur. You can register up to 20 tool burrs.	
	Copy cutter	Duplicates the selected tool bur. Enter a different name for the "Cutter name." The "Work time" is set to "0," and the "Replacement time" is duplicated.	
	Remove cutter	Deletes the tool bur selected in the list.	

Registering Tool Bur Information

If you register the tool bur information in VPanel, you can record the work time of the actually used tool burs and check the estimated replacement periods. For tool burs used with CAM, you also have to configure the settings on the CAM side.

Procedure

- 1 Click  and then [Cutter registration].
The "Cutter registration" dialog box appears.

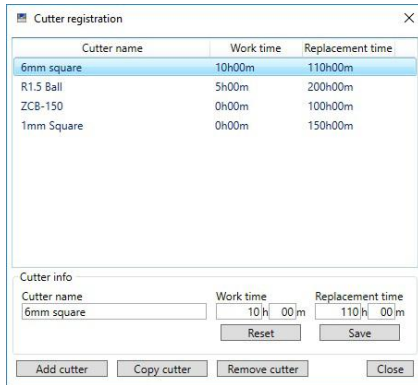

- 2 Register the tool bur.
 - 1 Enter the "Cutter name," "Work time," and "Replacement time."
When registering a new tool bur, enter "0 h 00 m" for the "Work time."
 - 2 Click [Add cutter].
 - 3 Click [Close].

☞ P. 63 "Cutter management" Dialog Box"

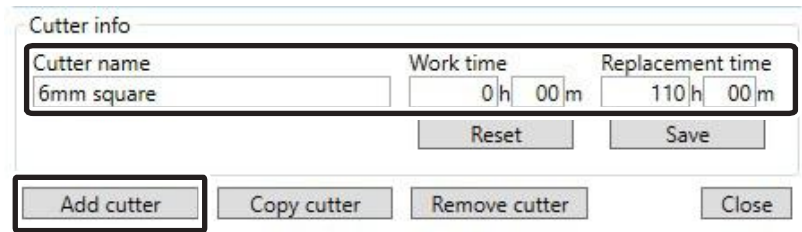

- 3 Select a tool bur in the "Cutter management" dialog box.
Click  in the VPanel "Cutter management" dialog box to select the tool bur to use. Tool burs that have not been registered in the "Cutter registration" dialog box are not displayed.

☞ P. 63 "Cutter management" Dialog Box"

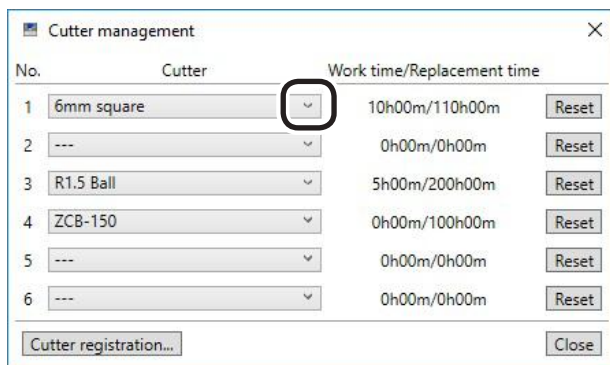





"Cut" Dialog Box

Click  on the top window to display the "Cut" dialog box.

"Cut" Dialog Box

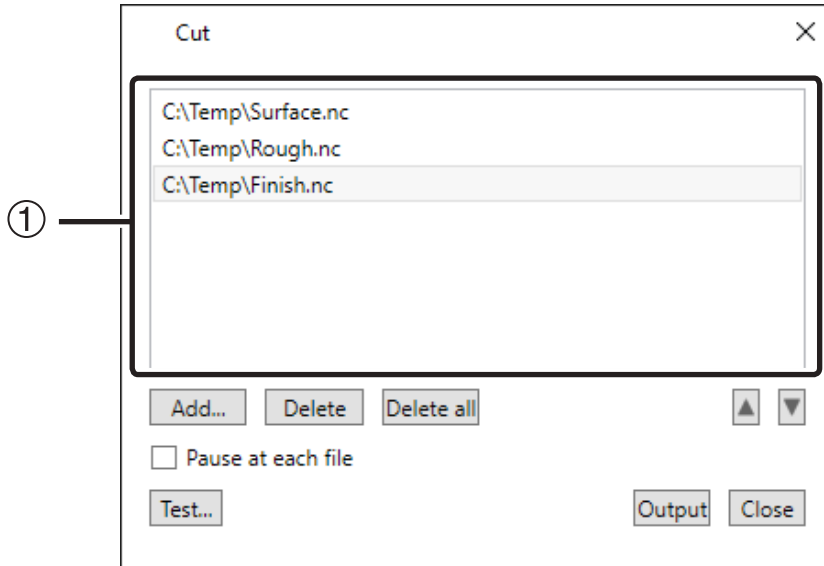
Use this dialog box to output cutting data to the machine.











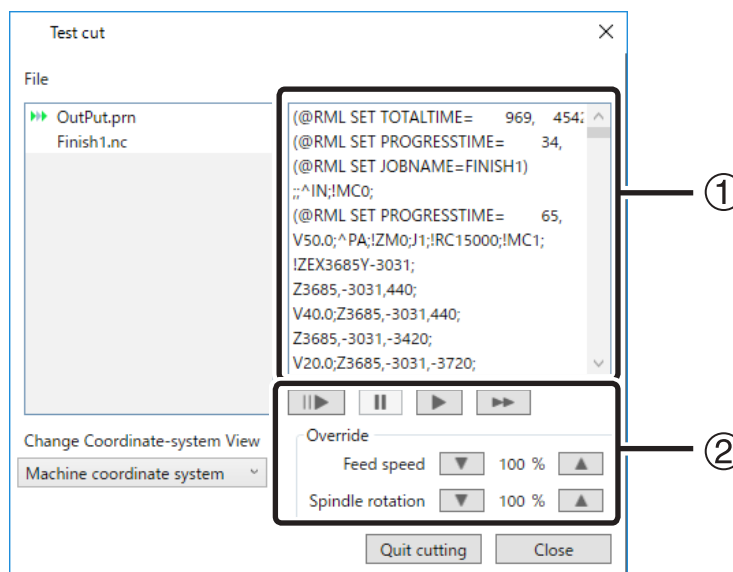

①	Output file list	This displays a list of the output files. The files are output in order starting from the top of the list.
	Add	Displays the "Open" dialog box, which you can use to add a file that you want to output to the output file list indicated with ①. You can also add files by dragging them to the output file list.
	Delete	Deletes the selected file from the list.
	Delete all	Deletes all the files from the list.
		Moves the selected file up or down in the list.
	Test	Tests the program operations on the actual machine. The "Test cut" dialog box appears. This button is only enabled in NC mode. ☞ P. 67 ""Test cut" Dialog Box"
	Pause at each file	Select this check box to pause the output for each file. ➤ Initial value: Cleared
	Output	Outputs the files in the list to the machine in order from the top. When you click this button, this dialog box closes.

"Test cut" Dialog Box

Use this dialog box to perform test cutting for the specified NC code.

 - [Test]



File	This displays a list of the files and the test progress. The file currently being tested is highlighted and  is displayed to the left of the file name.  is displayed to the left of the names of files that have already been tested.	
①	Code	This displays the NC code written in the file. The line (block) that is currently being executed is highlighted.
②		Execute the next block, and then pause the operation. During execution, this button as well as the  and  buttons are disabled.
		Pause the cutting machine. Click this button again to resume operation. This button is only enabled during operation.
		Perform normal operation (a run) without pausing after each block. However, operation will be paused in blocks that contain the "M01" command. To resume operation, click  or  . During a run, this button is disabled.
		Perform operations at the fastest speed at all times (a dry run). However, operation will be paused in blocks that contain the "M01" command. To resume operation, click [Run] or [Dry Run]. During a dry run, this button is disabled.
Coordinate System Display	Select the coordinate system of the coordinate values displayed on the built-in panel and on the top window. ➤ "G55" to "G59," "EXOFS"	
Override	Adjust the overrides.	
	Feeding speed	Adjust the override of the feeding speed (during cutting). Each time you click one of the arrow buttons, the value decreases or increases by 10. ➤ Range: 10 to 200 [%]
	Spindle rotation	Adjust the override of the spindle rotating speed. Each time you click one of the arrow buttons, the value decreases or increases by 5. ➤ Range: 25 to 200 [%]
Canceled	Cancels (or continues) cutting. The "Paused" dialog box appears.	
End Test	Clear the test cutting mode and close this dialog box. The remaining blocks are output normally, and the machine continues to operate. If you have used [Canceled] to cancel operations, the machine switches to standby.	

7. Troubleshooting

Machine/VPanel Problems	69
The Power Does Not Turn On	69
Initial Operations Are Not Performed or Fail	69
VPanel Doesn't Start Correctly	69
Operations Are Ignored.....	70
Detection with the Z0 Sensor Fails	70
Automatic Correction Fails.....	71
Abnormal Cutting Is Performed	71
When the Machine Stops with the Tool Bur Inserted in the Workpiece..	71
No Data Can Be Output to the Machine or the Machine Does Not Operate Even Though Data Is Being Output.....	72
Misaligned Origins	72
Quality Problems	73
The Cutting Results Are Not Attractive	73
Installation Problems	74
Installing the Driver Separately	74
Installing the Software and the Electronic-format Manuals Separately..	76
Driver Installation Is Impossible	77
Uninstalling the Driver.....	78
Uninstalling VPanel.....	79
An Error Message Appears	80

Machine/VPanel Problems

The Power Does Not Turn On

Has the emergency stop button been pressed?



If the emergency stop button has been pressed, the power will not turn on. Release the emergency stop button.

☞ P. 13 "Emergency Stop or Pause Due to Opening or Closing the Cover"

Initial Operations Are Not Performed or Fail

Is the front cover or the dust box cover open?



Keep the front cover and the dust box cover closed when starting the machine. For safety, the initial operations are not performed if a cover is open when the machine starts.

Is a large amount of cutting waste present?



Clean away any cutting waste. Clean the area around the spindle head especially carefully.

☞ P. 31 "Cleaning after Cutting Finishes"

Is anything caught on the spindle head or table?



Check whether something has become caught and is impeding the initial operations.

Is the tool bur caught on anything?



The machine may not be able to perform the initial operations if the tool bur attached to the spindle unit is caught on the rotary axis unit or workpiece. Try to detach the tool bur using the built-in panel's emergency release function.

☞ P. 71 "When the Machine Stops with the Tool Bur Inserted in the Workpiece"

VPanel Doesn't Start Correctly

Have the initial operations been completed?



Before you start VPanel, first switch on the power to the machine.

☞ P. 7 "Displaying VPanel"

Is the computer connected to the machine?



Check whether the connector cable has come loose.

Is the driver installed correctly?



If the connection to the computer is not made according to the procedure described, the driver will not be installed correctly. VPanel will not function normally if the driver is not configured correctly. Check again to ensure that the connection was made using the correct procedure.

☞ "Setup Guide" ("Installing the Windows Driver")

Are multiple machines connected to a single computer?



VPanel cannot control multiple machines at the same time. Never connect multiple instances of this machine to a single computer.

Operations Are Ignored

<p>Is the cable connected?</p>		<p>Connect the cable securely.</p> <p>☞ "Setup Guide" ("Connecting the Cables")</p>
<p>Was the machine started according to the correct procedure?</p>		<p>Simply switching on the main power switch does not enable operation. Start the machine using the correct procedure.</p> <p>☞ "Setup Guide"</p>
<p>Is the front cover or the dust box cover open?</p>		<p>If the front cover or the dust cover is open, the machine will not start cutting even if cutting data is received. Close all the covers.</p>
<p>Is the driver installed correctly?</p>		<p>If the connection to the computer is not made according to the procedure described, the driver will not be installed correctly. Check again to ensure that the connection was made using the correct procedure.</p> <p>☞ "Setup Guide" ("Installing the Windows Driver")</p>
<p>Are multiple machines connected to a single computer?</p>		<p>VPanel cannot control multiple machines at the same time. Never connect multiple instances of this machine to a single computer.</p>
<p>Is VPanel or the built-in panel displaying an error message?</p>		<p>VPanel or the built-in panel displays a description of the error.</p> <p>☞ P. 80 "An Error Message Appears"</p>
<p>Is operation paused?</p>		<p>When the machine is paused, cutting stops and some operations are restricted.</p> <p>Cancel the paused state.</p> <p>☞ P. 4 "Operation Keys"</p>
<p>Does VPanel recognize the machine?</p>		<p>Verify that "Offline" is not displayed in VPanel.</p> <p>☞ P. 7 "Displaying VPanel"</p>
<p>Is the spindle belt damaged or disconnected?</p>		<p>Check inside the maintenance cover. If the spindle belt is damaged, replace it.</p> <p>☞ P. 33 "Periodic Maintenance"</p>

Detection with the Z0 Sensor Fails

<p>Are you using a thin tool bur? Are you using a non-conductive tool bur?</p>		<p>If you use a thin or non-conductive tool bur, you may not be able to perform correct detections. Use the detection pin.</p>
<p>Is the Z0 sensor dirty?</p>		<p>Clean away any grime on the Z0 sensor. Fouling due to buildup of cutting waste or the like on this item may impede correct sensor operation, making detection impossible.</p>
<p>Is the cable connected?</p>		<p>Connect the cable securely.</p>

Automatic Correction Fails

<p>Is the detection pin or ATC magazine dirty?</p>	→	<p>Clean away any grime on the detection pin and the ATC magazine. Fouling due to buildup of cutting waste or the like on this item may impede correct sensor operation, making detection impossible.</p> <p>☞ P. 24 "Step 5 : Setting the Z Origin (Using the Z0 Sensor)"</p>
<p>Is the detection pin properly attached?</p>	→	<p>Verify that the detection pin is properly attached. Check the position of the tool holder on the detection pin.</p> <p>☞ "Setup Guide"</p>

Abnormal Cutting Is Performed

<p>Have the origins been set at correct positions?</p>	→	<p>Check that the origins have been set correctly. If the origin locations are not correct, cutting at an unintended location or to the wrong depth may occur.</p> <p>☞ P. 22 "Step 4 : Setting the XY Origin"</p> <p>☞ P. 24 "Step 5 : Setting the Z Origin (Using the Z0 Sensor)"</p>
<p>Is the command set correct?</p>	→	<p>Check that a command set that is compatible with the application software you are using has been selected. If the command set is not compatible, errors may occur, the machine may not operate, or unintended operations may occur.</p> <p>☞ P. 51 ""Machine" Tab"</p>

When the Machine Stops with the Tool Bar Inserted in the Workpiece

Procedure

- 1 Switch off the power.
- 2 Perform an emergency tool bar release.
 - 1 Switch on the power, and then press [SPINDLE] when the following screen is displayed.

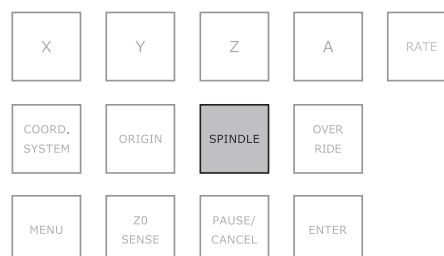

- ② When the following screen is displayed, use the dial to select "Yes," and then press [ENTER].

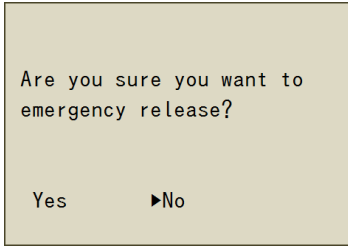

The tool bur is released in its current position.

- ③ Open the cover, and then remove the tool bur.
 ④ When "Please hit [ENTER] key." is displayed on the built-in panel, press [ENTER].



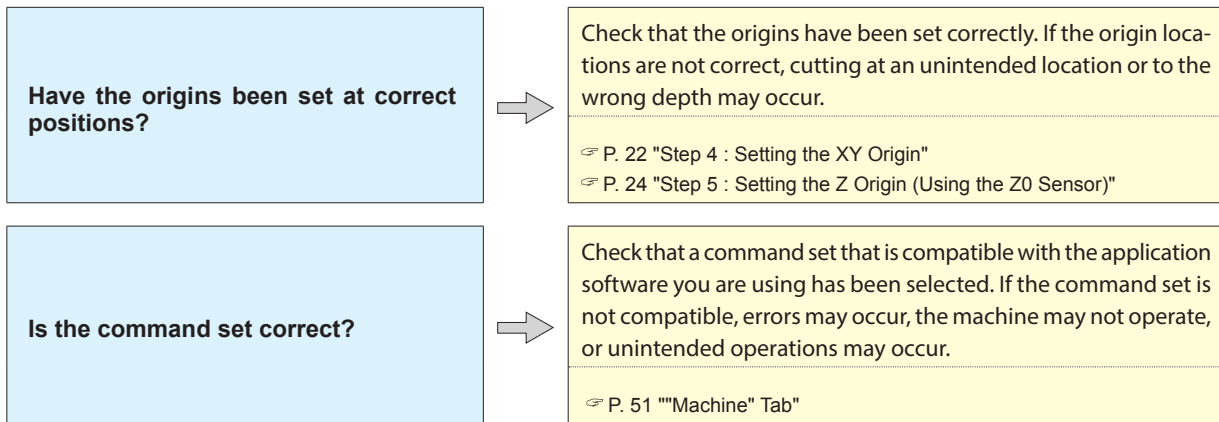

No Data Can Be Output to the Machine or the Machine Does Not Operate Even Though Data Is Being Output

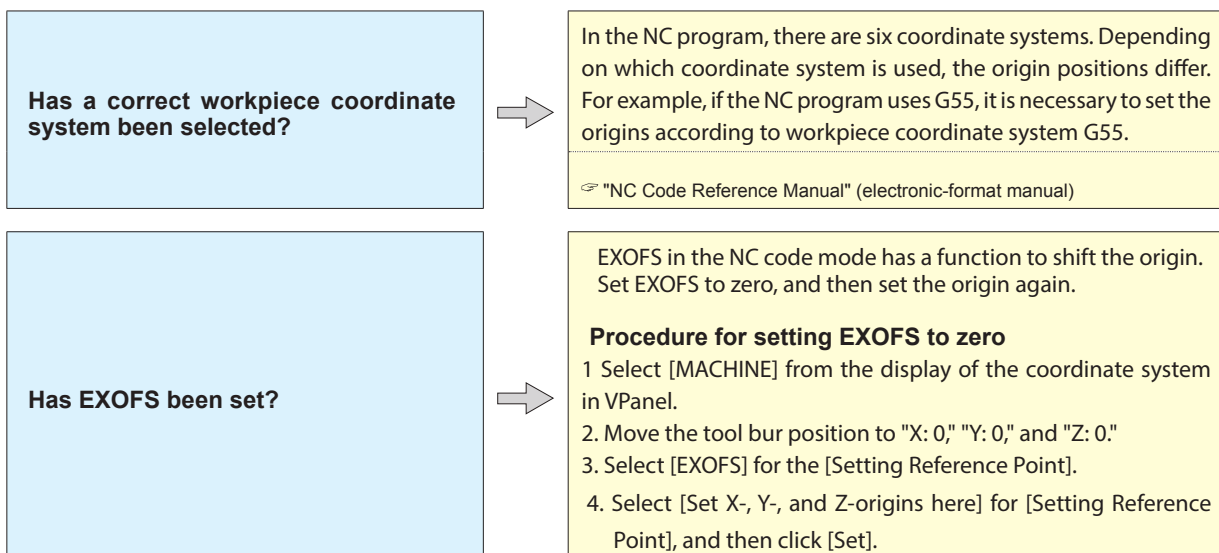

Misaligned Origins



The Cutting Results Are Not Attractive

<p>Are the cutting conditions optimal?</p>		<p>The optimal cutting conditions are determined by the balance between factors such as the workpiece hardness, the feeding speed, the spindle rotating speed, the cutting-in depth, and the tool bur capability. Make adjustments a little bit at a time while checking the cutting results.</p>
<p>Is the tip of the tool bur worn?</p>		<p>If the same tool bur is used for cutting for a long period of time, it will become worn and affect the cutting results. Try replacing the tool bur with a new one. The work time of the tool bur can also be managed in VPanel.</p>
<p>Has EXOFS been set?</p>		<p>EXOFS in the NC code mode has a function to shift the origin. Set EXOFS to zero, and then set the origin again.</p> <p>Procedure for setting EXOFS to zero</p> <ol style="list-style-type: none">1. Select [MACHINE] from the display of the coordinate system in VPanel.2. Move the tool bur position to "X: 0," "Y: 0," and "Z: 0."3. Select [EXOFS] for the [Setting Reference Point].4. Select [Set X-, Y-, and Z-origins here] for [Setting Reference Point], and then click [Set].
<p>Is the workpiece firmly secured in place?</p>		<p>Check the mounting condition of the workpiece. If the workpiece is not mounted on the machine correctly, the workpiece may become misaligned during cutting.</p>

Installation Problems

Installing the Driver Separately

With this machine, you can also install the driver, software, and electronic-format manuals all at once. For the method to use in installing all these items at once, see the "Setup Guide."

Important

- Be sure to connect the machine to the computer as instructed in the procedure. Failure to follow the correct procedure may make installation impossible.
- If an old version of SRP Player is installed, uninstall it, and then install a new version.

Procedure

- 1 Before installation, confirm that the machine and the computer are not connected with the USB cable.
- 2 Log on to Windows as the computer's administrator (or as an "Administrators" account).
- 3 Insert the Roland DG Software Package CD into the CD-ROM drive of the computer.
When the automatic playback window appears, click [Run menu.exe]. If a "User Account Control" window appears, click [Allow] or [Yes], and then continue with the installation. The setup menu screen appears automatically.
If the driver is already installed, uninstall it.
P. 78 "Uninstalling the Driver"
If the driver is not installed or if it has been uninstalled, go to step 4.

- 4 Click [Custom Install].
Follow the on-screen instructions to proceed with the installation.



- 5 Click [Install] for the "Windows Driver."



Windows 10

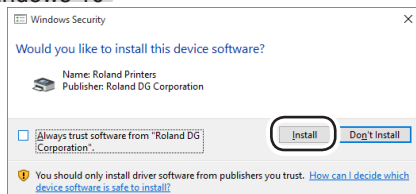

When the window shown in the figure appears, click [Install].

Windows 8.1



When the window shown in the figure appears, click [Install].

Windows 7

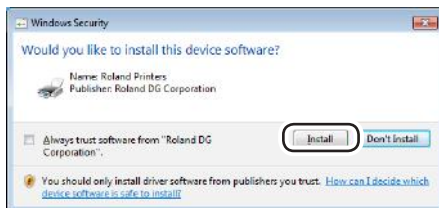

When the window shown in the figure appears, click [Install].

- 6 Follow the on-screen instructions to proceed with the installation.
- 7 When the installation is complete, remove the Roland DG Software Package CD from the computer.
- 8 Turn on the power to the machine.
- 9 Connect the machine to the computer using the USB cable.
 - Use the included USB cable.
 - Do not use a USB hub. Connection may not be possible.

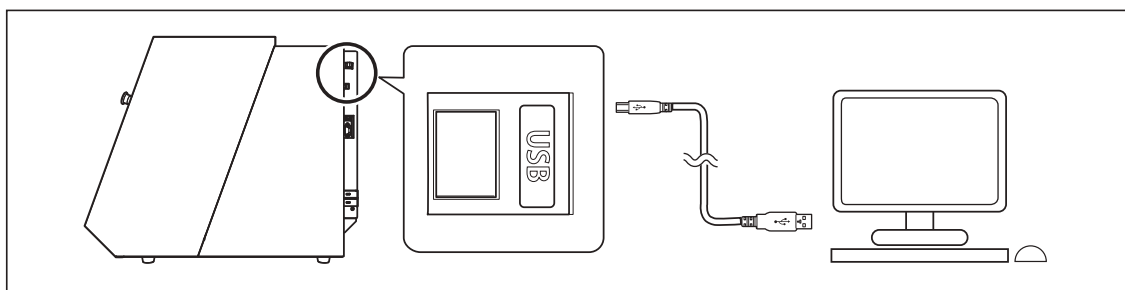

The driver will be installed automatically.

- 10 Secure the USB cable with a cable clamp.

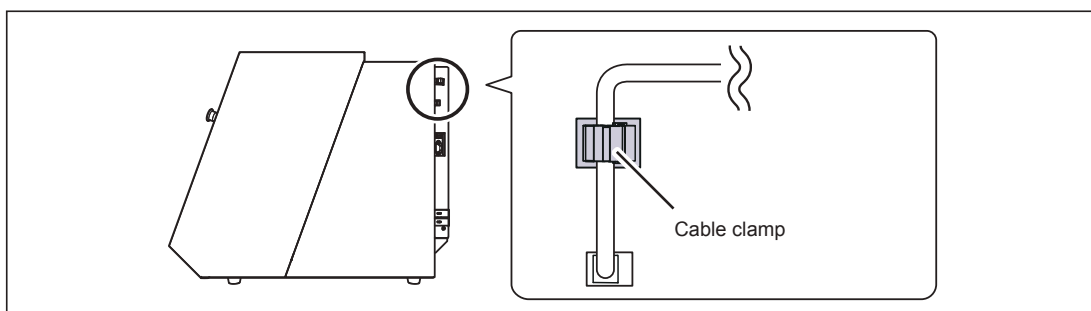

Installing the Software and the Electronic-format Manuals Separately

Important

If an old version of SRP Player is installed, uninstall it, and then install a new version.

Procedure

- 1 Log on to Windows as the computer's administrator (or as an "Administrators" account).
- 2 Insert the Roland DG Software Package CD into the CD-ROM drive of the computer.
When the automatic playback window appears, click [Run menu.exe]. If a "User Account Control" window appears, click [Allow] or [Yes], and then continue with the installation. The setup menu screen appears automatically.
- 3 Click [Custom Install] for the "MDX-50 Software."



- 4 Click [Install] for the "MDX-50 Manuals."

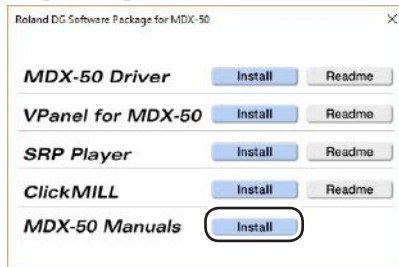

- 5 Follow the on-screen instructions to proceed with the installation.
- 6 When the installation is complete, remove the Roland DG Software Package CD from the computer.

With this machine, you can also install the driver, software, and electronic-format manuals all at once. For the method to use in installing all these items at once, see the "Setup Guide."

Driver Installation Is Impossible

If installation quits partway through or if VPanel does not recognize the machine, the driver may not have been installed correctly. In such cases, perform the following procedures. (If procedure A does not solve your problem, perform procedure B.)

Windows 10 and 8.1 (Procedure A)

1. Connect the machine to the computer with the USB cable and turn on the machine.
2. Click [Desktop].
3. Right-click the [Start] button, and then click [Control Panel].
4. Click [View devices and printers] or [Devices and Printers].
5. Check that the model you are using is displayed under "Unspecified."
6. Right-click the icon of the model you are using, and then click [Remove device].
7. If the message "Are you sure you want to remove this device?" is displayed, click [Yes].
8. Check that the icon for the model you are using is no longer displayed under "Unspecified."
9. Temporarily disconnect the USB cable connecting the machine to the computer, and then reconnect these devices. If the printer icon for the machine you are using is displayed under "Printers," the driver has been successfully installed. If this does not solve the problem, perform the procedure under "Windows 10 and 8.1 (Procedure B)."

Windows 10 and 8.1 (Procedure B)

1. Connect the machine to the computer with the USB cable and turn on the machine.
2. If the [Found New Hardware] message appears, click [Close] to close it. Disconnect any USB cables for printers or other such equipment other than this machine.
3. Click [Desktop].
4. Right-click the [Start] button, and then click [Device Manager].
5. If the [User Account Control] window appears, click [Continue]. [Device Manager] appears.
6. Click [Show hidden devices] from the [View] menu.
7. In the list, find [Printers] or [Other devices], and then double-click it. Under the selected item, click the name of the model you are using or [Unknown device].
8. Click [Uninstall] from the [Action] menu.
9. In the "Confirm Device Uninstall" window, click [OK]. Close [Device Manager].
10. Detach the USB cable from the computer, and then restart Windows.
11. Uninstall the driver. Carry out the procedure from step 3 on page 75 "Uninstalling the Driver (Windows 10 and 8.1)" to uninstall the driver.
12. Reinstall the driver again according to the procedure in the "Setup Guide" ("Installing the Software") or under P. 74 "Installing the Driver Separately".

Windows 7 (Procedure A)

1. Connect the machine to the computer with the USB cable and turn on the machine.
 2. From the [Start] menu, click [Devices and Printers].
 3. Check that the model you are using is displayed under "Unspecified."
 4. Right-click the icon of the model you are using, and then click [Troubleshoot].
 5. When a screen is displayed with the message "Install a driver for this device," click [Apply this fix].
 6. If a message is displayed asking you to "Set as default printer," click [Skip this fix].
 7. When the message "Troubleshooting has completed" is displayed, click [Close the troubleshooter].
- If the printer icon for the machine you are using is displayed under "Printers," the driver has been successfully installed. If this does not solve the problem, perform the procedure under "Windows 7 (Procedure B)."

Windows 7 (Procedure B)

1. If the [Found New Hardware] message appears, click [Close] to close it.
2. From the [Start] menu, right-click [Computer]. Click [Properties].
3. Click [Device Manager]. The [User Account Control] window appears. Click [Continue]. [Device Manager] appears.
4. Click [Show hidden devices] from the [View] menu.
5. In the list, find [Other devices], and then double-click it. Under the selected item, click the name of the model you are using or [Unknown device].
6. Click [Uninstall] from the [Action] menu.

7. In the "Confirm Device Uninstall" window, select [Delete the driver software for this device.], and then click [OK]. Close [Device Manager].
8. Detach the USB cable from the computer, and then restart Windows.
9. Uninstall the driver. Carry out the procedure from step 3 on page 75 "Uninstalling the Driver (Windows 7)" to uninstall the driver.
10. Reinstall the driver again according to the procedure in the "Setup Guide" ("Installing the Software") or under P. 74 "Installing the Driver Separately".

Uninstalling the Driver

When uninstalling the driver, perform the following procedure.

Windows 10 and 8.1

* If you uninstall the driver without following the procedure given below, you may not be able to reinstall the driver.

1. Turn off the machine and remove the cable connecting the machine to the computer.
2. Log on to Windows as the computer's administrator.
3. Click [Desktop].
4. Right-click the [Start] button, and then click [Control Panel].
5. Click [Uninstall a program] (or [Programs and Features]).
6. Select the driver of the machine to remove by clicking it, and then click [Uninstall]. If the [User Account Control] window appears, click [Allow].
7. The removal confirmation message will appear. Click [Yes].
8. Click [Start], and then click [Desktop].
9. Open Explorer, and then open the drive and folder containing the driver. (*)
10. Double-click "SETUP64.EXE" (64-bit version) or "SETUP.EXE" (32-bit version).
11. If the [User Account Control] window appears, click [Allow]. The setup program for the driver starts.
12. Click [Uninstall]. Select the machine to remove, and then click [Start].
13. If it is necessary to restart your computer, a window prompting you to restart it will appear. Click [Yes].
14. After the computer has restarted, open the Control Panel again, and then click [View devices and printers] or [Devices and Printers].
15. If you can see the icon of the machine to remove, right-click it and click [Remove device].

(*) When using the CD-ROM, specify the folder as shown below. (This is assuming your CD-ROM drive is the D drive.)

D: \Drivers\WINX64 (64-bit version)

D: \Drivers\WINX86 (32-bit version)

If you're not using the Roland DG Software Package CD, go to the Roland DG Corporation website (<http://www.rolanddg.com/>) and download the driver for the machine you want to remove, and then specify the folder where you want to extract the downloaded file.

Windows 7

* If you uninstall the driver without following the procedure given below, you may not be able to reinstall the driver.

1. Before you start uninstalling the driver, unplug the USB cables from your computer.
2. Log on to Windows as the computer's administrator.
3. From the [Start] menu, click [Control Panel]. Click [Uninstall a program] (or [Programs and Features]).
4. Select the driver of the machine to remove by clicking it, and then click [Uninstall].
5. The removal confirmation message will appear. Click [Yes].
6. From the [Start] menu, select [All Programs], then [Accessories], then [Run], and then click [Browse].
7. Select the name of the drive or folder where the driver is located. (*)
8. Select "SETUP64.EXE" (64-bit version) or "SETUP.EXE" (32-bit version) and click [Open], and then click [OK].
9. The [User Account Control] window will appear. Click [Allow].
10. The setup program for the driver starts.
11. Click [Uninstall] to select this operation. Select the machine to remove and click [Start].

12. If it is necessary to restart your computer, a window prompting you to restart it will appear. Click [Yes].

13. The uninstallation will be finished after the computer restarts.

(*)

When using the CD-ROM, specify the folder as shown below. (This is assuming your CD-ROM drive is the D drive.)

D: \Drivers\WINX64 (64-bit version)

D: \Drivers\WINX86 (32-bit version)

If you're not using the Roland DG Software Package CD, go to the Roland DG Corporation website (<http://www.rolanddg.com/>) and download the driver for the machine you want to remove, and then specify the folder where you want to extract the downloaded file.

Uninstalling VPanel

When uninstalling VPanel, perform the following procedure.

Windows 10 and 8.1

1. Exit VPanel. (Right-click  (the VPanel icon) in the task tray and select [Exit].)
2. Right-click the [Start] button, and then click [Control Panel]. Click [Uninstall a program] (or [Programs and Features]).
3. Select "VPanel for MDX-50" and click [Uninstall].
4. Follow the on-screen instructions to uninstall the program.

Windows 7

1. Exit VPanel. (Right-click  (the VPanel icon) in the task tray and select [Exit].)
2. From the [Start] menu, click [Control Panel], and then click [Uninstall a program] (or [Programs and Features]).
3. Select "VPanel for MDX-50" and click [Uninstall].
4. Follow the on-screen instructions to uninstall the program.

An Error Message Appears

This section describes the error messages that may appear on the machine's display screen, and how to take action to remedy the problem. If the action described here does not correct the problem or if an error message not described here appears, contact your authorized Roland DG Corp. dealer.

Continue/Abort

For errors in the table that indicate **Continue / Cancel Job**, you can select whether to resume or **Cancel Job** after performing the action for the error. Use the built-in panel to select "Continue" or "Canceled." The product's quality is not guaranteed if you resume cutting.

Error number	Error message (built-in panel)	Cause	Action/procedure
1000-****	% limit switch was not found. (% is "X," "Y," "Z," or "A.") * "A" is only displayed when a rotary axis is connected.	The operation may be inhibited by cutting waste or an obstruction.	<p>Procedure</p> <ol style="list-style-type: none"> ① Turn off the machine's power. ② Remove any objects blocking the operation of the machine and any accumulated cutting waste. ③ Turn on the power, and then resume or stop operation. <p>If the error occurs again after perform the above operations</p> <p>Contact your authorized Roland DG Corp. dealer.</p>
1001-0000	The NVRAM cannot be accessed.	-	<p>Restart the machine.</p> <p>If the error occurs again after perform the above operations</p> <p>Contact your authorized Roland DG Corp. dealer.</p>
1006-****	The % axis position has been shifted. (% is "X," "Y," "Z," or "A.") * "A" is only displayed when a rotary axis is connected.	The cutting conditions may be excessively strict.	<ol style="list-style-type: none"> ① Select "OK" on the built-in panel, and then press [ENTER]. This will clear the error. ② Review the CAM settings and the shape specified in the CAD data.
		The motor position may have been lost.	<ol style="list-style-type: none"> ① Turn off the machine's power. ② Remove any objects blocking the operation of the machine and any accumulated cutting waste. ③ Turn on the power, and then resume operation.
1006-0008	The A-axis unit was connected or disconnected with the power on.	-	Restart the machine.
1017-0000	The cover was opened during the spindle rotating. Continue / Cancel Job	During spindle rotation, the front cover or the dust box cover was opened. (For safety, the machine comes to an emergency stop if a cover is opened while the spindle is rotating.)	Do not open the front cover or the dust box cover while the spindle is rotating. Doing so may affect the cutting results.

Error number	Error message (built-in panel)	Cause	Action/procedure
1018-0000	The chucking sensor was not found.	-	Restart the machine. If the error occurs again after perform the above operations Contact your authorized Roland DG Corp. dealer.
1019-0000	The chucking sensor is in an incorrect status.	-	Restart the machine. If the error occurs again after perform the above operations Contact your authorized Roland DG Corp. dealer.
101A-0000	The chucking motor experienced excessive current.	-	
101B-0000	The chucking motor control circuit experienced excessive current.	-	
101C-0000	The tool sensor was not found.	-	
101D-****	The #% cutter cannot be released. (% is "1" to "6.")	The returning of the tool bur failed. The inside of the collet or the ATC magazine might be dirty.	Procedure ① Select "OK" on the built-in panel, and then press [ENTER]. This will clear the error. ② Remove the tool bur. <small>☞ P. 45 "Operation of the Tool Bur Replacement Function (Auto Tool Changer)"</small> ③ Clean the ATC magazine. <small>☞ P. 31 "Cleaning after Cutting Finishes"</small>
		The collet and tool bur are affixed together and cannot be separated. The inside of the collet might be dirty.	Retighten the collet. <small>☞ P. 37 "Retightening the Collet"</small> If the error occurs again after perform the above operations The collet may be deformed. In this case, replace the collet, and then perform automatic correction.
101E-****	The #% cutter might be broken. (% is "1" to "6.")	The tool bur might be broken.	① Select "OK" on the built-in panel, and then press [ENTER]. This will clear the error. ② If the tool bur is broken, replace it with a new one.
		The cutting conditions may be excessively strict.	Review the CAM settings and the shape specified in the CAD data.
		The collet may have come loose.	Retighten the collet. <small>☞ P. 37 "Retightening the Collet"</small>
		If the error occurs again after perform the above operations The collet may be deformed. In this case, replace the collet, and then perform automatic correction.	

Error number	Error message (built-in panel)	Cause	Action/procedure
101F-****	The #% cutter chucking has slipped out. (% is "1" to "6.")	The cutting conditions may be excessively strict.	<p>Procedure</p> <ol style="list-style-type: none"> ① Select "OK" on the built-in panel, and then press [ENTER]. This will clear the error. ② Review the CAM settings and the shape specified in the CAD data.
		The collet may have come loose.	Retighten the collet. ☞ P. 37 "Retightening the Collet"
		<p>If the error occurs again after perform the above operations</p> The collet may have worn out and its ability to retain the tool bur may have deteriorated. In this case, replace the collet, and then perform automatic correction.	
1020-****	The #% cutter is too long. (% is "1" to "6.")	There is a possibility that the position of the tool holder is not correct.	<p>During cutting</p> <ol style="list-style-type: none"> ① Select "Continue" on the built-in panel, and then press [ENTER]. Cutting will resume. <p>Not during cutting</p> Select "OK" on the built-in panel.
1021-****	The #% cutter is too short. (% is "1" to "6.")		<ol style="list-style-type: none"> ② Replace the tool bur with one of the appropriate length (30 to 80 mm [1.18 to 3.15 in.]). Also check the position of the tool holder. ☞ P. 17 "Loadable Tool Bur Conditions"
1022-****	The #% cutter was not found. (% is "1" to "6.") <p>Continue / Cancel Job</p>	The tool bur has not been set or it may have been mounted on an incorrect stocker number.	<p>During cutting</p> <ol style="list-style-type: none"> ① Select "Continue" on the built-in panel, and then press [ENTER]. Cutting will resume. <p>Not during cutting</p> Select "OK" on the built-in panel, and then press [ENTER]. This will clear the error.
		There is a possibility that the ATC magazine is out of position.	Perform automatic correction. ☞ P. 35 "Correcting the Cutting Machine (Automatic Correction)" <p>If the error occurred during cutting</p> Perform steps ① and ②, close the front cover, and then use the built-in panel to select "Continue." Cutting will resume.
		The collet may have worn out.	Replace the collet, and then perform automatic correction.

Error number	Error message (built-in panel)	Cause	Action/procedure
1023-0000	[Cutting data] The number of the parameters is incorrect. Continue / Cancel Job	There may be a problem with the cutting data received from the computer.	<hr/> <p>Procedure</p> <ol style="list-style-type: none"> ① Select "Canceled" on the built-in panel, and then press [ENTER]. Cutting will be canceled. ② Check the cutting data. <hr/> <p>If There Are No Problems with the Cutting Data</p> <p>Exit any unnecessary programs, and then perform cutting again.</p> <p>If the error occurs again after perform the above operations</p> <p>Restart the computer, and then perform cutting again.</p>
1024-0000	[Cutting data] The parameter is out of range. Continue / Cancel Job		
1025-0000	[Cutting data] A wrong command is detected. Continue / Cancel Job		
1026-0000	[Cutting data] The address is not defined. Continue / Cancel Job		
1027-0000	[Cutting data] The parameter is not defined. Continue / Cancel Job		
1028-0000	[Cutting data] The operation cannot be executed. Continue / Cancel Job		

Error number	Error message (built-in panel)	Cause	Action/procedure
1029-0000	The spindle experienced an overload.		
102A-0000	The spindle experienced overcurrent.	The spindle stopped under a large cutting load or due to a similar cause. The following are likely reasons. • The tool bur is worn. • A workpiece that cannot be cut by the machine is being used. • The cutting conditions are too strict.	① Turn off the power. ② Review the tool bur, the workpiece, the CAM settings, and the shape specified in the cutting data. ③ The motor may have overheated, so wait some time before performing operations again. ④ Turn on the power.
102B-0000	The spindle motor temperature is high.		
102C-0000	A communication error occurred between the spindle control circuit and the motor.		
102D-0000	The spindle can not be turned.	The spindle stopped under a large cutting load or due to a similar cause.	Restart the machine.
102E-0000	The spindle crashed.	-	Procedure ① Restart the machine. ② Review the workpiece, the CAM settings, and the shape specified in the cutting data. ③ Clean away any cutting waste.
1031-****	The error occurred in the control board.	-	Restart the machine.
1036-****	A communication error occurred between the spindle control circuit and the MAIN firmware.	-	Restart the machine. If the error occurs again after perform the above operations Contact your authorized Roland DG Corp. dealer.

Error number	Error message (built-in panel)	Cause	Action/procedure
103B-0000	The automatic correction is not yet finished.	<p>Cutting may have been started without first performing automatic correction.</p> <p>The firmware version may not correspond to the VPanel version.</p>	<p>① Select "OK" on the built-in panel, and then press [ENTER]. This will clear the error.</p> <p>② Perform automatic correction until completion. ☞ P. 35 "Correcting the Cutting Machine (Automatic Correction)"</p> <p>① Update both the firmware and VPanel to their latest versions. ☞ "Setup Guide"</p> <p>② Perform automatic correction until completion. ☞ P. 35 "Correcting the Cutting Machine (Automatic Correction)"</p>
-	You cannot set the origin with the machine coordinate system.	-	<p>Procedure (RML Mode)</p> <p>① Press [COORD. SYSTEM] to switch to the user coordinate system.</p> <p>② Set the origin again.</p> <p>Procedure (NC Mode)</p> <p>Press [COORD. SYSTEM] to switch to the coordinate system for which you want to set the origin.</p>
1044-0000	The automatic setting of Z0 failed.	<p>The following are likely reasons.</p> <ul style="list-style-type: none"> • The Z0 sensor has not been connected. • The Z0 sensor surface is dirty. • The detection pin surface is dirty. 	<p>① Select "OK" on the built-in panel, and then press [ENTER]. This will clear the error.</p> <p>② Connect the Z0 sensor cable again.</p> <p>③ Position the detection pin directly over the Z0 sensor.</p> <p>④ Use the [Z0 SENSE] button to automatically set the Z user origin again.</p>
1045-****	The error occurred during synchronizing the control board.	An error occurred during control board synchronization.	<p>Restart the machine.</p> <p>If the error occurs again after perform the above operations</p> <p>Contact your authorized Roland DG Corp. dealer.</p>
1046-****	The combination of firmware version of the main board and the sub board is invalid.	The combination of main board and sub board firmware versions is invalid.	Update the firmware to its latest version.

Error number	Error message (built-in panel)	Cause	Action/procedure
1047-****	The machine's internal memory cannot be accessed.	-	Select "OK" on the built-in panel, and then press [ENTER]. This will clear the error. * Cutting data can be sent. However, you must not disconnect the USB cable during cutting. If the error occurs again after perform the above operations Contact your authorized Roland DG Corp. dealer
1048-0000	Detected an emergency stop signal from the external input terminal.	-	① Check the status of the device connected to expansion port 2. ↳ "Setup Guide"
			② Restart the machine.
**** _ ****	An unknown error occurred.	-	Restart the machine. If the error occurs again after perform the above operations Contact your authorized Roland DG Corp. dealer.

8. NC Code Specifications

NC Code Specifications	88
List of Settings Related to NC Codes	88
Interpretations When NC Codes Are Omitted.....	89
List of Words Supported by This Machine	90

NC Code Specifications

List of Settings Related to NC Codes

This section lists the settings that can be performed from this machine among the settings related to NC code interpretation and execution. Perform all other settings from the NC program.

☞ "NC Code Reference Manual" (electronic-format manual)

* To configure settings related to NC codes, set the command set to "NC code" or "Automatic switching between RML-1 and NC code."

☞ P. 51 ""Machine" Tab"

Setting	Setting method	Remarks
Numeric value interpretation method	In VPanel, open the "Settings" dialog box, the "NC code setting" dialog box, and then use the [NC code] tab to configure the settings.	Select how to interpret numeric values that have a decimal point and the range of calculator interpretation.
Workpiece origin offset (G54 to G59)	Use the VPanel [Setting Reference Point] to select the target coordinate system, and then set the reference point. However, you can also use G10 and G92 to configure the setting in an NC program.	This setting is related to the workpiece coordinate system origin positions.
EXOFS	<ol style="list-style-type: none"> 1. Set the display of the coordinate system in VPanel to [Machine coordinate system]. 2. Specify the X, Y, and Z coordinate values in the "Moving to an Arbitrary Location" dialog box. 3. Select [EXOFS] for the [Setting Reference Point]. 4. Select [Set X-, Y-, and Z-origins here], and then click [Set]. However, you can also use G10 to configure the setting in an NC program.	
Tool diameter correction values	In VPanel, open the "Settings" dialog box, the "NC code setting" dialog box, and then use the [Tool-diameter offset] tab to configure the settings. However, you can also use G10 to configure the setting in an NC program.	
Tool-diameter offset type (G41 and G42)	In VPanel, open the "Settings" dialog box, the "NC code setting" dialog box, and then use the [NC code] tab to configure the setting.	Select type A or type B.
Optional block skipping (/)	In VPanel, open the "Settings" dialog box, the "NC code setting" dialog box, and then use the [NC code] tab to configure the setting.	Enable or disable optional block skipping.
Overrides	You can set the feeding speed (F) and the spindle speed (S). Use the built-in panel to set these values.	

Items Related to the Machine's Mechanical Specifications

This section describes the NC codes that are dependent on the machine's mechanical specifications.

☞ "NC Code Reference Manual" (electronic-format manual)

Setting	Setting method	
Dimension word	Among dimension words X, Y, Z, and A, only X, Y, and Z are supported as standard. A is supported when the rotary axis unit is attached.	
Data setting (G10)	The ranges for parameter G10 are as follows.	
	<table border="0"> <tr> <td> <ul style="list-style-type: none"> ➤ Parameter: number ➤ Function: Correction number ➤ Acceptable range: 1 to 12 ➤ Valid range: 1 to 12 </td> <td> <ul style="list-style-type: none"> ➤ Parameter: radius ➤ Function: Tool diameter correction values ➤ Acceptable range: Range 1 ➤ Valid range: 0 to 10 mm (0 to 0.3937 in.) </td> </tr> </table>	<ul style="list-style-type: none"> ➤ Parameter: number ➤ Function: Correction number ➤ Acceptable range: 1 to 12 ➤ Valid range: 1 to 12
<ul style="list-style-type: none"> ➤ Parameter: number ➤ Function: Correction number ➤ Acceptable range: 1 to 12 ➤ Valid range: 1 to 12 	<ul style="list-style-type: none"> ➤ Parameter: radius ➤ Function: Tool diameter correction values ➤ Acceptable range: Range 1 ➤ Valid range: 0 to 10 mm (0 to 0.3937 in.) 	
Tool diameter correction (G41 and G42)	<p>The ranges for parameters G41 and G42 are as follows.</p> <ul style="list-style-type: none"> ➤ Parameter: number ➤ Function: Correction number ➤ Acceptable range: 0 to 12 ➤ Valid range: 0 to 12 	
Spindle speed (S)	<p>The ranges for parameter S when a standard spindle is attached are as follows.</p> <ul style="list-style-type: none"> ➤ Parameter: revolution speed ➤ Function: Spindle speed ➤ Acceptable range: Range 2 ➤ Valid range: 4500 to 15000 (rpm specification) 73 to 84 (numeric code specification) 	
Feeding speed (F)	<p>The ranges for parameter F are as follows.</p> <ul style="list-style-type: none"> ➤ Parameter: feed rate ➤ Function: Feeding speed ➤ Acceptable range: Range 1 ➤ Valid range: X and Y axes: 7 to 3600 mm/min (0.3 to 141.7 in./min) Z axis: 7 to 3000 mm/min (0.3 to 118.1 in./min) <p>The feeding speed of the A axis depends on the specifications of the attached rotary axis unit. For details, see the user's manual of the rotary axis unit.</p>	

Interpretations When NC Codes Are Omitted

This machine interprets omitted NC codes as shown below. The ability to interpret omitted NC codes is a characteristic of this machine. If your goal is to create general-purpose programs, you should not omit codes recklessly.

☞ "NC Code Reference Manual" (electronic-format manual)

Setting	Setting method
Unit setting (G20 and G21)	If these codes are not written, input will be interpreted as always being in millimeters (G21).
Tool diameter correction (G41 and G42)	If these codes are not written, the correction value set in the "Tool-diameter offset" dialog box in VPanel will be used.
Workpiece coordinate system (G54 to G59)	If these codes are not written, the workpiece coordinate system will always be interpreted as being workpiece coordinate system 1 (G54).
Dimension (G90 and G91)	If these codes are not written, values will always be interpreted as being absolute values (G90).
Feeding speed (F)	If F is not written, the feeding speed will be 120 mm/min (4.72 in./min).
Spindle speed (S)	If S is not written, the rotation speed displayed on the built-in panel will be used.

List of Words Supported by This Machine

Preparatory Functions (G Functions)

Group name	Word	Function	Continuous function
Positioning/interpolation	G00	Positioning	Modal
	G01	Linear interpolation	
	G02	Clockwise circular interpolation	
	G03	Counterclockwise circular interpolation	
	G04	Dwell	One-shot
	G10	Data setting	One-shot
Plane selection	G17	XY surface selection	Modal
	G18	ZX surface selection	
	G19	YZ surface selection	
Unit specification	G20	Inch input	Modal
	G21	Millimeter input	
	G28	Return to reference point	One-shot
	G39	Corner offset circular interpolation	One-shot
Tool diameter correction	G40	Cancel tool diameter correction	Modal
	G41	Tool diameter correction—left	
	G42	Tool diameter correction—right	
	G53	Movement under Machine Coordinate System	One-shot
Workpiece coordinate system	G54	Workpiece coordinate system 1 selection	Modal
	G55	Workpiece coordinate system 2 selection	
	G56	Workpiece coordinate system 3 selection	
	G57	Workpiece coordinate system 4 selection	
	G58	Workpiece coordinate system 5 selection	
	G59	Workpiece coordinate system 6 selection	
Fixed cycle	G80	Cancel fixed cycle	Modal
	G81	Fixed cycle	
	G82	Fixed cycle	
	G83	Fixed cycle	
	G85	Fixed cycle	
	G86	Fixed cycle	
	G89	Fixed cycle	
Dimension	G90	Absolute	Modal
	G91	Incremental	
	G92	Coordinate system setting	One-shot
Return point	G98	Return to initial level	Modal
	G99	Return to R point level	

G43 / G49 (tool length correction) is not supported. The case of the MDX-50, the tool length correction is performed using the tool length was automatically measured by the tool sensor at the time of tool exchange.

Miscellaneous Functions (M Functions)/Feed Function (F Function)/Spindle Function (S Function)

Word	Function	Function start		Function continuation	
		At the same time as the operation instructed with the block	After the completion of the operation instructed with the block	Retained until cancelled or changed	Valid only within the instructed block
M02	End of program	○			○
M03	Rotate spindle	○		○	
M05	Stop spindle	○		○	
M06	Tool selection	○		○	
M30	End of program	○			○
F	Feed function	○		○	
S	Spindle function	○		○	

Other

Word	Function
A	Dimension word
I	Dimension word
J	Dimension word
K	Dimension word
N	Sequence number
O	Program number
R	Dimension word
T	Stocker number
X	Dimension word
Y	Dimension word
Z	Dimension word
/	Optional block skip
%	Data start/data end
<EOB>	End of block
()	Comment

