

CNC PART PROGRAMMING (MILLING)**PART 1**

Generate manual part program for the part shown in Figure 1 for NUM Flexium 68. The cutting conditions are as follows:

Cutting tool diameter: 12 mm

Spindle speed: 1000 rpm (use M43 S1000)

Note: M43 is used to specify the spindle speed range.

Feedrate: 2.5 mm/sec

The format of the CNC part program should be as follows:

```
%101 (program number)
N001 G79 N010 (unconditional branch to a sequence without return)
N002 X..Y.. (tangent)
X..Y.. (points)
X..Y.. (points)
N003 X..Y..(tangent)
N010 G0 G90 G17 X.. Y.. Z.. (first line template)
Nxx  begin program here (specify feed or feedrate, and use tool T1 for tool ID)
Nxx  .....
      :
      :
Nxx  M02 (last line)
```

For Figure 1, use the spline command for the lower right corner. Input the **spline curve data** between N002 and N003.

The information on spline command is given below:

Spline curve definition syntax (XY plane)

Nxx **G48** NC#y N.. N..

G48 Spline curve definition function.

NC.. Argument defining the curve number.

N.. N.. Numbers of the first and last block defining the points on the curve.

Spline curve execution syntax (XY plane)

N.. **G06** NC..

G06 Function forcing execution of a spline curve.

NC.. Number of the curve to be executed.

Add the comments as necessary (not required). No tool diameter compensation is necessary for this lab. Once program is verified on the Flexium 3D, show the work to TA and get a screenshot.

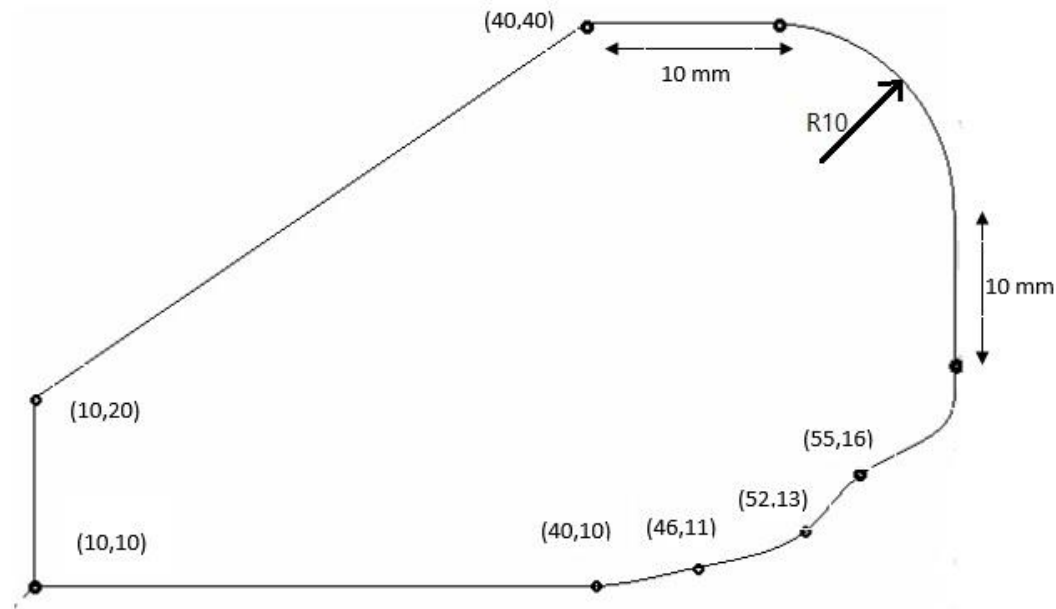

Figure 1. Part 1 schematic

PART 2

Generate a manual part programming for pocket creation as shown in Figure 2 for NUM Flexium 68. The cutting conditions are as follows:

- Cutting tool diameter: 8 mm (Same tool is used for roughing and finishing)
- Spindle speed: 3000 rpm
- Axial roughing feed rate and cutting depth: 100 mm/min, 5mm
- Lateral roughing feed rate and cutting depth: 500 mm/min, 7mm
- Axial finishing feed rate and cutting depth: 70 mm/min, 0.3mm
- Lateral finishing feed rate and cutting depth: 300 mm/min, 0.3mm
- Pocket cutting direction: Counterclockwise
- Coolant on: M08

The format of the CNC part program should be as follows:

```
%55  
N10 G00 G52 X75 Y52 Z70 (Tool has a length of 50mm)  
N20 T01 D01 M06
```

Figure 2 shows the part schematic

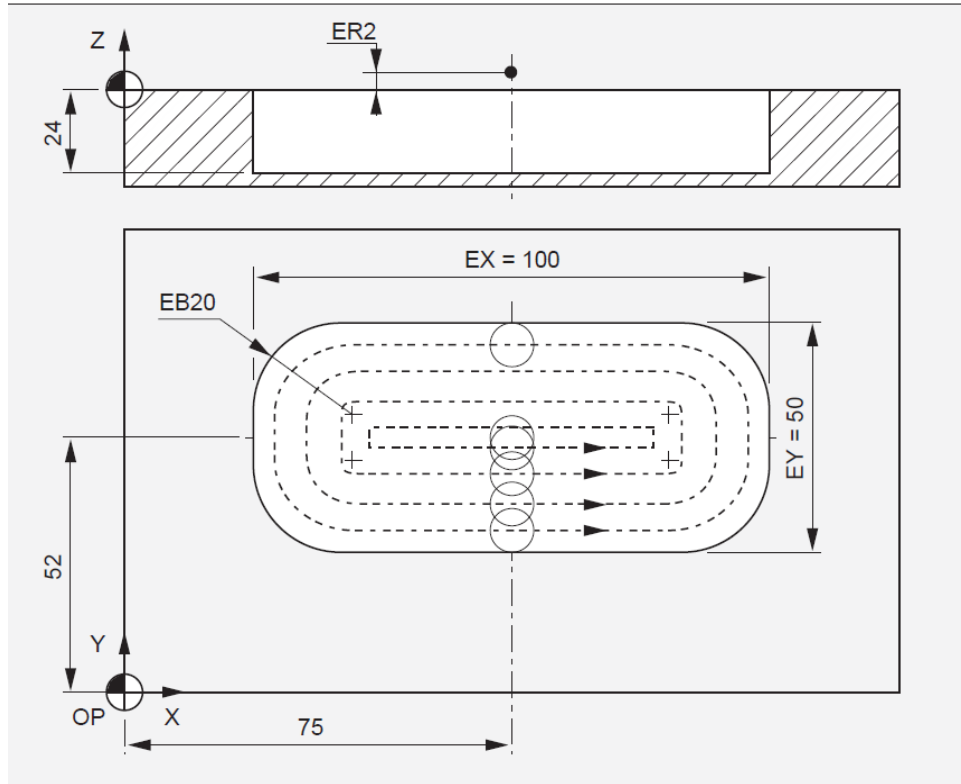

Figure 2. Part 2 schematic

PART 3

Generate a part program using the software “Walli” for the part shown in Figure 3 for the Cybermill CNC milling machine. Once program is completed, simulate the program for verification, and then run the program on the Cybermill using a pen as tool. The “Walli” is available on all four PC’s and does not require the part program number or the header information as in NUM750F.

The home position of the Cybermill is the upper left corner (from your view), positive X and Y directions are to your right and toward you facing the machine. The distance from the tip of the pen (tool) to the top of the paper is 24 mm. Assign (10,70) as the coordinate for position A (lower left corner of the part) and determine the coordinates of remaining points. In addition to tool path programming for the part in Fig. 3, program to print the initials of your name in the lower right corner by using G98 and G99. The information on G98 and G99 is given below:

G00 X# Y# (center location of the engrave): use (170,85)
 G98 X(orientation: use 1) Y(font type: use 1), Z(max. number of characters: leave as blank)
 G99 X, Y (dimensions of the text: use 10, 5), Z (depth of cut: use 3), put the text in REM column.
 G00 X0Y0Z0 (move the tool back to the home position)
 M68 Close the workpiece clamping
 M69 Open the workpiece clamping

Other notes:

- First define G90 or G91 before defining actual tool paths.
- Also note that the Wally system requires relative coordinates for the center position (I and J) of circles when G02 or G03 is used (only for the Wally system).

Once the part is drawn the paper, remove the paper. For further assistance, consult TA.

% The report must contain a cover page, a brief objective of lab, printouts of part programs and corresponding drawings, your discussion and conclusions. The report must be typed.

Home position (0,0)

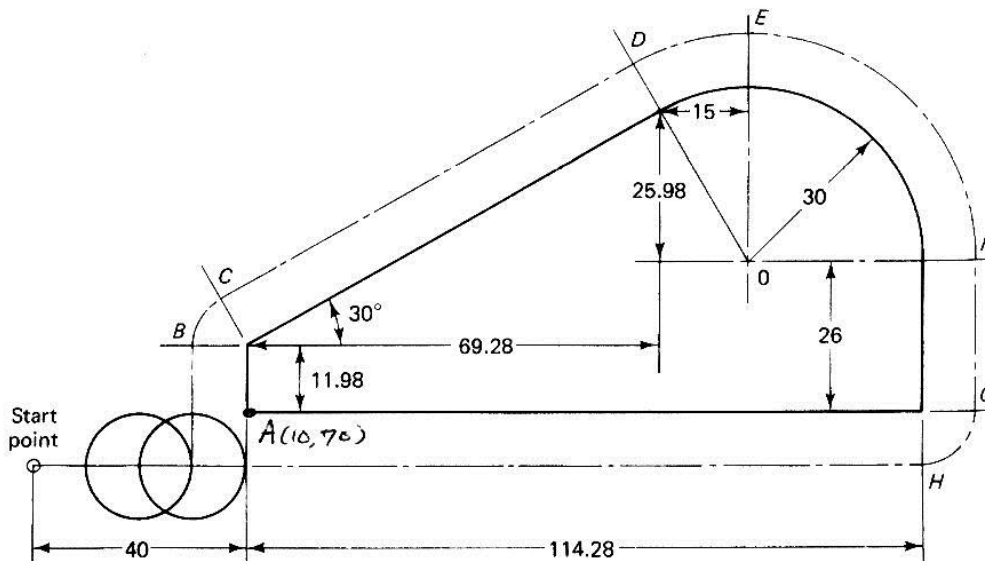
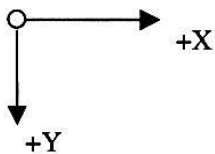

Figure 3. Part 3 schematic

Notes on Pocket cycle

5.14 Simple Pocket Cycle ▶ G45



G45 Simple pocket cycle.

This cycle is used to machine circular, oblong, rectangular and square pockets.

The primary and secondary axes are programmable in absolute dimensions and define the pocket center in the plane and the pocket depth in the tool axis.

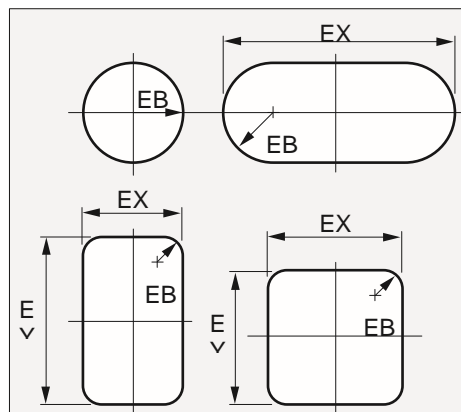

Syntax (XY plane)

N.. [G17] **G45** X.. Y.. Z.. [ER..] EX.. EY.. [EB..] P.. Q.. [I..] [J..] [EG2/EG3] EP.. EQ.. EI.. EJ..

G17	XY plane selection.
G45	Pocket cycle.
X.. Y..	Position of the pocket center.
Z..	Pocket bottom end point
ER..	Retraction plane in the tool axis.
EX..	Pocket dimension on the X or U axis.
EY..	Pocket dimension on the Y or V axis.
EB..	Radius of a circular pocket if EB is programmed alone. Radius of an oblong pocket. Fillet for other pockets.
P..	Axial roughing path.
Q..	Lateral roughing path.
I..	Axial finishing path.
J..	Lateral finishing path.
EG2/EG3	Pocket cutting direction (default EG3)
- EG2:	Clockwise (Conventional milling)

- EG3: Counterclockwise (Climb milling).

EP.. Value of the axial roughing feed rate.
EQ.. Value of the lateral roughing feed rate.
EI.. Value of the axial finishing feed rate.
EJ.. Value of the lateral finishing feed rate.

Properties of the Function

Function G45 is nonmodal. None of the arguments in the cycle are modal.

Cancellation

Function G45 is cancelled at the end of the block.

Notes

When the start of spindle rotation is programmed in the block, it must be placed before function G45 and its arguments.

Example: N.. S1000 M03 M40 G45...

If tool correction D.. is missing when cycle G45 is called, the system returns error message 898.

When the cycle is programmed, the system must be in state G40 (G41 or G42 radius offset cancelled).

When executing a cycle programmed with axial or lateral roughing and/or finishing passes, if only one feed rate (EP, EQ, EI or EJ) is programmed, this feed rate is used as default.

If no:

- axial feed rate (roughing or finishing) is programmed, the system returns error message 892,
- lateral feed rate (roughing or finishing) is programmed, the system returns error message 893.









The cycle calls the axis address equivalence table (see chapter 7.4). Use of the table is incompatible with the cycle call (it is initialised at the beginning of the cycle and restored initialised at the end of the cycle).

In the ZX and YZ planes, the pocket dimension in the Z (or W) axis is programmed by EZ..

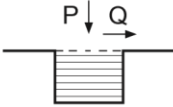
During machining:

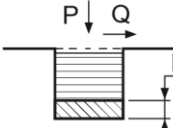
- The cycle cannot be interrupted until the pocket cycle is completed on a depth level (no possibility of mode change).
- The cycle cannot be modified until it has been completely executed.

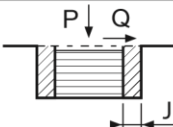
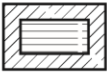
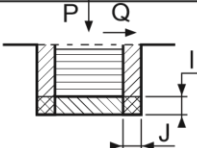
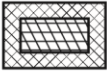
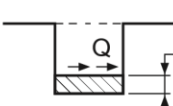
5.14.1 Pass setting possibilities

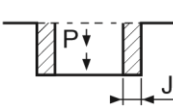
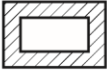
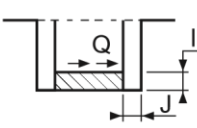
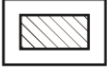
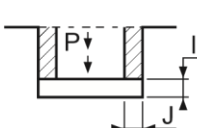
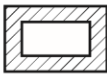
			
		SIDE VIEW	TOP VIEW
P . . Q . . Axial and lateral roughing			
P . . Q . . I . . Axial and lateral roughing and axial finishing of the bottom			
P . . Q . . J . . Axial and lateral roughing and lateral finishing of the sides			
P . . Q . . I . . J . . Sequenced axial and lateral roughing and lateral finishing (for each axial pass setting)			
Q . . I . . Axial finishing of the bottom by value I			
P . . J . . Lateral finishing of the sides by value J			
Q . . I . . J . . Axial and lateral finishing of the bottom up to lateral value J			
P . . I . . J . . Lateral finishing of the sides up to axial value I			

5.14. Roughing and finishing cycle with a single tool

Cycle with axial (P) and lateral (Q) roughing and axial (I) and lateral (J) finishing parameters.

Example:

G45 X.. Y.. Z.. ER.. EX.. EY..

P.. Q.. I.. J.. EP.. EQ.. EI.. EJ..

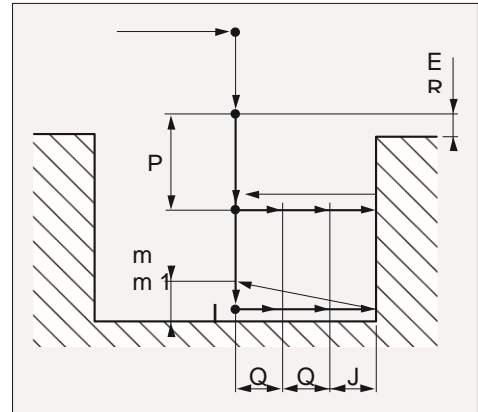

Notes on Cyber Mill

Safety Notes

- Hands should be kept clear of the area while the mill is running or enabled.
- The toggle switch on the right side of the mill “enables” the spindle motor. This toggle switch can also be used as an emergency stop. The spindle will stop if the toggle switch is in the down position.

To Set Up the Cyber Mill

The telephone wire connector should be connected from the RJ45 board, installed in the computer by the microscope to the upper telephone jack on the right side of the mill. The terminator plug needs to be installed in the lower telephone jack.

Starting the Mill

- The power is turned on with the switch on the left side of the mill.
- Once the power is on, the mill will home itself.
- The x, y, and z axes can be moved manually using the controls on the right side of the mill.
- In order to run the spindle through the software, the toggle switch on the right side need to be in the up position.

Walli Software

- The executable file for the software is currently in the D:\walli3 directory. It can be opened by double clicking walli3.exe. In the future, this could be moved to the desktop.
- The demonstration mill programs are stored under the *.ncm extension.
- The Cybermill can be toggled on and off-line in the Run menu.
- If the Cybermill is in the off-line mode the Start CyberMill sequence will draw (simulate) the program in the main window.
 - The key can be used to see the depths of the different cuts. These should be checked for accuracy with the program.
- The file needs to be saved before the changes any changes will become effective. ****The cursor needs to be at the bottom for all changes to be made. A change under the cursor **will not** be saved. The changes should always be verified off-line.**
- The Control Panel function under the Options menu can be used to manually move the x, y, and z axes, start and stop the spindle, and open and closed the vise. The mill can be homed using the Hard Home function under the Mill Calibration menu.
- When the Cybermill is started in the on-line mode the control panel will also appear.
- The program can be aborted from the control panel if desired.
- The status of the execution will be displayed on the control panel.