

Mechanical Design Reliability Handbook: Simplified Approaches and Techniques

Simple Approaches

Simplified Techniques

**A Publication of the Reliability Division
of ASQ**

ISBN 0277-9633 February 2010



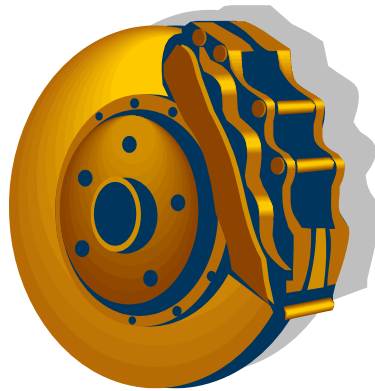

About the Author

James McLinn is a reliability consultant with Rel-Tech Group and an active member of the Reliability Division of ASQ. He holds a CRE, CQE and CMQ/OE from ASQ and has served on the ASQ certification board. He has produced three Monographs, Mechanical Reliability, Accelerated Life testing and Weibull Analysis. All are available from the Reliability Division. Jim presents short courses and training on a variety of topics of reliability which range from Design for Reliability to Preparation for the CRE.

Reliability Division of ASQ

The Reliability Division of ASQ publishes Seven Monographs on Reliability Topics. These include Design for Reliability by Bill Tian, PhD; Develop Reliable Software by Norm Schneiderwind PhD and Sam Keene PhD; Homeland Security and Reliability – Airport Model by Norm Schneiderwind PhD; and Credible Reliability Prediction by Laurence L. George PhD.

Mechanical Design Reliability Handbook: Simplified Approaches and Techniques

by James A. McLinn, CRE, Fellow, ASQ
10644 Ginseng Lane Hanover, Minnesota 55341

Mechanical reliability is one of the sparsely covered areas of reliability. Few comprehensive books exist. Most do not cover the full range of subjects that do exist. Additional references are made to help the reader.

Basic Mechanical Engineering - This includes how to set up and organize basic mechanical engineering. The simple concepts of stress, strain, tension, shear and fatigue are introduced. Extensive equations and complex situations are avoided in favor of simplicity. The stress-load approach is the basis of many of the examples.

Time Dependence - Most examples in reliability are based upon static models where cumulative fatigue is often ignored. Several approaches are shown that permit the inclusion of time into simple models and so show how to model degradation, fatigue or other similar dynamic situations. Coffin-Manson, cyclic stresses and other models are presented.

Accelerated Life - Mechanical reliability situations often involve difficult or hard to accelerate materials or systems. This short book shows some of the problems and solutions for these situations.

Non-Normal Distributions - Many situations arise where one or more of the strength or load distributions are non-normal. Weibull, lognormal, extreme value are all possibilities. This often changes the analysis and results.

Miner's Rule - This basic model is presented as well as limits. This simple model is one of the approaches for covering a dynamic spectrum of stresses.

Confidence Limits - Learn several simple approaches for establishing confidence limits on reliability data.

Costs - A short addendum on costs related to projects is included in this book. This critical topic is often left out in most books.

Reliability Prediction - An extensive example of how to make a prediction is shown. This includes bottom up approaches and the use of standard books.

Copyright Advisory – Copyright is held by the Reliability Division of ASQ. Abstracting is permitted with credit to source. No reprint or circulation is allowed without specific permission. Contact Monograph editor. Second Edition February, 2010

Preface - Second Edition

Updated and Improved

This first edition of this monograph created a lot of interest in mechanical reliability topics. While the world is primarily electronic, all of the packages, circuit boards, enclosures, housing are mechanical. These primarily serve to protect and support the electronics within. As semiconductor die shrink and simultaneously increase in power, operate at Gigahertz frequencies the packaging becomes a bigger and bigger issue. Heat conduction, cooling, high frequency termination, compatibility with lead free solder, and ability to remain firmly attached to circuit boards is an increasing challenge. Since the original monograph in 1998, MEMS technology and a host of small scale devices have made an understanding of mechanical reliability more important. Every quality engineer, manufacturing engineer, reliability engineer and project manager should be familiar with more of these topics, if only at a basic level. Material properties, magneto-striction, thin films, seals, corrosion, wear out, implantable devices and sensors combined with quantum effects will dominate the next 10 years of reliability.

This monograph will remain short, simple and to the point for all of its examples. This makes it easy to follow for quality and reliability engineers. No prior extensive mechanical or reliability knowledge is assumed. The use of statistics remains at a minimum and the background formulas shown where it would be useful to the reader. A wide variety of simple and useful examples are shown in the text. The author has presented a much longer reference list and a number of web sources for those topics that might be of interest to the practical reliability engineer. Excessive use of statistical tools has been avoided because most engineers find the language of statistics to be foreign and often obscures the engineering. There are plenty of statistics books on the market, if that is the desire of the reader.

The first edition contained the following promise. It is still true of the second edition.

This short monograph is in no way complete. So many more topics do exist that could be covered in greater detail. Some of these topics will be presented in a future edition.

James McLinn CRE, Fellow ASQ
Hanover, Minnesota
February 2010

Preface - First Edition

This monograph was initially created out of response for the desire for a simple, introductory group of mechanical reliability topics. It began as a series of five articles in *Reliability Review*. When begun there were only two available texts. Both were primarily theoretical and written for a one quarter college course. This monograph will be found to be short, simple and to the point for most reliability and quality engineers. No prior extensive mechanical or reliability knowledge is assumed. The use of statistics is kept to a minimum and the background formulas shown where it would be useful to the reader. A wide variety of simple and useful examples are shown in the text. The author has presented a much longer reading list and a number of other sources for those topics that might be of interest to the practical reliability engineer. Excessive use of or dependence on statistical tools has been avoided because most engineers find the language of statistics to be foreign and often obscures the engineering or business point being studied. Enjoy this, show it to your co-workers and when you are ready move beyond it to the bigger books and texts that provide many more details. A reading list exists at the end for additional related topics. These are primarily from recent journals.

The author also wishes to thank the many people who reviewed this work in its various iterations and provided helpful comments. Many called to ask about the series, commented about the examples and provided insight to improving them.

This short monograph is in no way complete. So many more topics do exist that could be covered in greater detail. Some of these will be presented in a future edition.

James McLinn
Hanover, Minnesota
June 1998

Table of Contents

Area and Topic	Page Number
Section 1.0 Simple Approaches to Common Design Problems	1
Section 1.1 General Groupings of Reliability Problems	3
Section 1.2 Reliability Definitions	4
Section 1.3 Types of Applied Loads	5
Section 1.4 Basic Mechanical Engineering	8
Example 1.1 Truncated Cone	9
Example 1.2 The Bronze Bushing	10
Example 1.3 Different Diameter Columns	12
Section 1.5 Shear Stress	14
Example 1.4 The Yield Angle	15
Example 1.5 Stress in a Spring	16
Example 1.6 The Active Spring	18
Example 1.7 Spring Force Constant	18
Example 1.8 Spring Steel Wire	19
Section 1.6 Structural Examples	19
Example 1.9 A Beam with Two Stresses	19
Section 1.7 Single Force on a Beam	21
Example 1.10 Beam Deflection	21
Example 1.11 A Uniform Load	21
Section 1.8 A Reliability Model, Stress Load	22
Section 2.0 Dynamic Examples	25
Section 2.1 A Stepper Motor	25
Example 2.1 Repetitive Cyclic Stresses	26
Example 2.2 Minimum Driving Force	26
Section 2.2 Simple Time Dependence	27
Example 2.3 Dynamic Time Dependence	27
Example 2.4 More Dynamic Reliability	27
Section 2.3 Calculating Minimum Zero Time Force	29
Example 2.5 Slow Degradation	29
Example 2.6 Alternative Slow Degradation	29
Section 2.4 The Importance of Degradation	30
Section 3.0 Dynamic Degradation	31
Example 3.1 Dynamic Degradation in Reliability Models	31
Example 3.2 Alternate Standard Deviation	32
Section 3.1 Cyclic Stress and Fatigue	32
Example 3.3 Miner's Rule and Accumulated Fatigue	32
Example 3.4 A Simple Application of Miner's Rule	33
Example 3.5 The S-N curve	35
Section 3.2 Reduction of Random Stresses	37
Section 3.3 Confidence limits on S-N	39
Example 3.6 Confidence Limits Calculations	39
Section 3.4 Interference when Distributions are Non-Normal	40
Example 3.7 Interference of a Normal and Weibull Distribution	40
Example 3.8 Approximation by Equivalent Distributions	42
Example 3.9 An Improved Approximation	43

Section 4.0 Mechanical Reliability Prediction	45
Section 4.1 Background of Predictions	45
Example 4.1 A Motor Reliability Model	45
Example 4.2 Consideration of Wear	47
Example 4.3 Dynamic Hazard Rate Curve	48
Section 4.2 The Carderock Models of Mechanical Reliability	48
Example 4.3 A Coil Spring	49
Example 4.4 Hard Drawn Steel Spring	50
Example 4.5 A Roller Bearing	51
Example 4.6 Ball Bearing	51
Example 4.7 Reliability Calculations from First Principles	52
Example 4.8 Minimum Applied Stress	53
Example 4.9 Simple Reliability Model	55
Example 4.10 Total Mechanical System	55
Example 4.11 A Non-Constant Model	56
Section 5.0 Confidence Intervals in Mechanical Reliability	59
Section 5.1 Calculating Confidence	59
Example 5.1 Confidence on the Deflection of a Beam	59
Example 5.2 Tchebyshev's Approach to Uncertainty	61
Example 5.3 Gauss' Inequality	63
Example 5.4 Cam-Meidell Approach	64
Example 5.5 Trivial Confidence Bounds	65
Example 5.6 Improved Cut Set Confidence Bounds	66
Example 5.7 More Complex Confidence Bounds	67
Example 5.8 The F Distribution for Confidence	69
Example 5.9 Traditional Chi-Square Distribution	70
Section 5.2 Accelerated Testing Examples	71
Example 5.10 Simple Acceleration of a Mechanical System	71
Example 5.11 Alternate Accelerations and Wear Rates	72
Section 5.3 Mechanical Materials Acceleration	72
Section 5.3.1 Mechanical Models that Describe Reliability	73
Section 5.3.2 Stress-Life Relationships	74
Section 5.3.3 Arrhenius, Power Law or Eyring	75
Section 5.4 Discrete Mechanical Systems	76
Example 5.12 A Weakest Link in a Discrete Parallel System	76
Example 5.13 Estimating Confidence Limits for a Discrete Situation	79
Bibliography and References	80
Appendix Cost and Project Issues	81

Table of Figures

Description of the figure	Page Number
Figure 1.1 The Stress-Strain Curve	7
Figure 1.2 The Truncated cone	9
Figure 1.3 Stress in a Cone and Column	10
Figure 1.4 A Combination Shaft	11
Figure 1.5 The Tapered Shaft	13
Figure 1.6 Shear Forces in Material	14
Figure 1.7 External Twist on a Column	16
Figure 1.8 The Helical Spring	18
Figure 1.9 Stress Distribution in a Beam	20
Figure 1.10 Free End of a Beam	21
Figure 1.11 A Uniform Load	22
Figure 1.12 The Stress-Load model	23
Figure 2.1 The Simple Stepper Motor	25
Figure 2.2 Simple Time Dependence of Reliability	28
Figure 3.1 A Stress-Load Degradation Model	31
Figure 3.2 A Summary of Stresses in a Three Day Period	34
Figure 3.3 Crack Propagation in a Large Plane	36
Figure 3.4 The S-N curve	37
Figure 3.5 Summary of Irregular Loads	37
Figure 3.6 Simple Time Listing of Stresses	38
Figure 3.7 Confidence Limits on the S-N curve	40
Figure 3.8 Cyclic Stresses in an Aluminum Bar	41
Figure 3.9 Interference of a Normal and Weibull Distribution	41
Figure 3.10 An Equivalent Normal Distribution	43
Figure 3.11 An Improved Normal Distribution	44
Figure 4.1 A Mechanical Bathtub model	46
Figure 4.2 Spliced Early Portion of the Bathtub	47
Figure 4.3 Dynamic Hazard Rate Curve	48
Figure 4.4 Aluminum Faucet Adaptor	52
Figure 4.5 Actuator Example	54
Figure 4.6 Water System Failure Rate Curve	57
Figure 5.1 Deflection of a Wide Beam under Load	59
Figure 5.2 – The Probability Plot of a Position Indicator	62
Figure 5.3 Gauss' Inequality	63
Figure 5.4 Camp-Meidell Model	64
Figure 5.5 A Simple System	66
Figure 5.6 Cut Sets and Tie Sets	67
Figure 5.7 A Complex System	68
Figures 5.8A and 5.8B Decomposition of a Complex System	68
Figure 5.9 Slow Wear of the Mechanical Bathtub	73
Figure 5.10 Dual Stress-Life Relationship	74
Figure 5.11 Discrete Stress-Load Example	77
Figure 5.12 Distribution of Strength-Load	78

Appendix

Figure A1 The Eight Dynamics of a Development Project	85
Figure A2 The Development Failure Breakdown Observed on System A	86
Figure A3 The Development Failure Breakdown Observed on System B	86
Figure A4 First Year Field Data from System A	88
Figure A5 First Year Field Data from System B	88
Figure A6 Second Year Field Data from System A	89
Figure A7 Performance of Successive Lots	90

List of Tables

Table Number	Topic	Page
Table 1.1	Modern Mechanical Reliability Applications	2
Table 1.2	Top Twelve list of Mechanical Reliability Problems	6
Table 1.3	Basic Properties of Common Materials	8
Table 3.1	A Summary of High Stresses	34
Table 3.2	Summary of Irregular Loads	37
Table 3.3	Characteristics of a Round Bar	41
Table 4.1	Data for Bathtub Curve	48
Table 4.2	Summary of Component Failure Rate Information	56
Table 5.1	Summary of Discrete Stress and Load	78

Appendix

Table A1	List of Typical Levels of Failure	83
Table A2	U.L. Definitions of Critical Components	83
Table A3	Typical Costs associated with System A	91

Appendix References	92
----------------------------	-----------

Mechanical Design - Reliability Primer

1.0 Simple Approaches to Common Problems of Design, Manufacture and Field Situations

Modern reliability tools and techniques have developed primarily 30 to 50 years ago. Reliability books in the last 30 years have been primarily devoted to the evolving electronic industry. This situation is highly ironic for mechanical reliability applications have been around over 5000 years. This ancient knowledge formed the basis for much of the well recognized modern electronic applications. The oldest reliability references can be found on ancient Sumerian clay tablets from about 2500 BC [1]. They stated that houses were to meet minimum structural standards and could not fall down upon the occupants under penalty of death of the builder. This millennium (3000 to 2000 BC) seemed to be part of a world wide building boom. Stonehenge, many pyramids and a variety of smaller structures sprang up all over the world. These structures seem to represent attempts to create lasting monuments. This wasn't done in a vacuum. The larger pyramids such as at Giza have smaller and older, practice pyramids nearby. The Egyptians slowly learned the basic engineering principles and then expanded them over hundreds of years. The Romans also had a desire to build lasting structures. They expanded the older Mesopotamian knowledge of water movement by expanding and improving aqueducts and arch bridges. The Romans are best known for lasting roads, many buildings, the Coliseum and a variety of structures during their *Pax Romana*. Many of these now ancient structures still exist in working order. Other cultures also shared in the lust to build lasting structures in stone. These include Stonehenge in England, the Parthenon in Athens and the massive stone temples and cities of the Inca world.

All of the structural (mechanical reliability) principles in use from the ancient times were based upon slowly gained knowledge of materials, geometry, structures and included anticipated aging of these structures. The plane, fulcrum, Archimedes screw, early concepts of tension versus shear all were in use. Simple mathematical models probably existed for some of the structures, but it is not clear how detailed these models might have been. What exactly does this have to do with modern mechanical reliability? Many of the *modern mechanical reliability applications* that cover materials and common structures are very similar to the knowledge gained from the past. Today, plastics, steels and aluminum have replaced wood, stone, copper and iron, but the application principals have changed very little. We benefit today by the wealth of reliability models and the development of advanced mathematics that describe complex situations. These permit descriptions of a variety of different potential applications. A short review of history has shown that these principles were preserved and came to fruition again at the end of the dark ages with the building of large churches, castles and cities. These set the stage for more modern structures. Eventually schools of architecture were founded and the subject taught in the university by the late 1600s. Christopher Wren was perhaps the most famous architect of that time. He built a number of famous structures and rebuilt older ones. Some of these older structures, such as the 400 foot cathedral spire at Salisbury England had begun sagging after only 300 years. His solution was simple, encase the four support columns with strategically placed metal bands. The necessary knowledge of tension, shear and torque were all required for this simple solution implemented in the 1670s. Many other people of the past have contributed to the knowledge we employ today. These include mathematicians such as Poisson, Gauss, Cardan, De Moivre, Abbe and von Neumann. Additionally, people such as Newton, Hooke and Weibull have contributed material studies. The approaches of the recent past are very similar to those faced by modern mechanical engineers and reliability people. The main difference is the availability of more complex models and the ready use of modern computers.

The following table is a short (modern) summation of some basic important approaches employed in many common modern situations. These are grouped by basic approach and are tied to specific applications of specific reliability tools and approaches. Later, sections of this book will provide specific examples tying tools, applications and simple statistical models that enhance reliability estimation. Basic engineering principles and models are also shown. This book will cover only some of these approaches. Simple principles can go a long way to providing reasonably accurate answers in most situations.

Table 1.1 - Modern Mechanical Reliability Applications

Static Applications with Constant Stress		Dynamic Applications & Stresses	
- Tension, Shear, Torsion, and Degradation corrosion involved		Variable, Full Reversing or Irregular stresses in place	
Structures	Materials	Structures	Historically Based Situations

The following list of more specific mechanical reliability applications can be placed under one or more of these broad categories above.

1. **Stress-Load** analysis (interference) both static and dynamic situations.
2. Modeling with **distributions** covering common and infrequent events.
3. **Probability estimates** - Tchebycheff's, Gauss's or Camp-Meidell methods covering non-parametric and non-symmetrical probability distribution situations.
4. First principle modeling and **physics of failure** (PoF) approaches.
5. Coefficient of variation.
6. Part or function table information - a list of common failure modes and causes.
7. Dynamic multiple cyclic loads with **Miner's Rule**.
8. Full **reversing load** situations.
9. Dynamic variable and irregular loads with reduction to equivalent cyclic stress.
10. **Monte Carlo** simulation or other simulation methods.
11. System reliability modeling.
12. Finite Element Analysis - **FEA**.
13. Failure Mode and Effects Analysis - **FMEA**.
14. Hazard Analysis – **HA** or Health and Hazard Analysis - **HHA**.
15. Fault Tree Analysis - **FTA**.
16. Approaches employing the concept of **entropy** or system disorder.
17. Materials limits and material **fatigue** concepts.
18. Possibility of chemical attack, chemical degradation, galvanic action or "stiction".

1.1 General Grouping of Mechanical Reliability Problems

Approaches to Mechanical Reliability take a number of different avenues. This is because there are so many different mechanical functions possible. These include a variety of structural problems from the construction of buildings, bridges and dams to simple metal chassis as used to protect electronics. In more common mechanical reliability analyses we look at the stiffness and strength of materials such as ceramics, fiberglass, iron and steel. Our analysis also considers the lubrication of metal surfaces. The variety of applications of mechanical functions can be grouped into similar approaches. Some approaches may be grouped as follows. This list expands some of the entries in Table I.

1. The types of mechanical functions required. These may vary from static to dynamic situations. These dynamic may be broken down into several different dynamic applications.

2. The range of stress of the mechanical part, material or system. We need to identify if the stresses are close to the ultimate tensile strength or any other "plastic limits" of the material. If below the plastic limit, we might often model these with simple elastic models.

3. Material fatigue may be an important issue to consider when accumulative fatigue or degradation begins to become important. Fracture mechanics are important in some high stress or high reliability applications.

4. Situations where the stresses are continuous in time or strength, cyclic in time or strength or semi-periodic or irregular in time or strength. Continuous forces, shear forces or pressures are more easily handled than cyclic, periodic or reversing forces. The hardest situations are irregular or unpredictable forces. In many situations we can lump forces into "equivalent groups" or reduce forces to their equivalents.

5. Variability of the forces. Can a stable mean force (or result) be identified? Is the variation about the mean value also stable over time or samples? Can the variation be described or approximated by the Normal distribution, LogNormal or Weibull. In these situations we have statistical results, not straight forward cause and effect results.

6. Identify the potential failure modes of a component, material, function or system and ultimately the root causes of failures. Knowing these can be much more important for mechanical situations than for electronic parts and systems. Knowledge of the causes usually leads directly to knowledge of improvements and preventative actions.

7. The Failure Mode Effects Analysis may be a good approach for looking at potential causes of system failures because there are often a small number of failure modes for many mechanical systems, functions, materials or parts. Many of these failure modes are tied closely to the way a part, material, function or system is employed (application) or to the material and/or geometry present.

8. Possibility of chemical attack, galvanic action, "stiction", dendritic growth, corrosion, oxidation and a variety of degradation modes exist. Each of these need to be considered as a root cause of an eventual mechanical failure.

9. "Reduction to first principles" is a common mechanical approach. This approach is another way of writing down what you know, use basic engineering or physics principles and write a simple equation.

10. Application of common accelerated life test methods for mechanical parts, materials, functions and systems. The problem is that many of the stress factors are either very low or very high. In either case it is often very difficult to identify and set up a good reasonably short accelerated life test. Consideration of multiple overstress tests or step-stress approaches will be provided.

1.2 Mechanical Reliability Definitions

Typically this area breaks into two types of reliability problems.

* **Mechanical parts** - such as switches, relays, bearings etc. that are wear out dependent. This is an application of many repetitive actions with minor wear at each cycle. We typically estimate life or run tests to ensure reliability of a distribution.

* **Structural situations** - Often thought of as a civil engineering situation. A material with a basic strength is expected to withstand the accumulation of stresses over time. Analysis of these situations works for housings, enclosures, buildings, bridges, dams etc. Some reliability problems for parts or systems may also fall into this category.

Definitions needed for Mechanical Reliability

Material - A collection of defects.

Acceptable Material - A fortuitous or organized collection of defects in a material. The material is characterized by having a long time to failure.

Unacceptable Material - An unfortunate and disorganized collection of defects. The material is characterized by have a short time to failure.

A variety of recurrent mechanical problems are listed in Table 1.2. These are based upon experiences over 25 years. Not all mechanical applications have the same requirements, so it would not be surprising if a biomedical application had a different requirement than a consumer one.

Table 1.2 - Top Twelve list of Mechanical Reliability Problems

1. Always assume the worst will eventually happen. This applies especially to critical parts and assemblies. Know what is critical especially to the use and customers. What are the critical parts? How will the customer abuse the assembly?

2. Always check for tolerance stack up problems. Parts in tolerance today may not be in the future. Don't assume stability from the suppliers or that wear can not occur. Most of the time we do not know the relationship between being in specification and the ultimate reliability. A DOE (Design of Experiments) would help here.

3. Metal inserts in plastic parts are hard to mold well. This may lead to problems in use because of residual stress and will eventually cause problems through tool wear and/or part cracking.

4. Always maximize the radii that are present. Small radii lead to high stress concentrations and failure prone places. Harden these areas or use harder metals where possible when the radii can not be increased.

5. Use as few connections as possible. This includes connectors, wire connections such as welds or solder joints, crimps and material connections and seals. Remember all connections are potentially weak points that will fail given time and stress.

6. All seals fail given time and stress. You need at least two levels of sealing to ensure the product will last as long as the customer expects. Remember that some materials diffuse through others. Perhaps three levels of seal are required.

7. Threads on bolts and screws shouldn't carry shear loads. Remember they need preloads and/or stretches to ensure proper loading initially. Metal stretches, fractures and corrodes as well as developing high stress concentrations in use under tension. Be sure to allow for this.

8. Use as few nuts, bolts and screws as possible. While these are convenient temporary connection methods, it is 100 year old technology. Lock washers and locktite have been developed to slow down the rate of loosening. All will eventually come loose anyway when there is stress, temperature or vibration present.

9. Belts and chains will stretch and/or slip when use to deliver power. Remember these types of parts need constant tension devices to aid their reliability. Again this is old technology that can be made reliable by careful application. (Note, this is one of the biggest field problem with snow-throwers.)

10. Avoid set screws as these easily come loose because of their small sizes. Even when used on a flat, set screws are only "temporary connection" mechanisms. Locktite only makes "the temporary" a little longer in the presence of stress.

11. Watch the use of metal arms to carry loads. They often deflect in an imperceptible manner. This is especially true when loads are dynamic.

12. Integrate as many mechanical functions as possible. Use as few separate and distinct mechanical parts that are joined as possible. Joints are usually unreliable.

Each of these common mechanical design problems is used in common "every day life" situations where 10% failures per year might be acceptable or near the limit of technology (washing machines, other appliances, many instruments and even some cars). The same standard designs will not work well in high reliability applications where only 1 or 2% failures per year are desired or acceptable (aerospace, military, medical devices etc.). Remember the difference between the two applications when designing.

1.3 - Types of Applied Loads, Stresses and Material Response

Almost all situations of mechanical engineering may be reduced to four basic classes of applied loads. The applied loads may in turn be described through internal stresses or even material strain. These stresses may be simply described as:

- 1) Compression
- 2) Tension
- 3) Shear
- 4) Torsion

All other internal stresses may be made up of combinations of these stresses be they static or dynamic situations. The material reliability may be measured through strength or durability concepts that include the following:

- 1) The *capacity* to withstand a static load over a specified time and stated environmental conditions.
- 2) The *resistance* to permanent internal or external deformation or damage resultant from by a one-time high load.
- 3) The *toughness* of a material under a shock load or an impact type test.
- 4) The measure of the *life* of a material when subjected to cyclic loads or fatigue.
- 5) The *material behavior* exhibited at high or low temperature, including cracking creep or induced internal stress.

As a rule, the applied loads are typically thought to be reflected as simple tension or compression. This not need be so. The loads may lead to shear or torsion stresses in addition to tension or compression. In the latter cases the details become more complex, but the basic approach remains the same. The model of the material response may vary as do the applied loads. The following description, as well as Figures 1.1a and Figure 1.1b, provides a generic, first-order relationship for a variety of materials.

In tension or compression testing, typically two distinct phases or different material responses may be identified. Figure 1.1a shows these as elastic and plastic ranges for two very different types of materials. The relationship of the stress, σ , to the response strain, ϵ , is through constant, E when in the elastic range. This simple expression is similar to Hooke's Law and applies for simple tension and compression with a similar simple relationship for shear and torsion. Typical mathematical equations for tension and compression are:

$$\text{Elastic Materials} \quad \sigma = E \epsilon \quad (1.1a)$$

$$\text{Plastic Materials} \quad \sigma = \sigma_0 \epsilon^m \quad (1.1b)$$

Equation 1.1a is a reasonable approximation for the elastic portion of the Stress-Strain relationship for many brittle and ductile materials. The constant slope in Figure 1.1a is labeled E, called Young's Modulus or the **Modulus of Elasticity**. At higher levels of stress, near the beginning of the plastic range the stress-strain relationship changes in a complex fashion as shown in Figure 1.1a and Figure 1.1b. Figure 1.1b is simple enough that Equation 1.1b models this plastic behavior for Titanium. The border of the plastic region in Figure 1.1a is identified by the term **yield stress**, σ_y , which is a significant measure of many materials.

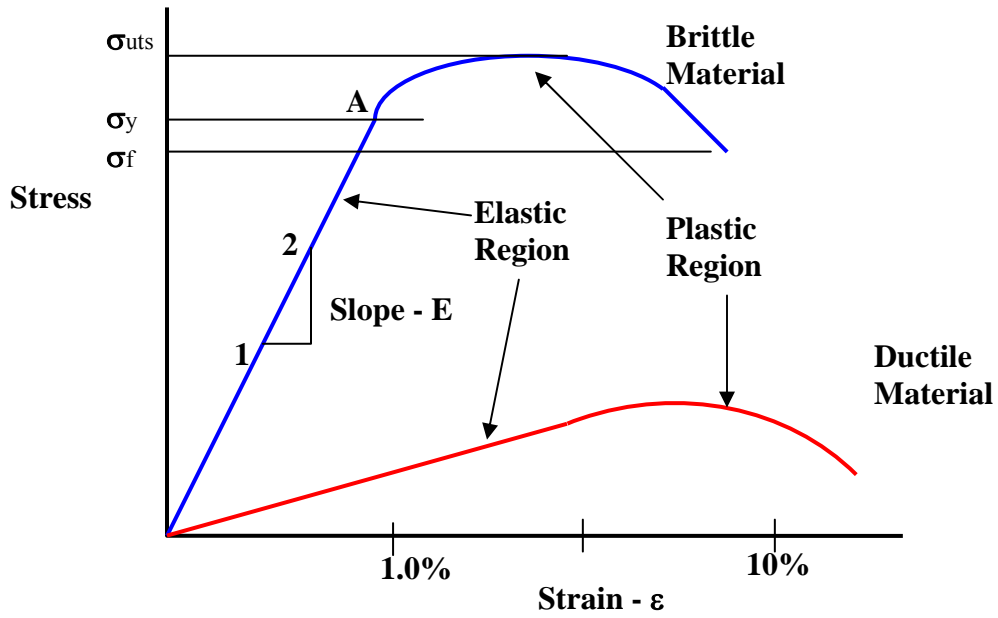

Figure 1.1a - The Stress-Strain Diagram

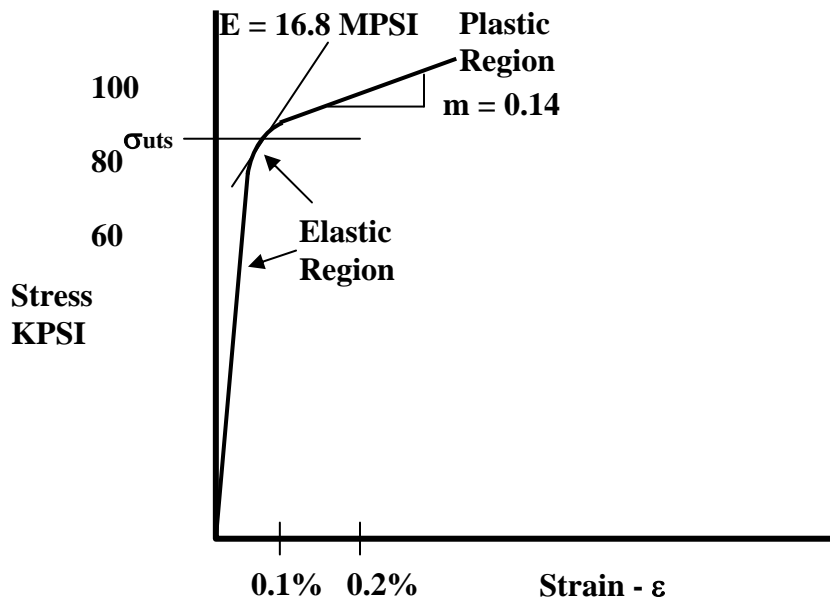

Figure 1.1b - An Alternate Stress-Strain Diagram for Annealed, A40 Titanium

1.4 Basic Principles of Mechanical Engineering

The following simple equations on the next several pages form the basis of most mechanical engineering and mechanical reliability analyses. These equations assume that materials can be described as homogeneous and elastic. To first approximations this works for a variety of different materials; therefore many mechanical situations can be described by Hooke's Law (Robert Hooke, 1635-1703). This simple model describes the elastic, homogeneous and simple linear behavior of many materials such as plastics, metals, fiberglass, ceramics and composites. With the simple Hooke's Law combined with basic physics, we can relate generalized Stress (**S**) with the Pressure (**P**) across an applied Area (**A**), with length **L** and change of length ΔL as follows.

$$\text{Stress} = \mathbf{S} = \frac{P}{A} = \frac{E\Delta L}{L} = \mathbf{E}\boldsymbol{\epsilon} \quad (1.2)$$

Where ΔL represents a change in length, due to the stress and the $\frac{\Delta L}{L}$ measures the change per unit length or the "strain" (**epsilon- ϵ**). The E is Young's Modulus (**the modulus of elasticity**) and is treated as a constant for a material and uniform in all axes. Many common materials have a range of elastic behavior that can be used to estimate the material response to applied stress. A few simple materials are shown below.

Table 1.3 – Basic Properties of Common Materials

Material	Young's Modulus - E
many steels	$E_s = 30 \times 10^6 \text{ lbs./in.}^2$ or PSI
many cast irons	$E_{ic} = 20 \times 10^6 \text{ lbs./in.}^2$ or PSI
Bronze	$E_B = 12 \times 10^6 \text{ lbs./in.}^2$ or PSI
Brass	$E_{Br} = 15 \times 10^6 \text{ lbs./in.}^2$ or PSI
Aluminum	$E_{Al} = 3.9 \times 10^6 \text{ lbs./in.}^2$ or PSI
concrete	$E_{cr} = 3 \times 10^6 \text{ lbs./in.}^2$ or PSI
many woods	$E_w = 1 \times 10^6 \text{ lbs./in.}^2$ or PSI

Most material can change length only 0.001 to 0.002 (0.1 to 0.2%) per unit length before inelastic behavior or permanent damage begins to occur. Therefore, we can estimate the yield strength from the following relationship.

Yield Strength = $E (\Delta L) = 30 \times 10^6 \text{ lbs./in.}^2 (0.001) = 30,000 \times 10^6 \text{ lbs./in.}^2$ for many irons and steels. Above this number the material may not remain in the elastic region.

When the cross section of any material varies as a function of a dimension, we rewrite the basic relationship shown in (1.2) as an integral. This becomes simply:

$$\Delta L = \frac{PL}{AE} = \frac{P}{E} \int_0^L \frac{dx}{A} \quad (1.3)$$

Thus, we can calculate ΔL for variable cross sections when a pressure P or stress is applied to a material along the axis described by L with the changing cross section perpendicular to the axis. The axis of symmetry is key in this example.

Example 1.1 – Let $r_x = r_1 + \frac{x}{L}(r_2 - r_1)$ represent the position relationship as shown in Figure 1.2.

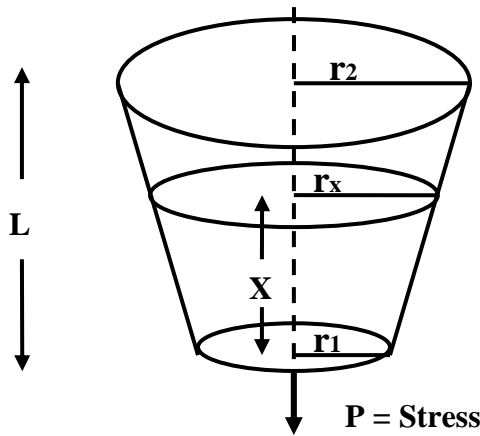

Figure 1.2 - A Truncated Cone

Assumptions -

- A) Equation 1.3 applies.
- B) The applied stress is along one axis only.
- C) Second order material effects will be ignored.

Solving this integral for a truncated cone yields with $A_x = \pi r_x^2$ at any point x, along the cone.

$$\Delta L = \frac{P}{\pi(E)} \int_0^L \frac{dx}{r^2} = \frac{P}{\pi(E)} \left(\frac{L}{r_2 - r_1} \right) \left(\frac{1}{r_1} - \frac{1}{r_2} \right) = \frac{P}{\pi(E)r_1r_2} \quad (1.4)$$

This general result reduces to the standard relationship for a column when $r_1 = r_2$. For the case of a true cone, with $r_1 = 0$, then the elongation becomes infinitely large.

The unit elongation becomes $\frac{\Delta L}{L} = \frac{P}{\pi(E)r_1r_2}$ under the stress, P, of 10,000 lbs. applied to a common steel cone that has dimensions of $r_1 = 1.5$ in. and $r_2 = 3.0$ in. This becomes for these dimensions:

$$\frac{\Delta L}{L} = \frac{P}{\pi(E)r_1r_2} = \frac{10,000 \text{ lbs}}{(3.1416)(30,000,000 \text{ PSI})(1.5 \text{ in.})(3.0 \text{ in.})} = 0.000,023,6$$

or
$$\frac{\Delta L}{L} = 23.6 \text{ PPM}$$

This figure represents the temporary elongation of the material due to the applied external stress. It is so small, that it cannot be measured by most simple devices and requires special techniques and tools to verify such a change of length occurs as a result of the applied stress.

In the case of a simple column of dimensions $r_1 = r_2 = 1.5$ inches, the unit elongation becomes:

$$\frac{\Delta L}{L} = \frac{P}{\pi(E)r_1r_1} = \frac{10,000 \text{ lbs}}{(3.1416)(30,000,000 \text{ PSI})(1.5 \text{ in.})(1.5 \text{ in.})} = 0.000,047,2$$

or
$$\frac{\Delta L}{L} = 47 \text{ PPM}$$

Here, the smaller column has a higher unit elongation because the cross section is uniform and smaller. That is, the effective area to carry the load has been reduced over part of the cone as shown in Figure 1.3. This is one of the forms of stress concentration that will be covered in future chapters. Since the pressure is a measure of the stress, with the definition of pressure as applied force per unit area, the stress will be greater in the smallest cross section.

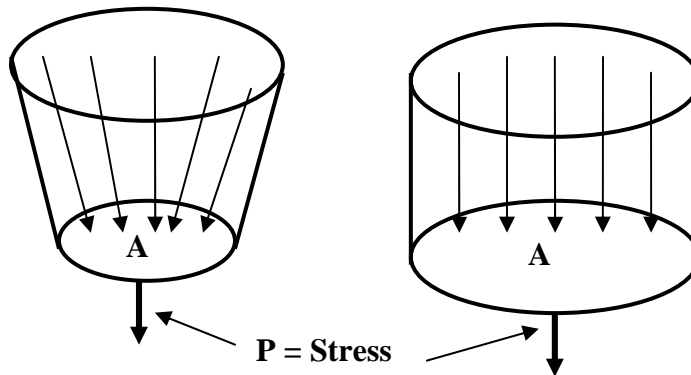

Figure 1.3 - Stress in a Cone and a Column

Example 1.2 - The combination of a steel shaft surrounded by a bronze bushing carries a load. We apply pressure along the long axis. This situation mimics many rods and support structures.

The combination of a steel columnar shaft surrounded by a bronze bushing carries an axial load. This situation mimics many instrument rods and simple, small support structures of common engineering projects.

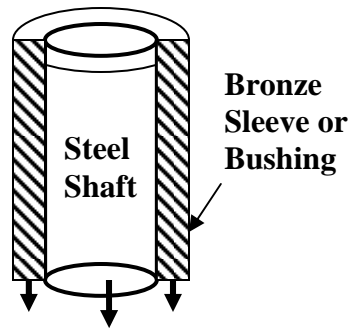

Figure 1.4 – A Combination Shaft with a Bronze Bushing around a Steel Shaft

The same assumptions of Example 1 will be employed here.

From equation (1.3) we can write the total stress on the combination shaft as:

$$\frac{\Delta L}{L} = \frac{P_s}{(A_s)(E_s)} = \frac{P_b}{(A_b)(E_b)} \quad (1.5)$$

Since the two materials of steel and bronze are in **close contact**, they will have the **same unit elongation**, but with different cross-sectional areas. Accordingly they will have different internal stresses. The total of the stress in the bronze and the stress in the steel must equal the applied stress.

$$P_s + P_b = P$$

Where the subscript “S” applies to the steel and the subscript “b” applies to the bronze portion. The stress is shared by the materials in proportion to their Modulus of Elasticity and their cross-sectional areas. This stress sharing condition can be written as a fraction of the total stress as:

for the steel rod
$$P_s = P \left[\frac{(A_s)(E_s)}{(A_b)(E_b) + (A_s)(E_s)} \right]$$

and for the bronze shaft
$$P_b = P \left[\frac{(A_b)(E_b)}{(A_b)(E_b) + (A_s)(E_s)} \right]$$

If the two cross-sectional areas are simply related, such as by $A_b = \left(\frac{1}{2}\right)A_s$

then:

$$A_{tot.} = A_s + A_b = 1.5A_s \quad \text{or} \quad A_s = (2/3) A_{tot.}$$

With $E_s = 30,000,000 \text{ lbs./in}^2$ for steel and $E_b = 12,000,000 \text{ lbs./in}^2$ for bronze we have:

$$P_s = P \left[\frac{30A_s}{30A_s + 12A_b} \right] = P \left[\frac{30A_s}{30A_s + 6A_s} \right] = \left(\frac{5}{6} \right) P \quad (1.6)$$

Thus, the **steel carries 5/6** of the total stress even though it is only 2/3 of the total cross-sectional area. It is wise to look at the unit elongation of each of the two materials to see if one may be the "weak link" in the combination. Why is this important? If one of the materials fails through the initiation of cracks or damage, then the whole shaft fails in the application.

Remember, the original assumption is that the unit elongation is the same for both materials. This is because the two materials are tightly connected and one can not slip relative to the other. The following calculations support this model:

$$\frac{\Delta L_s}{L} = \frac{P_s}{(A_s)(E_s)} = \frac{\frac{5}{6}P}{(A_s)(30 \times 10^6)} = (2.78 \times 10^{-8}) \left(\frac{P}{A_s} \right)$$

$$\frac{\Delta L_b}{L} = \frac{P_b}{(A_b)(E_b)} = \frac{\frac{1}{6}P}{(0.5A_s)(12 \times 10^6)} = (2.78 \times 10^{-8}) \left(\frac{P}{A_s} \right)$$

If the applied tensile stress is 5,000 lbs and the area of the steel is 0.7 in.², the unit elongation for the combined assembly would be:

$$\frac{\Delta L_s}{L} = (2.78 \times 10^{-8}) \left(\frac{P_s}{A_s} \right) = (2.78 \times 10^{-8}) \left(\frac{5000}{0.7} \right) = 1.984 \times 10^{-4}$$

$$\frac{\Delta L_s}{L} = 0.000,1984 = 198.4 \text{ PPM}$$

This would be a **safe condition** if using the elongation associated with maximum safe repetitive stress of 0.001 or 0.1% or less.

Example 1.3 – Two different diameter columns of bronze are welded together as shown in Figure 1.5. The small weld fillet between the two different diameters will be ignored in all of the calculations. What is the unit elongation if one column is 1 inch in diameter and 12 inches long and the other is 2 inches in diameter and 8 inches long and the applied axial stress is 7500 lbs. in tension?

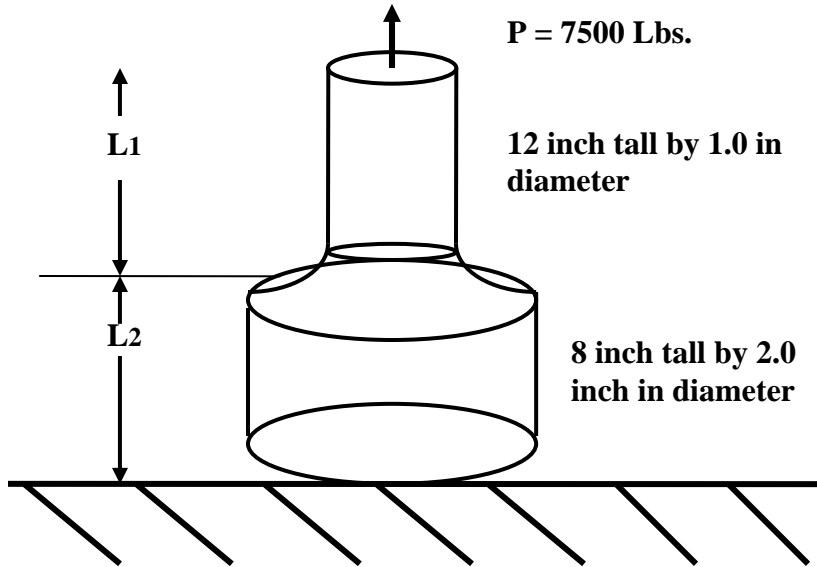

Figure1.5 – A Tapered Shaft with a Load

The same assumptions as in Example 2 apply here.

$$E = 12 \times 10^6 \text{ PSI for Bronze}$$

$$\text{then } \Delta L = \frac{P}{E} \left[\frac{L_1}{A_1} + \frac{L_2}{A_2} \right] = \frac{7500}{12,000,000} \left[\frac{12}{0.25(\pi)} + \frac{8}{\pi} \right] = 0.01114 \text{ inch}$$

Is this a safe condition for the column? The following are the elongation calculations. The stresses on each column are in proportion to the ratio $\frac{L}{A}$. These two numbers are:

$$\frac{L_1}{A_1} = \frac{12}{(0.25)\pi} = \frac{48}{\pi} \quad \text{and} \quad \frac{L_2}{A_2} = \frac{8}{\pi} \quad \text{or the ratio of 6 to 1}$$

Therefore:

$$\Delta L_1 = \left(\frac{6}{7}\right)(0.01114) = 0.009549 \text{ inch} \quad \text{and}$$

$$\Delta L_2 = \left(\frac{1}{7}\right)(0.01114) = 0.001591 \text{ inch}$$

$$\text{Elongation}_1 = \frac{0.009549}{12} = 0.000796 = \mathbf{796 \text{ PPM}} \quad \text{in the 1.0 inch column}$$

$$\text{and } \text{Elongation}_2 = \frac{0.001591}{8} = 0.000199 = \mathbf{199 \text{ PPM}} \quad \text{in the 2.0 inch column}$$

The elongation is a measure of the reliability of the situation since it is proportional to the stress and has a safe upper repetitive limit tied to a physical failure mechanism. This is through the creation of stress cracks and the eventual crack propagation leading ultimately to structural failure. The current model makes no comment on the length of time or the number of stress applications required that lead from crack inception to ultimate failure. The nature of how the stresses themselves are applied and the shape of the stress pulse applied to the material all have an impact. The one inch portion of the column is the weak link. The prior calculation shows it approaching the suggested safe upper limit of 0.1 percent as it is 0.0743 percent as an elongation. To complete this example, the calculation of a reliability number for this situation would be desired.

1.5 - Shear Stress Applications for Reliability

In many applications the limit of reliability is measured by the size of the shear applied to the material. Any shear imparts four simple stresses, as shown in Figure 1.6 and can lead to failure, again by material fracture. The stresses are shown below.

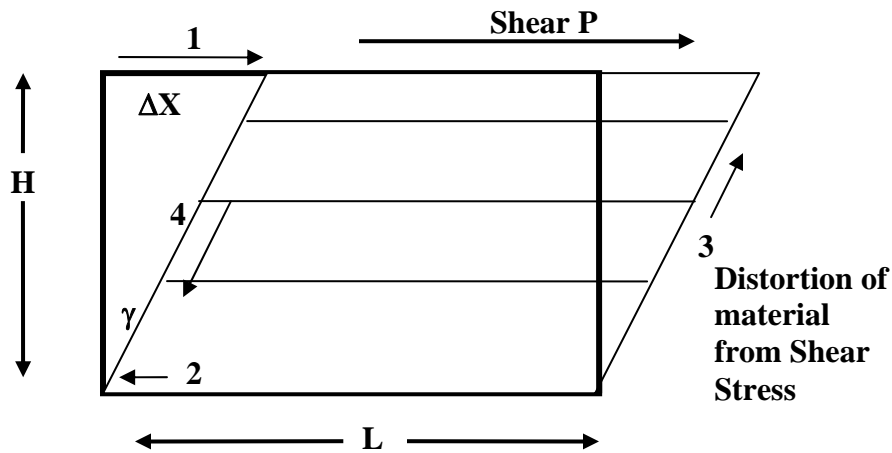

Figure 1.6 – Shear Forces of Material

Think of the material under shear as a **loose stack of cards**. When the force is applied at one edge, the card pile deforms (i.e. slides) as shown in Figure 1.6. This allows the material to maintain the same volume while it is rearranged to the new, distorted shape, here a simple parallelogram. This is a "slip deformation" and often occurs in crystalline planes of materials. The greater the number of planes in the material, the easier it is to produce this **elastic/plastic deformation** without overt brittle fracture. Dislocations in the material may affect the forces required for slip, reducing the overall force necessary to create a simple elastic deformation. This is the "rug slip" mode. The four forces in action as a result of applied shear are labeled 1 to 4 in Figure 1.6. Force 1 is the original cause of the shear stress. The other 3 "forces" are the **internal reactions** of the material and are related to the distortion to a parallelogram from a rectangle. The initial length is L and the initial height is H . The third dimension can be labeled T and is not shown or considered in Figure 1.6. For purposes of this discussion, the material will be treated as uniform in this plane with shear occurring only in the LT plane. The force placed upon the upper edge moves the material an angle, γ , or the total distance, ΔX . This simple model for shear has the following properties: (The shear is expressed in the traditional X - Y , LH plane, and so no subscripts will be shown to identify this plane). The shear stress may be written as:

$$\tau = \text{Shear Stress} = \text{Force/Area} \quad (1.7)$$

with the Strain written as:

$$\tan\gamma = \frac{\Delta X}{H} \sim \gamma \quad (1.8)$$

$$\text{and} \quad \tau = G \gamma \quad (1.9)$$

Where γ is the shear angle and G is the shear modulus for elasticity or Modulus of Rigidity in the LT plane.

The **ultimate shear strength** for steel is typically about three-quarters of the ultimate tensile strength which would make it about $\frac{3}{4}$ (80,000 PSI) = 60,000 PSI for hard cast steel. The elastic limit in this situation is typically about 36,000 PSI or 45% of the ultimate strength. For general steel, the shear modulus is typically $G = 12 \times 10^6$ PSI and follows Equation 3.2 for its relationship to other fundamental material variables.

Example 1.4 - The **yield angle** of a material represents a critical measurement and is the maximum shear angle for the material. It can be treated as analogous to the yield stress or elongation. This permits a simple estimate of reliability. For general steels, this angle is often about:

$$\gamma = \frac{\tau}{G} = \frac{27,000}{12,000,000} = 0.00225 \text{ radians} = 0.129 \text{ degrees} \quad (1.10)$$

for hardened steels we would have

$$\gamma = \frac{\tau}{G} = \frac{36,000}{12,000,000} = 0.00300 \text{ radians} = 0.172 \text{ degrees}$$

If the material were basic aluminum, with $G_{Alum.} = 3.9 \times 10^6$ PSI and the yield strength were to be calculated approximately as follows:

$$S_Y^{Alum.} = (0.6)(0.002)E_{Alum.} = (0.6)(0.002)(3,900,000) = 4,680 \text{ PSI}$$

The estimate is based upon the 60% factor and the upper limit of the elastic range of 0.002. Certainly, there is room for variation in both of the estimates. Thus, the yield strength in shear could be as low as 4000 PSI and as high as 40,000 PSI. Consult the table for the properties of each aluminum.

The maximum yield angle in this shear situation of aluminum would then be:

$$\gamma^{Alum.} = \frac{\tau}{G} = \frac{6,000}{3,900,000} = 0.001538 \text{ radians} = 0.879 \text{ degrees.}$$

Other materials can be calculated in a similar fashion. Remember that this simple approach is based upon elastic behavior of the material. If a calculated yield angle is above this critical number, consider the fact that the elastic region boundary may be a little uncertain. The maximum yield angle really is a minimum estimate of the stress present for elastic behavior. Caution is always suggested when estimating at the edge of the elastic region.

The twist angle, ϕ , with a shear stress S_s on a shaft of radius r with length L and moment of inertia M , may be written as:

$$\phi = \frac{M_t L}{GI_p} \quad \text{and} \quad \text{stress } S_s = \frac{M_t r}{I_p} \quad (1.10)$$

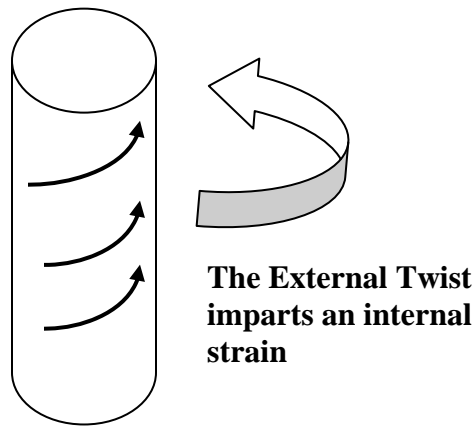

Figure 1.7 - External Twist on a Column

Example 1.5 - Stress in a Helical Spring

Place a force couple, \mathbf{P} , on a helical spring (Figure 1.8) that has a major radius, R , or diameter D , with wire radius, r (and with $d = 2r$), has N **effective coils** over the length L . A point, A , near the middle of the spring will have to transmit the shear force and so will have a moment acting through the center line of the wire itself. The coils have an angle β which represents the rise of the helical coils from the base. When angle β is small, the main moment which is $(PR)[\cos(\beta)]$ may be approximated by PR . The spring is then said to be "closely coiled". In this situation, we also neglect the effects of a second moment, $(PR)[\sin(\beta)]$ which will be very small in a closely coupled situation. The primary stress inside the wire from the twist moment generated when the spring expands can be written as:

$$\text{Stress} = \frac{M_t(r)}{(I_p)} = \frac{[PR\cos(\beta)](r)}{[\pi(r^4)]/2} \sim \frac{2PR}{\pi(r^3)}$$

And

$$\tau = Gr\left(\frac{d\phi}{dx}\right) \quad (1.11)$$

Remember that the major radius, R , as measured from the center line of the coil to the center of the wire is much larger than the wire diameter, r . There is a shear force within the wire itself which is distributed uniformly over the small wire cross section. This can be written as:

$$\text{Direct Shear Stress} = \frac{R}{\pi(r^2)}$$

Thus, the stress due to the **twist of the coil** is $\frac{2R}{r}$ times larger than the shear stress so the direct

shear stress. This small error will be neglected in further calculations of the shear inside the spring wire. The neglect of the shear stress is valid as long as $R \gg r$. In the real world, both stresses are acting, especially at the inner and outer edges of the wire. At the **inner edge the two stresses are additive** and this may lead to a change in the cycles to failure for the spring when the wire diameter is not small as compared to the coil diameter. This is why many coil springs fail from a crack that is initiated on the inner edge of the coil near one end.

The spring will naturally change its length due to the tension placed upon its ends. From Equation 1.11 above we can write the relationship for the shear force on the spring and the response of the spring. At point A, the spring will turn a small angle $d\phi$ as the tension or compressions forces act. The top and bottom coil of the spring turn an amount, $Rd\phi$ while the length changes by δ . Any sideways motion of the coil will be neglected in this calculation. This discussion can be summarized with the following two equations describing the twist angle as a function of the length change δ . This is:

$$d\phi = \frac{32PR}{\pi(d^4)} \left[\frac{dl}{G} \right]$$

and

$$\delta = \int Rd\phi = \frac{32PR^2}{\pi(G)(d^4)} \int dl = \frac{64PR^3(N)}{(G)(d^4)} = \frac{8PD^3(N)}{(G)(d^4)} \quad (1.12)$$

This is the simple downward length change of the coiled spring wire due to the force upon one end of the coil. Likewise, the spring height may lengthen due to the common force upon the spring (Hooke's Law). From this knowledge we can estimate the reliability. Hooke's Law may be expressed as:

$$\text{Force} = K (l - l_0)$$

Combined with Equation 1.12 with the fact that we will set $\delta = l - l_0$ and with $K = \frac{P}{\delta}$ representing the spring stiffness constant, one has:

$$K = \frac{Gd^4}{8N(D^3)} \quad (1.13)$$

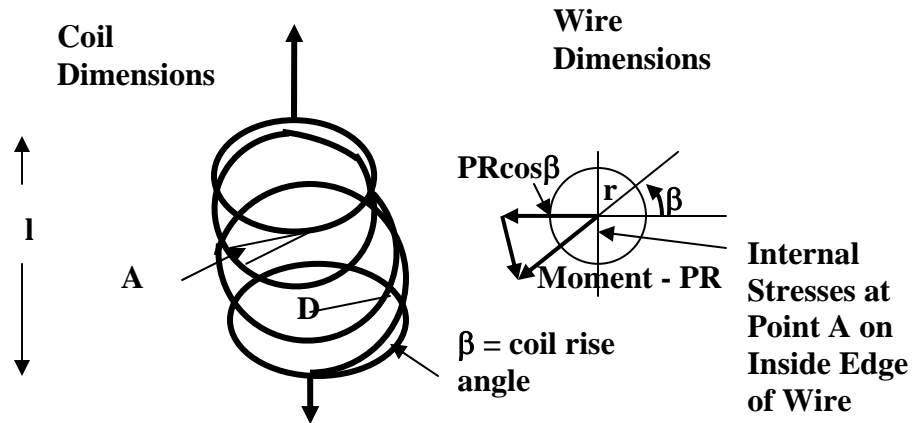

Figure 1.8 – The Helical Spring

Example 1.6 - A helical spring of 12 active coils, made of spring steel is constructed of 0.100 inch diameter wire with a coil diameter of 1.20 inches. What is the spring stiffness constant? What would the force be if this spring was stretched 2 inches?

Assumptions -

- A) The spring follows Hooke's Law.
- B) The twist is the main source of shear stress.
- C) The coil radius, $\frac{D}{2}$, is much larger than the wire radius, $\frac{d}{2}$.

Begin with Equation 1.13 to calculate the stiffness constant.

$$K = \frac{Gd^4}{8N(D^3)} = \frac{(12,000,000)(0.100)^4}{8(12)[(1.2)^3]} = 7.234 \text{ lbs./inch}$$

and

$$F = K(l - l_0) = (7.234 \text{ lbs./inch})(2 \text{ inch}) = 14.47 \text{ lbs.}$$

Example 1.7 - If the spring were only 8 active coils of wire 0.130 diameter and coil diameter 0.75 inches and made of **brass**, the force constant would be:

$$K = \frac{Gd^4}{8N(D^3)} = \frac{(6,000,000)(0.130)^4}{8(8)[(0.75)^3]} = 63.47 \text{ lbs./inch}$$

and the force for a 0.5 inch deflection is:

$$F = K(l - l_0) = (63.47 \text{ lbs./inch})(0.5 \text{ inch}) = 31.74 \text{ lbs.}$$

If a force of 40 lbs was required for a deflection of 0.2 inches, what brass spring constant would be required?

$$\begin{aligned} & 40 \text{ lbs.} = (0.2 \text{ inch})(K) \\ \text{or} \quad & K = 200 \text{ lbs./inch} \end{aligned}$$

Example 1.8 - What spring design would be consistent with this requirement if the spring were steel?

$$K = 200 = \frac{Gd^4}{8N(D^3)} = \frac{(1,500,000)d^4}{8N(D^3)} = (1,500,000) \frac{(d)^4}{N(D^3)}$$

For 12 active coils, one has:

$$\begin{aligned} 200 &= (125,000) \frac{(d)^4}{(D^3)} \\ \text{or} \quad & \frac{(d)^4}{(D^3)} = 0.0016 \end{aligned}$$

For a coil diameter of 1.25 inch, we have:

$$\begin{aligned} d^4 &= (0.0016)(1.25)^3 = 0.003125 \\ \text{or} \quad & d = 0.2364 \text{ inch} \end{aligned}$$

This is the steel wire diameter to build the desired spring.

1.6 - Simple Structural Examples

This section will be concerned with traditional beams and structures and how the forces, torques and moments may be simply described in order to evaluate the stresses in the beam materials. These examples will be employed later in the book to lead to simple estimations of reliability in a wide variety of situations. A few examples will be employed to show the concepts of beams. The following examples are the building blocks of many reliability approaches. The first example is from Den [18]. All of the examples employ the same basic assumptions which are:

Assumptions -

- A) Low stress, stress levels remain in the elastic zone of the material.
- B) Simple linear models in use, no non-linear effects are considered.
- C) Materials are uniform in all directions.
- D) Applied loads and stresses are uniform unless otherwise noted.

Example 1.9 - A beam with 2 stresses, P and Q, placed upon it is shown in Figure 1.9. What are the stress distribution and moments in the beam? This looks like a motor rotor or many other static load situations.

These distributions are shown in Figure 1.9 and described by the equations below. The two applied forces are P and Q. The force P is applied at the middle of the beam and Q is applied 1/4

of the way from the left edge. The beam is of length L. The beam cross section, width and height, are small with respect to the length and any effects will be ignored in this example. At each end of the beam there is vertical equilibrium. Using the right end as a reference, the shear force is:

$$\text{Shear Force, right side} = S_r = (1/2)P + 1/4(Q) \quad (1.14)$$

$$\text{Moment about a point, x, from the right edge} = M_b^r = x\left(\frac{P}{2} + \frac{Q}{4}\right) \quad (1.15)$$

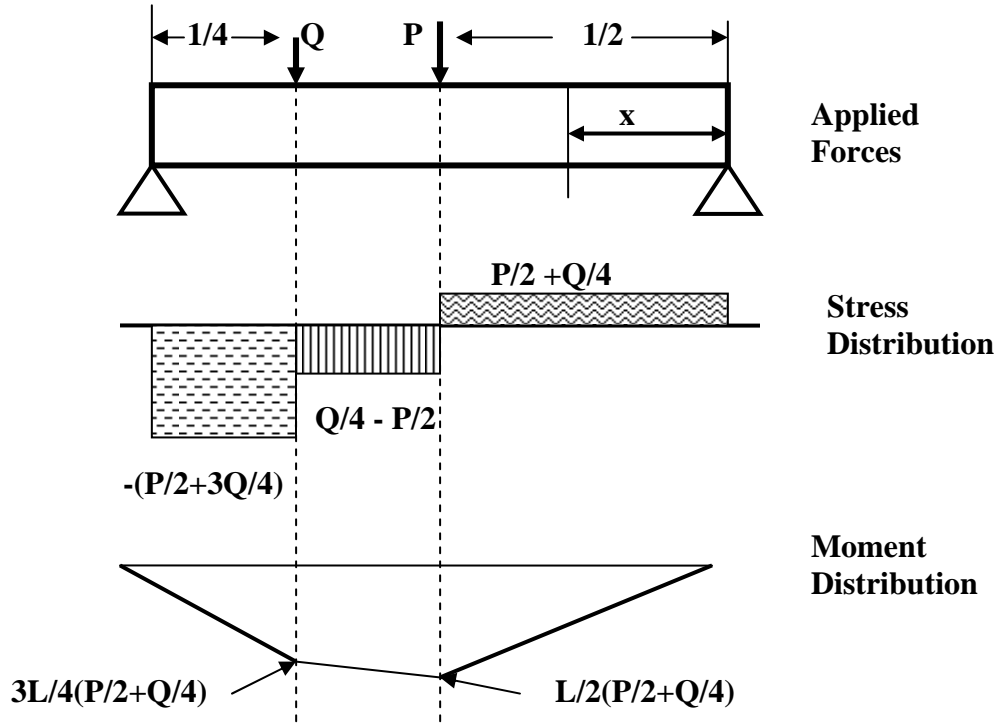

Figure 1.9 – The Stress Distribution in a Beam

The custom is to use a downward bending or deflection of a beam as a positive sign. Had we selected the left edge instead as a reference, the equations would still be the same. Starting at the left edge, the stress and moment equations are initially:

$$\text{Left Side Stress} = S_l = P + Q - \left(\frac{P}{2} + \frac{Q}{4}\right) = \left(\frac{P}{2} + \frac{Q}{4}\right)$$

$$\text{Moment} = M_b^l = (L - x)\left(\frac{P}{2} + \frac{3Q}{4}\right) - (Q)\left(\frac{3L}{4} - x\right) - P\left(\frac{L}{2} - x\right) = x\left(\frac{P}{2} + \frac{Q}{4}\right)$$

The discussion of the forces, moments and stress distributions allow one to extend the idea of simple deformation to more complex shapes and objects. This ultimately will permit several approaches for estimating the reliability of the beam material.

1.7 - A Single Force on a Beam - What is the deflection distance and angle for a simple beam deflected by a force P on the free end as shown in Figure 1.10?

Example 1.10 - The equations change a little from Example 1.9. These are shown as Equations 1.14 and 1.15. This example follows the basic assumptions given above.

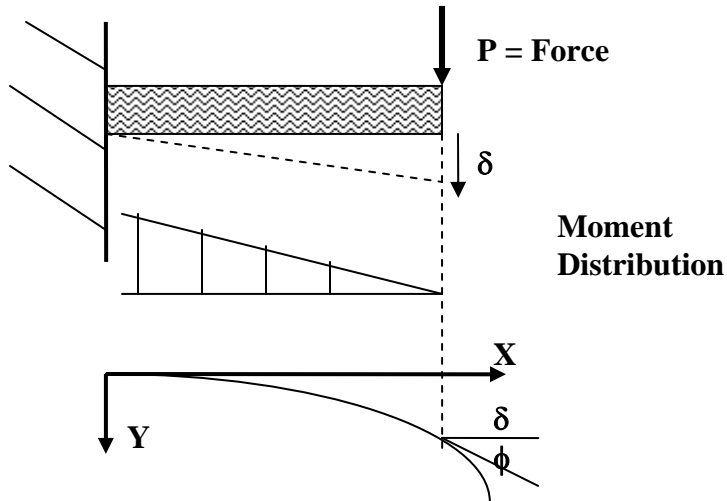

Figure 1.10 – The Free End of a Beam under and End Load

The maximum beam deflection angle is
$$\phi = \frac{PL^2}{2EI} \quad (1.16)$$

where \$I\$ is the Moment of Inertia about the end of the beam.

The maximum beam deflection is
$$\delta = \frac{PL^3}{3EI} \quad (1.17)$$

Example 1.11 - A Uniform Load. For a cantilever beam, as shown in Figure 1.11 with a uniform load, with weight per unit length, \$W\$, what is the deflection angle and deflection?

Worked in a similar fashion to Example 1.10 we have:

maximum deflection angle
$$\phi = \frac{WL^3}{6EI} \quad (1.18)$$

and maximum deflection
$$\delta = \frac{WL^4}{8EI} \quad (1.19)$$

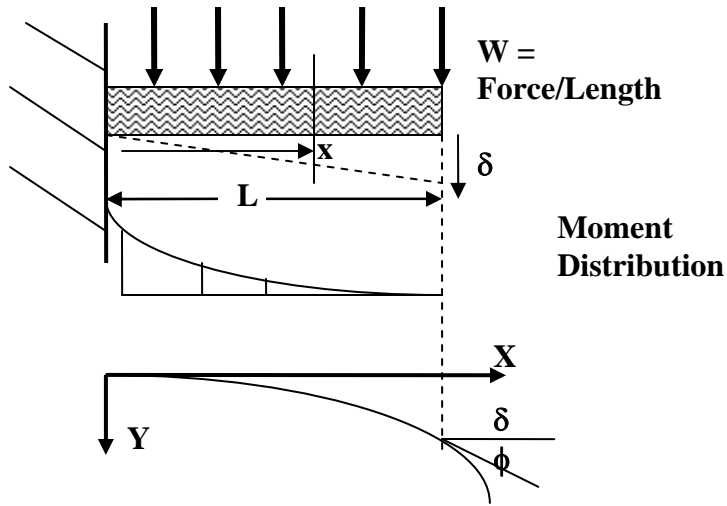

Figure 1.11- A Beam under a Uniform Load

The point, a distance x from the attached end, is $L-x$ from the free end. Therefore, the bending moment would be in this situation:

$$M = \frac{W(L-x)^2}{2} \quad (1.20)$$

Filling in the following basic equation, and integrating gives:

$$\phi = \frac{dy}{dx} = \int_0^L \frac{Mdx}{EI} = \frac{W}{2EI} \int (L-x)^2 dx = \frac{W}{2EI} \left[L^2x - Lx^2 + \frac{x^3}{3} + C_1 \right] \quad (1.21)$$

When x is zero there is no bending moment, so C_1 must be zero.

Integrating the results of Equation 1.21 gives:

$$y = \int \frac{W}{2EI} \left[L^2x - Lx^2 + \frac{x^3}{3} \right] dx = \frac{W}{2EI} \left[\frac{L^2x^2}{2} - \frac{Lx^3}{3} + \frac{x^4}{12} + C_2 \right] \quad (1.22)$$

When x is zero there is no bending moment, so C_2 must be zero.

Letting $x = L$ in equations 1.21 and 1.22 yields Equations 1.18 and 1.19 as previously shown, since $x = 0$ leaves no remaining terms.

1.8 – The First Reliability Model for Mechanical Situations

A simple reliability model is the **stress-load model**. In its simplest form it assumes that the stresses present are normally distributed and that the strength of material is also normally distributed across a number of samples. With these distributions known, we can calculate the

overlap of the two distributions, called interference, and can estimate the reliability of the situation. The area of overlap is proportional to unreliability. See references [2], [3], [4] and [6] for additional information on this technique.

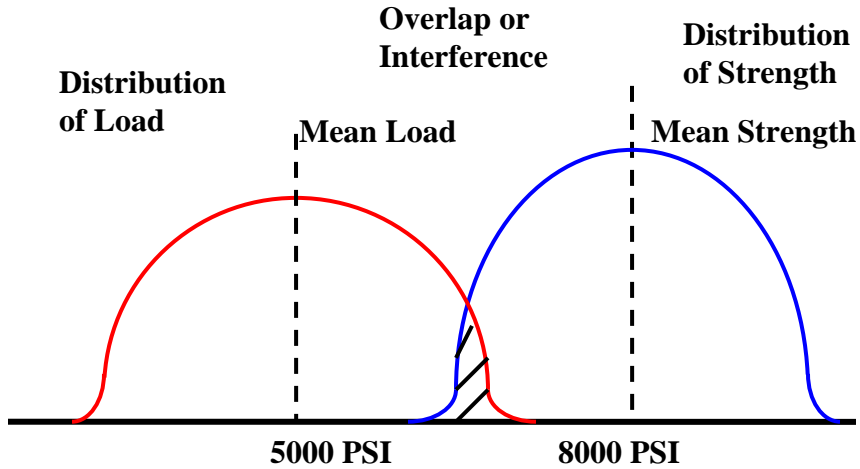

Figure 1.12 – The Stress–Load Model

Mean of the Load is $L = 5000 \text{ PSI}$ and $\sigma_L = 700 \text{ PSI}$

Mean of the Strength is $S = 8000 \text{ PSI}$ and $\sigma_S = 800 \text{ PSI}$

We often desire the Safety Margin to be ≥ 3 to ensure a high reliability. The Safety Margin unfortunately is a poorly defined term. You can find at least 2 definitions, depending upon the book. Note - *Most books agree* that The **Margin of Safety** is *different from* the **Safety Margin**. The Margin of Safety being the ratio of the average values of the strength and load when the standard deviations are unknown. The following is the most common convention for the Safety Margin or S.M.

$$Z = \text{Safety Margin} = \frac{\text{MeanStrength} - \text{MeanLoad}}{\sqrt{\text{Sum of variances}}} \quad (1.23)$$

Here this is
$$\text{S.M.} = \frac{8000 - 5000}{\sqrt{(700)^2 + (800)^2}} = \frac{3000}{1063} = +2.822$$

and since
$$\mathbf{R} = \Theta (\text{S.M.}) \quad (1.24)$$

so
$$\mathbf{R} = \Theta (+2.822) = \mathbf{0.997614}$$
 as read from the Normal Table

A one time application of a range of stress upon a material will lead to the **population reliability** of 0.997614 for the range of loads and strengths present. Figure 9 shows the considerable overlap of the two distributions. Despite this, the one time reliability is still high.

This simple model can be employed with a variety of situations. These are mainly mechanical, but can also be electronic. Where ever one can describe a probability distribution that is related to a state of a system that has a well defined failure distribution, we can use this approach. Time may even be added to the whole approach.

Extensions of the simple static model may be based upon the fact that one can model some quasi-static situations by the interference (overlap) of the strength and load distributions. The distributions represent a probability of strength and a probability of load (stress) in a population of possibilities. They do not suggest that a single system is changing values of strength, rather the whole population may be drifting. Load is assumed to be static or drifting just as is strength. Both distributions are still assumed to be normally distributed. The math in this case is easy. The overlap area of the two distributions is proportional to the probability of failure. This simple model may be extended by adding time or repetitive activities. The following examples show ways to extend this simple model.

Degradation may be the description of a slowly declining strength distribution. The stress changing with time may be associated with a number of common failure mechanisms such as loss of lubrication, wear out or damage.

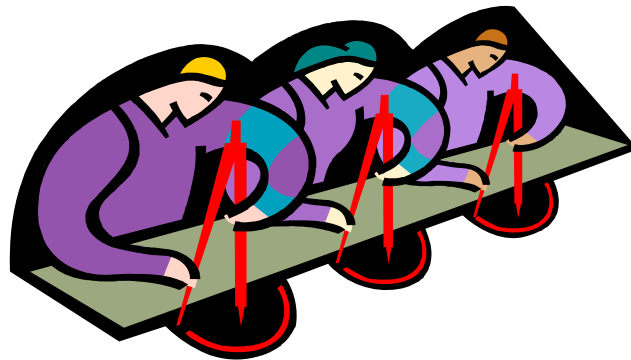

2.0 - Dynamic Examples and Applications

2.1 - A Simple Stepper Motor

Imagine for a minute we have 10% variation on the dynamic **load** of a stepper motor as might be the case with a driven assembly. We will use a stepper motor with the average **driving force** $F_{drive} = 40$ in.-lbs. and $\sigma_{drive} = 2$ in.-lbs. and these have a steady load ranging over

$$F_{Load} = 32.0 \text{ in.-lbs.} \quad \text{with} \quad \sigma_{Load} = 3.20 \text{ in.-lbs.}$$

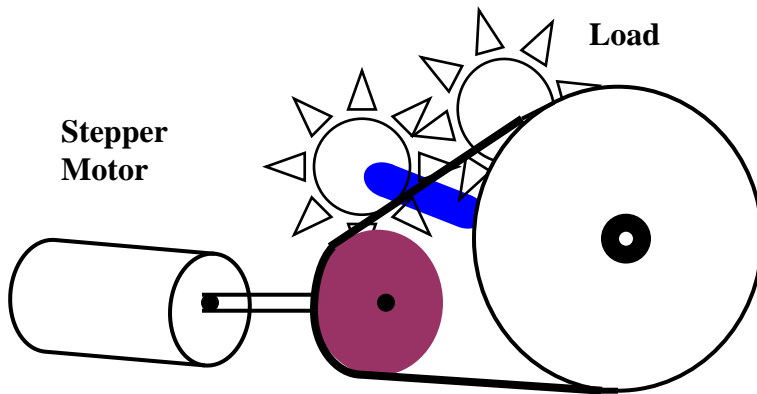

Figure 2.1- A Simple Stepper Motor

We can describe the expected average reliability *for a population* with these average values of driving force and load with the probability Equation (1.23).

$$\text{Prob. of Reliability} = \text{Prob.}(Z) = \text{Prob. (Safety Margin)} = \Phi \left\{ \frac{\text{Mean}_{Strength} - \text{Mean}_{Load}}{\sqrt{\text{Sum of variances}}} \right\}$$

$$\text{with} \quad Z = \text{S.M.} = \frac{40 - 32}{\sqrt{(2.0)^2 + (3.2)^2}} = \frac{8.0}{3.77}$$

$$\text{so} \quad Z = +2.12$$

$$\text{Reliability} = \text{Prob.}(+2.12) = 0.9830$$

The Z score represents the probability of Reliability in this situation. We are asking by the equation above just how close is the distribution of the driving force is to the load or damping force. This closeness is measured in terms of the variances of the distributions. Thus, we have by looking up this score in any Normal table.

This Reliability number represents for a simple population the expected reliability for a *one time* application of the population load distribution on the population driving force distribution. For anything more dynamic, some assumptions will need to be made.

Example 2.1 - Repetitive Cyclic Stresses

In this example, the concept of simple low level repetitive stresses is added. This approach will provide an approximate answer in the cases where cumulative stress slowly accumulates. This is sometimes referred to as wear, **degradation**, aging or fatigue model. How high should the one time population reliability be in order to achieve an average population Reliability of 0.90 at 5000 cycles? This assumes slow accumulation of degradation. A simple approximate model is then:

$$\text{Let } \mathbf{R}_{final} = 0.90 = (\mathbf{R}_{Initial})^{5000} \quad (2.1)$$

This model also assumes that all events are independent. It could also model a situation when there was a very low accumulative degradation or wear would be present in any of the stress incidents or cycles. We can easily rearrange the equation to write:

$$\mathbf{R}_{Initial} = (0.90)^{\frac{1}{5000}} = 0.9999789 \quad (2.2)$$

This number represents the required reliability of the initial products in order to achieve the final reliability after the 5000 stress cycles. The model is based loosely upon the binomial distribution and has limited applicability in most engineering situations. The assumptions required are seldom fully met in the real world. This model provides only an approximate solution to this problem.

Example 2.2 - Minimum Driving Force

If we fix the average load at 32 in.-lb. and the standard deviation of the load at 3.2, in Example 2.2 we can then solve for the minimum driving motor force required to achieve a reliability of 0.9999789 as calculated. We assume a 10% tolerance is adequate to describe the variability of the driving force that will result in the initial desired reliability of 0.9999789. We have then:

$$\mathbf{Z} = \frac{\mathbf{F} - 32}{\sqrt{(0.1\mathbf{F})^2 + 10.24}} = -4.126, \quad (2.3)$$

where -4.126 is from the required Z score for the desired initial reliability of 0.9999789. The minus sign indicates that we require the overlap or interference to be very small and "on the left side of the strength distribution". This is a common sign convention, but not the only one you may experience. The mathematics is not too difficult but will be detailed here.

$$(\mathbf{F} - 32)^2 = (17.024)(0.01\mathbf{F}^2 + 10.24)$$

$$\mathbf{F}^2 - 64\mathbf{F} + 1024 = 0.17\mathbf{F}^2 + 174.3$$

$$0.83\mathbf{F}^2 - 64\mathbf{F} + 849.7 = 0$$

and the solution is $\mathbf{F} = \mathbf{60.1}$ in-lbs is the required initial driving force

We discard the second solution to this quadratic equation, since it is 17.04 in-lbs. This solution is not viable for the problem as stated.

Note - If we hold the driving force variation to only 5% this average force reduces to 48.6 in.-lbs. This is a very dramatic reduction. It shows the implicit interaction of quality and reliability in this case.

2.2 - A Simple Time Dependent Situation

Example 2.3 - Set the reliability from the Example 2.1 equal to a simple static reliability model. We are suggesting the **reliability is time dependent** but the failure rate not dependent on time. This assumption is not true where wear, degradation or accumulated fatigue is present. Let the total expected life be equal to 5000 cycles which occur over 250 customer operating hours. These operating hours might actually be accumulated at the rate of five operating minutes per each system operating cycle per day. Think of this as a computer hard drive access situation or an appliance that is occasionally used (microwave or washing machine). It takes a long time to accumulate these 5000 operating cycles or "250 operating hours". Next, use the basic reliability equation, because we do not have more information to justify a better reliability model.

$$\text{Reliability} = e^{-\lambda t} \quad (2.4)$$

$$0.983 = e^{-\lambda t}$$

and $0.01715 = (250)\lambda$

$$\lambda = 0.0000686 \text{ failures/access hour}$$

or $\lambda = 0.0000034 \text{ failures/operating cycle}$

This number represents the failure rate that will achieve the desired reliability at the number of life cycles. The reliability at **50 cycles** would be 0.999829. The initial reliability, or zero cycle reliability, as calculated from the formula would of course be 1.00. The reliability at **one cycle** is 0.9999314. Both bracket the required initial reliability of 0.9999789 we had determined in Example 2.1. Thus, this zero time approximation is a rough estimate.

Example 2.4 - A More Dynamic Time Dependence

Now, consider the situation with the following time dependency on the load and driving force. This corresponds to the simple aging of the motor combined with the slow decrease of the load. This looks like any stepper motor situation you might encounter in the real world. Figure 2.2 shows this graphically.

$$\text{Motor Driving Force} = A_0 e^{-\left(\frac{t}{100}\right)^2} \quad \text{where } A_0 = 43 \text{ in.-lbs. or the initial drive} \quad (2.5)$$

$$\text{Load Force} = F_0 e^{-\left(\frac{t}{10000}\right)}$$

These two formulas represent a rapid motor force decay combined with a slow decay of the load.

When does the Reliability drop to 0.70? An approximate solution to this more complex time dependent reliability problem is as follows. We have:

$$\text{Driving Force} = (43)e^{-\left(\frac{t}{100}\right)^2} \quad \text{and } \sigma_F = 2.15 \text{ or } 5\% \text{ variation}$$

$$\text{Damping Force} = (32)e^{-\left(\frac{t}{10000}\right)} \quad \text{and } \sigma_{DF} = 3.2 \text{ or } 10\% \text{ variation}$$

$$\text{so we can write } -0.525 = \frac{43e^{-\left(\frac{t}{100}\right)^2} - 32e^{-\left(\frac{t}{10000}\right)}}{3.855} \quad (2.6)$$

$$-2.024 = (43)e^{-\left(\frac{t}{100}\right)^2} - (32)e^{-\left(\frac{t}{10000}\right)}$$

taking the first terms only of an expansion, we have

$$-2.024 = 43\left[1 - \frac{t^2}{10,000}\right] - 32\left[1 - \frac{t}{10,000}\right]$$

we have this approximation if we let t be small with respect to 10,000 hrs. This is often the case, so we will assume it and then see if it is true. The equation simplifies to:

$$-2.024 = 11 - \frac{43t^2}{10,000} + \frac{32t}{10,000}$$

$$43t^2 - 32t - 130,239 = 0$$

$$\text{solving } t = 55.4 \text{ hrs.}$$

Our assumptions appear to be correct as 55.4 is **small** as compared to 10,000 hours. This represents the total accumulated system "operating time" until the reliability drops to 0.70. It was the strong time decay of the driving (motor) force that reduced the reliability greatly in this example. This model also assumed that **no change to the variances** occurred. We see in Figure 2.2 that the two distributions approach each other as time passes. This accounts for the sole time dependence and the unreliability measure.

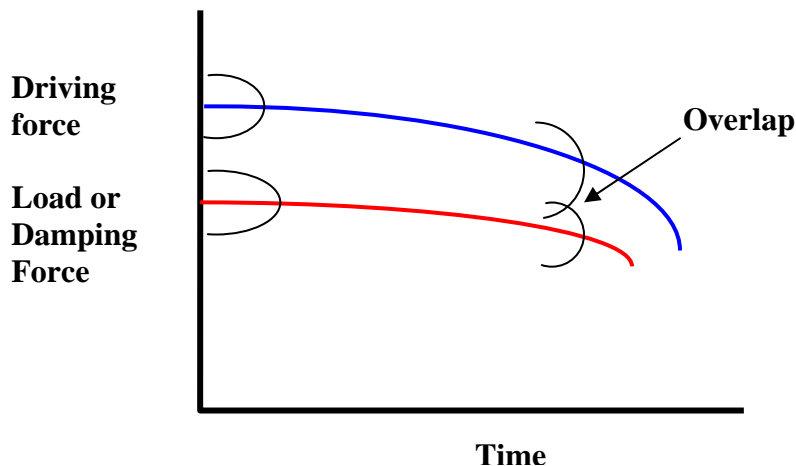

Figure 2.2 – Time Dependence of the Reliability

2.3 - Calculating the Minimum Zero-Time Force

Example 2.5 - If a reliability of 0.999 is desired at 50 hours in Example 2.4, what should the initial driving force be if 5% variability exists with the motor? We begin by filling in the Equation 2.6 above. F represents the basic force required at time zero to achieve this reliability. The time dependence is the same as in Example 2.5 for driving force and damping forces.

$$-3.09 = \frac{F e^{-\left(\frac{t}{100}\right)^2} - 32 e^{-\left(\frac{t}{10000}\right)}}{\sqrt{(0.05F)^2 + (3.2)^2}} = \frac{F\left(1 - \frac{t^2}{10,000}\right) - 32\left(1 - \frac{t}{10,000}\right)}{\sqrt{(0.05F)^2 + (3.2)^2}}$$

$$-3.09 = \frac{F - 32 - \frac{Ft^2}{10,000} + \frac{32t}{10000}}{\sqrt{(0.05F)^2 + (3.2)^2}} \quad (2.7)$$

Filling in the time of 50 hours and squaring the equation yields:

$$9.548(0.0025F^2 + 10.24) = (0.75F - 31.84)^2 = 0.5625F^2 - 47.76F + 1013.8$$

reducing the equation provides:

$$0.5386 F^2 - 47.76F + 916 = 0$$

or $F = 60.62 \text{ lbs.}$

Our initial average driving force must be at least this large to meet the desired reliability of 0.999 at 50 hours with the time dependence of the drive and damping forces as shown. This example is a prototype for a wide variety of similar problems that can be solved by similar techniques. Examples in addition to the stepper motor include fans, belt driven systems, sliding systems and shaft driven systems. This technique may also be applied to time dependent (i.e. wear out dominated) electronic components involved in special situations. These included bright LEDs, special incandescent bulbs and a variety of switches. Examples 2.4 to 2.6 allow approximate solutions in most cases and can be calculated on a single sheet of paper in about 10 minutes. The more detail available and the more complex the models in use usually adds to the effort required and the precision of the final answer. At times, this requires a computer or other approaches such as Finite Element Analysis.

Example 2.6 - Slower Degradation of the Driving Force

Now, consider the situation with the following different time dependency driving force. This corresponds to the simple slow aging of the motor combined with the slow decrease of the load. This changes the situation of Examples 2.4 and 2.5

$$\text{Motor Driving Force} = A_0 e^{-\left(\frac{t}{1000}\right)^2} \quad \text{where } A_0 = 43 \text{ in.-lbs. or the initial drive} \quad (2.5)$$

$$\text{Load Force} = F_0 e^{-\left(\frac{t}{10000}\right)}$$

These two formulas represent a **slow motor** force decay combined with a slow decay of the load.

When does the Reliability drop to 0.70? An approximate solution to this more complex time dependent reliability problem is as follows. We have:

$$\text{Driving Force} = (43)e^{-\left(\frac{t}{1000}\right)^2} \quad \text{and } \sigma_F = 2.15 \text{ or } 5\% \text{ variation}$$

$$\text{Damping Force} = (32)e^{-\left(\frac{t}{10000}\right)} \quad \text{and } \sigma_{DF} = 3.2 \text{ or } 10\% \text{ variation}$$

$$\text{so we can write } -0.525 = \frac{43e^{-\left(\frac{t}{1000}\right)^2} - 32e^{-\left(\frac{t}{10000}\right)}}{3.855}$$

$$-2.024 = 11 - 43\left[\frac{t^2}{10^6}\right] + 32\left[\frac{t}{10000}\right]$$

$$43t^2 + 3200t - 13,024,000 = 0$$

solving yields $t = 588.5$ hours

Thus, when the driving force decay was reduced by a factor of 10, the life increased by slightly more than 10 times.

2.4 - The Importance of Degradation

Additional methods for describing degradation can be employed. These are intended for a variety of different situations. When the standard deviation varies with time, the reliability model begins to look more and more realistic. This slightly more complex model can now cover a wider variety of situations such as encountered with accelerated life testing or high stress application. The next several examples explore these possibilities in detail.

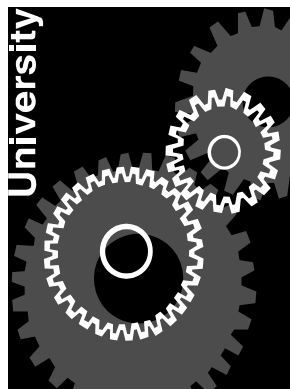

3.0 - Dynamic Degradation Mechanical Models

Example 3.1 - Inclusion of Dynamic Degradation into Reliability Models

Degradation considerations are often missing from most models using the Stress-Load approach and even those shown before were only a quasi-time dependence. This strength degradation could be a result of corrosion, accumulated fatigue, external damage or internal structural changes with-in the material itself. The material could be metal, plastic, wood or even ceramic. The model provides a better approach to including degradation. It shows a gradually decreasing strength and the common time dependent standard deviation. In this example the strength degradation will change over time while the load distribution will remain constant. Nelson [5, p.532], Carter [6], McLinn [15] have provided a few simple equations to describe this situation. This simple model is not widely known nor employed in many mechanical reliability examples.

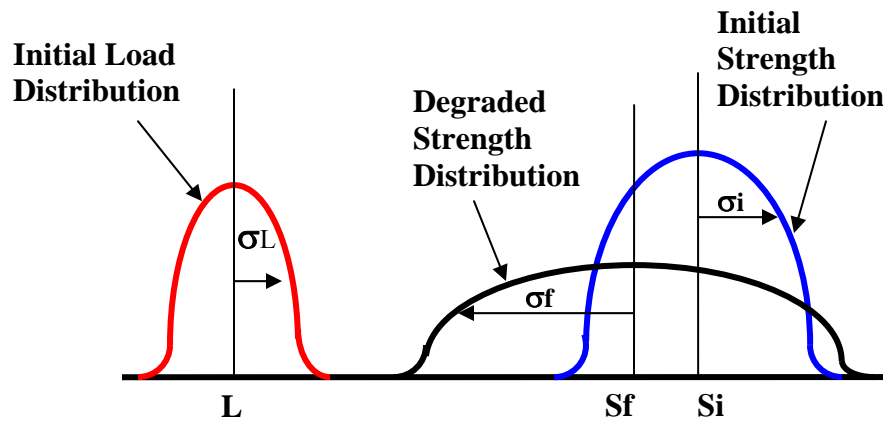

Figure 3.1 - The Stress-Load Degradation Model

A load distribution is applied to a material of initial mean strength S_i and initial standard deviation σ_i . This distribution will slowly decay over time to the one shown as the final distribution, labeled S_f and σ_f . The decay may be the result of the effects of a constant load, the effects of internal degradation of the material or as a result of material fatigue or long term corrosion. When will the reliability decay to 0.95 if the following mathematical function describes the degradation process?

The linear type decay of the strength of the material.

$$\text{Mean strength} = S_i - At \quad \text{with} \quad \sigma_f^2 = \sigma_i^2 + \sigma_b^2 t$$

Let $3\sigma_i^2 = \sigma_b^2$ with a decay rate of $A = 2 \text{ lbs./in}^2/\text{hr.}$ or PSI/hr.

The mean load is $L = 1200 \text{ PSI}; \sigma_L = 40;$ with $S_i = 2500 \text{ PSI}; \sigma_i = 50$

$$\text{And } R = P(Z) = -1.645 = \Theta \left[\frac{S_i - L - At}{\sqrt{\sigma_L^2 + \sigma_i^2(1 + 3t)}} \right] = \Theta \left[\frac{2500 - 1200 - 2t}{\sqrt{1600 + (2500)(1 + 3t)}} \right] \quad (3.1)$$

$$2.706(4100 + 7500 t) = 1,690,000 - 5200 t + 4 t^2$$

$$4 t^2 - 25495 t + 1,678,905 = 0$$

and $t = 66.5$ hours

Note $\sigma_f^2 = \sigma_i^2 + 3\sigma_b^2 t = (50)^2 + 3(50)^2 (66.5) = 501,250$

and $\sigma_f = 708$

With this rate of decay, it takes only 67 use hours to decay from an initial reliability of 1.00 to the reliability goal of 0.95. This seems unusually short in terms of operating time. It is because the strength distribution increased in standard deviation from the initial 50 PSI to 708 PSI even though the mean value has decayed from 2500 to about 2367 PSI. The model shows how important a change of standard deviation was to this problem.

Example 3.2 - Alternative Standard Deviation

Let the standard deviation function in Example 3.1 become:

$$\sigma_f^2 = \sigma_i^2 + \sigma_b^2 t \quad \text{with } \sigma_i^2 = \sigma_b^2$$

Keeping $L = 1200$ PSI; $\sigma_L = 40$; with $S_i = 2500$ PSI; $\sigma_i = 50$

$$R = P(Z) = -1.645 = \Theta \left[\frac{S_i - L - At}{\sqrt{\sigma_L^2 + \sigma_i^2(1 + t)}} \right] = \Theta \left[\frac{2500 - 1200 - 2t}{\sqrt{1600 + (2500)(1 + t)}} \right] \quad (3.2)$$

$$2.706(4100 + 2500 t) = 1,690,000 - 5200t + 4t^2$$

$$4t - 11965t + 1,678,905 = 0$$

so $t = 147.6$ hours

This example takes into account the combined effects of the gradual decrease of the mean strength and the additional spread of the strength distribution. The time to the reliability decrease has more than doubled. The example can be made more complex by the addition of time dependence in the load or by the use of a spectrum of loads. Monte-Carlo models may also be employed to solve problems of this nature.

3.1 – Cyclic Stresses and Fatigue

Example 3.3 - Miner's Rule and Accumulative Fatigue Theory

We can define something we call Miner's Rule. It relates the accumulation of

fatigue due to multiple incidents of stress on a product to the ultimate life of that product. There may be a *spectrum of stresses* present in this situation as is common in the real world. Miner's rule allows us to easily summarize this spectrum and look at the impact. The impact is the accumulation of fatigue that eventually leads to a failure. The concept of a fatigue limit also exists in this model. Only stresses above the fatigue limit contribute to eventual system failure. These may be combined by the following formula. This formula was developed as a means of estimating accumulative fatigue in dynamic situations. It is sometimes referred to as the Miner-Palmgrem relationship. The theory behind the relationship is simple. If each application of a stress (n) to a component or system does some damage or fatigue is accumulated over time, we can write a simple linear equation to describe the accumulative effects.

Total damage \propto n cycles of stress

The damage from each individual stress cycle is linearly cumulative in this model. Eventually, the stress accumulates and a failure occurs. It takes a minimum of N stress cycles before failure. Thus, each individual stress contributes an amount to failure proportional to a cycle. We have:

$$\text{individual stress damage} = \frac{n}{N}$$

Summing up all the contributions to damage from multiple levels (k_i) of stress yields formula 3.3. Setting this quantity equal to a total of 1.00 to indicate a failure, we have the traditional form of Miner's rule.

$$\text{Miner's Rule is } \sum_{i=1}^k \frac{n_i}{N_i} = 1.0 \quad (3.3)$$

Where n_i = Relative number of cycles that occur at a stress and above the fatigue limit.
Each recurrent stress level is indicated by a different value of "i".

N_i = Absolute number of cycles to destruction at the stress in question.

Miner's rule is a very simple formula that relates macroscopic behavior with a wide variety of microscopic activities. As stress cycles accumulate, fatigue cracks are first initiated by passing a threshold condition. Next, additional stress cycles lead to the growth and propagation of these cracks. Eventually, additional stress cycles lead to macroscopically observable effects and ultimately system failure. Therefore, it is not surprising that this simple linear macroscopic model may not always adequately cover these complex series of microscopic activities. There is one last aspect to the simple theory. At some low level of stress, no cracks are initiated. Thus, a "minimum threshold" needs to be overcome. This is commonly related to the fatigue limit, for it represents the lowest level for which damage can be started and accumulated.

Example 3.4 - Miner's Rule, a Simple Application

Given a Fatigue Limit = 4.5×10^8 PSI, a system was observed for a period of

time and the incidents of stress were combined into only three high stress levels above the fatigue limit. This data was recorded and a time snap shot is shown graphically in Figure 3.2. A large number of very low level stresses also were found to exist. These are all below the fatigue limit and do not contribute to any system fatigue. The high stress data is summarized in Table 3.1. Each week contains on the average the same number of high stress points, so any one week is typical of the product.

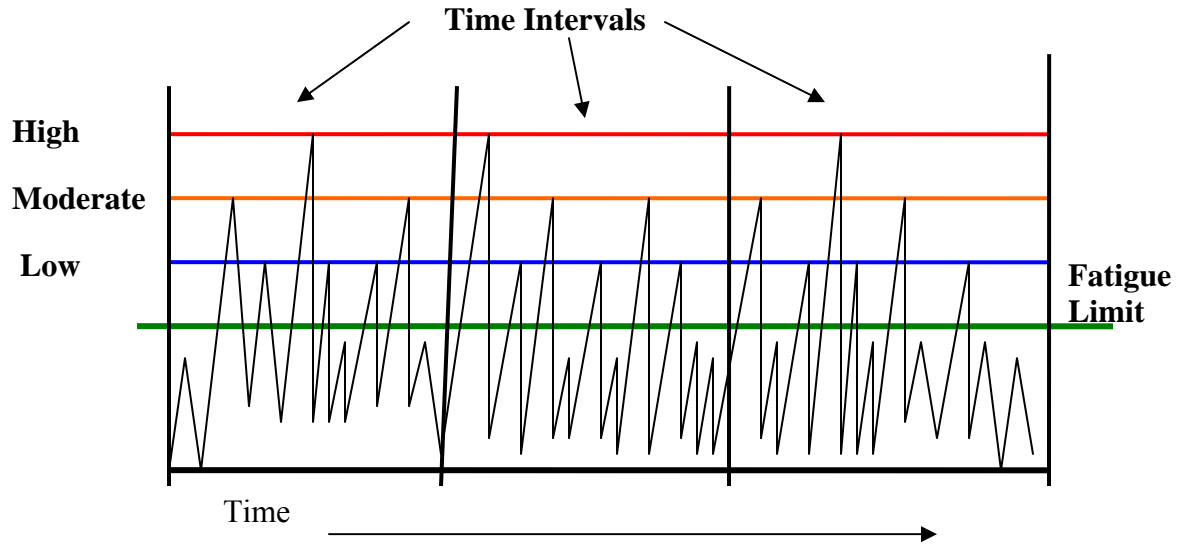

Figure 3.2 – The Summary of Stresses Observed over Three Time Periods

Table 3.1 - Summary of High Stresses Observed			
Strength		Cycles, N_i	Number of stresses observed
PSI		to Fatigue	each week, n_i
Low Stress	5.5×10^8	10,000,000 cycles	3010 stress cycles
Moderate Stress	6.5	“ 3,000,000 “	1360 “
High Stress	7.0	“ 500,000 “	477 “

With Miner's Rule we can write:

$$1 = \frac{3010A}{10,000,000} + \frac{1360A}{3,000,000} + \frac{477A}{500,000}$$

$$10,000,000 = 3010A + 4528.8A + 9540A = 17,078.8A$$

$$\text{so } A = 585.5$$

Solving for A, yielded **585.5 weeks to failure** for the "typical" system. The "A" in this equation stands for a typical week over which the comparative observations occurred. The only requirement on the time period is that each is long enough to be "typical". That is, contain

the same information on the average as every other time period on the average.

This solution assumes all systems respond the same when exposed to this spectrum of stresses. That is, there is a very narrow range of system strength. No variation of system strength was considered in this example. This may or may not be accurate with real systems as they normally show 5% to 10% variation in strength. Likewise, it is assumed that every source of stress is the same. This may not be true as the sources of stress may vary by serial number, customer use or customer environment.

Example 3.5 - The S-N Curve

The meaning of the S-N curve can be described fairly simply. Most materials have a limit (fatigue) below which any stresses have very little impact. The life of the system is essentially infinite because no cracks or other sources of system damage can be initiated and propagated. Above the fatigue limit the life is limited and strongly stress dependent. A plot of the log of stress versus the log of life often produces the two straight lines. One line for each of the two different relationships that are present. The fatigue limit is located at the knee of the two lines. Many materials can be simply described in this fashion. However, some caution is required when employing this relationship. It is well known that for some high levels of stress this relationship breaks down. That is, an upper limit may exist for some materials. For other materials or applications of stresses, this may be a poor description of the initiation of damage to propagation of damage to ultimate failure. Simply said, there are situations where Miner's rule does not work. It is not surprising that tension, shear, compression could be found for certain stresses or materials where a more complex formula would be required. It is probably best to treat Miner's rule as a first approximation for iron, steel, bronze and aluminum over the range of 10^3 to 10^7 stress cycles of life [14]. Outside of this cycle range, the model should be employed very cautiously. Rao [3] and Carter [6] indicate application limits do exist, but neither is able to be more specific and suggest limits. Mischke [14, p.13.8] cites different S-N curves for the same material when stresses are applied by different methods. Slightly different curves exist for narrow band stresses versus sinusoidal applied stresses or even by constant stress loads. When repetitive cycles of stress are applied to a material, fatigue usually occurs at a much lower stress level than the ultimate strength. This is due to the accumulation of damage. It may be described by crack theory.

Typically, a power law relationship is employed to describe the S-N, stress-cycle life relationship. A simple stress-strain relationship for the uniaxial and multiaxial situations can be described as:

$$\boldsymbol{\varepsilon} = \left(\frac{\boldsymbol{\sigma}}{D}\right)^n \text{ models the uniaxial case and } \boldsymbol{\varepsilon}_{ij} = \frac{3}{2} \left(\frac{\bar{\boldsymbol{\sigma}}}{D}\right)^{n-1} \left(\frac{S_{ij}}{D}\right) \text{ models the multiaxial case} \quad (3.4)$$

Where $\boldsymbol{\sigma}$ is stress, D is related to the Young's Modulus and $\boldsymbol{\varepsilon}$ is the strain. Employing a simple elastic-plastic model to describe stress-strain situation we would have the Ramberg-Osgood relationship.

$$\boldsymbol{\varepsilon} = \boldsymbol{\varepsilon}^e + \boldsymbol{\varepsilon}^p = \left(\frac{\boldsymbol{\sigma}}{E}\right) + \left(\frac{\boldsymbol{\sigma}}{D}\right)^n \quad (3.5)$$

This macroscopic model is based upon a power-law relationship and can be directly related to an S-N curve. Cruse [9] shows that the microscopic crack propagation also follows a power low type relationship for a variety of geometries. A simple linear plane of width 2h under tension $\boldsymbol{\sigma}$ with

an initial crack of length $2a$, has a stress intensity factor at the tip of the crack which is K . This factor is related to the tension in the plane and crack length through:

$$K = (\sigma) \left[\frac{\sqrt{\pi(a)}}{\sqrt{1-\alpha}} \right] [1 - 0.5\alpha + 0.37\alpha^2 - 0.044\alpha^3] \quad (3.6)$$

Here, $\alpha = \frac{a}{h}$ and ranges from 0 to 1.0

Figure 3.3 shows this geometry in detail. It assumes the X-Y plane is uniform.

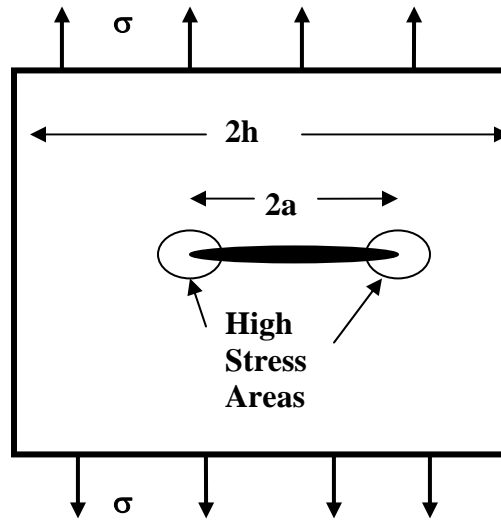

Figure 3.3 – Crack Propagation in a Large Plane

Let the value of α be 0.01. With $\sigma = 5000$ PSI, $\sigma_{ys} = 12,000$ PSI for Aluminum shear and $a = 0.01$ inch, we can fill in equation 3.6.

$$K = 5000 \left[\frac{\sqrt{\pi(0.01)}}{\sqrt{1-0.01}} \right] [1 - 0.5(0.01) + 0.37(0.01)^2 - 0.044(0.01)^3]$$

$$K = 5000[0.178138][0.995037] = 886.27 \text{ PSI}$$

This is the localized effective stress that drives the crack growth at the tips of the crack. Next, the stress will determine if the material at the tips of the crack are in the elastic or plastic region. Treating the zone around the crack tip as a small circular region we have the radius of the plastic zone estimated as:

$$r_y = \frac{1}{2\pi} \left(\frac{K}{\sigma_{ys}} \right)^2 = (0.15915)(0.07746)^2 = 0.00095 \quad (3.7)$$

This is, the plastic region extends out about 0.00095 inch from the tip of the crack in a circle. It is

this high stress region that will continue to grow under repeated stresses, because it is no longer elastic. When α is 0.001, the region is still 0.00087 inch in size for a crack of initial size 0.01 inch. We conclude small cracks grow slowly and the rate of growth increases as the crack size increases.

The crack growth formulas rapidly get complex when non-uniform characteristics exist or when primary and secondary creep are added to the situation. In all cases, the stress relationship can be written as a power law. This means the macroscopic S-N curve should provide a reasonable approximation when kept within reasonable limits. Even materials such as solder should follow a simple power law relationship when stressed by thermal cycles or mechanical cycles. Some common electronic package applications also exist for the use of S-N curves. Figure 3.4 provides a simple model for the S-N curve over the range of reasonable interest for most materials and situations.

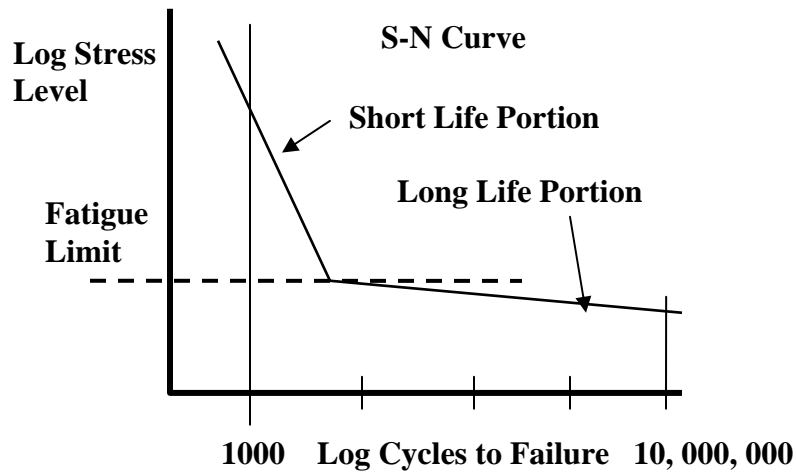

Figure 3.4 – The S-N Curve

3.2 - Reduction of Random Stresses

Multiple levels of stress exist on a piece of metal as shown in Figure 3.5. Observations over time allow us to lump the apparently erratic stresses into seven different levels of stress. These levels are summarized in a Table 3.2. The situation can best be described by stresses that may be applied in random order and time. We will use Miner's Rule to describe and summarize this situation.

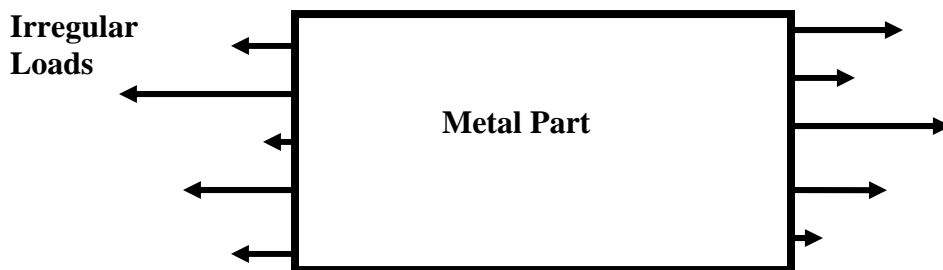

Figure 3.5 – Summary of Irregular Loads on a Metal Part

The many different loads applied to the metal part may be reduced to an equivalent total that cover all of the stresses. The stresses may be positive as well as negative in sign representing both tension and compression. Figure 3.5 and Figure 3.6 shows this in detail. All stresses applied can be lumped into one of the seven stress categories as shown in Figure 3.6 and Table 3.2. The number of each stress that were observed during a given time period are shown in the table. This allows one to calculate the equivalent damage and then determine the accumulated overall damage to the metal part.

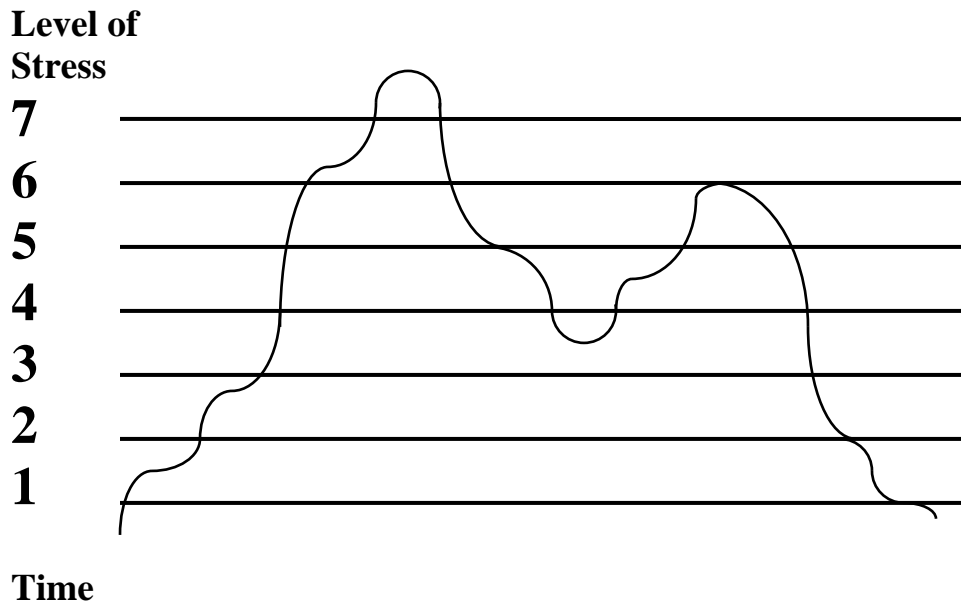

Figure 3.6 – Simple Time Listing of Stresses

Table 3.2 - Summary of Irregular Loads Data			
Stress Level	Occurrence Observed (n_i)	Cycles to Failure Data (N_i)	Ratio n_i/N_i
11.7 KSI	335 cycles	4.6×10^7	7.283×10^{-6}
12.5 "	284 "	$3.0 \times "$	$9.467 \times "$
13.3 "	217 "	$1.8 \times "$	$12.056 \times "$
14.1 "	167 "	$1.1 \times "$	$15.182 \times "$
14.9 "	110 "	7.2×10^6	$15.278 \times "$
15.7 "	75 "	$4.8 \times "$	$15.625 \times "$
16.5 "	52 "	$4.2 \times "$	$12.381 \times "$
	-----		-----
	1240 total cycles observed		87.272×10^{-6}

Accumulated contributions to system failure may be expressed as:

$$C = \sum_{i=1}^k \frac{n_i}{N_i} = 87.272 \times 10^{-6}$$

The equivalent number (single stress) of cycles to fatigue can be expressed as:

$$N_{equil.} = \frac{1}{C} \sum_{i=1}^k \frac{n_i}{N_i} = \frac{1240 \text{cycles}}{87.272 \times 10^{-6}} = 14.21 \times 10^6 \text{ cycles} \quad (3.8)$$

The data can be described by the following equation for the cycles to fatigue versus the stress. Note this is the upper, short life curve of the S-N diagram. The **actual formula** for this portion of the S-N Curve is:

$$N_i = [2.466 \times 10^{10}] e^{-0.539S} \quad (3.9)$$

so we can write $N_{equil.} = 14.21 \times 10^6 = [2.466 \times 10^{10}] e^{-0.539Seq.}$

$$5.762 \times 10^{-4} = e^{-0.539Seq.}$$

$$-7.459 = -0.539Seq.$$

$$Seq. = \mathbf{13.839 \text{ KSI}} = 13,839 \text{ PSI}$$

This is a moderate level of stress for most metals since KSI = 1000 PSI

This number represents the single equivalent stress that would describe the seven various levels of stress actually present in the frequency cited. We did not calculate an equivalent unit of time to describe the average system life. All we know is the number of **equivalent cycles** to failure. This calculation provides an observed value of $A = 11,458.4$ "units of time" (i.e. $1,000,000 / 87.272$) over which the expected $N_{equil.}$ or 14,210,000 cycles of 13.839 KSI stress would have occurred.

3.3 - Confidence Limits for S-N

Real world uncertainty may be added to the S-N calculation through estimating confidence. Assume the material strength is normally distributed and has a $\pm 10\%$ variation to cover the range of 6σ . We then can simply write using equation 3.9.

Example 3.6 – Confidence Limits Calculation

For a Lower confidence limit

$$N_{iLC} = (0.9) [2.466 \times 10^{10}] e^{-0.539S} \text{ as the } \mathbf{lower \ limit} \text{ on cycles to failure}$$

And an Upper confidence limit

$$N_{iUC} = (1.1) [2.466 \times 10^{10}] e^{-0.539S} \text{ as the } \mathbf{upper \ limit} \text{ on cycles to}$$

failure

We are assuming the shape of the variation is constant over the stress range in question as shown in the modified S-N curve below. This does not have to be true. Calculating the upper and lower limits on cycle life at the nominal stress of 13.839 KSI from example 3.6 provides:

$$N_{iLC} = (2.219 \times 10^{10})(5.758 \times 10^{-4}) = 12.777 \times 10^6 \text{ cycles to fail at lower limit } (-3\sigma)$$

$$N_{iUC} = (2.713 \times 10^{10})(5.758 \times 10^{-4}) = 15.621 \times 10^6 \text{ cycles to fail at upper limit } (+3\sigma)$$

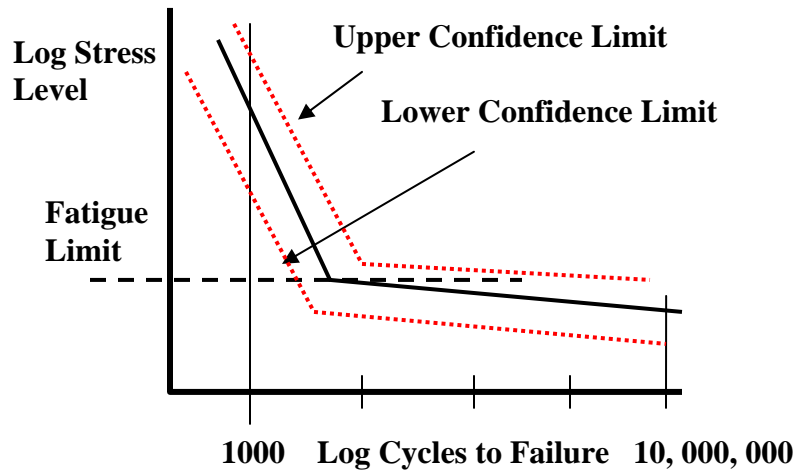

Figure 3.7 – Confidence Limits on the S-N Curve

The confidence limits as plotted on the S-N graph shows that these limits parallel the basic S-N curve itself. There are many different ways to calculate confidence limits and these will be explored in detail in a later section.

3.4 - Interference When Distributions are Non-Normal

The following examples present a more realistic picture of many materials and stresses that may be described by various distributions. Distributions that are possible include extreme value, Weibull, Normal or Lognormal covering either load or strength. The following example shows the approach for the Normal and Weibull distributions. This example is common for rotating situations and full reversing loads such as reciprocal pumps or with thermal cycles.

Example 3.7 - Interference of a Normal and Weibull Distribution

A round aluminum bar is turned repeatedly to full stress levels of ± 25.0 KSI with a standard deviation of 2.50 KSI. This represents the maximum stress at the ends of the circular travel of an Aluminum bar. Figure 3.8 shows this situation in detail. The stresses are within the bar and maximum at the ends.

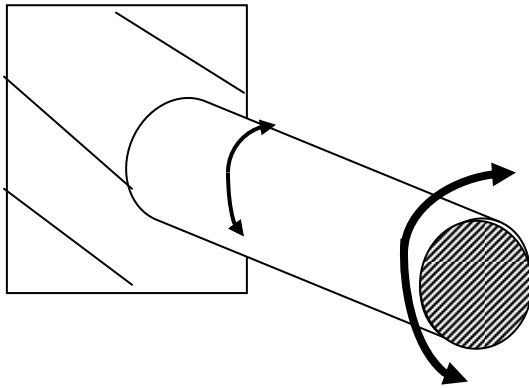

Figure 3.8 – Cyclic Stress in an Aluminum Bar

A design life of at least 500,000 cycles is desired for an Aluminum Alloy, Al 7079 - T652, as forged and surface polished to a "16 finish". We look up the properties of this aluminum alloy in any good handbook. Here the RAC Mechanical Applications Handbook [7], in Table 3.6-3 or the TR-68-403 Handbook [20] can be employed. These handbooks detail the properties of a variety of materials and document a number of interference distributions. The calculations that follow represent the minimum material strength needed for surviving to 500,000 cycles. The initial strength of material is above 60 KSI. When looking at these tables **be wary**, the X_0 parameter is not defined as is normally done with a three parameter Weibull in reliability. This example **does not** follow the unconventional labeling found in the two 1968 handbooks. Here, I follow the conventional labeling of most reliability books the standard Weibull labeling convention. This is sometimes inconsistent with standard mechanical engineering notation and usage.

Table 3.3 - Characteristics of the Round Bar	
Load Distribution Parameters	Strength Distribution Parameters
$\mu = 25.0$ KSI	$\beta = 3.13$
$\sigma = 2.5$ KSI (or 10% of mean)	$\eta = 31.32$ KSI
Upper limit = 32.5 KSI	$\gamma = 22.11$ KSI
Lower limit = 17.5 KSI	

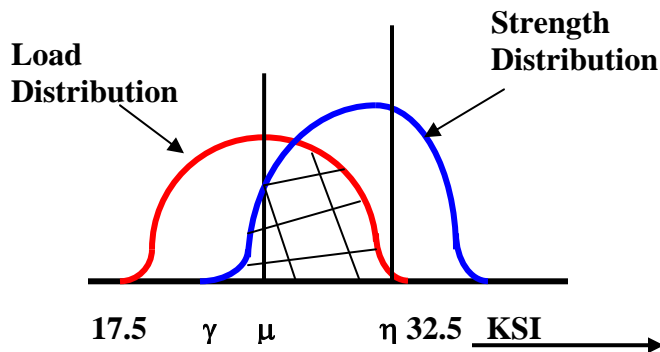

Figure 3.9 – Interference of the Normal and Weibull Distribution

The Load is modeled by starting with the lowest point of the Weibull distribution and expressing this in terms of location within the Normal distribution Z score gives:

$$Z_{Stress} = \frac{\gamma - \mu}{2.5} = \frac{22.11 - 25.0}{2.5} = -1.16 = A$$

Weibull Strength is modeled by starting with the highest point of the Weibull distribution and expressing this in terms of location within the Normal distribution Z score gives:

$$Z_{Strength} = -\frac{\gamma - \eta}{2.5} = -\frac{22.11 - 31.32}{2.5} = 3.68 = C$$

We use these two numbers to look up the interference in the RAC Table 3.6-4. This table has entries for integer values of β for 3.0 and 4.0. We interpolate between these two entries for the value of $\beta = 3.13$, staying in the correct columns for a cycle life of 500,000 cycles. The tables showing the interference are proportional to the probability of failure.

$$\text{Interference} = 0.0897$$

This number was interpolated from the two tables based on the values of A(note this is negative) and the value of C

$$\text{Reliability} = 1 - \text{Interference} = 0.9103$$

Describes the interference of the Normal Load with Weibull Strength situation.

Example 3.8 - Approximation by Equivalent Distributions

Had we done the Example 3.7 calculations with a **Normal distribution for strength** (instead of Weibull) we could have used the regular interference of two Normal distributions formula. In this case we would use the **median value** of the Weibull distribution as the mean of the equivalent Normal distribution. Set the approximate "Weibull range", here 0.3% to 99.7%, divided by 6 to represent the approximate standard deviation for 6σ . The basic calculations become:

$$\begin{aligned} \mu_{equil.} &= \eta(\ln 2)^{\frac{1}{\beta}} = 31.32(\ln 2)^{\frac{1}{\beta}} = 31.32(0.8895) = 27.859 \\ \sigma_{equil.} &= \frac{1}{6}(38.09 - 23.53) = 2.427 \end{aligned}$$

We replace the value of η , the characteristic life, with the equivalent "normal median" and employing a new distribution that covers the same range as the original Weibull distribution. We can then write as before:

$$Z_{score} = \frac{27.859 - 25.0}{\sqrt{(2.427)^2 + (2.5)^2}} = \frac{2.859}{3.484} = 0.8206$$

and Reliability = 0.7940 with this Normal model

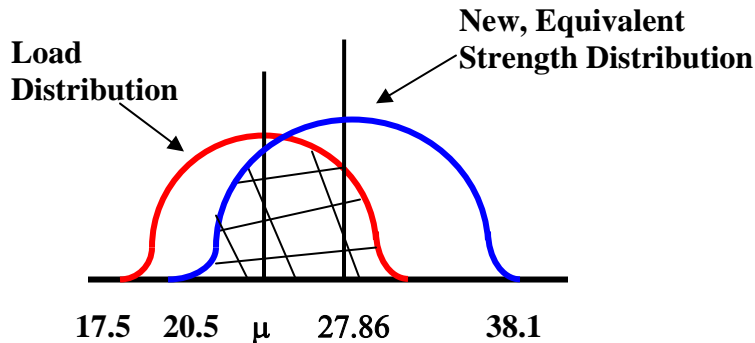

Figure 3.10 – An Equivalent Normal Distribution for Strength

The reason this value is very low as compared to the Example 3.7 is that the strength distribution has been **artificially shifted downward** by the use of the "equivalent normal model" as shown in Figure 3.10. Since the original Weibull model was skewed, the *equivalent normal* distribution model really is a poor fit to the original Weibull distribution. The estimate of the equivalent standard deviation could also be improved in this case. Why show this example at all? It is because the use of equivalent normal ranges is common when the true distribution is unknown or complex. Most of the time, the error in reliability is smaller than as shown in Example 3.8. This approximation is also useful when the special tables are not handy. Be cautious about approximating distributions in many situations.

Example 3.9 - An Improved Approximation

An alternative approach might be to use the mean of the equivalent Weibull distribution which is to be found by calculation. The following formula is the easiest way to obtain the value of the mean from the Weibull parameters.

$$\text{Mean} = \eta \Gamma(1 + 1/\beta)$$

$$\text{Mean} = (31.32) \Gamma(1.3194) = (31.32)(0.8947) = 28.06$$

$$\text{Lower Limit at 1\% failures} = 24.23$$

$$\text{Upper Limit at 99\% failures} = 37.11$$

The lower and upper limits were estimated from the original Weibull distribution parameters.

$$\sigma_{\text{equil.}} = \frac{1}{6} (37.11 - 24.25) = 2.14$$

This better estimate for σ exists from ignoring the extended tails of the Weibull distribution. The Normal, doesn't have the spreading tails. This approach is also common as it represents an attempt to improve the result without using an improved model. Some do this once in a while. This example shows how it is possible to improve approximations by being careful. Filling in the same equations above provides the following new numbers.

$$Z_{score} = \frac{28.06 - 25.0}{\sqrt{(2.14)^2 + (2.5)^2}} = \frac{3.06}{3.29} = 0.9301$$

and Reliability = 0.8240 in this improved approximation.

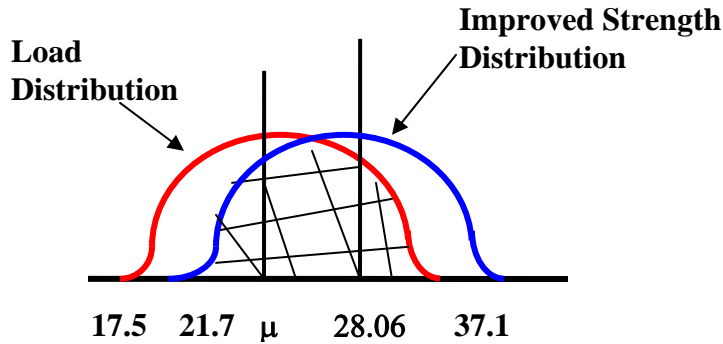
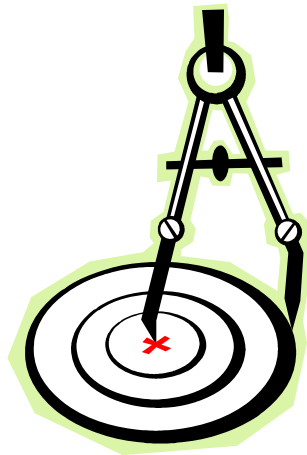

Figure 3.11 – An Improved Normal Distribution for Strength

A short summary of these three reliability examples provides the following table of information. This example shows the range of possible answers when approximating solutions. Most of the time the approximations are closer to the exact answer than in these two approximation cases. It demonstrates why one should work with exact solutions whenever possible.

Exact Answer	Simple Normal Approximation	Improved Normal Approach
R = 0.9103	R = 0.7940 - 12.8% error	R = 0.8240 - 9.5% error



4.0 - Mechanical Reliability Predictions

4.1 Background of Predictions - Mechanical reliability predictions are being increasingly performed on a wide variety of systems, assemblies and components. These predictions are unlike electronic predictions for several main reasons. These include:

1) Most mechanical components, assemblies and systems are **wear dependent** over most of their life. This eliminates some of the common models such as exponential reliability. When wear dominates an assembly, it becomes critical to control the rate of wear to a low level in order to permit a long life. If wear occurs at higher rates, a short life or frequent maintenance may be the result.

2) **Mechanical functions may be standard**, but not mechanical components. A cam may be consist of three or four components and this becomes a standard building block. It may not matter much that the cam is one cast piece of homogeneous metal or two shaped pieces of dissimilar metal such as an actuator, a load bearing surface and a bushing. Both may serve the same function, but the multi-piece cam is expected to cost more, but have a longer life. It is difficult to analyze the exact function of a cam without all of the mating components in place to understand the stresses present and watch the function.

3) Mechanical components are often operated at very different stress levels than electronic components. Sometimes this is at higher relative stress and other times it is lower. Electronic components are typically operated from 20% of their stress rating to 80% of their rated stress. Mechanical components may be operated in the range of 5 50 10% stress to preserve long life. Other applications demand operating stresses be near 100%

4) Further differences exist between standard electronic components and mechanical components. Standard mechanical reliability models assume that the failure rate and hazard rate are not constant over any point of the life of a mechanical component. That is, they generally decrease or increase with time as shown in Figure 4.1. There may be a short "wear-in" period often with decreasing hazard rate while a new mechanical component or assembly "takes a set", "works out the bugs" or "burnishes the wear surfaces". A number of euphemisms are employed to describe this period. It is sometimes difficult to make the proper reliability estimate for this wear-in section. Later a much longer wear period usually exists and this dominates the life. Since the wear-in period is usually short, some people use models that act as if it were not present. Others develop models to treat this complex wear-in and wear behavior *as if it were* constant over some period of time. An average value is then employed with such simple models. References [1 to 5] provide some additional information on a variety of mechanical failure rate models.

Using a constant or non-constant failure rate model we could estimate the failure rate of a simple "component", assembly or system based upon an understanding of its functions, internal stresses and loads. The following three examples show the main of the three approaches commonly in use for mechanical prediction applications. A fourth approach, Finite Element Analysis, will not be considered in this book, as a detailed discussion is beyond the scope.

Example 4.1 – A Motor Reliability Model

Consider the failure rate of a population of electric motors. The old Military Handbook 217 revision F (Hereafter Mil-Hdbk 217) provided the following simple failure rate model for a variety of generic electric motors. There was no distinction between types of motors (DC, synchronous or stepper) in any of these models. This handbook provides a formula for estimating the average failure rate over some period of time. Note that one term increases with time and the other appear to decrease with time.

$$\text{Average Failure Rate} = \left[\frac{t^2}{\alpha_B^3} + \frac{1}{\alpha_W} \right] \times 10^6 \text{ failures} / 10^6 \text{ operating hours} \quad (4.1)$$

The AFR is expressed in failures per hour over the operating period “t”.

This model is based upon the operating temperature, which is hidden in the terms α_B and α_W . This temperature dependence ultimately determines the characteristic life for the bearing term (α_B) and winding term α_W , respectively. If the motor is to operate for 15,000 hours at 60°C internal temperature on the average, then the estimate of the time average failure rate can be calculated. The numbers are from the Mil-Hdbk 217F (1992) and are:

$$\bar{\lambda} = \frac{(15,000)^2}{(3.5 \times 10^4)^3} + \frac{1}{1.8 \times 10^5} = \frac{2.25 \times 10^8}{4.288 \times 10^{13}} + 5.56 \times 10^{-6}$$

or
$$\bar{\lambda} = 5.247 \times 10^{-6} + 5.56 \times 10^{-6} = 1.081 \times 10^{-5} \text{ failures per operating hour}$$

This number is equal to = 10, 807 FITs or failures per billion operating hours

RIAC document 217 Plus [22] has no entry for motors and Telcordia [23] lists motors as 500 FITs. The Carderock Mechanical Prediction Handbook [12] does not list motors. The RAC Non-Operating data book [24] lists storage failure rates running from 45 FITs to 2379 FITs for different types of motors.

A diagram of this two part failure rate model from Mil-HDBK 217 is shown in Figure 4.1. The average equivalent failure rate is drawn in to show how it doesn't match the active model.

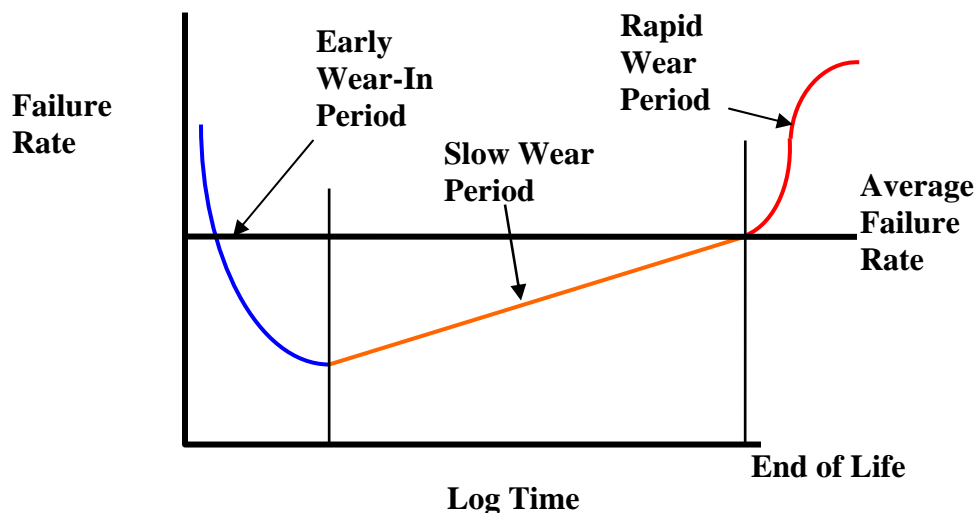

Figure 4.1 – The Mechanical Bathtub Curve

Example 4.2 -Consideration of Wear

A wear process is often created by having one material slide over another. Even if lubrication is present, a slow wear of both surfaces may occur. This rate of material wear usually remains low for a long time, but then begins to increase near the end of life. The term wear-out may be used at this point of life. Be careful not to confuse wear and wear-out. Wear is the process and wear-out is the end result of a failure.

A prior life test of some samples had established the rate of wear may be best described by the Weibull function through the shape parameter β . The wear-in period might be described with a $\beta = 0.75$, while the slow wear period may be described by a value of β ranging from 1.25 to 1.50. The rapid wear phase may be described by values β above 2.0. The cross-over point for the various curves may become important. Say, that the prior test suggested that this cross over was around 50 operating hours with about 2% total failures in a large sample by this point. The bottom of the failure rate curve can be set at this time and two different Weibull curves smoothly spliced. Each of the two failures rates from the two different Weibull distributions must be equal at this point in time. The slopes are expected to be different at this point and may not be related.

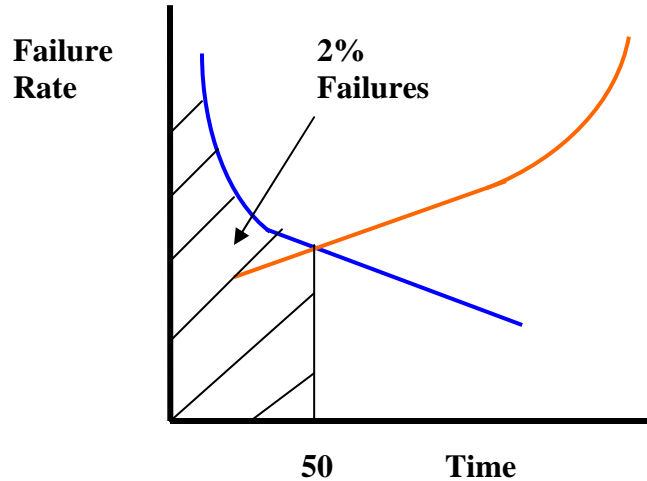

Figure 4.2 – The Spliced Early Portion of the Bathtub Curve

With this information we can write:

$$R_{50} = 0.98 = e^{-\left(\frac{50}{\eta}\right)^\beta}$$

This formula describes the first portion of the bathtub curve. Since there is only one unknown, we can solve for it. This becomes:

$$\eta_1 = 8969.7 \text{ hours}$$

Describes the decreasing failure rate distribution situation of the early distribution. Using the fact that we have equality at 50 hours we can write:

$$\frac{\beta_1}{(\eta_1)^{\beta_1}} (t_{50}^{\beta_1-1}) = \frac{\beta_2}{(\eta_2)^{\beta_2}} (t_{50}^{\beta_2-1}) \quad (4.2)$$

Equating the hazard rates at 50 hours for the two distributions provides $\eta_2 = 1693.3$ hours. With this information we can construct Table 4.1 for hazard rate values as a function of operating time.

Time	Hazard rate	Time	Hazard Rate
1 hour	814×10^{-6}	500 hours	544.3×10^{-6}
5 "	544.4 "	1000 "	647.3 "
25 "	364 "	2000 "	769.7 "
50 "	306.1 "	5000 "	967.9 "
100 "	363.9 "	10,000 "	1151.1 "
250 "	457.7 "	20,000 "	1368.8 "

The time period to 2,000 hours corresponds to a total of 71.61% failure. This data is plotted as the bathtub curve in Figure 4.3. This data set could also have been converted the **average** hazard rate of 358.1×10^{-6} failures per operating hour over the first 2,000 hours. Other average values would be calculated for different time frames. For purposes of many reliability predictions a real dynamic hazard rate curve is often preferred to static data when the real curve can be calculated. Otherwise, static models such as portrayed by the average data are seldom a good fit to real time dependent systems. Dynamic curves are really needed to estimate the time-dependent hazard rates of real components, assemblies and systems.

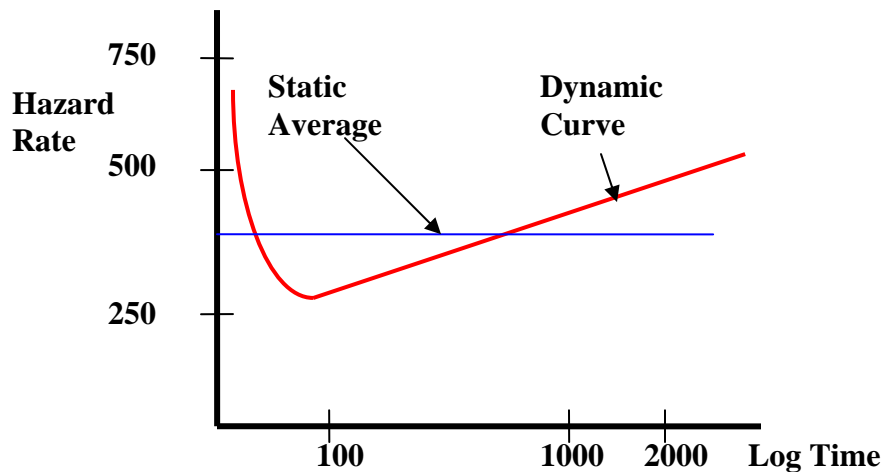

Figure 4.3 – A Dynamic Hazard Rate Curve

4.2 - The Carderock Models of Mechanical Reliability

The Carderock Mechanical Reliability Manual [12] has created a number of failure rate models for mechanical components and applications. Many look similar to the electronic components found in either Mil-Hdbk 217 or the Telcordia Handbook. A review of some of these models will prove enlightening. Most are based upon that idea that the failure rate of any component can be modeled

through a base failure rate that is modified by a series of multiplicative factors. The following examples are typical ones for many mechanical components. The “C factors” in the mechanical handbook are analogous to the “ π ” factors in Mil-Hdbk 217 and Telcordia. A few simple examples show that the correction factors must be looked at carefully in order to select the best choices. Not every choice may exist to correspond to all possible situations.

Example 4.3 - A Coil Spring

Pretend that you are designing a spring for a certain application. The following characteristics arose as part of your design. The spring should be made from a spring temper steel alloy with a wire diameter of 0.050 inch, a coil diameter 1.0 inch and have 12 active coils present. The desired compression, or cycle travel will most often be about 0.25 inches and this will occur on the average of about 10 times an hour, 24 hours per day and seven days a week. These cycles are of short duration in time, so it is the cycle count that is important. The basic Carderock numerical model for this type of coil spring is:

$$\lambda_{sp} = \lambda_{sp}^{base} C_G C_{DW} C_{DC} C_M C_Y C_L C_K C_{CS} \quad (4.3)$$

where the terms are defined by

- λ_{sp}^{base} is a base failure rate of 0.65 failures per million operating cycles.
- C_G corrects for spring material rigidity.
- C_{DW} is a correction for the wire diameter.
- C_{DC} is a correction factor for the spring coil diameter.
- C_M is a correction factor for the number of active coils.
- C_Y is a correction factor for material tensile strength
- C_L is a correction factor for spring deflection (compression or expansion)
- C_K is a correction for stress concentration in the spring based upon the Wahl factor
- C_{CS} is a correction for the spring cycle rate

Each of the correction factors has either a formula that relates the operating environment, or detailed stress, or consists of a look up table to obtain the correction number that best fits the end use environment of the coil spring. Once these have been calculated or determined the whole formula may be filled. Thus we would have:

$$\lambda_{sp} = \lambda_{sp}^{base} C_G C_{DW} C_{DC} C_M C_Y C_L C_K C_{CS}$$

$$\lambda_{sp} = (0.65/1,000,000)(1.0)(0.27)(0.038)(1.59)(0.47)(0.0128)(0.677)(1.0)$$

$$\lambda_{sp} = 0.0432 \times 10^{-9} \text{ failures per operating cycle}$$

$$\lambda_{sp} = 10.368 \times 10^{-9} \text{ failures per day} = 3.79 \times 10^{-6} \text{ failures per year}$$

Where individual formulas for corrections are:

$C_G = \left(\frac{G_m}{11.5}\right)^3$ and ranges from 0.5 to 1.0 with G_m as the material rigidity expressed in 1,000,00 PSI

$C_{DW} = \left(\frac{D_w}{0.085}\right)^3$ and ranges from 0.2 to 5.0 with D_w as the wire diameter expressed in inches

$C_{DC} = \left(\frac{0.58}{D_C}\right)^6$ and ranges from 0.07 to 20.7 with D_C as the coil diameter expressed in inches

$C_M = \left(\frac{14}{N_a}\right)^3$ and ranges from 0.26 to 12.7 with N_a as the number of active coils; which is commonly the total number of coils minus two.

$C_Y = \left(\frac{190}{T_s}\right)^3$ and ranges from 0.47 to 9.40 with T_s as the tensile strength expressed in KSI

$C_L = \left(\frac{D_L}{1.07}\right)^3$ and ranges from 0.03 to 7.03 with D_L as the spring compression in inches

$C_K = \left(\frac{K_w}{1.219}\right)^3$ and ranges from 0.552 to 4.415 where K_w is the Wahl factor. $K_w = \frac{4r-1}{4r-4} + \frac{0.615}{r}$
and the factor $r = \text{Spring Diameter/Wire Diameter}$

C_{CS} is selected based upon the rate of cyclic operation. $C_{CS} = 1$ when the spring cycle rate is less than 300 cycles per minute. From 301 to 360 cycles per minute $C_{CS} = 6.0$, Above 360 cycles a minutes $C_{CS} = 12.0$

There is no correction for corrosion or surface plating added to the spring wire. What is the projected failure rate of a spring with the following characteristics?

Example 4.4 - Hard drawn steel as spring material, 10 coils total in a helical winding, wire diameter of 0.150 and coil diameter of 0.500, material tensile strength is for spring temper steel, typical compression is 0.5 inch with a rate of cycling at 1 time per minute.

$G_m = 11.5 \times 10^6$ for material rigidity factor, $C_G = 1.00$

$$C_{DW} = \left(\frac{D_w}{0.085}\right)^3 = \left(\frac{0.150}{0.085}\right)^3 = 5.496$$

$$C_{DC} = \left(\frac{0.58}{D_C}\right)^6 = \left(\frac{0.58}{0.50}\right)^6 = 2.436$$

$$C_M = \left(\frac{14}{N_a}\right)^3 = \left(\frac{14}{8}\right)^3 = 5.359$$

$$C_Y = \left(\frac{190}{T_s}\right)^3 = \left(\frac{190}{245}\right)^3 = 0.4664$$

$$C_L = \left(\frac{D_L}{1.07}\right)^3 = \left(\frac{0.50}{1.07}\right)^3 = 0.1020$$

$$C_K = \left(\frac{K_w}{1.219}\right)^3 \text{ with } K_w = \frac{4r-1}{4r-4} + \frac{0.615}{r} \text{ with } r = 0.500/0.150 = 3.333 \text{ thus } K_w = 1.303, \text{ so}$$

$$C_K = \left(\frac{K_w}{1.219}\right)^3 = \left(\frac{1.303}{1.219}\right)^3 = 1.2213$$

$C_{CS} = 1.0$ since this is a slow cycle rate of 1 cycle per minute.

$$\lambda_{sp} = \lambda_{sp}^{base} C_G C_{DW} C_{DC} C_M C_Y C_L C_K C_{CS}$$

$$\lambda_{sp} = (0.65 \times 10^{-6})(1.0)(5.496)(2.436)(5.359)(0.4664)(0.102)(1.2213)(1.0) = (0.65 \times 10^{-6})(4.1686)$$

$$\lambda_{sp} = 2.7096 \times 10^{-6} \text{ failures/operating cycle}$$

Thus, at 1440 operating cycles per day, the failure rate becomes 0.0039 failures per day or 0.2029 failures per year.

Example 4.5 – A Roller Bearing

It is time to look at a roller bearing as an example. Waloddi Weibull described the life of these in the 1930s using the distribution which was named after him. Load and fatigue usually limit the operating life of the ball bearings and other types such as roller bearings. These have similar stress-life relationships, but the focus will be on the ball bearings. Lubrication, proper alignment, freedom from corrosion and contaminants, lack of shock or extremes of temperature all help ensure the long life of bearings. A study of roller bearing failures discovered that the causes broke into three categories. These were supplier related (30.1%) which included workmanship, material and construction. User problems were 65.9% which included high wear, improper maintenance, defective mounting, high vibration levels and electrical currents in the bearing. The remaining failures causes were 4.0% and included items such as failure to adequately lubricate and contaminated lubricants.[25]

A simple time dependent model for the average (mean) bearing life of roller bearings is:

$$\lambda_m = \frac{(t)^{\alpha_1}}{(\eta)^{\alpha_2}} \quad (4.4)$$

where $\alpha_1 = 1.88$, $\alpha_2 = 2.88$, η is the Weibull characteristic life which is dependent upon load, lubricant type and operating temperature. Lastly t is the operating time. This model shows a strong increasing failure rate as a function of time. It should look similar to Figure 4.3, except any early wear-in or early life portion would be very short and is neglected by this formula.

Example 4.6 – Ball Bearings – Bearing Life can be described by another formula that ignores time dependence, but covers the stress-life relationship. This is shown in equation 4.5 and can be found in most vendor bearing books and many reliability texts. The formula covers both ball bearing and roller bearings.

$$\lambda_{BE} = \lambda_{BE}^{base} \left(\frac{C}{P}\right)^\gamma \quad (4.5)$$

λ_{BE} is the constant failure rate expressed in failures/million revolutions

λ_{BE}^{base} is a base failure rate derived from a B_{10} life

C is the dynamic load expressed in pounds
P is the equivalent radial load expressed in pounds
 γ is a constant. It is 3.0 for ball bearings and 3.33 for roller bearings

This equation is also described by the following relationship

$$\lambda_{BE} = \lambda_{BE}^{base} C_Y C_v C_{CW} = \lambda_{BE}^{base} \left(\frac{L_A}{L_S} \right)^\gamma \left(\frac{v_0}{v_L} \right)^{0.54} C_{CW} \quad (4.6)$$

Here the terms are defined by:

γ is a constant. It is 3.0 for ball bearings and 3.33 for roller bearings
 L_A is the equivalent radial load in pounds
 L_S is the vendor rated maximum bearing load capacity expressed in pounds
 v_0 is the specified lubrication viscosity in lb-min/in²
 v_L is the operating lubrication viscosity in lb-min/in²
 C_{CW} is a water contamination factor, expressed as the following formula where CW is the percentage of water in the lubricant

$$C_{CW} = 1.04 + 1.03CW - 0.065 (CW)^2$$

Let $(L_A/L_S) = 0.5$ and $v_0/v_L = 1.0$, if the water concentration, CW is 2%, what is the ratio of failure rate to base failure rate for a ball bearing system?

$$\lambda_{BE} = \lambda_{BE}^{base} (0.5)^3 (1)^{0.54} [1.04 + 0.0206 - 0.000026] = \lambda_{BE}^{base} (0.125)(1.06063)$$

$$\lambda_{BE} / \lambda_{BE}^{base} = 0.1326$$

The failure rate would be low at half the rated bearing load, at rated lubrication viscosity and low water.

Example 4.7 - Reliability Calculation from First Principles

Estimate the failure rate of an aluminum faucet adaptor that is internally threaded. The diameter is 1.25 inch with 1/8 thick walls and threads about 0.093 deep on each wall.

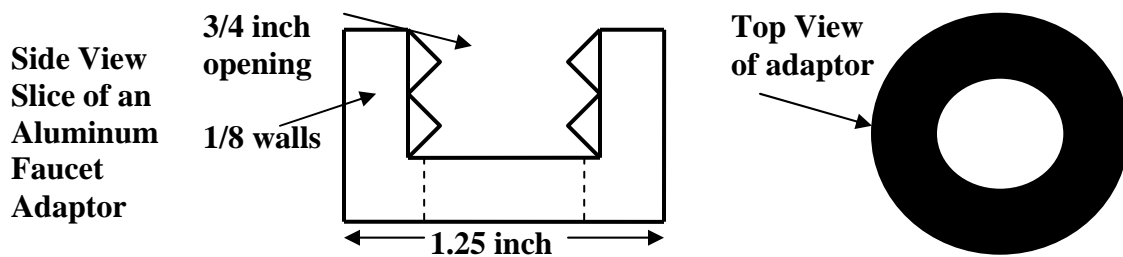

Figure 4.4 – An Aluminum Faucet Adaptor

With the wall thickness of 1/8 inch and inner wall height of 3/4 inch, this represents the minimum material strength for shear, which is the main failure mode of concern. Calculating this gives:

$$\text{Ultimate Tensile Strength} = (1/8 \text{ in.})(3/4 \text{ in.})(12,000 \text{ lbs/in.}^2) = 1125 \text{ lbs.}$$

$$\text{Using shear yield at 60\% of tensile strength we have } (0.60)(1125) = 675 \text{ lbs.}$$

$$\text{On the diameter we have a maximum permissible torque of } \frac{675}{0.625} = 1080 \text{ in.-lbs.}$$

A typical customer employing a 12 inch pliers to tighten the nut would place 600 in.-lbs. maximum on the adapter. This becomes a static daily load as temperatures and usage continues to maintain this pressure on the adaptor. We can estimate reliability. Using a 7% variation on strength and 10% on the load.

$$R = \Theta \left[\frac{1080 - 600}{\sqrt{(75.6)^2 + (60)^2}} \right] = \Theta \left[\frac{480}{96.516} \right] = \Theta(4.9733) = 0.999,999,671$$

This reliability is for a one time stress. If we make the assumption that 4 times a day this level of stress is placed upon the adapter through normal use and all other stresses are treated as small, we have. The approximate one year reliability assuming slow accumulation of fatigue is:

$$R_{\text{year}} = (0.999,999,671)^{1460} = 0.999,518,316$$

The mean life would be expressed as

$$R_{\text{mean}} = 0.368 = (0.999,518,316)^X$$

$$X = 2074.9 \text{ years as the mean life}$$

The equivalent failure rate over this period of time is:

$$\bar{\lambda} = \left(\frac{0.368}{2074.9} \right) \left(\frac{1}{8760} \right) = 2.025 \times 10^{-8} \text{ failures/operating hour}$$

or $\bar{\lambda} = 20.25 \text{ FITs}$

Example 4.8 - Maximum Applied Stress

This example looks at stress in a 3/8 inch diameter brass actuator piece. If we have a brass piece shaped as shown in Figure 4.5. The stress applied is considered concentrated at the narrowest point of the part. It is assumed that the stress is uniformly spread through the actuator. The end piece of the actuator is 1/8 inch thick and about 3/4 inch in diameter. It is subject to occasional accidental hits perpendicular to the long axis.. What is the reliability of this situation?

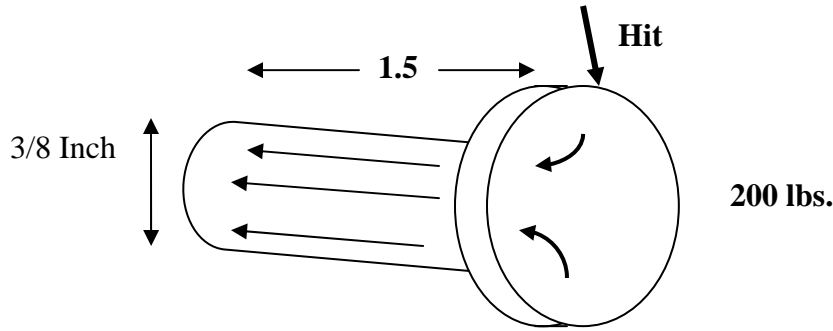

Figure 4.5 - Actuator Example

$$\text{Ultimate Material Strength} = \text{Area (material strength)} = \pi(0.1875)^2(6000\text{lbs/in.}^2) = (0.1104)(6000) = 662.7 \text{ lbs}$$

The yield strength begins at about 60%, so we will use this number for repetitive stresses of tightening or induced by hot and cold cycling of the mating materials. If the piece is 1.5 inches long, we have:

$$(662.7 \text{ lbs.})(0.6) = 397.6 \text{ lbs. The torque on the end is } \frac{397.6}{1.5} = 265.1 \text{ in-lbs.}$$

A strong human (at 95% limit) can place about 150 in-lbs on the part by twisting, turning or by accident with a heavy hit. With these numbers we can estimate for a one time reliability.

$$R = \Phi \left[\frac{265.1 - 150}{\sqrt{(18.56)^2 + (20)^2}} \right] = \Phi \left[\frac{115.1}{27.29} \right] = \Phi(4.218) = 0.999,987,674$$

Fifty such hits a year, assuming slow accumulation of fatigue, would lead to an annual reliability estimate of

$$R_{\text{year}} = (0.999,987,674)^{50} = 0.999,383,886 \text{ and}$$

a mean life of $.368 = (0.999,383,8864)^X$

$$X = 1622 \text{ years}$$

The average failure rate might be estimated as:

$$\bar{\lambda} = \left(\frac{0.368}{1622} \right) \left(\frac{1}{8760} \right) = .0000000259 = 2.59 \times 10^{-8} \text{ failures/operating hour}$$

$$\bar{\lambda} = 25.9 \text{ FITs}$$

These failure rate numbers in Examples 4.7 and 4.8 might be approximated by other means as shown by the earlier examples. This is especially true if the material strength was known and the distribution of

loads was known. No overt degradation of material was assumed, but is probably present and would shorten the life estimates. No change in load or spectrum of loads was assumed. This would also alter the results. That is, a strong blow might weaken a low strength part much faster than an average part. Lastly there was no consideration of stress concentration.

Example 4.9 - A Simple Reliability Model

Based on the exponential reliability model, the data from Example 4.8 could be re-analyzed by the following approach. This may not be the best way to do it, but it is simple and easy.

$$\text{Let } R = e^{-\lambda t} = 0.999,383,886$$

$$\lambda t = .0006163 \text{ failures/year}$$

$$\bar{\lambda} = 0.00000007035 \text{ failures per hour} = 70.35 \times 10^{-9} \text{ failures/operating hour}$$

This answer is 2.7 times higher than that in Example 4.8. Treat this as an alternate solution that may not be accurate.

Example 4.10 - A Total Mechanical System

A simple mechanical water handling system shall be made from a 3/8 inch brass piece, a housing, an adapter, a spring and two seals. We have already evaluated some (Examples 4.7 and 4.8) but need to add the two seals and the housing estimates. The seals will be from the Carderock Handbook just like the spring model. We have a model for the two **static** seals used on a hot/cold water line in a typical U.S. household in a city or suburb.

$$\lambda_{SE} = \lambda_{SE}^{Base} C_p C_Q C_{DL} C_H C_F C_v C_T C_N$$

where C_p is a correction for fluid pressure

C_Q is a correction for leakage

C_{DL} is a correction for seal size

C_H is a correction for contact stress

C_F is a correction for mating material smoothness

C_v is a correction for fluid viscosity

C_T is a correction for temperature excursions

C_N is a correction for contaminants in the fluid

Using typical stresses and extremes we can fill in this equation as follows.

$$\lambda_{SE} = (0.85 \times 10^{-6}) (0.11)(2.8)(0.7)(1.0)(1.0)(0.87)(0.46)(10) \text{ failures/operation}$$

$$\lambda_{SE} = 733.7 \times 10^{-9} \text{ failures/operation}$$

At 4 operations/day over a year we have:

$$\lambda_{SE} = 1.071 \times 10^{-3} \text{ failures/year} = 122.3 \times 10^{-9} \text{ failures/operating hour}$$

Our system could be complete based upon failure rate if we were to use for the housing failure rate double the adapter from Example 4.7. These perform similar functions and would be exposed to similar stresses, but doubling it is conservative. The housing need only hold the pressure of the water and any fatigue or corrosion also present. It need not be screwed on and off.

Component	Quantity	Fail Rate	Total
Brass Piece	1	25.9×10^{-9}	25.9×10^{-9} failures/operating hour
Seals	2	122.3 “	244.6 “
Adapter	1	20.25 “	20.25 “
Spring	1	2.592 “	2.592 “
Housing	1	40.50 “	20.25 “

System failure Rate			333.84×10^{-9} fails/operating hr.

System MTBF is approximately $\frac{1000000000}{333.84} = 2,995,446$ hours life = 342 years

If the system operates within the standard household stresses and environments with no chemical degradation or deterioration, than this system should last on the average about this long based upon the constant failure rate model. A time dependent model may produce a different answer and shorter life. We recognized that several of the components of the system have failure modes that are really time dependent and increasing failure rate. Thus, the 342 year life should be considered very optimistic. The following simple example easily shows the problem of using constant failure rate model for a deteriorating system.

Example 4.11 - A Non-Constant Equivalent Model

Example 4.10 may be extended by using a non-constant model for reliability of this mechanical system. The following is one of several models that might be employed based upon the information about the water system. The dynamic failure rate curve must cross the constant failure rate model at two points early in life of a population of systems. There is insufficient detail to determine exactly where the crossings occur. Additionally, the exact accumulation of fatigue formula or relationship is not known. Figure 4.6 shows the situation graphically, but may represent only a rough estimate. We need to explore this model in detail in order to better identify the failure rate curve and where an average life estimate generated by Example 4.10 might cross the Weibull curve.

The best approach to this problem would be to have in-house test data or field data to go with the prediction estimates. Since we don't have this information, we start with a series of reasonable assumptions. This can bracket events for us and we could pick a upper and lower failure rate model. Let the constant failure rate model cross the Weibull model at one customer year. We choose this point initially in order to fix details. It doesn't have to be that way. Additionally, since the accumulative fatigue is slow, we will select a Weibull model with $\beta = 1.25$ which is consistent with slow degradation. Treat this as a first estimate to the situation.

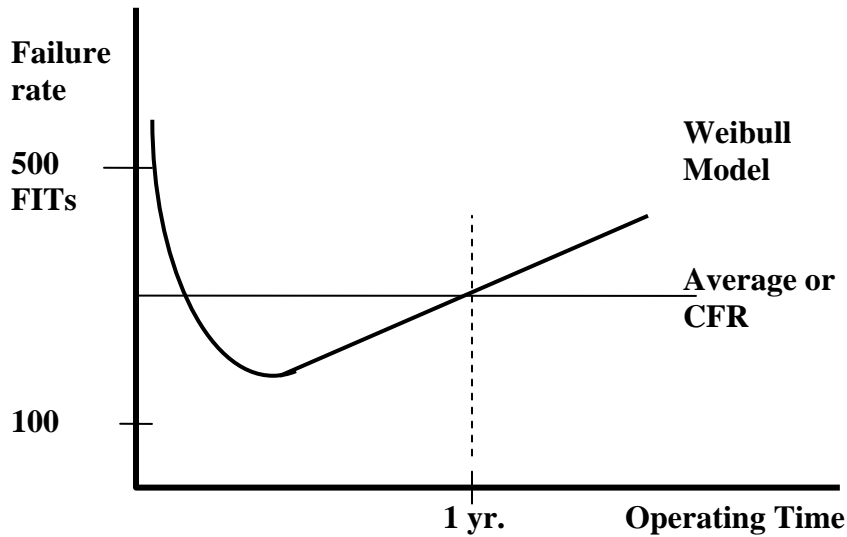

Figure 4.6 - Water System Failure Rate Curve

Since the Constant Failure Rate Number from Example 4.10 is set equal to the Weibull model at one year, we let the second crossing of the Weibull curve be set equal. This is:

$$333.84 \times 10^{-9} (8760 \text{ hrs.}) = 1 - e^{-\left(\frac{8760}{\eta}\right)^{1.25}}$$

$$0.0029244 = 1 - e^{-\left(\frac{8760}{\eta}\right)^{1.25}}$$

$$0.997076 = e^{-\left(\frac{8760}{\eta}\right)^{1.25}}$$

$$0.002929 = \left(\frac{8760}{\eta}\right)^{1.25}$$

$$0.009405 = \frac{8760}{\eta}$$

$$\eta = 931,454 \text{ hours} = 106.3 \text{ years}$$

We see from this simple model that in the first year about 0.29% of the units in the field would fail. In the second about 0.40% would fail and in third year about 0.47% would fail. What if the constant failure rate and Weibull models cross at about one month instead of one year? This piece of information changes the calculations above. They become:

$$(1/12)333.84 \times 10^{-9} (8760 \text{ hrs.}) = 1 - e^{-\left(\frac{730}{\eta}\right)^{1.25}}$$

$$0.000244 = 1 - e^{-\left(\frac{730}{\eta}\right)^{1.25}}$$

$$0.999756 = e^{-\left(\frac{730}{\eta}\right)^{1.25}}$$

$$0.000244 = \left(\frac{730}{\eta}\right)^{1.25}$$

$$0.001287 = \frac{730}{\eta}$$

$$\eta = 567,147.3 \text{ hours} = 64.7 \text{ years}$$

Now only 0.54 % fail in the first year and it takes over ten years to get to 20% failures.

Had we selected other choices such as $\beta = 1.50$, then the results could be very different. That is why real test results and field data are so important to modeling. Caution, don't assume a model and then use this as a basis for estimating warranties or any other money dependent activity. **Real data is required.**

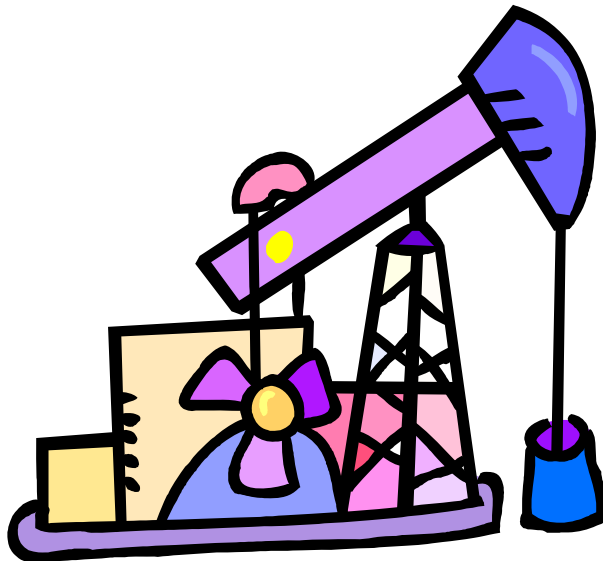

5.0 Confidence Intervals in Mechanical Reliability

Up to this point the mechanical reliability examples have shown how to calculate or estimate the reliability in a variety of situations. The tools connecting standard mechanical engineering to reliability techniques were explored and many connections made. In order to improve mechanical reliability applications we need explore additional mechanical engineering tools and techniques. Sometimes this requires a computer and more elaborate modeling; at other times simple models will take us a long way. It is left to the reader to pursue their own interests in these more complex areas. Normally these are pursued when a specific problem arises. The references cited may help along the way, but often few references go into sufficient detail without dedicated software.

The first section of Chapter 5 will show how to approach some of the common mechanical reliability confidence questions. These often arise when dealing with a variety of interesting mechanical reliability problems. This area is typically neglected or poorly covered in most books on reliability and mechanical reliability. Thus, the reader may find some unique examples.

Section 5.1 - Calculating Confidence

Confidence measures some estimate of the uncertainty in precisely knowing a point estimate. An example of this might be a statement of "the mean weight of a product is 3.5 ± 0.2 Kilograms". The most likely estimate (highest frequency) of the weight is 3.5 Kgr., but the highest estimate consistent with this is $3.5 + 3(0.2)$ or 4.1 Kgr.. The lowest estimate consistent with the measure is $3.5 - 3(0.2)$ or 2.9 Kgr. The most probable weight is a band around 3.5 Kgr. Some additional models or prior knowledge is required to better estimate the uncertainty about the weight. In this example we have treated *the uncertainty* as if it were a standard deviation based upon a Normal distribution of weight. While the Normal distribution has been employed in earlier mechanical examples to measure variability present, it was not directly employed to create confidence limits upon a **point estimate**. Other distributions may also be employed to estimate confidence limits. The most famous is perhaps the **Chi-Square** distribution. Handling of confidence estimates usually covers a wide variety of approaches because of the wide variety of mechanical applications that exist. A few typical examples will be shown in this chapter. These will range from standard statistical calculations and measures to basic estimates of the variability present in a specific situation. This chapter will look at methods as esoteric as **entropy** or employ other measures of physical principles to make estimates. The examples presented by no means exhaust the possibilities.

Example 5.1 - Confidence on the Deflection of a Beam

Consider the deflection of a simple beam under a force (load) P centered as shown in Figure 5.1.

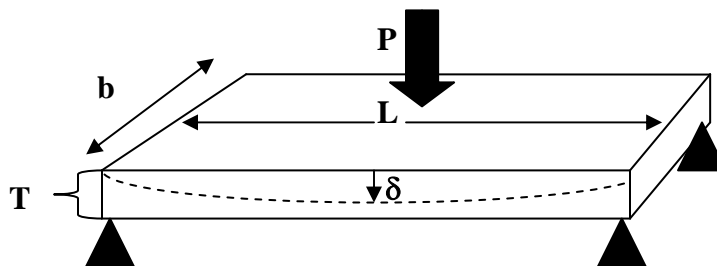

Figure 5.1 – The Deflection of a Wide Beam under Load

The maximum beam deflection is simple described as:

$$\delta = \frac{PL^3}{48EI} \quad (5.1)$$

If $P = 15,000$ lbs., $E = 30 \times 10^6$, $L = 24$ inches, $b = 2$ inches, $T = 1$ inch and the moment of inertia of the beam, $I = \frac{bT^3}{12}$ and the Tensile Strength of the material is $20,000$ lbs./in.² along this axis. What is the deflection of the beam?

Filling in the Equation 5.1 and using the moment of inertia equation yields:

$$\delta = \frac{PL^3}{4bT^3E} = \frac{(15,000)(24)^3}{4(2)(1)^3(30 \times 10^6)} = 0.864 \text{ inch} \quad (5.2)$$

The stress along the beam is:

$$S = \frac{P}{bT} = \frac{15,000}{(2)(1)} = 7500 \text{ lbs./in.}^2$$

Now it is time to introduce some variability or uncertainty into this example. If the dimensions are specified to within 0.2 inch on a mechanical drawing, we treat these as *dimensional tolerances*. The **statistical tolerances** can be said to cover the full range of the dimensional tolerances. That is, the range of ± 0.2 or 0.4 inch total is equivalent to 6σ . The standard deviation becomes 0.067 inch when a normal distribution is applied to dimension. Applying the same reasoning for a 10% maximum and minimum in the material property, Young's Modulus or E and to the applied force P with the thickness T would yield us the following set of statistical tolerances for the dimensions.

Let $b = 2 \pm 0.067$, $L = 24 \pm 0.067$, $T = 1 \pm 0.033$, $P = 15000 \pm 500$, $E = 30,000,000 \pm 1,000,000$ and beam tensile strength is established at 20,000 PSI minimum.

The nominal reliability can be calculated from the stress as:

$$R_N = \Theta \left\{ \frac{20,000 - 7500}{\sqrt{(2000)^2 + (750)^2}} \right\} = \Theta \left\{ \frac{12500}{2136} \right\}$$

$$R_N = \Theta \{5.852\} = 0.999,999,997,571$$

This reliability for a one time load is very high!

What happens for the lower limit of this beam? This is the situation where the beam is at the low limit of thickness or 0.9 inch and width (1.8 in.) and the load is at the high limit or about 16,500 lbs. The stress becomes:

$$S_{\max.} = \frac{P_{\max.}}{b_{\min.} T_{\min.}} = \frac{16,500}{(1.8)(0.9)} = 10,185.2 \text{ lbs./in.}^2$$

This should represent the lowest reliability for all material conditions within specification. The reliability estimate for a one time load now becomes:

$$R_{LL} = \Phi \left\{ \frac{20,000 - 10,185.2}{\sqrt{(2000)^2 + (1018.5)^2}} \right\} = \Phi \left\{ \frac{9814.8}{2244.4} \right\}$$

$$R_{LL} = \Phi \{4.373\} = 0.999,993,880$$

Likewise, the thickest beam and lowest load should have the highest one time reliability. This becomes:

$$S_{\min.} = \frac{P_{\min.}}{b_{\max.} T_{\max.}} = \frac{13,500}{(2.2)(1.1)} = 5,578.5 \text{ lbs./in.}^2$$

This should represent the highest reliability for all material conditions within specification. The reliability estimate for a one time load now becomes:

$$R_{UL} = \Phi \left\{ \frac{20,000 - 5,578.5}{\sqrt{(2000)^2 + (557.9)^2}} \right\} = \Phi \left\{ \frac{14,421.5}{2076.4} \right\}$$

$$R_{UL} = \Phi \{6.9454\} = 0.999,999,999,998,106$$

$$R_{LL} \leq R_N \leq R_{UL}$$

$$0.999,993,880 \leq R_N \leq 0.999,999,999,998,106$$

While these numbers may seem close together, they are really significantly different. At 1000 cycles of load the reliability range becomes:

$$0.993,898,678 \leq R_N^{1000} \leq 0.999,999,998,106$$

Example 5.2 - Tchebyshev's Approach to Uncertainty

The following example applies when little is known about the underlying distributions involved or the causes of any variation. The following series of approaches are distribution free. They do have basic requirements which are identified, but depend upon no underlying distribution. Hence, they can be rough estimates of confidence limits and not as precise as might be desired. With more information, better estimates can be made.

Tchebyshev's Inequality may be applied when the underlying variability distribution is unknown but thought to be symmetrical around some point or axis. The inequality allows one to estimate the uncertainty or confidence of a random variable, x , modeled by a Normal distribution. The number h represents the estimated number of standard deviations away from the mean. The probability of x deviating from the mean, \bar{x} , can be expressed by $h\sigma$ units is then:

$$P(|x_i - \bar{x}| \geq h\sigma) \leq \frac{1}{h^2} \quad (5.3)$$

This relationship represents the probability that x_i will be found beyond h units of σ from \bar{x}

or stated another way that $1 - \frac{1}{h^2}$ represents the probability that x_i , an individual measurement will be found **within** $\pm h\sigma$ of \bar{x} . This is analogous to the continuous situation with a Normal distribution, expressed in units of h . Applications for such confidence limit estimates include pharmacy, tourism, fishing industries and analysis of SPC data.

Consider the following example of a rotating component with an expected angle (mean or average location) of $\Phi = 30^\circ$ and a known coefficient of variation (CV) of 12%. What is the probability that the device will be found between 20° and 40° from some reference?

In this situation the CV indicates that the instrument is found closer to the center and a simple probability distribution was created to reflect this fact in Figure 5.2. There is a small probability of being outside of this range. The CV can be used to calculate an equivalent standard deviation. We have:

$$\sigma_\phi = (0.12)(30^\circ) = 3.6^\circ$$

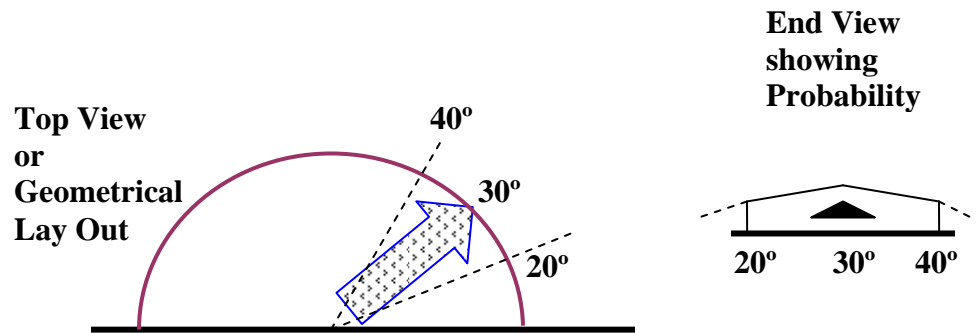

Figure 5.2 – The Probability Plot of a Position Indicator

by Tchebyshev's Inequality, we can write:

$$h = \frac{\phi_i - \bar{\phi}}{\sigma} = \frac{40^\circ - 30^\circ}{3.6^\circ} = \frac{10^\circ}{3.6^\circ} = 2.8 \text{ units}$$

is what the 10 degrees on either side of the mean represent. The probability at any point being found within this span or 20° is

$$P[20^\circ \leq \phi_i \leq 40^\circ] \geq 1 - \frac{1}{h^2} = 1 - \frac{1}{(2.8)^2} \geq 0.8724$$

Thus, the probability is at least 0.8724 that at any time the indicator ϕ will be found between 20° and 40° based upon the scant information known.

If we wanted a tighter range such as between 25° and 35°, or 1.4 units of h , we can easily estimate that probability as well. The equation becomes:

$$P [25^\circ \leq \phi_i \leq 35^\circ] \geq 1 - \frac{1}{h^2} = 1 - \frac{1}{(1.4)^2} \geq 0.4898$$

Thus, about half of the time the indicator would be found in this tighter range.

Example 5.3 - Gauss' Inequality

Gauss' approach to this type of uncertainty may be applied to situations where the underlying distribution is symmetrical and has a maximum within the range of interest. This distribution doesn't have to be centered over the range in question, which makes it different from Tchebyshev's approach. We have a little more information here, so we might be able to narrow the range of uncertainty or confidence. The formula for the inequality is shown in equation 5.4.

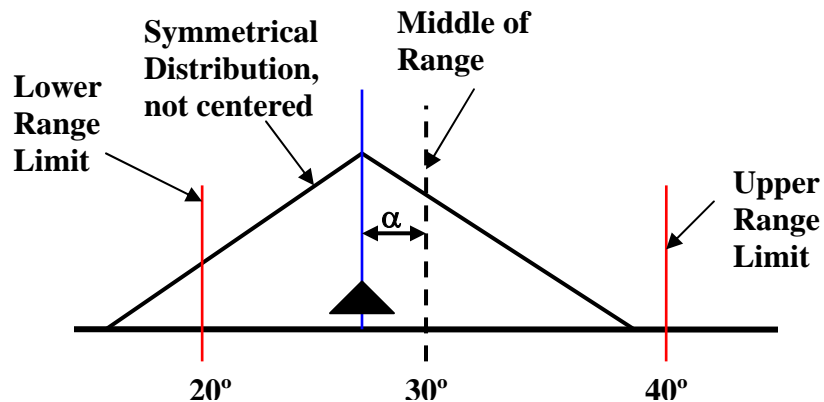

Figure 5.3 – Gauss' Inequality Model

We will use the same problem as in Example 5.2 and label the axes with the appropriate limits. Gauss' Inequality can be written to describe this situation. It is:

$$P(|X_i - \mu| \geq h\sigma) \leq \frac{4(1 + \alpha^2)}{9(h - |\alpha|)^2} \quad (5.4)$$

Here, α measures the difference between the mean and mode. It is simply

$$\alpha = \frac{\text{Mean} - \text{Mode}}{\sigma}$$

With Gauss' Inequality, what is the probability that the instrument will be found between 20° and 40° if $\alpha = 0.2\sigma$? Now the same problem using Gauss' Inequality gives us:

$$P [20^\circ \leq \phi_i \leq 40^\circ] \geq \frac{4(1 + \alpha^2)}{9(h - |\alpha|)^2} \geq 1 - \frac{4[1 + (0.2)^2]}{9[h - 0.2]^2} = 1 - 0.06838 = 0.9316$$

represents the probability of being within the range of 20° to 40° even if the distribution is not centered in this range. Gauss' approach only required a maximum were present in the range and the distribution was symmetrical. We did need to also know information about the off center distribution. What happens if there is a skewed distribution?

Example 5.4 - Non-Centered, Non-Symmetrical Distribution or the Camp-Meidell Approach

What if the distribution is not symmetrical? We can use the Camp-Meidell approach. This requires only that the distribution is unimodal and the mode does not equal the mean (otherwise it would be symmetrical). The probability formula in this situation becomes:

$$P(X < m - h\sigma) \leq \frac{1}{(2.25)h^2} \tag{5.5}$$

The details in Figure 5.4 show the differences between this approach and Gauss' Inequality. Carefully read the following description of the triangles shown in Figure 5.4.

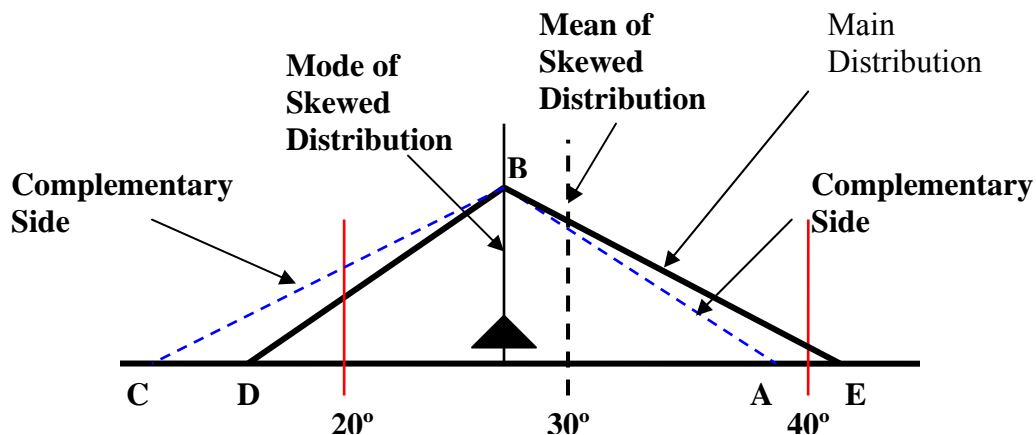

Figure 5.4 – The Camp-Meidell Model

Triangle **BDE** represents the original skewed distribution. The line **BC** is the complement of the line **BE**. That is, the complement line **BC** would make triangle **BCE** symmetrical. The line **BA** is the complement of line **BD**. Thus, we can create symmetrical triangle **BDA** as well. With this complement lines drawn in we are able to estimate the probability in this skewed situation.

Look at triangle **BCE** - we can write for this triangle:

$$P(X < 40^\circ) \leq \frac{1}{(2)(2.25)h_1^2} \text{ for half of the triangle (the BE side).}$$

Similarly, we have triangle **BDA** on the BD side with

$$P(X > 20^\circ) \leq \frac{1}{(2)(2.25)h_2^2}$$

The overall probability of being inside these limits, which is triangle **BDE** is then:

$$P(\text{inside upper and lower limits}) = 1 - \frac{1}{(2)(2.25)h_1^2} - \frac{1}{(2)(2.25)h_2^2}$$

If $h_1 = 1.3$ units and $h_2 = 1.5$ units, we have as the probability

$$P(\text{inside, } h_1 \text{ and } h_2) = 1 - \frac{1}{(2)(2.25)(1.3)^2} - \frac{1}{(2)(2.25)(1.5)^2} = 1 - \frac{1}{7.605} - \frac{1}{10.125}$$

$$P(\text{inside, } h_1 \text{ and } h_2) = 0.7697$$

represents the probability of being within the range from near 20° to near 40° even if the distribution is not centered in this range and it stretches unevenly about the limits from about 16° to 37° .

Example 5.5 - The Trivial Confidence Bounds

Trivial confidence bounds can be established for many situations. Consider a system built of N components connected in any fashion. It is possible to establish confidence bounds on the combined reliability of the components. The following approach provides rough estimates of the confidence limits of the system reliability. In this example the system will have four identical components, labeled 1, 2, 3 and 4 each with reliability of 0.9. The bounds on the system will be set by the possibility of a complete parallel or complete serial combination. The true system configuration is shown below in Figure 5.5. The nominal R_{sys} is 0.9891 for the geometry shown below. For more complex systems it is always possible to reduce parts of the system to equivalent series or parallel combinations before applying this method to the portions that can not be easily reduced.

The nominal value is calculated by first combining parallel components 3 and 4. This is:

$$R_{3\&4} = 1 - (1-0.9)(1-0.9) = 1 - 0.01 = 0.99$$

Next, combine this result with in series with component 2.

$$R_{2,3\&4} = R_2 R_{3\&4} = (0.9)(0.99) = 0.891$$

Combine this result with the parallel component 1 to give

$$R_{sys.} = 1 - (1 - R_1)(1 - R_{2,3\&4}) = 1 - (0.1)(0.109) = 0.9891$$

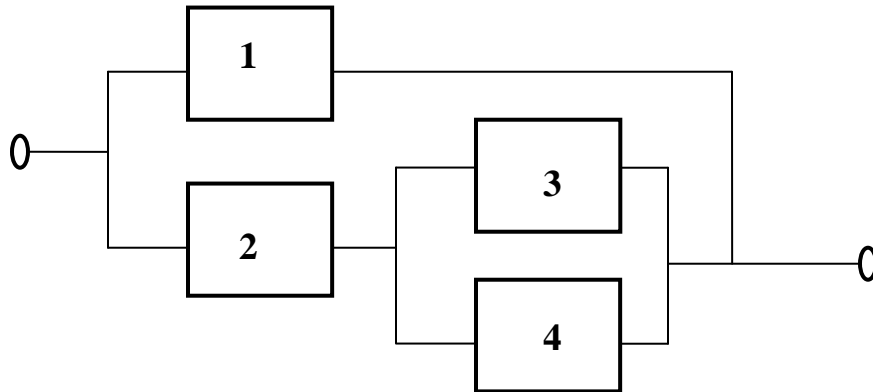

Figure 5.5 - A Simple System

All Serial reliability possibility for a system may be described by:

$$R_{sys.} = \prod_{i=0}^N R_i = R_1 R_2 R_3 R_4 = (0.9)^4 = 0.6561 \quad (5.6)$$

$$\text{All parallel possibility } 1 - \prod_{i=0}^N (1 - R_i) = 1 - (1 - 0.9)^4 = 0.9999 \quad (5.7)$$

Thus, wide limits on the nominal reliability of the system have been determined.

$$0.6561 \leq R_{sys.} = 0.9891 \leq 0.9999$$

These numbers represent the broad set of confidence limits and are sometimes called “Trivial Bounds”. These represent rough estimates of the upper and lower bounds. This approach made no use of knowledge about the geometry of the system itself. There should be a better way to narrow these limits by making use of knowledge of the system configuration.

Example 5.6 - Improved Cut Set Confidence Bounds

A much better confidence bounds estimate, one based on geometry, can be obtained by looking at the geometry. We use the minimum (success) paths or tie sets and minimum cut sets (failure paths) to estimate the reliability confidence limits. The situation is no harder to describe than trivial bounds and the calculations in this situation are easy. Complex systems are much harder to accomplish and telecommunications networks form examples of such complex combinations. If the reader is interested in more complex situations see Locks [26]. These are also called Esary-Proschan bounds.

To improve our estimate of the confidence limits, determine **the Minimum paths**. These are those shortest paths that lead to successful system operation. From Figure 5.5 these paths are [1], [2&3], [2&4]. There are no other paths to success in this system and are shown as arrows in Figure 5.6

Next, identify the **Minimum cut sets**. These are those fewest cut paths that cause the system to fail to operate. From Figure 5.6 these may be identified as cuts across the outputs of components 1 and 2 called [1,2], and a cuts across the output of 1 and the combination 3 and 4 or [1,3,4]. These are the minimum cut sets for this system.

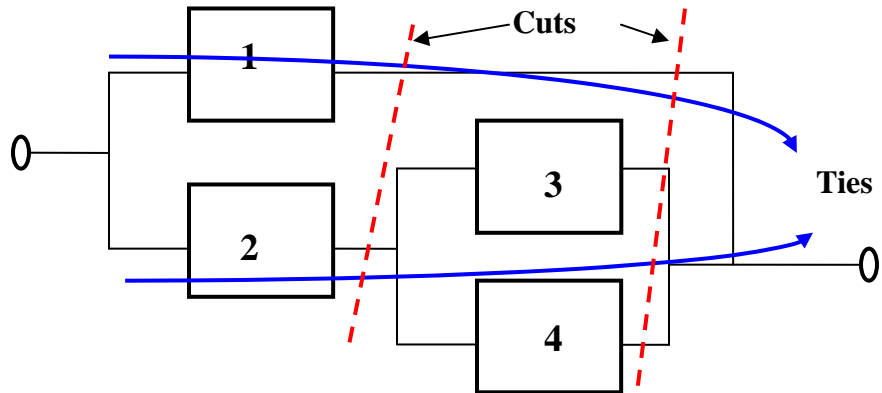

Figure 5.6 – Cut Sets and Ties Sets

The cut sets will represent the lower bound on the reliability estimate for the system. The tie sets will be the new upper bound. These may be calculated by the following formulas.

Cut Sets multiply the probabilities of the states as:

$$\text{Lower estimate} = \prod_{j=1}^k [1 - \prod_{i=1}^n (1 - p_i)] = [1 - (1 - p_1)(1 - p_2)][1 - (1 - p_1)(1 - p_3)(1 - p_4)] \quad (5.8)$$

$$\text{Lower estimate} = [1 - (0.1)(0.1)][1 - (0.1)(0.1)(0.1)] = (0.99)(0.999) = 0.98901$$

Tie Sets combine the probabilities of the states as follows:

$$\text{Upper estimate} = \prod_{j=1}^k [1 - \prod_{i=1}^n p_i] = 1 - [1 - p_1][1 - p_2 p_3][1 - p_2 p_4]$$

$$\text{Upper estimate} = 1 - [0.1][1 - 0.81][1 - 0.81] = 0.99639$$

Thus, the **improved Esary-Proschan confidence bounds** on the system reliability becomes

$$0.98901 \leq R_{\text{sys.}} = 0.9891 \leq 0.99639$$

This provides a much more useful estimate for the upper and lower system bounds and may be used for more complex systems and combinations.

Example 5.7 – A More Complex Confidence Bounds Example

The following system is made of five unequal components and is an example of a complex calculation. The nominal reliability will be calculated as well as upper and lower confidence bounds using the cut and tie set approach.

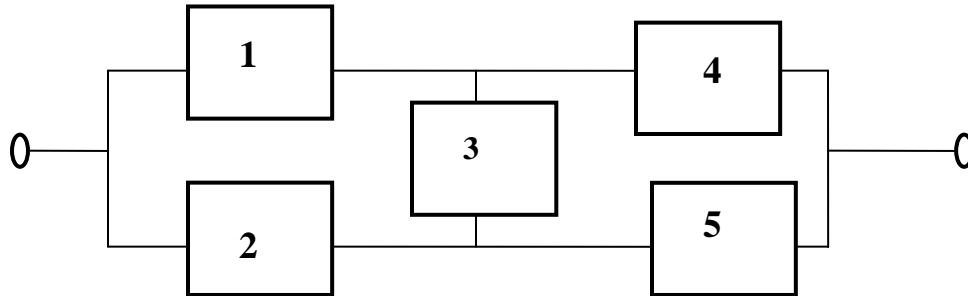

Figure 5.7 – A Complex System

This system is made of five components. Components 1, 2, 4, 5 all have a reliability of 0.9 and component 3 has reliability of 0.8. The system can be broken into two pieces in order to estimate the reliability. This is an example of decomposition. Here it will be over time, with 80% of the time component three is operating and 20% of the time component three has failed. These two states are then added to obtain the reliability. This is shown as two pieces in Figure 5.8A and 5.8B:

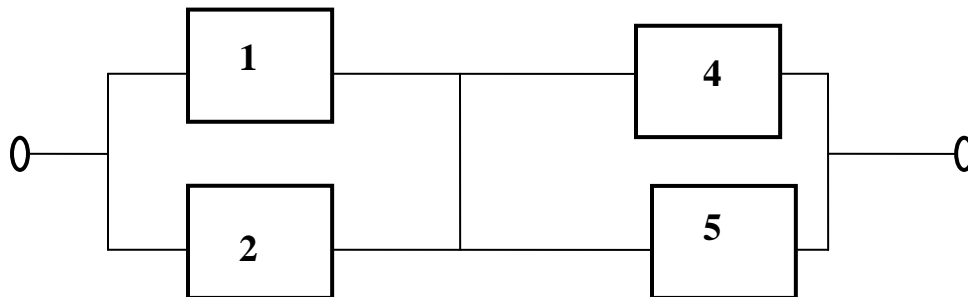

Figure 5.8A – When Component Three operates successfully

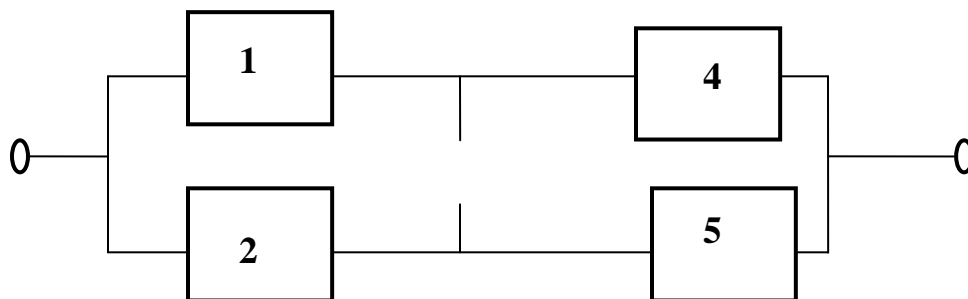

Figure 5.8B – When Component Three Fails

Now the calculation of the reliability for Figure 5.8A is based upon component 1 is parallel to 2 and in series with the parallel combination of components 3 and 4.

$$R_{Success} = 0.8[1-(1-0.9)^2] [1-(1-0.9)^2] = 0.78408$$

$$R_{Fail} = 0.2 [1 - (1- (0.9)^2)] = 0.19278$$

$$R_{System} = 0.78408 + 0.19278 = 0.97686$$

Next, identify the tie sets. Here these are paths [1,4], [2,5] and paths [1,3,5] and [2,3,4] and represent the upper bound. This becomes:

$$\text{Upper estimate} = 1- [1- (0.9)^2]^2 [1- (0.8)(0.9)^2]^2 = 0.99553$$

Now, identify the cut sets. Here these are paths [1,2,], [4,5] and paths [2,3,4] and [1,3,5] and represent the lower bound. This becomes:

$$\text{Lower estimate} = [1- (0.1)^2]^2 [1- (0.2)(0.1)^2]^2 = 0.97618$$

Thus, the **improved confidence bounds** on the complex system reliability becomes

$$0.97618 \leq R_{sys.} = 0.97686 \leq 0.99553$$

Example 5.8 - The F Distribution for Confidence Limits

The classic formulas for confidence may be derived from the F distribution. These can be written as:

$$\text{Lower Limit} = \frac{\frac{j}{n-j+1}}{F_{(1-\alpha, n_2, n_1)} + \frac{j}{n-j+1}} \quad \text{Where } n = \text{number on test} \quad (5.9)$$

j = number of test survivors
F is the F test, at confidence 1- α

$$\text{Upper Limit} = \frac{(\frac{j}{n-j+1})F_{(\alpha, n_1, n_2)}}{1 + (\frac{j}{n-j+1})F_{(\alpha, n_1, n_2)}} \quad \text{Where } n_1 = 2j \text{ and } n_2 = 2(n-j+1) \quad (5.10)$$

Let there be 10 units on test, with 4 failures over the period of operation and interest. What are the confidence limits at the fourth failure at 90% confidence? Here $n = 10$, $j = 6$, $\alpha = 0.90$

Look into the F tables and find the fourth failure at the appropriate confidence limits.

Lower limit F value = $F_{(0.1,10,12)} = 2.19$ and

Upper limit F value = $F_{(0.9,12,10)} = 0.711$

Calculating provides:

$$\text{Lower Limit} = \frac{\frac{6}{5}}{2.19 + \frac{6}{5}} = 0.354$$

$$\text{Upper Limit} = \frac{\frac{6}{5}(2.28)}{1 + \frac{6}{5}(2.28)} = 0.732$$

These numbers represent the upper and lower limits on confidence at the fourth failure. We can likewise calculate the confidence limits at earlier failures and all later failures if desired. The confidence bounds are:

$$0.354 \leq R = 0.60 \leq 0.732$$

Example 5.9 - Traditional Chi-Square Distribution Limits

The limits on the fourth failure in Example 5.8 can be calculated by the Chi-square distribution as:

$\chi^2_{(2f, 1-\frac{\alpha}{2})}$ at 90% confidence for a failure ended tests and

$\chi^2_{(2f, \frac{\alpha}{2})}$ and 10% confidence for a failure ended tests

These two calculations are the upper and lower value estimates for this problem as:

$$0.368 \leq R = 0.60 \leq 0.738$$

These are close to the more exact limits calculated in Example 5.8.

Section 5.2 Accelerated Testing Examples

Accelerated testing with mechanical components can be problematic because many components are hard to accelerate until one reaches the limit of catastrophic failure. The following simple examples address some of the issues with accelerated testing for mechanical components and systems. This topic can be the subject of a book all by itself.

Example 5.10 - Simple Acceleration of a Mechanical System

This approach is based upon the use of two standard Weibull formulas. The first is the standard Weibull equation for reliability and the second equation is the zero failure formula from Abernathy [17].

$$R = e^{-\left(\frac{t-\gamma}{\eta}\right)^\beta} \quad \text{and} \quad \eta^\beta = \frac{(N)(AFt)^\beta}{-\ln(1-C)} \quad (5.11)$$

Where “t” is the time, η is the characteristic life, β is the Weibull shape parameter, γ is the offset, C is the desired confidence and AF is the acceleration factor.

Let $\gamma = 0$, AF = 3 and $\beta = 2.0$ indicating a wear situation at normal stress levels. Filling in the zero failure formula for 90% confidence formula provides:

$$\eta^2 = \frac{(N)(3t)^2}{2.303} \quad \text{or}$$

$$\left(\frac{t}{\eta}\right)^2 = \frac{2.303}{9N}$$

Filling in the reliability formula provides for a desired reliability of 0.95:

$$R = 0.95 = e^{-\left(\frac{2.303}{9N}\right)}$$

$$0.0513 = \frac{2.303}{9N}$$

$$N = 4.988 \quad \text{or} \quad 5 \text{ samples minimum}$$

This sample size is required to demonstrate $R = 0.95$ at 90% confidence at zero failures with an acceleration factor of 3.

$$\text{With} \quad R = 0.95 = e^{-\left(\frac{2.303}{9N}\right)} = e^{-\left(\frac{t}{\eta}\right)^2}$$

$$\text{So} \quad 0.0513 = \left(\frac{t}{\eta}\right)^2$$

And

$$\left(\frac{t}{\eta}\right) = 0.2265$$

The time to first failure = 22.65% of the characteristic life

Example 5.11 - Alternate Accelerations and Wear Rates

Stress and Wear situations change in Example 5.10. Now let the AF = 5, confidence be 90% and R = 0.95. Now

$$\eta^2 = \frac{(N)(5t)^2}{2.303} \quad \text{or}$$

$$\left(\frac{5t}{\eta}\right)^2 = \frac{2.303}{N}$$

again

$$0.0513 = \left(\frac{5t}{\eta}\right)^2 = \frac{25t^2}{\eta^2} = \frac{2.303}{N}$$

And so

$$N = 1.796 \quad \text{or 2 samples are required under these conditions.}$$

The difference in sample sizes is in the Acceleration Factor because of the accelerated test conditions.

$$R_{\text{accel.}} = e^{-\left(\frac{5t}{\eta}\right)^2} = \left[e^{-\left(\frac{t}{\eta}\right)^2}\right]^{25}$$

The units under test have aged significantly because of the acceleration. Imagine that the accelerated test ran 10% of the unaccelerated characteristic life (i.e. $t/\eta = 0.10$). This is about half of the expected characteristic life when acceleration is included. Then filling in for t and η , we have:

$$R_{\text{accel.}} = \left[e^{-0.01}\right]^{25} = 0.7788$$

Section 5.3 - Mechanical Materials Acceleration

Acceleration techniques apply to the following groups of common materials.

- 1.) Iron/Steel/Brass/Copper and other materials
- 2.) Many Plastics
- 3.) Ceramics and similar materials
- 4.) Wood and a variety of natural fibers.

All of these materials have the property that the material changes tend to vary slowly with the application of stress and so are consistent with a Hook's Law model for simple uniaxial systems. This is true over some range of stress on the material.

Typical stresses that can be included in mechanical acceleration situations include:

- | | | |
|-----------------------|---------------------------|---------------------------|
| A) Temperature | B) Humidity | C) Vibration |
| D) Shock | E) Chemical attack | F) Mechanical Load |
| G) Duty cycle | H) Dust | I) UV Light |
| J) Corrosion | | |

All of these stresses can be associated with a many slow wear mechanisms. If Weibull analysis can be employed to describe them, the shape parameter usually falls in the range of 1.25 to 2.50. This range is typical for slow wear, degradation or deterioration. More rapid wear or deterioration may be described by a large shape parameter.

Section 5.3.1 - Typical Mechanical Models that Describe Reliability

The Mechanical Bathtub – This bathtub is typically different from an electronic bathtub because the center of the bathtub is dependent upon slow wear mechanisms. This means a slow increase in the failure rate over time until the onset of rapid wear or the wear out state. This point is usually an indication of the end of life of a population. For most mechanical systems we focus upon this slow wear portion of the curve

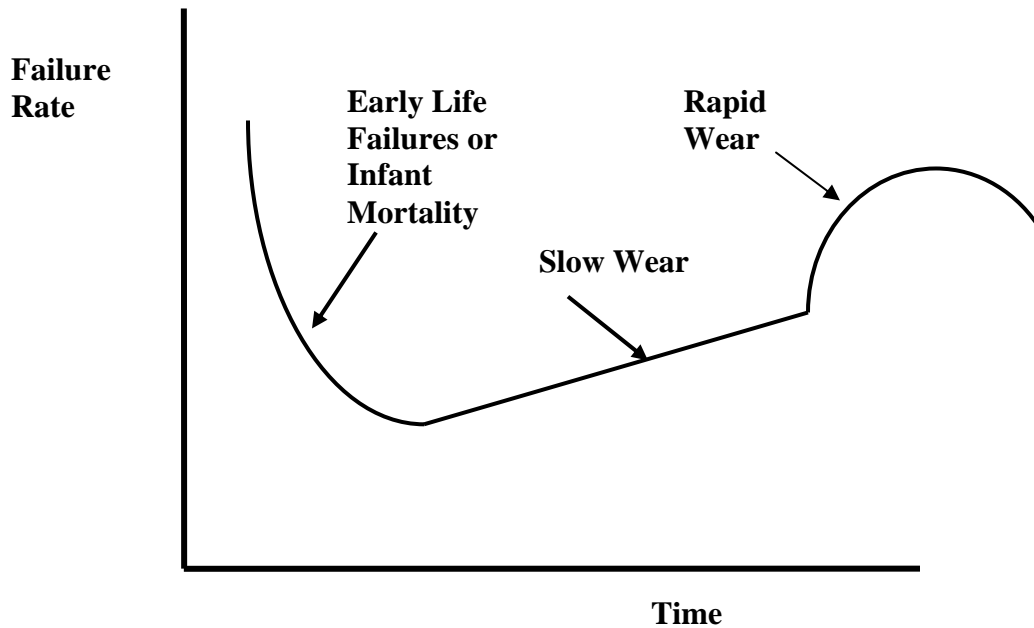

Figure 5.9 – Slow Wear of a Mechanical Bathtub Curve

There are a variety of processes that lead to slow wear (deterioration, degradation or fatigue) of components and systems. A short list of some of these follows. Slow wear is all around us in everyday life. Light bulbs have a limited life, switches eventually wear out from the slow accumulation of damage associated with actuation. Relays will pit and become high resistant from actuation under load. Car tires eventually need to be replaced as the tread becomes thin. Computer keyboards have a limited actuation

life and eventually the keys no longer work. Rechargeable electric shavers or cell phones can no longer be recharged. All of these represent the slow wear we tend to ignore in real life. Slow wear often occurs when material is removed from a surface while operating. Another source of slow wear is the generation and propagation of flaws or defects. These tend to grow and accumulate and eventually lead to failures. Stress applied to a metallic structure can lead to slow changes of the metal as internal defects or dislocations grow and accumulate. Eventually the metal fails from this slow accumulation of defects. A last type of slow wear is chemical. Materials oxidize, corrosive by-products might be created, chemical reactions that are not fully reversible lead to ultimate failure. All occur at a slow rate. There are three models that cover most of these stress-life situations.

Typical causes of Slow Wear

- 1.) Sliding or rotating motions of material on material
- 2.) Chemical degradation with use (i.e. rechargeable batteries)
- 3.) Material loss through use (such as light bulb filaments)
- 4.) Rust, corrosion or oxidation of materials
- 5.) Crack accumulation and spread
- 6.) Cumulative fatigue from stress or internal damage
- 7.) Limits of material strength, brittle fracture or creep
- 8.) Exhaustion of a chemical processes (i.e. battery run down)

Any of these processes may be subject to slow wear which limits life or look like slow wear as components age. This situation is rather common and may range from tire wear to solder fatigue. There are a small number of basic models that may relate the stress versus life in these situations. The following is a short summary of some models.

5.3.2 - Typical Stress-Life Relationships

As stress is increased the failure rate of a mechanical function should also increase. The relationship is usually not linear. For some mechanical situation of cyclic stresses there are often two regions that describe the degradation with use or operation. One represents slow wear and the other a high rate of wear. Figure 5.10 shows this situation. This was discussed in Chapter 3 in some detail. This dual range of relationship often limits the ability to accelerate a mechanical test. Figure 5.10 shows this graphically.

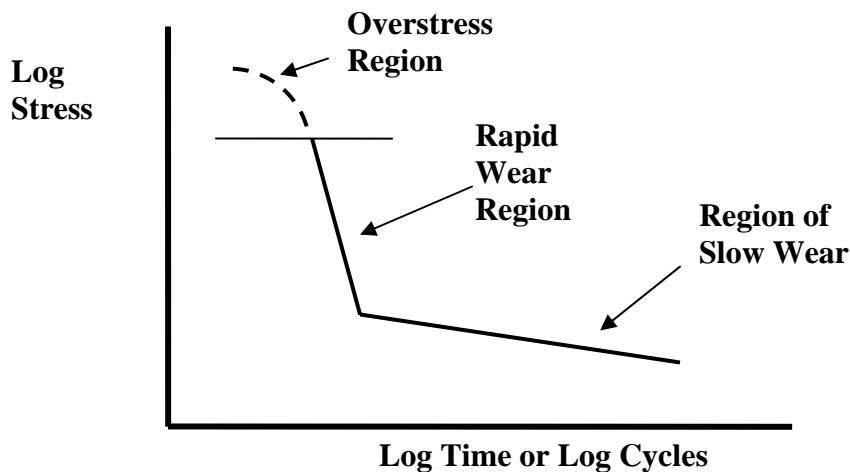

Figure 5.10 – The Dual Stress-Life Relationship

In order to accelerate mechanical functions, the stress or load must be increased. However, there is typically only a narrow range of the stress over which slow wear may occur. As stress continues to increase, the Stress-Life relationship may move onto the high rate of wear curve. An accelerated life test in this region can't easily be extrapolated into the slow wear region and retain meaning. Typically the failure modes are different from the slow wear region to the high rate of wear. As stress continues to increase, the component will have a very short life. Near the upper stress limit the overstress region may be encountered. In this region life is very short and failures have little relationship to the slow wear region. This is why we often limit the level of stress applied to a mechanical system. Meaningful acceleration can't always be accomplished by test. How can we tell if there would be a problem? Use the following activities as a guide.

- Look at the response to stress at lower stress
- Look at the failure modes in the slow wear region
- Compare the response in a higher stress region to the low stress region
- Compare the failure modes in a higher stress region to the low stress region
- If they appear different, you are probably out of the slow wear region.

With this knowledge, basic mistakes can be avoided. What do I do with test data from several levels of stress? The answer is analysis of course!

5.3.3 - Complex Mechanical Models – Arrhenius, Power Law or Eyring

There are three models that cover a lot of failure modes in mechanical reliability. The first is **Arrhenius**. It was named after Svante Arrhenius, a Swede chemist, and Nobel Prize winner (1903). It was he who first observed that the rate of chemical reactions is temperature dependent. This means any failure mode dependent upon chemistry might follow the Arrhenius relationship. Thus anything that oxidizes, corrodes, rusts or generates chemical by products might follow this relationship. All failure modes that depend upon diffusion to propagate should follow Arrhenius. All of these should be temperature sensitive. Equation 5.12 shows the Arrhenius formula.

$$\text{Life} = A e^{\frac{E_a}{K_b T_k}} \quad (5.12)$$

Here, E_a is the activation energy which is an amount of energy needed to drive a chemical reaction.

K_b is Boltzmann's constant and is set at 8.615×10^{-5} electron Volts/°K

T_k is the temperature in degrees Kelvin or °K, which is °C plus 273

A is a scaling constant

Typical mechanical activation energies run as low as 0.05 eV to 0.2 eV.

The second basic model of mechanical reliability is the **Power Law**. This relates an inverse power of Stress to the Life. Equation 5.13 shows this.

$$\text{Life} = B(S)^{-N} \quad (5.13)$$

Here, S represents a stress

-N represents a material constant, the minus is kept to show life gets shorter at higher stress

B is a scaling factor

Typical mechanical exponent values of N, run as low as 0.5 to 7.0. This relationship tends to work for many processes. It isn't always this simple.

The third basic model of mechanical reliability is the **Eyring relationship**. This relates an inverse power of Stress to the Life combined with a temperature term. Equation 5.14 shows this relationship with an interaction term. This means at some level, the combination of stresses is non-linear.

$$\text{Life} = C e^{\frac{E_a}{K_b T_k}} (S)^{-N} e^{\frac{D(S)E_a}{K_b T_k}} \quad (5.13)$$

This equation shows both a Arrhenius term and a Power Law term. The third term has both stresses present (both T and S) in it. The new additional unknowns are:

C – a scale factor

D – a scale factor for the interaction term. It is often small

A last word about acceleration - Many mechanical components have a low acceleration with respect to the stresses. They are on the slow wear curve. Therefore, it is often difficult to conduct a reasonable test until the level of stress gets higher. Therefore, the typical electronic examples with an acceleration factor of 10 or 50 are not too useful. There are three basic ways to accelerate mechanical systems.

- 1) Raise the level of a stress of interest (i.e. temperature)
- 2) Increase the duty cycle of operation
- 3) Raise the level of a second stress, one that is also related to one of interest (i.e. Humidity, chemical concentration, UV light etc.)

Beyond these three approaches there are not many other ways to accelerate mechanical items.

Section 5.4 - Discrete Mechanical Systems

Up to the present time all of the examples of applications of mechanical situations have been treated as continuous distributions. The following example from Rao [3] shows how to handle the rare situation of a discrete distribution that sometimes occurs. These examples can look a little artificial, but serve as good approaches.

Example 5.12 - A Weakest Link in a Discrete Parallel System

The following system is constructed of a small number of vertical beams. They all support a load by sharing. These are treated as discrete elements in a system. If one beam fails, the remainder supports a larger load. In the following example, the load has two possible states. Sometimes it is one state and sometimes another. This complicates the analysis of a discrete system.

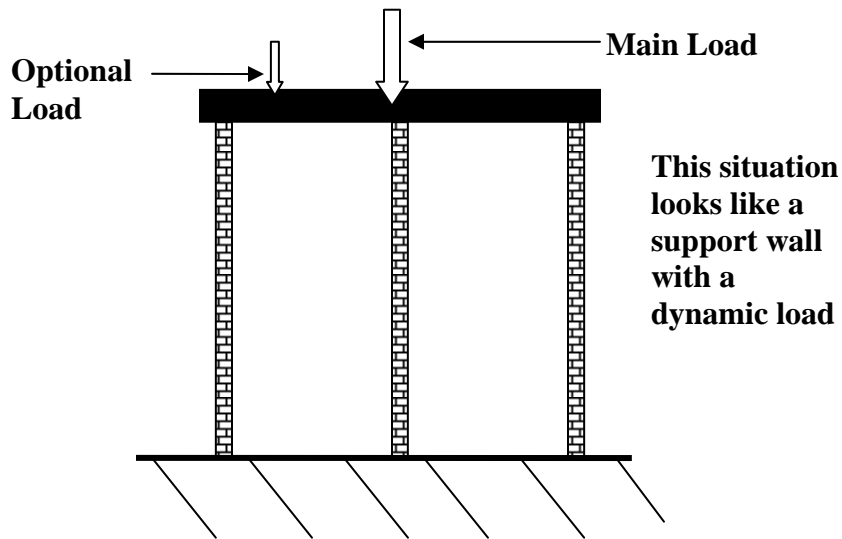

Figure 5.11 – The Discrete Strength-Load Situation

The strength probability is discrete and has two states, call them state 1 and 2. They are:

$$P_1(S) = \frac{3}{8} \text{ of the time the structure can safely carry 800 lbs. each or}$$

$$P_2(S) = \frac{5}{8} \text{ of the time the structure can safely carry 1600 lbs each}$$

Describes a two state strength for *each* of the three discrete elements holding the load. This is a parallel load share situation. Selecting different support structures shows the influence of two possible strengths.

Discrete Load Distribution

$$P_1(L) = \frac{1}{8} \text{ of the time a 2500 lbs. load may be present}$$

$$P_2(L) = \frac{1}{2} \text{ of the time a 3500 lbs. load may be present}$$

$$P_3(L) = \frac{3}{8} \text{ of the time a 4500 lbs. load may be present}$$

The Minimum Strength of 2400 lbs. would be unreliability for all load states. The next strength state of 3200 lbs. would be reliable only for the minimum load of 2500 lbs. The third strength state of 4000 lbs. is reliable for loads of 2500 lbs. and 3500 lbs. The highest strength state of 4800 lbs. is reliable for all three loads. Table 5.1 shows this information with probabilities all summarized. This allows us to do a discrete interference calculation for Strength and Load. The interference shows the reliability for the complete situation.

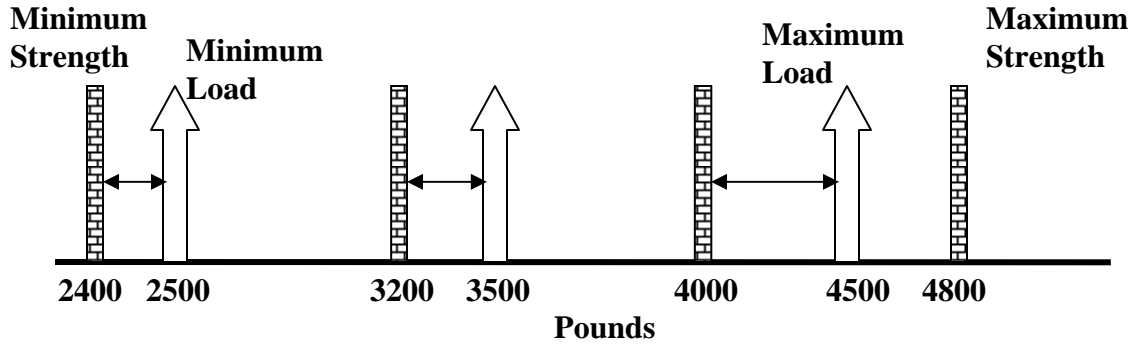

Figure 5.12 – The Distribution of Strength and Load

Table 5.1 – Summary of Discrete Strength and Load

$R_3 = S_1 + S_2 + S_3$ Four Possible States	Probability of Each State	Cumulative Probability - P_s
Min. Strength = $3(800) = 2400$ lbs.	$(\frac{3}{8})^3 = \frac{27}{512}$	$\frac{27}{512}$
Next State = $2(800) + (1600) = 3200$	$3(\frac{3}{8})^2(\frac{5}{8}) = \frac{135}{512}$	$\frac{162}{512}$
Next State = $800 + 2(1600) = 4000$	$3(\frac{3}{8})(\frac{5}{8})^2 = \frac{225}{512}$	$\frac{387}{512}$
Max. Strength = $3(1600) = 4800$	$(\frac{5}{8})^3 = \frac{125}{512}$	1.00

What is the reliability for this simple discrete system? We will need to calculate "the Interference", which is related to the probability of failure of this type of system. Table 5.1 holds the probabilities we will need.

This problem is *different from prior continuous interference examples* for it describes a discrete system with discrete states. There is no simple distribution of strength and loads. We will summarize the discrete states to estimate the reliability.

$$P_{fail} = \sum_{i=1}^3 P_s L_L = (\frac{27}{512})(\frac{1}{8} + \frac{1}{2} + \frac{3}{8}) + (\frac{135}{512})(\frac{1}{8} + \frac{3}{8}) + (\frac{225}{512})(\frac{3}{8}) = \mathbf{0.4482} \quad (5.14)$$

$$P_{fail} = \text{Prob. of 3 failed states} + \text{Prob. of 2 failed states} + \text{Prob. of 1 failed state}$$

So

$$\mathbf{R} = \mathbf{1} - \mathbf{P}_{fail} = \mathbf{0.5518}$$

The reliability is so low because the load overlaps the strength distribution by a large amount at all but the highest strength.

How do we improve this situation? Consider the possibility that the **lowest state** of strength can not occur. That is we can prevent this state and thus only have two other states left. We now have:

$$\mathbf{P}_{fail} = \sum_{i=1}^2 P_S L_L = \left(\frac{135}{512}\right)\left(\frac{1}{2} + \frac{3}{8}\right) + \left(\frac{225}{512}\right)\left(\frac{3}{8}\right) = \mathbf{0.3955}$$

$$\mathbf{R} = \mathbf{1} - \mathbf{P}_{fail} = \mathbf{0.6045}$$

Why didn't this change much? It is because the lowest strength state was a very small fraction of the possibilities and so a small contributor to the overall reliability.

Example 5.13 - Estimating Confidence Limits for a Discrete Situation

The Upper and Lower confidence limits can be established for this discrete situation of Example 5.12. This is a critical estimate when we are not otherwise sure of the expected limits. Classical methods of calculation do not easily work here. We will calculate these confidence limits by dividing the load in three and comparing it to a single element strength. We look at the probabilities of this new system being in each of the states. Remember this is comparing 1/3 of the load to the strength of each column.

$$\mathbf{P}_{fail-Ind.} = \sum_{i=1}^3 P_S L_L = \left(\frac{1}{3}\right)\left(\frac{1}{8}\right) + \left(\frac{3}{8}\right)\left(\frac{1}{2}\right) + \left(\mathbf{1}\right)\left(\frac{3}{8}\right) = \frac{39}{64} = \mathbf{0.6094}$$

Loads 833 lbs. 1167 lbs. 1500 lbs.

Each contribution represents the simultaneous probability of the load and strength both being in a given state. The following formula represents an estimate of the confidence bands for the situation. It is based upon the minimum single element probability failure as the lower end limit and the combined probability of all elements to be in a minimum state as the upper end limit. This is mathematically:

$$\text{Lower Confidence Limit} = 1 - \text{Probability of a single failure} = \mathbf{1} - \frac{39}{64} = \mathbf{0.3906}$$

$$\text{Upper Confidence Limit} = 1 - \text{Probability of three failures} = \mathbf{1} - \left(\frac{39}{64}\right)^3 = \mathbf{0.7737}$$

Thus the discrete confidence limits on the discrete reliability are:

$$\mathbf{0.3906} \leq \mathbf{0.5518} \leq \mathbf{0.7737}$$

References

1. Frederich, Johannes, *Extinct Languages*, Dorset Press, 1989
2. Ireson, Grant, Coombs, Clyde and Moss, Richard. *Handbook of Reliability Engineering and Management*, 2nd. edition, McGraw Hill, New York, 1996
3. Rao, S.S., *Reliability Based Design*, McGraw Hill, New York, 1992
4. O'Connor, P. D. T., *Practical Reliability*, 4 th Student edition, Wiley, New York, 2002
5. Nelson, Wayne, *Accelerated Testing*, ASQ Press, Milwaukee, 1990
6. Carter, A.D.S., *Mechanical Reliability and Design*, Wiley, New York, 1997
7. Sadlon, Richard, *Mechanical Applications in Reliability Engineering*, Reliability Analysis Center, Rome 1993
8. Lipson, Charles Sheth, Narendra and Disney, Ralph, *Reliability Prediction - Mechanical Stress/Strength Interference*, University of Michigan under government contract RADC-TR-66-710 1966.
9. Cruse, Thomas, *Reliability Based Mechanical Design*, Marcel Dekker, New York, 1997
10. Sadlon, Richard, *Analysis Techniques for Mechanical Reliability*, Reliability Analysis Center, Rome, 1985
11. *Non-electronic Part Reliability Data*, Reliability Analysis Center, Rome, 1995
12. *Handbook of Reliability Prediction Procedures for Mechanical Equipment*, Carderock Division, Naval Surface Warfare Center, NSWC 92/L01, May 1992
13. *Reliability and Maintainability Guideline for Manufacturing Machinery and Equipment*, SAE publication through the National Center for Manufacturing Sciences, 1993
14. Shingley, Joseph and Mischke, Charles, *Standard Handbook of Machine Design*, second edition, McGraw Hill, New York, 1996
15. McLinn, James, *Mechanical Reliability Tutorial*, Proceedings of the Annual Reliability and Maintainability Symposium, IEEE, Piscataway, 1998
16. Carter, ADS, *Mechanical Reliability*, 2nd. edition, MacMillian, London, 1986 - This book was published in London and is no longer in print.
17. Abernethy. Robert, *The New Weibull Handbook*, fourth edition, self published, 536 Oyster Rd. North Palm Beach, Florida, 33408, Weibull@worldnet.att.net
18. Den Hartog, J.P., *Strength of Materials*, Dover, New York, 1961
19. Vinogradov, Oleg, *Introduction to Mechanical Reliability: A Designer's Approach*, Hemisphere Publishing, New York, 1991
20. Lipson, Charles Sheth, Narendra, Disney, Ralph, and Altun, Mehmet *Reliability Prediction - Mechanical Stress/Strength Interference (Non-Ferrous)*, University of Michigan under government contract RADC-TR-68-403, 1968.
21. *Military Handbook 217*, Rev F2, 1991, Now obsolete for new design.
22. *Handbook of 217 Plus Reliability Prediction Models*, Created and published by the Reliability Information Analysis Center, under contract to the DOD, Utica, 2006
23. *Reliability Prediction Procedure for Electronic Equipment*, Telcordia Technologies Special Report, SR-332, Piscataway, 2001
24. Rossi, Michael, *Non-Operating Reliability Databook*, Created and published by the Reliability Analysis Center, under contract to the Rome Air Development Center, Utica, 1987
25. Dhillon, B.S., *Mechanical Reliability: Theory, Models and Applications*, American Institute of Aeronautics and Astronautics, Washington, 1988
26. Locks, Mitchell, *Reliability, Maintainability and Availability Assessment*, second edition, ASQ, Milwaukee, 1995

Appendix - Cost Issues during the Development of a Reliable Product

Summary

Two new medical blood analyzers (laboratory instruments) were designed, developed and readied for production. Near the end of this development activity, prototype systems were tested and exhibited lower than desired reliability in customer simulation life tests. It was unclear to the designers why the instruments had performed so poorly since "**the best design criteria and practices**" were employed. This section will detail the project findings at this point in time, as well as, the methods used for product improvement and the ways to improve overall customer satisfaction.

Some of the technical choices and tradeoffs for improving quality, reliability, maintainability, projected field performance, overall development costs are identified. The critical element of some of the "management decisions" that strongly effect field quality and reliability will be identified. The reliability, maintainability, support and improvement data should prove highly instructive for any commercial or consumer company wishing to improve the product development process. Benchmark data is presented to aid others in establishing progress points during development.

Detail of Two Systems

The problem of producing a reliable complex medical equipment system (the same problems as producing any product; see BusinessWeek Nov. 91 and BusinessWeek Aug. 93) can be shown acutely by the following Management choices usually include "how much quality and reliability" to design into the system and how to "cost effectively" produce the "best system" for the company and the customers. These are only two of the problems that face any development project. Two systems will be employed to illustrate some of the many choices.

System A is a small, stand-alone instrument with moderate software needs, simple standard hardware, a precision mechanical motion section as well as electronics and fluidics handling subsystems.

System B is, by contrast, a large, fully integrated complex system that adds extensive complex computer power and software control, limited simple mechanical motions, but adds complex heating and cooling area requirements to the mix described by System A.

Some of the lessons learned by each project, the choices made and the problems resolved provide a series of benchmarks and valuable examples. This paper is restricted to some aspects of quality, reliability and related design and development issues. These include the prediction of reliability, measurements of subsystem reliability, the quantity of warranty spares, the cost to create trained repair people, costs for special set-up and debug of a delivered system, the special needs for unexpected repairs and all the costs associated with monitoring and controlling these activities. Through this information, the typical quality, reliability or development engineer or project manager will have sufficient meaningful benchmarks and a partial road map of common do's and don'ts. Many books have been published that talk around this area or speak in general terms. Few books or articles talk in sufficient detail about quality, reliability, maintainability, time to market, design features, warranty support with all of their associated costs and the "best ways" to balance their diverse requirements in order to create an optimum product through a tuned development process. (Shima, 1991, pp 29, 32, 44). To quote Ted Levitt,

"Satisfaction is, as it should be, mute. Its prior presence is affirmed only by its subsequent absence. And that's dangerous, because the customer will be aware only of failure, of dissatisfaction, not of success or satisfaction."(Levitt, 1986)

The Development Process

The following is a short summary of the design and development process for instruments A and B. These are discussed because they are typical of the development cycles of many products in other fields. Improvement activities and metrics for the development process and subsequent field deployment are shown at the end of this section.

System A is a small table top instrument that was designed to operate about 10 hours per day about 250 days of the year. A target reliability of no more than 4 catastrophic (Type A in Table I) failures per year was established as a goal early in the development process. This number was based upon market research and competition. The development process was set at 18 months. The product was designed with existing "off the shelf" mechanical and electronic technology. It was developed by a small dedicated staff of development engineers (no people with quality or reliability background were on the development team). Several prototype systems were built and employed by the development team to debug and improve the initial design; two prototype systems were dedicated to the concurrent software development and one prototype system would be dedicated to development chemistry work. These three original prototype systems initially seem to work, but were not very reliable in any of the prototype development work. For six months the hardware development group and the software group worked with the fragile prototype systems waiting for the improved versions (more than 10 preproduction units). About six months into the development cycle, ten preproduction systems were built by manufacturing people to marked-up preliminary process documents. By the third preproduction system built, a clear series of continued problems was present. None of these first three new systems would work for more than several days. In fact, they were worse than the earlier systems. The new systems showed a variety of new problems, not previously shown.

System B was a large complex system with a planned four year development cycle and a large, fully representative project oriented staff. This staff included many development engineers, advanced manufacturing engineers, quality people, procurement and production control people. This system is three to four times as complex as System A and was primarily a software-controlled system with some new technology that was not yet fully developed. Reliability goals were established as less than 5.0 customer failures (catastrophic, type A only) in the first year after release. The First year of development was primarily working with crude parts of the full system. During the second and third year of the development process a series of prototype subassemblies had been independently operated through the equivalent of five full years of customer operation cycles. These were primarily wear type tests and the 16 subassemblies operated independently without characteristic system loads. No significant quality, reliability or design issues were identified as a result of these wear out life tests. Systems were run for a pre-determined time and the tests shut down with few real failures observed. The records of this expensive test life test (\$500,000) were actually very sketchy in retrospect. Later, in the fourth year of development, the first full prototype systems were assembled under the direction of the development team. None of the initial prototype systems would actually operate. The problems ranged from mechanical assemblies that would not fit into each other, assemblies that crashed into each other during operation, electronics that were designed to different standards and so would not talk to each other and software that failed to properly identify the range of motions and limit the motions to safe conditions. This caused an additional six month internal delay while the many problems were fully identified and eventually resolved. About a year after this point, in the fifth year of development a few preproduction systems were then assembled. This was under the guidance of the development team. These systems did not work well either. The reasons included the fact that at this point "no clear definition of system failure" had been identified. This complex system could have several levels of non-performance, not all of which would be catastrophic. So system failures would not be obvious to the typical customer. This lack of clear definitions had earlier masked some of the real problems, which tended to be written off as

"unlikely to happen in production" by the development people. Many of the problems were ascribed to manufacturing errors as causes.

Table A1 - List of Typical Levels of Failure of a Complex System

Type A - This catastrophic **system failure** causes immediate system shut down and loss of information. The customer cannot resolve the problem and a technical service visit is required to return the system to full operation. The system is shut down during this time while waiting for a service technician.

Type B - This catastrophic system failure causes a system shut down and possible loss of information. The customer is able to return the system to operation by a series of actions that may be directed by technical service people via phone or email. Down time is typically in excess of one-half hour. Examples include small software errors, fuse failures, monitoring sensor failures or other hardware faults.

Type C - This system shut down can be resolved by the customer with little or no outside help. There may be a loss of some data, but the system can be returned to operation quickly. Typical situations include unexpected power downs, unexpected system resets, interruptions of the system normal operation by the customer and electrical noise present within the system or around the system.

Type D - The system does not operate properly, but this may not be readily apparent to the customer. Special knowledge or tools may be required to identify the fact that the system may be providing questionable data. Normally a customer cannot detect this level of system non-performance. The system appears to be operating correctly.

Possibilities for Improvement

While system level definitions of failure are valuable we also need component level Definitions of failure. Between these two types of definitions we may be able cover most of the failure possibilities and system faults.

Table A2 - U.L. Definitions of Critical Components for Smoke Detectors

Non-Critical - A component is non-critical if all of the failure modes will not result in a trouble signal or have no effect on the intended operation of the smoke detector for alarm and trouble signals and will not affect the detector sensitivity.

Critical - A component is critical if two or more of the failure modes of the component, which will affect the intended operation or the sensitivity of the detector, do result in a trouble signal.

Conditionally Critical - A component is considered conditionally critical if only one failure mode of the component will affect the intended operation or the sensitivity of the detector, and it does not result in a trouble signal.

Trouble Signal - A trouble signal may be indicated by energization of an audible signal, energization of a separate visual indication (amber or orange), or de-energization of a power-on light. If a visual indication is depended on to denote a trouble condition, it shall have a documented predicted failure rate.

The development of any complex hardware & software system can be described as a series of difficult choices (Shima 1991, p44). This might be described as a balancing act between system performance, the development schedule, feature sets, total cost to develop, total cost to manufacture, system quality, system reliability, field warranty failures and after warranty support. The object is to optimize the combination of all of these. No one of these metrics can be neglected or can dominate the others. If this happens, the other metrics will suffer and cause increased development costs and delayed release to production. Development is truly a complex juggling act at each stage of the process. Figure 1 shows this schematically.

We now ask a difficult question, “What were the expectations of the project management people for either system A or B?” Each project had established reliability, maintainability, manpower, feature, time to develop, cost of production, quality and overall cost goals. In retrospect, some of these goals were either incomplete or stated in a misleading fashion. Both projects focused upon the development cost, development time, features, and manpower goals from the start for both Systems A and B projects. Reliability, quality, maintainability and warranty were treated as "secondary project goals" during the development process. A few examples of potential **improvements** and appropriate **metrics** any project might include are the following:

1. Establish **well defined** minimum **quality and reliability** goals early in the development cycle for all major subassemblies of the product. This includes electrical and mechanical hardware, fluidics, and software.
2. Establish high quality and reliability **goals for suppliers** (critical ones) of all important or critical parts, subassemblies or purchased assemblies early in the development process. This is a prototype stage activity that should be updated during preproduction and production stages.
3. Perform a preliminary **reliability prediction** during the prototype development for the whole system. This includes all electrical and mechanical hardware, fluidics, and software. Compare the prediction results to the marketing and design goals. Use this prediction to help identify important and critical parts, subassemblies and purchased materials.
4. Create measurable **design verification test** and design validation test goals. Be sure these development activities cover all aspects of the project including reliability measures and customer feature measures.
5. Consider the possible failure modes of critical parts of the system. Perform a failure modes effects analysis (**FMEA**), a hazard analysis (HA), and a fault tree analysis (FTA) during the prototype development stage. Use these tools to help identify important and/or critical parts, suppliers, materials and system functions. Identify a list of safety issues, customer misuse and abuse potential and misinformation potential, if these exist at customer's sites. (McLinn, MDDI 1994). Next define a series of tests that verify if the failure modes have been eliminated or reduced in impact. Close the loop on potential problems.
6. Establish a series of short, highly accelerated, multiple-environment **stress tests** that cover the major functional parts of the system, or better yet, of the whole system. These are used to evaluate the potential field performance and reliability. Remember to operate the system in a fashion similar to that of a worst case customer. Be wary of interactions between various hardware assemblies or hardware and software. Define a failure before the start of the test and keep definitions similar to one a customer would use. Be sure to operate any life tests for more than two years of equivalent customer operation on *each system* in this test.

7. Establish **metrics for performance measurements** during the whole development process. Examples include manpower needs, operating costs, reliability, parts failures and projected warranty field failures. Use these metrics on future development projects as a “lessons learned”.

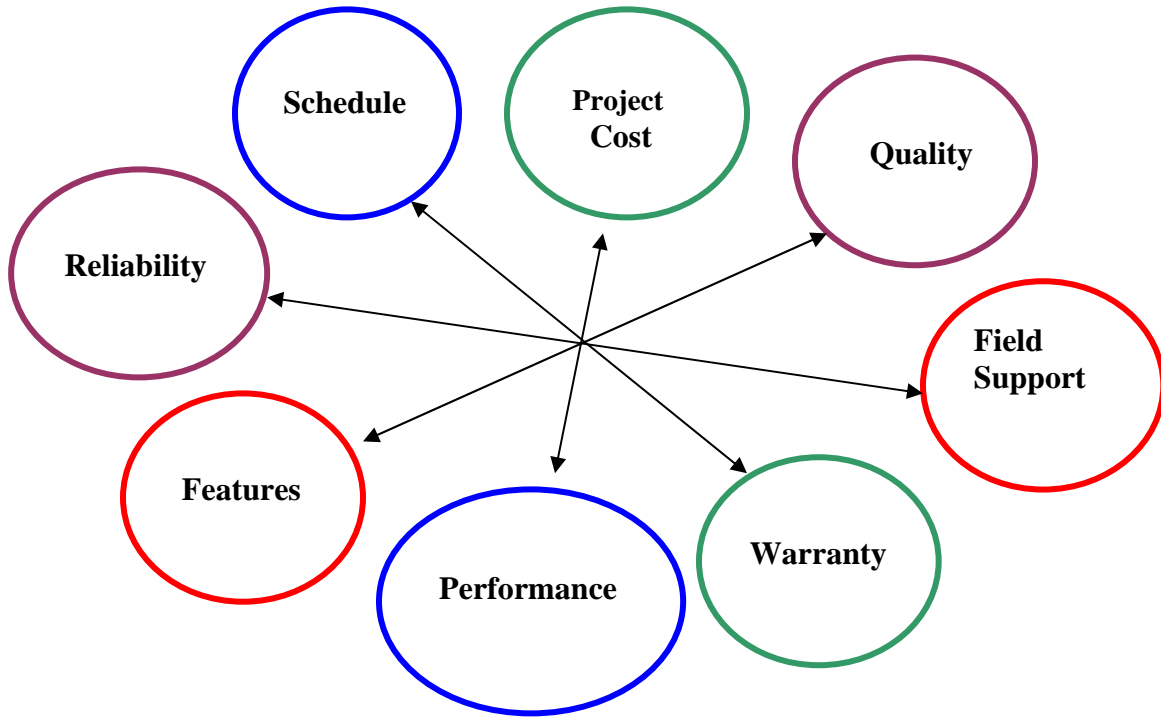

Figure A1 – The Eight Dynamics of a Development Project

8. Consider running a test such as **HALT** (Highly Accelerated Life Test) on all eligible assemblies or the whole system. Be sure to fix the hardware and software problems discovered. These failures will be new and different from verification test results or life test results.

9. **Keep good data** at all steps of the development. Maintain a log book with every system or long all failures into a computerized system that documents causes, problems and corrective actions. All activity of and on the system should be logged as well as an "system operating time meter" and an "on time meter" or an “operating cycle meter”. These are important metrics needed for later tests and customer simulations.

10. Be sure your development team has the **proper depth and breadth** of people at the start. Training is key for success. You note that neither team (system A or B) had people familiar with or trained in basic reliability. One team, system A, had no quality people involved in development until very late in the development process when it became time to transfer the project to production.

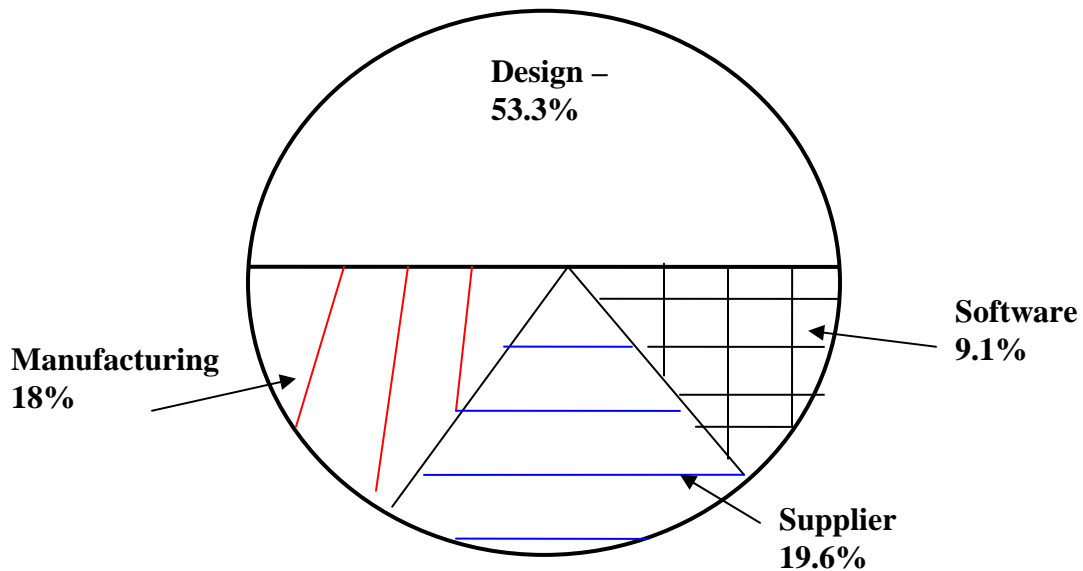

Figure A2 – The Development Failure Breakdown Observed on System A

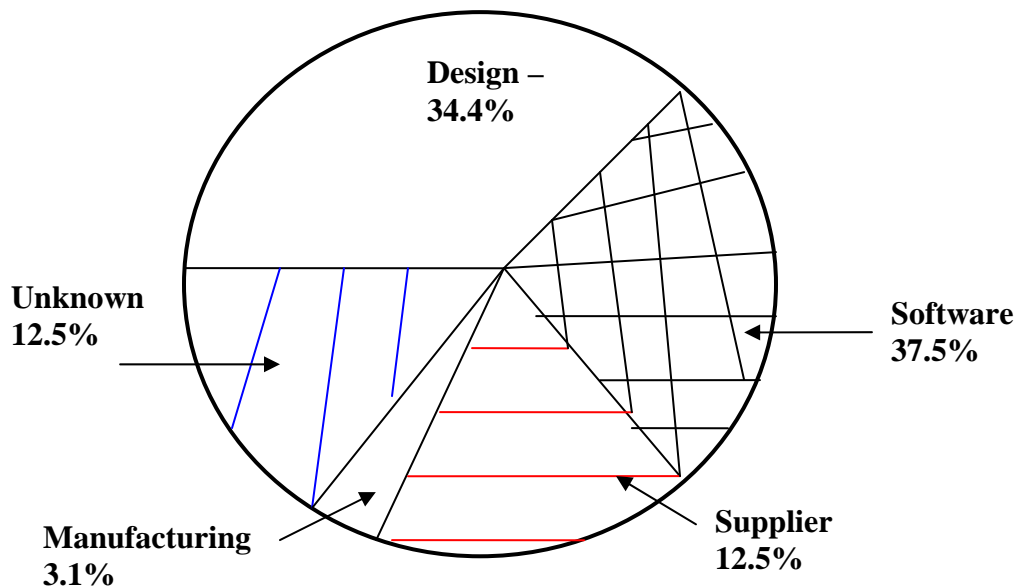

Figure A3 – The Development Failure Breakdown Observed on System B

Metrics for the Systems

The following is some of the details and metrics of Systems A and B development. They are typical of those any company might find useful. One metric is the breakdown of the valid failures by causal area. This is shown as a pie chart with design, manufacturing, supplier (component), operator and software issues. Figures A2 and A3 shows examples of this breakdown for Systems A and B during

the development cycle. We expect to see this pie chart to have a strong design portion early in development and a lesser design dependence as development proceeds. It is clear that System A has a much bigger percentage of design related problems during development while System B shows software is the biggest development problem. Figure A4 and Figure A6 show the pie charts for System A in the first year after release and for the second year after release. These pie charts document that as this project moved from development into production, the design portion of the pie fell as software and customer related problems increased. System B was a bit different; here as the design portion and supplier portion increased in the field while software problems declined.

Design Manpower - System A found that they needed to add two people for 1/2 year (about a 10% increase in manpower) each during development, once they identified serious reliability and quality problems were present in the prototype and preproduction units. This manpower increase allowed them to stay close to the original development schedule. The project management then elected to release an incomplete product and to spend the first year after release to production "working out" the remaining bugs. This turned out to be a costly strategy as documented in Table III. The "failure to do a good job" during development and the cost to redo the design during development was estimated at less than 1/4 of the cost that was later accumulated to fix the problems. This was despite hiring two additional people part time to help with System A development.

System B added 20% additional people to their development team and extended the development time by 50% in order to avoid releasing a product that would not meet their corporate goals for performance, reliability and customer satisfaction. Since System B was much more complex than System A, this appeared to be wise. Total costs for this decision were not available. It is clear however that avoidance activity would have cost much less than the costs to rectify the problems in the field.

Schedule Adherence – The System A project elected to stay close to the original schedule by cutting some corners and adding people to solve "immediate problems" once they were discovered. No manpower was allocated to any longer range issues such as working with suppliers and problem prevention. Manpower was added to continue to implement a series of mechanical improvements beyond the first year of production. In reality, at 15 months post release a series of improvements were still being incorporated. This 15 months would be more properly counted as part of the development time. Such an extension would represent more than a 60% increase to the original schedule 24 months. The costs to find and incorporate the System A electronic, mechanical, fluidic and software failures during an extended development period would have been less than retrofitting the same problems in the field. Additionally, the negative customer perception of this new system would have been reduced. The clear trade-off was to ship a known faulty system early in order to obtain the revenue.

System B did extend development by 50%, clearly incurring a large increase in development costs in order to avoid high support costs later. Note the difference in choices. Both projects were delayed by about the same percentage of time in order to achieve their ultimate project goals. One project (A) was "officially released" and fixed in the field while project (B) elected to fix the development problems prior to release at lower relative costs to the project. Both decisions cost each company money, but the Company B retained a reputation for producing an effective and reliable system. Company A still retains a reputation for not producing a reliable system, even though by year three after product release, System A was performing well.

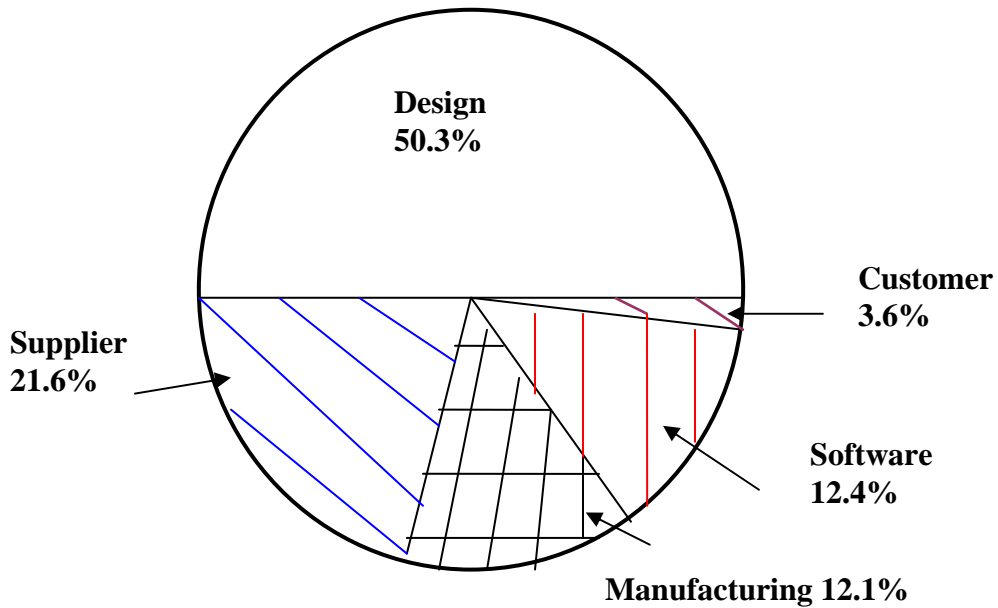

Figure A4 – First Year Field Data from System A

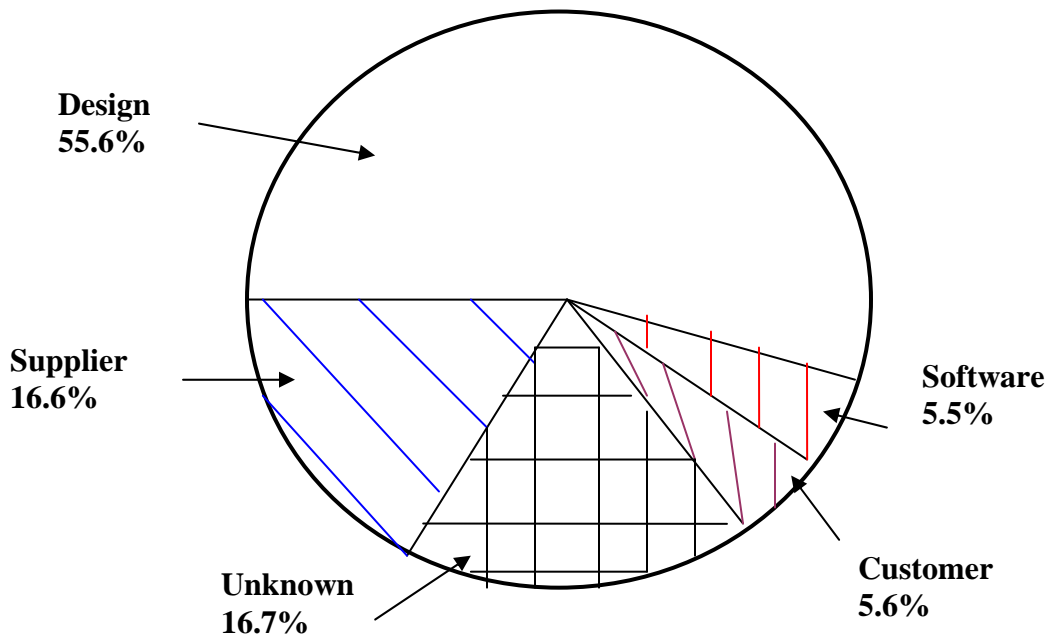

Figure A5 – The First Year Field Data of System B

Reliability - The System A initial reliability goal was “less than four unexpected failures per customer year”. It was not met at product release and for several years. The first year product number was approximately 12 failures per system per year during the first six months. This was reduced to about 6.0 in the second six months of the first year. It later achieved about 4.0 just during the second year after release. Two major field maintenance activities were required in addition to achieve these numbers. This was in addition to repair of any failures to achieve reliability improvement. A reliability prediction for this System A had been based on the Bellcore handbook 1992 and suggested the electronics might be

capable of an MTBF of about 2.0 failures per year. Thus, System A operating at about 4.0 failures per year for all reasons (electronic, mechanical, fluid, software) could still be improved based on the field results. Even though the initial system reliability target was 4.0 failures per system per year for all reasons, it was clear after a year in the field that System A could do better.

System B was initially operating at approximately double the desired release goal of 5.0 (type A failures only) failures per year during development tests. This was brought down to less than 5.0 at about a year after release to production. A reliability prediction (electronics only) for System B, performed to Bellcore (1997) indicated an expected failure rate of 1.5 electronics failures per system per year on this scale. Thus System B, at 5.0 failures per system per year, having achieved its original reliability target, could likewise still be improved. A Software reliability prediction was not made for either system, though software was not a big contributor to system failures by the end of year one in the field.

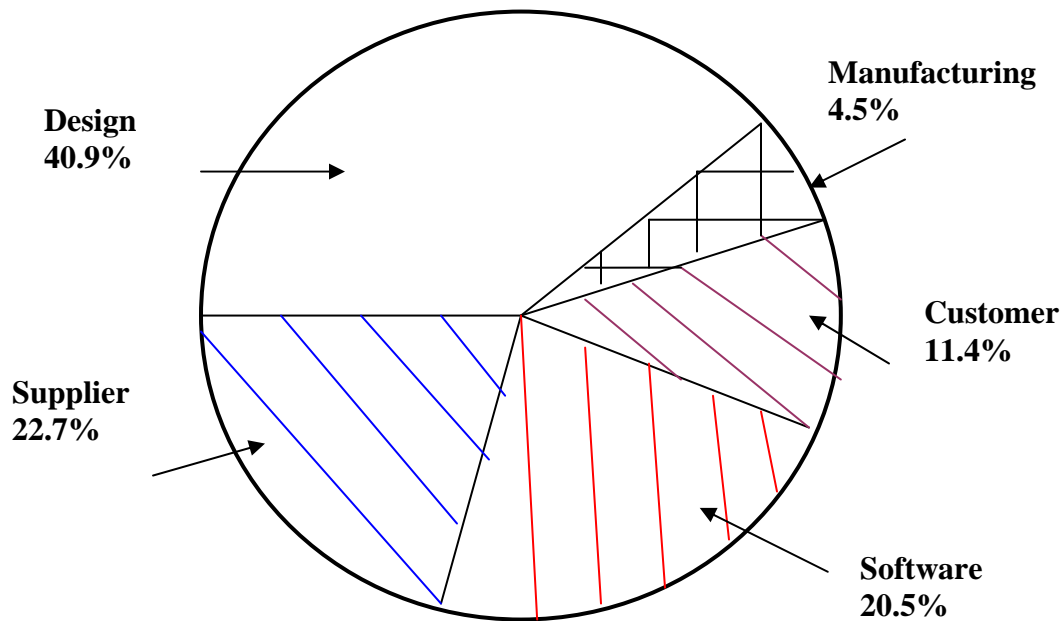

Figure A6 – The Second Year of Field Data for System A

Maintenance Activities - Planned maintenance activities were few for both systems. System A had a planned maintenance activity level of 1.0 per year, but required two maintenance actions for the first two years to reduce a specific design problem. System A reduced the unplanned field repair team support staff from 5 people to 3 people by the end of the second year in the field. As the failure rate dropped from 12 to under 4 the extra manpower became unnecessary. The two "extra" people represented six man years that should have not been needed initially because of the failure to do a good job during development.

System B had a planned maintenance of 2.0 per year and achieved that number by the end of the first year in the field. System B maintained a constant service level through the first two years. No extra people were needed to support the system in the field even though it did not initially meet its reliability goal. This represented an extra cost of 0.5 to 1.0 extra man-year.

Quality and Design Simplification - Not long after release System A people recognized that many of the problems were related to shortcuts mandated during the original design development process. The project schedule had been the top priority for this system and the rest of the project performance metrics (reliability, quality, maintenance, costs and warranty etc.) had suffered because of the drive to stay on schedule. This project elected to "clean up" and simplify the design deficiencies after it went into

production. Part of the improvement was a massive mechanical redesign. It consisted of combining mechanical parts, eliminating components and improving overall design tolerances. This activity reduced procured parts by 30% (i.e. 30% fewer parts went into every system) and made them easier to produce to specification. This activity also reduced the manufacturing time by 40% with overall "cost to manufacture" being reduced by more than 50%. This was a reflection of fewer required adjustment operations and many fewer quality rejects during manufacture. This improvement activity strongly aided system reliability by reducing subsequent field failures in the second half of the first year and into the second year after release. In fact, for systems manufactured in the second year, the mix of failure causes had changed (shown in Figure 6A).

System B people elected not to simplify their design and did not reduce manufacturing time or costs more than 10% by and improvements. No second year data is available for this system. Engineering cost estimates suggested there was a 30% cost reduction potential available that was never implemented for System B. This was because the project had taken too long and the necessary engineers were now needed on projects elsewhere.

Issues with Spares - System A, not having performed a reliability prediction early in the development, elected to set aside spares parts at the rate of 25% of planned manufactured systems. After three years, except for two problem systematic parts (design issues), the highest need for spares was found to be a cumulative 10%. A large quantity of spares stock (tied up for three years) was then returned to manufacturing stock as a big surplus. This represented a large amount of development money (about \$2,000,000) tied up in unnecessary spares stock with its carrying charges.

Project people for System B had employed past experience and a detailed reliability prediction early on in creating their spares policy. No large quantities of parts were set aside. Table III illustrates the cost associated with this type of activity and these decisions.

Reliability Growth - System A showed "reliability growth" especially during the first two years in production. A number of activities were involved. These included reliability screens of some parts, special testing of assemblies, selection of parts, design changes, manufacturing changes, system set up changes, training changes and maintenance schedule adjustments. All of these activities contributed to the overall improvement observed by the customer. Figure A7 shows this in two ways, first there was continuous changes made as serial numbers increased. Secondly, a given block of serial numbers showed reduced failures over time.

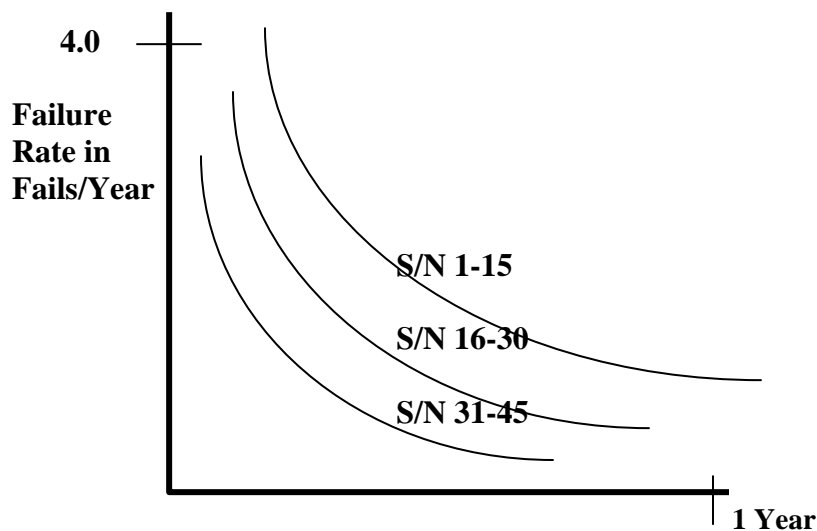

Figure A7 – Performance of Successive Production Lots by Serial Number of System A

Costs Estimates - For System A, all units in the field during the first six months would require an extra 73 service calls and 43 customer complaints. A low “burden factor” of 2.1 was selected for calculations. The average failure rate for the time interval was 5.50. A similar column was generated for a hypothetical situation of 2.4 failures per year. With the numbers shown in Table III, we can calculate the return on investment (ROI) concerning the decision to take proactive actions not reduce the early failures. We will ignore the cost of the development engineering staff and support groups not involved in the improvements, since this ROI refers to the improvement decision only.

Table A3 - Table of Typical Costs Associated with System A

Activity Area	Total Estimated Costs, Activity Burdened	
	at 5.5F/S/yr	at 2.4F/S/yr
Repairs at 73 calls, each \$1250 or (73)(\$1250)(2.1) =	\$191,625	\$73,623
Service calls , 43 at \$250 each or (43)(\$250)(2.1) =	\$ 22,575	\$ 9,843
Field service people salaries	\$152,250	\$102,250
Spares stock, 6 sets , 10% carrying charge (6)(1.1)(16,000) =	\$105,600	\$52,800
Field spares, 4 sets, one with each repair person	\$ 70,393	\$52,800
Development support	\$ 31,500	\$10,500
Reports, special	\$ 5,000	\$ 2,000
Improvement efforts		
Engineering	\$ 45,000	\$10,000
Profits from lost sales	\$ 35,000	\$25,000
Failure Analysis	\$ 36,500	\$15,927
Manufacturing Efforts	<u>\$ 14,000</u>	<u>\$ 6,000</u>
Totals	\$704,443	\$360,743
Potential Savings = \$343,700		
The estimated cost of additional engineering efforts to reduce the failure rate from 5.5 to 2.4 failures/system/yr are estimated as \$57,000 in additional costs with the following additional savings:		
Engineering support, people savings	\$ 48,000	
Design simplification, reduced drawings, orders and stock	\$141,000	
Field service reduced changes and documents	<u>\$ 12,000</u>	
Total additional Savings	\$201,000	

$$\text{ROI} = \frac{\$343,700 + \$210,000}{\$57,000} = \mathbf{9.56}$$

Thus, it makes sense to reduce the expected level of failures, reduce spares and support manpower. The reason that this ROI number is so high, is that most of the identifiable costs are included, but not background support costs. The costs for decreased parts, fewer orders, lower stocks and reduced failure analysis were neglected. These were almost half of the expected improvement savings for System A.

Conclusions

The efforts of management decisions on improvement efforts for System A and System B have been documented for impacts on development costs, follow-up engineering support costs and expected field failures. These numbers represent a series of decisions that can be made as part of a reliability improvement effort (McLinn 1994, AQC). Profits from lost sales and the impact of spares policies were not included here. At times, some projects view schedule as the "foremost among equals". It is viewed as the most critical variable. This is sometimes referred to in the literature as meeting a "window of opportunity", suggesting it opens for a short time and then closes forever. The data from these two projects suggest this market driven view may not be correct. System A was reviewed by management in this light and the decision was still made to move to "capture the window". History has now shown that for this system a greatly extended "window of opportunity" developed and new market applications evolved. In retrospect, a controlled release of System A might have been a better decision than the full release to "capture a window of opportunity". This project did not make a profit until after the full second year in production, because of the high field failure and support costs. It also had a strong impact on the engineering staff, who knew they were being asked to turn out a product that was less than the customers desired. By three years after release many of the key designers had left company A.

System B was late to the market "window of opportunity", but well accepted by customers. Costs were better controlled than for System A and the staff at Company B did not feel they had been forced to turn out a bad product. Thus, the future purchase of new equipment was not ruled out as it appeared to be with a number of early purchasers of System A.

Appendix Reference List

- Levitt, Theodore, *The Marketing Imagination*, The Free Press Division of MacMillian Inc., 1986, New York
- McLinn, J.A., "Qualification Testing: Considerations for a Comprehensive Program", Medical Devices and Diagnostics Inc., May 1994, Hitchcock Publications pp. 224- 231
- McLinn, J.A., "Improving the Product Development Process", 48th. Annual Quality Congress Proceedings, 1994, Las Vegas, pp. 507- 516
- Shima, S. *Concurrent Engineering and Design for Manufacture of Electronic Products*, Van Nostrand Reinhold, 1991, pp. 29-32
- Shima, S., *ob. cit.* p 32
- Shima, S., *ob. cit.* pp. 44- 46
- BusinessWeek , November 18, 1991 pp. 62-66
- BusinessWeek, August 16, 1993 pp. 76-82
- Bellcore, TR-NWT-000332, *Reliability Prediction Procedure for Electronic Equipment*, Issue 4, September 1992, Piscataway, New Jersey

Reliability Division, ASQ
PUBLICATIONS ORDER FORM

Specify publication(s) desired, quantity and delivery address. Enclose your check or money order.

Contact:(person placing order): _____ EMAIL ADDRESS: _____
 Phone # Work _____ Home # _____
 Ordered for (name): _____
 Mail to (Address) _____
 City, State, Postal Code, Country _____

ORDER FORM

QUANT. PRICE = TOTAL

Reliability Review: _____ **EACH**
 Available Back Issues (Specify which) _____ \$10.00 _____

Monographs

Practical Weibull Analysis 5th edition by J. McLinn, CRE _____ \$30.00 _____

Practical Accelerated Life Testing by J. McLinn CRE _____ \$30.00 _____

Design For Reliability by X. Tian, Ph.D. et. al. _____ \$30.00 _____

Mechanical Design Reliability (2nd) McLinn, CRE _____ \$25.00 _____

Credible Reliability Prediction by Larry George, Ph.D. _____ \$25.00 _____

**Develop Reliable Software at Low Life Cycle Cost
by Dr. N. Schneidewind, and Dr. Sam Keene** _____ \$25.00 _____

**Homeland Security & Reliability – Airport Model
by Dr. N. Schneidewind IEEE Congressional Fellow** _____ \$25.00 _____

TOTALS Qty. _____ \$ _____

MAILING & HANDLING . Within USA, add \$7.00 first copy.+ \$3.00 per additional copy

QUANTITY ORDERED _____ , TOTAL MAILING CHARGES _____

For **International Delivery** charges contact us via e-mail with complete order and delivery address

We will quote delivery charges . E-mail: JMReL2@Aol.com International fee \$ _____

TOTAL REMITTANCE [PURCHASE PLUS MAILING] \$ _____

Remit Payment in U.S. Funds and Payable to the **Reliability Division** and send to:

James McLinn RR and Monograph Publisher
 10644 Ginseng Lane
 Hanover, Minnesota 55341-9692 USA
 1 763 498-8814
 E-mail: JMReL2@Aol.com

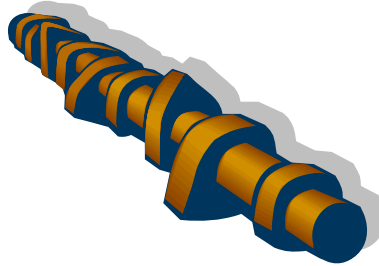

Reliability Division ASQ

The Reliability Division of ASQ has sponsored a Monograph Series in response to requests for articles on a variety of diverse topics of reliability. Copies of any of the RD Monographs may be ordered from:

James McLinn - Monograph Publisher
10644 Ginseng Lane
Hanover, Minnesota 55341 USA

1 763 498-8814

JMReL2@Aol.com

