

MEDIA KIT • 2015

The Atlantic **Current**™

South Florida's Culture and Lifestyle Magazine



About Us

"The Atlantic Current" is the first magazine of its kind in South Florida.

Our magazine started in 2012 with an idea of bringing a quality magazine to South Florida that encompassed the true cultures and lifestyles that exist in our coastal community. In a nutshell, we feature local action sports, music, art, fishing & diving, food, events, feature stories, and much more. We believed that creating a free magazine of quality was the best option to ensure maximum distribution and readership. Over two years later we couldn't be more excited about the progress our company has made. The Atlantic Current has become a household name and copies continue to fly off the shelves at an increasing rate. Our distribution continues to increase and we have expanded our geographic reach from Jupiter to Fort Lauderdale.

The Atlantic Current brings people of all kinds together under one common culture and lifestyle. Whether you are an action sports junkie, aspiring artist, fishing fanatic, tourist, or a typical local, you're guaranteed to find something you will like in our magazine.

Readers are affluent and educated. 64% earn \$50k or more annually and 58% have a college or post college degree

70% of readers 21-44 years of age

Exceptional photography. 83% of readers rate our photography "better than" or "the best" of any local magazine

Long Shelf life = advertising value; 64% keep the magazine for one month or more

57% always or often make purchases from Atlantic Current Magazine advertisers

Competitive rates, promotional tie-ins, and social media promotion allows for customized, effective advertising plans

69% of readers say that The Atlantic Current is the only or is one of a couple of local print publications they read



Who are our readers?

GENDER

Male 56.0%
 Female 44.0%

AGE

21+ 97.0%
 18-34 49.0%
 21-44 70.0%

EDUCATION

Graduated High School 99.0%
 Graduated College 58.0%

INCOME

Earns \$25K - 50K annually 26.0%
 Earns \$50K - 100K annually 34.0%
 Earns more than \$100K annually 30.0%

SHELF LIFE

30.0% keep more than one month
 34.0% keep one month

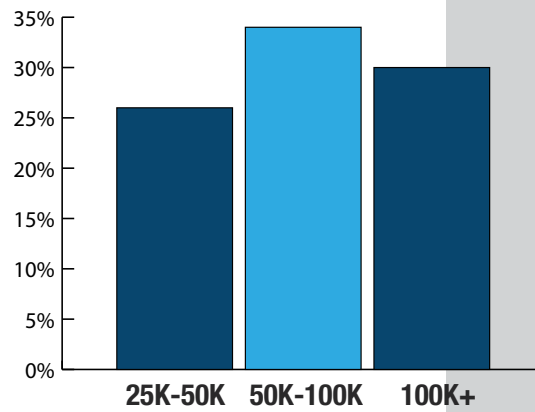
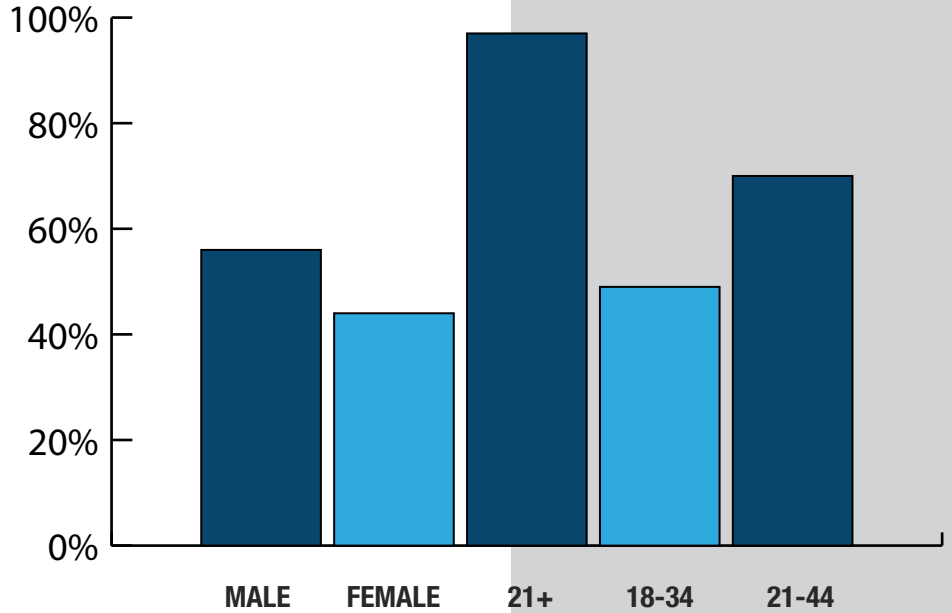

PHOTOGRAPHY

42.0% rate our photography as the best of any local magazine
 41.0% rate our photography as better than most other local magazines



Action Sports

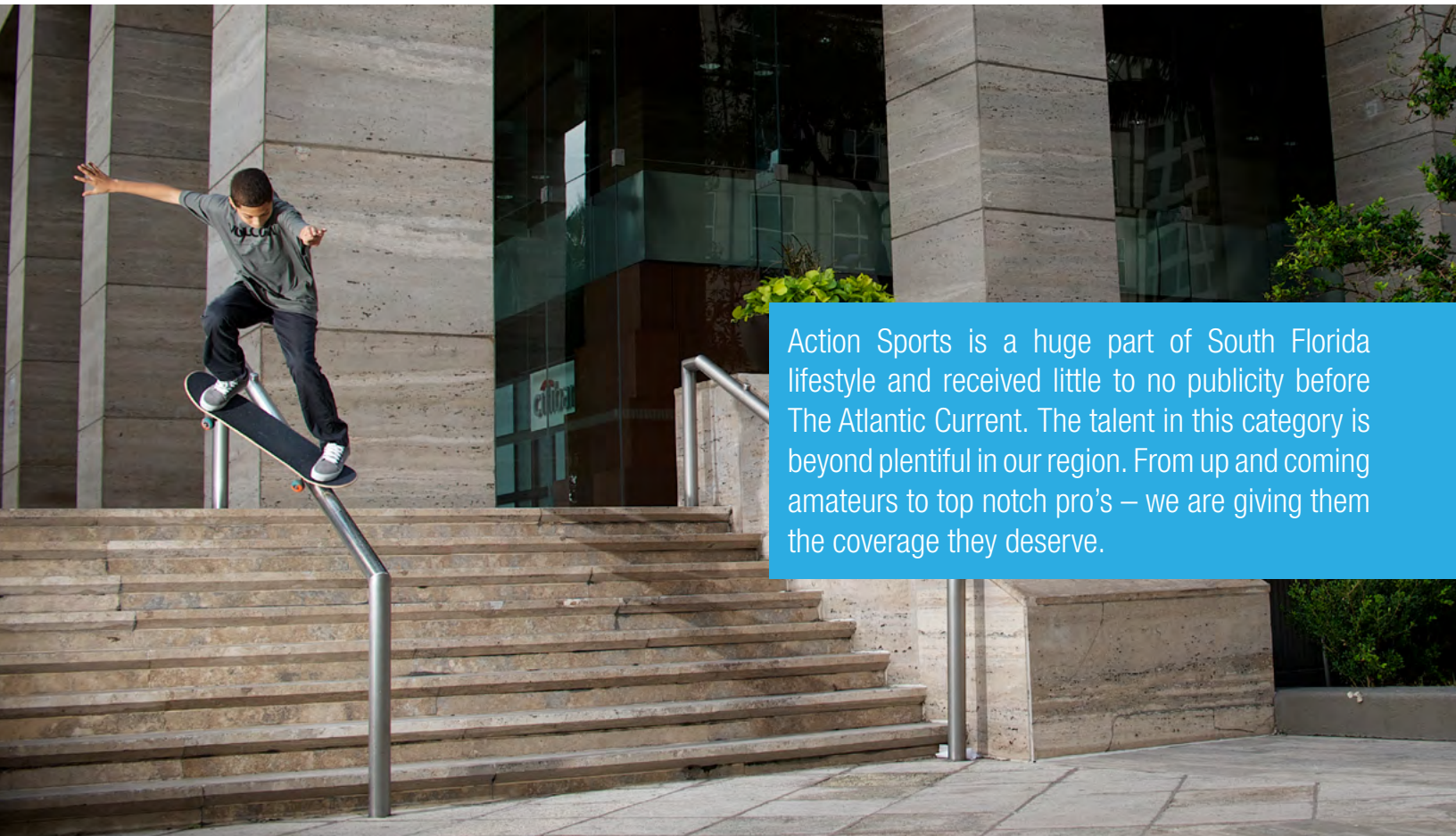

Action Sports is a huge part of South Florida lifestyle and received little to no publicity before The Atlantic Current. The talent in this category is beyond plentiful in our region. From up and coming amateurs to top notch pro's – we are giving them the coverage they deserve.





Music and Arts

The music and arts scene has blown up in recent years. In every issue we bring some of the best musicians and artists our region has to offer.



Local Entertainment

Stay current as we promote and cover the latest and greatest events in South Florida.





Fishing and Diving

South Florida is home to some of the best fishing and diving in the country. In each issue we bring a fishing forecast by local experts and other features related to this common lifestyle.



Food

Our region has endless restaurants with every style of food imaginable. The Atlantic Current features some of the best food finds in the magazine and on our website.





Special Features

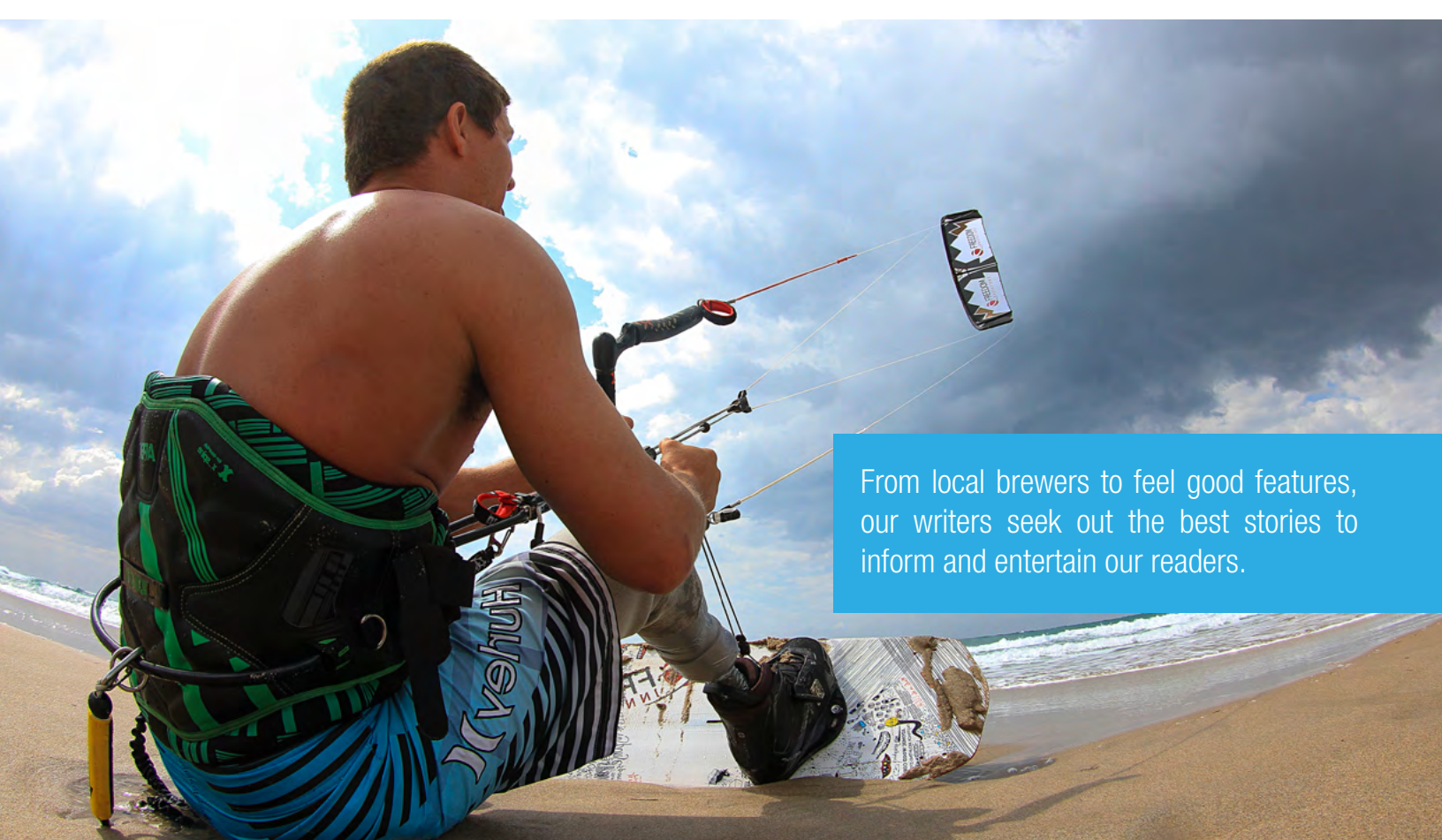

From local brewers to feel good features, our writers seek out the best stories to inform and entertain our readers.

Circulation

JUPITER

3 Natives	Jupiter Kiteboarding
Blue Line Paddle	Local's Surf Shop
FL Paddleboards	Marley's
Food Shack	Ocean Magic Surf Shop
Ground Swell Surf Shop	Tequesta Brewing
Guanabana's	

WEST PALM BEACH

Harold's Coffee	Oshea's Irish Pub
Hullabaloo	Center City Pharmacy
Ink and Pistons	Sub-Culture Coffee
Longboards Restaurant	Wonderland

LAKE WORTH

Island Water Sports	Propaganda
Old Key Lime House	Top 5 Records
Poutine Dog	Tuppen's

BOYNTON BEACH

Due South Brewing Co	South Florida Mastercraft
Maui Wowi	Sweetwater Bar & Grill
Nomad Surf Shop	Tsunami Subs
Seaside Deli and Market	

DELRAY BEACH

3rd and 3rd	Put'n Around Delray
Chamber of Commerce	Saltwater Brewing
Coffee District	Sazio Express
Delivery Dudes	Smart Zone
Epic Surf Shop	Soflo Music School
Fit Foods	Spot Coffee
Mint Fit	The Beat Cup
Nourishe	The Hurricane Bar and Lounge
Pepe's Hideaway	The New Vegan
Planet Juice	Tsunami Subs
Project Mate	

BOCA RATON

4th Generation Market	Heritage Smoke Shop
620 Subs	It's Owl Time
Bagels With a Schmeear	Jaco Hybrid Training Center
Bike America	Lion & Eagle English Pub
Boca Bike Shop	Munchiez
Boca Scooters	Night Owl
Boca Surf & Sail	O'Brian's Bar
Boca's Best Pizza Bar	Ocean Liquors
D'Best Sandwich Shop	Old Dixie Seafood
FAU Breezeway	PA BBQ and Grille
FL E-Cigs and Vapes	Planet Juice
Force-E Scuba	Rogue Wave
Fran's Fried Chicken	Stroke of Genius Tattoo
Funky Buddha	The Duck Tavern
Grateful J's	The Funky Biscuit
Hemp Factory	Wishing Well

DEERFIELD BEACH

2 Georges at the Cove	Kahuna Bar & Grill
American Rock Bar	Mora
Bicycle Generation	Muscle Maker Grill
Bogaert Boards	Oceans 234
Brew Dogs	Rattlesnake Jakes
Charm City Burgers	Ski Rixen
Dixie Divers	Tucker Dukes
El Jefe Luchador	Vapor Haven
Island Water Sports	

POMPANO BEACH

2nd Street Surf Shop	Riva Motorsports & Marine
Custom Rod & Reel	Seafood World
Force-E Scuba	Zona Fresca
Kitesurf Place	

FORT LAUDERDALE

BC Surf & Sport

Over 8,000 copies distributed in over 100 locations from Jupiter to Fort Lauderdale 6 times a year!

The Atlantic Current Magazine is an audited publication by the Circulation Verification Council

7491 N. Federal Hwy, Ste C5-119. Boca Raton, FL 33487 | info@theatlanticcurrent.com | For more info call 561-383-0035 ext 101

Online

All advertisers receive further promotion through our website or social media in addition to their print advertisement.

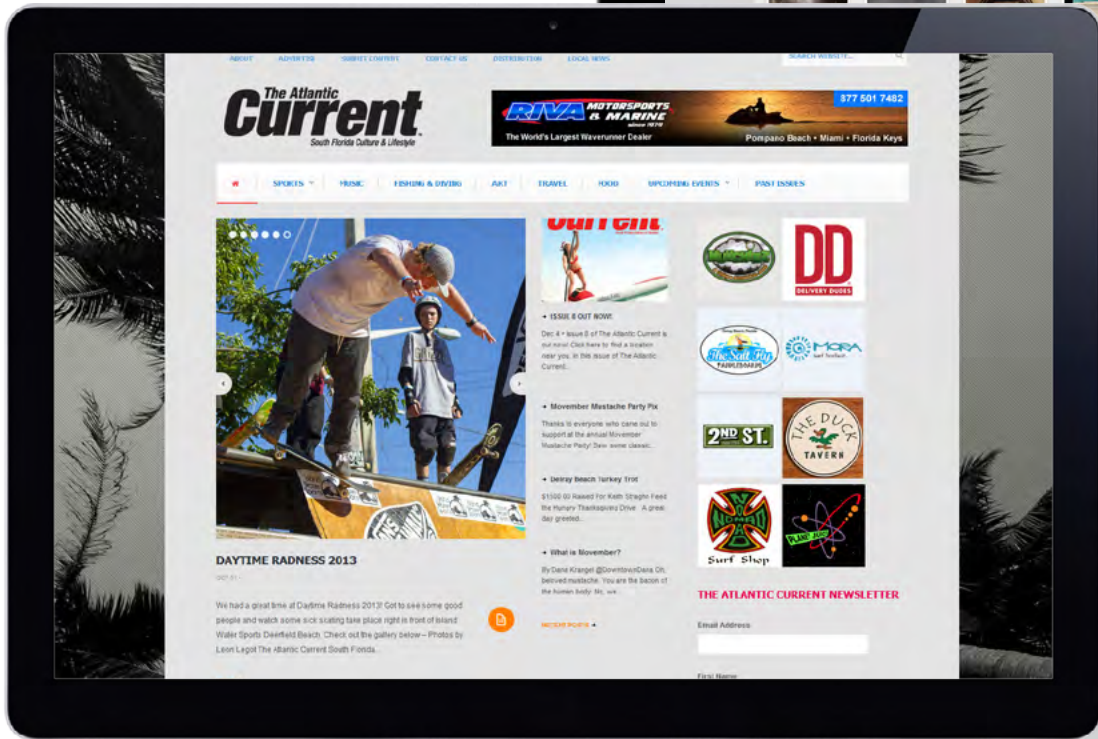
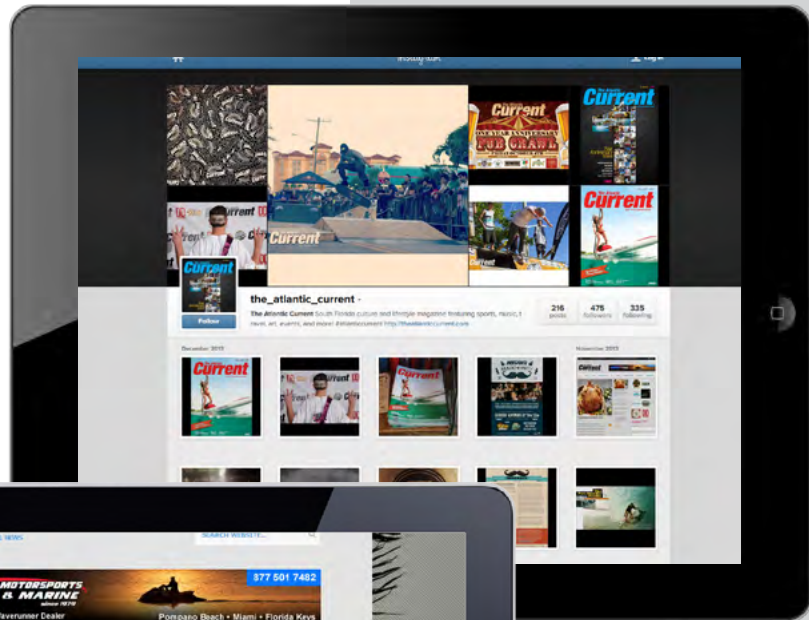

Current Creations

Complete graphic design services available.



Your Atlantic Current Ad Specifications

Mechanical Specifications

Advertisement Dimensions

Full page (bleed)	8.625" x 11.125"
Full page (non-bleed)	7.625" x 10.125"
1/2 page vertical	3.75" x 10.125"
1/2 page horizontal	7.625" x 5"
1/8 page horizontal	3.75" x 2.4375"
1/3 page horizontal	7.625" x 3.3"
1/4 page vertical	3.75" x 5"

Document bleeds extend .125" beyond the trim size of 8.375" x 10.875". All areas not intended to be trimmed MUST be 7.875" x 10.375".

Magazine Specifications

Binding	Saddle Stitched
Trim	8.375" x 10.875"
Live Area	7.875" x 10.375"
Bleed	8.625" x 11.125" (0.125" on each side)
Color	4-color process (GATF/SWOP/CMYK)
Resolution	300 dpi @ 100%

Digital Ads:

Advertisers are required to submit digital files in the following formats.

Listed in order of preference

- Acrobat PDF (PDF/X-1a:2001), with bleeds and crop marks included
- Photoshop Tiff (CMYK at 300dpi)
- InDesign CS5
- Illustrator CS5 (all fonts converted to paths/outlines)

Electronic ads must include all graphic files and all fonts preferably converted to paths/outlines. Pantone colors must be converted to CMYK. Do not supply JPEG files. Please provide a printed disk directory that includes a list of all files on disk, and a separate proof sheet printed at actual size. **Please note:** To avoid additional charges, ads must be supplied in sizes and formats specified above. Alterations or additional preparation of artwork will be charged at cost.

Email all creative materials to: tacreadyads@gmail.com. For large files, please use "YouSendIt" or a similar large file service. You may also submit your creative materials on disc. **Artwork may be overnighted to:** The Atlantic Current, Attention Production Department, 7491 N. Federal Hwy, Ste C5-119. Boca Raton, FL 33487. Please be aware that we cannot assume responsibility for slight color variations. A printed proof page accompanying your submission is strongly suggested.

Ads are due to our production department no later than the 15th of each month. Please ask your sales representative for a calendar of specific due dates and publication dates. At your request, The Atlantic Current will design your ad for you. Hourly design rates may apply. Please ask your sales representative for details.

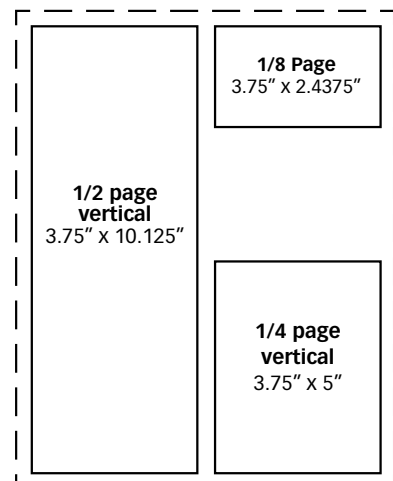
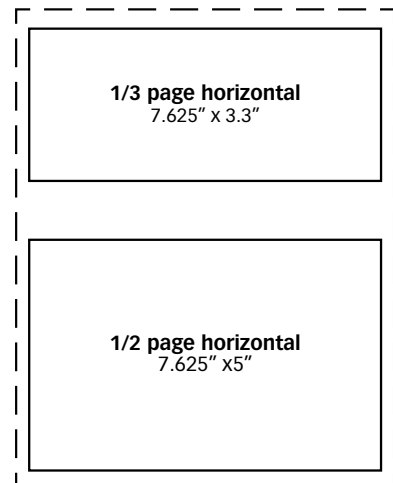
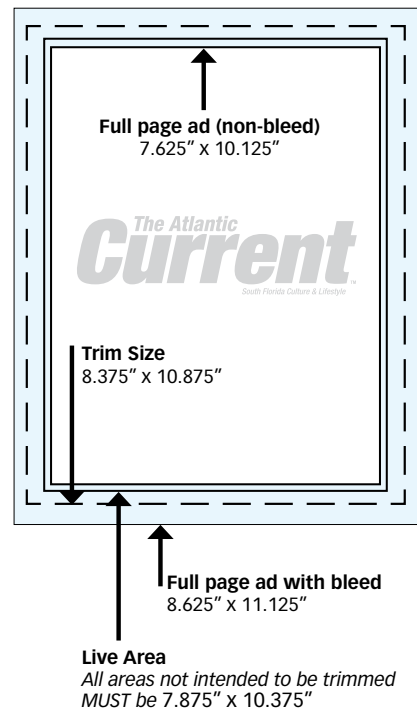



[facebook.com/TheAtlanticCurrent](https://www.facebook.com/TheAtlanticCurrent)



twitter.com/AtlanticCurrent



[instagram.com/the_atlantic_current](https://www.instagram.com/the_atlantic_current)



www.theatlanticcurrent.com



7491 N. Federal Hwy, Ste C5-119. Boca Raton, FL 33487



info@theatlanticcurrent.com



561-383-0035 ext 101