

Medical
Equipment
& Accessories
Catalog

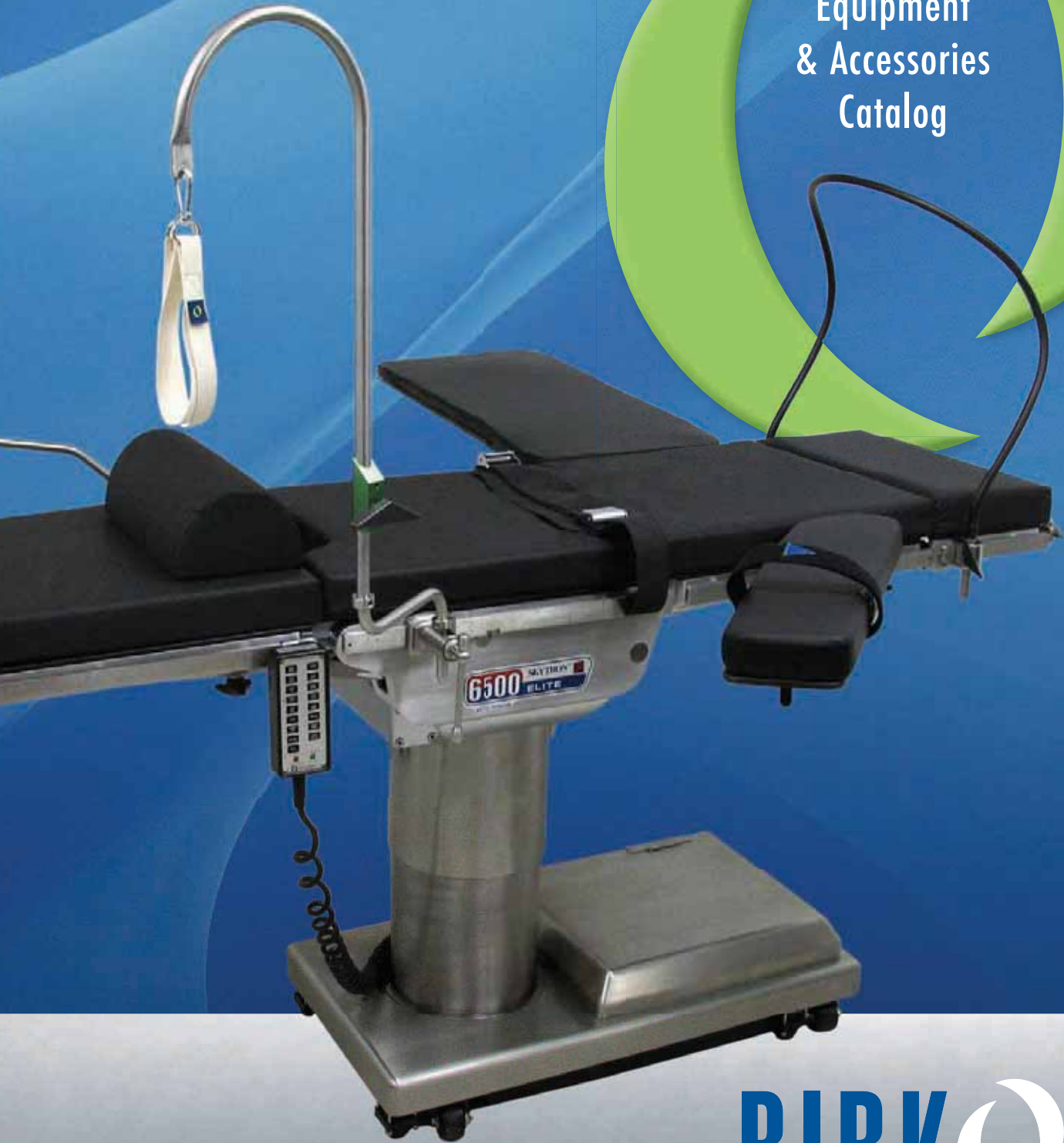

BIRKOVA
Products

Pads & Positioners Surgical Accessories Clinical Furniture



BIRKOVA
Products

809 4th Street
Gothenburg, NE 69138
888-567-4502
PH: 308-537-7300
FAX: 308-537-7363

Product Index

| | | | | | |
|--------------------------------------|----------|---------------------------------------|--------|--------------------------------------|--------|
| Anesthesia Screens | 33 | Kova Care Positioners | 13 | Stacking Stools | 39 |
| Arm & Hand Table Pads | 7 | Kova Lite Positioners | 13 | Stainless Steel Cabinetry | 50 |
| Arm & Hand Tables | 27 | Kross Arm Support | 25 | Stainless Steel Carts | 33 |
| Armboard Pads | 7 | Labor & Delivery Pads | 11 | Stainless Steel Stools | 39 |
| Armboards, Arm Supports | 25 | Lateral Supports | 33 | Stallion Headlight | 41 |
| Armguard Pads | 7 | Leg Extensions | 23 | Stools | 39-40 |
| Armguards | 25 | Leg Preppers | 31 | Stress Post | 29 |
| Arthroscopic Legholder | 31 | Legholder Pads | 9 | Stretcher Pads | 5 |
| Back Tables | 43 | Legholders / Supports | 29 | Stretchers | 35 |
| Bariatric Uni-prepper | 31 | Legholder Replacement Parts | 37 | Super Table Mover | 37 |
| Bariatric Pads | 3, 7, 13 | Linen Hampers | 45 | Surgical Table Pads | 3 |
| Bariatric Roller Board | 35 | Lithotomy Legholders | 31 | Table Extenders | 23 |
| Bassinet Pads | 11 | Mattresses, Birthing Bed | 11 | Table Mover | 37 |
| Bean Bag Positioners | 19 | Mayo Stands | 45 | Tables | 43 |
| Birthing Bed Accessories | 37 | Minor Surgery Tables | 27 | Trash Receptacles | 41 |
| Birthing Bed Mattresses | 11 | Narrow Headrest | 33 | Treatment Tables | 50 |
| Blood Draw Chairs | 50 | Neuro Headrest/Wristrest | 33 | Uni-prepper | 31 |
| Candy Cane Legholders | 31 | Ortho Pads, Boots | 9 | Utensils, S.S. | 46 |
| Carts, Accessory/Legholder | 29 | Pads, Arm Supports | 7 | Utility / Prep Tables | 43 |
| Carts, Stainless Steel | 43 | Pads, Disposable | 21 | Utility Carts | 43, 45 |
| Casters, Parts | 37 | Pads, Legholders | 9 | Velcro | 20 |
| Chairs | 39, 49 | Pads, Positioners | 13-16 | Vinyl Positioners | 15 |
| Clamps | 23 | Pads, Stretcher | 5 | Wall Mount Brackets | 27, 35 |
| Clinical Furniture | 49, 50 | Pads, Surgical Table | 3 | Warming Cabinets | 47 |
| Comf-toppers | 11 | Parts | 37 | Waste Baskets | 41 |
| CUBZ Gel | 15 | Patient Positioners | 13, 15 | Width Extender | 23 |
| Covers, Carts | 43 | Patient Restraint Straps | 20 | Wilson Frame Pads | 9 |
| Cushion Sets | 3 | Patient Transfer Boards | 35 | X-ray Panels | 37 |
| Custom Pads | Call | Pediatric Stretcher/Crib | 35 | X-ray Protection Equipment | 22 |
| Disposables | 21 | Perineal Filler Plate | 37 | | |
| Drainage Bag Systems | 21, 31 | Pickett Fence Prepper | 31 | | |
| Exam Light | 45 | Power Cords | 37 | | |
| Exam Stools | 39 | Powermate, IV Accessory | 41 | | |
| Exam Tables | 49 | Privacy Screens | 49 | | |
| Finger Trap Devices | 37 | Rail Extenders | 23 | | |
| Flexible Anesthesia Screen | 33 | Recliners | 50 | | |
| Foam Positioners | 13, 15 | Restraint Straps | 20 | | |
| Gel Positioners | 15, 17 | Roller Boards | 35 | | |
| Hampers & Bags | 45 | S.S. Utensils | 46 | | |
| Headlight, Stallion | 41 | Sand Bag Positioners | 19 | | |
| Headrests | 33 | Scrub Sinks | 47 | | |
| Instrument Tables | 43 | Siderail Clamps | 23 | | |
| Instrument Trays | 46 | Slide Boards, Transfer | 35 | | |
| IV Poles | 41 | Sliding Headrest | 33 | | |
| Kick Buckets | 45 | Solution Stands | 45 | | |

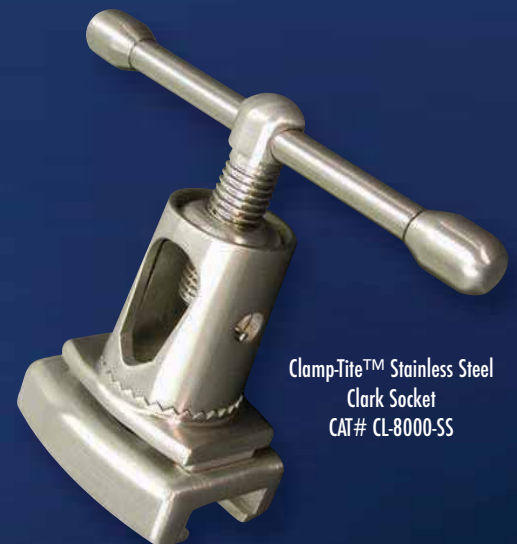

Clamp-Tite™ Stainless Steel
Clark Socket
CAT# CL-8000-SS

Look to Birkova for all your equipment needs!

Surgical Table Cushion Sets



BCS-7020

Standard Series

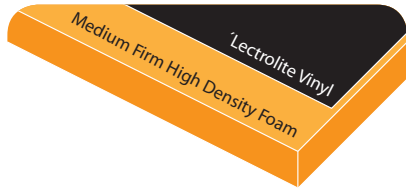

Standard Series cushion sets are recommended for low risk patients, short duration procedures. 2" thick overall. Constructed of medium firm high density foam, covered with Electrically conductive 'Lectrolite vinyl.

Comfort Plus Series

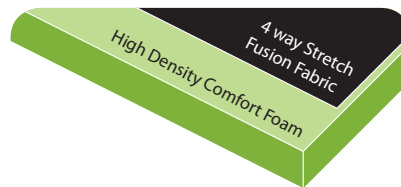

Comfort Plus Series cushion sets provide superior comfort for medium - high risk patients, in average duration procedures. 2" thick overall. Constructed of high density comfort foam, covered with 4-way stretch ultra soft Fusion Fabric (vinyl).

Pro-Tek Series

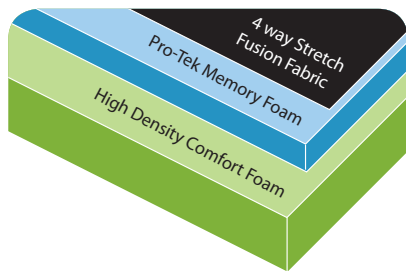

Pro-Tek Series cushion sets are designed for **Pressure Management**, recommended for high risk patients, medium to long duration procedures. 2 1/2" thick overall. Constructed with high density comfort foam, a top layer of anti-shear Pro-Tek Memory foam, covered with 4-way stretch ultra soft Fusion Fabric (vinyl).

Integra-Gel Series

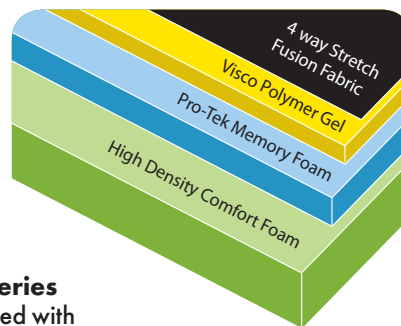

Integra-Gel Series cushion sets are designed with ultimate patient comfort in mind. Recommended for high risk and heavy weight patients. 3" thick overall. Constructed of high density comfort foam, a layer of anti-shear Pro-Tek Memory foam, and a top layer of visco polymer Gel, covered with 4-way stretch ultra soft Fusion Fabric (vinyl).

Bariatric Comfort Series

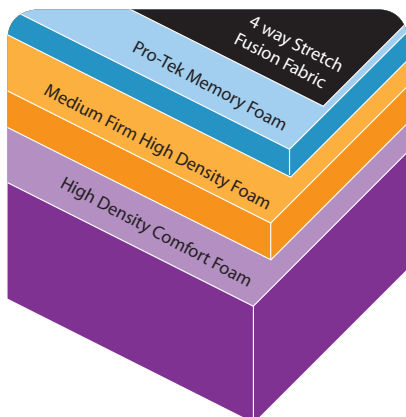

Bariatric Comfort Series cushion sets are designed with the comfort of bariatric patients in mind. Recommended for low - high risk obese patients. 4" thick overall. Constructed of high density firm foam, a layer of anti-shear Pro-Tek Memory foam covered with 4-way stretch ultra soft Fusion Fabric (vinyl).

| MAKE | MODEL | Standard Series | Comfort Plus Series | Pro-Tek Series | Integra Gel Series | Bariatric Comfort Series |
|------------------------------|--|-----------------|---------------------|----------------|--------------------|--------------------------|
| AMSCO | 2080M - 2080L - 2080RC - 1080 | SC-3220 | CPS-3220 | PC-3220 | IGC-3220 | BCS-3220 |
| | 3080RC - 3080RL - 3080SP - 3085SP | SC-3320 | CPS-3320 | PC-3320 | IGC-3320 | BCS-3320 |
| | ORTHOGRAPHIC II - (Optional Pads also available, see pg 9/10) | SC-3540 | CPS-3540 | PC-3540 | IGC-3540 | BCS-3540 |
| | ORTHOVISION - (Optional Pads also available, see pg 9/10) | SC-3545 | CPS-3545 | PC-3545 | IGC-3545 | BCS-3545 |
| MAQUET | 1130 [3-pc. set] w/ solid leg | SC-5330 | CPS-5330 | PC-5330 | IGC-5330 | BCS-5330 |
| | 1132 Alphastar | SC-5380 | CPS-5380 | PC-5380 | IGC-5380 | BCS-5380 |
| MIDMARK / CHICK | 7100 | SC-4550 | CPS-4550 | PC-4550 | IGC-4550 | BCS-4550 |
| | 7300 - (Available extensions, see pg 9/10) | SC-4560 | CPS-4560 | PC-4560 | IGC-4560 | BCS-4560 |
| | CST SE 2001 [3-pc. set] | SC-4120 | CPS-4120 | PC-4120 | IGC-4120 | BCS-4120 |
| | CST SE 2001 [6-pc. set] | SC-4121 | CPS-4121 | PC-4121 | IGC-4121 | BCS-4121 |
| | 10500 CLT Orthopedic [7-pc. set] | SC-4220 | CPS-4220 | PC-4220 | IGC-4220 | BCS-4220 |
| SHAMPAINE / AFFILIATED / MDT | 1501 - 1502 - 1503 - 1505 | SC-1320 | CPS-1320 | PC-1320 | IGC-1320 | BCS-1320 |
| | RADI-OP 1900 - 1900E - 1900RC | SC-1520 | CPS-1520 | PC-1520 | IGC-1520 | BCS-1520 |
| | RADI-OP 4900E - 4900B | SC-1620 | CPS-1620 | PC-1620 | IGC-1620 | BCS-1620 |
| SKYTRON | 5001 - 6001 - 6001K - 6001KR - 6001KRB - 6500 - 6500B - 6500HD [3-pc. set] | SC-7020 | CPS-7020 | PC-7020 | IGC-7020 | BCS-7020 |
| | ELITE 3100 | SC-7030 | CPS-7030 | PC-7030 | IGC-7030 | BCS-7030 |
| | ELITE 3501, 3501B EZ Slide | SC-7032 | CPS-7032 | PC-7032 | IGC-7032 | BCS-7032 |
| | ELITE 3500, 3500B | SC-7035 | CPS-7035 | PC-7035 | IGC-7035 | BCS-7035 |
| | 5000 - 6000 - 6000K [4-pc. set] | SC-7050 | CPS-7050 | PC-7050 | IGC-7050 | BCS-7050 |
| | 6600 | SC-7230 | CPS-7230 | PC-7230 | IGC-7230 | BCS-7230 |
| | Hercules 6700B, 6701 | SC-7280 | CPS-7280 | PC-7280 | IGC-7280 | BCS-7280 |

Replacement cushion sets available for all makes & models of Surgical tables, Orthopedic tables and other O.R. Equipment

Waterfall Edge Construction
 Fluid and Stain Resistant
 X-ray Permeable
 Anti-Microbial
 Latex Free



Pro-Tek Memory Foam



Waterfall Edge Construction

Pads & Positioners

Stretcher Pads



Stretcher & Custom Pads

Stretcher Pads, Radiology Pads and Custom application pads available

A. Standard Stretcher Pads

Medium density comfort foam
Covered in electrically conductive vinyl
Latex free, bacteria and fluid resistant
6 universal sizes in stock
Universal pads have 2 rounded / 2 angle corners

Upgrade option – request Fusion fabric to provide extra comfort for your patients

CAT# SP-5000

24" x 76" x 3" w/ universal corners

CAT# SP-5004

24" x 75" x 4" w/ universal corners

CAT# SP-5017

24" x 77" x 4" w/ universal corners

CAT# SP-5051

27" x 75" x 4" w/ universal corners

CAT# SP-5054

27" x 77" x 4" w/ universal corners

CAT# SP-5060

30" x 76" x 4" w/ universal corners

B. Pressure Management Stretcher Pads

Kova Comfort pads provide ultimate patient comfort
Medium density comfort foam with a top layer of PRO-TEK™ memory foam - 4" thick overall
Covered in 4-way stretch ultra-soft Fusion fabric, Latex free
Anti-microbial, fluid and stain resistant 6 universal sizes in stock

CAT# SPM-5000

24" x 76" x 4" w/ universal corners

CAT# SPM-5004

24" x 75" x 4" w/ universal corners

CAT# SPM-5017

24" x 77" x 4" w/ universal corners

CAT# SPM-5051

27" x 75" x 4" w/ universal corners

CAT# SPM-5054

27" x 77" x 4" w/ universal corners

CAT# SPM-5060

30" x 76" x 4" w/ universal corners

C. Radiology & Custom Application Pads

Choose from Standard Foams, Pro-Tek Memory Foam, and Gel. Also available in Kova Care protective coated construction

Choose covering material and specify all measurements, corner type, and attachment device

Simple ordering: Choose style (A - G) that most closely resembles your pad, get make and model of your unit, and call customer service (Shown on right)

Custom pads available for CT Scanners, MRI tables, X-ray tables, and more

D. Custom Stretcher Pads

Choose from Standard or Kova Comfort Pressure management style

Please specify custom measurements, corner style for each dimension shown in the diagram below.

a. _____ d. _____ g. _____
b. _____ e. _____ h. _____
c. _____ f. _____ i. _____
corner style _____

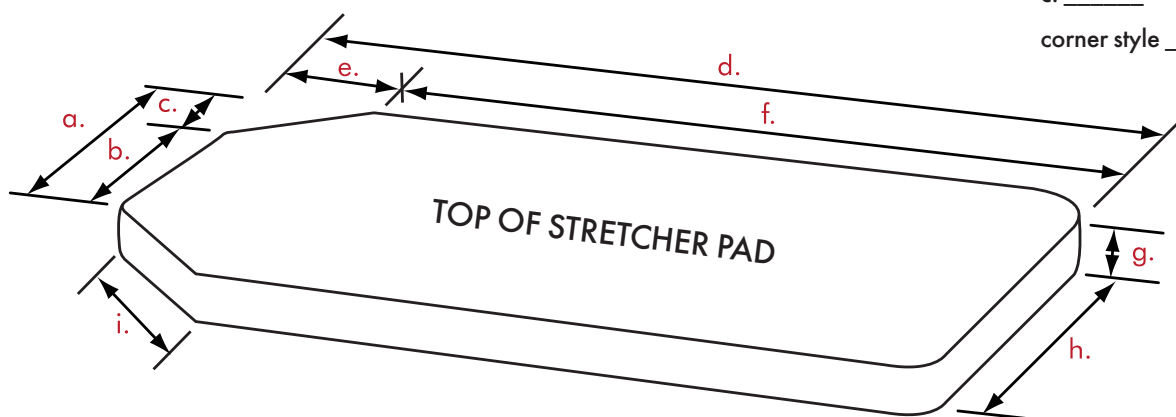

Specify measurement for each dimension shown above - a - i



Standard Stretcher Pads



Universal pads have 2 rounded / 2 angle corner

A

In Stock Items

Kava Comfort

NEW!



Pressure Management Stretcher Pads

B

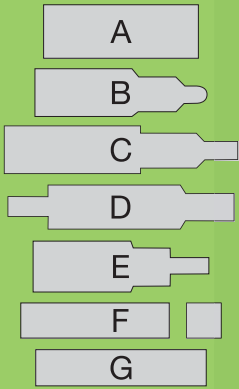

C



D



Custom fit pads for stretchers, chairs, MRI tables, and more...



Pads & Positioners

Arm Support Pads



AS-4001-2-PM

- A. Multi-Purpose Armboard Pads**
 Pressure management pads – 2” thick
 4 way stretch Fusion Fabric(vinyl)
 Flame retardant
 Anti-microbial and fluid resistant
 For multi-purpose surgical table armboards
- CAT# AS-6001-2PM**
 For 6” x 20” Multi-purpose/ Multi-task Armboard
- CAT# AS-6001-2CT Contoured**
 For 6” x 20” Multi-purpose Armboard
- CAT# AS-6091-2**
 For Amsco Multi-purpose Armboard
- CAT# GP-2160**
 For 6” x 20” Multi-purpose Armboard countered pad w/ Gel overlay
- B. Arm & Hand Table Pads**
 Pro-Tek™ or Standard Style
- CAT# HT-1201-1**
 1” Pad for HT-1200 Arm & Hand Table
- CAT# HT-1601-1**
 1” Pad for HT-1600 Arm & Hand Table
- CAT# HT-1801-1**
 1” Pad for HT-1800 Arm & Hand Table
- CAT# HT-8201-2PM**
 2” Pro-Tek Pressure Management Pad for HT-8200 Carbon Fiber Arm Table
- CAT# HT-5201-2PM**
 2” Pro-Tek Pressure Management Pad for HT-5200 ‘T’ or Winged table
- CAT# HT-6601-2PM**
 2” Pressure Management Pad for HT-6600 Rectangle table
- CAT# HT-6901-2PM**
 2” Pressure Management Pad for HT-6900 Hourglass Arm & Hand table

- C. Incline Armboard Pads**
 For all standard 26” armboards
 Flame retardant
 Anti-microbial and fluid resistant
- CAT# AS-4001-CT2**
 Incline from 2” to 6” thick
- CAT# AS-4001-CT3**
 Incline from 3” to 7” thick
- D. Vinyl Pads for Armguards**
 Memory foam pads covered with 4-way stretch Fusion Fabric
 Easily slip over armguard
 Disposable pads available *(see pg 21)*
- CAT# AS-8020**
 Vinyl Soft Pad provides patient protection and comfort
- CAT# AS-8040**
 Double-Care Pad provides protection for both patient and caregiver
 Memory foam on both sides of armguard

- E. Armboard Pads**
 (See graph below, choose from 1”, 2”, 3”, or 4” pads)
 Flame retardant
 Anti-microbial and fluid resistant
 Electrically conductive vinyl
 For 26” or 24” standard surgical table armboard
 Wide Armboards and Pediatric Armboard pads available
- F. Custom Pads**
 Custom replacement pads are available for all styles of arm supports. Specify foam style, fabric, thickness and attachment device requirements when ordering

Armboard Restraint Straps

See page 20

| Armboard Size | Pad | Standard | Pro-Tek PM | Integra Gel |
|---------------|------|-----------|----------------|-----------------|
| 6”x 24” | 1” | AS-2001-1 | n/a | n/a |
| 6”x 24” | 2” | AS-2001-2 | AS-2001-2-PM | n/a |
| 6”x 26” | 1” | AS-4001-1 | n/a | n/a |
| 6”x 26” | 2” | AS-4001-2 | AS-4001-2-PM | n/a |
| 6”x 26” | 2.5” | n/a | AS-4001-2.5-PM | AS-4001-2.5-IGC |
| 6”x 26” | 3” | AS-4001-3 | AS-4001-3-PM | AS-4001-3-IGC |
| 6”x 26” | 4” | AS-4001-4 | AS-4001-4-PM | AS-4001-4-IGC |
| 11” x 26” | 2” | AS-4111-2 | AS-4111-2-PM | n/a |
| 6” x 20” Pedi | 2” | n/a | AS-1201-2-PM | n/a |

Multi-Purpose Armboard Pads

AS-6001-2CT



AS-6001-2PM



AS-6091-2



GP-2160

A

Arm & Hand Table Pads



HT-5201-2PM



HT-6901-2PM



HT-1601-1

B

Incline Arm Board Pads



AS-4001-CT2

C

Arm Guard Pads



AS-8040

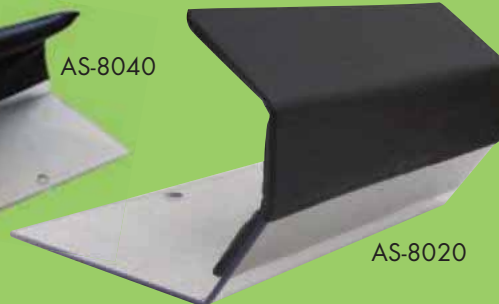

AS-8020

D

Standard Arm Board Pads



11" wide

24" or 26"

AS-4111-2PM

AS-4001-2PM

E

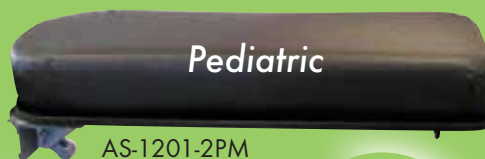

Pediatric

AS-1201-2PM

9a Stock Items

Custom Pads...



F

For replacement pads on all other makes and models of armboards call customer service

Custom shape, size, thickness, and covering material

Replacement Pads & Leg Support Pads



A. Replacement Legholder Pads

Memory foam pads covered with 4-way stretch Fusion for comfort

Regular and Clam-shell style available

Most styles listed are in stock

For all other makes and models of legholders call customer service

CAT# ALS-6020 [shown]
Altima™ Legholder Pads

CAT# ALS-6030
Altima™ Legholder Pads
- clamshell style

CAT# LS-6220
Allen black boots

CAT# LS-6230
Allen black boots - clamshell style

CAT# LS-9020 [shown]
Yellofin™ boots - clamshell style

CAT# LS-9025
Yellow Banana boot

CAT# LS-9028 [shown]
Skytron Levitator & Ankle-Lock boot

CAT# LS-9030 [shown]
Allen blue boots

CAT# LS-9035 [shown]
Steris/Amsco grey boots

CAT# LS-9040 [shown]
Allen Pal-Pro/Foot-Hugger™ style

Gel legholder pads – see pg. 17

*Disposable Legholder pads
– see pg. 21*

B. Wilson Spinal Frame Unit

CAT# SC-9010
Replacement Wilson Spinal Frame Pads - 4 PC SET (requires light assembly)

CAT# WS-9010 [shown]
Wilson Spinal Frame Unit
Remanufactured, completely reconditioned to like new standards, complete unit, includes new set of pads

C. Extension/ Transfer Board Pads

CAT# SC-4560-4
Midmark 7300 36" extension board pad

CAT# SC-4560-5 [shown]
Midmark 7300 55" extension board pad

CAT# LS-9501-2 [shown]
LS-9500 leg extension pad

For all other makes and models of patient transfer boards and I.A. Extension boards, call customer service

D. Orthopedic Traction Boots

For Orthographic I, Orthographic II, Orthovision and Orthopedic Extension

CAT# LS-9980 [shown]
Secures patient's foot with three deluxe straps. Attaches to foot plate of traction unit assembly. Made of soft vinyl with foam padding.

[Ortho boots for Shampaine, OEC, Maquet and others call for info]

E. Knee Crutch Pads

Replacement pads available for most makes and models of knee holders or knee crutches, call customer service

F. Steris/AMSCO Replacement Pads For Ortho II & Orthovision

CAT# SC-3540 [not shown]
Orthographic II
Replacement table pads [2pc set]

CAT# SC-3540-3
T-shaped Sacral Rest Pad

CAT# SC-3540-4
U-shaped Hip Rest Pad

CAT# SC-3540-5
Patient Transfer Pad

CAT# SC-3540-6
I.A. Extension Pad

CAT# SC-3540-7
Arm&Hand Rest Pad

CAT# SC-3540-8
I.A. Extension Pad, short, 4"thk

CAT# SC-3540-9
I.A. Extension frame vinyl cover

CAT# SC-3540-10
I.A. Extension w/square cut-out

CAT# SC-3545 Orthovision
Replacement table pads [2pc set]

CAT# PRT-6540
Perineal Post Pads /10 per set

Leg Holder Pads



LS-9020



LS-9030



ALS-6020



LS-9035



LS-9028



LS-9040



A

Extension/Transfer Board Pads



SC-4560-5



LS-9501-2

C

Orthopedic Traction Boots



LS-9980

D

Knee Crutch Pads



E

F Steris/AMSCO Ortho Pads



SC-3540 &
SC-3545

SC-3540-4

SC-3540-3

PRT-6540



SC-3540-6

SC-3540-7



SC-3540-9



SC-3540-5

SC-3540-8



SC-3540-10

Air Mattresses



BBM-6750AIR

A. Replacement Birthing Bed

Mattress Sets

Provides ultimate comfort for Mom
 Flame, fluid and bacteria resistant
 Soft blue Sure-Chek vinyl covering
 Dual layer foam construction
 - Bottom – Standard durable foam
 - Top – Soft convoluted foam
 5" overall thickness on most beds
 Available with or without perineal cut out

CAT# BBM-6720 [shown]

For HILL-ROM AFFINITY I & II & III w/ "V" PERINEAL CUT-OUT; this set has original style tabs and snaps for attachment same as OEM

CAT# BBM-6750 [shown]

For HILL-ROM AFFINITY I & II & III w/ "V" PERINEAL CUT-OUT; this set has velcro attachment devices instead of snaps

CAT# BBM-6760

For HILL-ROM AFFINITY w/ "U" PERINEAL CUT-OUT; this set has velcro attachment devices instead of snaps

CAT# BBM-4750

STRYKER ADEL LD-500 w/ PERINEAL CUT-OUT

CAT# BBM-4757

STRYKER ADEL LD-500 w/ NO PERINEAL CUT-OUT

CAT# BBM-4920 [shown]

STRYKER 5010 Birthing Bed

Sets for all makes and models of birthing beds. Call for catalog number of mattress set that is designed for the make and model of your bed

B. Birthing Bed Calf Support Pads

CAT# PRT-6710

Replacement pads fit Hill-Rom™ Affinity Calf Supports, pair



B

C. Hill-Rom™ Affinity Air Mattresses

CAT# BBM-6750Air [shown]

Replacement Air Mattresses for Hill-Rom Affinity beds, body section 5" thick, Foot section 3" thick

D. Bassinet Pads, Infant Warmer pads

Replacement pads available for any make or models of Bassinets or Infant Warming Units

Ultra foam covered with Sure-Chek vinyl, standard thickness 1" or 2"
 Custom sizing and thickness available
 Anti-microbial, fluid and stain resistant
 Infant Warming Unit pads are available with or without board insert

Bassinet Pads

CAT# BP-1000

24" x 12" x 1" thick, Lt. Blue

CAT# BP-1300

26" x 12.5" x 1" thick, Lt. Blue

CAT# BP-2000

24" x 12" x 2" thick, Lt. Blue

CAT# BP-2300

26" x 12.5" x 2" thick, Lt. Blue

Infant Warming Unit pads

CAT# WP-4400

Warmer Pad with board insert

CAT# WP-4500

Warmer Pad without board insert

E. Replacement Sheet Sets

Replacement Sheet Sets available for most makes of birthing beds, call for information

CAT# BBS-1528 [shown]

For Hillrom Affinity I, II, and III with V cut out. Latex free, cotton fitted sheets

F. Comfi-topper™

2" thick high density convoluted foam, covered with soft staph-chek vinyl, designed to provide ultimate postnatal comfort for Mom

Eliminates uncomfortable gaps and ridges caused by perineal cutouts and hinges on LDR mattresses

CAT# CTP-150

For beds 30.5" - 32" W x 74" - 76" Lg

CAT# CTP-250

For beds 32.5" - 34" W x 74" - 76" Lg

CAT# CTP-350

For beds 34" - 36" W x 76" - 80" Lg

CAT# CTP-450

For ADEL LD-500 BBM sets 31.5" tapered to 33.5" W x 75" Lg

CAT# CTP-750 [shown]

For HILL-ROM AFFINITY I, II & III SETS 34" W x 77" L with rounded foot end

Comftoppers™ available for all birthing beds. Call for catalog number of Comftopper™ that is designed for the make and model of your bed.

G. CRIB MATTRESS

CAT# CM-0500

Crib Mattress for PTS-5000 or Midmark 500 Cribs – 4" thick, rounded corners



CM-0500

Replacement Birthing Bed Mattresses



Stryker 5010

BBM-4920



BBM-6720

Affinity II

Affinity III
BBM-6750

*Satisfaction
Guaranteed*

A

D

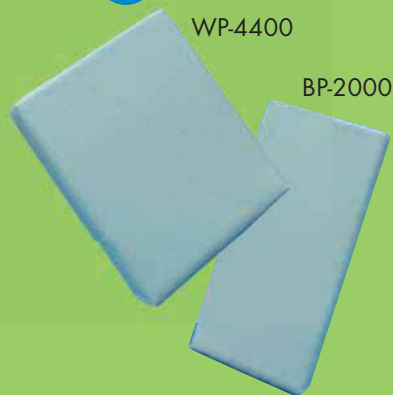

WP-4400

BP-2000

*In Stock or Custom
Replacement pads
available for all your
Labor & Delivery
requirements...*



BBS-1528

E



CTP-750

F



G



CM-0500

Provides Ultimate Comfort for MOM!

Pads & Positioners

KOVA Care Positioners & Pads

Armboard Pads

CAT# KC-4001-2PM *[shown]*

6" x 26" x 2" thick Ultimate Pressure Management comfort for all standard armboards



KC-4001-2PM

KOVA Care Positioners & Pads Multiple Sizes & Styles

Fluid-proof durable Kova-Care™ coating
Great for patient positioning
Re-usable; Premium quality
Comfortable medium firm support
No seams, wrinkles, zippers
Disinfectable; Latex free

A. Head Donuts / Disks

CAT# KC-6120 *[shown]*

Small Donut 6" Dia x 1.5" H (3/pk)

CAT# KC-6140 *[shown]*

Large Donut 9" Dia x 1.5" H (3/pk)

CAT# KC-6220

Disc 6" Dia x 1.5" H (3/pk)

B. Positioning Rolls

CAT# KC-6230

Small Roll 6" Dia x 12" L

CAT# KC-6235

Medium Roll 6" Dia x 18" L

CAT# KC-6240

Large Roll 6" Dia x 23.5" L

CAT# KC-6250 *[shown]*

X-Large Roll 8" Dia x 23.5" L

CAT# KC-6320 *[shown]*

Semi-Circle 14" L x 8.5" W x 4.25" H

C. Positioning Rectangles

CAT# KC-6460

Rectangle-Sm 9" x 7" x 2"H

CAT# KC-6470 *[shown]*

Rectangle-Lg 14" x 9.25" x 2"H

D. Surgical Table Pads

Constructed of high density base foam covered with a layer of viscoelastic memory foam; Coated with Kova-Care™ protective coating; fluid proof; seamless; Available for most Surgical tables

Kova-Care™ Surgical Table Pad Sets

2" thick overall; Ultimate Pressure Management Comfort

Kova-Care™ Bariatric Surgical

Table Pad Sets

4" thick overall; Recommended for high risk or obese patients. Specify make & model of surgical table when ordering. Order by surgical table make & model.

Popular Sets

E. Super Positioner Set

CAT# KC-9000 *[shown]*

11 pc set includes:

15°, 20°, 35/55° 'A', 45° 'D' wedges; 1-sm, 1-lg rectangle; 1-disc; 1-semi circle; 1-large roll; 1-sm, 1-lg donut

Radiology Set

CAT# KC-7000 6pc set includes:

15°, 20°, 35/55°, 45° 'D' wedges; head rest and finger block oblique

Small Positioner Set

CAT# KC-8000 7 pc set

Includes: 2- 45° ('A' & 'C') 2- 20° wedges; 1- 6" Disc, 2 Sm rectangles

F. Positioning Wedges

CAT# KC-6615 *[shown]*

15° Wedge 10.5" L x 9.75" W x 2.75" H

CAT# KC-6620

20° Wedge 11" L x 8.5" W x 3.75" H

CAT# KC-6635A *[shown]*

35/55° Wedge 24" L x 10" W x 6.5" H

CAT# KC-6635B *[shown]*

35/55° Wedge 24" L x 15" W x 10" H

CAT# KC-6645A

45° Wedge 7" L x 4" W x 4" H

CAT# KC-6645B

45° Wedge 10" L x 10" W x 10" H

CAT# KC-6645C

45° Wedge 12" L x 6.75" W x 6.75" H

CAT# KC-6645D

45° Wedge 23.5" L x 6.75" W x 6.75" H

G. Specialty Positioners

CAT# KC-6910 *[shown]*

Head Rest 10.75" L x 7" W x 6" H

CAT# KC-6920 *[shown]*

Finger Block Oblique

CAT# KC-6930 *[shown]*

Cross Leg Block 16" L x 14" W x 10" H

CAT# KC-6935 *[shown]*

Leg Immobilizer 16" L x 14" W x 6" H

H. KOVA Lite™ Positioners

CAT# PP-8200

Kova Lite Responsible head Donuts, 3/pkg, molded

CAT# PP-8400

Kova Lite Responsible Prone Headrest Positioner, 3/pkg, molded

Available in multiple sizes and shapes

Easy to clean, non-skid coating

MRI compatible

Water Proof

A



KC-6120

KC-6140

E



KC-9000

B



KC-6250

KC-6320

F

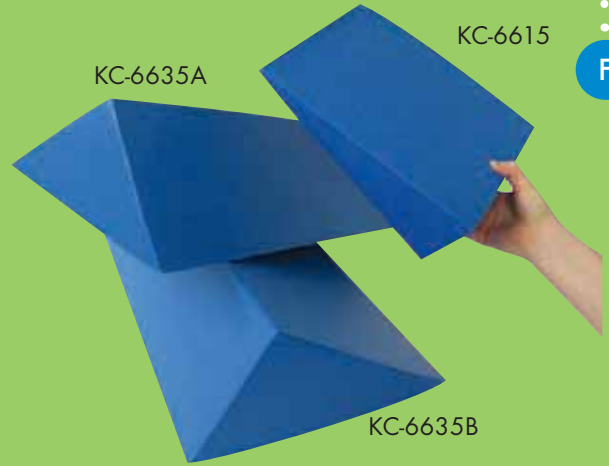

KC-6635A

KC-6615

KC-6635B

C



KC-6470

G

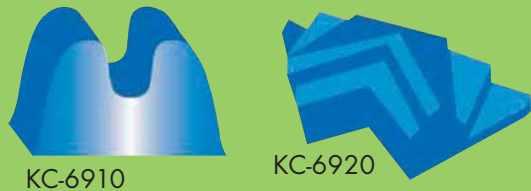

KC-6910

KC-6920

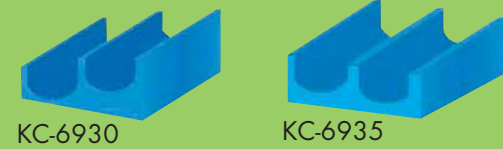

KC-6930

KC-6935

D



KCB-7020

H



Pads & Positioners

Vinyl, Foam & Specialty Positioners

Available in multiple sizes and shapes

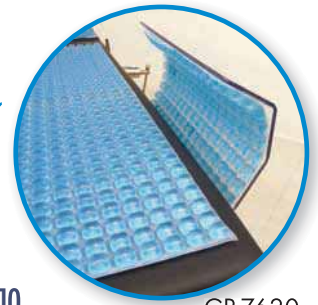

GP-7620

Foam Patient Positioners

Multiple Sizes & Styles
Standard firm foam
Covered with black vinyl
Many styles in stock
Custom positioners available upon request

A. Well-Leg Pad

CAT# PP-2250

Arthroscopic well-leg support pad

B. Arm/Leg Prepper

CAT# PP-2850

PP-2850 Arm/Leg Prepper Positioner

C. Surgery Rolls

CAT# PP-5250

Surgery Roll - Small (6" x 10")

CAT# PP-5255

Surgery Roll - Long (6" x 20")

CAT# PP-5260

Half Roll - (6" x 16")

D. Knee Bolster

CAT# PP-2750

Knee Bolster Pad
(12" w x 7 1/4" h x 21" L)

CAT# PP-2755

Knee Bolster Pad
(12" w x 10" h x 21" L)

E. Head Donuts

CAT# PP-5210

Head Donut-Small
(5.5" od x 2" id x 2" t)

CAT# PP-5215

Head Donut-Med
(7" od x 3" id x 1.5" t)

CAT# PP-5220

Head Donut-Large
(9" od x 4" id x 2" t)

CAT# PP-5225

Head Donut-XLarge
(10" od x 6" id x 2" t)

CAT# PP-5229

Head Donut - Custom Sizing

F. Frogger—Vein Harvesting Positioner

CAT# PP-2950

Frogger Pad w/o mounting strap

CAT# PP-2955

Frogger Pad with 60" mounting strap

G. Misc. Foam Positioners

For Pillows, 1/2 Rolls, Wedges, and Custom

Call Customer Service for Catalog Number and Pricing

H. Gel CUBZ Positioners

CUBZ Gel Pads

CAT# GP-7400

Cubz Table Pad 20" x 20"

CAT# GP-7500

Cubz Table Pad 20" x 46"

CAT# GP-7610

Cubz Head Table pad 9" x 16"

CAT# GP-7620

Cubz Armguard pad 9" x 16"

CAT# GP-7630

Cubz Knee Crutch pad 9" x 16"

CAT# GP-7700

Cubz Surg table body section 18" x 36"

CAT# GP-7800

Cubz Chair - multiuses 16" x 16"

CAT# GP-7850

Cubz Chair - multiuses 16" x 18"

CAT# GP-7900

Cubz Chair - multiuses 18" x 18"

CAT# GP-7950

Cubz Chair - multiuses 20" x 18"

I. Air/Misc. Gel Positioners

CAT# GP-8200

Air/Gel Seat Pad 18" x 18"

CAT# GP-6200

Lateral Shoulder/
Arm Positioner
(.5" - 6.3" h x 28" l x 20" w)

CAT# GP-2700

Oval Ulnar Nerve
Protector
w/velcro

CAT# GP-2920

Heel Protector cups - 2 pc - 3/8" gel covered w/ fabric 7" x 9" w/ strap

CAT# GP-2165

Contoured Arm board Foam Pad w/
Gel Cover (6" x 25" x 2")

CAT# GP-5200

2pc. Gel Restraint Strap w/Gel Pad - 14" x 2.75" x 5/8" on 26" lg secured nylon strap for wrist or ankles

CAT# GP-5350

Patient Restraint Strap w/Gel Pad - 3.5" x 20" x 3/8" gel w/ 2" x 114" strap



GP-2700



GP-2165



GP-5350

In Stock Items



PP-2250

A



PP-2850

B



PP-5250



C

PP-5255

PP-5260

D



PP-2750

PP-5220



PP-5215

PP-5210

E

Custom Wedges, Half Rolls, Disks, Pillows....



F



PP-2955

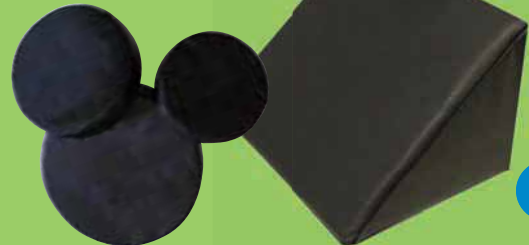

G

I

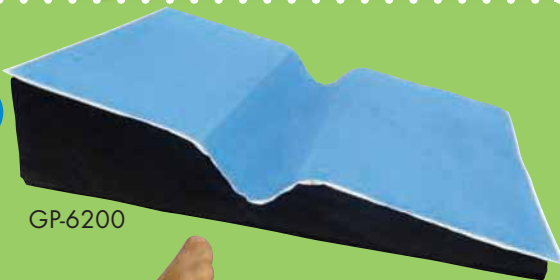

GP-6200

*New!
Air Gel*

GP-8200



GP-2920



GP-5200



Specialty Positioners

Pads & Positioners



Gel Patient Positioners

Multiple Sizes & Styles available; High quality viscoelastic polymer gel Provides Anti-shear protection and ultimate comfort in patient positioning

A. Head Donuts/Pads

- CAT# GP-1500**
Adult (8" Dia.)
- CAT# GP-1580**
X Large 8" dia. x 3"
- CAT# GP-1600**
Child (6" Dia.)
- CAT# GP-1650**
Infant (3-1/4" Dia.)
- CAT# GP-1700**
Adult Horseshoe (8" Dia.)
- CAT# GP-1750**
Child Horseshoe (6" Dia.)
- CAT# GP-1760**
Infant horseshoe 3.5" dia.
- CAT# GP-1780**
X large horseshoe 8" dia. x 3"



B. Head & Foot Pads

- CAT# GP-1800**
Head pillow w/ centering dish (9" x 10" x 1")
- CAT# GP-1850**
Head pillow w/ centering dish (9" x 10" x 2")
- CAT# GP-1900**
Contoured headrest 7.5" x 7.5" x 2.5"thk
- CAT# GP-1950**
Head pad w/ centering dish 9" x 11" x 3"
- CAT# GP-2200**
Anesthesia Prone Headrest w/tube channels
- CAT# GP-2250**
Anesthesia Prone headrest w/ tube channels 9"x7.5"x5"
- CAT# GP-2800**
2pc Contoured Ankle gel pads 4" x 7.5" x 3"h
- CAT# GP-2850**
2pc Heel gel pads - 3" x 6" x 2.25"h w/ molded heel cup indents



GP-1900

C. Arm Support Pads

- CAT# GP-2300**
Armboard Pad (6" x 15")
- CAT# GP-2350**
Armboard Pad (6" x 26")
- CAT# GP-2400**
Armboard Pad (4.5" x 24")
- CAT# GP-2120**
Armguard Pad (11" x 17")
- CAT# GP-2600**
Elbow Nerve Protector w/ velcro

D. Leg Support Pads

- CAT# GP-3020**
Knee crutch pad (9" x 12")
- CAT# GP-3120**
Knee crutch pad (10" x 16")
- CAT# GP-3200**
Knee Crutch Pad (20" x 20")
- CAT# GP-3250**
Universal Stirrup Boot Pad (Pair)
- CAT# GP-3300**
Candy Cane Stirrup Post Pad (Pair)
- CAT# GP-3350**
Candy Cane Ankle Straps (Pair)



GP-3350

E. Multi-purpose Positioner

- CAT# GP-3500**
(6.5" x 3" x 1.75")
- CAT# GP-3520**
(13" x 3" x 2")
- CAT# GP-3600**
(10" x 5" x 2")
- CAT# GP-3700**
(15" x 5" x 2")
- CAT# GP-3750**
(21" x 5" x 2")

F. Flat Bottom Chest Roll

- CAT# GP-4400**
(12" x 7" x 6")
- CAT# GP-4420**
(4" x 12" x 4")
- CAT# GP-4460**
(4" x 16" x 4")
- CAT# GP-4500**
(16" x 7" x 6")
- CAT# GP-4600**
(21" x 7" x 6")
- CAT# GP-4620**
(6" x 12" x 4")
- CAT# GP-4660**
(6" x 16" x 4")
- CAT# GP-4680**
(6" x 20" x 4")
- CAT# GP-4800**
(3" x 6" x 3")
- CAT# GP-4900**
(6" x 2" x 2")
- CAT# GP-4920**
(2" x 10" x 2")

G. Surgical Table Pads

- CAT# GP-1000**
3/4 Length Table Pad (20" x 46")
- CAT# GP-1100**
Full Length Table Pad (20" x 72")
- CAT# GP-1300**
3pc. Gel Surgical Table Set
- CAT# GP-1400**
Table / Hip Pad (20" x 20")

H. Specialty Pads

- CAT# GP-6100**
Fracture Table Hip Pad w/ 1 3/4" hole to accommodate perineal post
- CAT# GP-6150**
Fracture Table Post Pad (8.25" x 7" x 1/2")
- CAT# GP-6300**
Bassinet Gel Pad Overlay (12" x 26")
- CAT# GP-6500**
Wilson Frame Pad set w/Velcro 2pc
- CAT# GP-7400**
Chair Pad - large (20" x 20")



A



B

C



GP-2325

GP-2350

D



GP-3020

GP-3250

GP-3300

GP-3350

E

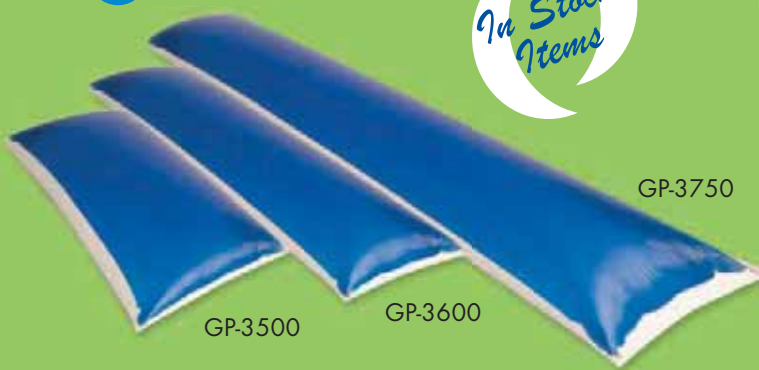

In Stock Items

GP-3750

GP-3500

GP-3600

F



GP-4920

GP-4800

G



GP-1300

H



GP-6500

Available in multiple sizes and shapes

Pads & Positioners

Restraint Straps & Positioners



Bean Bag Patient Positioners

Bean bag positioner with replaceable button release valve, durable stain resistant vinyl. Quick and easy hook up to a suction line to evacuate air and form positioner to desired shape. Open valve for positioner to return to relaxed state.

Bean Bags

CAT# VP-8010
20" x 10" Positioner

CAT# VP-8020
20" x 20" Positioner

CAT# VP-8030
40" x 30" Positioner w/Shoulder cut-out

CAT# VP-8030G
40" x 30" Positioner w/Shoulder cut-out and Integra Gel layer

CAT# VP-8046
46" x 46" Bariatric Positioner w/Shoulder cut-out

CAT# VP-8076
30" x 76" Full length Positioner

Ultralite Bag Positioners

1/3 the weight of heavy sand
Re-usable
Covered with black vinyl
Great for patient positioning
Steady & firm support
Available with or without grommets

CAT# SB-2002
2lb. 8" x 11" Positioner

CAT# SB-2003
3lb. 9" x 13" Positioner

CAT# SB-2005
5lb. 10" x 15" Positioner

CAT# SB-2007
7lb. 11" x 16" Positioner

CAT# SB-2010
10lb. 12" x 19" Positioner

CAT# SB-2202
2lb. 8" x 11" Positioner W/Grommets

CAT# SB-2203
3lb. 9" x 13" Positioner W/Grommets

CAT# SB-2205
5lb. 10" x 15" Positioner W/Grommets

CAT# SB-2207
7lb. 11" x 16" Positioner W/Grommets

CAT# SB-2210
10lb. 12" x 19" Positioner W/Grommets

Heavy Fill Sand Bag Positioners

Re-usable
Covered with black vinyl
Great for patient positioning
Steady & firm support
Available with or without grommets
Custom weights & sizes available upon request

CAT# SB-1002
2lb. 6.5" x 8" Positioner

CAT# SB-1003
3lb. 6.5" x 8" Positioner

CAT# SB-1005
5lb. 8" x 10" Positioner

CAT# SB-1007
7lb. 8" x 10" Positioner

CAT# SB-1010
10lb. 13" x 10.5" Positioner

CAT# SB-1202
2lb. 6.5" x 8" Positioner W/Grommets

CAT# SB-1203
3lb. 6.5" x 8" Positioner W/Grommets

CAT# SB-1205
5lb. 8" x 10" Positioner W/Grommets

CAT# SB-1207
7lb. 8" x 10" Positioner W/Grommets

CAT# SB-1210
10lb. 13" x 10.5" Positioner W/Grommets

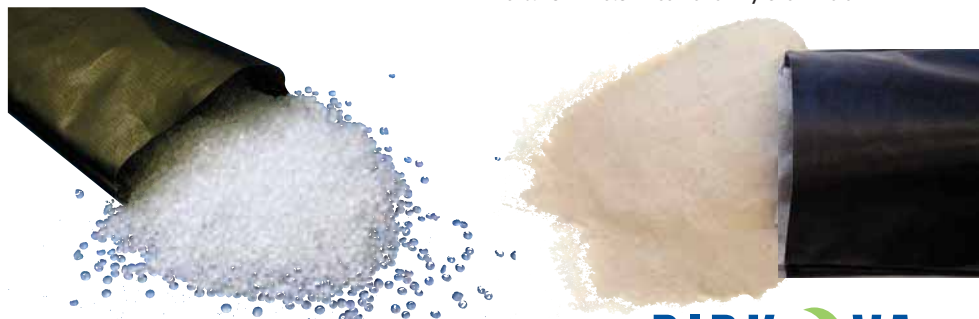

Surgical Table Restraints

Restraint straps are available in many styles for use on Surgical and other procedure tables

A. Rubber Restraint Straps

Synthetic rubber; Latex free
Provides secure restraint
Durable; easy to clean
2" strap with 2 airplane buckles
5" x 20" center panel for patient comfort
Mounting hooks are optional
Straps secure to siderails with or without mounting hooks

CAT# PR-3200 [shown]

Overall length 96",
secures to 56"

CAT# PR-3300

X-tra long, overall 124",
secures to 84"

B. Restraint Strap Mounting Hooks

2 styles to choose from; sold in pairs
Attach to any N. American Surgical table siderail

CAT# PR-0050 [shown]

Stainless steel hooks, secure onto siderail

CAT# PR-0055 [shown]

Stainless steel flat hook clips, clip on siderail

C. Deluxe Restraint Straps

4" wide surgical table restraint straps
2 pc Vinyl / Velcro strap; Reusable
No hooks necessary
Straps secure directly to siderails

CAT# PR-3400 [shown]

CAT# PR-3800 X-tra long

D. Continuous Wrap Restraints

4" wide Vinyl w/ Velcro closures, 1 pc
Continuous wrap restraint straps wrap completely around table and secure back on themselves
Ideal for Surgical tables, Pain Mngmt tables, IA tables & Treatment tables

CAT# PR-3920 [shown]

80" lg, overall

CAT# PR-3950

92" lg, overall

CAT# PR-3980

120" lg, overall



E. Economy Armboard Restraint Strap

CAT# PR-4200 [shown]

6 straps per set; 26" lg x 2" wide;
1 pc. Velcro strap w/ buckle
Loops around armboard to comfortably secure patient's arm to armboard

F. Alero Armboard Restraint Strap

CAT# PR-4000 [shown]

2 part strap w/ double Velcro closures
Upper strap 26" long x 2" wide
Lower strap secures around 6" board
Upper strap secures patient's arm to board

G. Stretcher Patient Safety Straps

CAT# PR-9000 [shown]

3" wide dura-cloth straps with metal mounting rings and Velcro closure.
Three 2-pc straps per set
Straps secure to side of stretcher



H. Velcro

2" wide, black
Available by 25 yd roll or cut lengths
Pressure sensitive, adhesive backed



PR-3200
w/ PR-0050



A



PR-0050



PR-0055

B

PR-3400



C

PR-4200



E

Strap
PR-4000



F



Armboard Pad
AS-4001-2
(see page 7)

Disposables & X-Ray Protection

Drapes?
Ask for details

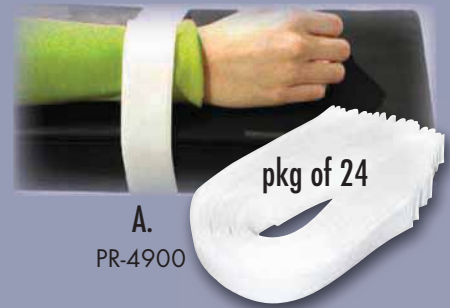

A.
PR-4900

Disposables

A. Armboard Restraint Strap

CAT# PR-4900

Includes 24 straps; 26" long x 2" wide
1 pc. disposable Velcro strap
Loops around armboard to comfortably secure patient's arm

B. Armboard Pads

CAT# AS-4070

Includes 10 per case
Comfortable foam pads
Fit all 6" x 26" armboards

C. Armguard Pads

CAT# AS-8070

Includes 20 pc per case; 8" x 16"
Comfortable convoluted foam

D. Legholder Pads & Straps

CAT# ALS-6070

Includes 10 pairs per case
Disposable convoluted foam pads
Fits Altima & Allen legholders

CAT# ALS-6090

Includes 6 straps per set
Fit Altima & Allen legholders

E. Kross Kloth

CAT# AS-7520

Comes in roll, cut to length desired
Fits onto Kross Arm Support arm cradle
Black, 6" wide cotton knit sleeve material

F. Arthro Legholder Pads

CAT# LS-1420

Reusable pads, but economical enough for disposable needs
Includes 10 pads per case
2-ply shaped foam pads

G. IV Pole Trays

CAT# IVP-8915

Triangle Utility Trays
Durable plastic, 4 per package
Fits any IV Pole w/ Support Wheel

H. Drainage Bags

Fits Drainage Bag System (DB-1000)

CAT# DB-1050

20 bags per case
Sterile, individually packaged

CAT# DB-1070

20 bags per case
Non-sterile, individually packaged

I. Quik-Strap™

Quik-Strap™ is the ultimate strap for any patient restraint needs. With loop Velcro on one side and hook Velcro on the other: this unique material allows you to create any length of strap. Just roll out and cut with scissors.

CAT# PR-8000

Blue-25 yd. roll; 1 1/2" Wide

CAT# PR-8200

White-25 yd. roll; 1 1/2" Wide

CAT# PR-8500

Blue-25 yd. roll; 2" Wide

CAT# PR-8700

White-25 yd. roll; 2" Wide



PR-8500



ALS-6070
C.



AS-8070
B.

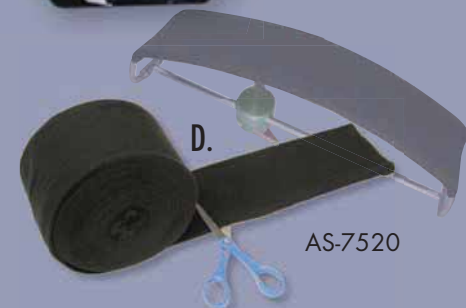

D.
AS-7520



E.
LS-1420

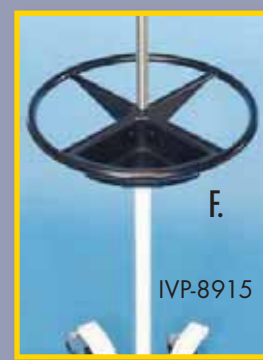

IVP-8915
F.



G.
DB-1070



APR-7000



APR-1000



APR-2000



APR-0660

APR-0640



APR-0100

APR-0190

X-RAY PROTECTION APRONS

Aprons are available in many styles, on ordering choose size 'small to X-large', protective lead content of .3mm to .5mm as well as lite-ply, choose from 24 different colors/prints of vinyl/fabric covering.

CAT# APR-1000

Three Quarter Wrap Apron

CAT# APR-2000

Frontal Apron w/ tie straps

CAT# APR-3000

Adjust-a-Fit Apron

CAT# APR-4000

Standard Coat Apron

CAT# APR-5000

Surgical Drop Away Apron

CAT# APR-6000

Flex Back Apron w/ elastic back

CAT# APR-7000

Wrap Around Apron – full protection

CAT# APR-8000

Half Apron - front or back protection

DENTAL APRONS

CAT# APR-9000

Kling-Kuver style

CAT# APR-9200

Panoramic Poncho

CAT# APR-9400

EZ Patient Apron, no-slip back, no fasteners required for fast easy use

CAT# APR-9600

Dental Thyroid Protection Collar

CAT# APR-9800

Panoramic Cape

CAT# APR-0220

Dental Apron hanger, 20"wide, powder coat finish



APR-0220

APR-9400



X-RAY EQUIPMENT & SUPPLY

CAT# APR-0100

Valet Rack, 36.5" w x 53" h, 300# capacity, includes 10 hangers

CAT# APR-0120

Heavy Duty Chrome Hanger, 3/16" steel, 50# capacity

CAT# APR-0150

Mobile Swing Arm Rack, 36" w x 53" h, holds 10 aprons

CAT# APR-0190

Porta-Rack, holds up to 8 aprons, 5 leg base, 50" h

CAT# APR-0400

Adjustable Mobile Shield, adjusts from 24" – 48" h, .5mm Pb equiv lead, vinyl coated

CAT# APR-0440

Clear Pb Acrylic Mobile Barrier, available with 24" or 60" high clear lead acrylic window, 30" w x 75" h

CAT# APR-0620

Non-Graduated Porta Shield, 7 leaf shield, 26" w, adjusts from 40" – 60" h, .5mm Pb

CAT# APR-0640

Porta-Shield, 5 leg mobile base, 3 shield sizes available, adjusts from 36" – 60" h, .5mm Pb

CAT# APR-0660

Graduated Porta Shield, 7 leaf shield graduating from 16" to 28" long strips, 26" w, height adj from 40" – 60" h, .5mm Pb

CAT# APR-0250

Wall Mount Swing Arm Rack, 5 individual chrome swing arms. Right or Left swing avail.



APR-0250(L&R)

CAT# APR-0820

Lead Vinyl Gloves, 15" L one-piece dip molded glove w/ supple vinyl cover, foam liner, pairs only, 5 colors, .5mm Pb



APR-0820

CAT# APR-0840

Lead Leather Gloves, 15" L one-piece dip-molded lead glove, durable goat skin leather cover, foam liner, 2 colors, .5mm Pb

CAT# APR-0260

Multi-Apron Glove Rack, 19" wide, powder coated finish

CAT# APR-0280

Apron & Glove Combo Rack, holds one set, 25" wide, powder coated finish

CAT# APR-0480

Mobile Screens, available w/ several options and sizes

CAT# APR-0240-A

Peg Rack, holds 1-4 aprons, 24" wide

CAT# APR-0240-B

Peg Rack, holds 1 aprons, 5" wide

CAT# APR-0980

Lead 48" x 96" vinyl Sheeting, beige, .5mm Pb



APR-4000

APR-0400

X-Ray Protection

Siderail Clamps & Table Extenders



A LS-9500

A. Leg/Foot Extension CAT# LS-9500

Stainless steel and phenolic construction

Adds ten inches to length of O.R. table

Doubles as a foot support in vertical position

Comes with 2" pad and mounting clamps

Quick and easy to setup

This extension is designed for most surgical tables

– Specify make and model of surgical table when ordering



LS-9500

B. Stainless Steel Straight Bar Accessory Clamp CAT# CL-1000

Solid stainless steel construction

Accommodates all rectangle bar accessories up to 1/4" x 1"

Easily attaches to siderails of all North American surgical tables

For safe, secure positioning of straight bar accessories

C. Clamp-Tite™ Stainless Steel Clark Socket CAT# CL-8000-SS

Design ensures ultimate clamping ability for all surgical table accessory positioning needs

Accommodates all accessories up to 3/4" Dia.

Attaches to siderails of all North American surgical tables

Allows secure positioning of surgical table accessories

D. Stainless Steel Round Bar Accessory Clamp CAT# CL-2000

Solid stainless steel construction

Accommodates all round bar accessories 1/4" up to 3/4" Dia.

Easily attaches to siderails of all North American surgical tables

For safe, secure positioning of round bar accessories

E. Super Clamp Multi-Positioner CAT# CL-7500

Solid stainless steel construction

Effortlessly secures most all accessories to siderail of any North American surgical table; Both round bars up to 3/4" Dia. as well as straight bars up to 1/4" x 1"

Also accommodates square bar accessories up to 3/4" square

Optional: Super Clamp to accommodate European siderails available - order #CL-7500-E

F. Standard Clark Socket CAT# CL-8100

Standard Style Clark Socket
Solid Stainless Steel Construction
Accommodates round bar accessories up to 3/4" diameter
Attaches to all North American surgical table side rails

G. Siderail Extender CAT# EX-1000

Extends the siderail of surgical tables by 8" to accommodate more mounting accessories

Provides for greater patient positioning flexibility

Solid Stainless Steel

Doubles as a straight bar clamp, accommodating all straight bar accessories up to 1" x 1/4"

Attaches to all North American surgical table siderails

Sold in pairs

H. Table Width Extender CAT# EX-2200

Surgical table side/width extension

Easily mounts to existing table siderail

Extends table surface 4" x 20"

18" Accessory Siderail

Comes w/ 2" pad



B

CL-1000



F

CL-8100



C

CL-8000-SS

NEW!
Clamp-Tite™
Design



G

EX-1000



D

CL-2000



H

EX-2200

**MOST VERSATILE
POSITIONER
AVAILABLE**



E

CL-7500



Round bar



Square bar



Flat bar

Surgical Accessories

Arm Supports



Arm supports for any procedure... Choose your style!

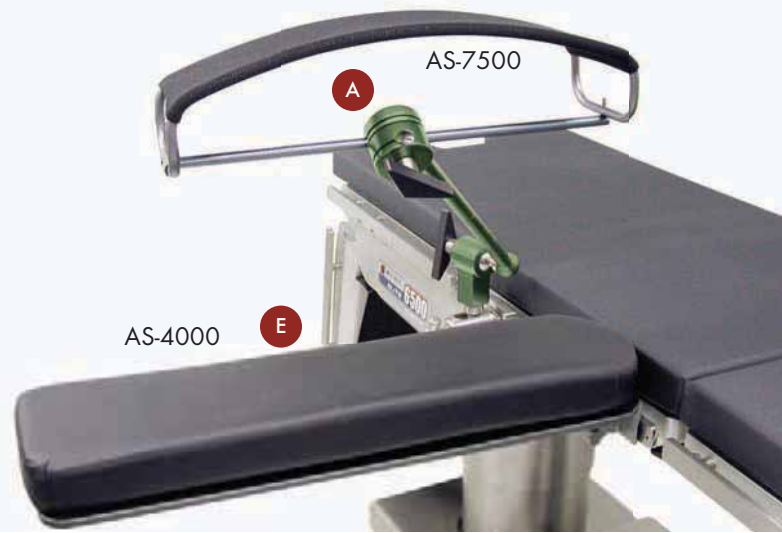

A. Kross Arm Support

CAT# AS-7500

Perfect for arm chair, prone, lateral and neuro procedure positioning
SS arm cradle measures 6" x 20"
Disposable Kross Kloth sleeve makes this a sanitary choice, one roll included
Requires one clark socket for mounting
(Kross Cloth available, See pg 21)

B. Multi-Position Armboard

CAT# AS-6000

6"W x 20"L Phenolic operating surface
Permits complete range of positioning
Stainless steel support bar
Comes w/ 2" Pressure Management pad
Provides arm support for Lateral, Prone, Neuro, Chair and Park Bench positioning
Requires clark socket or super clamp for mounting to siderail of surgical table
For contoured armboard pad - see pg 8

C. Shoulder Mount Armboard

CAT# AS-4970

100% Radiolucent Carbon Fiber
6" x 26" X-ray translucent surface
Slides under table top cushion
No mounting device, no metal parts
Non-locking swivel gear allows for quick and easy 180° positioning
Comes w/ 2" Pressure Management pad

D. Surgical Table Armguard

CAT# AS-8000

X-Ray translucent
8" High x 16" Long
Protects patient extremities
Easily slips under table cushion
Prevents nerve damage to patients
Armguard Pads available - see pg 7, 21

E. Standard Armboards

Phenolic operating surface
Rotates 180°, one-finger operation
Standard 24" or 26" length
Easy to attach to all North American surgical tables
Pressure Management and standard pads available in 1", 2", 3", or 4"
(See pg 7)

CAT# AS-2001

6" x 24" Standard Armboard w/o pad

CAT# AS-4001

6" x 26" Standard Armboard w/o pad

Standard Armboard and Pad Sets

CAT# AS-2000

24" Standard Armboard with 2" pad

CAT# AS-4000

26" Standard Armboard with 2" pad

CAT# AS-4000-1

26" Standard Armboard with 1" pad

CAT# AS-4000-3

26" Standard Armboard with 3" pad

CAT# AS-4000-4

26" Standard Armboard with 4" pad

F. Duralux™ Armboard

CAT# AS-4501

NEW Duralux™ operating surface
Standard 26" length
Rotates 180°; 21 locking increments
Easy to attach to all North American surgical tables
Board and pad combination available
Pressure Management and standard pads available in 1", 2", 3", or 4"
(See pg 7)

G. Quick Release Armboard

CAT# AS-4950

100% Radiolucent Carbon Fiber
6" x 26" X-ray translucent surface
Quick release mounting device
Non-locking swivel gear allows for quick and easy 180° positioning
Comes w/ 2" Pressure Management pad
Mounts to any N. American surgical table siderail

H. Wide Armboard

CAT# AS-4110

11" x 26" phenolic operating surface
Easy one-finger positioning, in 21 locking increments
Wide surface provides for ultimate patient comfort
Comes w/ 2" Pressure Management pad
Mounts to any N. American surgical table siderail

I. Clamping Armboard

CAT# AS-4051

Allows for secure positioning on siderail during procedures requiring the table back to be raised w/ a spring loaded rail-lock clamping mechanism
6" x 26" Phenolic operating surface
Rotates 180°; 21 locking increments
Pads available in 1", 2", 3", or 4"
(See pg 7)

J. Pediatric Armboard

CAT# AS-1200

6" x 20" Phenolic operating surface
Provides close efficient access for staff when working with small patients
Comes with 2" thick pad
Rotates 180°; 21 locking increments
Effortlessly mounts to siderail of any N. American surgical table



AS-7500

A



AS-6000

AS-6000-CT

B



100% Radiolucent

AS-4970

C



AS-8000

D



AS-4001

E



AS-1200

J



AS-4501

F

I



AS-4051

H



100% Radiolucent

AS-4950



AS-4110

Surgical Accessories

Arm & Hand Supports



HT-1600
(Shown with Pad)

Arm & Hand Tables

A. DURACLEAR™ Operating Surface

Provides excellent X-ray clarity and C-Arm visualization
3 sizes available (see below)
Supplied with 1" standard pad
Requires 2 clark sockets or round bar clamps for mounting to siderails of all North American surgical tables

CAT# HT-1200 [not shown]

12"x30" Duraclear™ Table w/ Pad

CAT# HT-1600

16"x30" Duraclear™ Table w/ Pad

CAT# HT-1800 [not shown]

18"x30" Duraclear™ Table w/ Pad

CAT# HT-2600

16"x30" Duraclear™ Table w/ Pad
Plus Siderail Attachment for additional accessories needed in minor hand surgical procedures
Plus an adjustable/removable telescoping support leg for added strength and stability.

B. New Lightweight Tables — only 7LB's

Provides excellent X-ray clarity and C-Arm visualization
2 sizes available (see below)
Supplied with 1" standard pad
Requires 2 straight bar or round bar clamps for mounting to siderails of all North American surgical tables

CAT# HT-3200

16" x 30" Lightweight Table w/ Pad — Round Bar Mount

CAT# HT-3400

16" x 30" Lightweight Table w/ Pad — Flat Bar Mount

C. PHENOLIC Operating Surface

Constructed from sturdy radiolucent material with built-in clamps for easy attachment and removal on all North American surgical tables
Supplied with a 2" pressure management pad

CAT# HT-5200

'T' or Winged shape Arm & Hand Table w/ 2" pressure management pad
Legless design provides unimpeded C-arm access and easy access for surgeon comfort

CAT# HT-6600

Rectangle Arm & Hand Table w/ 2" pressure management pad
Table comes equipped with stainless steel adjustable/retractable support leg for superior stability

CAT# HT-6900

Hourglass Arm & Hand Table w/ 2" pressure management pad
Hourglass shape provides ample support and comfort for surgeon
Table comes equipped with stainless steel adjustable/retractable support leg for superior stability

D. Wall Mounting Brackets

For Arm & Hand Table Storage

CAT# PT-5800

Stainless Steel wall mounting brackets keep Arm & Hand tables up out of harms way

E. Arm & Hand Table Siderail Attachment

Stainless Steel siderail attachment provides mounting space for additional accessories needed in special surgical procedures.
Request HT-6050 to be added to table

CAT# HT-6050-18 [not shown]

18" Stainless Steel siderail

CAT# HT-6050-24

24" Stainless Steel siderail

F. PHENOLIC Under Mount Table

CAT# HT-8200

Constructed from sturdy 100% radiolucent phenolic
Easily slides under table cushion
Provides 14" x 25" operating surface of unimpeded imaging
Comes with 2" Pressure Management pad



Arm & Hand Minor Surgery Tables



A
HT-1600
shown w/o pad



HT-2600
shown w/o pad

Birkova Supplies
Replacement pads for
all makes and models
of minor surgery tables
(See page 7)

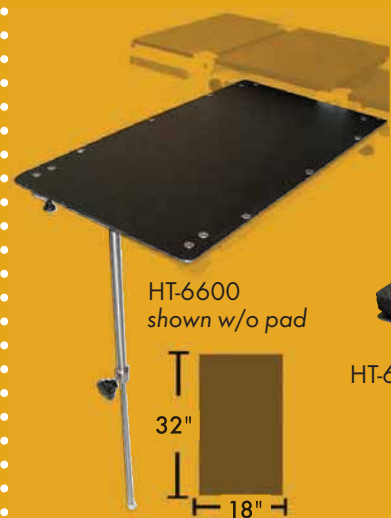

HT-6600
shown w/o pad
32"
18"



HT-5200
22"
30"
12"



HT-6900
32"
15"
24"

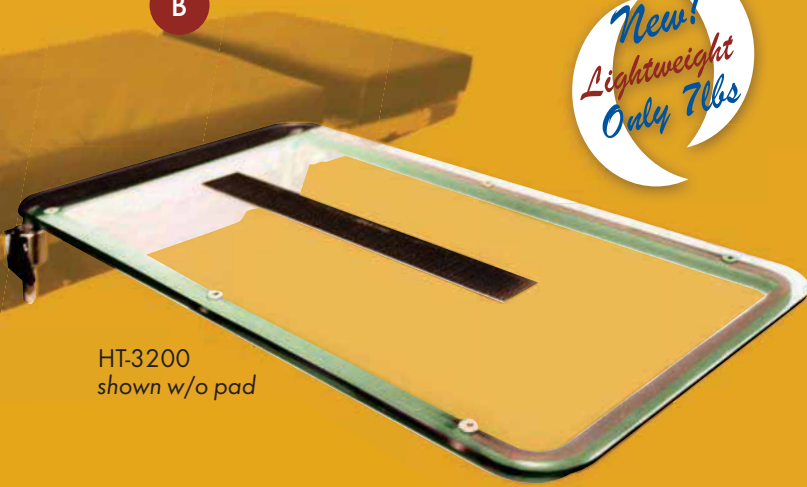

HT-3200
shown w/o pad

New!
Lightweight
Only 7lbs



PT-5800



D



Round Bar
HT-3200



Flat Bar
HT-3400



HT-6050-24

E



HT-8200
shown w/o pad

F

Surgical Accessories

Need replacement legholder boot pads...? see page 10

A. Altima Leg Positioning System

CAT# ALS-6200

Solid stainless steel adjustable extension bar provides ultimate positioning possibilities
Altima boot clamps are designed for full range adjusting and multi-positioning requirements
Super-clamps or Clamp-Tite™ clark sockets recommended for mounting legholders to surgical table (sold separately)
Replacement pads & straps available
Gel boot pads available



Complete System Includes:

- 1 pair of Altima Legholders
- 1 set of Restraint straps
- 1 set of Pressure Management pads

Reusable Gel Pads (Pair)
CAT# ALS-6050



Disposable Foam Pads
(10 Pairs per Case)
CAT# ALS-6070



Pressure Management Pads
With 4-Way Stretch Vinyl (pair)
CAT# ALS-6020



Replacement Straps for Altima
Velcro, 6 per set
CAT# ALS-6090

Pressure Mgmt Pads
Clam Shell Style (pair)
CAT# ALS-6030



B. Universal Well-Leg Support

CAT# ALS-6610

Solid stainless steel adjustable extension bar
Boot clamp is designed for full-range positioning
Ideal for positioning patients of any height
Requires one Super clamp or Clamp-Tite™ clark socket for mounting to surgical table (sold separately)

Includes:

- 1 Well Leg Support
- 1 set of Restraint straps
- 1 Pressure management pad

C. Legholder / Accessory Cart

CAT# LS-1100

Solid stainless steel Accessory Cart
Ideal for storage of your legholder system and other O.R. accessories
Casters allow for easy mobility



LS-1100
shown w/
legholders

D. Lift Assist Leg Positioning System

CAT# LS-3500

Pneumatic lift assist
120° degree rotation
Handle controlled abduction and adduction
Mimics natural hip motion
Twist handle to position leg
500 lbs. weight capacity
Gel boot pads available

System Includes:

- 1- Set of Pneumatic lift assist leg holders
- 1-Set of Pressure management boot pads
- 1- Set of siderail clamps

E. Knee Crutch Supports

CAT# LS-1700

Height adjustable; 360° full rotation
Stainless steel support bars
Includes pressure management pads and restraint straps
Attaches to surgical table using Super Clamps or Clamp-tite clark sockets (sold separately)

F. Arthroscopic Stress Post

CAT# LS-9050-12 - 12" Height Adj.

CAT# LS-9050-18 - 18" Height Adj.

Provides a fulcrum to leverage the leg to gain better access to the knee
5/8" dia. height adjustable post
4" x 6" pad included
Stainless steel plate & support bar
Available in 12" or 18" post height
Securely attaches to any O.R. Table using a Clamp-Tite™ clark socket



ALS-6200

A



ALS-6610

B



LS-1100

*Storage cart
for any leg
holder system*

C



LS-3500

To adjust simply twist and release.

D



LS-1700

E



LS-9050-18

F



LS-9050-12

Surgical Accessories

Leg Holders & Accessories

A. 'Candy Cane' Style Lithotomy Legholder

CAT# LS-2000

Sold in pairs
Fits all surgical tables
Adjustable height of 26" - 39"
Support extension 'cane' 10"W
Stainless steel 'cane' and mounting rod
Superior flexibility for Lithotomy positioning
Super-clamps or Clamp-Tite™ clark sockets recommended for mounting legholders to surgical table
(sold separately)
Set includes 1 pair of ankle support straps
Replacement straps, heel cups and gel available

Lithotomy Legholder Ankle Straps

CAT# LS-2020

Durable cotton straps
Sold in pairs
Double stitched for superior strength

Lithotomy Legholder Heel Cups

CAT# LS-2040

Extra soft heel support cups
Sold in pairs

Lithotomy Legholder Gel Post Pads

CAT# GP-3300

Viscoelastic Gel pads slip over lithotomy post to protect patient extremity
Sold in pairs

Lithotomy Legholder Gel Ankle Straps

CAT# GP-3350

Viscoelastic Straps for Lithotomy legholders
Comfortable support
Sold in pairs

B. Arthroscopic Leg Holder Unit

CAT# LS-1400

Accommodates all patients
Adjusts medially and laterally to apply desired pressure
Dual hinged positioning clamp
Spring loaded adjusting lever
Siderail clamp included
Includes pad

Replacement Arthro Pads

CAT# LS-1420

2-ply, foam, shaped pad
10 pads per case

C. Drainage Bag System

CAT# DB-1000

Flexible, latex free drape support frame
Integral tissue retention filter with flexible hose
Sterile & Non-sterile bags available
Compatible with all suction systems
Efficient fluid containment for hysteroscopy or cysto procedures
Fits any North American surgical tables
Integral rail clamps included
(Replacement Drainage Bags - see pg 21)



DB-1000

D. Pickett Fence Leg Prep Unit

CAT# LS-4200

Easy positioning; Easy to clean
Efficiently preps both legs at once
Stainless steel support bar- 5/8" dia.
Height adjustable up to 30"
Attaches to surgical table using a Clamp-Tite clark socket or Super clamp (sold separately)

E. Uni-Prepper Leg Prep Unit

CAT# LS-4800

Most versatile leg prepper available
Infinite positioning possibilities
Requires a Clamp-Tite clark socket or Super clamp for mounting *(sold separately)*
Leg cradle measures 8"W x 5"H x 3 1/2"D
Adjustable height of 12" - 27"
Stainless steel construction
Fits all surgical tables
Pressure management pad included

Replacement Uni-Prepper Pad



CAT# LS-4801-1

Memory foam with 4-way stretch fusion vinyl pad

F. Bariatric Uni-Prepper Leg Prep Unit

CAT# LS-4850

Same as LS-4800, except heavier construction and 10.5" wide support cradle

*Leg supports for any procedure...
choose your style!*

*Lithotomy positioning...
made easy!*



LS-2000



LS-2020



LS-2040



GP-3350



GP-3300

*In Stock
Items*

LS-1420



LS-1400



LS-4200



LS-4800

B



D

NEW!

E



360° rotation of leg cradle

**Doubles as an
arm support**



LS-4850

F



Surgical Accessories

Surgical Table Accessories



A. NEW! Sliding Headrest

NH-5000 Series

New unique sliding design allows for precise positioning for ophthalmic and ENT procedures

24 possible locking positions provide surgeons with ultimate accessibility

Comes with 2" Pressure

Management pad

Secures in desired position; remains horizontal

Clamps not required for mounting

CAT# NH-5120

Sliding headrest for Amsco 2080/1080 tables

CAT# NH-5130

Sliding headrest for Amsco 3080/3085 tables

CAT# NH-5200

Sliding headrest for Skytron tables

CAT# NH-5300

Sliding headrest for Champagne tables

B. Narrow Headrest

NH-2000 Series

Designed for ophthalmic and ENT procedures

Allows superior access for the surgeon

Durable design using stainless steel and radiolucent phenolic

Comes with 2" thick pad

Clamps not required for mounting

This headrest is designed for most surgical tables

CAT# NH-2120

Narrow headrest for Amsco 2080/1080 tables

CAT# NH-2130

Narrow headrest for Amsco 3080/3085 tables

CAT# NH-2200

Narrow headrest for Skytron tables

CAT# NH-2300

Narrow headrest for Champagne tables

C. Neuro Headrest w/ Wristrest

NH-7000 Series

Designed for ophthalmic and ENT procedures

Wristrest is height adjustable

Headrest comes with 2" pressure management pad

Secures in desired position;

remains horizontal

Clamps not required for mounting

CAT# NH-7120

Neuro headrest for Amsco 2080/1080 tables

CAT# NH-7130

Neuro headrest for Amsco 3080/3085 tables

CAT# NH-7200

Neuro headrest for Skytron tables

CAT# NH-7300

Neuro headrest for Champagne tables

Specify make and model of surgical table when ordering headrests A-C

D. Anesthesia Screen

CAT# AN-1100

Multi-positionable

Height adjustable

Stainless steel

Single point mount for easy access to patient

Mounts using clark socket

or round bar clamp

E. Form-A-Screen

CAT# AN-8000

This flexible Anesthesia Screen is malleable and shapes easily into any configuration desired and retains its shape

Stainless steel with flexible coating

Requires 2 siderail clamps for mounting

F. Deluxe Lateral Brace System

CAT# LP-6000

Fully adjust vertically, horizontally, and diagonally for optimum positioning

Independent locking device insures precise positioning

Swivel heads securely lock in desired position; braces are covered with soft Fusion pads

Stainless steel & anodized aluminum construction

Stainless steel & anodized aluminum construction

Stainless steel & anodized aluminum construction

Stainless steel & anodized aluminum construction

Stainless steel & anodized aluminum construction

Stainless steel & anodized aluminum construction

Stainless steel & anodized aluminum construction

Stainless steel & anodized aluminum construction

Stainless steel & anodized aluminum construction

Stainless steel & anodized aluminum construction

Stainless steel & anodized aluminum construction

Stainless steel & anodized aluminum construction

Stainless steel & anodized aluminum construction

Stainless steel & anodized aluminum construction

Stainless steel & anodized aluminum construction

Stainless steel & anodized aluminum construction

Stainless steel & anodized aluminum construction

Stainless steel & anodized aluminum construction

Stainless steel & anodized aluminum construction

Stainless steel & anodized aluminum construction

Stainless steel & anodized aluminum construction

Stainless steel & anodized aluminum construction

Stainless steel & anodized aluminum construction

NEW! Sliding Headrest

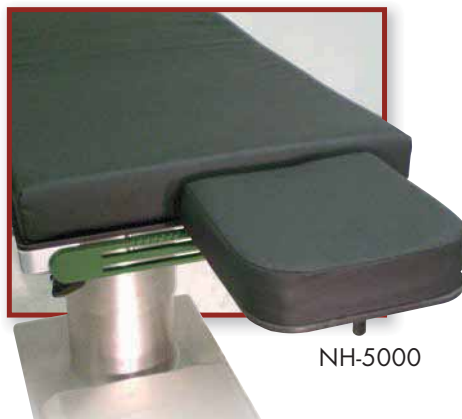

NH-5000

A headrest designed at a surgeons request...

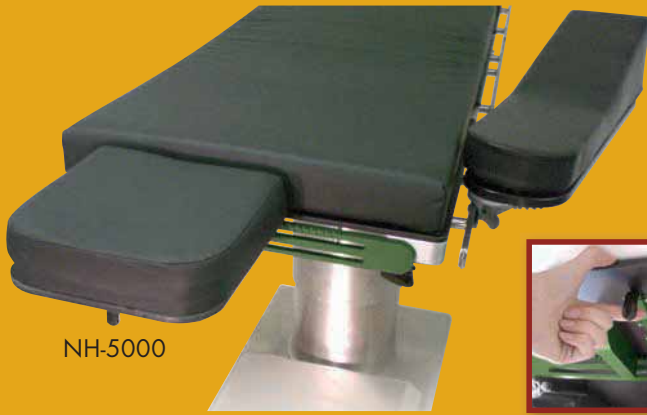

NH-5000



24 possible positions

A

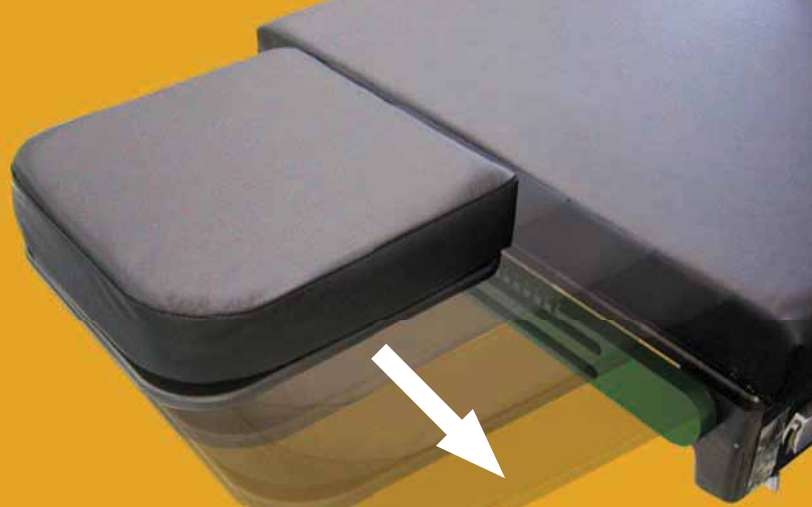

... slide, and lock, in the position that works best!

B



NH-2000

C



NH-7000

D



AN-1100

F

LP-6000



Infinite Positioning

E

AN-8000



Quality Guaranteed

Surgical Accessories



A. Patient Transfer Slide Board

Lightweight and very flexible
This transfer device easily slides patients from one surface to another
Durable X-ray permeable material
Built-in hand holes for easy grip
Straps available for easy maneuvering
Latex free, anti-static, easy clean surface

CAT# PT-2200

23"x36" Slide Board

CAT# PT-2400

23"x70" Slide Board

Slide Board Accessories

CAT# PT-2010

Hook for wall mounting Slide Boards

CAT# PT-2015

Bracket for wall mounting Slide Boards

CAT# PT-2020

Patient straps for Slide Boards(Pair)

B. Patient Roller Board Transfer Devices

Transfer patients from one surface to another with minimum effort
Reduces the risk of back injuries
Aluminum rollers allow easy Glide
Heavy-duty vinyl cover – easy to clean
Replacement vinyl covers available

CAT# PT-5825

15"x25" Roller Board w/ cover

CAT# PT-5830

15"x30" Roller Board w/ cover

CAT# PT-5867

15"x67" Roller Board w/ cover

C. Roller Board Wall Mount

CAT# PT-5800

Store roller boards on the wall
Durable stainless steel mounting brackets keep transfer devices up off the floor
Instructions for mounting, placement, and hardware are included

D. Bariatric Roller Board Transfer Device

CAT# PT-5920

20" wide x 31" long
Heavy duty construction
Ideal for Bariatric patients

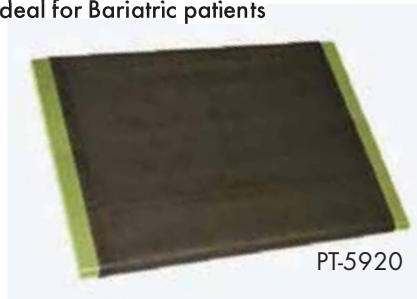

E. Transfer Stretcher

Versatile transfer stretcher, provides ultimate patient comfort
Smooth and easy transferring of patients
Dual lift cylinders with easy trendelenberg adjustment.
14" H stainless steel collapsible siderails.
Height adjustable 23" to 36"
Includes removable 26" double hook IV Pole
Includes 4" standard mattress
Available in additional patient widths

CAT# PTS-8000

Transfer stretcher 26" x 77" surface

CAT# PTS-8200

Transfer stretcher 29" x 77" surface

CAT# PTS-8300

Transfer stretcher 31" x 77" surface



F. Eye Transfer Stretcher

Dual articulating head attachment
Headrest articulation, fowler assist and knee gatch
8" locking casters w/ foot end brake steer pedals
Sturdy dual pedestal hydraulic lift mechanism
Easy hands free access for Trendelenburg/Reverse Trendelenburg and lift features
Fold forward side rails with built in push handles
I.V. pole sockets on all corners
O2 storage underneath
Includes 4" standard mattress
2 hook removable telescopic I.V. pole included

CAT# PTS-8500

Eye transfer stretcher 26" x 77" surface with articulating headrest

CAT# PTS-8600

Eye transfer stretcher 29" x 77" surface with articulating headrest

CAT# PTS-8700

Eye transfer stretcher 31" x 77" surface with articulating headrest

G. Pediatric Stretcher/Crib

Full-function Stretcher that doubles as a Crib
Perfect for any facility
Childproof with one-handed operation siderails
Counter balanced 2" bar spacing
Quick operation of Fowler, Trendelenburg, and Reverse Trendelenburg positioning
Includes staph-chek 4" covered mattress.
Call for choice of many optional features.

CAT# PTS-5000

Pediatric Stretcher/Crib 30" wide x 60" long
(Replacement crib mattress CM-0500)
(See page 11)

Patient transfer devices protect staff from back injuries!



A



B



- Tilt patient
- Place transfer device under patient
- Transfer patient to the other surface
- Tilt patient – Remove transfer device



C



PT-5825
shown on
PT-5800



PT-5800



PT-2010



PT-2015



PT-2020

E



PTS-8000

F



PTS-8500

Surgical Accessories

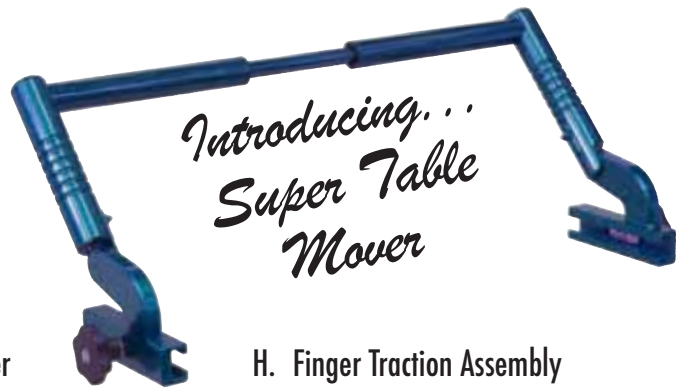

*Introducing...
Super Table
Mover*

A. Surgical Table Perineal Filler Plate

CAT# PRT-1220

Plate covers perineal cut-out on Amsco/Steris 3080/3085 surgical tables
Durable plastic with mounting studs
For other makes/models of tables call for ordering information

B. HILL-ROM AFFINITY ACCESSORIES

CAT# PRT-6706 - Crank Handle

CAT# PRT-6708 - Labor Grip

CAT# PRT-6714 - Foot Support

CAT# PRT-6710 - Calf support pads

CAT# PRT-6712 - Calf Support

CAT# PRT-6720 - Perineal Fluid Basin

CAT# PRT-6740 - IV Pole

Replacement accessories for most makes and models of Birthing Beds. Call for more information. For replacement birthing bed mattresses – see pg. 11

C. Equipment Casters & Feet

Replacement casters & feet available for most healthcare equipment.
Call for more information

D. Surgical Table Power Cords

Hospital grade power cords in standard 20 ft. length come with 3 different connector ends.
Temperature rating up to 105° C.
Custom lengths and specifications available upon request.

CAT# PRT-2120 - Hard wire applications
(No connector)

CAT# PRT-2130 - Straight connector

CAT# PRT-2150 - Right hand connector

CAT# PRT-2170 - Left hand connector

CAT# PRT-2180 - Twist-lock connector

E. Super Table Mover

CAT# STM-8000

This unique attachment puts the “mobile” into your mobile surgical or imaging table
Reduces risk of back strain injury to hospital staff
Increases infection control protocol, by allowing easier and efficient moving of tables for room sterilization
Lockable in three positions from 0 to 45 to 90 degrees
The handle width is adjustable from 19.5” to 32”
Reduces OR /Imaging Suite downtime
Includes wall mounting bracket for storage

F. Legholder Replacement Parts

CAT# PRT-1000

Lift Cylinder Strut

CAT# PRT-1014

Replacement Strut Clips 4/pkg
(for replacement pads – see pg 9)

G. X-ray Permeable Panel Sets

These radiolucent panel sets allow for the insertion of an x-ray cassette tray and film under the patient during procedures requiring a hard copy x-ray.
Available for most makes and models
Call customer service for catalog number and pricing for the set that fits your surgical table

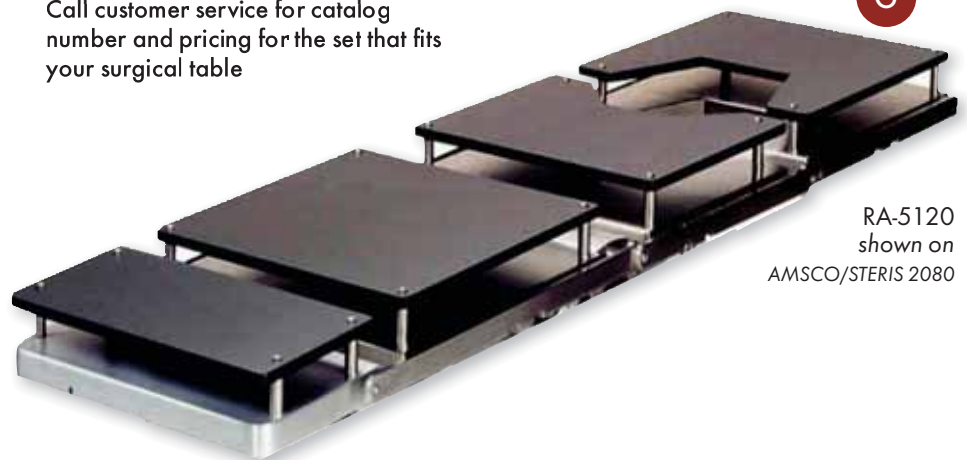

RA-5120
shown on
AMSCO/STERIS 2080

H. Finger Traction Assembly

CAT# FT-2000

Durable stainless steel construction
Use with 1 to 5 finger trap placements
Fully adjustable for both height and angulation requirements
Each placement wheel is independently secured in desired position with easy adjust tension knob
Recommended for use on HT-2600
Finger sleeves & weights not included
Includes mounting clamp

CAT# FT-2100

Equilizing Triangle w/ hardware

I. Finger Trap Sleeve Sets [not shown]

CAT# FT-2020

Pediatric Set

CAT# FT-2050

Set A, Adult Set

CAT# FT-2070

Set B, Adult Large Set

Finger traps for hand traction devices, does not include weights
5 traps per set

A

PRT-1220



B

Birthing Bed Replacement Accessories



C



D



E



Makes surgical tables 'Mobile' for O.R. sanitization and organization easy to use in 3 easy steps



F



H

FT-2000

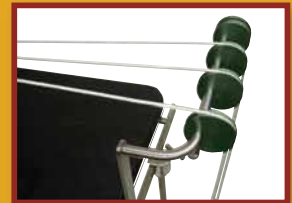
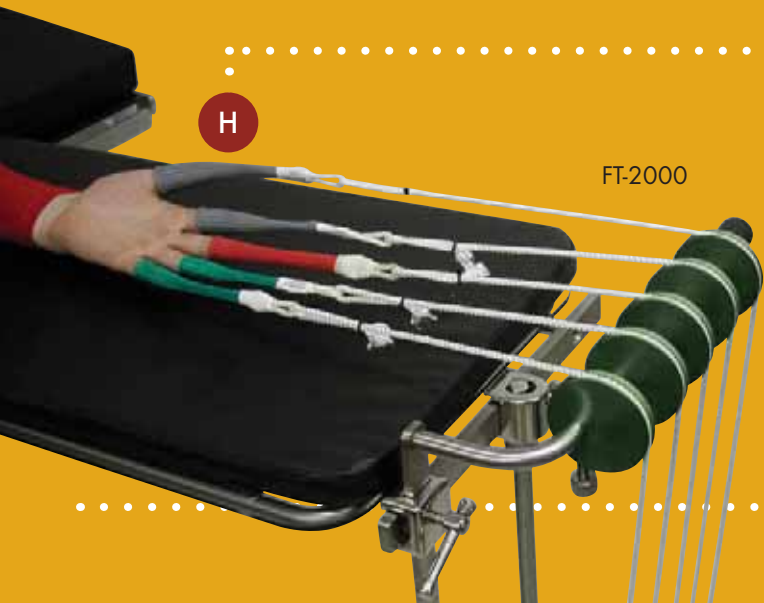

Surgical Accessories

A. STYLUS STOOL

Included on all Pnuematic stools:
Quick adjust gas spring height
adjustment, heavy duty aluminum base,
16" dia. Comfort padded seat
(Hgt adj 18" - 23")
(specify vinyl color)

CAT# ST-6200

Pnuematic stool

CAT# ST-6240

Pnuematic stool w/Foot Ring

CAT# ST-6260

Pnuematic stool w/ Back Support

CAT# ST-6280

Pnuematic stool w/ Back Support and
Foot Ring



ST-6280

CAT# ST-6200-15

Foot Operation Upgrade, innovative
quick adjust mechanism, provides hands
free operation of height adjustment,
factory installed. Available for all
STYLUS STOOLS

B. FOOTSTOOLS

Chrome Footstool

CAT# ST-8200

Chrome construction, Rubber ribbed
platform
Lightweight & sturdy,
14"L x 11"W x 9"H

300 lbs. weight capacity

2-Step Footstool

CAT# ST-8400

Stainless Steel, MRI safe,
Bottom step 24"w x 16"d
Top step 24"w x 8"d
Optional 41" handrail available

C. E-Z Stacking Stool

CAT# ST-8700

MRI safe
Locking side-to-side or end-to-end feature
12"D x 18"L x 5 1/4"H, Stainless steel
No slip rubber treading on platform
No slip rubber tips on legs
Great for surgery suites and exam rooms

E-Z Stacking Stool Dolly

CAT# ST-8790

Great for easy storage and
stool mobility
Stainless steel construction
Non-magnetic components,
MRI safe
Non-marring rubber casters
13"D x 23"W x 39"H

D. Easy Lift Gas Stools

Gas lift - finger tip height adjustable
16" seat dia. w/3" thick density foam
Covered in heavy gauge vinyl
Easy rolling 2" casters
Models available with vinyl or polished
aluminum base
(specify vinyl color)

CAT# WN-3250

Gas Lift Stool with polished aluminum
base

CAT# WN-3600

Gas Lift Stool w/ Backrest and vinyl base

F. Pneumatic Foot Operated Height

Adjustment from 18" to 23"
Tall model available
15" or 16" dia. padded seat
5 leg base with ball bearing casters
Choice of vinyl colors
Ergonomic options available

Call for item number and available styles

CAT# ST-4200

SUPRA' BIOFIT PNEUMATIC STOOL
- chrome, foot operated - 15" dia. Seat
(Hgt adj 18" - 23")
(specify vinyl color)

G. LABORATORY STOOL

CAT# ST-4720

18" dia. Contour Seat, fully adjust
seat & back, 18" Footring, pneumatic
easy lift, black aluminum base w/ glides,
(Hgt adj 20.75" - 31")
(specify vinyl color) 250lb. capacity

CAT# ST-4725

TALL - 18" dia. Contour Seat, fully adjust
seat & back, 18" Footring, pneumatic
easy lift, black aluminum base,
(Hgt adj 21.75" - 32")
(specify vinyl color) 250lb. capacity

CAT# ST-4840

SURGEON STOOL - 18.5"w Contour
Seat & Back, fully adjust seat & back,
Foot Operated, hands-free pneumatic
easy lift, black aluminum base, (Hgt adj
19" - 24")
(specify vinyl color) 250lb. capacity

CAT# ST-4960

TASK CHAIR w/ADJ. ARMS - 18.5"w
Contour Seat & Back, fully adjust seat
& back, pneumatic easy lift, black
aluminum base, (Hgt adj 18" - 25")
(specify vinyl color) 250lb. capacity

A



ST-6200

ST-6240



ST-6200-15

B



ST-8200



ST-8400

C



ST-8700

ST-8790

D



WN-3250

WN-3600

Padded Stool Covers

CAT# ST-1200 (12" dia.)

CAT# ST-1300 (13" dia.)

CAT# ST-1400 (14" dia.)

CAT# ST-1500 (15" dia.)

CAT# ST-1600 (16" dia.)



Available in
Black only

*Cover Cushions
Give your old
stool new life!*

E



ST-4200

F



ST-4720

ST-4725

ST-4840

ST-4960

Surgical Lighting, IV Poles & Misc.

A. IV Poles

CAT# IVP-4200

S.S. IV Pole w/ 2 hook, extends 53"-96"
5 leg powder coated base

CAT# IVP-4400

S.S. IV Pole w/ 4 hook, extends 53"-96"
5 leg powder coated base

CAT# IVP-4600

S.S. IV Pole w/ 6 hook, extends 53"-96"
5 leg powder coated base

CAT# IVP-6050

Chrome heavy-duty IV Pole, 5 leg base,
Tru-loc knob, 4 hook top, extends 56"-
100"

CAT# IVP-6250

S.S. 4 leg IV Pole w/ 2 hook top
Tru-loc knob, extends 51"-94"H

CAT# IVP-6450

S.S. 4 leg IV Pole w/ 4 hook top
Tru-loc knob, extends 51"-94"H

B. IV Poles Accessories

Economy IV Poles

CAT# IVP-1200

Chrome IV Pole, 4 leg, 2 hook 47"-85"

CAT# IVP-1400

Chrome IV Pole, 4 leg, 4 hook 47"-85"

Versa-Pole

CAT# IVP-8800

Portable I.V. pole w/clamp secures
where you need it
Works on stretchers, wheelchairs, etc
S.S., 2 hook, Fully extends
22"-36" high

Super Pole Unit

CAT# IVP-8900

Stainless Steel telescoping pole,
2 hook top, 33"-60",
Securely mounts in beds, gurneys,
and medical carts

IV Pole Accessories

CAT# IVP-1050

S.S. Infusion pump tray/ utility tray for
I.V. Pole

CAT# IVP-1090

Infusion pump support frame with 2
universal pole clamps for mounting

CAT# IVP-8910

Patient Pal Support Wheel
Holds 4 utility trays

CAT# IVP-8915

Utility Tray Triangle
Durable plastic, 4 per package

CAT# IVP-8950

Standard C-Clamp for IV Poles

Powermate

CAT# IVP-9080

6 receptacle outlet hub
Securely mounts on any IV Pole
15' power cord, 120v

C. Waste Receptacles

Waste Receptacles Meet OSHA
standard on bloodborne
Pathogens, available in 13, 20 & 32
Quart capacity, 5 styles, plastic or
painted enamel, colors red, white, beige
or stainless steel finish available

CAT# WC-6220

Step-on, Plastic Waste Can, 32QT.
(8 Gal) capacity, White,
12"d x 15"w x 19"h

CAT# WC-6420

Step-on, Square Metal Waste Cans,
20QT. (5 Gal) capacity, White enamel
finish, removable plastic liner,
11"d x 11.75"w x 17.25"h

CAT# WC-6480

Step-on, Square Metal Waste Cans,
32QT. (8 Gal) capacity, Red enamel
finish, removable plastic liner,
11.5"d x 12.25"w x 18.25"h

CAT# WC-6690

Step-on, Round Metal Waste Can, 32QT.
(8 Gal) capacity, Beige enamel finish,
removable plastic liner, 11.5"Dia. x 24"h

CAT# WC-6710

Step-on, Round Metal Waste Cans,
13QT. capacity, Stainless Steel

D. Stallion Ultraview Headlight System

CAT# SHL-3100

STALLION ULTRAVIEW HEADLIGHT
SYSTEM, CORDLESS, FULLY
ADJUSTABLE W/ SWIVEL MOUNT,
includes 2 batteries, charger & magnify-
ing lens

CAT# SHL-3200

STALLION ULTRAVIEW 2 HEADLIGHT
SYSTEM, CORDLESS, FULLY
ADJUSTABLE W/ SWING AWAY
MOUNT, includes 2 batteries, charger &
magnifying lens

Stallion 
U L T R A V I E W



SHL-3200

BIRKOVA
Products

In Stock Items

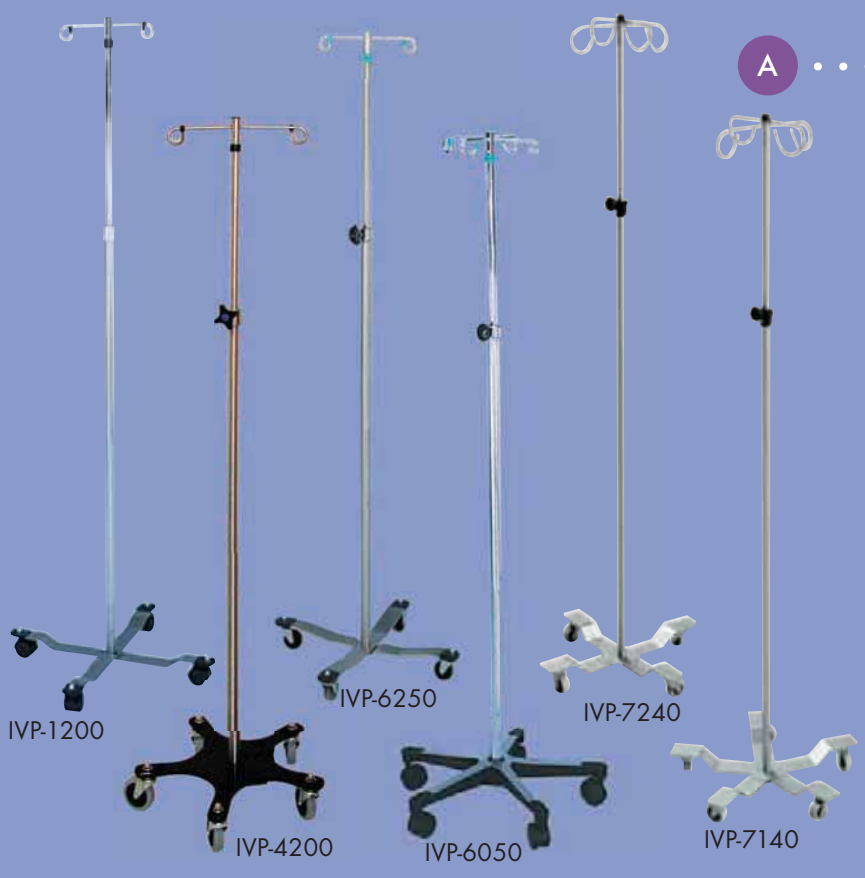

NEW!
Stallion  **Cordless**
ULTRAVIEW
Headlight System



Clinical Outfitting

Stainless Steel Carts & Tables



ITH-8036

A. Instrument Tables

Premium quality
Solid stainless steel construction
Many different sizes available
Heavy duty casters for easy mobility
Available with shelf or 'H' brace

| Table Size | Shelf | 'H' Brace |
|-----------------|----------|-----------|
| 16" x 20" x 34" | ITS-1620 | ITH-1620 |
| 16" x 30" x 34" | ITS-1630 | ITH-1630 |
| 18" x 33" x 34" | ITS-1833 | ITH-1833 |
| 20" x 36" x 34" | ITS-2036 | ITH-2036 |
| 20" x 48" x 34" | ITS-2048 | ITH-2048 |
| 24" x 36" x 34" | ITS-2436 | ITH-2436 |
| 24" x 48" x 34" | ITS-2448 | ITH-2448 |
| 24" x 60" x 34" | ITS-2460 | ITH-2460 |
| 24" x 72" x 34" | ITS-2472 | ITH-2472 |

B. Case Carts

CAT# CC-1600 (42" x 29" x 39")
Open Cart, 2 Wire adjustable shelves

CAT# CC-1800 (42" x 29" x 39")
Open Cart, Solid top shelf,
1 adjustable shelf

CAT# CC-2100 (29.5" x 29" x 39")
Mini Cart, 1 door, wire pull-out

CAT# CC-2200 (52" x 29" x 39")
Maxi Cart, 2 door, 2 wire pull-outs

CAT# CC-2300 (29.5" x 29" x 54")
Space Saver, 1 door, wire pull-out

CAT# CC-2400 (42" x 29" x 39")
Multi-purpose Cart, 2 door, 1 shelf

CAT# CC-2480 (42" x 29" x 39")
Multi-purpose Cart w/ 2 18" ext. shelves

CAT# CC-2500 (42" x 29" x 54")
Ultra Space Saver Cart, 2 door, wire pull-out

C. Adjustable Height Instrument Tables

Many styles available - please call customer service for more information.

D. Utility Tables/Prep Stands

Stainless Steel stands w/ casters

CAT# UT-2100
(20" x 16" x 34"H) no drawer

CAT# UT-2200
(20" x 16" x 34"H) 1 drawer

CAT# UT-2500
(20" x 16" x 34"H) 2 drawer

CAT# UT-2800
(20" x 16" x 34"H) 3 drawer

CAT# UT-2900
(20" x 16" x 34"H) 4 drawer

CAT# UT-3000
(36" x 20" x 34"H) 2 drawer

E. Nested Instrument Tables

CAT# ITN-8000
Complete Set - 6 tables

CAT# ITN-8001
Table 1 - 28"Wx14"Dx32"H

CAT# ITN-8002
Table 2 - 32"Wx16"Dx34"H

CAT# ITN-8003
Table 3 - 36"Wx18"Dx36"H

CAT# ITN-8004
Table 4 - 40"Wx20"Dx38"H

CAT# ITN-8005
Table 5 - 44"Wx22"Dx40"H

CAT# ITN-8006
Table 6 - 48"Wx24"Dx42"H

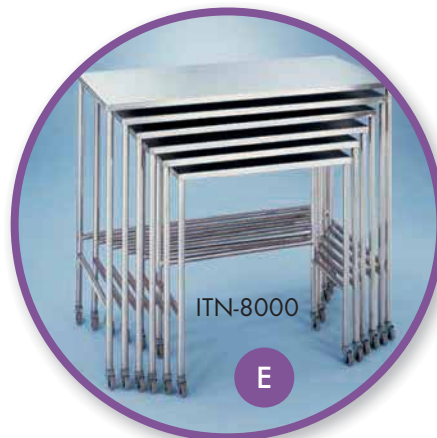

ITN-8000

F. Stainless Steel Work Tables

CAT# ITS-6830
w/ shelf (68"W x 30"D x 36"H)

CAT# ITS-8036
w/ shelf (80"W x 36"D x 36"H)

CAT# ITS-9244
w/ shelf (92"W x 44"D x 36"H)

CAT# ITH-6830
w/ H-brace (68"W x 30"D x 36"H)

CAT# ITH-8036
w/ H-brace (80"W x 36"D x 36"H)

CAT# ITH-9244
w/ H-brace (92"W x 44"D x 36"H)

G. Stainless Steel Exchange / Supply Carts

CAT# EC-6220 (36.25"w x 24"d x 45"h)
Holds 12 standard 5" totes or
6 large 10" totes

CAT# EC-6280 (51.5"w x 24"d x 57"h)
Holds 24 standard 5" totes or
12 large 10" totes

CAT# EC-6420 (55.365"w x 26"d x 58"h)
3 shelves and tote storage - Holds 7
standard 5" totes or 3 large 10" totes

CAT# EC-6480 (66.625"w x 26"d x 69"h)
4 shelves and tote storage - Holds 9
standard 5" totes or 4 large 10" totes

CAT# EC-6005
5" plastic supply tote

CAT# EC-6010
10" plastic supply tote

Exchange/Supply Cart Covers

Available for all makes and models of carts
STAPH-CHEK COVER w/ clear vinyl front, nylon zipper closure
Call for cat# and info

Cart Shelf 'Dust Guards'

Keep linens cleaner
Heavy mil plastic panel 'dust guards'
Place on wire shelves to protect against dirt or dust filtering up through wire on shelves



A



*Satisfaction
Guaranteed*



B

D

C



G



Clinical Outfitting

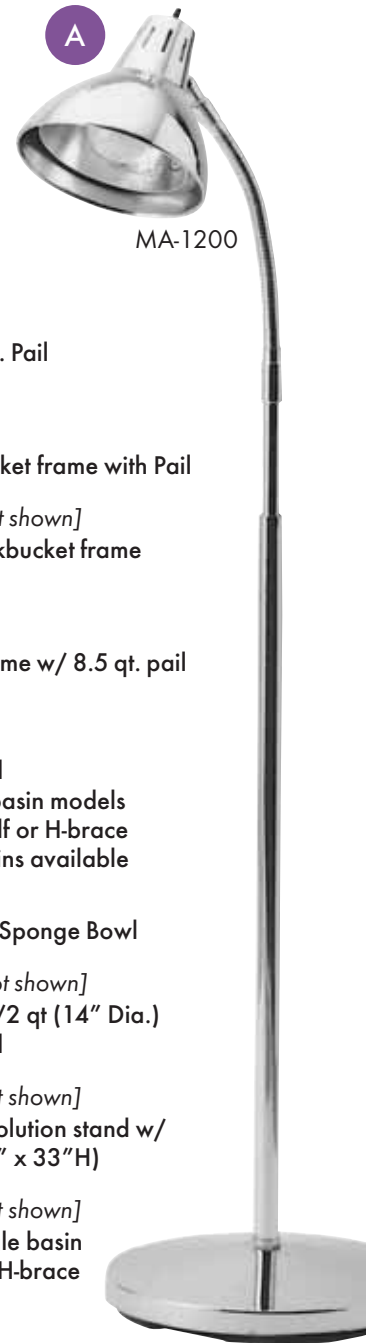

MA-1200

A. Exam Light

CAT# MA-1200

Exam Lamp, 60 WATT,
Chrome freestanding model
110v, 50/60Hz

CAT# MA-1800 [not shown]

Halogen 35 Exam light, floor model
w/ mobile base, 35 watt, available in
white or beige

B. Folding Utility Cart

CAT# UC-3240

Chrome Frame (29.75" x 19" x 35"H)

CAT# UC-3242 [not shown]

12" Wire Basket for UC-3240

CAT# UC-3241 [not shown]

6" Wire Basket for UC-3240



UC-3240 (frame)

C. Hamper bags

CAT# HP-0018

Hamper bag – Re-useable
Fits 18" dia. hamper models

CAT# HP-0024 [not shown]

Hamper bag – Re-useable
Fits 24" dia. hamper models



HP-0024

D. Hampers *Many styles available*

CAT# HP-1800

20" Dia. chrome hamper with S.S. lid
and foot pedal

CAT# HP-2100

Chrome step-on hamper, foot
operated

CAT# HP-6800

Adjustable chrome hamper
18", 22", or 24"

CAT# HP-4200 [not shown]

Triangular hamper, space-saver, solid
stainless steel

CAT# HP-4220

Triangular hamper, space-saver, w/
foot operated lid, solid stainless steel

E. Mayo Stands

Stainless Steel or chrome stands
2" conductive casters
Foot or thumb operated styles
available
MS-5580 is MRI Safe

CAT# MS-1100

Chrome single post mayo stand
(12 5/8" x 19 1/8")

CAT# MS-1300

Chrome 5 leg, instrument stand
(12 5/8" x 19 1/8")

CAT# MS-3200

S.S., single post, manual knob
operated (21.25" x 16.25")

CAT# MS-3400 [not shown]

S.S., single post, manual knob
operated (13 3/4" x 19 1/8")

CAT# MS-4420

S.S. Foot operated (16" x 21")

CAT# MS-5000

Jumbo S.S. double post, foot
operated
(20" x 25")

CAT# MS-6700

S.S., single post, hand/thumb
operated friction lock (21.25" x
16.25")

F. Kickbuckets

CAT# KB-1000

Kickbucket 12.5 qt. Pail
(fits all models)

CAT# KB-2100

S.S. Lenox kickbucket frame with Pail

CAT# KB-2180 [not shown]

MRI Safe - S.S. Kickbucket frame
w/ 12.5 qt. pail

CAT# KB-2400

S.S. Kickbucket frame w/ 8.5 qt. pail

G. Solutions Stands

304 Stainless Steel
Single or Double basin models
Available with shelf or H-brace
Extra Solution basins available

CAT# SS-0050

Solution basin 7qt Sponge Bowl

CAT# SS-0090 [not shown]

Solution basin 8 1/2 qt (14" Dia.)
304 Stainless Steel

CAT# SS-1000 [not shown]

S.S. Single basin solution stand w/
H-brace (15" x 15" x 33"H)

CAT# SS-1080 [not shown]

MRI Safe S.S. Single basin
solution stand- w/ H-brace

CAT# SS-1100

S.S. Single basin solution stand
w/ Shelf (15" x 15" x 33"H)

CAT# SS-1180 [not shown]

MRI Safe S.S. Single basin
solution stand w/ Shelf

CAT# SS-2000 [not shown]

S.S. Double basin solution
stand w/ H-brace
(15" x 32" x 33"H)

CAT# SS-2100

S.S. Double basin solution
stand w/ Shelf (15" x 32" x 33"H)



HP-1800



HP-2100

D

E

*Quality
Guaranteed*

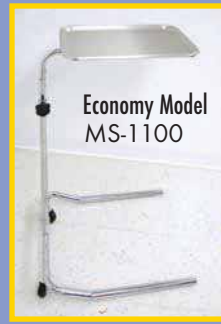

Economy Model
MS-1100



MS-1300

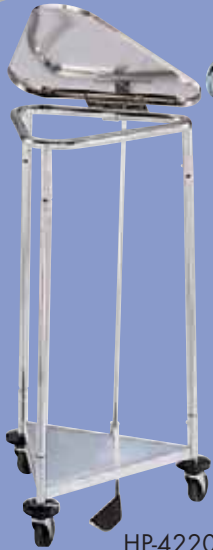

HP-4220



HP-6800



MS-3200



MS-4420



MS-5000

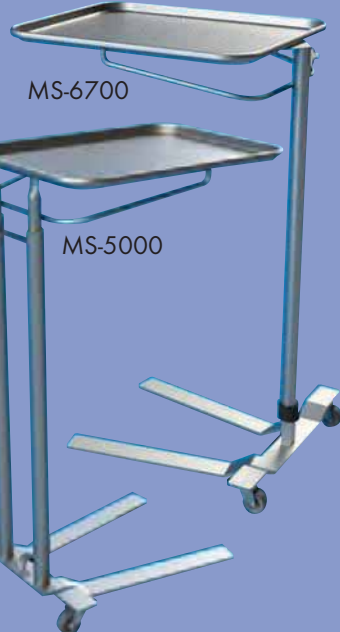

MS-6700



KB-1000



KB-2100



KB-2400

F



SS-2100



SS-1100

G



SS-0050

H



Utensils/Stainless Steel Appliances
Dressing Jars, Ointment Jars,
Catheter Tray & Cover, Emesis
Basin, Graduated Medicine Cups,
Graduated Measures, Iodine Cup,
and Instrument Trays.
Many styles available - please
call customer service for more
information.



Clinical Outfitting

Single, Dual & Triple Compartments



For all other available options please contact your rep

A. Blanket/Solution Warming Cabinets

Multiple Styles Available
 Large digital display
 Easy operation / User lockout available
 Rapid warm time / Uniform heating
 18" cabinet depth available on some models
 Push button digital control panel
 Countertop and under countertop models available
 Available with or without glass doors
 Will maintain +/- 1 degree F. of set point
 Single 120V, 7.5 Amp, 50/60 Hz
 Dual / Triple 120V, 15 Amp, 50/60 Hz

Single Compartment

CAT# MWC-2200

Ready Warmer 15"W x 15.5"D x 22"H w/ glass doors

CAT# MWC-4100

24"W x 20.5"D x 24.5"H, adjustable shelf

CAT# MWC-4100G

24"W x 20.5"D x 24.5"H Glass doors only, adjustable shelf

CAT# MWC-4200

30"W x 26.5"D x 24.5"H

CAT# MWC-4200G

30"W x 26.5"D x 24.5"H w/ glass doors

CAT# MWC-4218

30"W x 20.5"D x 24.5"H

CAT# MWC-4218G

30"W x 20.5"D x 24.5"H w/ glass doors

CAT# MWC-4300

30"W x 26.5"D x 36"H

CAT# MWC-4300G

30"W x 26.5"D x 36"H w/ glass doors

CAT# MWC-4620

24"W x 20.5"D x 64.75"H

CAT# MWC-4620G

24"W x 20.5"D x 64.75"H w/ glass doors

CAT# MWC-4630

30"W x 20.5"D x 64.75" H

CAT# MWC-4630G

30"W x 20.5"D x 64.75"H w glass doors

CAT# MWC-4700

30"W x 26.5"D x 74.5"H

CAT# MWC-4700G

30"W x 26.5"D x 74.5"H w/ glass doors

Dual Compartment

CAT# MWC-6000

30"W x 26.5"D x 74.5"H

CAT# MWC-6000G

30"W x 26.5"D x 74.5"H w/ glass doors

CAT# MWC-6018

30"W x 20.5"D x 64.5"H

CAT# MWC-6018G

30"W x 20.5"D x 64.5"H w/ glass doors

CAT# MWC-6100

30"W x 26.5"D x 74.5"H

CAT# MWC-6100G

30"W x 26.5"D x 74.5"H w/ glass doors

CAT# MWC-6118

30"W x 20.5"D x 74.5"H

CAT# MWC-6118G

30"W x 20.5"D x 74.5"H w/ glass doors

CAT# MWC-6200

24"W x 26.5"D x 74.5"H

CAT# MWC-6200G

24"W x 26.5"D x 74.5"H w/ glass doors

CAT# MWC-6218

24"W x 20.5"D x 64.5"H

CAT# MWC-6218G

24"W x 20.5"D x 64.5"H w/glass doors

CAT# MWC-6250

24"W x 20.5"D x 74.5"H

CAT# MWC-6250G

24"W x 20.5"D x 74.5"H w/ glass doors

Triple Compartment

CAT# MWC-8200

30"W x 26.5"D x 78.25"H

CAT# MWC-8200G

30"W x 26.5"D x 78.25"H w/glass doors

Transport Dolly

CAT# MWC-7920

Transport dolly for tall models
 30"W x 24"D x 5"H

B. Surgical Scrub Sinks

Optional Features Available
 Knee operated soap dispenser
 Optional scrub timer
 Pedestal base option
 Large scrub area with a deep sloping basin
 Sterilizable spray rose aerator
 All stainless steel construction
 Manual or automatic operation
 Adjustable thermostatic water mixing valve
 Available in single, double, and triple sink basin

CAT# MSS-2000

Windsor Wall Mount Scrub Sink

CAT# MSS-2320

Single Scrub Sink
 32"W x 37"H x 27.5"D

CAT# MSS-2320IR

Single Scrub Sink w/ Infrared Option
 32"W x 37"H x 27.5"D

CAT# MSS-2640

Double Scrub Sink
 64"W x 37"H x 27.5"D

CAT# MSS-2640IR

Double Scrub Sink w/ Infrared Option
 64"W x 37"H x 27.5"D

CAT# MSS-2960

Triple Scrub Sink 96"W x 37"H x 27.5"D

CAT# MSS-2960IR

Triple Scrub Sink w/ Infrared Option
 96"W x 37"H x 27.5"D



MWC-6000G



MWC-4200



MWC-4100G



MWC-4300G

MWC-4200G
shown on ITS-2436



MWC-2200



MWC-4700G
shown on
MWC-7920 Dolly



MSS-2960

A
B

*Satisfaction
Guaranteed*



MSS-2640



MSS-2000



MSS-2640IR



MSS-2320IR

Clinical Outfitting

Clinical Outfitting



Privacy Screens



Utility Carts



Designer Side Chairs



Specialty Exam Tables





WN-8400



WN-8200



WN-9400



WN-9800

Blood Chairs

Recliners



OT-4610



OT-9200



OT-4630



WN-1750



WN-1880

Over Bed Tables

Treatment Tables



OT-4240
(shown w/ mirror tray and maple top)

Clinical Outfitting Furniture
Call for details



Stainless Steel Cabinetry

For more information contact your Birkova Representative

Clinical Outfitting

Cushions

Armboards

Roller Board

Clark Sockets

Patient Restraints

Stretcher Pads

Leg Stirrups

Custom Pads

Cart Covers

Ortho Boots

Sand Bags

Leg Holders

Vinyl Pillows

Solution Stands

Custom Positioners

S.S. Instrument Tables

Warming Cabinets

and more . . .



©2010 Birkova Products, LLC. All Rights Reserved.
Specifications, availability and pricing subject to change without notice.
Printed in USA.

DISTRIBUTED BY:



BIRKOVA PRODUCTS, LLC.
Call for your local distributor
1.888.567.4502
or (308)537-7300