

Medical Imaging Reading Environment Optimization; A Planning Guide

Table of Contents

INTRODUCTION	3
HISTORICAL PERSPECTIVE	4
FUNDAMENTAL DESIGN GOALS	5
READING ENVIRONMENT GOALS	6
Ergonomics	6
Seating	6
Input Devices	6
Work Surfaces	6
Display Management	7
Acoustics	7
Lighting	8
Environmental Control	9
Finishes	9
Layout and Location	9
READING ROOM DESIGN GUIDELINES	11
Primary Zone	12
Seating	12
Sit/Stand Workstation	13
Monitor Management	13
Input Devices	13
Task Lighting	13
Secondary Zone	14
Sit/Stand Workstation	14
Ambient Workstation Backlighting	15
Acoustics	15
Climate Control	15
Tertiary Zone	16
Room Finishes	16
Acoustics	16
Ambient Room Lighting	17
Climate Control	17
Flow and Layout	18
Access	18
Room Location	18
Additional Guidance for Specialty Reading Environments	19
Additional Academic Institution Design Guidelines	19
Special note about remote teleradiology reading only	19
WHAT WILL THE FUTURE HOLD FOR READING ROOM DESIGN?	20
APPENDIX A: READING ROOM OPTIMIZATION PLANNING CHECKLIST	22

Introduction

This document is intended to provide detailed guidance to architects, designers, facilities planners and clinical department personnel involved in the planning, design and improvement of medical imaging reading room environments. It has been prepared to address the scarcity of practical, educational guidance for medical imaging reading room optimization based upon best-practices and the needs of healthcare providers.

Furthermore, this document addresses the range of ways good design and siting can help improve the practice of radiology, by applying good ergonomic principles, to eliminate repetitive motion injuries. Proper location can significantly enhance communication between radiologists and the many clinicians they service. This leads to improved quality of care and customer service, both of which can increase the long-term value of radiology.

Good environmental and space design ensures that reading rooms support the operational, clinical and educational needs of the department, while minimizing distractions and providing a comfortable working environment. This document includes practical guidance about the many ways ergonomics, design and siting can be optimized to minimize the risk of repetitive motion injuries, minimize fatigue and maximize radiology department productivity. It also offers a vision of radiology reading room design and the factors that may impact the practice of medical imaging in the future.

Historical Perspective

Beginning in the early 2000's, Picture Archiving and Communication Systems (PACS) and Voice Recognition (VR) adoption drastically impacted the design of medical imaging reading environments. Since then, the importance of ergonomic and design considerations that maximize productivity and reduce repetitive motion injuries have been established and studied in great detail.

Ergonomic issues became more prominent during the past decade following the introduction of new digital imaging technologies into the radiologist's workplace. Today, radiologists spend the majority of their time sitting, reviewing and reporting on thousands of patient images, resulting in a very sedentary workplace environment.

During the early part of the decade – approximately 2001-2006 – most healthcare enterprises implemented first generation PACS. At that time, most radiologists, hospital administrators, equipment planners and architects did not heed a handful of pioneering radiologists and healthcare

architects who proclaimed that there was more to be considered with this new reading paradigm.

As the first PACS systems were installed, it quickly became apparent that PACS did more than simply eliminate film. A new set of workflow practices and processes needed to be developed. Furniture used in the initial implementations was not optimized for ergonomics or space. In response, several manufacturers emerged to develop customized ergonomic workstations to meet the specific needs of radiology reading rooms.

In 1998, when the University of California Los Angeles (UCLA) began to design a new filmless and paperless hospital, Osman Ratib, MD, PhD, took the opportunity to reengineer radiology working spaces. Ratib revealed his full size

prototype in an InfoRAD exhibit at the 2001 Radiological Society of North America (RSNA) Annual Meeting. Rudimentary ergonomic furniture systems were developed, implemented and adopted with varying degrees of success. For the most part, sit-stand desks and adjustable ergonomic chairs became the norm as a "sufficient ergonomic solution," with a slide away keyboard tray thrown in for good measure. As time passed, it became apparent that the ability to adjust the height of a radiologist's work surface, while somewhat beneficial, was a basic and incomplete solution. A complete solution requires additional considerations that encompass not only equipment/furniture adjustments and features, but also, more complex environmental factors.

This guide will begin with a review of design goals for all aspects of the reading room environment and then provide specific implementation guidance for each area. The goals presented are minimum standards and requirements for today's reading room environments. At the end of this document we discuss the potential impact of future trends on reading environment design.

Fundamental Design Goals

As PACS and imaging IT systems have matured and their adoption has become universal, reading room design requirements have shifted from supporting technology to supporting the evolving role of radiology in our changing healthcare system. While the conversion from film to digital drove most reading room design and location decisions early on, there is clearly an opportunity to leverage reading room design and location to help radiology and medical imaging solidify its role in the future of healthcare. Organizations considering the redesign of their reading environments will need to anticipate future requirements, while addressing current needs.

These 4 common themes will be addressed by the recommendations in this document:

- a. Physician productivity
- b. Interpretative accuracy
- c. Radiologist health and safety
- d. Communication between the radiologist, referring physicians and patients

Reading Environment Goals

Ergonomics

Eliminating repetitive motion injuries should be the primary goal of any reading environment optimization effort. Radiologists in particular have been found to be at high risk of neck, back, shoulder and wrist injuries. These risks increase over time and can significantly impact physician productivity, personal health and diagnostic accuracy.

Ergonomic input devices, seating surfaces and furniture are broadly available and should be utilized where possible to ensure physicians have flexible, customized and comfortable physical work environments. It is also important to extend proper ergonomic design throughout the entire reading environment to minimize visual fatigue and aural distractions.

Training in the proper use and adjustment of all ergonomic equipment and design features should be included in any reading environment optimization effort, to ensure their benefits are realized. Healthcare organizations are advised to leverage in-house or external ergonomics and physical therapy professionals to ensure staff behavioral changes occur that enable full realization of the benefits of the ergonomic design efforts.

Seating

Arguably, seating is one of the most critical components of proper ergonomics and comfort. Since no single seat is optimal for everyone, it should be determined early on how many different styles of seats will be provided. Seats must be fully adjustable to accommodate individuals of different heights and body types. Cost should not be the determining factor, as proper seating is expensive. Prior to making purchases, different seats should be tested by each individual involved. Regardless of the types of seats purchased, alternating positions from sitting to

standing is the best way to avoid back pain and other discomforts due to sitting for extended periods.

Input Devices

While adoption of ergonomic mice and keyboards is important, radiologist adoption of voice recognition has made the speech microphone the primary input device. Use of hands-free devices, including headsets, should be considered.

Work Surfaces

Work surface designs (desktops) need to provide sufficient depth to allow horizontal re-positioning of monitors for optimal viewing by multiple users, in both sitting and standing positions. There must also be enough depth and width for books and support materials, particularly in academic environments. Space should allow for 2 or 3 people to sit around the displays to view images and discuss findings.

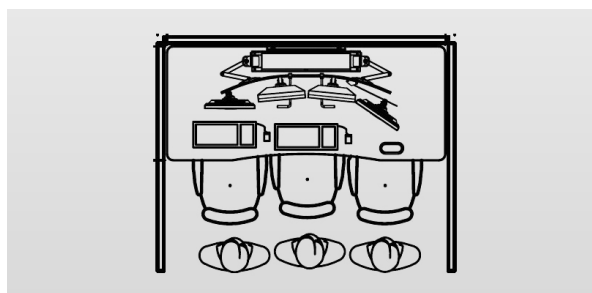

Adequate space for 2-3 people



Horizontal monitor adjustment

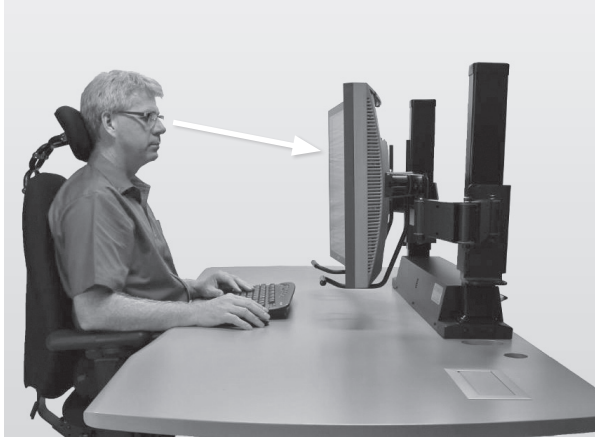

Monitors viewed at a slight downward angle

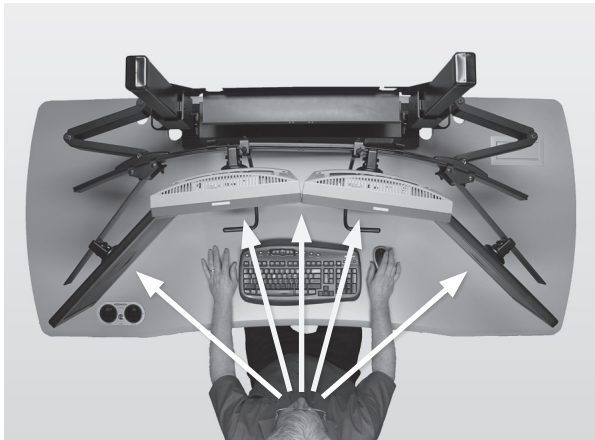

Semi-circle to ensure equidistant from user's eyes

Display Management

Displays should be height adjustable in relation to the main work/input device surface to ensure they are viewed at a slight downward angle. To minimize eye fatigue and strain, additional adjustments and placement in the horizontal plane (forward/backward, side-to-side) are required to ensure monitors are approximately 24 inches away from the viewer's eye. Monitors should also be easily adjustable, preferably with one hand, and must remain solidly in place once adjusted. They should be arranged in a single row and in a semi-circle to ensure all are equidistant from the viewer's eyes. To further relax the eyes and reduce eye strain, radiologists should be trained to look at an object 20 feet from their displays, every 20 minutes, for 20 seconds.

Acoustics

Acoustic issues are most prevalent in shared reading environments. Shared reading room environments are most common in large teaching hospitals but are not uncommon in smaller community based hospitals. Many radiologists approve of the collaborative opportunities supported by this type of environment. Meanwhile, diagnostic imaging managers have taken advantage of the space freed by vacated (and no longer required) film libraries to create reading rooms conducive to today's digital workflow and desire for increased clinical collaboration.

A balance must be achieved between an environment that is neither too noisy, nor one that is too quiet. In a space that is too quiet, the human voice can become a significant distraction. The goal must be maintenance of a consistently low level of ambient or white noise. The advent of voice recognition (VR) software has

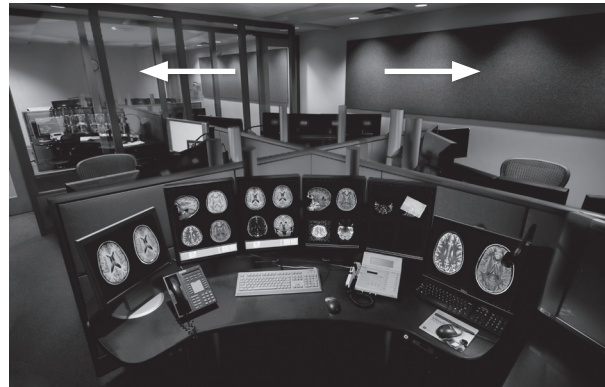

Sound absorbing panels; Acoustical separation using glazing



Acoustical wall treatment and partitioning

driven much of the discussion related to noise levels in reading rooms. VR technology has improved over the past decade and its ability to compensate for ambient noise levels is rather good and normally sufficient. Inconsistencies in noise levels throughout the day, however, can have an effect on VR accuracy. Poor acoustics can adversely affect both the performance of the software as well as the performance of the radiologist. Reading room design needs to minimize noise resulting from radiologist dictations, as well as personal and professional conversations. Additionally, many other ambient sound pollutants, such as HVAC and computer fan noise, ringing phones (landline and cellular) all need to be considered and minimized in the final design.

A combination of passive noise reduction methods (i.e. acoustical treatments on walls, ceilings and floors) and active noise cancellation options are now more affordable and should be utilized.

Lighting

Early studies, indicated conclusively that ambient lighting levels in the reading room, as well as light fixture placement (indirect lighting), were critical to maximize productivity and interpretive accuracy. Ambient lighting intensity must equal monitor illumination intensity in order to reduce eye fatigue. In general, lighting design should aim to minimize eye strain and associated fatigue, and maximize visual acuity and the ability to appreciate small contrast differences in the images. To achieve this, light intensity should be controllable at both the room level and at the individual radiologist reading station level. Furthermore, lighting must accommodate multiple purposes: viewing desktop papers, viewing images on monitors, ensuring people can be seen across the room, and ensuring people can walk safely and avoid obstacles. The location of lighting controls and fixture wiring is increasingly important in shared rooms with multiple workstations. To minimize interference between areas with different needs, reading rooms

need to fine-tune the location of lighting controls and fixture wiring. It is also important to ensure that utility lighting, only needed when cleaning and service personnel are in the facility, can be turned off during normal business hours. Pathway lighting should be focused on illuminating the pathways to and from access doors without interfering with the controlled ambient light within primary reading areas.



Traffic pathway lighting

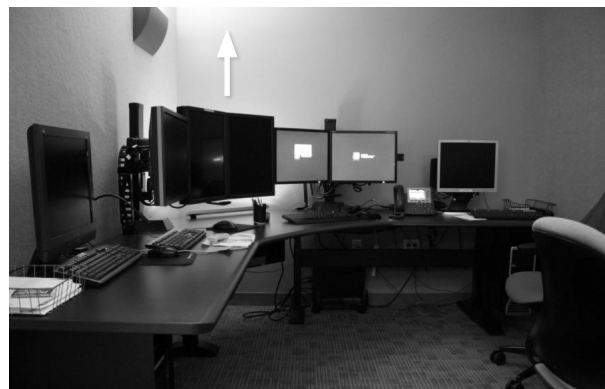

Ambient workstation backlighting

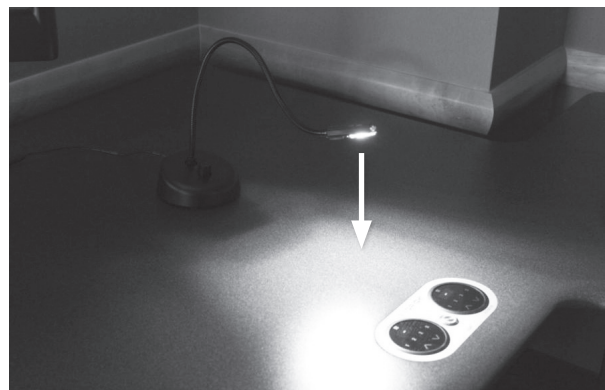

Task lighting

Environmental Control

The introduction of multiple monitors, CPU's, dictation equipment and other heat generating electronic devices requires paying special attention to the design of the air conditioning system. Reading room HVAC must be dedicated and highly adjustable to ensure that personal preferences can be met. Controls should be available for the overall room common spaces but should be adjustable in individual reading areas. Airflow should also be adjustable.

Studies show radiologist productivity is affected by room temperature and users are more productive in cooler rooms. The optimal temperature is approximately 72 degrees Fahrenheit.

Ideal personalized ventilation controls should allow users to increase or decrease temperature, as well as manage airflow in their immediate area. Temperature controls should be individual for each reading room.

Finishes

All finish materials (flooring, ceiling and walls) should be sound and light absorbing. The use of carpeting, sound absorbing ceiling tiles and acoustical wall panels is suggested. Where carpeting may not be allowed due to infection control criteria, use of alternative flooring materials such as recycled rubber can provide both acoustical properties as well as easy cleaning.

Painted surfaces should be neutral and non-reflective; a matte finish is recommended.

Layout and Location

Location and layout should reinforce the room's purpose. Does it serve general or subspecialty reading needs? Does the department support unique teaching and research needs for the rest of the institution? Layout should group individuals, who need to communicate with each other, more closely (i.e. radiologists in a specific subspecialty). Similarly, radiologists who read the same specialty should

be grouped closely in order to facilitate efficient communication.

The reading room design should ensure that staff and clinicians are able to find a specific radiologist or reading zone with the least amount of disruption or distraction to others within the environment.

Academic facilities should make accommodations for groups of residents and fellows to enter and exit the room with minimal disruption. Corridors and entryways should be sufficiently wide and deep to prevent groups of individuals from congregating adjacent to individual reading areas. Academic reading rooms should be sectioned and organized by body part; Neuro, Chest/Cardiac, MSK, and Body. Within each section, a separate area should be created for teaching where 6-8 people can comfortably gather to review and discuss cases. These areas should be separated acoustically while maintaining a visual presence. The use of glass in both doors and partitions is appropriate. These teaching rooms should be placed near main entrances to minimize groups of individuals walking through the entire reading area.

Furthermore, room location can facilitate efficient communications by minimizing the distance between the reading room, technologists and referring physicians. Distances that physicians and technologists must walk to meet in person should be minimized. Consideration should be made to embed certain subspecialty reading rooms in the appropriate clinical area, as a means of facilitating face-to-face communications between the radiologist and the subspecialty physician. Efficient communications ensures productivity is maintained while customer service is enhanced. The need to facilitate radiologist/patient consultations should be discussed, and if embraced, an appropriate space should be considered near the patient waiting area. The rooms should be clearly identified and made welcoming, to the appropriate individuals, to balance the radiologist need for productivity and visibility.

The future needs of the department should also be taken into account, as any new reading environments should support the department's needs for the next 5-7 years. Coordinating departmental goals with the institutions strategic plans can ensure this is the case. Factors such as imaging consolidation, patient centered care, and personalized medicine are likely to affect the practice of radiology, over the next 10 years. Continued technology consolidation and image enablement of the EHR will impact technologies that may need to be supported in a reading environment. The importance of proximity will likely increase in importance as radiology is encouraged to be an integral part of the care team, and imaging continues to be recognized as a valuable diagnostic tool.

In addition to addressing these needs, academic facilities should accommodate the need for staff rounds to come to the reading room to view cases and meeting with radiologists. Overall, the additional reading room traffic must be anticipated and accounted for in room design, to minimize distractions and disruptions to radiologists, when they are not involved in teaching activities, or providing consultations. Individual reading areas should also provide sufficient space for three or four individuals to meet around a PACS workstation. A dedicated teaching/conference room should be developed that supports the teaching requirements and methods of the institution. This room should include projection equipment connected to PACS and to mobile devices, to enable sharing, viewing and open discussion of cases.

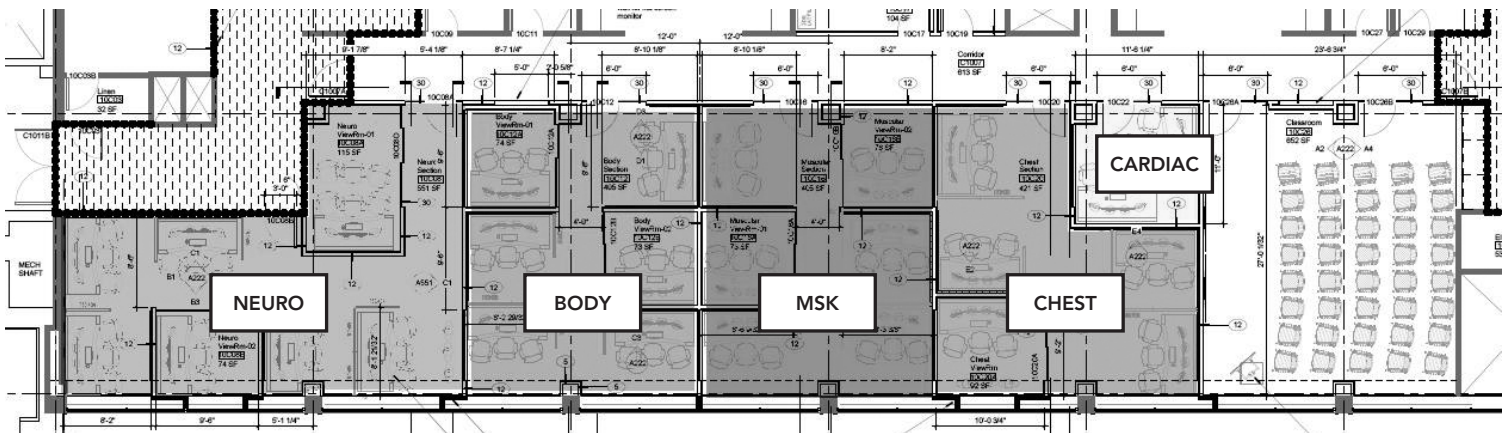

Academic Reading room, OHSU Portland, OR (Courtesy SRG Partnership Inc.)

Reading Room Design Guidelines

This section provides specific design guidelines and recommendations that will help meet the goals suggested in the previous section. Guidance is broken down according to the following reading environment zones:

1

PRIMARY ZONE

This is the work zone immediately in front of the radiologist where he or she interacts with the primary viewing technologies, including monitors and input devices. This is the area that is most impacted by ergonomics.

2

SECONDARY ZONE

This zone is immediately outside the primary zone, yet still the area immediately surrounding the radiologist. The key environmental issues in this zone include organizational factors such as clutter control, paper and cable management. This zone primarily is impacted by convenience, environmental control, safety and security.

3

TERTIARY ZONE

This zone is immediately outside the secondary zone and encompasses the remaining aspects of the entire reading environment as well as location of the reading environment.

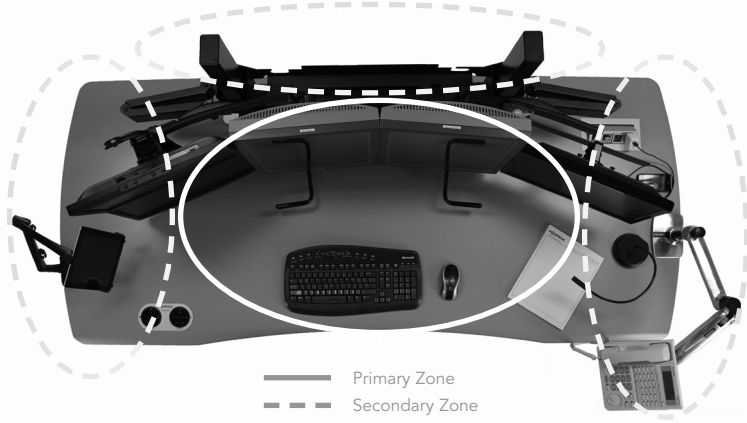

1

PRIMARY ZONE

The design guidelines in this zone are intended to optimize ergonomics and productivity.

Optimal design will eliminate repetitive strain disorders (RSDs) resulting from the need to interpret large volumes of data over extended periods of time in a sedentary work environment.

Proper ergonomics will minimize visual and physical fatigue, while lowering the risk of repetitive strain disorder or injury. “Best practices” include task variation, alternating sitting and standing several times a day, as well as looking at least 20 feet away from the displays, for 20 seconds, after 20 minutes. Given the absence of a governing body that monitors the claims of ergonomic furniture manufacturers, it is important to leverage the expertise of your institution’s ergonomics expert, or take the time to research ergonomics claims on the Internet.

Optimizing the reading environment to reduce unwanted distractions allows physicians to focus on interpreting and dictating studies, and providing required physician/patient consultations, thereby improving their productivity. The design of the workstation and the immediate surroundings can significantly reduce unwanted distractions.

Design guidelines for the Primary Zone:

Seating

- Seats should be fully adjustable and move with the individual to encourage good posture. Additionally, they must include head and neck support, as well as back and arm support.
- Headrests should be adjustable independently for height, as well as forward and backward position.
- Lumbar supports should provide both in and out, as well as up and down adjustability to accommodate various body types.
- Seat pans should have the ability to slide forward or backward in relation to the seat back to provide optimal support for upper legs.
- Chair arm design should allow for height and width adjustment.
- Chair arms must be robust in order to withstand constant force from arms supporting dictation devices.
- Multiple seating options should be provided, as no one seat is optimal for everyone.
- Most importantly, the seat must be properly adjusted for each individual. Training should be provided to ensure this is the case.
- A routine of alternating between sitting and standing throughout the day should be adopted.

Sit/Stand Workstation

- Workstations should support the weight of PACS systems, which can include multiple CPUs, as well as four or more medical grade monitors.
- The design needs to be flexible to suit the available space within the reading room and accommodate variations in workflow.
- To minimize distraction, the work surface should be made from a non-reflective (matte finish) material, neutral in color and hue.
- The front edge of the work surface should be rounded or sloped to minimize any forearm pressure points. Ideally, this should be achieved without the use of applied edging materials that can create crevices that are hard to clean and disinfect.
- The main work area should be a single surface that is not split or divided. This provides much more flexibility and allows task variation while keeping distractions to a minimum.
- The size of the work surface should be large enough to accommodate the daily tools of the radiologist and fit two or more specialists, residents or fellows who may need to review cases together.
- The surface should be curved to encircle the reader and optimize the use of available space in the Secondary Zone.
- The entire workstation should be height adjustable to facilitate sitting and standing, while maintaining proper ergonomics for individuals of all heights.

Monitor Management

- The workstation must provide the ability to adjust the monitors in the vertical, horizontal and lateral planes relative to a radiologist's eyes. To minimize eye strain, all monitors should be 18" - 24" away, and should be viewed downward at a 14-degree angle.

- All adjustments must be easy and quick to perform, preferably with one hand, to ensure proper adjustments are made and the ergonomic benefits are realized.
- The tilt or angle of the monitor, as well as the radius of the monitor array, must ensure all monitors are the same distance from a radiologist's eyes and support preferences to sit, stand, or (slightly) recline.
- The monitor mounting solution must be robust enough to securely hold the monitors in place once adjustments have been made.

Input Devices

- Ergonomic keyboards and mice should be used to avoid injury caused from wrist deviation.
- Alternative input and navigation devices such as programmable mice and devices like the "Shuttle Pro" can speed navigation and eliminate repetitive strain.
- Roller mice and left hand devices should also be explored to minimize repetitive mouse clicks with the same hand.
- Hands free devices should be adopted, particularly headsets used for dictation and/or talking on the phone.

Task Lighting

- Individually adjustable task lighting should be incorporated into each reading workstation to illuminate items on the desktop yet not create glare on the monitor.
- The task light should be on an adjustable gooseneck.
- (White) light should be on a dimmer that is controlled by the user, allowing the user's eyes to adjust to lower ambient light intensity.

2

SECONDARY ZONE

The design guidelines in this zone are primarily intended to optimize productivity and reduce fatigue. Although most radiology workflow is completely paperless, there will always be personal and business items on top of a desk. This may include supporting clinical documents, telephones, resource materials, printers or personal items such as cell phones, tablets or laptop computers. Whatever the source or reason for these items, they should be organized to avoid clutter which impedes ergonomics and creates distractions. Similarly, cables from computer systems or peripheral devices can clutter a space, be distracting and interfere with the adjustability of a workstation.

Lighting, acoustics and climate control guidelines in the Secondary Zone can be applied to the Tertiary Zone. This is because these zones are typically contiguous with each other, except in situations where individual reading areas can be cordoned off.

In a teaching environment the Secondary Zone should accommodate the needs of two or three additional people at each workstation. The desktop configuration needs to provide ample space for sitting or standing while viewing images on the monitors, as well as viewing books or papers on the desktop.

Design guidelines for the Secondary Zone:

Sit/Stand Workstation

- Space permitting, spread out the work surface beyond the Primary Zone to accommodate peripheral materials, such as documents, resources and device management. In the case of a teaching environment, the desktop design should easily accommodate at least a second person, if not a third.
- Extra desktop power outlets and USB ports should be provided to help organize personal cell phones and tablets, as well as enable efficient connection to local computers and printers.
- A telephone support arm that allows a radiologist to position the telephone in the most convenient location also frees-up valuable desk space.
- Personal tablet management and security should be addressed by providing locking drawers with charging capabilities, as well as desktop locking supports.
- Local storage of necessary office supplies, such as pens, pencils, paper clips, should be provided to avoid clutter and ensure supplies are easily found.
- Shelving and lockable storage for personal items and resource materials should be provided.
- When there is a requirement for a high frequency of interaction between the patient and the radiologist, the workstation should be designed to allow easy viewing of the images by all parties.

Ambient Workstation Backlighting

- All ambient lighting used during business hours should be indirect and the intensity should be adjustable, to match the brightness of the PACS monitors. This has been shown to support optimal productivity and reduce eye fatigue.
- Each individual reading location should include a dimmable light that illuminates the visual field behind and surrounding the PACS monitors. The optimum location for this light source is behind and below the monitor array.
- Where possible, blue ambient light should be used to minimize eye fatigue.

Acoustics

- Attempts should be made to divide individual reading areas using moveable panels with sound absorbing and sound blocking properties.
- All reading areas should be outfitted with acoustic ceiling and wall treatments.
- Care should be taken to ensure the HVAC system does not generate excessive noise when operating. Active and passive acoustic controls designed for the Tertiary Zone should extend into the Secondary Zone since they are contiguous spaces. This ensures disruptions and distractions are minimized.
- Special care should be taken to select landline phone ringers that are not too piercing or loud. Similar care should be taken for in-house IP phones that staff may be required to wear.
- Educate staff about putting personal cell phones on vibrate, or turning down ringer volume, when bringing personal cell phones into the reading room.
- Accommodations should be made to enable reading room visitors to have conversations with staff without creating a disruption. Providing ample space for two

or three people to meet, at each reading station, eliminates groups congregating in common areas. Creating the ability to close off these areas, or providing separate common consultation rooms can further help.

Climate Control

- Temperature and fan speed in each reading area should be individually controlled.
- Temperature should be maintained between 72 and 75 degrees Fahrenheit, as this has been shown to be optimal for most people, and conducive to productivity and comfort.
- Additionally, adjustable table level ventilation should be made available.
- Ceiling diffusers must be placed in such a way that reading stations are not located directly in the path of the high velocity airflow. Furthermore, the use of directionally adjustable ceiling diffusers is highly recommended to minimize noise from airflow and ensure uniform temperature control.

3

TERTIARY ZONE

This is, perhaps, the area of the reading room that has been overlooked the most. Over the past decade, much more attention was paid to the Primary and Secondary Zones, since the greatest “pain” was experienced in these areas. Over the last several years, the challenges in the Primary and Secondary Zones have received the greatest attention by researchers and design consultants.

Increasingly, thought leaders and researchers realize attention must be focused on the Tertiary Zone in order to increase customer service, communications and productivity in response to the evolving healthcare system. This is true within both academic and non-academic radiology departments.

General reading environments and specialty reading rooms benefit from similar guidance. Since specialty rooms typically are much smaller, support one or two people, and are embedded in the clinical specialty area, they benefit from additional specific guidance, which is provided later in this document.

Design guidelines for the Tertiary Zone:

Room Finishes

- Walls and partitions should be finished with neutral colors that harmonize with the use of either blue or white ambient light systems. When using white ambient light, colors in the blue or blue-grey hue are advisable. A flat or matte finish will reduce unwanted reflections that cause visual fatigue and eye-strain.
- Where possible, sound absorbing wall and ceiling surfaces should be employed, to reduce ambient noise. Acoustical ceiling tiles can be upgraded to a high NRC (Noise Reduction Coefficient) rating that will absorb sound, reducing distracting reverberations.
- Floor finishes should be appropriate for high traffic, use of chairs, standing for prolonged periods and sound absorbing. Carpet is often the choice of facilities to provide these features but can be difficult to keep clean and dust-free. Newer sheet flooring products are available in materials such as recycled rubber that can provide a cushioned support for standing, easy cleaning and sound absorption that contributes to the acoustical optimization of the reading room.

Acoustics

- To minimize noise from outside the reading room, ensure that common exterior walls are well insulated.
- Install an active sound masking system with controls located inside the reading

area. Control over this system should be limited to a single individual, probably at the facilities level.

- Consider the proximity of entry points (doors) in relation to individual reading areas and meeting rooms. Doors should not be immediately adjacent to individual staff.
- Use sound absorbing finish materials on the walls, ceilings and floors, where possible – high NRC acoustical ceiling tiles, carpet on floor, acoustical partitioning and floor to ceiling partitioning, where necessary, to divide collaborative zones from production zones. Sound absorbing surface material could be artfully designed too!
- Doors should shut automatically but slowly enough so as not to make a loud noise when they latch. In high traffic reading rooms designers and facilities managers should specify door hardware and locking mechanisms that are not excessively noisy when latching or avoid the use of latching mechanisms altogether where fire regulations allow.
- Partition walls between workstations should be slightly angled to deflect sound and reduce reverberation. They should also be made of sound absorbing material.
- Disconnect overhead paging systems and alarms in reading areas if local codes allow. Alarm systems are available with flashing light indicators as alternatives to bells or alarms.

Ambient Room Lighting

- During business hours, the reading environment should not be illuminated with direct down-pointing overhead or fluorescent lighting. This type of lighting should only be used to enable personnel to clean the room after business hours.
- Dimmable pot lights with non-reflective cans should be used to illuminate pathways. They should not be

used over or near diagnostic reading stations, as they will cause glare and reflection on the monitors.

- Low level, indirect LED lighting along walls and partitions is recommended in order to maintain a minimal level of illumination that allows obstacles to be seen.
- Doors should be positioned so that light from outside the room does not penetrate the reading environment and cause glare on the monitors.

Climate Control

- In designing the HVAC system, consider the length of ductwork from fan units to ceiling diffusers. And, if necessary, internally insulate and coil short duct runs to absorb the fan noise. Noise from fans starting and stopping coupled with unbalanced and noisy diffusers can create inconsistencies that may affect VR accuracy.
- The HVAC system should be dedicated to the reading environment, and temperature and fan controls should only be inside the reading environment.
- Temperature should be maintained between 72 and 75 degrees Fahrenheit, as this has been shown to be optimal for most people, and conducive to productivity and comfort.
- Ceiling diffusers should be carefully placed to minimize noise and drafts, while ensuring good airflow and temperature control.
- Consult with a professional mechanical engineer.

Flow and Layout

- Partitions between workstations should be slightly angled to deflect sound and reduce reverberation. They should also be made of sound absorbing material.

- Avoid doors with windows. They will transmit unwanted sound and light from adjacent spaces. Where glass is a requirement, consider applying a tinted film to reduce the amount of light transmitted.
- Position common rooms, for consultations and teaching, near the main entrance to minimize traffic through the main reading area.
- If possible, station a person near the access point to receive and manage calls and visitors.
- Do not position the radiologist's back to incoming traffic as this can result in monitor glare, cause unnecessary disruption, and make it more difficult for visitors to identify a specific individual without interrupting more than one person.

Access

- Doors should not be locked from the outside. Preferably, doors should not be locked at all.
- There should be only one point of visitor access to a reading area.
- If the door is locked from the outside, there should be a buzzer that opens the door.

Room Location

- General reading rooms should be placed centrally in the radiology department, to facilitate efficient communications between radiologists, technologists, specialty physicians and patients.
- Consideration should be made to locate specialty reading rooms, such as women's imaging, musculoskeletal imaging or interventional radiology and nuclear medicine in or adjacent to the subspecialty physicians, imaging modalities and clinical services they support.
- Account for hospital-wide initiatives to consolidate multidisciplinary care providers by including radiology in the planning and siting.
- Place the reading room entrance near waiting areas so patient/radiologist communications can be efficient for both parties.

ADDITIONAL GUIDANCE FOR SPECIALTY READING ENVIRONMENTS

- All sub-specialty rooms should follow the same guidance proposed above, for the Primary, Secondary and Tertiary Zones.
- Additional guidance will depend upon how many physicians work in a given room and how likely the room is to be frequented by patients.
- If a single radiologists will work from the room, yet patients will routinely require consultation, a special table and chairs may be included in the reading area to accommodate this need.
- Additional consideration should be given to the wall and floor coverings to ensure the room presents nicely to patients.

ADDITIONAL ACADEMIC INSTITUTION DESIGN GUIDELINES

In addition to the guidance provided above, academic facilities should incorporate the following guidance:

- Entryways, hallways and common meeting areas should be wider and larger to accommodate groups of 10-15 people, depending on rounds and radiology teaching methods.
- Additional standing and sitting space is required in individual diagnostic reading areas, particularly for those specialty reading areas where teaching may occur.
- Leverage large, intelligent wall surfaces that can interact with users mobile devices in real time for dedicated teaching rooms (teaching, annotations, etc.).
- Ensure there is sufficient Wi-Fi coverage and bandwidth to accommodate large groups of individuals congregating in a single area with their mobile devices.
- Consider providing a common area for residents and fellows to research, study and meet. This space should be near the reading room entrance to ensure radiologists are not interrupted by the comings-and-goings of these individuals.
- Because collaboration, open interaction and specialization often have greater importance in academic environments, consideration should be made for grouping reading, teaching and study spaces around individual subspecialties.

Special note about remote teleradiology reading only

Rooms that support remote teleradiology only and are not located in a healthcare provider facility will have unique needs. They should follow the design guidance for the Primary and Secondary Zones to maximize physician productivity and reduce distractions. Tertiary Zone guidance for reading room location, access and flow will likely not be relevant. Because only radiologists will use these environments, accommodating for disruptions from other sources will not be necessary. Of course, time should be taken to ensure that noise from outside the facility or building does not cause a distraction.

What will the future hold for reading room design?

Predicting the future of healthcare is outside the scope of this document. However, it is expected that ongoing consolidation of imaging IT systems, the development of increasingly powerful software and hardware, and the need to reduce healthcare costs will continue impacting how and where healthcare is delivered.

We should challenge ourselves to ensure that reading room design responds to the following industry pressures:

Technological advances

- How will advances in mobile technologies and our increasing acceptance of completing tasks using mobile technology affect workflow processes?
- Will the ongoing convergence of enterprise imaging technology require added flexibility in today's reading room designs?
- Will the concept of a centralized reading room remain relevant?

Reimbursement and cost factors

- How will accountable-care and new value-based reimbursement models impact the priorities of radiology? What will be the impact of reduced fee-for-service reimbursement?
- In an effort to reduce costs, will reading rooms continue to shift to spaces outside costly hospital environments?

Evolving practice of healthcare

- How will the concept of personalized medicine evolve and impact imaging?

- What modifications will new processes that reduce fragmentation and increase work efficiency require?
- Will the trend towards increased specialization reverse or continue?
- Will the new "Intelligent Patient Model" require larger rooms to accommodate multidisciplinary teams dealing with personalized medicine?

The answers to these questions will significantly alter the design requirements of future reading rooms and may eliminate their need altogether.

While the current model has many imaging specialties with their own departmental reading areas, with separate imaging IT systems, for many reasons this stems from political turf issues and not from an assessment of what provides the best care. In many cases this configuration results in significant

inefficiencies. Perhaps, as enterprise imaging concepts evolve, and imaging is increasingly integrated into the clinical care continuum there will be good reason to consolidate all reading into a single area. Or, perhaps, embed all subspecialties directly into the relevant clinical care. Or, perhaps, we may eliminate dedicated reading rooms altogether.

As Dr. Osman Ratib, currently at the University Hospital of Geneva suggests, we need to think about two contradictory business and workflow models: mass reading of routine radiological cases, on one hand, and specialized experts consulting in a multi-disciplinary approach to image interpretation, on the other. The “radiology factory” with high throughput is the industrial version of a cost effective and highly lucrative practice of radiology. The second model is what we believe radiology will be in the future: integrated within the clinical management environment.

In our opinion, the dedicated radiology reading rooms we know today will evolve into spaces where clinicians do more than simply interpret radiology information. They will be spaces where interdisciplinary clinical care teams collaborate around the idea of all-encompassing intelligent patient models.

These models will be complete digital representations of each person that contain all clinical information available for that individual. In this scenario, could an “intelligent patient model room” replace the radiology reading room?

Some of the above questions point to technology changes that may

affect space demands on reading environments, while others will result in behavioural changes that will affect siting and design. Inevitably, academic institutions will consider the impact of these forces earlier than non-academic, community and private practice institutions. We will continue to revisit these questions in subsequent iterations of this document.

Appendix A:

Reading Room Optimization Planning Checklist

Use this checklist to identify and track reading room improvements, as they are planned and implemented.

- Reference the appropriate sections in this planning guide for detailed guidance.
- Print this checklist and use it as a project management tool.

PRIMARY ZONE

See page 12 of the planning guide for detailed information about the Primary Zone.

Seating

- Identify adequacy of existing seating.
- Ensure staff is educated about proper adjustment of existing chairs.

Sit/Stand Workstation

- Identify factors currently limiting the adequacy of existing workstations.
- Document requirements for new workstations, including size requirements.

Monitor Management

- Confirm the current standard monitor configuration and potential future changes.
- Confirm the ability of current radiologist workstations to adequately provide adjustment of the required monitor configuration.

Input Devices

- Identify the need for ergonomics mice, keyboards and speech recognition microphones.

Task Lighting

- Quantify the prevalence of task lighting on existing workstations.
- Understand the need to illuminate workstation desktop documents.

SECONDARY ZONE

See page 14 of the planning guide for detailed information about the Secondary Zone.

Sit/Stand Workstation

- Identify storage and shelving needs at each radiologist workstation.
- Assess how many people need to be accommodated at each radiologist workstation.

Ambient Workstation Backlighting

- Ensure workstation backlighting is implemented and can be individually adjusted to match the medical display brightness.

Acoustics

- Understand the impact of personal electronics, phone ringers, and human conversation on overall reading room noise.
- Assess opportunities to improve the sound attenuating effectiveness of the reading room ceiling tiles, wall and flooring material.

Climate Control

- Quantify the ability of the current reading room heating and ventilation system to quietly maintain the proper room temperature and provide fresh air for all who use the reading room.

TERTIARY ZONE

See page 16 of the planning guide for detailed information about the Tertiary Zone.

Room Finishes

- Identify whether the reading room wall color should be changed to reduce reflections.
- Determine whether sound absorbing material can be installed on the existing wall surfaces and if ceiling tiles can be replaced with more sound deadening materials.

Acoustics

- Investigate the cost and benefit of an active noise cancellation system.
- Identify noise contributions from reading room ingress/egress and other functions performed in the reading room that may contribute to unnecessary noise.

Ambient Room Lighting

- Observe issues with current reading room lighting and whether improvements require changing the location and type of lighting or smaller improvements in types of bulbs and light switches used.
- Identify the need to train personnel on optimal lighting and creation of a policy that ensures optimal reading room lighting is maintained.

Climate Control

- Collaborate with HVAC professionals at the facility to identify opportunities to reduce noise and drafts from the air handling system.

Flow and Layout

- Perform a workflow assessment to understand foot traffic patterns in the entire reading room to identify where and why people congregate in the reading room.
- Identify opportunities to reduce unwanted distraction and noise from reading room visitors.

Room Access

- Develop a reading room access strategy that ensures the reading room is a welcoming environment to those who should interact with Radiologists.

Room Location

- Build consensus among facilities and clinical department management on the opportunities and benefits of relocating reading rooms centrally and closer to the subspecialty physicians who use radiology services.



RedRICK Technologies
21624 Adelaide Road
Mount Brydges, Ontario N0L 1W0
Canada
www.redricktechnologies.com
info@redricktechnologies.com
1-800-340-9511

CANNONDESIGN

CannonDesign
1901 Avenue of the Stars, Suite 175
Los Angeles, California 90067
United States
www.cannondesign.com
info@cannondesign.com
310-229-2761