

# ECHO

## **Medical supplies and equipment for primary health care**

A practical resource  
for procurement and  
management

by **Manjit Kaur and Sarah Hall**  
Editor **Kathy Attawell**

Drugs, medical supplies and equipment have a significant impact on the quality of patient care and account for a high proportion of health care costs. Health services need to make informed choices about what to buy in order to meet priority health needs and avoid wasting limited resources.

Many organisations have produced useful information about essential drugs, but less information is available about essential medical supplies and equipment. Despite the fact that there is a much wider range of different brands and items to choose from, selecting supplies and equipment is often given little attention. This often results in procurement of items that are inappropriate because they are technically unsuitable, incompatible with existing equipment, spare parts and consumables are not available, or because staff have not been trained to use them.

Procurement is only one part of managing medical supplies and equipment, and effective storage, stock control, care and maintenance are also critical if health services are to get the most out of what they buy. However, there is also limited information available about these aspects of management of medical supplies and equipment.

To address this situation, ECHO has produced *Medical supplies and equipment for primary health care*. The manual is intended to be a practical resource for those responsible for procurement and management of medical supplies and equipment at primary health care level. It includes guiding principles for selecting supplies and equipment, provides guidelines for procurement, storage and stock control, care and maintenance, and considers safe disposal of medical waste. The manual also discusses the use of standard lists as a tool for encouraging good procurement practice and includes model lists of medical supplies and equipment required for primary health care activities in health facilities and in the community, and for basic laboratory facilities.

Although Medical supplies and equipment for primary health care is mainly intended for primary health care level, it will also be a useful resource for those at national and district levels responsible for health planning and management, training, and managing medical stores.

**ECHO International  
Health Services Limited**  
Ullswater Crescent  
Coulson Surrey CR5 2HR  
United Kingdom  
**T** +44 (0)20 8660 2220  
**F** +44 (0)20 8668 0751  
**E** [cs@echohealth.org.uk](mailto:cs@echohealth.org.uk)  
[www.echohealth.org.uk](http://www.echohealth.org.uk)

£7.50

ISBN 0-9541799-0-0

# **Medical supplies and equipment for primary health care**

A practical resource for procurement  
and management

by **Manjit Kaur and Sarah Hall**

Editor **Kathy Attawell**



**ECHO**

International Health Services Limited

Published by ECHO International Health Services Ltd, 2001.

© ECHO International Health Services Ltd, 2001.

All rights reserved. This publication can be freely reviewed, abstracted, reproduced or translated, in part or in whole, but not for sale or for use in conjunction with commercial purposes, and provided that ECHO is acknowledged as the source. The content and information contained in this publication are intended as guidelines only.

### **Medical supplies and equipment for primary health care**

A practical resource for procurement and management

ISBN 0-9541799-0-0

Printed in the United Kingdom by Dunns.

Price: One copy free of charge to organisations in the South, £7.50 for additional copies and for international organisations.

Available from:

ECHO International Health Services Ltd  
Ullswater Crescent  
Coulston  
Surrey CR5 2HR  
UK

Tel: +44 (0) 20 8660 2220

Fax: +44 (0) 20 8668 0751

E-mail: [cs@echohealth.org.uk](mailto:cs@echohealth.org.uk)

[www.echohealth.org.uk](http://www.echohealth.org.uk)

ECHO is a UK registered charity supplying low-cost, quality assured pharmaceuticals, medical supplies, equipment, teaching aids and books to the public and non-profit health sector in developing countries. ECHO also provides advice and training, and publishes practical information on medical supplies and equipment.

***“It is not the knowing that is difficult, but the doing”***

Chinese proverb



# Contents

<b>Foreword</b>	i
<b>Preface</b>	ii
<b>Acknowledgements</b>	iii
<b>Glossary, acronyms, abbreviations and symbols</b>	iv
<b>Introduction</b>	1
Who is this book for?	1
What is the purpose of the book?	2
Why are standard lists useful?	2
What information is included in this book?	3
How can you use this book?	3
<b>Section 1 Guiding principles for selecting supplies and equipment</b>	5
Need	5
Appropriateness	5
Quality	6
Costs	7
Source	8
Use and maintenance	8
Material	9
Disposable or reusable	11
<i>Table 1.1 Safety and performance standards</i>	6
<i>Table 1.2 Information provided by manufacturers</i>	7
<i>Table 1.3 General plastic-ware</i>	10
<b>Section 2 Procurement and management of supplies and equipment</b>	13
<b>2.1 Ordering and procurement</b>	13
Estimating and calculating requirements	13
Quantification methods	13
Lead time and frequency of orders	15
Stock levels	15
Calculating for an increase or decrease in order quantity	16
Ordering guidelines	17
Estimating costs	17
Freight and insurance charges for imported goods	18
Pre-Shipment Inspection	18
Identifying suppliers	19
Placing an order	19
Specifications	20
Handling donations	22

<b>2.2 Storage and stock control</b>	23
Organising the store	23
Stock control	24
Store records	25
Receiving supplies	27
Issuing supplies	28
Stock taking	28
Inventory of stock	28
<b>2.3 Care and maintenance</b>	29
User maintenance	29
Planned preventive maintenance	30
Stainless steel instruments	32
Choosing new instruments	33
General rules	34
Refrigerators	35
Choosing a refrigerator	35
General rules	36
<b>2.4 Cleaning, disinfection and sterilisation</b>	38
Cleaning	39
Disinfection	39
Disinfection by boiling	40
Chemical disinfection	40
Sterilisation	41
Sterilisation by steam under pressure	41
Sterilising reusable syringes and needles	49
Before sterilisation	49
Sterilisation	50
After sterilisation	52
<b>2.5 Disposal of waste</b>	55
Waste handling and management	55
Waste collection, treatment and disposal	55
Collection and disposal of sharps waste	56
Safety box	56
Puncture resistant container	56
Needlyzer	57
Balcan destructor	57
<i>Table 2.1 Calculating consumption</i>	14
<i>Table 2.2 Lead time and reserve stock</i>	15
<i>Table 2.3 Calculating order quantity</i>	16
<i>Table 2.4 Calculating costs</i>	17
<i>Table 2.5 Freight terms</i>	18
<i>Table 2.6 Standard storage temperatures</i>	23
<i>Table 2.7 Looking after SS instruments</i>	35
<i>Table 2.8 Looking after refrigerators</i>	37
<i>Table 2.9 Decontamination procedures</i>	38
<i>Table 2.10 Cleaning methods</i>	39
<i>Table 2.11 Disinfection by boiling and chemical disinfection</i>	44



<i>Table 2.12</i>	<i>Sterilisation</i>	48
<i>Table 2.13</i>	<i>Sterilising syringes and needles</i>	51
<i>Table 2.14</i>	<i>Different methods of waste disposal</i>	58
<i>Table 2.15</i>	<i>Different types of waste</i>	60
<i>Figure 2.1</i>	<i>Sample order form</i>	20
<i>Figure 2.2</i>	<i>Sample specification form</i>	20
<i>Figure 2.3</i>	<i>Sample stock card</i>	25
<i>Figure 2.4</i>	<i>Sample stock control ledger forms</i>	26
<i>Figure 2.5</i>	<i>Sample issue voucher form</i>	28
<i>Figure 2.6</i>	<i>Sample inventory form</i>	28

## **Section 3   Supplies and equipment for primary health care** 63

### **3.1 General supplies and equipment for health facilities** 64

General supplies and equipment 64

Diagnosis 71

General patient treatment and care 76

Boiling and sterilising 87

### **3.2 Supplies and equipment for primary health care activities** 93

Preventive child health 93

Reproductive and sexual health 103

Dressings, minor surgery and first aid 115

    Dressings 115

    Suturing and minor surgical procedures 120

    First aid 123

Eye care 125

Health education and promotion 128

### **3.3 Supplies and equipment for laboratory facilities** 131

Major equipment 131

Supplies and minor equipment 136

Miscellaneous consumables 143

Reagents and stains 145

### **3.4 Supplies and equipment for community care** 149

### **3.5 New developments** 153

## **Appendix 1   Useful resources** 157

Books and manuals 157

Free materials and guidelines 160

Sources of low-cost supplies, equipment and pharmaceuticals 160

Sources of publications and resource and information centres 161

<b>Appendix 2 Essential drugs</b>	165
Using the Essential Drugs List	165
An example of an Essential Drugs List	165
Practical tips for procurement	167
Quantification	169
<i>Table A1 Advantages and disadvantages of consumption and morbidity methods of quantification</i>	169
<i>Table A2 Consumption method</i>	170
<i>Table A3 Morbidity method</i>	171
<i>Table A4 Calculating drug requirements by health problems</i>	173
<b>Appendix 3 Common instrument features</b>	175
Shape	175
Serrations and/or teeth	175
Points	176

# Foreword

The life cycle of a health technology (medical devices or drugs) consists of three main phases - provision, acquisition and utilization. Procurement is one of the key steps in the acquisition phase. As such it plays an important role in ensuring that the right health sector goods (equipment, drugs, supplies etc.) are available, in the appropriate places and in the required quantities. Good procurement practices do not only lead to savings in acquisition costs, they also facilitate downstream activities during the utilization phase, especially maintenance in the case of equipment.

This book is a welcome document in this vein, as it provides a comprehensive resource for acquisition of health sector supplies and equipment, covering the needs of facilities at the primary health care level. If properly used, it should help ameliorate the situation in developing countries, where procurement of goods (and services) is often fraught with ineffectiveness and inefficiency. The book is fairly exhaustive in the range of products it covers - from cotton swabs to syringes, and from microscopes to waste disposal systems. The identification of equipment and supplies with the procedures they support, reasserts the need for acquisitions to be driven by health care goals, not procurement objectives.

The practical tips and suggestions on routine inspection and preventive maintenance can extend the useful life of the items procured, especially in the developing world, where sometimes more than fifty per-cent of all health care equipment is unusable, for reasons ranging from operator misuse to lack of spare parts. The discussion on management again underscores the need for a holistic view of procurement as an activity in a broader context, whose object goes beyond simply procuring health sector goods, to improving health services.

We trust that the book will get the readership it richly deserves, and most important, that its use will contribute positively to improving the health of the people and communities envisaged.

S. Yunkap Kwankam, Scientist & Andrei Issakov, Coordinator, Service Outcome  
Department of Health Service Provision, World Health Organization, Geneva

# Preface

Drugs, medical supplies and equipment account for a high proportion of health care costs. Health services in developing countries need to choose appropriate supplies, equipment and drugs, in order to meet priority health needs and to avoid wasting limited resources. Making sure that health facilities have adequate supplies, equipment and drugs is also essential if people are to have confidence in health services and health workers.

Model lists of basic low-cost products can help people responsible for procurement to make cost-effective decisions. A lot of useful information is available about essential drugs, and the World Health Organisation and other organisations have produced model lists of essential drugs. Until recently, less information was available about medical supplies and equipment, despite the fact that there is a much wider range of different brands and items to choose from and the specifications for supplies and equipment are much less standardised than for essential drugs. To address this situation, ECHO published *Selecting medical supplies for basic health care*, a model list of essential supplies and equipment, in 1995.

This revised edition, *Medical supplies and equipment for primary health care*, covers effective procurement, management and maintenance of basic supplies and equipment. The model list of essential supplies and equipment has been updated to reflect changes and developments since 1995 and expanded to include laboratory supplies, supplies and equipment for community care, and essential drugs. The presentation of the list has been reorganised to show what supplies and equipment are required for different primary health care activities. New information has been included about selection, ordering, storage, care and maintenance of medical supplies and equipment, and about waste disposal.

We hope that the revised edition will help readers to think about what supplies and equipment are needed and why, to decide how to obtain supplies and equipment, and to understand the basic principles of management and maintenance. Please use the feedback form at the end of the book to send your comments and suggestions, which will help us to improve future editions.

# Acknowledgements

This publication was produced with the generous support of the Tudor Trust and the Thackray Medical Research Trust. It includes information from the first edition written by Ray Skinner, John Townsend and Victoria Wells and new material compiled and written by Manjit Kaur and Sarah Hall.

ECHO would like to thank Anthony Battersby, Peter Bewes, James Bohan (ANTEC International Ltd), Andrew Chetley (Healthlink), Jurgen Clauss (FAKT – Association for Appropriate Technologies), Roger Drew (Healthlink), Robin Gray (WHO), Carolyn Green, Peter Hoffman (PHLS – Public Health Laboratory Service), Kathy Holloway (WHO), Jan Huys (HEART – Health Care through Appropriate and Reliable Technology), Warren Johns, Ted Lankester (Interhealth), Joos van den Noortgate (MSF – Medecins Sans Frontieres), Eldred Parry (THET – Tropical Health and Education Trust), Sr Nympha Que (CHAM – Christian Health Association of Malawi), Ellie Salkeld (MERLIN – Medical Emergency Relief International), Dean Shuey, Sue Stevens (International Centre for Eye Health) and Gerald Verollet (WHO) for their ideas and contributions and for reviewing the text.

Particular thanks are due to Elaine Harden (CPA – Commonwealth Pharmaceutical Association) for providing information on essential drugs, quantification and calculation, to Monica Cheesbrough (THT – Tropical Health Technology) for help and advice with the laboratory section, and to Caroline Temple-Bird (Ziken International) for contributing material on selection, specification and maintenance.

Special thanks are due to Charles Olupet (Mbale Clinical Officer Training School) for his invaluable support during field testing of the manual in Uganda. Many thanks to all of the following individuals who provided comments and practical help during field testing, including Peter Ngatia and Charles Munafu (AMREF), Ron Wehrens (JMS – Joint Medical Stores), Ian Clarke (IMC – International Medical Centre), Arne Clausen (FGA – African Development Society), Christine Naigogo (Hospice Uganda), Felix Drachaku and Robert Tigawazana (Mbale Clinical Officer Training School), Levi Bofu, Idah Nambozo, Martha Mugide, Vincent Wesamoyo and Boniface Mwambu (Buteza Health Centre, Mbale), Alice Khainza, Andrew Epenyu, Ruth Taliba, Sarah Kakayi, Fatuma Namatovu, Jennifer Mutonyi, Adeng Maty, Florence Akello and Mike Kadyama (Kolonyi Health Centre, Mbale), J Masaba, Stephen Tuunde and Michael Eregu (Mbale Regional Hospital), and Abedinego Watenga and Judith Nabuduwa (TASO – The AIDS Support Organisation, Mbale).

The authors would like to acknowledge the valuable contribution of colleagues at ECHO, especially Bonnie Fundafunda, Mark Radford and Justine Wilson.

Acknowledgements are expressed to all those who kindly gave permission to reproduce material and supplied artwork: WHO for Dunsmore drum burner; MedPro Needlyzer for Needlyzer; and Balcan Engineering for Balcan destructor.

The authors are indebted to Kathy Attawell for editing and support.

The manual was illustrated by David Woodroffe and designed by wave.

# Glossary, acronyms, abbreviations and symbols

## Glossary

**Accessories** – are complementary and add to the functions of an item of equipment, but are not always essential, e.g. a 20X objective is useful if you are using a microscope to examine plasma for parasites but is not required for other functions.

**Cleaning** – is the process of removing visible material, such as dirt, grease, blood and body fluids and reducing the number of infectious micro-organisms (bacteria, viruses, fungi, and spores).

**Consumables** – are essential for an item to perform its basic function, e.g. immersion oil is essential for microscopes. Consumables are also items that are used within a short time, e.g. cotton wool.

**Disinfection** – is the process of removing or reducing the number of micro-organisms to levels that are no longer harmful. Disinfection kills viruses, fungi and bacteria but not spores such as tetanus. Disinfection is, therefore, safe for items that are used for some purposes but not for those where all organisms must be destroyed.

**Disposables** – are items designed for single use. Disposables should only be used once and should not be re-used.

**Equipment** – is capital equipment and durable items that last for several years, e.g. beds, examination tables, sterilisers, microscopes, weighing scales, and bedpans.

**Planned Preventive Maintenance (PPM)** – is the regular maintenance service recommended by manufacturers and carried out by trained technicians, which should supplement maintenance carried out by health facility staff using the equipment.

**Procurement** – includes deciding what quantities to order, choosing a supplier if goods are purchased, and obtaining supplies and equipment through donations.

**Reusables** – are items designed to be used more than once. Reusables should only be used after proper cleaning and sterilisation and/or disinfection.

**Spare parts** – are required to maintain the basic function of an item of equipment, e.g. to replace damaged, worn or lost parts, or as part of PPM to prevent breakdown.

**Standard List** – is a model list of standardised medical supplies and equipment, based on the type of preventive care, diagnostic tests, and treatments a health facility is expected to carry out.

**Sterilisation** – is the process of destroying or removing all forms of living organisms, including bacteria, viruses, fungi and spores.

**Supplies** – are items that need replacing on a routine basis, including disposables, single use items, e.g.

disposable syringes and needles; expendables (sometimes also called consumables), items that are used within a short time, e.g. cotton wool and laboratory stains; reusable items, e.g. catheters and sterilisable syringes; and other items with a short life span, e.g. thermometers.

**User Maintenance** – is day-to-day routine care and maintenance by users, including cleaning, inspection for damage and reporting any defects, which is essential to keep instruments and equipment in good working condition.

## Acronyms and abbreviations

ANC	Ante Natal Care
B/B	Blunt/Blunt
BCG	TB vaccine
CHW	Community Health Worker
CMS	Central Medical Store
CSSC	Christian Social Services Commission
ECHO	ECHO International Health Services Ltd
ED	Essential Drugs
EDL	Essential Drugs List
EPI	Expanded Programme on Immunisation
Hb	Haemoglobin
HIV	Human Immunodeficiency Virus
HW	Health Worker
IDA	International Dispensary Association
JMS	Joint Medical Store
LBW	Low Birth Weight
MCH	Mother and Child Health
MEDS	Mission for Essential Drugs and Supplies
MOH	Ministry of Health
MSF	Medecins Sans Frontieres
NGO	Non Government Organisation
ORS	Oral Rehydration Solution
ORT	Oral Rehydration Therapy
Paed	Paediatric
PHC	Primary Health Care
Pr	Pair
PVC	Poly Vinyl Chloride
SS	Stainless Steel
S/S	Sharp/Sharp
SSS	Sugar Salt Solution
STI	Sexually Transmitted Infection
TBA	Traditional Birth Attendant
TH	Traditional Healer
TT	Tetanus Toxoid vaccine
UNICEF	United Nations Children's Fund
VEN	Vital, Essential, Non-essential
WHO	World Health Organisation

## Abbreviations for drug formulations and routes of administration

Amp	Ampoule
Cap(s)	Capsule(s)
Inj	Injection/Injectable
IM	Intramuscular
IV	Intravenous
SC	Subcutaneous
Tab(s)	Tablets

## Abbreviations for standards

BP	British Pharmacopoeia
CE	European Committee for Standardisation
EP	European Pharmacopoeia
EN	European Norms
IEC	International Electrotechnical Commission
IP	WHO International Pharmacopoeia
ISO	International Organisation for Standardisation
USP	United States Pharmacopoeia

## Symbols

°	degree
%	per cent
&	and
"	inches
+	and/with
/	or/per
<	less than
>	more than
÷	divided by
x	multiplied by
μ	micro

## Measures

AC	alternating current
C	centigrade (Celsius)
CH	Charriere gauge for catheters, tubes, drains (same as FG e.g. CH5 = 5FG)
cm	centimetre
DC	direct current
F	Fahrenheit
FG	French gauge for catheters, tubes, drains (same as CH e.g. 5FG = CH5)
G	gauge for IV catheters, needles (the lower the gauge the greater the diameter)
g	gram
ht	height
Hz	Hertz (cycles per second)

kg	kilogram
l	litre
lb	pound
l x w x h	length x width x height
m	metre
min	minute
mcg	microgram
mg	milligram
ml	millilitre
mm	millimetre
MU	mega units
no.	number
oz	ounce
tsp	teaspoon (5mls)
V	volts
W	watts
wt	weight

This book uses metric dimensions and sizes. If you use imperial measures, refer to the conversion table below.

## Conversion table

### Length:

cm =	inch	inch =	cm
1	0.394	1	2.54
2	0.787	2	5.08
3	1.181	3	7.62
4	1.575	4	10.16
5	1.969	5	12.70
6	2.362	6	15.24
7	2.756	7	17.78
8	3.150	8	20.32
9	3.543	9	22.86
10	3.937	10	25.40

### Temperature:

To convert °C to °F: multiply by 9, divide by 5 and add 32.

To convert °F to °C: subtract 32, multiply by 5 and divide by 9.

### Measures and equivalents:

1 cm	=	10 mm
1 kg	=	2.2 lb
1 m	=	100 cm
1 lb	=	0.454 kg
1 g	=	1000 mg
1 kg	=	1000 g





# Introduction

## Who is this book for?

This book is aimed at primary health care facilities. It is intended for health workers who are responsible for selecting and managing medical supplies and equipment for primary health care services provided by government facilities and by non-government organisations, including non-profit agencies and private companies such as mines and plantations.

The way that primary health care is organised varies from country to country and the services provided depend on the type of facility and staff, and on the resources available. Primary care facilities include health posts, dispensaries, clinics and health centres. Some facilities may have only one health worker, others may have a number of staff. Primary care staff include medical assistants, clinical officers, nurses, midwives, community-based workers or other professional and non-professional health workers.

In this book we have assumed that primary health care facilities offer the following services:

- **Diagnosis and treatment of common diseases and conditions** – including malaria, skin diseases, respiratory infections, anaemia and malnutrition.
- **Preventive child health** – including growth monitoring, immunisation and nutrition.
- **Reproductive and sexual health** – including antenatal, postnatal and delivery care, family planning and prevention, diagnosis and treatment of STIs.
- **Treatment of injuries** – dressing wounds and immobilising uncomplicated fractures, minor outpatient surgery under local anaesthetic and providing basic first aid in emergencies.
- **Eye care** – including checking vision, prevention of blindness and treatment of infections.
- **Health education and health promotion** – in the community and in health facilities.

Primary health care facilities usually provide **community care**, supporting and supervising community-based health workers (community health workers, traditional birth attendants and traditional healers), and home-care programmes for people with chronic or terminal illness and disabled people.

Some primary health care services may also have a small delivery room for births and a few short stay beds for very sick patients, and basic **laboratory facilities** for conducting simple diagnostic tests.

The information in this book will also be relevant for secondary level facilities, usually district hospitals, which deal with more complex cases and take referrals from primary level facilities. The more sophisticated needs of tertiary level facilities, which provide specialist services, are not discussed in this book. However, we hope that it will be useful to health planners, managers and trainers at national and district level in Ministries of Health, Finance and Planning, and to personnel responsible for purchase and supply and for managing medical stores.

## Medical supplies and equipment

The term medical supplies means different things to different people, and the distinction between supplies and equipment is not always clear. In this book, we have defined medical supplies and equipment as follows:

- **Supplies** – items that need to be replaced on a routine basis, including: disposables, single use items, e.g. disposable syringes and needles; expendables (sometimes also called consumables), items that are used within a short time, e.g. cotton wool, laboratory stains and tape; reusable items, e.g. catheters and sterilisable syringes; and other items with a short life span, e.g. thermometers.
- **Equipment** – capital equipment and durable items that last for several years, e.g. beds, examination tables, sterilisers, microscopes, weighing scales and bedpans.

## What is the purpose of the book?

Choosing supplies and equipment is often given little thought or attention. This can result in procurement (the process of obtaining items through purchase and donation) of inappropriate supplies and equipment. Items can be inappropriate because they are technically unsuitable or incompatible with existing equipment, because accessories or spare parts are not available, or because staff have not been trained to use them. Too often, supplies and equipment are not effective or efficient because they are poorly managed and maintained.

This book aims to:

- Provide guidance for deciding what medical supplies and equipment are needed.
- Promote the use of standard lists of supplies and equipment, in order to encourage good procurement practice in primary level facilities.
- Encourage collaboration between those who use supplies and those who make decisions about the allocation of resources.
- Improve understanding of management and maintenance of supplies and equipment.

## Why are standard lists useful?

A standard list is a model list of standardised medical supplies and equipment, based on the type of preventive care, diagnostic tests and treatments a health facility is expected to carry out.

Standard lists assist in making appropriate choices of medical supplies and equipment, which helps to improve patient treatment and care, use of resources and management.

Standard lists improve patient treatment and care by:

- Identifying the priority supplies and equipment needed to prevent and treat common health problems, and ensuring that these priority items are available in health facilities.
- Promoting standardised use of medical supplies and equipment in treatment, providing the basis for standard clinical procedures and training for health workers.

Standard lists improve use of resources by:

- Providing a framework for budgeting and for controlling procurement costs.
- Avoiding procurement of items that are rarely or never used.
- Reducing duplication of items used for the same purpose.
- Preventing expensive and wasteful over-ordering and over-stocking.
- Helping to prioritise new acquisitions.

Standard lists improve management of supplies by:

- Reducing the number of items that need to be supplied.
- Dividing supplies into 'vital', 'essential' and 'not so essential' categories (see Box), which helps to identify items that should always be in stock.
- Encouraging uniformity in health facilities, which simplifies stock control, ordering and maintenance.
- Providing the basis for standard maintenance training of users and technicians.
- Rationalising the range of spare parts, accessories and other consumables required, which simplifies sourcing, purchasing and storage.
- Helping to decide whether or not to accept donated supplies and equipment.

## The VEN system

The VEN system helps to set priorities in procuring medical supplies and equipment and keeping stock. Items are categorised as:

- **Vital** – items that are crucial for providing basic health services.
- **Essential** – items that are important but not absolutely crucial for providing basic health services.
- **Not so essential** – items that are used for minor or self-limiting problems.

Vital and essential items should be given priority if funds are limited, and health facilities should always have these items in stock.

## What information is included in this book?

This book is organised in the following sections:

- **Section 1** – provides a checklist of criteria to guide selection of supplies and equipment.
- **Section 2** – provides practical guidelines about procurement, including deciding what quantities to order, choosing a supplier, and dealing with donations of supplies and equipment. It also looks at management, including keeping records, maintaining supplies and equipment in good condition and disposing of waste.
- **Section 3** – includes information about essential supplies and equipment for primary health care services, with specific lists of the items required for activities carried out by most primary health care facilities. This section also describes new developments in the field of medical supplies and equipment.

Appendix 1 provides a resource list of useful materials and sources of additional information, and Appendix 2 includes a list of essential drugs for primary health care facilities and information about drug quantification methods.

## How can you use this book?

Ideally you should use a standard list to help you select supplies and equipment. In many countries, Ministries of Health (MOH) have developed guidelines or standard lists of medical supplies and equipment for all levels of the health system.

If there is no standard list available, you will need to develop your own standard list of commonly used supplies and equipment. This book is intended to help you to do this. It is beyond the scope of this book to include everything you might need to know about equipping and furnishing a PHC facility, and so it does not provide information about non-medical and communications equipment, furnishings, stationery and so on.

- Think about the most common health problems in your area.
- Review patient needs and the services provided by your facility.
- Review the skills and competence of your health workers.
- Assess what resources you have available for procurement of supplies and equipment.
- Find out what supplies and equipment are used by other health facilities in your district and ask colleagues in these facilities about their experience.

Use this information and the criteria in Section 1, the guidelines in Section 2 and the lists in Section 3 to help you draw up a standard list of the supplies and equipment required to meet patient needs. Make sure that you involve health workers and maintenance staff in drawing up the list. Review and update the list on a regular basis. The prices given as examples are illustrative. You will need to obtain current prices from suppliers.

Readers are also encouraged to use the book as a practical resource for procurement, management and maintenance of supplies and equipment. You can photocopy or reproduce relevant sections as posters, wall charts or other practical tools to help you in your day-to-day work.

ECHO welcomes your comments on this manual. Please use the feedback form at the end to send us your suggestions about ways in which we can improve future editions.



# SECTION 1

## Guiding principles for selecting supplies and equipment

Selecting medical supplies and equipment is not easy because of the wide range of products available. The criteria discussed below, and summarised in the checklist at the end of this section, are intended to help you decide what to include in a standard list and what to procure.

### Need

Think about why you are planning to purchase supplies or an item of equipment. Issues to consider are:

- Public health
- Technical
- Economic
- Clinical

There may be public health or epidemiological reasons for needing the supplies or equipment. For example, you may need them to prevent, diagnose or treat a new health problem or to improve existing services to patients. Whether you are adding something new to your facility or replacing an existing item, use the VEN system to help you think about whether a new or replacement item is 'vital', 'essential', or 'not so essential' for your services.

Equipment should not be replaced just because it is old or a newer model is available. Only buy replacements for items that have reached the end of their useful life, that are not economical to repair or that are technically obsolete – the manufacturer is no longer producing spare parts, consumables and accessories (see Box).

Sometimes an item of equipment becomes clinically obsolete, because the technology or technique is no longer considered appropriate, or a more cost-effective or more clinically effective model becomes available.

- **Consumables** – are essential for an item to perform its basic function, e.g. immersion oil is essential for microscopes. Consumables are also items that are used within a short time, e.g. cotton wool.
- **Accessories** – are complementary and add to the functions of an item of equipment, but are not always essential, e.g. a 20X objective is useful if you are using a microscope to examine plasma for parasites but is not required for other functions.
- **Spare parts** – are required to maintain the basic function of an item of equipment, e.g. to replace parts that are damaged, worn or lost, or as part of PPM (see Section 2.3) to prevent breakdown.

Different types of equipment last for different lengths of time, although this depends on how often they are used and how well they are maintained (see Section 2.3).

### Appropriateness

Supplies and equipment should be appropriate for the setting in which they will be used. Issues to consider include:

- Local conditions
- Compatibility
- Acceptability

Avoid buying items that are too technically sophisticated for local conditions. The latest model often requires more expertise to use and maintain, and complicated items tend to break down more frequently. If you are thinking about procuring a particular item, it can be useful to talk to someone in a facility that has experience of using that model.

You also need to check reliability and durability under local conditions. For example, it may be important to find out if supplies or equipment function well in an environment that is hot, humid, dry or dusty, and if special storage conditions are required. Some supplies and equipment are particularly sensitive to certain conditions, for example, condoms are sensitive to heat and microscopes are sensitive to humidity.

Supplies and equipment should be compatible with existing equipment and appropriate for the level of service provided by your facility. You also need to check that supplies and equipment will be familiar to staff and culturally acceptable to patients.

## Quality

Supplies and equipment must be of sufficiently high quality in terms of:

- Performance
- Safety
- Materials and design
- Labelling and packaging

The quality of performance you need depends on how often an item will be used and how long you are expecting it to last. Buy the quality that is best suited to your needs.

It is worth buying better quality supplies and equipment if they are going to be used frequently or are expected to last a long time. However, it is not always necessary to buy the very best quality. For example, good 'mid-range' quality stainless steel instruments are probably the best buy. It is not cost-effective to buy the most expensive because instruments are easily misplaced, or the cheapest because these are more likely to rust or fall apart.

Patient care and safety should never be compromised by poor quality. Supplies and equipment must meet safety standards (see Table 1.1). Safety also depends on the quality of installation, correct use and regular maintenance.

Table 1.1 **Safety and performance standards**

All medical supplies and equipment should meet international, regional or national safety and performance standards. The most important standards include:

**IEC** – which are international standards for the electrical safety of electrical and electromechanical equipment, and apply to refrigerators for example. IEC 601 is the international standard specifically for electrical and mechanically safe medical equipment for use by staff and with patients.

**ISO** – which are international standards for quality management and systems. ISO 9000–9004 is a series of standards covering the quality of manufacturing processes, design and development, construction, installation and service. ISO standards do not currently exist for all medical supplies and equipment, but do apply to syringes, needles, gloves, instruments and scales, for example.

**CE mark** – which indicates that a product meets European Union directive standards, and apply to sterile medical supplies for example.

**Pharmacopoeia specifications** – which establish quality specifications for the most commonly used drugs and some medical supplies, such as bandages, tape and swabs. Important pharmacopoeias include the British (BP), European (EP), United States (USP) and WHO International Pharmacopoeia (IP).

**Quality certificates or export certificates** – which are issued under various national and regional standards such as ISO 9000 or the equivalent EN 29000.

If possible, before purchasing, check the quality of the labelling and the packaging. Labelling should include information about country of origin, date of manufacture and, if appropriate, expiry date and storage instructions. Packaging should protect supplies and equipment from damage or deterioration during transit and storage.











Labelling or packaging also includes information that manufacturers are required to provide to users. This information is sometimes presented as symbols, which are intended to be understood by any user irrespective of their languages. Explanations for the most common information and symbols are included in Table 1.2.

## Costs

Better quality supplies and equipment are more expensive, but cheaper supplies and equipment are often of poor quality. Buying the cheapest items can be a false economy, because they may need repairing or replacing more frequently. It may be more cost-effective to spend more on a higher quality item that is more reliable and that lasts longer.

Supplies that are close to their expiry date are sometimes offered for sale at low prices. Be careful not to buy more than you can use before the expiry date, otherwise you will waste resources. Packaging also adds to the cost of supplies and equipment, but it is usually worthwhile purchasing goods that are well packaged. Poorly packaged goods are more likely to be damaged in transit.

Table 1.2 Information provided by manufacturers

 <p>Sterile</p>	 <p>Sterilised by irradiation</p>	 <p>Sterilised by heat</p>	 <p>Sterilised by ethylene oxide</p>
 <p>2005-06-30</p> <p>Use by date e.g. use by 30 June 2005</p>	 <p>2001-06</p> <p>Date of manufacture e.g. manufactured June 2001</p>	 <p>Batch number (code)</p>	<p>SN-ABC 123</p> <p>Serial number</p>
 <p>Do not re-use (use once)</p>	 <p>Attention (see instructions for use)</p>	 <p>Complies with EU directives</p>	

In addition to the purchase cost, other initial costs to consider include:

- Import tax and customs duty
- Transportation and insurance
- Installation
- Staff training

You also need to check that your budget will cover operational (running) costs throughout the lifespan of the equipment, including:

- Consumables and accessories – allow for continuity of these supplies
- Maintenance and servicing – allow 5-7% of capital cost for this
- Spare parts
- Kerosene, electricity or other fuel
- Safe waste disposal

## Source

Another important factor is the source of supplies and equipment. There are issues to consider related to:

- Manufacturers and suppliers
- Imported supplies
- Used supplies

The quality of manufacturing standards differs from country to country. Only procure supplies and equipment from a licensed, reputable and reliable source. Before buying, ask the supplier which safety and performance standards an item complies with. Be wary of copies – items made to look like a well-known brand – as these are often of poor quality and do not conform to international standards.

If you are thinking about importing supplies and equipment, you will need foreign exchange. Find out if the supplier will provide all the necessary documentation for customs clearance and decide whether you can deal with import procedures, transport, insurance and other arrangements (see also information about Pre-shipment Inspection in Section 2.1).

Buying second hand, refurbished or reconditioned equipment requires particular care. Asking the following questions can help:

- What condition is the equipment in? How much longer will it last?
- If it has been reconditioned, what is its new life time?
- Will it be supplied with installation and use instructions, service and repair manuals?
- Has it been fully tested and calibrated? Are all the essential parts, and at least two year's supply of accessories and working materials (including all the consumables and spare parts needed to use the equipment) included?
- Will the supplier be able to continue to provide accessories, consumables and spare parts, technical support and maintenance for the future life of the item?
- What after sales support will the supplier provide?
- How long will it take from placing the order to receiving the item?
- Will staff have to be trained to use the equipment or are they already familiar with it?

Sometimes it is more cost-effective to buy new rather than used equipment, which only has a limited life. Obtaining accessories, consumables and spare parts can also be difficult for older models that are no longer made. Find out the cost of a new model of the same or a similar item of equipment and compare this with the cost of a used model.

## Use and maintenance

It is essential that your facility can use and maintain the supplies and equipment you procure. There is no point in obtaining items if your staff do not have the expertise or information to use them effectively or if you cannot access maintenance support and technical back up. Issues to consider include:

- Utilities
- Skills and training
- Technical back up
- Consumables, accessories and spare parts

Check that your facility has the utilities needed to use an item of equipment. For example, some equipment requires a reliable power supply, adequate quantities and quality of water, and an effective waste disposal system. If your facility has an unreliable or fluctuating power supply, choose equipment that can be operated with kerosene, gas or battery power, or consider whether you can afford to purchase a voltage stabiliser for electronic equipment.

Consider how easy it will be for your staff to use, clean and maintain the equipment. Do all the staff who will use it already have the skills required or will they receive training? Find out if the manufacturer or supplier provides training and other support services.

Check that the equipment is supplied with simple, easy to use instructions, user, repair and service manuals, and a list of spare parts.



If maintenance requires the services of a skilled technician, find out whether you have access to technicians locally or nationally who can service and repair the equipment, and who can provide planned preventive maintenance (PPM). PPM is the regular maintenance service recommended by manufacturers, which should supplement maintenance carried out by health facility staff using the equipment. Manufacturers and suppliers do not have service agents in all countries. If there is no authorised agent in your country, find out if there are other organisations that offer this service, for example JMS in Uganda and CSSC in Tanzania.

Check whether the supplier provides a guarantee or warranty for the equipment and parts. Guarantees can last for a year or more, although the length of time depends on the type of equipment or product. While an item of equipment is under guarantee or warranty, the manufacturer should replace or repair it (either directly or through a distributor or local agent), or provide a refund if the equipment is found to be defective due to faulty materials or workmanship, either on arrival or during use. However, if there is no authorised agent in a country, the user may be responsible for the cost of sending the item back to the manufacturer. A guarantee does not cover defects arising from items not used correctly, misuse, neglect, accidents or repairs carried out by other companies.

Finally, consider the availability of consumables, accessories and spare parts. Find out what you will need to operate and maintain the equipment, how much these items cost, where they can be obtained and how easy it is to get hold of them, and for how long they will continue to be available in future.

### **Procedure for products sent to ECHO for repair**

ECHO is able to accept a wide range of medical equipment from customers for repair, whether or not it was bought from ECHO. Customers wishing to use this service should first check with ECHO's Biomedical Engineering Department. Please note that if you are sending goods to ECHO from outside the UK, special paperwork is required to show that the items are being brought on a 'temporary import basis' to be repaired. If you do not complete this documentation you will be charged import duty on the goods by the UK authorities. ECHO can advise you about the procedures if necessary.

**Warranties:** Medical equipment bought from ECHO, whether new or reconditioned, is normally offered with a warranty (or guarantee) for a fixed period. If the item you purchased develops a fault in the course of normal use during the warranty period, then ECHO will offer you replacement, repair or other appropriate support according to the terms of the warranty. However, you should be aware that warranties do not cover damage caused by inappropriate use, and will be invalidated if the customer has attempted an unauthorised repair. Details of the warranty offered by ECHO on any specific item of equipment are available on request.

**Insurance:** If ECHO is freighting your goods to you, we will normally insure them unless we have been instructed not to by you. If your products are lost or damaged in transit, you should let ECHO know within two months of the arrival or expected arrival of the goods. If notified within this period, ECHO will process your insurance claim for you so that replacement or repair can be set in motion.

## **Material**

Another important consideration is the material an item is made from. Instruments made from tungsten carbide last longer but are the most expensive. Instruments made from good quality stainless steel last longer than plastic instruments but are more expensive. Items made of aluminium are lightweight but bend and buckle more easily than items made of iron or stainless steel.

Metal items that rust easily are difficult to clean. Make sure metal items that need to be cleaned and sterilised or disinfected regularly have a polymerised finish, polyester coating, epoxy coating or are made from good quality stainless steel. Polyester or epoxy coating also provides additional protection from scratches and abrasions.

Glass items are fragile and break easily. Not all glass items can be re-used. Many glass items are also manufactured in plastic. Plastic does not break easily and weighs less than glass, making it safer to use and easier and cheaper to transport. Some plastic items can be re-sterilised, others cannot. Table 1.3 summarises the key properties of different types of general plastic-ware.

Although most supplies are quite durable, some spoil if left unused for too long, for example, rubber tubing and latex items such as condoms. Plastic wrapping helps to protect such items against high humidity and is more robust than paper wrapping.

**Table 1.3 General plastic-ware**

Type	Uses	Sterilisable <sup>a</sup>	Temperature resistance (up to 15 min)	Chemical resistance <sup>b</sup>	Flexibility	Transparency <sup>c</sup>
Polypropylene (PP)	Centrifuge tubes, some disposable syringes, funnels, test tube racks, trays, buckets	Yes	140°C	High	Rigid	Translucent <sup>d</sup>
High density polyethylene (HDPE)	Trays, bottles	Yes (with caution, up to 20 min)	120°C	High	Rigid	Translucent
Low density polyethylene (LDPE)	Wash bottles, buckets, airtight boxes	No	95°C	Medium	Excellent	Translucent
Polystyrene (PS)	Disposable laboratory ware	No	70°C	Low (but can be disinfected with bleach solution)	Rigid	Clear
Polyvinyl chloride (PVC)	Tubing, trays	No	80°C	Low (but can be disinfected with bleach solution)	Rigid	Clear
Polymethyl-pentene (PMP)	Conical centrifuge tubes, beakers, jugs	Yes	200°C	Medium	Rigid	Clear

<sup>a</sup> Autoclaving: 121°C 15 psi for 30 minutes

<sup>b</sup> Chemical resistance: High – exceptional resistance to almost all laboratory chemicals; medium – good to excellent resistance to a broad range of common laboratory chemicals; low – moderate to good resistance to common aqueous laboratory chemicals but avoid organic solvents and strong acids and bases

<sup>c</sup> Transparent: Can be clearly seen through and allows light to pass through without diffusion

<sup>d</sup> Translucent: Allows light to pass through but not transparent

Source: Adapted from *Selection of basic laboratory equipment for laboratories with limited resources (WHO)*.

## Disposable or reusable

Some supplies and equipment, such as gloves and syringes, are available as disposable and as reusable products, and you may need to decide which type to procure.

- **Disposables** – are items designed for single use. Disposables should only be used once and should not be re-used.
- **Reusables** – are items designed to be used more than once. Reusables should only be re-used after proper cleaning and sterilisation and/or disinfection.

Both types have advantages and disadvantages in terms of convenience and cost. Disposables are more convenient than reusables. However, using disposables costs more than reusables, because they need to be replaced more often. When comparing costs you also need to include the cost of sterilising reusable equipment. To help you to decide what type is most suitable for your health facility, consider the following issues:

- National policy
- Sterilisation
- Supply

Is there a national or local policy regarding the use of disposable or reusables? It is usually easier and more practical to follow existing policy.

Does your facility have the equipment required for sterilisation? You should only plan to use reusables if your facility can sterilise equipment properly (see Section 2.4). Staff and patients are at risk of diseases such as hepatitis B and HIV if equipment is not properly sterilised.

Can you obtain regular and reliable supplies? You should only plan to use disposables if you can obtain a regular and reliable supply of replacements. Disposable equipment is not intended to be sterilised and should not be re-used. If supply problems are likely, either use reusables or keep a reserve supply of reusables for times when disposables are not available. In both situations you need to have a reliable and effective sterilisation system in place.

# Guiding principles checklist

## Need

- Why do you need the supplies or item of equipment? Will it address an important or new health problem or improve existing services? Is it vital, essential or not so essential for your services?
- Is it new or replacing existing equipment?
- Has your existing equipment reached the end of its useful life? Is it no longer economical to repair?
- Is it technically obsolete? Is the manufacturer no longer producing spare parts, consumables and accessories?
- Is it clinically obsolete? Is a more clinically-effective or cost-effective model available?

## Quality

- What level of quality best meets your requirements?
- How often will the item be used and how long is it expected to last?
- Do the supplies or equipment meet safety standards?
- Is the labelling and packaging of acceptable quality?
- Is the equipment supplied with necessary operations and service manuals?

## Source

- Are you planning to procure from a local supplier or to import?
- If importing, do you have access to foreign exchange? Will the supplier help with arrangements for import?
- Is the manufacturer or supplier reputable, licensed and reliable?
- Are you planning to buy used, refurbished or reconditioned equipment? How long will it last? What technical support will be available? Will you be able to obtain spare parts, consumables and accessories?

## Material

- What material is the item made from?
- Is it made from good quality, hard wearing material?
- Will it be easy to clean, disinfect and/or sterilise?
- Will it break or spoil easily?

## Appropriateness

- Are the supplies or equipment appropriate for the type of services your facility provides?
- Are they technically suitable for local conditions?
- Will the item be efficient, reliable and durable in dry, hot, dusty or humid conditions?
- Are special storage conditions required?
- Will the supplies or equipment be compatible with your existing equipment?
- Will the item be familiar and acceptable to staff and patients?
- Is the item simple, robust and capable of local maintenance?

## Costs

- Are you buying the cheapest supplies and equipment available? Are they of adequate quality?
- Would it be more cost-effective to spend more on a higher quality item?
- Have you taken into account the costs of import tax and duty, freight, transport and insurance, installation and staff training in addition to the capital cost?
- Have you budgeted for maintenance, fuel, spare parts, consumables and accessories?

## Use and maintenance

- Do your staff have the skills to use, clean and maintain the supplies or equipment? Will training be provided?
- Does the item come with a guarantee or warranty? What support services are provided by the manufacturer or supplier? Is the technical expertise required for maintenance available nationally or locally?
- Does your facility have the utilities required to use the item? Does it need a reliable power supply, adequate quantity and quality of water, effective waste disposal?

## Disposable or reusable

- Are you planning to procure disposable or reusable items? What is national policy?
- Can your facility afford to buy disposables? Are supplies regular and reliable?
- Does your facility have the capacity for proper sterilisation of reusables?

# SECTION 2

## Procurement and management of supplies and equipment

This section provides practical guidelines for all stages of procurement and management of medical supplies and equipment. It is divided into the following sub-sections:

- **Section 2.1** covers ordering and procurement.
- **Section 2.2** covers storage and stock control.
- **Section 2.3** covers care and maintenance.
- **Section 2.4** covers cleaning, disinfection and sterilisation.
- **Section 2.5** covers disposal of waste.

### **2.1** Ordering and procurement

#### **Estimating and calculating requirements**

When you have decided what supplies and equipment you need, you then need to calculate or estimate what quantities of each of these items is required. It is important to order the right quantities.

Ordering too little (understocking) will result in shortages and your health facility will be unable to provide effective treatment and care, undermining staff and patient confidence in the service. Ordering too much (overstocking) will result in a build up of stock and wastage, for example of items that are not used before their expiry date or that become spoiled if unused for too long, as well as tying up valuable funds unnecessarily.

The amount you order will depend on factors that you can anticipate, such as how much stock is normally used, how many patients will need to be treated, seasonal demands, how often you place an order, and the storage capacity of your health facility. You may also need to order a limited quantity of extra stocks of some items so that your facility can deal with unexpected events, such as epidemics and natural disasters.

#### **Quantification methods**

Quantification is the process used to calculate or estimate the quantities of medical supplies, drugs and equipment required. It is usually done once a year or during the planning for a new health programme or project. Proper quantification ensures that there is enough stock to meet demand, and avoids both understocking and overstocking. It is also a useful tool for preparing budget estimates, adjusting quantities to match a fixed budget, and monitoring use of supplies and equipment by health facility staff.

The most commonly used quantification methods are:

- **Consumption method** – which uses data about actual use or past consumption to calculate what quantities will be required in future.
- **Morbidity data method** – which uses data about prevalence and incidence of disease and health problems, and the standard treatments for these, to estimate future needs.

The consumption method is the preferred method for estimating requirements. An example of how to use this method to calculate the quantity of crepe bandage needed for 12 months is given in Table 2.1. More detailed information about quantification methods and how these can be used to calculate drug requirements is provided in Appendix 2.

**Table 2.1 Calculating consumption**

**Step 1: Select the time period for calculating consumption**

To calculate the quantity of crepe bandages required for a 12 month period for 10,000 patients. You have the following data for 12 months:

Opening stock balance	100 crepe bandages
Stock received	1000 crepe bandages
Closing stock balance	200 crepe bandages
Wastage	0
Stockout	2 months

*12 months is the most practical time period to use for calculation, because it allows for seasonal variations in requirements. If the data you have available covers a shorter or longer time period, use Step 4 to adjust it to calculate requirements for 12 months.*

**Step 2: Calculate the consumption for each item during the time period**

Recorded consumption = Opening stock balance + Stock received – Closing stock balance

Recorded consumption = 100 + 1000 – 200 = 900 crepe bandages

*To calculate consumption you need accurate stock cards with a record of all items received and issued. Or you can calculate consumption for each item by adding together all the stock issues made (to do this you need a record of all items issued).*

**Step 3: Adjust consumption figures for wastage or stockouts**

**Wastage**

Real consumption (RC) = Recorded consumption – Wastage (avoidable losses)

Real consumption = 900 – 0 = 900

AND/OR

**Stockout**

Adjusted RC = Real consumption x  $\frac{\text{Period in calculation (months, weeks, days)}}{\text{Period in stock (months, weeks, days)}}$

Adjusted real consumption = 900 x  $\frac{12}{10}$  = 1080 crepe bandages

*Wastage of 5-10% is considered to be unavoidable, but you will need to adjust the consumption figure if it is more than 10%. You can estimate wastage by checking the number of patients treated and items issued. For example, if your stock records show that you have issued 40 bandages, but have treated 25 patients with 1 bandage each, there are 15 you cannot account for. Check to see how many are in the dressing room. If there are 10, you know 5 have been wasted, i.e. 12.5%. You will also need to adjust the consumption figure for any item that has been out of stock for more than 1 month during the time period, using the stockout formula. NB: If there are no stockouts, no adjustment is made. If there is no wastage, the recorded consumption is the real consumption.*

**Step 4: Adjust to time period or patient numbers for which quantities are required**

**Time Period** (e.g. 12 months)

Annual consumption = Real consumption x  $\frac{12 \text{ months}}{\text{Months in stock}}$

Annual consumption = 900 x  $\frac{12}{10}$  = 1080 crepe bandages

OR

**Patient numbers** (e.g. 10,000 patients)

Consumption per 1000 patients =  $\frac{\text{Adjusted real consumption} \times 1000}{\text{Total number of patients}}$

Consumption per 1000 patients =  $\frac{1080 \times 1000}{10,000}$  = 108 crepe bandages

So for 10,000 patients you need:  
108 x 10 = 1080 crepe bandages

*This step is not needed if you have data for the period in calculation, e.g. if you are calculating for 12 months and you have data for 12 months. However, if the data available is for less or more than 12 months then you need to adjust the figure, in the same way as for 'out of stock' adjustment in step 3.*

*Use the patient numbers calculation if you need to calculate consumption in terms of quantities per numbers of patients, e.g. the amount of item used per 1000 patients. The number 1000 patients is used for ease of calculating needs and for planning.*

The consumption method depends on reliable consumption data and effective stock control, especially accurate record keeping. To use this method you need a monitoring system that both provides information about actual rates of consumption of supplies and equipment and highlights higher than expected consumption of particular items and potential misuse of supplies.

**Quantification methods** are useful for **estimating annual requirements**. However, actual annual consumption can be different from estimated consumption. Also, many health facilities place orders more than once a year, either on a regular basis or when the need arises. To calculate the **exact quantities** to order to ensure there are enough supplies to last until the next order, you need to use the **stock control system** (see also Section 2.2). You also need to take into account factors including **lead time and frequency of orders, reserve stock, minimum and maximum stock**. Information about these factors should be recorded on stock cards.

### Lead time and frequency of orders

The length of time between placing an order and receiving the items is called the **lead time** (or the **delivery time**). The lead time and the frequency of ordering will affect the quantities you order. The less frequently you place an order, the larger the quantities of each item you need to order to maintain stocks until the next delivery. On the other hand, if orders are placed frequently, you need to order less to maintain stock levels between deliveries.

### Stock levels

The **stock level** is the quantity of an item that is available for use in a given period of time. The **reserve stock** (sometimes also called **safety stock** or **buffer stock**) is the lowest level of stock for each item, and quantities should not be allowed to fall below this level. Your reserve stocks are essentially extra supplies to ensure that there are no stockouts if there is an unexpected increase in demand or a delay in receiving supplies.

The quantity of reserve stock depends on the **average monthly consumption** and the **lead time**. Use information about average monthly consumption and Table 2.2 to help you estimate the amount of reserve stock.

**Average monthly consumption (AMC)** is the average quantity of an item that is issued each month over a period of months. It takes account of seasonal variations in demand and is calculated using the following formula:

$$\text{Average monthly consumption} = \frac{\text{Total quantities issued in the time period}}{\text{Number of months in the time period}}$$

Using Table 2.2, if, for example, the lead time is 2 months for a particular item you would need to have an extra 1 month's stock as a reserve stock.

Table 2.2 Lead time and reserve stock		1 month	2 months	3 months	6 months	12 months
<b>Lead time</b>						
<b>Reserve stock</b>		2 weeks usage	1 month usage	1.5 months usage	2 months usage	3 months usage

If there are factors that could increase lead times, for example, bad roads, unreliable transport or conflict, consider increasing the amount of reserve stock.

The **minimum stock level** (sometimes called the **re-order level**) is the stock level that indicates you need to place an order to avoid running short of supplies. The minimum stock level can change over time, so check it regularly and make any necessary adjustments to the stock card and your orders. To calculate the minimum level, use the formula:

$$\text{Minimum stock level} = \text{Reserve stock} + \text{Stock used during lead time}$$

The **order quantity** is the quantity of items that is ordered to be used in one supply period, and it depends on the length of time between orders (i.e. frequency of ordering) and average monthly consumption. If, for example, you place an order every 6 months, the quantity ordered should maintain stocks above the reserve stock level until the next



supplies are received i.e. last for 6 months. To calculate the order quantity, in other words how much you need for the supply period, use the formula:

$$\text{Order quantity} = \text{Time between orders} \times \text{Average monthly consumption}$$

The **maximum stock level** is the maximum amount of any item you should have in stock at any time. You will usually only have the maximum level in stock just after receiving a delivery. The maximum level helps to prevent you from over-ordering. This level can change over time, so check it regularly and make any necessary adjustments to the stock card and your orders. To calculate the maximum stock level, use the formula:

$$\text{Maximum level} = \text{Reserve stock level} + \text{Order quantity for one supply period}$$

Table 2.3 shows how you can use the formulae to calculate how much to order, using 5ml disposable syringes as an example.

Table 2.3 Calculating order quantity	
Annual requirement:	480 x 5ml disposable syringes
Time between orders:	6 months
Balance:	120 x 5ml disposable syringes
Lead time:	2 months
Formula	Calculation
$\text{AMC} = \frac{\text{Total quantities issued in the time period}}{\text{No. of months in the time period}}$	Average Monthly Consumption = $\frac{480}{12} = 40$
Reserve stock = 1 month if lead time is 2 months	Reserve stock = $1 \times 40 = 40$
Minimum stock level = Reserve level + Stock used during lead time	Minimum stock level = $40 + (2 \times 40) = 120$
Order quantity = Time between orders x AMC	Order quantity = $6 \times 40 = 240$
Maximum stock level = Reserve level + Order quantity	Maximum stock level = $40 + 240 = 280$
Notes:	
<ul style="list-style-type: none"> <li>- the quantity ordered should replenish the stock to the maximum stock level</li> <li>- adjust the order quantity to the nearest amount which matches the pack sizes available</li> <li>- this calculation must be done for each item on your list</li> </ul>	

Although this method of calculating may appear difficult, with practice it becomes easier to use. Try to learn to use this method, because it is an important approach to help you manage stock and purchasing.

If the above method is too difficult, a simpler method is to calculate the quantity to be ordered by adding the annual amount required to the annual reserve stock and then adjusting the total to the supply period. Again using the 5ml disposable syringe example, the annual amount required is 480, and the annual reserve stock (if the order period is every 6 months,  $2 \times 40 = 80$ ) = 560 packs. Divide 560 by 12 months to calculate the amount required for 1 month and then multiply by 6. So the quantity to be ordered every 6 months will be  $560 \div 12 \times 6 = 280$ .

### Calculating for an increase or decrease in order quantity

To calculate changes in the quantity of an item to order, for example, where an item's rate of use is increasing or decreasing you need to know the **order quantity**, **minimum level** and the **stock balance**. The formula to calculate how much extra or less stock should be ordered is:

$$\text{Quantity to be ordered} = \text{Order quantity} + \text{Minimum order level} - \text{Stock balance}$$

Use this formula, when there is a substantial difference between minimum order level and the stock balance at the time new supplies are being ordered.



## Ordering guidelines

Running out of supplies is a serious problem, and having an oversupply is a waste of money and space. The **Maximum** and **Minimum** (Max/Min) system is a common system for keeping the right amount of supplies and to make sure that you never run out of stock. There are several variations of the Max/Min system and there are also different ways of calculating the maximum, minimum, and order quantity. In some systems, you have to make orders according to a regular schedule, for example once a year or periodically. In others, you are able to order supplies as and when you need to. Use the following to help you decide whether or not to place an order:

- If you place orders on a regular basis, order additional supplies if the stock balance is equal to, or less than, or even greater than the minimum stock level. Table 2.3 shows how you can calculate how much to order.
- If you order supplies as and when you need them, check the stock balance of each item and order enough to take quantities up to the maximum stock level. This is sometimes called a topping up system. Remember that some items such as syringes and needles, cotton wool and other supplies that are used every day need frequent re-ordering to keep stock at adequate levels.
- If the stock balance frequently falls below the minimum stock level, because consumption has increased, you need to revise the minimum and maximum stock levels. (If demand has increased unexpectedly or for no obvious reason, report this to your supervisor.) Review minimum and maximum stock levels regularly, because consumption patterns and lead times for items change. If you do not review these stock levels, you may run short of fast-moving items and/or overstock slow-moving items.
- If the stock balance reaches the equivalent of 1 month's consumption, you need to place an order. As a general rule, the stock balance should not fall below 1 month's supply or exceed 2 month's supply at any time.
- If you receive supplies through a kit system, you may not place regular orders. However, you still need to monitor actual consumption, in case kit quantities are not sufficient so that you can order additional supplies.

## Estimating costs

Before you place an order, you need to do a cost estimate, to check you are within budget. Start by making a list like the one shown in Table 2.4 (see Section 1), using catalogues published by government stores, medical supply organisations or manufacturers to obtain prices. Remember to include the costs of consumables and accessories. The total price for each item (Column 4) = Unit price x No. of units (Column 2 x Column 3). The total cost is the sum of all the figures in Column 4. Also as part of the cost estimate you should budget at least an additional 5-7% of the purchase price of capital items of equipment to cover the cost of maintenance and running costs.

Table 2.4 **Calculating costs**

1: Item	2: Unit price	3: No. of units	4: Total price
<b>TOTAL COST</b>			

If you are importing supplies or equipment, you also need to consider the costs of import duties, pre-shipment inspection, customs clearance, freight and insurance, transport, handling and storage. If the total cost is more than your budget, the best approach is to decide which of the 'not so essential' items you can do without. Avoid reducing quantities of 'vital' and 'essential' items.

### Practical tips for budgeting

- Obtain at least three quotations.
- Remember to include costs of import duties, pre-shipment inspection, customs clearance, freight and insurance, transport, handling and storage.
- Ask for advice about these costs from the supplier.
- As a general rule, add 20-30% to the cost of the item(s) to cover freight and insurance costs and, for items of capital equipment, add 5-7% to cover maintenance and running costs.
- If the total cost is more than your budget, decide which of the 'not so essential' items you can do without.

## Freight and insurance charges for imported goods

Freight charges vary enormously, depending on the volume and weight of the items ordered, the type of goods (for example, hazard or heat-sensitive goods), mode of transport (sea, land or air) and distance. The value of freight is based on the weight or volume of the goods rather than on the value of the goods. Hazardous or heat-sensitive goods can cost considerably more to transport and may be restricted to particular modes of transport. For example, laboratory reagents, which are flammable, require special packing and documentation, and vaccines, which must be kept cold during transport, require an effective cold chain.

The insurance charge is related to the value of the goods. A freight contract that includes insurance is more expensive, but insuring goods against loss or damage is very important. If you insure goods, you can make a claim if they are lost or damaged during freighting. This usually takes the form of a refund, a credit or replacement of goods. You cannot make a claim for loss or damage if you did not insure the goods.

When you are putting together a budget add approximately 20-30% of the cost of the order to cover the cost of freight and insurance. For example, if the total cost of the item ordered is US \$100, then you need to add US \$20-30 to your budget, to cover the cost of freight and insurance. Ask your supplier or freight forwarders for estimates of freight and related insurance costs before placing the order. Responsible suppliers will advise on the best way to freight and insure goods.

Table 2.5 **Freight terms**

Suppliers use a range of freight terms. These are referred to as INCOTERMS (International Chambers of Commerce Terms) and are often given as acronyms or initials. As a purchaser, you need to know what these initials mean. The most commonly used are:

**CIF** (Cost, Insurance, Freight) – if you are ordering from a local supplier, CIF means that the price includes delivery to your store. If you are ordering from a supplier outside the country, CIF means freighting of goods to the 'port of entry' i.e. sea or airport, but you are responsible for any costs after the goods have been unloaded, for example, clearing customs, transport.

**C&F** or **CFR** (Cost and Freight) – means the same as CIF, except the purchaser is responsible for insurance of goods during transport and delivery.

**FOB** (Free on Board) – the supplier arranges for all costs up to the port and time of shipment, and the purchaser is then fully responsible for freight and insurance of the goods.

**EXW** (Ex-Works or Ex-Warehouse) – the price of the goods includes no freighting or transport costs, and the purchaser collects the goods from the supplier and arranges freight and insurance.

**CPT** (Freight and Carriage Paid) – the supplier arranges freighting of the goods directly to the agreed destination, but the purchaser must arrange insurance.

**CIP** (Freight, Carriage & Insurance Paid) – is like CPT but the supplier arranges insurance on the purchaser's behalf against damage or loss of goods in transit.

**FCA** (Free Carrier) – the supplier arranges to deliver goods to a 'named' freight forwarder. For example, ECHO will deliver to a destination in the European Union and the freight forwarder and purchaser take full responsibility for the goods from there.

## Pre-Shipment Inspection

Pre-Shipment Inspection (PSI) involves inspection of goods before they are shipped, to check the quantity and quality of goods to be exported and to ensure that they are fit for their intended purpose and are adequately packed for shipment. PSI is a legal requirement for some countries for customs clearance or import. PSI may be required for shipments of all goods, or it may only be required for shipments over a certain value. You need to check current procedures with your national customs department, as well as with your supplier. Failure to comply with PSI requirements can cause delays in customs clearance and extra expense, or can result in goods being confiscated or returned. Be aware that you, as the buyer, must request PSI.

## Identifying suppliers

You need to decide, if you have a choice, whether to order supplies locally or internationally and to select a supplier. Criteria for selecting a supplier (see also Section 1) include:

- Price
- Quality
- Delivery times
- Guarantees and warranties
- Reputation
- Reliability

Potential suppliers include wholesalers and retailers, manufacturers, central medical stores, and non-profit supply organisations, for example, European suppliers such as Action Medeor, ECHO International Health Services, and IDA, JMS in Uganda and MEDS in Kenya.

You need to make a careful comparison of local and international costs. The prices charged by international suppliers may seem to be lower, but imported products often have additional costs, such as import duties, freight, handling and insurance. Whenever possible, obtain quotations (a request for a price) from at least three suppliers so that you can compare prices.

Do not select a supplier on the basis of price alone. The cheapest suppliers may provide poor quality products, delivery and service. Although equipment may be supplied with a guarantee or warranty, check that the manufacturer or supplier is liable for repairs and maintenance. If there is no authorised agent or representative in your country, you may find you have to send the item back to the manufacturer and this could be very costly.

Try to find out about other factors such as reliability and delivery times. After you have selected a supplier, monitor their performance to ensure that they continue to provide good service.

Certain conditions may be attached to funding for equipment and supplies from donor agencies. For example, donors may stipulate that you must obtain a minimum of three quotations and that items must be BP or CE marked or ISO approved.

## Placing an order

Place your order using an **order form** (see example in Figure 2.1 below). Some health facilities use **requisition forms** or books for ordering supplies from district or national stores. Each order is numbered sequentially. Pre-printed requisition forms make ordering easier and help to avoid mistakes.

When placing an order or re-ordering:

- Check the stock records to find out the stock balance and decide what items and how much of each item you need to order.
- List the supplies to be ordered alphabetically and in sections, for example, drugs, equipment, consumables. Only include one item and one item size on each line. If you are ordering from a catalogue, write down the catalogue code number for each item.
- Provide a full and clear description of each item.
- Specify the quantity of each item. Place orders for complete packs. For example, if you need 34 rolls of crepe bandage and a pack contains 12 rolls, order 3 packs.
- Check that all copies of the order are easy to read and signed by an authorised person.
- Check that the order includes your full contact details and, if you are not the recipient, include the contact details of the person, agency or institution to which the goods should be delivered.
- Make at least two copies of the order. Keep one copy in the health facility and send one copy to the supplier.
- Specify, if appropriate, whether the item is to be delivered or collected, the method of shipment (for example, sea, land or air), contact details of the organisations responsible for shipment and payment, and instructions for packing (for example, carton size and weight).
- Include any other special instructions (for example, no delivery at weekends or during holidays) and, if applicable, account number.

Figure 2.1 **Sample order form**

Consignee (recipient):		Health facility:			
Date:		Authorised signature:			
Code/Cat. no	Description	Unit size	No. of units	Unit price	Total value
ET181P	Bandage crepe 5cm	12 rolls/pack	4	£2.35	£9.40
ET18104P	Bandage crepe 10cm	12 rolls/pack	2	£3.90	£7.80
ET182P	Cotton wool absorbent 500g, paper wrapped	1	5	£1.50	£7.50
ER13001P	Microscope slides, 76 x 26mm, 1mm thick,				

## Specifications

A specification is a detailed description of an item. It is important to provide suppliers with a clear and complete description, to make sure that you receive the specific item you require. It is usually better to write generic specifications that describe items by type rather than by brand name. However, there may be times when you need to specify an exact model or manufacturer, for example, for particular products such as microscopes.

Figure 2.2 **Sample specification form**

	Example 1	Example 2
<b>Purpose</b>	Forceps dissecting	Syringe disposable
<b>Features</b>	14cm, spring type, 1 x 2 teeth	2ml, fixed 21G needle, plastic wrapped
<b>Material</b>	Stainless steel	Disposable plastic
<b>Pack size</b>	Pack of 1	Pack of 100
<b>Quantity</b>	4	2

- **Purpose** – what the item will be used for, e.g. general purpose forceps, dressing forceps, dissecting forceps, episiotomy scissors.
- **Design and features** – e.g. manual, electric or battery operated and the type of battery needed; length, height and width; toothed or plain; wheels or no wheels; handles; curved angled or straight; sharp or blunt; small or large; sterile or non-sterile.
- **Material** – e.g. stainless steel, sterilisable plastic, disposable, paper packed or plastic packed, epoxy coated, fine or robust.
- **Consumables, accessories and spare parts** – e.g. additional items required to use an item such as bulbs for lamps. Remember that while some equipment uses standard supplies, other equipment requires specific supplies, and you will need to order accordingly.
- **Unit or pack size** – the number of items in each unit or pack, e.g. 12 rolls of crepe bandage or 100 syringes.
- **Quantities** – the exact quantities or number of units or packs required, e.g. 5 packs of 12 rolls of crepe bandages.
- **Safety** – e.g. power requirements for equipment, equipment earthed, pin plugs compatible with 3-pin plug with 3-way socket or adapter, type of battery.

Other specification considerations include:

- When ordering things that need to be used together, e.g. needles and syringes, battery-operated items and types of batteries, pay particular attention to specifications to ensure that you order compatible items.
- When ordering electrical items, include information about voltage frequency, wattage and Hz requirements for your facility.
- When ordering spare parts, provide as much information as possible, e.g. manufacturer, model or type of equipment the spare part is for, spare part serial number, a description of the part, and if possible a diagram including accurate measurements.
- When ordering chemicals, reagents and stains, provide the correct name and, if possible, the chemical formulae, and indicate whether you require powder, liquid concentrate or ready-made preparations.

Sometimes a supplier may offer an alternative, if they are unable to supply the specified item. Check that the alternative is appropriate for your needs and affordable within your budget. For example, 14cm instead of 12cm scissor dressing may be acceptable, but 19G instead of 23G disposable needles may not be appropriate.

### **Practical tips for ordering**

- Develop written procedures and assign responsibility for ordering.
- Only order items your health facility needs and is authorised to keep.
- Carry out a stock take before ordering more supplies.
- Ask for quotations before placing orders. Use the same format as an order form, but state clearly that it is a quotation request. Also ask for a pro-forma invoice, which provides a complete breakdown of costs and which also makes ordering easier.
- Keep records of past orders that show supplier contact details, code and catalogue numbers, and unit quantities, to help you make subsequent orders.
- Fill in order or requisition forms clearly. Provide as much detail about requirements and specifications as possible to avoid supply of incorrect items or quantities or delays in filling your order.
- Each supplier will have its own forms. It is particularly important to fill out the forms from your national supplier. For other suppliers, you may not need to fill out the form as long as you provide the relevant information.
- Make sure that equipment is supplied with the necessary consumables, accessories and spare parts or, if not, order these at the same time.
- For goods with expiry dates, specify in your order the minimum expiry dates required (i.e. the expiry date from the time of arrival of goods in-country).

## Handling donations

Procurement also includes donation of drugs, supplies and equipment. Donated goods can be of great value to health facilities with limited resources, but donations are not always useful or totally 'free'. For example, recipients may have to pay for customs clearance, storage, insurance and transport. There are also costs associated with staff time to organise arrangements and sort out what is and is not useful, and with disposing of inappropriate items.

Health facilities with limited resources are often worried about refusing or complaining about donations. Do not feel obliged to accept donations unless the goods being offered are appropriate to your needs. Establish and use donation guidelines and policies, or use the practical tips in the box to help you manage donated supplies.

### Practical tips for receiving donations

- Decide what supplies and equipment are needed and in what quantities, and prioritise the list of items you plan to request.
- Check that national regulations allow these goods to be imported.
- Check that the donor has the capacity to fulfil the request.
- Provide potential donors with clear and comprehensive information about the items needed and how they will be used.
- Before agreeing to accept a donation, check that the supplies being offered conform to national policy or the WHO Drug Donation Guidelines or WCC/CISS Guidelines on Medical Equipment Donations and are suitable for your facility and staff. Confirm who will be responsible for covering the costs of transport, freight, insurance, import duties and customs clearance. If the supplies include drugs or sterile supplies, check that these will have an adequate expiry date (at least a year or half the shelf life if the expiry date is less than a year).
- When donations are received, check expiry dates and labelling, make sure that equipment is fully functioning and is supplied with relevant manuals, spare parts and consumables, and, where appropriate, accessories.
- Confirm receipt of donated goods with the donor, including providing information about the condition and appropriateness of the goods.
- Keep a record of all donations received, including those you have not requested, and inform donors of unsolicited donations.
- Refuse inappropriate donations and provide an explanation of the reasons for refusal.

Donor organisations have a responsibility to make sure that they donate appropriate medical supplies, equipment and drugs. For example, equipment should be in full working order and supplied with all technical documents and enough consumables and spare parts for 2 years.

Donors should only provide donations in response to requests, and should know or find out about the recipient, confirm the need for the donation, and check their capacity to handle donations. It is important to ensure that the recipient provides clear specifications of the items required. If offering alternatives, donors should check with the recipient that these alternatives are acceptable.

Before sending donations, it is essential to obtain consent from the recipient and to agree who will cover the costs of international and local transport, freight and insurance, warehousing, clearance, storage and handling. Finally, donors should confirm what items are being sent and when these will arrive so that the recipient can plan to receive them.

## 2.2 Storage and stock control

### Organising the store

Most of your stock of drugs and other supplies will be kept in a store, from which they are issued when needed. Supplies should be stored according to the manufacturer's instructions. Proper storage conditions are important to protect stock from deterioration and damage. The store should be:

- Secure
- Clean
- Free from pests
- Dry
- Not too hot or cold
- Well ventilated
- Not exposed to direct sunlight

To ensure security, keep the store locked. Make one person responsible for looking after the supplies, keeping the keys and locking the store. Appoint someone else to be in charge when the person normally responsible is away. Avoid having more than two sets of keys, and make sure there is always one set available at the health facility.

Keep the store room clean, because dirt attracts insects and rodents. If the store room has windows, put up curtains to keep out direct sunlight. Keep a thermometer in the store room and monitor the temperature daily. If the store room is too hot or poorly ventilated, improve air circulation by installing a fan or perforated airbrick.

Many items, such as laboratory reagents, are made in countries with cool climates so, for example, instructions to protect from excessive heat mean store below 25-30°C. Standard storage temperatures for different instructions are provided in Table 2.6.

Table 2.6 Standard storage temperatures

Description	Temperature range
Protect from excess heat	25-30°C
Room temperature	15-25°C to 30°C (depends on local conditions)
Keep cool	8-15°C
Refrigerated	2-8°C
Frozen	Below 0°C

The storeroom should have enough space to put all your medical supplies on shelves or pallets. Organise the store in a simple and logical way so that items can be found quickly and easily, using the following guidelines and the diagrams.

- Make your own shelves using planks of wood supported on bricks or crates, if there is no shelving in the store room.
- Make use of the space in the middle of the room for shelves. Putting shelves all around the walls takes up a lot of space and wastes the space in the middle of the store.
- Store supplies raised off the floor on open shelves or pallets, or in locked cupboards, to protect them from damp and pests.



- Organise the stock into different sections for different categories of supplies, for example, drugs, dressings, instruments, medical stationery, equipment and spare parts, laboratory supplies, disinfectants.
- Clearly label each section of the store, allocate each item to a specific place and label the position of the item on the shelf so that it is easy to read.
- Arrange categories of supplies with a large range of items, such as dressing materials, in alphabetical order.
- Divide supplies into regular use and reserve stock, placing the reserve stock on the same shelves behind the regular use stock. Keep a reserve stock of instruments that are used frequently, such as scissors, suture needles and forceps.
- Remove a whole unit at a time. Partly opened units should not be kept in the store room, but should be kept as limited 'working stocks' for daily use in the relevant service area of the health facility.
- Rotate stock according to the expiry date using the SLFO (Shortest Life First Out) and FIFO (First In First Out) rules. Put items that have the latest expiry date at the back and items with the earliest expiry date at the front. Use the FIFO rule for items without an expiry date and mark these with the date of receipt.
- Put a red star or a similar mark on the labels of all items that have an expiry date within the current year.
- Remove expired, damaged or obsolete items from the shelves and dispose of them according to approved procedures (see Section 2.5).

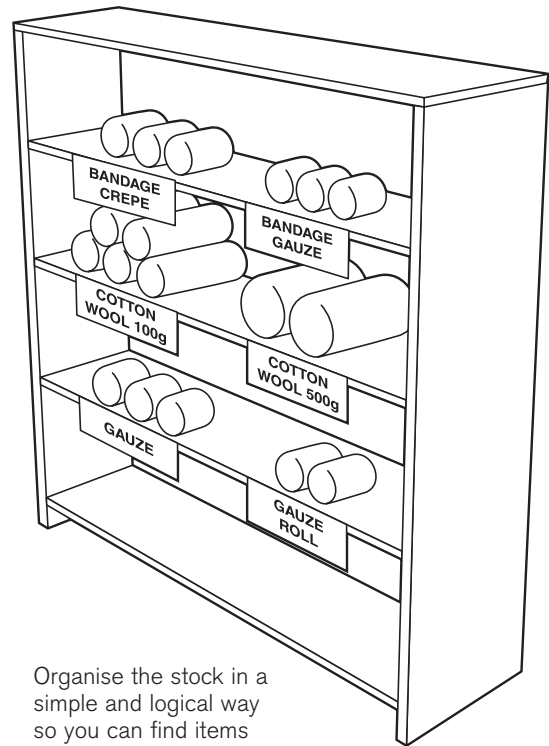

Organise the stock in a simple and logical way so you can find items quickly and easily

## Stock control

Stock control is about the management of supplies in a health facility. Stock control includes keeping accurate and reliable records of stock received and issued, stock taking (checking stocks on a regular basis), and carrying out an inventory of stock at least once a year. A stock control system uses tools such as stock record cards and a stock control ledger. Effective stock control is important to help you order the right quantities of supplies and equipment and, ideally, you should carry out a stock take before placing an order for more supplies.

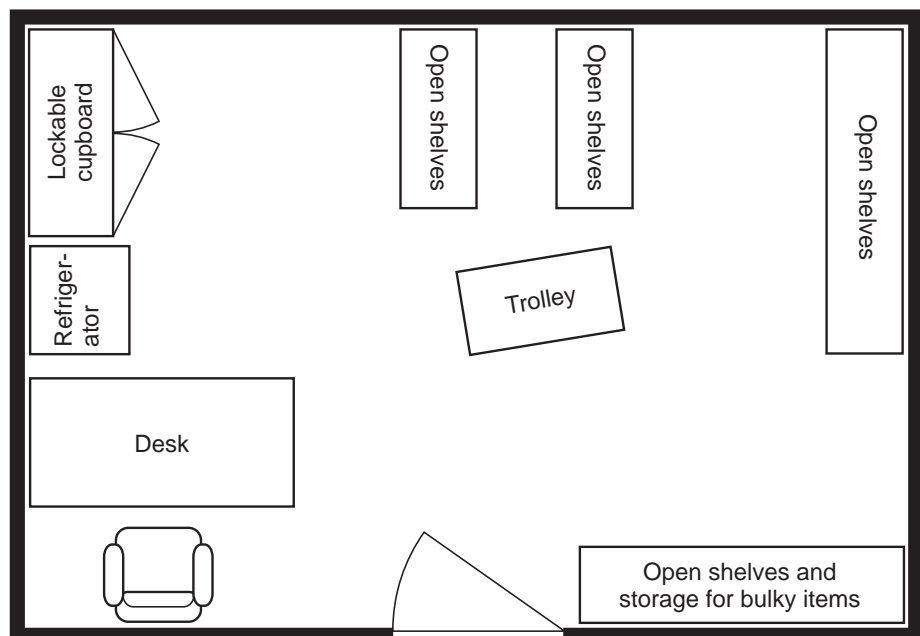

Floor plan of a small medical storeroom



## Store records

Every health facility needs a system for recording stock movement. Reliable record keeping is very important, because errors caused by poor record keeping will affect service delivery. For example, if stock records used to estimate requirements are not accurate, you may order too much or too little. Accurate record keeping depends on easy to use, well-designed methods and forms. Stock cards (stock record cards) and stock control ledgers are the simplest, and examples are provided below.

**Stock cards** are kept for each type of item in stock. Although time consuming to keep up to date, stock cards have many advantages. They provide information about quantities received, issued and in stock at any time, can be used to calculate orders, and are a useful tool for preventing shortages and over-stocking (see Figure 2.3 below). Stock cards help supervisors to monitor overall consumption and use by different services, and to check stock levels, assess wastage and identify theft.

Figure 2.3 **Sample stock card**

Item:		Unit/pack size:		Card no.		
Strength/size:				Code no.		
Maximum level:		Reserve stock level:		Lead time:		
Minimum level:		Order quantity:				
Date	Received from/ Issued to	No. received	No. issued	New balance	Remarks	Signature

### Notes:

1. Make sure each item and each item unit pack, size, strength etc. has its own stock card, e.g. disposable needle 21G, disposable needle 19G.
2. Item: name of the product.
3. Code no.: the national code no. if applicable.
4. Card no.: optional, although numbering cards makes retrieval and filing easier. Cards for the same item should be serially numbered.
5. Strength/size: of the item, e.g. 21G needles.
6. Unit/pack size: no. of units in each pack, e.g. 100 needles/box.
7. Lead time, Order quantity, Minimum level, Maximum level, Reserve stock level: see Section 2.1.
8. Record quantities issued or received each time there is a transaction.
9. Calculate and record the new stock balance (old balance + quantity received or – quantity issued).
10. Record important information in the remarks column, e.g. expiry date, special conditions for storage, price, supplier, stock take count, unexplained gains and losses, stockouts, average monthly consumption.
11. All transactions should be initialled.

Once a month the information on the stock cards is transferred to the **stock control ledger**. It is simpler to make an order using the summary in the stock control ledger than using all the individual stock cards. The stock control ledger is also a useful tool for analysing stock management and reviewing the accuracy of stock levels (see Figure 2.4 below). You can either obtain a stock control ledger from the district health team or make one yourself, using a separate page to keep records for each type of item.

## Figure 2.4 Sample stock control ledger forms

Example 1

Item:		Code no.			
Unit/pack size:		Order quantity:			
Date	Quantity received	Quantity used	Balance	Quantity to order	Signature

Example 2

Item:		Code no.				
Unit/pack size:		Order quantity:				
Order quantity:						
Date	Previous count (physical)	Amount received	Amount used	Present count (physical)	Quantity to order	Signature

### Practical tips for stock storage and record keeping

- Assign responsibility for stock control and the store room and develop written procedures.
- Keep the store room tidy and well organised. An organised store saves time when ordering or locating items and prevents stock from getting lost.
- Avoid wastage by rotating stock according to expiry dates and FIFO.
- Store drugs, medical supplies and equipment separately, if possible in a different store room, from linen, food and non-medical supplies.
- Make sure store records are completed regularly.
- Keep stock cards in the storeroom. This enables the person responsible for stock control to update the cards after every transaction (ordering, receiving and issuing stock). Write each transaction on a separate line, even if there is more than one transaction on the same day.
- Record any stockouts on stock cards and report these to your supervisor.
- Store stock cards together in a box or keep each card with the stock in the correct place on the shelves.
- Keep and file old cards.
- Carry out random checks to ensure that record cards are being updated regularly and accurately.

## Receiving supplies

Make sure at least two people receive and check supplies. It is important to check supplies received before you put them away in the store. Otherwise you may only discover that an item is incorrect, damaged or poor quality when it needs to be used and when it is too late to ask the supplier for a replacement. The following simple checks can avoid these problems and save time in the long term:

- Check the delivery note, packing list and contents against a copy of the order.
- Check the contents and number of boxes against the packing list.
- Check the outer and inner packaging to make sure it is intact and for signs of damage, for example, spots, breakages, leaks, missing labels, tape or lids.
- Check labels are legible and include complete information, for example, the approved name, strengths, storage instructions, manufacturer's details, and expiry date.
- Check that all spare parts, accessories, instruction manuals, and warranty documents are included.
- Check that the voltage shown on your packing list (or packing case) for electrical equipment is compatible with your power supply. Also check that the fuse rating is correct.
- Check the temperature monitor that comes with vaccines to see if there has been any colour change. Record the temperature of the vaccines on the delivery note. If the colour has changed or the temperature is incorrect, there may be a problem with the cold storage used during transport and you should report this to the supplier. Put vaccines and other heat sensitive supplies in the refrigerator at once.
- Check the shelf life and expiry date. Do not accept items if the expiry date has passed. Only accept items nearing the end of their shelf life if you are sure you can use them before the expiry date. The expiry date is the time up to which the manufacturer guarantees the quality of the product and many products, e.g. laboratory reagents, sterile dressings and syringes, are only fit for use for a limited time.
- Check that you file delivery documents with the order forms.
- Check that you keep the manuals together in a dry, safe and easily accessible place.

Report any problems to the supplier and the carrier immediately, explaining the nature of the problem, for example under-supply or damaged goods. Do not use damaged goods.

When you unpack supplies, enter the details on the stock card and enter new items in the **inventory**. It is also important to keep a **goods received record** for equipment items, listing the supplier, date, invoice number and the serial number or other unique identification. Register the guarantee or warranty if necessary. Keep all equipment packaging materials in case you need to transport it again in future.



Make sure at least two staff members receive and check supplies

## Issuing supplies

Every health facility also needs a system for recording issue of supplies. The most common method is an **issue book** or **issue voucher** (see Figure 2.5 below). The following information should be recorded every time an item is issued: date of issue, item and quantities issued, name of receiving service or individual, and the signature of the recipient. Give a copy of the issue voucher to the recipient for their records.

After issue, the receiving service or individual should be responsible for care of the item and accountable for loss or breakage. For example, microscope care should be the responsibility of the laboratory or the laboratory technician in charge.

Figure 2.5 **Sample issue voucher form**

Date	Item	Quantity issued (units)	Issued to	Remarks	Signature

## Stock taking

Regular stock taking is an important part of stock control. A stock take involves physically counting what is in stock and comparing the counted figures with the balance figures on the stock cards, checking expiry dates and the condition of stock. If there is a difference between the counted figures and the balance figures on the stock cards, you need to find out why. For example, stock may have been received or issued without being recorded or may have been stolen. Ideally you should carry out a stock take before ordering more supplies. If this is not possible because you order stocks very frequently then carry out a stock take at least three times a year.

## Inventory of stock

An **inventory** is a list of non-expendable supplies and equipment that are kept at the health facility (see Figure 2.6 below). The person in charge of the health facility should keep a master copy of all items and update this list each time an item is received and issued. Each PHC service or section should keep its own working copy and update their own list. The person in charge of each service should keep an updated list of all the equipment and supplies they receive and include items damaged, broken or sent for repair.

An inventory should be carried out at regular intervals (at least once a year) to check the condition and location of supplies and equipment in use and in stock. Checking the inventory of stock is an important part of stock control and helps to identify purchasing requirements. However, it is often forgotten and so it may be useful to have a set time or times each year for inventory checking.

Figure 2.6 **Sample inventory form**

Date of inventory:		Service/section:	
In-charge name:		Title:	Signature:
Witness name:		Title:	Signature:
Item description	Record		Remarks (e.g. action required, action taken)
	Functional	Non-functional	

### Practical tips for receiving and checking stock

- Check all supplies received carefully and immediately before unpacking, putting away and completing paperwork.
- Check packaging of sterile items for damage. If packaging is damaged, products should only be used if they can be re-sterilised before use.
- Check a random sample of stock for damage or deterioration on a regular basis. Remove damaged or expired stock and dispose of safely.
- Carry out a regular stock take and inventory and investigate the reasons for differences in physical counts and stock cards.
- Review whether quantities of stocks used are reasonable or excessive.

## 2.3 Care and maintenance

Proper maintenance affects the performance and safety of equipment. Poorly maintained equipment deteriorates more quickly and is more likely to break down. Unreliable or inaccurate equipment is often worse than no equipment at all. A steriliser, for example, with a leaky seal will not sterilise its contents properly.

Both day-to-day maintenance by users and Planned Preventive Maintenance (PPM) are essential to keep equipment in good working condition. This section discusses user maintenance and PPM, illustrated by examples of practical care and maintenance of items of equipment including stainless steel instruments, microscopes, steam sterilisers, and refrigerators.

### User maintenance

Health facility staff play an essential role in routine care and maintenance of instruments and equipment, especially cleaning, checking for damage and reporting any defects. Important care and maintenance tasks include:

- Keeping all items clean and dry.
- Protecting items from dust and dirt after use by keeping them covered.
- Switching off and unplugging items when they are not in use.
- Storing items properly when they are not in use, e.g. keeping scissors closed and diagnostic sets in their case.
- Checking and oiling wheels, e.g. wheels on trolleys.
- Checking screws and tightening loose screws.
- Replacing lost, worn, cracked or broken parts, e.g. stethoscope earpieces and diaphragms, and rubber seals in sterilisers.
- Removing batteries when battery-operated items are not in use to prevent corrosion.
- Keeping scissors sharp.
- Unscrewing stethoscope earpieces and removing any aural wax.
- Inspecting bedframes for cracks and splits, e.g. where the legs join the frame.

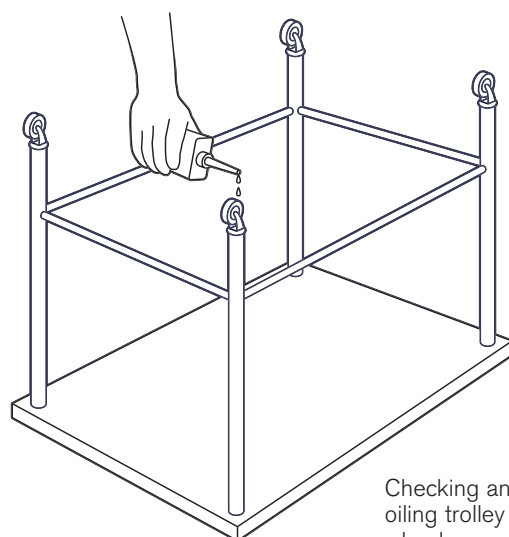

You can help to remind staff about these care and maintenance tasks by putting written instructions near the equipment.

## Practical tips for steam steriliser care and maintenance

- Clean the inside of the steriliser after use and check regularly for signs of wear and damage. Regularly clean the nozzle that the weights rest on.
- Check for steam leakages around the lids and valve. If there is a problem, turn off the heat, open the pressure valve and wait for the steriliser to cool.
- If steam is leaking out from under the steriliser lid, check the position and quality of the rubber seal and adjust or replace it.
- If steam is leaking out from the safety valve, check the position of the valve and adjust or replace it.
- If you cannot solve the problem, use another steriliser and inform your supervisor.

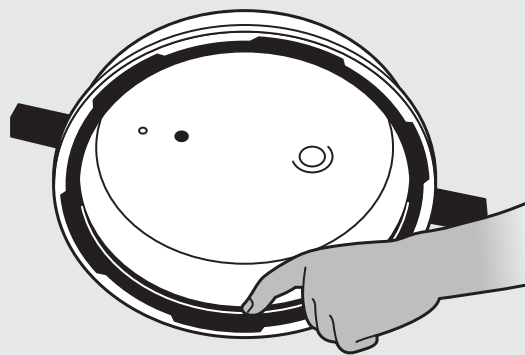

Checking the rubber seal is in place and is in good condition

## Planned Preventive Maintenance

Planned Preventive Maintenance (PPM) is a regular service, recommended by manufacturers and carried out by trained technicians, to check equipment performance and replace parts. PPM should support and supplement user maintenance carried out by staff using the equipment. The frequency of PPM depends on the type of equipment and the manufacturer's recommendation. PPM can double the life time of equipment and reduce breakdowns. For example, a microscope will last around 15 years with proper care and maintenance but only around 8 years if it is not looked after properly. Refrigerators and weighing scales should last for about 8 years, sterilisers for about 6 years, and ward beds about 12 years.

Manufacturers and suppliers usually provide maintenance and repair services, but may not have representatives or authorised service agents in every country. If there is no representative or authorised agent in your country, you will need to identify a specialised organisation that can provide PPM for particular items of equipment, such as the technical unit of your local hospital. All maintenance and repair should be carried out according to the manufacturer's instructions.

## Practical tips for microscope care and maintenance

### User care and maintenance:

- When the microscope is not in use, keep it covered with a cotton dust cover. Do not keep the microscope in a closed wooden box.
- Before using the microscope, wipe it with a clean cloth to remove any dirt and dust, and clean the lens with lens tissue or a separate piece of clean cotton cloth.
- At the end of each day's work, switch off the microscope and remove the plug from the mains socket.
- Clean the microscope thoroughly according to the manufacturer's instructions – mild soapy solution is suitable for most cleaning purposes.
- Use a rubber bulb to blow air over the microscope to remove dust particles.
- Remove oil residue from the lens with clean lens paper, soft toilet paper or soft cotton cloth.
- Clean the optics with a special solution of 40% petroleum ether, 40% ethanol and 20% ether.
- Ethanol can be used for cleaning mirrors, but do not use ethanol for cleaning lenses, because it dissolves the cement.
- Never dip the objectives in xylene or ethanol because the lenses will become unstuck.
- If the microscope is not going to be used for a few days, put it in a sealed, airtight plastic bag (made from thick polyethylene not PVC) with a packet of silica (silica absorbs moisture from the air). This will protect the microscope from fungal growth and corrosion.
- Do not store the microscope without the eyepieces unless the holes are plugged.
- Report any problems to your supervisor.



Keeping the microscope clean and dust free

### Planned Preventive Maintenance:

- Periodically check and clean mechanical parts (adjustment, focus, stage etc).
- Remove any fungal growth.
- Lubricate according to manufacturer's instructions.
- Check optical alignment and spring load.
- Check the integrity of electrical grounding.
- Clean and inspect the microscope for signs of damage.

## Practical tips for care and maintenance

- Develop a maintenance strategy that includes both user maintenance and PPM.
- Remember that spending a little money on routine servicing while a piece of equipment is working will improve its efficiency and extend its life.
- Train users in correct use, care and maintenance of equipment.
- Prepare clear instructions and a maintenance checklist for use of each item of equipment. Place the checklist, which should include a cleaning and maintenance schedule and action to be taken if the equipment fails, near the equipment.
- Keep a stock of spare parts e.g. lamps, fuses, and rubber seals. Make sure you order and use spare parts specified by the manufacturer. Incorrect parts can affect performance and safety.
- Identify one person to be responsible for organising maintenance and for arranging in-house repairs and sending equipment away for repair.
- Set up a system for reporting defects and encourage staff to report problems immediately.
- If the district health office is responsible for maintenance and repairs, follow district procedures for reporting and dealing with breakdowns and faults and for replacing equipment.
- Identify local technicians who can perform basic maintenance and repairs, but check their competence and training carefully. Equipment can be damaged if technicians without appropriate skills or experience try to repair it.
- Find out if there is an authorised agent that provides periodic maintenance (PPM) checks or a specialised organisation with the capacity to carry out PPM.
- Make sure you have arrangements in place for accessing specialist technical skills for servicing and repair.
- Keep a detailed record of faults reported, maintenance and repairs. If there are long delays between fault reporting and fault repairing, review your system.
- Keep equipment record cards for all items of equipment. On one side of the card, record details of the model, date of purchase, source, replacement parts, accessories and consumables and the manufacturer's recommended maintenance schedule. On the other side, record maintenance and repairs carried out.

## Stainless steel instruments

Surgical instruments are made of stainless steel (SS), anodised aluminium, chrome-plated non-ferrous heavy metals, silver, titanium and plastic. Most instruments are made of stainless steel. SS instruments containing chromium and carbon are subjected to special heat treatment to give them the elasticity or hardness required for their particular purpose.

Tungsten carbide (a hard metal) inserts extend the working life of a SS instrument. Instruments with tungsten carbide are more expensive but have a greater resistance to wear and tear and last longer than those made with ordinary SS. Instruments containing tungsten carbide are easily recognisable because they have gold plated bows.

The appearance, performance and working life of SS instruments depends on the quality of the SS and on proper handling, storage and care. SS instruments will stain, rust or corrode if they are not cleaned and sterilised correctly.



## Reasons for damage to SS instruments

- Not cleaning and drying or lubricating the moving parts of new instruments before first use.
- Not cleaning instruments immediately after use or after they have been in contact with corrosive agents, such as iodine tincture, silver nitrate preparations, mercury compounds.
- Not cleaning instruments properly, leaving traces of blood, pus and other secretions.
- Not rinsing instruments properly, leaving traces of detergent or disinfectant.
- Not drying instruments properly, leaving water trapped in joints.
- Using very hot water, which causes protein substances, such as organic matter, to coagulate and stick.
- Using corrosive detergent or disinfectant solutions.
- Storing instruments in saline or disinfectant solutions for long periods of time, or allowing saline solution to dry on the instruments.
- Re-using the same disinfecting solution rather than fresh, clean solution.
- Using tap water with high mineral content (chloride, sodium, calcium, manganese, iron and copper) rather than clean rainwater for cleaning, preparing disinfecting solutions and sterilising.
- Using metal brushes, steel wool or abrasive pads for cleaning, leaving scratches and grooves.
- Mixing instruments made of different metals, for example SS and brass or new and damaged instruments during cleaning, disinfection or sterilisation.
- Using instruments for purposes other than those they were designed for.

## Choosing new instruments

Stainless steel instruments have no standard names and are often known by the name of the person who designed them or by specific features. As a result there is a wide range of instruments with the same function but different names, e.g. mayo, kilner and laurence needle holders. There are also groups of instruments that share similar names but perform different functions, e.g. artery forceps, dissecting forceps and sponge holding forceps. Remember that the most important factor to consider when choosing an instrument is its function and purpose.

Make sure that you buy SS instruments that conform to international, regional or national standards. Quality is important, especially for instruments that you expect to use frequently and to last a long time. Buying the cheapest, low grade instruments can be a false economy, because they may need to be repaired or replaced more often. However, it may not be cost-effective to buy top grade instruments, because it will be expensive to replace them if they get lost. In most cases it is better to buy middle range, good quality instruments. To help you judge the quality of instruments before you buy them, check that:

- Edges of jaws and handles are even and smooth.
- Ends are of equal length.
- Jaws of forceps are of equal thickness, close evenly and are fully closed when on the last ratchet.
- Jaws and tips of hinged instruments are aligned and do not overlap.
- Serrations mesh properly and evenly.
- Blades of sharp and semi-sharp instruments are sharp.
- Ratchets are deep cut as this ensures that the instrument will be held securely when closed, and will glide smoothly, hold firmly and open easily.
- Handle grips are firm.
- Teeth permit a firm grip.
- Bows (finger rings) are comfortable to use.
- Joints are not loose or stiff.

- Surface is smooth, polished or stain finished.
- There are no dull spots, scratches, chips or dents.

It is also useful to remember that:

- Box joints are stronger and more stable than screw joints.
- Passivated surfaces increase resistance to corrosion (passivation is a process that helps to ensure a corrosion-resistant coating of chromium oxide on the instrument).
- Olive-shaped cut outs help to relieve pressure on instruments, which increases their flexibility and working life.
- Serrated edges prevent tissue and suture materials from slipping. Serrations may be coarse or fine, run lengthways or crossways, run the whole way or only part way of the blade (see Appendix 3).

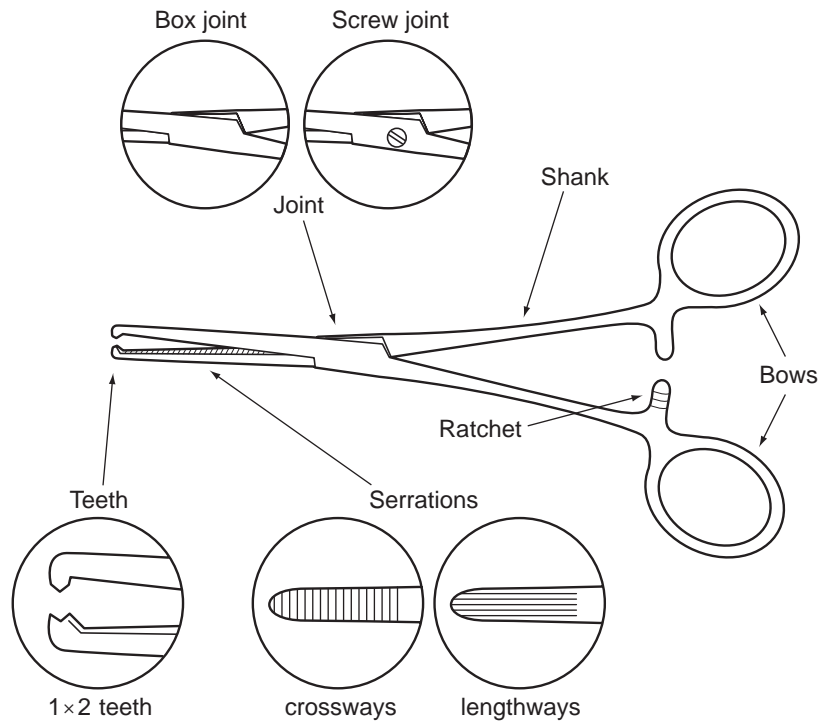

Parts of an instrument

- Ratchets ensure that the instrument will hold firm when closed, and allow the user to grasp or vary the tension. Ratchets vary in strength and some have a self-retaining clasp.

## General rules

Follow the simple rules below for handling, care and storage, to keep your SS instruments in good condition. Guidelines for cleaning, disinfecting and sterilising SS instruments are included in Table 2.7 and in Section 2.4.

- New instruments are supplied without lubricants. Before first use, remove from their packaging, wash carefully, dry, lubricate moving parts, and store in a dry place. Hinged instruments, for example scissors, needle holders, and artery forceps, need regular lubrication.
- Dip instruments in the lubricant one by one, do not soak them in the lubricant. Only use water-based (or water-soluble) lubricants because these allow steam penetration during sterilisation, are anti-bacterial, inhibit corrosion, and prevent joints becoming stiff. Do not use general purpose or oil-based lubricants.
- Every instrument is designed for a specific purpose and should only be used for that purpose. Incorrect use can cause damage. For example, forceps should never be used as pliers or openers, surgical scissors should never be used for cutting gauze.
- Never etch or scratch the instrument surface, for example with the name of the clinic. This removes the protective layer and causes dirt and water to collect in the grooves, which results in corrosion, staining or rusting. Rust weakens instruments and will eventually cause them to break.
- For chemical disinfection, use freshly-made and diluted solution every day. Using the same solution several times reduces its effectiveness and increases the risk of corrosion, because of high concentrations of dirt and debris such as rust particles. The solution may become more concentrated because of evaporation, and this can also cause corrosion.
- Use only detergents or disinfectants recommended by the manufacturer.
- After cleaning, disinfecting and rinsing, store instruments in a dry, clean area that is protected from dust and sterilise when you need to use them. Check that instruments are thoroughly dried before storage.

- Store instruments correctly. For example, scissors should be closed to protect the cutting edge, and forceps closed on the first ratchet to prevent tension and stress.
- Check instruments regularly for damage and to make sure they are working properly. For example, check that scissors are sharp and that forceps align correctly. Handle instruments gently, and avoid dropping, misusing or over-straining them.
- Remember these five steps: **1. Clean; 2. Inspect; 3. Lubricate; 4. Sterilise; 5. Store.**

**Table 2.7 Looking after SS instruments**

<b>Cleaning</b>	<b>Disinfection and sterilisation</b>
<ul style="list-style-type: none"> <li>• Wear gloves for cleaning instruments.</li> <li>• Soak used instruments immediately after use because they are a contamination risk.</li> <li>• Clean instruments in a solution of cool or warm water and a general purpose detergent.</li> <li>• Use soft bristled brushes (e.g. a toothbrush) to remove debris, paying particular attention to box joints, ratchets, teeth, hinges and serrations.</li> <li>• Rinse thoroughly immediately after cleaning with cool or warm water.</li> <li>• Dry instruments thoroughly. Do not use cotton wool for drying.</li> </ul>	<ul style="list-style-type: none"> <li>• Check the instruments are clean and dry and inspect for damage.</li> <li>• Lubricate moving parts with a water-soluble lubricant.</li> <li>• Make sure all jointed or hinged instruments are open and keep them open by hanging them on a 'mayo' safety pin or in a specially designed rack.</li> <li>• Place instruments with curved jaws so that all the jaws are pointing in the same direction to protect the tips.</li> <li>• Close instruments with ratchets to the first ratchet notch only.</li> <li>• Make sure instruments are not piled on top of each other or overpacked in the boiler or steriliser.</li> <li>• If you have the choice, instruments should be sterilised rather than boiled.</li> </ul>

## Refrigerators

Your refrigerator provides a safe and reliable cold storage facility. The refrigerator should have two compartments:

- Main compartment – kept at 0-8°C (or 2-8°C) – for vaccines and some drugs.
- Freezer compartment – kept below 0°C – for making ice packs.

## Choosing a refrigerator

- If your health facility has a stable and reliable supply of mains electricity choose a compression (electrical) refrigerator.
- If the electricity supply is unreliable, or operates for less than 8 hours in 24 hours, or there is no mains electricity, choose an absorption refrigerator (either kerosene and electricity or gas).

The temperature in gas and electrical refrigerators is controlled by a thermostat. The temperature in a kerosene refrigerator is controlled manually by adjusting the kerosene burner wick up and down (a large flame makes the refrigerator colder and a small flame makes it warmer). Make sure you buy a refrigerator suitable for your needs.

## General rules

Following these simple rules will keep your refrigerator in good condition and ensure that it works efficiently.

- Keep the refrigerator in the coldest room in the health facility. The room should be well-ventilated and the refrigerator kept away from sunlight, heat and draughts. Draughts can blow out the flame in kerosene and gas refrigerators. Leave at least 20cm between the refrigerator, the wall and other equipment to allow hot air to escape from the back of the refrigerator.
- Keep the refrigerator locked or in a room that can be locked. Always leave the key at the clinic and in a safe place.

- Open and close the door of the refrigerator gently. Make sure that the refrigerator door seals perfectly, to prevent warm outside air from entering. Badly fitting doors and damaged seals cause the temperature inside the refrigerator to rise and reduce its efficiency. Check regularly all around the door seals for damage and to make sure they seal properly. A simple way to do this is to place a sheet of paper between the door seal and cabinet and close the door. If the seal is working properly the paper stays in place and is not easy to pull out.

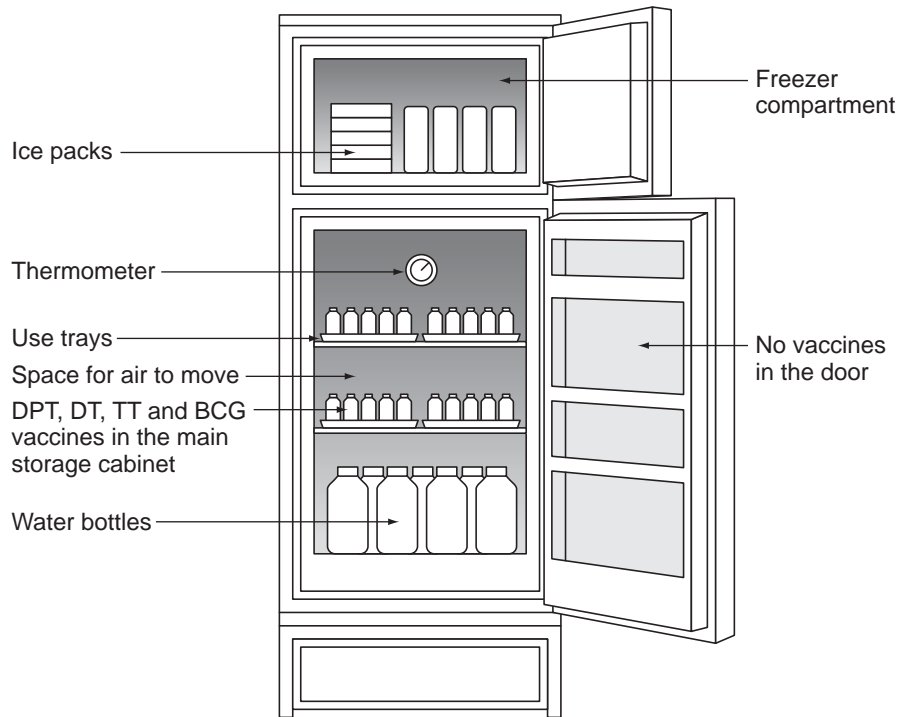

Stocking the refrigerator

- Open the refrigerator only when necessary and as infrequently as possible. Each time the door is opened, cold air escapes and warm air gets in, causing the temperature in the refrigerator to rise. Only use the refrigerator for storing EPI supplies. Do not store food or drinks in the same refrigerator to avoid unnecessary opening of the door. Avoid re-opening the door immediately after closing. If there is space, put containers of water in the bottom or the door of the refrigerator to keep contents cool when the door is opened.
- Make sure the refrigerator is on a firm, level base. If it has adjustable feet, adjust these by hand. If not, level the refrigerator by placing pieces of cardboard under each corner. To check it is level, place a ball on top and adjust the refrigerator until the ball stops rolling. If possible place the refrigerator on a small timber pallet that keeps it off the ground by about 15cm. This stops water and moisture collecting under the refrigerator and so helps to prevent rusting. It also improves cooling, and allows easy access for cleaning.
- Do not overfill the compartments. If air cannot circulate freely inside the refrigerator, the temperature will rise.
- At least once a month, clean the door gasket and burner, and remove any dust from the condenser.
- When ordering spares such as burners, lamps and wicks, check the size needed (for wicks the size is usually written on side of the burner). Keep wicks wrapped in a plastic bag to protect them and keep them dry.
- Give one person responsibility for the refrigerator, including storing vaccines, diluents and ice-packs, checking and recording the temperature, and maintaining the cold chain.
- Make sure the health facility has a plan of what to do if the refrigerator breaks down and that staff are trained to carry it out.

## Practical tips for vaccine storage

- Make sure there is enough space to allow air to circulate freely around vaccines and diluents. Store vaccines in rows in trays, putting the same type of vaccines together in the same tray. Use trays with perforated bottoms and allow 5cm between each tray.
- Put measles and polio vaccines on the top shelf of the main compartment, and BCG, DPT, DT, TT, hepatitis B and Hib vaccines on the middle shelf.
- Do not store vaccines in the refrigerator door, because the temperature is higher than the main compartment.
- Never allow DPT, DT, TT, hepatitis B and Hib vaccines to freeze. These vaccines are damaged if they are exposed to temperatures below 0°C.
- Put diluents next to the vaccines for which they were supplied. Keep enough measles and BCG diluent in the refrigerator to meet the needs of the next immunisation session. The diluent must be cool when it is used, otherwise it may damage the vaccine.
- Store and use vaccines on a First In First Out (FIFO) basis. Write the date of receipt on the box, so you know which ones to use first. Do not keep expired vaccines in the refrigerator.

Table 2.8 Looking after refrigerators

### Daily checks

- Check the temperature every morning and evening. The temperature pattern will show if there are any faults or the refrigerator is not working efficiently.
- Check the gas bottle or kerosene tank, the flame and the wick. Top up the fuel and adjust the flame and wick as necessary. If you have a kerosene refrigerator, refill the kerosene tank each day (record the amount of fuel added to the tank) and check the flame every morning and evening. Order fuel and spare parts if required.
- Check the freezer for ice build up.
- Report faults to the maintenance officer immediately.

### Defrosting

- Defrost the refrigerator regularly (at least once a month).
- Before defrosting the refrigerator, transfer stock to another refrigerator or cold box.
- Speed up defrosting by placing a container of warm water in the freezer and in the main compartment. Do not use knives or sharp instruments to remove ice as these can permanently damage the refrigerator.
- Swab the inside of the cabinet with 70% ethanol while defrosting and keep the door open. Use water and detergent to clean the inside and outside of the refrigerator. Do not use abrasives or bleach, because these will leave grooves that allow micro-organisms to multiply. Dry all surfaces with a clean, soft, dry cloth.
- Return vaccines, diluents and ice packs to their appropriate places. But, only put stock back in the refrigerator when the required temperature (0-8°C) has been reached. People often make the mistake when a refrigerator has been defrosted of setting the thermostat at the coldest setting and restocking immediately with vaccines. This can cause vaccines to freeze making them useless.

### PPM

- Follow the maintenance schedule and checks as advised by the manufacturer.
- Thoroughly clean the condenser
- Oil the door fittings, locks and other moving parts. Check that the door is sealing correctly and, if necessary, change the door gasket. Check for visible damage, clean off patches of rust and repaint.

## 2.4 Cleaning, disinfection and sterilisation

Decontamination is the process of making items safe for handling and before they are re-used. Cleaning, disinfection and sterilisation are procedures used to prevent contamination and spread of infection by medical instruments and equipment.

Table 2.9 Decontamination procedures

Recommended process	Suitable for supplies and items	Examples
Cleaning	<ul style="list-style-type: none"> <li>• In contact with intact skin</li> <li>• Not in contact with the patient</li> <li>• Low infection risk</li> <li>• To be disinfected or sterilised</li> </ul>	Bedframes, mattresses with impermeable covers, trolley tops before use, work surfaces
Disinfection	<ul style="list-style-type: none"> <li>• In contact with intact skin and mucous membrane</li> <li>• Contaminated with readily transmittable organisms</li> <li>• Medium infection risk</li> </ul>	Metal tongue depressors, work surfaces, washing bowls, soiled items, contaminated items, thermometers, infectious spills, e.g. blood, urine on mattresses
Sterilisation	<ul style="list-style-type: none"> <li>• In contact with broken skin or mucous membrane</li> <li>• That penetrate the skin or enter sterile body areas</li> <li>• Contaminated with readily transmittable organisms</li> <li>• Medium to high infection risk</li> </ul>	Surgical instruments, dressings, reusable items such as sterilisable syringes and needles

Every member of the health team is responsible for carrying out cleaning, disinfection and sterilisation procedures.

For reasons of safety, staff responsible for cleaning, disinfection and sterilisation should:

- Wash their hands with soap and water.
- Be aware of the risks of contamination.
- Wear thick, protective gloves.
- Be particularly careful when handling sharps and sharp instruments.
- Follow manufacturer's instructions.

### Practical tips for using water for cleaning, disinfection and sterilisation

- Use clean water (preferably filtered or boiled) for cleaning, disinfecting and sterilising.
- In areas where tap water and surface water have a high mineral or salts content use clean (filtered or boiled) rainwater for cleaning, preparing disinfection solutions and sterilising. Water with a high mineral or salts content can damage equipment and instruments causing scaling, furring and corrosion of boilers and sterilisers. Boiling or filtering does not reduce the mineral or salts content of water but will ensure that the water is clean.
- Use cool or warm water for cleaning not hot water. Hot water causes protein substances (such as organic matter) to stick to instruments and equipment.

## Cleaning

Cleaning is the process of removing visible material such as dirt, grease, blood and body fluids, and reducing the number of infectious micro-organisms (bacteria, viruses, fungi, and spores). Disinfection and sterilisation methods only work properly if items have been thoroughly cleaned and dirt, grease, and organic matter such as mucus, tissue, blood and other body fluids removed. The presence of organic matter can protect germs against, or reduce the action of, disinfectants or sterilising agents. Corrosion and rusting are also caused by inadequate cleaning, rinsing and drying.

- After use and before cleaning, all items should be soaked in water to prevent deposits drying up, as this makes them more difficult to remove.
- Cleaning methods are summarised in Table 2.10.
- After cleaning and before sterilising or disinfecting, all items should be rinsed thoroughly with clean water and dried.

**Table 2.10** Cleaning methods

Cleaning method	Suitable for	Comments
Clean water	Sterilisable syringes and needles Lancets Latex gloves Reusable plastic, glass, metal items	Soak in clean water after use to loosen or prevent organic matter drying and to make cleaning easier. Most items only need to be soaked for about 30 minutes to remove debris before disinfection or sterilising. Do not leave items, especially metal items, soaking for long periods of time, e.g. overnight, as this can damage them. Soaking poor quality SS instruments for a long time can lead to corrosion and rusting. After cleaning, rinse and dry thoroughly.
Clean water and general purpose detergent, e.g. Omo	Reusable glass and plastic, metal items and SS instruments Spilt blood and body fluids Work surfaces, e.g. examination tables, bench surfaces Ward surfaces, e.g. floors, walls, ceilings	Soak in clean water after use (as above). Do not leave metal items soaking for too long (as above). After cleaning, rinse off the detergent with clean water and dry thoroughly. Never use detergents to clean syringes, needles and lancets.
Clean water and soap	Hands	Wash hands before, after and between contact with each patient and procedure. Never use soap to clean syringes, needles and lancets, or latex materials. Soap can make latex materials sticky and easy to break.

## Disinfection

Disinfection is the process of removing micro-organisms or reducing the number to levels that are no longer harmful. Disinfection kills viruses, fungi, bacteria but not spores such as tetanus. Disinfection is, therefore, safe for items that are used for some purposes but not for those where all organisms must be destroyed.

The two main disinfection methods are boiling and chemical disinfection. Guidelines for these two methods are provided in Table 2.11. It is important to remember that chemical disinfectants are not suitable for use with needles and syringes, because traces of chemicals can be toxic, cause irritation and inactivate vaccines.



## Disinfection by boiling

It is important to remember that boiling provides high level disinfection but not sterilisation. Boiling is still widely used either because steam sterilisers are not available or because health staff believe that boiling is the same as sterilisation and guarantees that items are sterile. Use the following guidelines for disinfection by boiling:

### *Preparation of the boiler and the load*

- Use a special boiling pan (boiler) or, if not available, a saucepan with a close fitting lid.
- Prepare the items so that they are ready for disinfecting. Make sure they have been thoroughly cleaned, rinsed and dried.
- Check items for signs of damage and to make sure that, for example, joints are not loose.

### *Loading the boiler*

- Load the boiler so that the water will be able to circulate around each item and each part. Arrange the items so that they are not touching each other or the sides of the boiler. Do not overload the boiler.
- Place heavier items at the bottom and smaller, lighter items on top.
- Make sure that hinged instruments are open.
- Do not boil sterilisable needles and syringes unless sterilisation is not possible. Separate the plunger and barrel of the sterilisable syringes and place the needles in a needle container or stick into a gauze swab.
- Fill with enough clean water to make sure that all the items are covered. Boiling without enough water will damage the boiler and the items.

### *Boiling*

- Heat until the water boils, then reduce the heat slightly to save fuel but make sure that the water remains boiling.
- Start timing. Boiling time starts from when the water boils not from the time the water starts to be heated. Boil for the required time (see Table 2.11).
- Do not leave the boiler unattended when in use.
- Do not add any items during the boiling cycle. If items are added, you need to start timing from the beginning again. Similarly, if boiling is stopped at any point, you need to restart again.

### *Removing the load*

- After the required boiling time, shut off the heat source and remove the boiled items. Either take out the tray with its contents and allow it to drain dry or take out the boiled items using sterile or disinfected long handled forceps and place them in a sterile or boiled metal container to dry before using or storing them.
- Allow the boiler to cool down before draining the hot water.
- Do not leave items in the water because it can easily become re-contaminated.
- Do not disinfect by boiling more than 24 hours before you use items. The items may become contaminated even if they are stored in a closed container.
- Clean the boiler after each day's use.

## Chemical disinfection

A wide range of chemical disinfectants is available (see Table 2.11). Each is best suited for a specific purpose and must be used in a particular way to be effective. Because not all disinfectants will kill all organisms, a single disinfectant will not fulfil all your requirements, but two different disinfectants will usually be sufficient. Choose disinfectants with the following characteristics:

- Wide range of activity
- Not readily inactivated
- Non-corrosive when diluted
- Non-irritant to skin
- Low cost



Proper disinfection depends on using an appropriate disinfectant at the right concentration and for adequate contact time. It is also important to follow the manufacturer's instructions for disinfectant handling, preparation, use and storage. Incorrect dilution, poor storage and repeated use of the same working solution reduce the effectiveness of chemical disinfection.

### **Practical tips for chemical disinfection**

- Develop a policy for chemical disinfection. Only use chemical disinfection if it is not possible to sterilise or boil.
- Disinfectants may be supplied ready to use or may need to be diluted. Label bottles or containers with the name and concentration of disinfectant and, for diluted disinfectants, the date of dilution/preparation.
- Prepare dilutions with clean water.
- Most disinfectants, once diluted, can only be stored for 1 week. Prepare small amounts at a time to avoid wastage. Do not mix freshly made diluted solution with old solution. Wash and dry the container before filling with new solution.
- Use fresh soaking solution every day. Renew soaking solution during the day if it looks dirty. Never mix fresh solution with old solution. Wash and dry the container before filling with new solution.
- Clean, rinse and dry items thoroughly before disinfecting. All disinfectants are inactivated to some extent by organic matter, rubber, hard water and detergents.
- Wear gloves to avoid irritation of the skin. If there is irritation, wash the affected part with clean water until all the chemical is removed.
- Avoid soaking metal items for too long or in too high concentrations as this causes corrosion and rusting.
- After disinfection, rinse thoroughly with clean water to remove all chemical residues. Alcohol solutions can be allowed to dry without rinsing.

## **Sterilisation**

Sterilisation is the process of destroying or removing all forms of living organisms, including bacteria, viruses, fungi and spores. Carrying out sterilisation is not easy. It requires proper equipment and staff who are trained to use the equipment correctly and to follow procedures. If sterilisation is not possible, disinfection by boiling is a useful alternative. But remember that boiling does not guarantee sterility.

The main method of sterilisation (sometimes also called autoclaving) is steam under pressure, described below and in Table 2.12. This section also includes more detailed information about sterilising reusable needles and syringes.

### **Sterilisation by steam under pressure**

'Pressure cooker' type sterilisers are designed to sterilise unwrapped, non-porous, non-fabric items such as instruments and syringes. They are not suitable for sterilising wrapped or porous items such as swabs. Use the following guidelines for sterilisation by steam of basic supplies and equipment with a portable pressure cooker steam steriliser:

#### *Preparation of the steriliser and the load*

- Put the required quantity of water in the steriliser. The level is usually marked or the quantity indicated by the manufacturer. Dry heating without water could damage the items and the steriliser and cause injury to the operator.
- In areas where tap water has high mineral and salts content, use clean rainwater to reduce corrosion, rusting, scaling or furring of metal items and the steriliser. Hard water pads will also help to reduce the build up of scale in the steriliser.
- Prepare the items ready for sterilising. Clean, rinse and dry thoroughly. Check for cleanliness, signs of damage and loose joints or hinges.
- Lubricate hinged instruments before sterilising. Use a water-soluble lubricant as this allows steam to penetrate during sterilisation.

### *Loading the steriliser*

- Load the steriliser. Arrange items so that steam vapour is able to circulate freely around each item and part.
- Make sure that items for sterilisation are not in contact with water. It is the steam that sterilises not the water. Use stands to support trays and baskets.
- Arrange items in the baskets and trays so that they are not touching or stacked on top of each other.
- Make sure that hinged instruments are open, if possible putting ring-handled instruments on a mayo pin to keep them in the open position.
- Place cupped instruments, such as gallipots, upside down to prevent water collecting in them during sterilisation.
- Make sure that sliding windows on drums and containers are open, and that containers with lids are uncovered.
- Only sterilise reusable (sterilisable) syringes and needles (see later in this section).
- Place test strips – TST (TimeSteamTemperature is preferable) – or autoclave tape in the middle of the load, which is where the heat penetration is the slowest.

### *Sterilisation*

- Turn the heat on full, making sure the pressure control (air removal, purge) valve is open (the lever is pushed up). If the air is not expelled, the mixture of hot air and steam and the temperature will not be sufficient to sterilise the items. Check that the small pin in the safety valve is down.
- When you can hear the steam escaping and it forms a strong, steady and continuous jet, close the valve. If necessary repeatedly steam purge according to the manufacturer's instructions.
- Start timing. The sterilisation cycle starts when the steam comes out in a strong, steady and continuous jet, not from when the heat is turned on.
- Sterilise for the recommended time (see Table 2.12). Do not interrupt the sterilisation cycle. If there is an interruption you must start again from the beginning.
- Make sure steam can be heard escaping from the pressure control valve all the time.
- Do not leave the steriliser unattended when it is in use.

### *Removing the load*

- At the end of the sterilisation time, turn off the heat and open the pressure control valve to allow the steam to escape and the pressure to reduce.
- After all the steam has escaped, close the pressure control valve so that sterility is maintained.
- Allow the steriliser to cool down for at least 1 hour before opening or draining the hot water.
- Take care when opening the lid because the load may be hot even after the cooling down time.
- After sterilisation, items must remain sterile until they are used. So, do not open the steriliser lid until you need to use the sterilised items. Items will become contaminated again as soon as they are in the air. Or take items out with sterilised forceps and place them in a sterilised or highly disinfected container and close the lid.
- If you are using the steriliser drum, remove the drum and seal by closing the vents. Also remove any containers with covers or lids and close.
- Before using sterilised items, examine the TST strips to make sure sterilisation has been satisfactory.
- Clean the steriliser after use. Also check regularly for signs of wear and damage (see Section 2.3)

## Practical tips for sterilisation

- A wide range of sterilisers is available. Always follow the manufacturer's instructions for the type of steriliser that you are using.
- Air in the steriliser and load results in inadequate steam penetration and incomplete drying of the load. This is because air acts as an insulator for heat and prevents steam reaching the surface of items to be sterilised. Steam purging by opening and closing the valve, removes air and improves the steriliser's performance.
- Always sterilise items for the correct time using a clock or timer. Standard combinations of time and temperature for sterilisation are: 121°C for 15 minutes and 134°C for 3 minutes. You need to know the operating pressure of the autoclave and altitude of your health facility to determine correct sterilising time. If you cannot change the operating pressure then you need to extend the sterilising time.
- Never sterilise single use items such as disposable needles and syringes in order to re-use them, because the high temperatures during steam sterilisation will damage them.
- Indicator strips on autoclave tape are not a reliable guide that sterilisation has taken place. Use TST indicators instead of autoclave tape.
- Because it is difficult to keep items sterile (items are contaminated by contact in the air), carry out sterilisation on the day of use (but not immediately before use as you need to allow time for items to cool down).
- Replace safety valve and gaskets (rubber seals that seal the junction of metal surfaces) immediately if they are damaged or worn.

**Table 2.11 Disinfection by boiling and chemical disinfection**

Method	Kills	Suitable for	Advantages	Disdvantages	Comments																		
<p><b>Boiling</b></p> <p><i>Disinfection time:</i></p> <p>Boil clean items</p> <table border="1"> <thead> <tr> <th>Altitude</th> <th>Min</th> </tr> </thead> <tbody> <tr> <td>Sea level</td> <td>10</td> </tr> <tr> <td>1000m</td> <td>10</td> </tr> <tr> <td>2000m</td> <td>10</td> </tr> <tr> <td>3000m</td> <td>20</td> </tr> <tr> <td>4000m</td> <td>20</td> </tr> <tr> <td>5000m</td> <td>30</td> </tr> <tr> <td>6000m</td> <td>45</td> </tr> <tr> <td>7000m</td> <td>60</td> </tr> </tbody> </table>	Altitude	Min	Sea level	10	1000m	10	2000m	10	3000m	20	4000m	20	5000m	30	6000m	45	7000m	60	<p>Bacteria</p> <p>Spores (some)</p> <p>Viruses</p> <p>Fungi</p>	<p>Metal instruments</p> <p>Sterilisable plastic and glass materials</p> <p>Sutures</p> <p>Sterilisable syringes and needles</p>	<ul style="list-style-type: none"> <li>• High level disinfection</li> <li>• Low running costs</li> <li>• Quick, simple and efficient</li> <li>• Minimal maintenance</li> <li>• Readily available</li> <li>• Can be done using a range of locally available fuels</li> <li>• Kills wide range of organisms including HIV, hepatitis B</li> </ul>	<ul style="list-style-type: none"> <li>• Does not kill all spores, e.g. tetanus, gangrene</li> <li>• Can cause rusting or blunting of instruments, e.g. scissors</li> <li>• Water must be at the correct boiling temperature (100°C) and maintained at this temperature for the whole disinfection time</li> <li>• Does not ensure sterility</li> </ul>	<ul style="list-style-type: none"> <li>• Boiling in water is high level disinfection not sterilisation.</li> <li>• Boiling is only an acceptable alternative to sterilisation when steam sterilisation is not possible.</li> <li>• Boiling will not kill organisms effectively if items have not been cleaned properly.</li> <li>• Boiled items must be allowed to dry before use or storage.</li> <li>• Boiled items should not be left in the water, which can easily become re-contaminated.</li> <li>• Disinfection time starts from when the water is actually boiling not when it is heating up. Boiling time of 10 min is sufficient to kill non-sporing bacteria, some bacterial spores, viruses, fungi but not fungal spores.</li> <li>• In hard water areas use rainwater to prevent corrosion, scaling or furring of metal equipment and the boiling pan.</li> </ul>
Altitude	Min																						
Sea level	10																						
1000m	10																						
2000m	10																						
3000m	20																						
4000m	20																						
5000m	30																						
6000m	45																						
7000m	60																						
<p><b>Alcohols</b></p> <p>(Isoprophyl alcohol 70-90%, Ethanol 70%)</p> <p><i>Disinfection time:</i> Soak clean items for up to 15 min</p>	<p>Bacteria</p> <p>Fungi</p> <p>Viruses (some)</p>	<p>Metal instruments</p> <p>Thermometers</p>	<ul style="list-style-type: none"> <li>• Fast acting</li> <li>• Effective against HIV</li> <li>• Not corrosive to metal</li> <li>• Leaves surfaces dry, no rinsing needed</li> </ul>	<ul style="list-style-type: none"> <li>• Low level disinfectant</li> <li>• Toxic, flammable and volatile</li> <li>• May cause skin irritation</li> <li>• High evaporation rate, poor surface disinfectant</li> <li>• Relatively expensive</li> <li>• Poor activity against organic matter and ineffective against bacterial spores</li> <li>• Sensitive to light</li> </ul>	<ul style="list-style-type: none"> <li>• 70% alcohol is much more effective than higher concentrations.</li> <li>• Must be diluted before use. Requires care when diluting.</li> <li>• Can be easily replaced by PVI (povidone).</li> <li>• Store in a cool place (below 30°C) in airtight containers to avoid evaporation, and protect from light.</li> <li>• Although alcohols are effective against HIV on clean surfaces, they are not suitable for dealing with contaminated surfaces because of their poor penetration of organic matter and high evaporation.</li> </ul>																		

Method	Kills	Suitable for	Advantages	Disdvantages	Comments
<p><b>Chlorhexidine + Cetrimide</b> (Savlon, HAC)</p> <p><i>Disinfection time: Soak clean items for 10 min</i></p>	<p>Bacteria</p> <p>Fungi</p> <p>Viruses (limited)</p>	<p>Low level disinfecting</p> <p>Handwashing</p> <p>Surfaces</p> <p>Metal instruments, plastic and rubber ware</p>	<ul style="list-style-type: none"> <li>• Readily available</li> <li>• Low cost</li> <li>• No staining</li> </ul>	<ul style="list-style-type: none"> <li>• Low level disinfectant</li> <li>• Blunts instruments</li> <li>• Possibility of allergic reactions</li> <li>• Inactivated by hard water, some detergents, soap, organic matter, and iodine disinfectants</li> <li>• No activity against TB and bacterial spores</li> <li>• Poor activity against HIV</li> </ul>	<ul style="list-style-type: none"> <li>• Solutions must be freshly prepared at the recommended concentration for different uses.</li> <li>• Concentrated solution of 1.5% Chlorhexidine + 15% Cetrimide must be diluted before use with clean water.</li> <li>• Soaking for too long or with too high a concentration can corrode metal instruments.</li> <li>• Not suitable for sterilising instruments or for sterile instrument storage.</li> <li>• No particular storage precautions required for concentrated solution. Store unused diluted solution for a maximum 1 week.</li> </ul>
<p><b>Phenolics</b> (Lysol, Jeyes, Stericol, Hycolin)</p> <p><i>Disinfection time: Soak clean items from 30 min–6 hours</i></p>	<p>Bacteria</p> <p>Fungi</p> <p>Viruses (some)</p>	<p>Glass, e.g. slides, urine containers</p> <p>Surfaces, e.g. floors</p> <p>Instruments</p> <p>Linen</p> <p>Equipment</p>	<ul style="list-style-type: none"> <li>• Not readily inactivated by organic matter</li> <li>• Cheap</li> <li>• Effective against many organisms, wide range of bactericidal activity, including TB</li> </ul>	<ul style="list-style-type: none"> <li>• Low level disinfectant</li> <li>• Poor activity against bacterial spores and hepatitis B</li> <li>• Variable activity against viruses</li> <li>• Slow activity</li> <li>• Highly irritating to skin and mucous membrane</li> <li>• Strong smelling</li> </ul>	<ul style="list-style-type: none"> <li>• Wide range of phenolic disinfectants with varying composition, concentrations and similar actions.</li> <li>• Pure phenols are not recommended since they are less soluble in water and more irritating. Phenols (containing soap) are preferred.</li> <li>• Should not be used on food preparation surfaces or equipment that may come into contact with skin or mucous membrane. Often used for wiping bench surfaces and floors and when chlorine-releasing disinfectants cannot be used because of their corrosiveness.</li> <li>• Show variable activity and are not recommended for routine disinfection against HIV.</li> <li>• Concentrate solution to be diluted before use. Check manufacturer's instructions for dilution.</li> <li>• Diluted solutions must be stored in airtight containers and not kept for more than 24 hours.</li> </ul>

Method	Kills	Suitable for	Advantages	Disdvantages	Comments
<p><b>Povidone (PVI)</b> (Iodine, Polyvidone-iodine, Betadine, Videne)</p> <p><i>Disinfection time: Soak clean items for 15 min</i></p>	<p>Bacteria</p> <p>Fungi</p> <p>Spores (some)</p> <p>Viruses (some)</p>	<p>Handwashing</p> <p>Surfaces</p> <p>SS instruments</p> <p>Sutures</p> <p>Blades</p>	<ul style="list-style-type: none"> <li>• Readily available as aqueous solution or powder form</li> <li>• Low cost</li> <li>• Versatile</li> <li>• Efficient and fast acting</li> <li>• Wide range of activity, including against HIV</li> </ul>	<ul style="list-style-type: none"> <li>• Low level disinfectant</li> <li>• Solution must be made up daily at the time of use</li> <li>• Stains fabrics and surfaces</li> <li>• Discolours, oxidises and may corrode metal</li> <li>• Solution is dark so difficult to see items in soak</li> <li>• May be a skin irritant</li> <li>• Cannot be used with mercury derivative</li> </ul>	<ul style="list-style-type: none"> <li>• Concentrated solution must be diluted before use.</li> <li>• Solution must be freshly prepared at the recommended concentrations for different uses, e.g. for instruments 2.5% PVI.</li> <li>• Solution must be changed daily.</li> <li>• Soaking for too long or with too high a concentration can cause corrosion of metal items.</li> <li>• Concentrated solution 10% PVI must be stored in airtight and opaque containers.</li> <li>• Unused diluted solution 2.5% PVI can be stored for a maximum 1 week.</li> </ul>
<p><b>Virkon</b></p> <p><i>Disinfection time: Soak items from 3-10 min</i></p>	<p>Bacteria</p> <p>Fungi</p> <p>Spores</p> <p>Viruses</p>	<p>Blood and body fluid spills</p> <p>Hard surfaces</p> <p>Glass and plastic</p> <p>SS equipment and instruments</p>	<ul style="list-style-type: none"> <li>• High level disinfectant</li> <li>• Suitable for multiple uses</li> <li>• Fast action</li> <li>• Effective against HIV and hepatitis B</li> <li>• One step disinfectant, cleans and disinfects in one operation (pre-cleaning not necessary)</li> <li>• Built-in colour (pink) indicator of activity</li> <li>• Working solution is non-irritant to skin, eyes</li> <li>• Not readily inactivated by organic matter</li> </ul>	<ul style="list-style-type: none"> <li>• Warm water needed to dissolve powder</li> <li>• Disinfecting solution must be changed weekly (or sooner if pink colour is lost)</li> <li>• Corrosive to some metal items</li> </ul>	<ul style="list-style-type: none"> <li>• One of the newer disinfectants.</li> <li>• Powder disinfectant safer and easier to transport and store.</li> <li>• Suitable for all routine disinfection tasks.</li> <li>• Diluted working solution stable for 7 days and should be discarded after this time or sooner if the pink colour starts to fade.</li> </ul>

Method	Kills	Suitable for	Advantages	Disdvantages	Comments
<b>Sodium Hypochlorite</b> 5% (solution) (Bleach, Chloras, Jik, Domestos)  <b>Calcium Hypochlorite</b> (solid/powder/granules)  <b>NADCC</b> (Sodium dichloroisocyanurate) [Presept, Sanichlor, Haz-Tab] (tablet/powder/granules)  <i>Disinfection time: Soak clean items from 10-60 min</i>	Bacteria	<i>0.1% solution</i>	<ul style="list-style-type: none"> <li>• High level disinfectant</li> <li>• Readily available</li> <li>• Reasonable cost</li> <li>• Rapid action, potent and wide range of activity including against HIV and hepatitis</li> <li>• Sporicidal, particularly if buffered at around PH 7.6</li> <li>• Disinfectant of choice against viruses</li> <li>• Active against TB at high concentrations</li> <li>• Suitable for cotton and linen (but risk of discolouration)</li> <li>• Useful as a laboratory disinfectant</li> <li>• Wide range of use</li> </ul>	<ul style="list-style-type: none"> <li>• Highly volatile</li> <li>• Strong oxidising agent, and corrosive to some metals</li> <li>• Concentrated and strong solutions damage textiles</li> <li>• Toxic properties</li> <li>• Potentially irritant, e.g. skin, eyes, lungs</li> <li>• Diluted (working) solutions are unstable and must be freshly prepared daily or as required</li> <li>• Limited storage life</li> <li>• Inactivated by organic matter, particularly if used in low concentrations</li> <li>• Need to avoid mixing strong acids with hypochlorites, as chlorine gas will be released</li> </ul>	<ul style="list-style-type: none"> <li>• Chlorine releasing disinfectants. The power of the disinfectant is expressed as 'available chlorine', usually as % of available chlorine or as mg/l (1 mg/l = 0.0001%) or parts/million (1ppm = 0.0001%). Check disinfectant labels for the amount of available chlorine.</li> <li>• Always dilute according to manufacturer's instructions (and chlorine content), in non-metal containers (chlorine oxidises metal). Prepare just before use.</li> <li>• High concentrations are caustic and corrosive.</li> <li>• Low concentrations are non-toxic.</li> <li>• To avoid corrosion, use only for SS instruments.</li> <li>• Solutions exceeding 0.1% should not be used on SS, or left in contact with items for more than 30 min. Do not exceed recommended concentration or contact time.</li> </ul>
	Fungi	Hands			
	Spores	Gloves			
	Viruses	SS items			
		Cotton and linen			
		<i>0.2-0.25% solution</i>			
		Surfaces, e.g. floors and tables			
		Plastic items			
		<i>0.5-1% solution</i>			
		Spills of infectious materials, e.g. blood			

- Handle carefully, because of rapid deterioration in light and heat, corrosion of metals and damage to fabrics. NADCC is more stable, less corrosive and more resistant to inactivation by organic matter than hypochlorites. Concentrates and working dilutions must be protected from sun, heat and strong light (and humidity for solids). Store in dark or opaque airtight non-metal containers. Undissolved NADCC is very stable when stored dry but unstable when in solution. Store unused diluted solutions for a maximum of 1 week.
- Handle carefully, because of rapid deterioration in light and heat, corrosion of metals and damage to fabrics.
- NADCC is more stable, less corrosive and more resistant to inactivation by organic matter than hypochlorites.
- Concentrates and working dilutions must be protected from sun, heat and strong light (and humidity for solids). Store in dark or opaque airtight non-metal containers.
- Undissolved NADCC is very stable when stored dry but unstable when in solution. Store unused diluted solutions for maximum 1 week.

**Table 2.12 Sterilisation**

Method	Kills	Suitable for	Advantages	Disdvantages																		
<b>Steam sterilisation</b>  <b>Sterilisers</b> (Autoclaves, Pressure Cooker [Domestic] )  <i>Sterilisation time:</i> Steriliser designed to operate at 121°C (250°F)  <table border="1"> <tr> <td>Altitude</td> <td>Min</td> </tr> <tr> <td>Sea level</td> <td>20</td> </tr> <tr> <td>1000m</td> <td>30</td> </tr> <tr> <td>2000m</td> <td>35</td> </tr> <tr> <td>3000m</td> <td>45</td> </tr> <tr> <td>4000m</td> <td>50</td> </tr> <tr> <td>5000m</td> <td>60</td> </tr> <tr> <td>6000m</td> <td>70</td> </tr> <tr> <td>7000m</td> <td>80</td> </tr> </table>	Altitude	Min	Sea level	20	1000m	30	2000m	35	3000m	45	4000m	50	5000m	60	6000m	70	7000m	80	Bacteria  Fungi  Spores  Viruses	Heat stable items such as reusable glass and plastic  All metal items  Fabrics  Dressings	<ul style="list-style-type: none"> <li>• Quick and efficient</li> <li>• Low running costs</li> <li>• Reliable</li> <li>• Safe</li> <li>• Environmentally friendly</li> <li>• Appropriate for all health facilities and services</li> <li>• Effective against HIV and hepatitis B</li> </ul>	<ul style="list-style-type: none"> <li>• Can be difficult to find spare parts</li> <li>• Recurrent costs, e.g. fuel, test tapes</li> </ul>
Altitude	Min																					
Sea level	20																					
1000m	30																					
2000m	35																					
3000m	45																					
4000m	50																					
5000m	60																					
6000m	70																					
7000m	80																					
<b>Comments</b>																						

- If carried out correctly, following the manufacturer’s instructions, steam sterilisation can guarantee complete sterility.
- There are many types of sterilisers, ranging from simple hand-operated type to advanced fully automatic models.
- Sterilisers can be grouped according to the type of load they are designed to handle: non-porous items (e.g. instruments, syringes, unwrapped items, non-fabric) and porous items (e.g. swabs, wrapped items). The type of steriliser required will depend on the range of items to be sterilised, workload, staff skills and power supply.
- All types work using the principle of steam under pressure for a specified time. Pressure (created by expelling air) is used to produce high temperature steam. Use steam pulsing (technique where steam is released and admitted again in short continuous pulses by opening and closing the valve) to improve air removal and, hence, the steriliser’s performance.
- Steam is much hotter than boiling water.
- The most common combinations for temperature and time (at sea level) are 121°C for 20 min, 126°C for 10 min and 134°C for 3 min. To determine accurately the time needed for sterilisation you need to know the operating pressure of the steriliser and the altitude. Sterilisation time starts when the required temperature (pressure) is achieved, not from the start of heating. Indicator strips, such as TST, should be used – ideally during every sterilisation cycle or at least once a week – to make sure sterilisation has been satisfactorily carried out.
- Sterilisation will not remove blood and other organic matter, and may also result in contaminated material being ‘baked’ onto items, so cleaning, rinsing and drying before sterilising is essential. If items are not clean all organisms will not be killed. Use clean rainwater if tap water has high mineral and salts content, to prevent corrosion and rusting of metal equipment and steriliser.



## Sterilising reusable syringes and needles

A single sterile syringe and needle should be used for each injection. Re-using syringes or needles without proper sterilisation puts the health worker and the patient at risk of cross-infection with bloodborne diseases, e.g. hepatitis and HIV, of contracting infections, e.g. septicaemia and tetanus, and of injection abscesses. WHO estimates that 10-20 million serious infections, of which approximately 1 million are fatal, are caused each year through re-use of, and accidental needlestick injury with, contaminated syringes and needles.

Always follow national policies regarding the use of sterilisable syringes and needles and sterilisation. If national policies are not available, use the following guidelines for sterilising reusable syringes and needles.

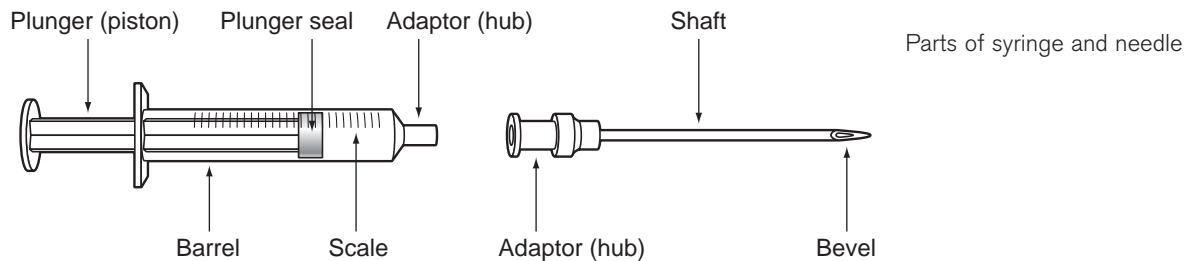

### Before sterilisation

Preparing reusable syringes and needles for sterilisation involves two steps, soaking and cleaning.

#### Soaking

- Immediately after the injection, flush the needle and syringe with clean water 4-5 times. This prevents the needle from becoming blocked.
- Soak used needles and syringes in a bowl of cold, clean water. This makes them easier to clean. To prevent needlestick injuries, lay the syringes side by side in the container, so that all the needles are pointing in the same direction.

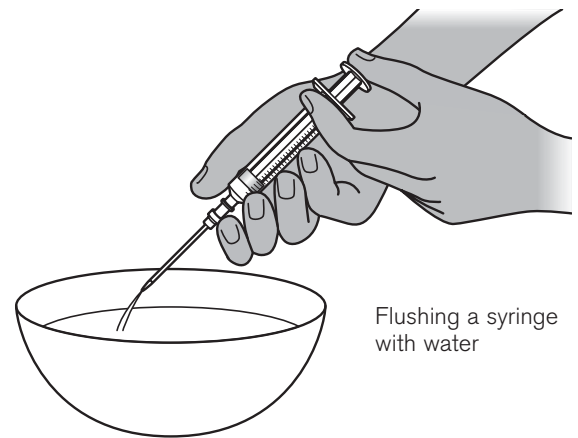

#### Cleaning

- Just before sterilising, pour away the water used for soaking and refill the container with clean water.
- Remove needles from syringes using forceps (to avoid accidental needlestick injury).
- Leave the needles in the water until you are ready to clean them.
- Flush the syringe 3-4 times, separate the barrel and plunger and rinse both in the basin.
- Check that the plunger seal fits inside the syringe barrel properly and you can read the scales on each syringe before loading them into the steriliser. If not, dispose of the syringe.
- Use forceps to attach the needle to a clean 5ml syringe. Flush the syringe and needle with water several times. Dispose of blocked needles.
- Test each needle for barbs (hooks) by drawing it across some cotton wool or gauze. If it is barbed it will catch and a wisp of cotton or gauze will stick to it. Throw away barbed needles, because an injection with barbed needle is painful, damages tissues and causes infections.

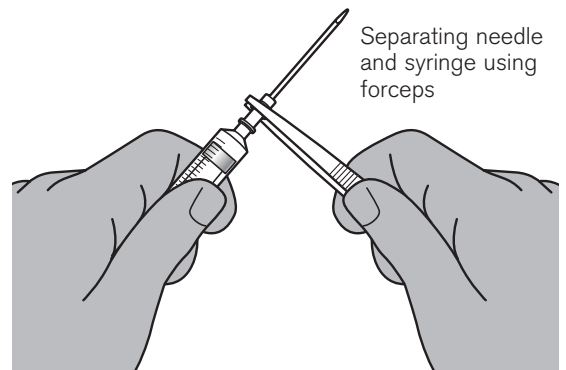

## Sterilisation

Sterilise syringes and needles using a pressure cooker type steriliser. Table 2.13 describes the steps in loading the steriliser for EPI and general injections and the sterilisation process (see also Table 2.12 and Section 3.1).

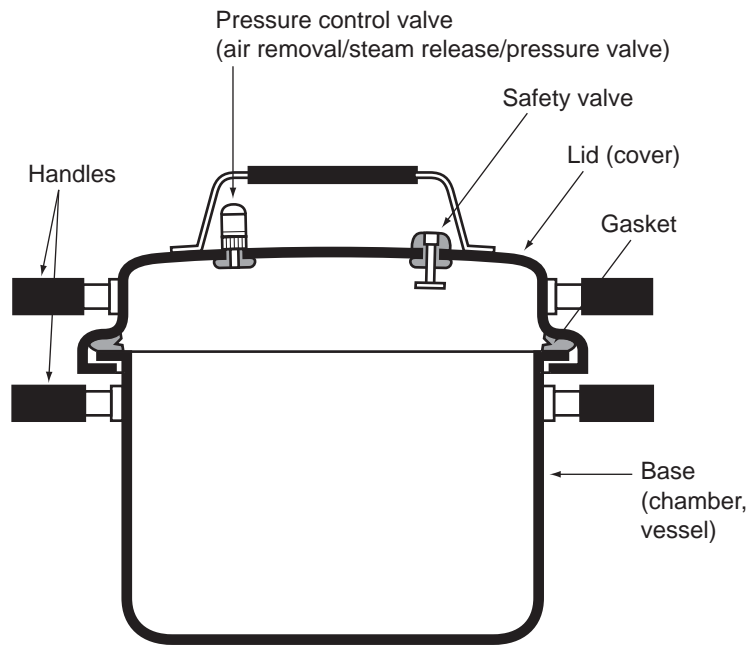

Parts of a pressure cooker type steam steriliser



Loading the syringe and needle rack

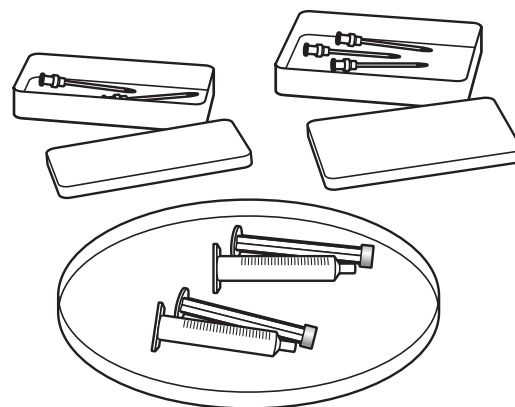

Loading a tray and needle cases

**Table 2.13 Sterilising syringes and needles**

**EPI programmes**

When loading the steriliser, whether using a rack or drum, follow these steps:

- Place syringe barrels in the largest holes of the steriliser rack, plungers into medium-sized holes, and needles, pointing downwards, into the smallest holes. To make assembly after sterilisation easier, place syringes near the appropriate needles, e.g. BCG needles near BCG syringes.
- Fill the steriliser with water up to the water level mark on the inside of the steriliser base. If you are using a hard water pad, place this in the water.
- Place the loaded rack(s) in the steriliser, put a TST indicator on top of the syringes and needles. Put the lid on the rack and place two forceps on the lid (with double or triple rack sterilisers on the top rack lid only). If using a steriliser drum, make sure the vents (holes) are open and position the forceps in place.
- Before sterilising, check the small pin in the safety valve is down and the pressure control (pc) valve is opened by pushing up the lever. After a few minutes of heating, the water will boil and steam will start to escape from the pc valve. Set the timer for 5 minutes. During this period, air is flushed from the steriliser with steam. The steam can be heard escaping and forms a strong and steady jet. When the timer rings, close the pc valve by pushing down the lever. Start timing for 15 minutes, turn the heat down making sure steam can still be clearly heard escaping from the pc valve at all times. In total there should be 20 minutes of uninterrupted steam.
- At the end of sterilisation time, turn off the heat and open the pc valve to release the steam and allow the pressure to reduce (if the steam is not released you will not be able to open the steriliser). After all the steam has escaped, close the pc valve so that sterility is maintained. Leave the steriliser and its contents to cool for at least 1 hour.
- Before using the sterilised supplies, check the TST strip to make sure sterilisation has been satisfactory

**General injections**

When loading the steriliser, follow the instructions for loading the EPI steriliser, if using a steriliser syringe rack or drum designed for 2ml and 5ml syringes OR place the syringe parts (barrel and plungers) and needles held in uncovered needle case in the instrument trays or the instrument container. Do not pack the trays or container or the needle case too tightly. The steam must be able to move freely during the sterilisation process.

- Fill the steriliser with water up to the mark on the inside of the base. If using a hard water pad put it in the water. Position the V support, trivet or shelf in the water and place the loaded trays or instrument container on top of it. Place the TST indicator in the middle of the load. Put the lid or tray on and position the forceps on the lid.
- Before sterilising, check the small pin in the safety valve is down and the pressure control (pc) valve is opened. The lever of the pc valve is pushed up. After a few minutes of heating, water will start boiling and steam will start escaping strongly from the pc valve. Set the timer for 5 minutes. During this period, air will be flushed from the steriliser with steam. The steam can be heard escaping and forms a strong and steady jet. When the timer rings, close the pc valve by pushing down the lever. Start timing for 15 minutes, turn the heat down making sure steam can still be clearly heard escaping from the pc valve at all times. In total there should be 20 minutes of uninterrupted steam.
- At the end of sterilisation time, turn off the heat and open the pressure valve to release the steam and allow pressure to reduce. If the steam is not released you will not be able to open the steriliser. After all the steam has escaped close the pc valve so that sterility is maintained. Leave the steriliser and its contents to cool for at least 1 hour.
- Before using the sterilised supplies, check the TST strip to make sure sterilisation has been satisfactory.

## After sterilisation

After sterilisation either reassemble syringes and needles for use or store them so that they remain sterile. Before using the sterilised syringes and needles, check the TST tape to make sure sterilisation has been satisfactory.

### Assembling directly from the steriliser and steriliser drum

- Do not open the sterilised unit until you are ready to use the sterilised syringe and needle.
- Take the lid off the base and put it upside down on the table.
- Move sterile forceps to the lid but do not touch the tips of the forceps with your hands. Place the forceps so that the tips lay inside and the handle rests on the edge of the lid. This way you can pick up the forceps without contaminating the inside of the lid.
- Use the forceps to pick up the barrel. Hold the barrel in your hand being careful to touch only the outside not the hub.
- Pick up the plunger with the forceps and fit it into the barrel. Do not touch the plunger shaft or seal.

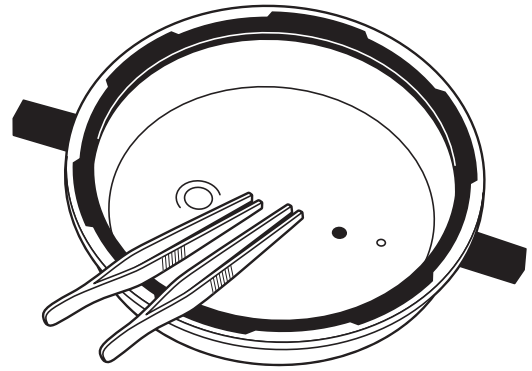

Sterile forceps resting on the steriliser lid

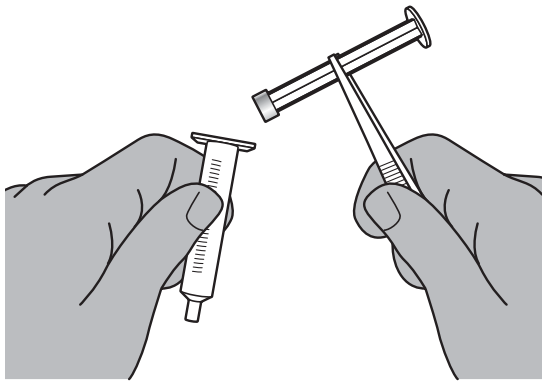

Fitting the plunger into the barrel using sterile forceps

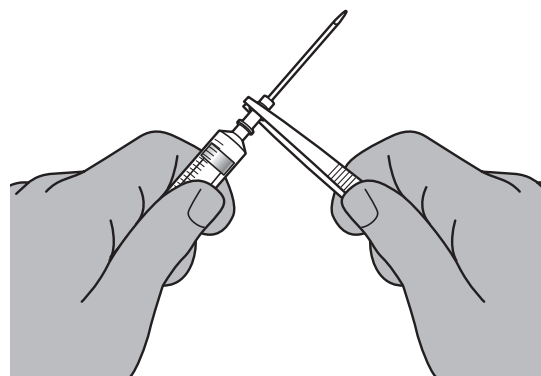

Fixing the needle into the syringe using sterile forceps

- Use the forceps to pick up the needle by its hub and to fit the needle on the syringe. Turn the needle to fix it securely
- Be careful not to touch the needle shaft or bevel.
- Place the syringe and needle down on the lid so that the barrel is on the lid, and the needle sticks up in the air and does not touch the lid or anything else.

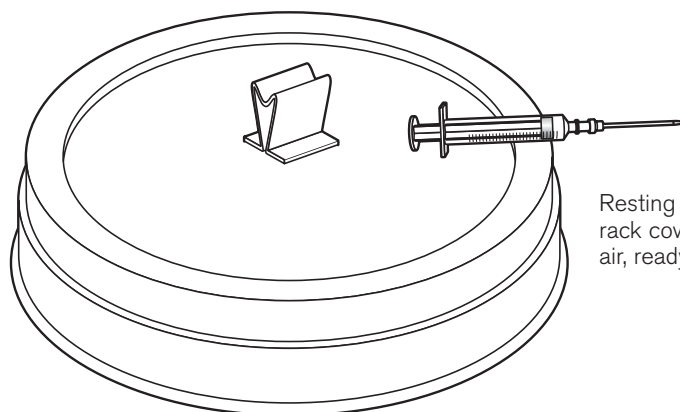

Resting the syringe on the rack cover with needle in the air, ready for use

### Storing

- Once sterilised, syringes and needles must remain sterile until they are used.
- If you have sterilised syringes and needles using racks, keep the steriliser closed until you are ready to use them. (The steriliser can be carried as a sterile unit to the immunisation and injection sessions).
- If you have sterilised them using a drum, remove the drum and seal it by closing the vents. This will keep the contents sterile. (The sealed drums can then be carried to the immunisation and injection sessions without the steriliser).
- If you have sterilised them using trays or baskets, keep the steriliser closed until you are ready to use the needles and syringes. Or remove using sterile forceps to lift out the barrels and plungers and to place them in a sterilised container. Put the lid on the container and store until required.
- Take out any uncovered needle cases and their covers and close. If you are not using needle cases, take out the needles using sterile forceps and place in a sterile container. Put on the lid and store until required.

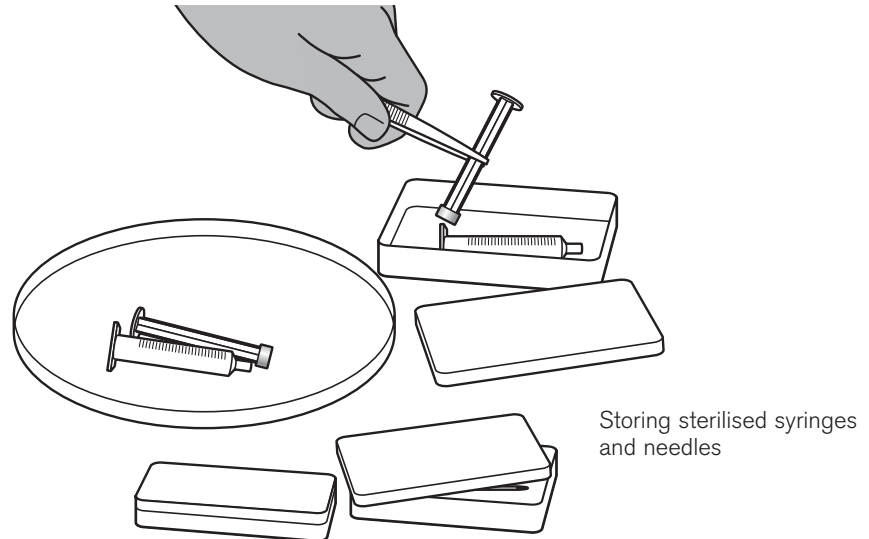

### Assembling from stored sterile containers

- Do not open the sterilised unit until you are ready to use the sterilised syringe and needle.
- Take the lid off the container and put it upside down on the table.
- Use sterile forceps to pick up the barrel. Hold the barrel in your hand being careful to touch only the outside, not the hub.
- Pick up the plunger with the sterile forceps and fit it into the barrel. Do not touch the plunger shaft or seal.
- Use the sterile forceps to pick up the needle by its hub and to fit the needle on the syringe. Turn the needle to fix it securely.
- Be careful not to touch the needle shaft or bevel.
- Place the syringe and needle on the lid so that the barrel is on the tray or lid, and the needle sticks up in the air and does not touch the tray or lid or anything else.

## Practical tips for sterilising syringes and needles

- Never use soap, detergents or chemical disinfectants for soaking or cleaning sterilisable syringes and needles. Traces of these chemicals left on syringes and needles can cause irritation and inactivate vaccines.
- Sterilisable plastic syringes are recommended because they are inexpensive, can be sterilised and are not fragile like glass syringes.
- Reusable syringes should last for 200 sterilisation cycles and reusable needles for 50 sterilisation cycles. However, hard water salt deposits reduce the life of reusable syringes, and in hard water areas they will only last for about 140 sterilisation cycles. Using hard water pads during sterilisation can help to extend the life of reusable syringes.
- After sterilisation you can touch the outside of the barrel, the outside of the hub of the needle or the button of the plunger, but never touch needles with your fingers or with anything else that is not sterile.
- Always wash your hands with soap and water before sterilising or touching sterilised items.
- Ideally, clean and sterilise needles and syringes immediately after an immunisation or injection session. If this is not possible, clean immediately after and sterilise the next morning.
- If you have to sterilise syringes and needles during an immunisation session, allow them to cool before use because hot syringes and needles can destroy or inactivate vaccines.
- Never try to sterilise and re-use disposable syringes and needles. The high temperatures required for effective sterilisation damage disposable syringes and needles.

## Practical tips on using and re-using gloves

Health workers should:

- Wear gloves to protect against infection during certain patient procedures, e.g. assisting during delivery, or handling soiled and contaminated material, e.g. blood and other body fluids.
- Use sterile gloves for sterile procedures, e.g. during suturing or surgery.
- Use clean gloves for other procedures not requiring sterile gloves.
- Change gloves between patients and only use a pair of gloves once.

If there are not enough disposable gloves for a 'one use' only approach, wash and disinfect gloves carefully between use:

- Examine gloves carefully and dispose safely of damaged gloves, e.g. gloves that are peeling, cracked, have tears or punctures. To check for tears or punctures:
  - Gently blow into the gloves until they are full of air, twist the cuff and hold them under clear water. If the gloves have holes you will see air bubbles under the water
- OR
- Fill the gloves with clean water, twist the cuff and squeeze them to see if they leak.
- Wash intact gloves with clean water but not with soap, before disinfection. Soap makes latex sticky and easy to break.
- Disinfect the gloves by boiling for 20 minutes OR soaking them overnight in bleach (sodium hypochlorite) solution. Good quality latex gloves can be disinfected using either of these methods five or more times.
- Gloves can be sterilised, but only if you have the equipment to sterilise and package them to keep sterile.
- Dry gloves out of direct sunlight. Sprinkle gloves inside with talcum or starch powder when dry and before re-use, to re-lubricate them.

## 2.5 Disposal of waste

Waste disposal is essential in all settings, including those with limited resources where staff may be reluctant to throw away supplies, such as disposables, which are seen as 'still functional' and valuable.

Proper management of waste products helps to keep the health facility clean and tidy, prevents the spread of disease, reduces the risk of injury, and prevents re-sale and re-use. Incorrect management of waste places waste handlers, health workers and the community at risk of infection and injury.

### Waste handling and management

Waste handling, treatment and disposal methods must be practical, safe, affordable, appropriate and sustainable. To ensure proper management of waste:

- Adopt a safe disposal policy that conforms to national guidelines. If these are not available you can adapt WHO guidelines.
- Ensure you have sufficient funds in your budget for proper waste management.
- Involve staff in developing policy and protocols for collecting and handling waste.
- Train all facility staff, including cleaners and handymen, in proper waste collection, handling and disposal and explain the health risks of unsafe practices.
- Assign responsibilities for waste collection, handling and disposal. This includes appointing an official waste handler to collect and manage waste, and making sure health staff sort the waste they produce into categories for different disposal methods.
- Provide staff with the equipment and clothing they need to manage waste correctly and to protect their safety. Provide waste handlers with protective clothing (overalls), heavy duty gloves and boots; provide clinic staff with disposable gloves, and provide goggles to those responsible for incineration to protect their eyes.
- Monitor waste management activities.

### Waste collection, treatment and disposal

Waste material should be sorted, ideally at the site where it is generated, for collection. In some urban areas, the MoH may collect waste for centralised treatment and disposal. Waste should be placed in sealed bags for transport. If there is no collection service, separate waste into material for incineration, burning or burying and, where appropriate, recycling or re-use.

Collect waste daily and take it to a secure, safe central collection or storage point for treatment and/or disposal. Never deposit waste in the open or on the surface of open dumps. Follow these practical guidelines:

- Collect waste in good quality metal or plastic buckets which have a close-fitting lid or in strong, leakproof plastic bags.
- Make sure you have enough containers to be able to replace full buckets with clean, empty ones.
- Keep containers covered to avoid attracting flies and rodents.
- Replace containers before they become too full.
- Clean and disinfect buckets between use. If you use chlorine for disinfection, use plastic buckets because chlorine causes metal buckets to rust.
- Dispose of waste regularly. Waste should not be stored for more than 24-48 hours before disposal. In very hot climates, organic waste such as organs and placenta should be disposed of immediately if possible.
- Reusable or recyclable materials, e.g. plastic, metal and glass items, should be kept separate from other categories of waste for decontamination before re-use.
- Set aside and designate a specific place as the disposal site. The site should be at least 30m away from the health facility and from drinking water sources, to avoid contamination.



- Put up a fence around pits or incineration sites. This should secure and protect against theft and scavenging and prevent accidents and entry of animals and unauthorised persons.

Treatment and disposal methods depend on the type of waste. Different methods of waste treatment and disposal are summarised in Table 2.14 and different types of waste are summarised in Table 2.15.

## Collection and disposal of sharps waste

Sharps are items that can pierce the skin, for example needles, lancets and scalpels. As noted in Section 2.4, health workers and patients are exposed to the risk of infection through sharps injuries from used needles and re-use of contaminated needles and syringes. Proper disposal of sharps, in particular needles and syringes, is therefore extremely important and methods for collecting sharps waste are described below. These methods, designed to be used where sharps waste is generated, e.g. dressing room, ward or immunisation site, could minimise the risk of accidental needlestick injuries by reducing the need for health workers to recap needles. These methods also reduce the risk of infection from re-use of disposable needles and syringes by encouraging disposal at point of use.

### Safety box

Safety boxes are special boxes for collection of used needles and syringes. They come as flat packs for ease of storage and transport, but are also available as rigid plastic containers in a range of styles and sizes. When the box is nearly full, it is sealed and disposed of by incineration, burning, or burying in a deep pit.

Whereas safety boxes are used for collecting needles and syringes, the three methods described below minimise the volume of sharps waste by separating syringes (non-sharps) from needles (sharps).

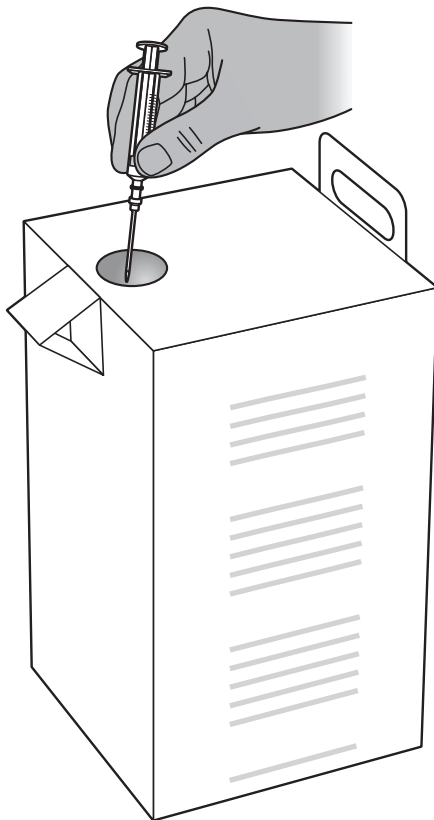

Puncture proof safety box

### Puncture resistant container

Puncture resistant containers can be locally and cheaply made from sealable, thick plastic or metal containers, for example, old tablet bottles. A small hole is cut in the lid, and the needle part of the 'syringe and needle' is put into the hole and allowed to slide towards one of the corners of the container so that the hub is under the lid. When the syringe is pulled up, the needle falls into the container.



Puncture resistant container

The small hole in the lid prevents sharps spilling out if the container is knocked over, reduces the risk of accidental needlestick injuries or re-use, and decreases the amount of sharp waste by separating syringes from needles. When nearly full, the hole is taped over and the container is incinerated, burned, or buried in a deep pit. Used syringes should be treated as infectious waste and incinerated or burned.



## Needlyzer

A Needlyzer is a device that destroys the needle all the way up to the hub and totally eliminates the sharp. The needle is destroyed by being oxidised while it is still attached to the syringe, butterfly, vacutainers, tubing etc. The Needlyzer is powered by a rechargeable battery and can destroy up to 30 needles per second. Granular powder generated by the oxidation process is collected in a small replaceable cartridge, which has the capacity to hold debris from 3,000-5,000 destroyed needles. The syringe is left intact and, again, should be treated as infectious waste.

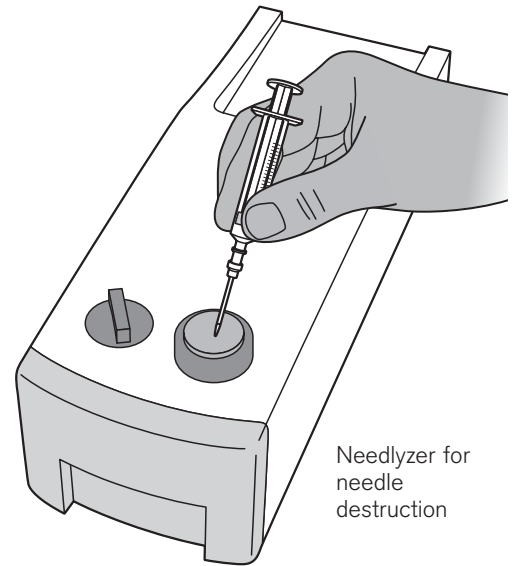
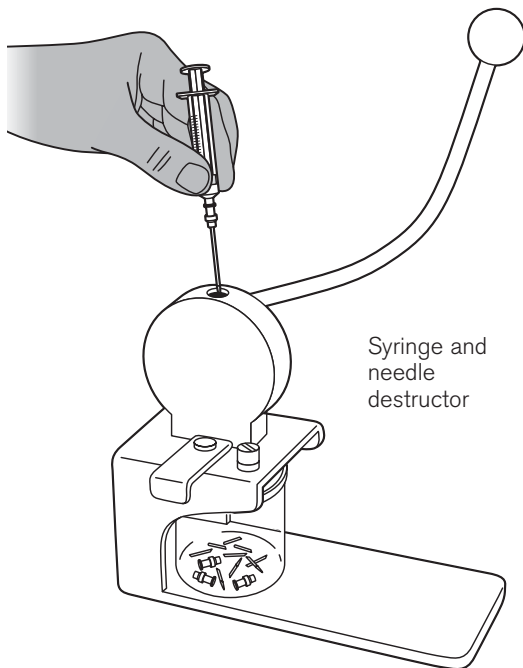

## Balcan destructor

The Balcan destructor is a manually-operated device made of specially hardened stainless steel that renders both needle and syringe unusable. It has a hole at the top into which the full length of the needle is inserted. Pushing the destructor handle in one motion cuts the hub of the syringe and chops the needle into several pieces. The debris is collected in a pot fitted and secured underneath the destructor.

When the pot is full it is sealed with a lid and incinerated, burned or buried. The destructor pot can hold approximately 250 chopped needles. Remember that cut needles are still sharps and should be treated as such. Syringes that have been rendered useless can be disposed of as common waste and do not need to be incinerated or burned.

The Balcan destructor is also suitable for use with reusable syringes that can be sterilised. It has a simple mechanism that allows needles to be safely removed and destroyed, leaving the reusable syringe intact.

**Table 2.14 Different methods of waste disposal**

Method	Comments	Advantages	Disadvantages
<b>Incineration</b>	<p>Incineration is often the simplest and most appropriate waste disposal method, although not necessarily in urban settings or small facilities. Incineration should be carried out at least twice a week. Suitable on-site options include a simple, low-cost, low-maintenance, 2-chamber incinerator that uses locally available fuel, can reach a temperature greater than 800°C, is easy to operate and maintain, and can incinerate approximately 10kg of waste per hour, e.g. the DMU incinerator or the Medcin 400:</p> <ul style="list-style-type: none"> <li>- DMU incinerator, designed to be built on site using bricks, firebricks and steel, uses local fuel (wood or charcoal or kerosene or diesel).</li> <li>- Medcin 400, pre-assembled, gas incinerator.</li> </ul> <p>See Appendix 1 for more information.</p>	<ul style="list-style-type: none"> <li>• Reduces volume and weight of waste.</li> <li>• Makes waste unusable.</li> <li>• Prevents scavenging</li> <li>• Decontaminates and produces less hazardous waste and non-infectious debris.</li> <li>• Does not require highly trained operators, but staff must be trained in safe and correct use of incinerator.</li> </ul>	<ul style="list-style-type: none"> <li>• Running costs, e.g. fuel, may be too high for some health facilities.</li> <li>• Not environmentally friendly.</li> </ul>
<b>Burning</b>	<p>Burning is one of the most common methods of waste disposal and is an acceptable alternative if incineration is not possible. Burning waste in a shallow pit or drum, e.g. the Dunsmore drum burner, is safer for operators and less of a hazard than uncontrolled open burning. After waste burning is completed, ash and other debris should be removed from the drum or pit and buried safely.</p> <ul style="list-style-type: none"> <li>- Dunsmore drum burner, 210 litre steel drum, with both ends removed, placed over a fire. (Other fire-resistant material, e.g. a large section of clay pipe, can be used instead of a steel drum). Burns one bag of waste at a time. A strong metal grate holds the burning waste above the fire, and a fine screen on top of the drum prevents ash blowing out.</li> </ul>	<ul style="list-style-type: none"> <li>• Reduces volume and weight of waste.</li> <li>• Makes waste unusable.</li> <li>• Prevents scavenging.</li> <li>• Produces less hazardous waste and non-infectious debris.</li> <li>• Low cost.</li> </ul>	<ul style="list-style-type: none"> <li>• Can be difficult to burn waste completely without generating smoke and to maintain a high temperature.</li> <li>• Partially destroyed or decontaminated waste material can be hazardous.</li> <li>• Requires mixing with material that burns easily, e.g. wood shavings.</li> <li>• Not environmentally friendly.</li> </ul>
<b>Burying in a deep pit</b>	<p>The pit should be 4-5m deep and 1-2m wide and its boundary lined with material, e.g. clay that prevents pollution of drinking water sources. Only use in areas where there is no risk of flooding, the water table is low and will remain at least 1.5-2m below the base of the pit even during the rainy season.</p> <p>Cover each load of waste with a layer of soil, leaves or ash to prevent bad smells, avoid attracting insects and rodents, and to speed up decomposition.</p> <p>Protect the pit and prevent accidents with a tight-fitting cover over the opening.</p> <p>You may need more than one pit if your facility produces a lot of waste.</p>	<ul style="list-style-type: none"> <li>• Low cost.</li> <li>• Relatively safe, if waste is buried properly.</li> </ul>	<ul style="list-style-type: none"> <li>• Can pollute water if the soil is permeable or the pit is too close to the water table.</li> <li>• Only practical for a short time. Once available space is filled a new pit is needed.</li> <li>• Must be protected with a fence or guarded to prevent scavenging.</li> </ul>
<b>Encapsulation</b>	<p>Encapsulation involves filling a plastic or metal container with waste, adding 'immobilising' material, e.g. cement mortar, clay or bitumous sand, when the container is about ¾ full, waiting for the material to dry, then sealing and burying the container.</p>	<ul style="list-style-type: none"> <li>• Simple and safe.</li> <li>• Suitable for drugs, chemicals, sharps.</li> <li>• Prevents scavenging.</li> <li>• Reduces water source pollution risk.</li> </ul>	<ul style="list-style-type: none"> <li>• Can be costly.</li> <li>• Not recommended for infectious or non-sharps waste, because of the large volumes involved.</li> </ul>

Dunsmore drum burner  
for health care waste

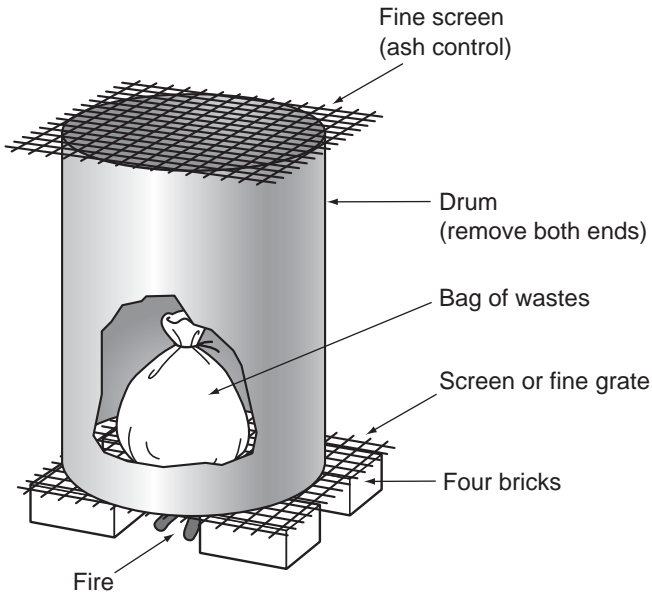

DMU incinerator for mixed  
health care waste

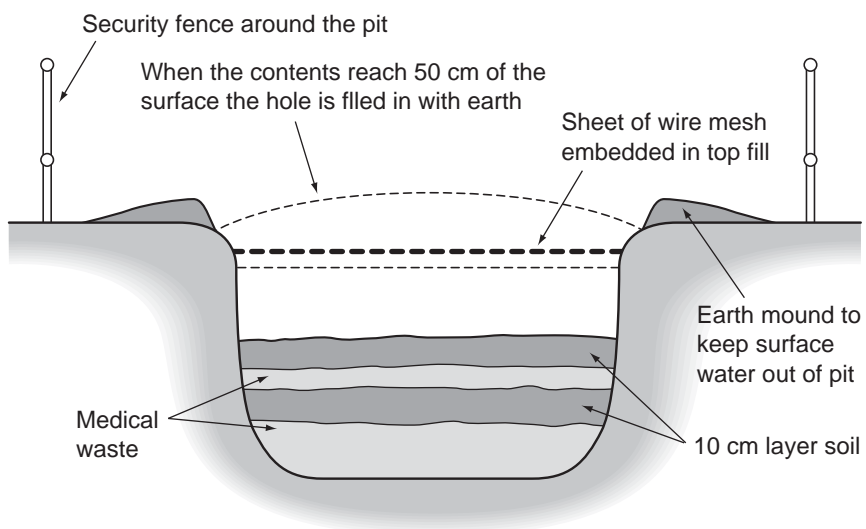
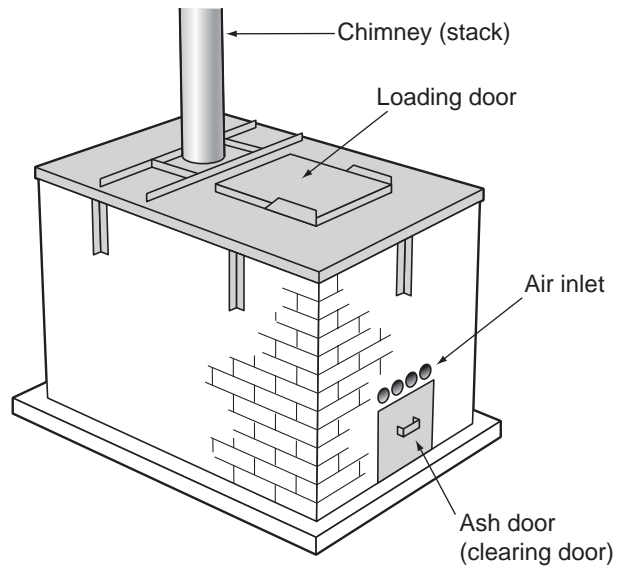

Burial pit for health care waste

**Table 2.15 Different types of waste**

<b>Waste type</b>	<b>Disposal method</b>	<b>Comments</b>
<p><b>Infectious waste</b> Waste contaminated by blood, body fluids, laboratory cultures, dressings and other materials that have been in contact with infected patients</p>	<p>Incineration</p> <p>Burning</p>	<p>Collect in good quality plastic or metal buckets with close-fitting lids or leakproof plastic bags. If possible, use double packaging, e.g. plastic bag inside bucket. Keep buckets covered, empty them when they are almost full, clean and disinfect between use. Collect infectious waste and general medical waste together rather than separately (see below). Certain infectious waste, e.g. sputum from TB patients should be disinfected before disposal in accordance with national guidelines.</p>
<p><b>General medical waste</b> Syringes (without needles), bandages, swabs, paper, gloves</p>	<p>Incineration</p> <p>Burning</p>	<p>Collect in a good quality plastic or metal bucket with a close-fitting lid, along with infectious waste. Incinerate or burn used syringes that have been separated from needles. Do not bury waste that will not decompose, e.g. plastic or metal items. Incineration or burning reduces the volume of waste.</p>
<p><b>Drugs and vaccines</b> Expired, damaged or spoilt, unused, unidentifiable</p>	<p>Return to supplier</p> <p>Incineration</p> <p>Burning</p> <p>Encapsulation</p> <p>Discharge to sewer</p> <p>Pit latrine</p>	<p>Follow national procedures for dealing with expired, damaged and unidentifiable drugs and vaccines. Keep a register of action taken or disposal method. Inform your supervisor. It is important to dispose of drugs and vaccines carefully to prevent pilfering, re-sale and re-use of expired or ineffective drugs and vaccines. For this reason, do not throw them away in their original packaging. Collect in lockable containers and keep separate from other supplies in a secure, locked place.</p> <p>Dilute mild cough mixtures, IV solution, eye drops with large amounts of water and pour down the sink or into a pit latrine. Pour in more water after disposal. Incorrect disposal can potentially contaminate water supplies.</p> <p>In practice, expired or damaged items that were supplied by the government health system, should be returned to the district store for disposal. Mark items as 'expired' or 'damaged' when returning to sender.</p> <p>Incineration and burning is only suitable for disposing of small quantities of drugs, but could be used for expired or damaged drugs provided from sources other than MOH, when it would be too expensive to return to sender. If drugs are still usable, try to find another health centre that can make use of them.</p>
<p><b>Chemical waste</b> Unused, expired reagents, disinfectants</p>	<p>Incineration</p> <p>Burial in deep pit</p>	<p>Collect in a good quality plastic or metal bucket with a close-fitting lid. Follow the same disposal methods as for infectious waste if you have the authority to dispose of chemical waste or, preferably, return reagents and undiluted and expired disinfectants to the district store.</p>
<p><b>Waste containing heavy metals</b> Batteries, BP gauges, broken thermometers</p>	<p>Recycling</p> <p>Encapsulation</p> <p>Burial in deep pit</p>	<p>Collect in a good quality plastic or metal bucket with a close-fitting lid. Do not burn or incinerate because waste containing heavy metals is toxic and pressurised containers may explode. Encapsulation is the safest method for dealing with this type of waste.</p>
<p><b>Delivery waste</b> Placenta, aborted foetus</p>	<p>Pit latrine</p> <p>Placenta pits</p>	<p>Collect in plastic bags or, if not available, plastic buckets with close-fitting lids. Health workers should only deal with placenta or aborted material if this is culturally acceptable. In some cultures, the family will want to take the material home.</p>

Waste type	Disposal method	Comments
<b>Sharps</b> Needles, needles and syringes, blades, scalpels, broken glass, ampoules, infusion sets	Incineration Burning Encapsulation Burial in deep pit	Sharps are hazardous and need careful handling, as there is a risk of needlestick injury, cuts and puncture wounds, and of infection of these wounds if sharps are contaminated or through subsequent handling of waste. Dispose of single use needles and syringes after one use and of reusable needles and syringes when these are damaged or worn out. Never recap or remove used needles from the syringe by hand. Collect used sharps in safety boxes or puncture resistant sealable containers, not flimsy cardboard boxes. Keep containers close to where sharps waste is generated. Tape over the hole and dispose of the container when it is nearly full. Throw it into a deep pit, incinerate or burn. Destruction by incineration at a temperature above 800°C (lower temperatures will just make the sharps soft and pliable) is the best method, although care is needed to avoid potential needlestick injuries when emptying the incinerator. Sharps, including needles in containers, should be mixed with other waste before incinerating or burning.
<b>Organic waste</b> Food and vegetable matter	Compost pit Organic waste pit	Collect in a bucket with close-fitting lid. Biodegradable waste, including animal dung, can be composted and used as fertiliser after 4-6 months.
<b>Cholera waste</b> Cholera stools and vomit	Chemical disinfection Pit latrines Burial in deep pit Incineration Burning	This is highly infectious waste. Put liquid waste (stools and vomit) in a pit latrine or bury it. Disinfect it first by mixing it with disinfectant, such as cresol, lysol or bleach. Incinerate semi-solid waste. If this is not possible, burn then bury it. Collect cholera waste separately and keep it separate from other waste, if possible in single use plastic bags. Disinfect buckets and containers used for collecting all types of cholera waste, preferably with 150ml of 2% chlorine, each time after emptying.



# SECTION 3



## Supplies and equipment for primary health care

This section includes information about essential supplies and equipment for primary health care services.

- **Section 3.1** covers basic supplies and equipment required for general tasks carried out by health facilities.
- **Section 3.2** covers supplies and equipment for key primary health care activities including: preventive child health; reproductive and sexual health; dressings, minor surgery and first aid; eye care; and health education and promotion.
- **Section 3.3** covers supplies and equipment required for basic laboratory facilities.
- **Section 3.4** covers supplies and equipment required for community care.
- **Section 3.5** describes new developments in supplies and equipment for primary health care.

Each section is a list of supplies and equipment in a table format. These lists have been developed on the basis of extensive experience and feedback from many individuals working in primary health care.

When you use the lists, it is important to note that:

- The lists have been kept as short as possible, with an emphasis on items that should always be available, using the VEN system. Each list is divided into two categories. Items that are 'vital' and 'essential' are printed in bold type, e.g. **Apron**. Items that are 'not so essential' or optional are printed in italic type, e.g. *Drip stand*.
- The tables list each item, with descriptions, specifications and guidelines about quantities. Additional information, e.g. about care and use, is included in the remarks column.
- The full description and specification is included for each item where it first appears or when it is a key item. The description and specification is not repeated when the item is mentioned subsequently. Instead the page number is given to tell you where to refer to for a full description and specification, e.g. Stethoscope, dual head first appears on page 71, so where it is mentioned on page 73 it says, see p71.
- Items are sometimes known by several different names. These items are listed using the most well-known name, and other names are included in brackets, e.g. **Nailbrush** (surgical brush).
-  means that this item is illustrated, e.g. Cotton wool buds . Please note the size of the illustrations are approximate and for guidance only.
- The information provided is generic and the quantities suggested are appropriate to an initial stock to enable a health facility to provide basic primary health care services. You may need to adapt the quantities to your situation, taking into account local priorities and resource constraints. Information about estimating quantities of supplies and equipment required is provided in Section 2.1 and a standard list of essential drugs for PHC is provided in Appendix 2.
- The type of supplies and equipment required will depend on the level of your health facility and laboratory, the type of health problems in the community and the number of patient contacts, and the training and skills of the health workers who will use them. For example, supplies and equipment for delivery care are divided into a basic list of items for TBAs and a more comprehensive list of items for midwives.
- The same item is sometimes used for a range of different activities. These items are included in all the relevant lists, but this does not mean you need to have duplicate items for each different activity. For example, one apron per health worker is included in the list of general supplies and equipment and in the list for delivery care. The same apron can be used for different purposes, and health workers do not need a separate apron for each type of activity.
- Before you make your lists of supplies and equipment using this section, make sure you are clear about what you are trying to do, and what resources you have or need to be able to use the supplies and equipment. There is no point ordering items if, for example, your facility does not have staff with appropriate skills or cannot access technical back-up, spare parts or maintenance support. Use the criteria in Section 1 and the guidelines in Section 2 to help you draw up a list.

## 3.1 General supplies and equipment for health facilities

This sub-section describes basic supplies and equipment required for: general tasks that are carried out in all health facilities; diagnosis; general patient treatment and care; and boiling and sterilising.

### General supplies and equipment

Item	Specification	No. required	Remarks
<b>Apron</b>	Plastic, heavy duty, re-usable, 100-115cm in length	1 per health worker	For protecting staff clothing.
<b>Gloves for examination</b> (protective)	Latex, pre-powdered, non-sterile, disposable, mix of small, medium, large, pack size 100 per box	At least: <i>Small</i> 1 box <i>Medium</i> 2 box <i>Large</i> 1 box	To protect against infection during treatment or handling soiled or contaminated material. Should be discarded after each patient or checked for damage, washed and disinfected before re-use.
<b>Glove powder</b>	Talc purified, 1kg or purified maize starch, also available in sterile sachets, 1.5g	At least 1kg	For lubricating cleaned and disinfected latex gloves. Alternatively use starch powder or water-based (but not oil- or petroleum-based) lubricant. Before re-use, dust insides of gloves with powder.
<b>Gloves for heavy duty tasks</b> (domestic)	Rubber, heavy duty, household, reusable, small, medium, large	At least 1 pair per general cleaner and 1 spare set	To protect hands when washing, general cleaning and collecting waste.
<b>Nailbrush</b> (surgical brush)	Plastic with nylon bristles, sterilisable, length 8-10cm, width 3-5cm	At least 1 per room	For scrubbing under fingernails. Alternatively use a thin piece of bamboo or similar stick for cleaning under fingernails.
<b>Cotton wool buds</b> (Q-tips, cotton buds)	Cotton tipped applicators, non-sterile, single use, 100 per pack	1 pack per room	General use, but not suitable for swab specimen. Can be made using cotton wool and applicator stick.
<b>Applicator sticks</b>	Plain wooden sticks, 12cm x 1mm, 500 per pack	At least 2 packs	General use from making cotton buds to cleaning fingernails.
<b>PVC sheeting</b> (plastic, mackintosh)	Plastic, heavy duty, reusable, approx. 90–120cm x 180cm	At least 1 per bed/examination couch	To protect mattresses, examination couches, and provide a clean delivery surface. Heavy duty sheet will last longer.
<b>Buckets</b>	Plastic, approximately 12-20l, with lid or foot operated	At least 2-3 per room	For general use including collecting dirty items, segregating waste. Keep covered to avoid attracting flies and rodents.
<b>Bedpan</b>	Adult, sterilisable, plastic or SS	For 50% of in-patient beds	Wear gloves when emptying the. Clean and disinfect immediately after use.
<b>Urinal</b>	Sterilisable, plastic or SS, capacity 1000mls approx. with or without cap	For 50% of in-patient beds	Wear gloves when emptying. Clean and disinfect immediately after use.



Item	Specification	No. required	Remarks
<b>Basin</b>	Round or square, approx. 12l, rigid plastic, general purpose or domestic type	At least 1 per room and per bed	For general cleaning and patient use. Do not mix basins for general cleaning and patients. Have different basins for clean use and dirty use, e.g. washing cups and washing floors.
<b>Measuring jug</b>	Plastic or SS, reusable, graduated with handle, 500mls-1l	At least 2	For measuring fluids, e.g. making ORS. It is easier to see and read the fluid level in transparent plastic jugs.
<b>Stretcher</b>	Canvas, foldable with poles (aluminium or wooden), approx. 2m x 60cm	At least 1	Can be manufactured locally.
<b>Tape measure</b>	Fibre glass cloth, 1.5m graduated in cm and inches (metric/imperial)	At least 4 for general use	Multipurpose use and general measuring. Make sure made of non-stretch material.
<b>Examination couch</b> (examination table)	Foldable, 2 sections, hinged/adjustable backrest and couch, SS or epoxy coated or wooden frame, padded with washable, waterproof cover (vinyl, leather or plastic), approx. 1800 x 60 x 100cm (l x w x h)	At least 1, ideally 1 per examination room	Folding legs for easy transport and storage. Can be made locally. Backrest adjustable to at least 5 positions. Padding for patient comfort. Available accessories usually include leg holders (lithotomy sockets) and heel stirrups.
<b>Steps</b>	2–3 steps, wooden, 50 x 40 x 20cm (l x w x h)	1 per examination couch	For getting onto the couch. Can be made locally. Alternatively use a stool.
<b>Bed</b>	Frame: SS (good quality) or epoxy coated metal or polymerised finish, standard size approx. 198 x 91cm, lockable anti-static castors at head, rubber feet at base  Mattress: foam, waterproof cover, approx. 191 x 91 x 10cm (l x w x h)	At least 1  1 per bed	1 for 'emergency' e.g. patients waiting to go to hospital. Actual number depends on activities of facility. SS or epoxy coating or polymerised finish frames will be more resistant to regular washing, knocks and abrasions. Paint covering on metals tend to chip, scratch and flake and with frequent washing the metal will rust. Fireproof foam mattresses with washable covers are recommended.
<b>Trolley</b> (cart for dressing/dispensing)	SS or epoxy coated metal, approx. 90-95 x 45-55 x 80-100cm (l x w x h), 2–3 shelves, guard-rail (optional), rubber swivel anti-static castors	At least 2 (1 for general use, and 1 for ward area)	Can be made locally or purchased as flat pack for assembly. If you regularly need to move the trolley, buy one fitted with castors. Those without castors should not be dragged, pulled or pushed.
<b>Screen</b>	3-4 panels, plastic or fabric curtains, foldable, mobile on castors	At least 2 (1 for consultation room and 1 for ward area)	To provide privacy. Can be locally made of timber frame covered with cotton fabric.

Item	Specification	No. required	Remarks
<b>Water filter</b> (gravity filter)	<p>Gravimetric filter with output of 40-80l/24 hours, SS, 2 sections, upper section fitted with ceramic candle filters (elements), washers, wingnuts, lower section with tap, non-slip anti-condensation rubber ring</p> <p>Spare: candles and washers</p>	<p>At least 2 (1 for general use and 1 for dispensing area)</p> <p>At least 2 candles and washers for each water filter</p>	<p>To provide clean, safe water for cleaning, rinsing, drinking, preparing disinfectants and liquid drugs and some laboratory reagents and stains. Filtration cleans but does not reduce the salt and mineral content of the water. Some filters can be adapted to vary the output, from 20-80l/24 hours by the number of candles in use (1 candle provides output of 20l, 2 candles 40l, 3 candles 60l and 4 candles 80l). The unused candle holes must be blocked with rubber plugs (supplied by manufacturer). Candles are self-cleaning and do not require boiling. On a regular basis or when the flow becomes weak, remove and clean candles by holding under running water or in a bowl of water. Clean ceramic part of the candle by scrubbing with a stiff brush in direction away from candle mount. Check for cracks or damage. Do not use soap, detergent or bleach for cleaning. Replace candles approx. every 12 months or as recommended by manufacturer.</p>
<b>Soap</b> (toilet bar)	Approx. 100g bar, wrapped or unwrapped	At least 1 per room	For personal hygiene.
<b>Wash stand</b> (wash basin with stand)	Single bowl metal stand, basin (plastic or SS) to fit the stand, metal water container with tap, 15-20l capacity	At least 1 per room	Alternative to sinks for hand washing. Can be made locally.
<b>Scissors</b>	SS, straight, sharp/blunt, approx. 18cm	At least 2	General purpose, e.g. cutting paper.
<b>Clock</b> (timer)	Wall, approx. 25cm diameter, black hand, red second hand, battery-operated type "AA" 1.5V	1 in each key area	Important for timing activities, e.g. delivery, taking pulse, giving treatments, and general time keeping.
<b>Tray general</b>	Plastic, shallow, approx. 36 x 46cm	At least 1 per room	For general purpose.
<b>Kerosene lantern</b> (lamps)	Hurricane type, 340ml capacity, clear globe, wick	At least 2	Offers an alternative light source or standby.
<b>Scrubbing brush</b>	Heavy duty, wooden with bristles	At least 2	For cleaning floor and walls.

Item	Specification	No. required	Remarks
<b>Toolkit</b>	Screwdrivers flat blade, 3.2-8mm, insulated handle	1 set	Basic and simple tool kit to discourage repairs outside staff capability. Assign responsibility for kit to 1 person. Draw up a checklist of all the tools and carry out tool checks regularly. Keep toolbox locked and stored in a secure place.
	Screwdriver Philips (star), no. 0-3, insulated handle	1 set	
	Pliers combination, 125mm, insulated handle	1	
	Pliers slip-joint, approx. 24mm, 2 position	1	
	Pliers longnose, 125mm, insulated	1	
	Plier cutters, 125mm, insulated	1	
	Spanners flat, 9-22mm	1 set	
	Spanners ring, 9-26mm	1 set	
	Tape measure retractable, 3m	1	
	Hammer claw, approx. 450gm	1	
	Hammer 280mm	1	
	Allen keys 2-10mm	1 set	
	Brush paint, flat, 25mm	1	
	Brush paint, round, 2cm diameter	1	
	Tape, insulating, black and red	1	
Multimeter digital, with AC/DC voltage, AC/DC current, resistance and continuity measurement functions	1	Multimeter digital to carry out basic electrical measurements.	
Tool box, steel, lockable	1		
<b>Registers (records)</b>	A4 hardback book, lined or pre- printed formats	At least 1 for general registration and at least 1 per activity including: out-patients, in-patients, maternal care, family planning, child health, laboratory, financial, referrals, maintenance, community activities, logbook	For recording patient numbers, age, disease etc. Useful source of information (e.g. daily workload, disease patterns, activities carried out, supply requirements) and for general supervision. Accurate and consistent record keeping is central to good management and service delivery. Should be kept where they are used, e.g. laboratory register in laboratory, delivery register in delivery room. Logbook to record 'health unit issues' such as supervisory visits, minutes of staff meetings, problems etc.  To avoid having to rule and head each page separately, use a 'ruled and headed' backing card, placed behind the page being used. Backing card must be heavily ruled with a marker pen so that the lines can be seen clearly. Different registers, each with its own card, can be prepared and used this way.

<b>Item</b>	<b>Specification</b>	<b>No. required</b>	<b>Remarks</b>
<b>Patient record cards or patient booklets</b>	National patient record cards if available, or WHO cards/booklets adapted to local situation	1 per patient	Either kept by the patient or at the clinic. If kept by the clinic, use a system for filing, which makes them easy to find, e.g. numerical order. Card must be printed on paper strong enough to withstand frequent use.
<b>Forms</b>	National or WHO forms adapted to local situation	1 per patient	Wide range of forms may be needed from admission, ordering to birth notification forms.
<b>Referral forms</b> (referral letter)	National or WHO forms adapted to local situation	1 per patient to be referred	Used for patients who need additional tests and/or treatment at another health unit. The original must go with the patient and then be returned after treatment at the referred unit. Encourages continuity of care. Use standard referral letters (either pre-printed forms or hand written). Basic information should include: time and date of referral; name of referral unit and referring health worker; patient's name and age; reason for referral; treatment given; care, treatment and follow-up advice from referral centre to referring unit.
<i>Crutches</i>	<i>Adult and child size</i>	<i>At least 1 of each size</i>	<i>Could be made locally.</i>
<i>Soap dishes</i> (soap container)	<i>Plastic with lid, boilable, 95 x 65 x 35mm</i>	<i>At least 1 per room and 2 per mobile team</i>	<i>To hold a bar of soap approx. 100g size.</i>
<i>Drip stand</i>	<i>Adjustable height up to 2m, SS stand, double hook, stand base mounted on anti-static castors with 2 lockable castors, topple safe</i>	<i>At least 1</i>	<i>Alternatively, put hooks on the wall.</i>
<i>Wheelchair</i>	<i>Adult, folding, 44 x 40cm seat, self propulsion, detachable footsteps, hand brakes</i>	<i>At least 1</i>	<i>For transporting sick or disabled patients.</i>
<i>Voltage stabiliser</i>	<i>3 kW/13 Amps model</i>	<i>At least 1</i>	<i>For use with sensitive electronic equipment. Electronic equipment can be damaged by power fluctuations. Voltage stabilisers protect against fluctuations but not power cuts. Suitable for use with mains and generators. Many models on the market. Some can be expensive.</i>

**Nailbrush**

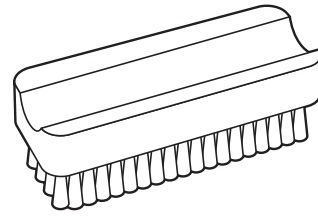

**Applicator sticks**

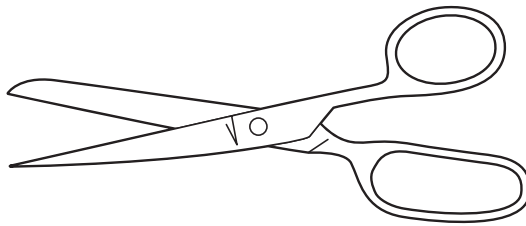
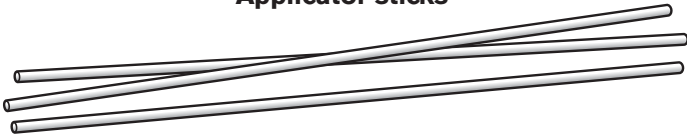

**Scissors - general**

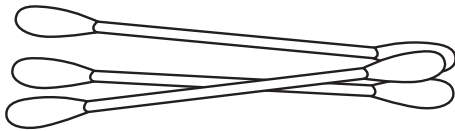

**Cotton wool buds**

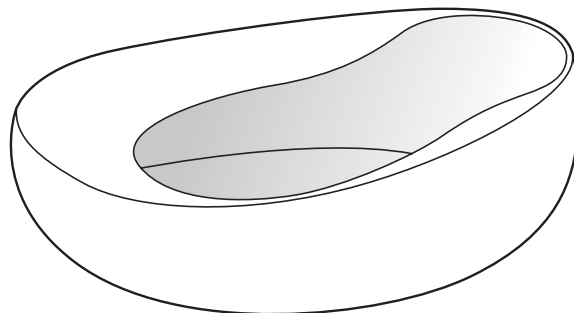

**Bedpan**

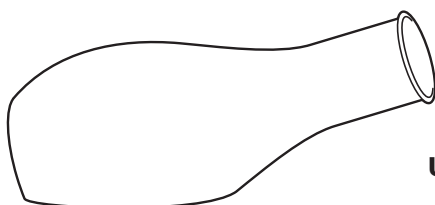

**Urinal**

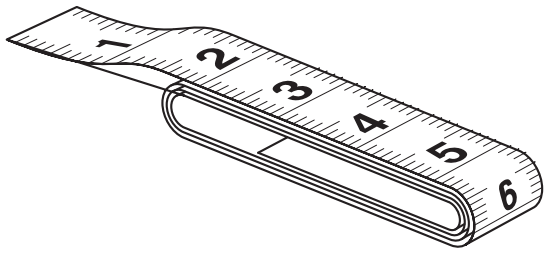

**Tape measure**

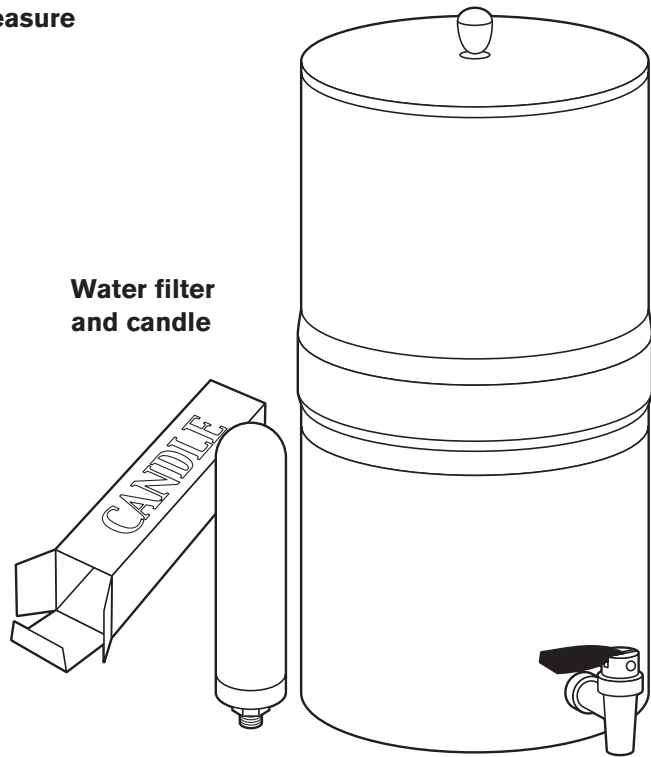

**Water filter  
and candle**

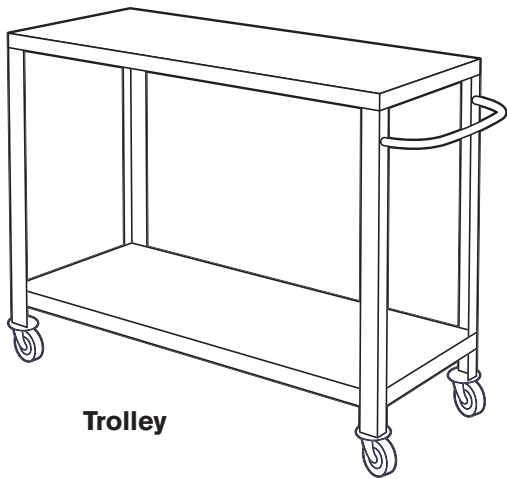



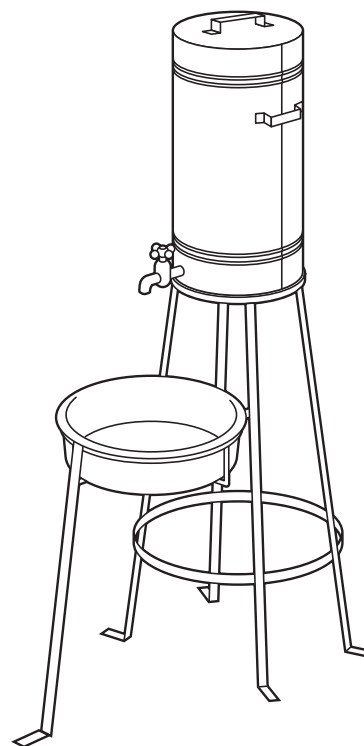

**Trolley**





**Wash stand**

## Diagnosis

Procedure	Item	Specification	No. required	Remarks
Measuring a patient's temperature	Thermometer	Clinical, suitable for oral, rectal or axillary (under the arm) use, graduation scale in °C (35-45°C) and °F (94-113°F), mercury, plastic case optional	At least 2 per staff member carrying out consultations  10 spares in case of breakages	Wash with warm soapy water, rinse in cold water and wipe with thermometer disinfectant between patients. Do not use hot water, which may break the thermometer. Keep separate, labelled thermometer for rectal use.
		<i>Clinical, subnormal, 25-40°C, mercury, plastic case optional</i>	<i>At least 2</i>	<i>To measure temperature of premature infants.</i>
Measuring blood pressure	 <b>Spygmo-manometer</b> (Blood pressure [BP] apparatus, hand manometer)	Mercury or aneroid, complete with washable cloth cuffs, with or without velcro fastenings, hand inflation bulb and valve, carrying case. Cuff sizes: Adult: 57 x 14.5cm Child: 53 x 10.5cm  Spare: bulbs, cuffs, tubing, valves	At least 1 per consultation or examination room and 1 for ward	Mercury devices are more costly, but more accurate, reliable and easier to repair. Aneroid types need regular recalibration to ensure accuracy – check accuracy against mercury device every 6 months. Velcro fastening (sticky fabric) allows tight adjustment around the arm. Incorrect cuff size is a major source of error. An undersized cuff may over-estimate BP, an oversized cuff may under-estimate. Rubber tubing tends to crack, particularly when stretched.
	 <b>Stethoscope</b>	One head (cup), aluminium with 43mm diaphragm (adult) and ring, Y vinyl tube, SS springy arms, changeable plastic ear pieces, supplied with spare diaphragms and earpiece  <i>AND/OR</i>  Dual head (cups), pivoting, aluminium, SS or chrome-plated brass with 1 adult (43mm) and 1 paediatric (28mm) diaphragm, Y vinyl tube, SS springy arms, changeable plastic earpiece, supplied with spare diaphragms, earpiece	At least 1 per consultancy or examination room and 1 for ward	For measuring BP, one-cup and economy model stethoscopes are suitable. Spring arms provide reliability and comfort.  Earpieces need to be unscrewed occasionally and any ear wax removed.  Dual head stethoscopes should be used primarily for auscultation and diagnosis.

Procedure	Item	Specification	No. required	Remarks
<b>General examination, particularly of mouth, throat and eyes</b>	<b>Torch</b> (flashlight)	Hand held, pocket, with 2 x 1.5V batteries  Spare: bulbs and batteries	At least 1 for each health worker carrying out consultations	Ophthalmoscope may be used instead for eye examinations.
<b>Weighing patients</b>	<b>Adult scale</b> 	Stand on, bathroom, mechanical, range 0-100kg in 500g divisions, portable  <i>OR</i> Stand on, bathroom solar, range 0-150kg in 100g divisions, powered by long life lithium battery, portable  <i>OR</i> Scale, sliding beam type, range 0-150kg in 100g divisions, (available as metric or dual graduation), weight approx. 14kg  Height measure rod, measuring range 80-200cm in divisions of 1mm, optional	At least 1 adult scale and 1 height measure scale	Bathroom type is cheaper but beam scales are more accurate and robust. Beam scales are also suitable for weighing babies and children (weigh babies in health worker's or mother's arms). Bathroom scales are not accurate enough for children and babies. Weigh adults and older children without shoes and remove headgear before measuring height. Weigh young children without clothes and shoes or wearing light clothing only.
	<b>Infant scale</b> 	Portable, spring, Salter, hanging type, capacity 25kg, markings 500g with 100g graduations supplied with trousers and slings  Spare: slings and trousers  <i>AND/OR</i> Metric, double beam (sliding scale), weighing range 0-16kg x 10g, shallow tray, table top model (basin type)	At least 2 (1 for clinic use, 1 for outreach) or 1 of each type	Infant beam balance scales (basin scales) are only suitable for babies. Hanging scales are compact, small, easy to transport and read, and can be used for children up to age 5 (with appropriate receptacles). Also available as 50kg with 200g graduations. Weigh a child without clothes and shoes or wearing light clothing only.  All scales must be checked for accuracy, calibrated daily with standard weights (check against a known weight e.g. 5kg – if the measure does not match the weight scale, recalibrate or discard) and adjusted to read zero before each weighing.



Procedure	Item	Specification	No. required	Remarks
<b>Examining the mouth and throat</b>	<b>Tongue depressor</b> (spatula)	SS (reusable) or wooden (disposable) Adult: approx. 17cm Child: approx. 4cm	Reusable: At least 1 for each health worker carrying out consultations Disposable: pack of 100	Use 1 disposable depressor per patient. If you use disposables, ensure you have a back-up supply of 1 or 2 reusables in case of supply problems.
<b>Auscultation of the chest</b>	<b>Stethoscope</b>	Dual head, see p71	At least 1 for each health worker carrying out consultations	Dual head stethoscopes should be used primarily for auscultation and diagnosis.
<i>Examination of eyes (internal and external)</i>	 <i>Ophthalmoscope</i>	<i>Handle with 2 x R6 batteries, head with halogen bulb 2.5V, in protective case</i>  <i>Spare: bulbs halogen 2.5V and batteries 1.5V, type AA</i>	<i>At least 1</i>	<i>For detailed examination of eyes. Make sure switched off at the end of each day and stored in protective case. Remove batteries, if not being used for a while. Alternative is basic diagnostic "Oto-Ophthalmoscope set" in which the handle is suitable for both ophthalmoscope and auriscope heads. Suitable only for staff trained in use. Hand held torch can be used instead.</i>
<i>Examination of ears</i>	 <i>Auriscope (otoscope)</i>	<i>Handle with 2 x R6 batteries, head with halogen bulb 2.5V, plastic or chrome, sterilisable set of 3–5 different size (2.5–5) earpieces (speculae), protective case</i>  <i>Spare: bulbs halogen 2.5V and batteries 1.5V, type AA</i>	<i>At least 1</i>	<i>Check speculae fit firmly. Disinfect earpieces after each use and check for cracks. Make sure switched off at the end of the day and stored in protective case. Remove batteries if not being used for a while. Alternatively use 'diagnostic set' described above.</i>
<i>Diagnosing meningitis</i>	<i>Spinal needles (lumbar puncture needles)</i>	<i>Needle and stylet, disposable, sterile, colour-coded connections, SS with plastic hub, size 20G (yellow) and 22G (black), each needle individually wrapped</i>	<i>25 of each size</i>	<i>For lumbar puncture. This procedure must only be carried out by staff trained to do this.</i>

**Sphygmomanometer - aneroid**

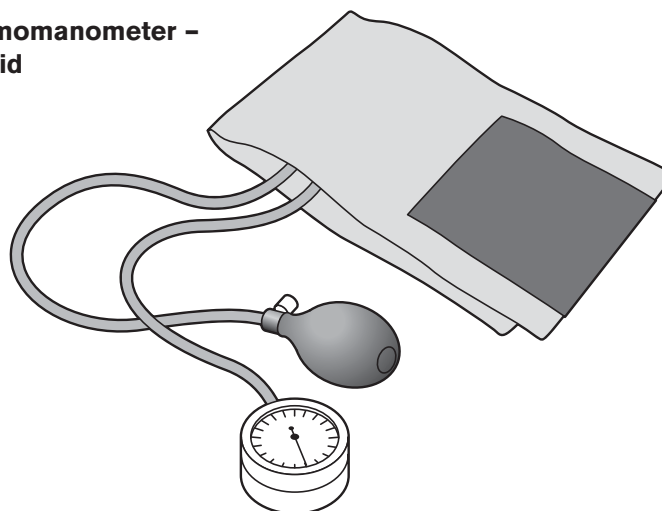

**Sphygmomanometer - mercury**

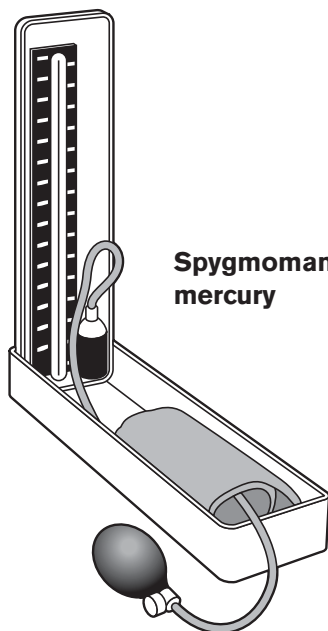

**Stethoscope - single head**



**Stethoscope - dual head**

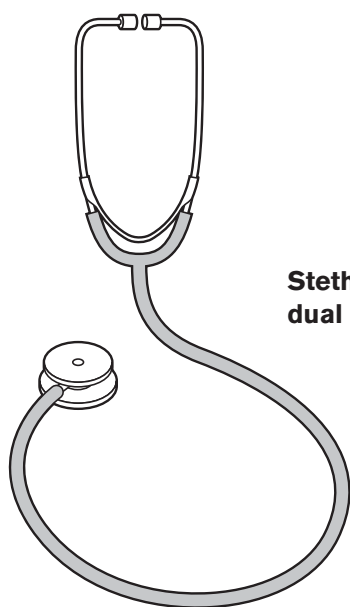

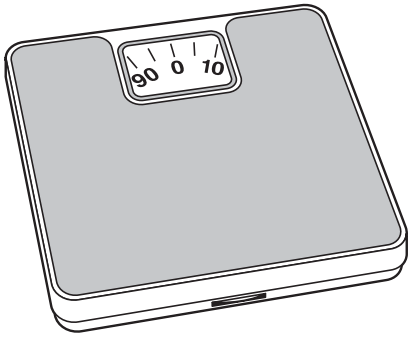

**Adult scale -  
bathroom**

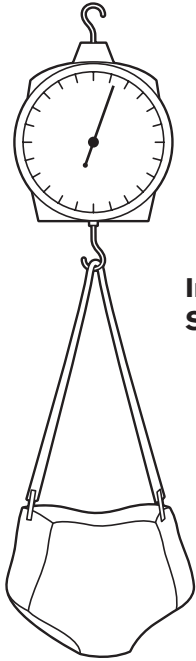

**Infant scale -  
Salter**

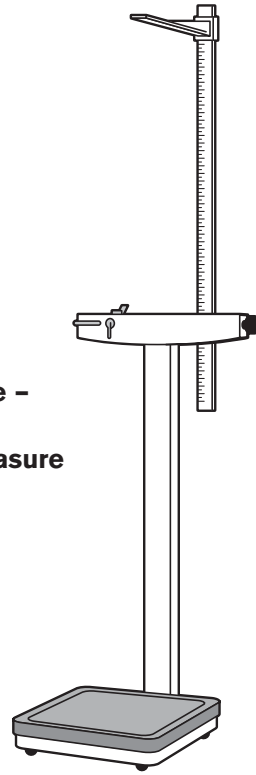

**Adult scale -  
beam with  
height measure**

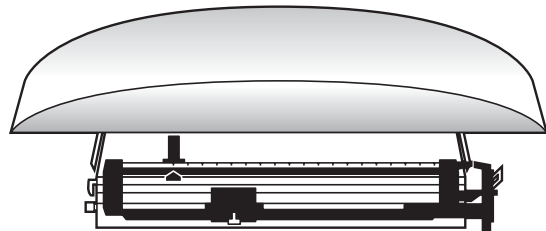

**Infant scale - beam**

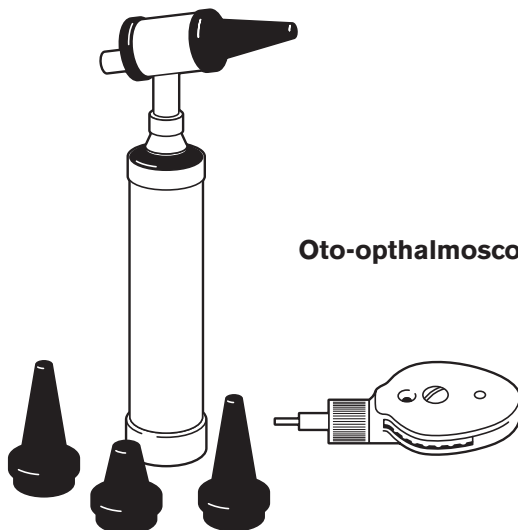

**Oto-ophthalmoscope**

## General patient treatment and care

Procedure	Item	Specification	No. required	Remarks
<b>Making and giving oral rehydration solution (ORS) or sugar-salt solution (SSS)</b>	<b>ORS spoon</b>	Double ended sugar and salt measuring spoon	At least 6 for clinic use and 4 for mobile team	Measuring devices can be bought or made. Local measuring containers that are widely known, easily available and of standard sizes may be used for making SSS and ORS, e.g. 5ml teaspoon, coke bottle. Alternatively, use pre-packaged ORS (WHO standard), which is quick and easy to make up accurately. Use the correct amount of ORS or sugar and salt and clean water for making ORS or SSS. Follow national/WHO guidelines for treating with ORS.
	<b>Container for measuring 1l of water</b>	250ml cup, 0.5l bottle, 1l bottle or jug	At least 6 for clinic use and 4 for mobile team	
<b>Dispensing medicines</b>	<b>Tablet counter</b> (counting tray)	Plastic, SS, aluminium or wood, triangular tray, each side approx. length 19cm	At least 1	<p>Simple device for counting 'round tablets' by counting the no. of rows. To use, fill the number of rows nearest to the total required, then add or take away the balance. If you need 20 tablets, for example, fill to row 6 (21 tablets) and take away 1 tablet.</p> <p>Rows: 4 5 6 7 ...12 13 Tablets: 10 15 21 28 ...78 91</p> <p>Metal or plastic trays are preferable as they can be easily cleaned or washed. Counting loose tablets and capsules by hand is not good practice, is not hygienic and cross-contamination is possible. If a tray is not available use a clean piece of paper, lid or smooth surface and clean knife to count. Clean the surface between counting different drugs, so one drug does not contaminate another. Capsule counters, similar to tablet counters, are also available.</p>

Procedure	Item	Specification	No. required	Remarks
<b>Dispensing medicines</b> (continued)	<b>Medicine spoon</b>	5ml plastic or SS	At least 12	Sizes of teaspoon vary from 3-5ml. Only use 5ml teaspoons and check that patients understand what a 5ml teaspoon looks like. The size will make a significant difference to the amount of medicine given to a child. If you have no choice but to use a bottle cap to measure liquid drugs, measure the cap to see how much it holds and advise patients or parents accordingly.
	<b>Measuring cylinder</b>	100mls, 200mls, glass or plastic, graduated, reusable	1 of each size	To measure amount of liquid drugs accurately, use the measuring cylinder size nearest to the amount needed, e.g. if you need 25ml use a 50ml cylinder rather than 100ml.
	<b>Medicine measure</b>	30-50ml, plastic or SS, graduated, sterilisable	At least 4	For accurate measuring/dispensing/administration of liquid drugs.
	<b>Tablet envelopes</b> (dispensing bags)	Plastic, markable with ballpen, self-sealing (mini-grip), size approx. 6 x 8cm, 1000 per pack	At least 2 packs	Pack drugs into clean, dry containers, e.g. plastic or paper tablet bags, cardboard boxes or plastic or glass bottles. Self-sealing bags can be opened and re-sealed as required. Plastic bags keep drugs clean and moisture proof. Paper envelopes do not protect against moisture.
	<b>Bottles for dispensing liquid medicines</b>	Sizes 50ml-100ml, plastic or glass, with tight fitting caps/tops	At least 100 (of various sizes)	Dispensing using a piece of screwed up paper or dirty bottles is not good practice. Wash and re-use old medicine bottles (remember to remove old labels). Do not use bottles with loose tops or chipped/cracked necks. Ask patients to return bottles after use. Label all containers with patient's name, drug name, dose and frequency, even if the patient cannot read. Adapt labelling to patient literacy level, e.g. using symbols for times of day. Clear labelling helps prevent misuse and accidents.



Procedure	Item	Specification	No. required	Remarks
<b>Dispensing medicines</b> (continued)	<b>Box for pre-packed medicines</b>	Wooden or cardboard, with sections	At least 2, (1 for clinic and 1 for outreach)	Locally made box for holding and dispensing. Pre-packaging of the most commonly prescribed drugs has many advantages including quicker, easier and safer distribution. Decide how many pre-packs to prepare each day, based on average no. dispensed. Do not prepare too many as drugs can only be kept pre-packed for a few days.
	<b>Prescription pads</b> (or forms)	Notepad, plain, A6	At least 1 per prescriber	Used to provide prescribing instructions to the dispensing assistant. Alternatively, use exercise book or OPD card.
	<b>Dispensary register</b>	A4 hardback book, lined	At least 2, (1 for clinic and 1 for outreach)	For registration of drugs dispensed. Write the date, list the drugs in columns or rows, record quantities of each drug given to each patient. At the end of each day, calculate the total consumption, e.g. Acet. Sal Acid 300mg Tally: 3+6+6+9+3 Total: 27 Chloroquine 150mg Tally: 6+14+14+6 Total: 40
<b>Nasogastric feeding</b> (tube feeding)	<b>Feeding tubes</b> (nasogastric tubes (NGT), gastric tubes, ryles tubes)	Feeding tubes, PVC (Poly Vinyl Chloride plastic), approx. 50cm, rounded, 2 eyes, luer tip with stopper, disposable, sterile, size: CH6, 8, 10	At least CH6 x 20 tubes CH8 x 50 tubes CH10 x 50 tubes CH16 x 20 tubes	General recommendations: CH6-8 for infants and children, CH 8-20 for older children to adults. Should only be used by trained staff.  'Feeding tubes' suitable for NGT feeding using luer tip syringe.  'Feeding/ aspirating tubes' particularly suitable for NGT feeding in adults and older children and for gastric aspiration. Used with syringe with conical tip.
		<i>AND</i> Feeding/aspirating tubes, PVC, approx. 125cm, 4 side eyes, conical tip (nozzle), graduated, disposable, sterile, size: CH6, 8, 16		
	<b>Syringe for tube feeding</b>	Syringe, disposable, conical connector, 60ml	At least 20	For tube feeding, 20ml syringes may be used instead.  Always record carefully the amount of fluid and feed given.



Procedure	Item	Specification	No. required	Remarks
<b>Giving general injections</b> (curative)	<b>Needles</b>	<p>Disposable, SS, luer, sterile, plastic wrapping, 100 per box, sizes: 19G (white), 21G (green), 25G (orange)</p> <p><i>AND/OR</i></p> <p>Reusable, SS, luer, sterilisable, non-sterile, pack size 6, 12 or 24 per box, sizes: 19G, 21G, 23G, 26G</p>	<p>Disposable: 1 needle for each injection. At least 19G x 10 box 21G x 20 box 25G x 1 box</p> <p>Reusable: At least 19G x 1 box of 12 21G x 1 box of 12 23G x 1 box of 12 26G x 1 box of 12</p>	<p>Every injection should be given using a sterile syringe and sterile needle. There are health risks from cross infection if either the syringe or needle or both are re-used without proper sterilisation. Single use disposables are packed and sterilised by the manufacturer, reusables are not and must be sterilised before the first use, and after every use.</p> <p>There are 2 types of disposable syringes: standard (conventional) and autodisable (see section on child health, p96). Disposable needles and syringes are available as 'syringe with needle' or as single unit needle and syringe.</p> <p>When ordering syringes with fixed needles make sure you specify the combinations you need, e.g. 2ml syringe with 23G or 21G needle.</p> <p>Disposables may be paper or plastic wrapped (plastic protects against high humidity). If the sterile package (paper or plastic) is wet or torn, do not use the syringe or needle.</p> <p>If using disposable needles and syringes, keep a back-up stock of reusables in case of supply problems.</p> <p>If using reusables, ensure staff have been trained in sterilisation procedures.</p> <p>For information about sterilising and disposal of syringes and needles, see Section 2.4 and 2.5.</p> <p>Disposable needles and syringes, made from less durable plastic than reusable are damaged by the high temperatures and therefore cannot be effectively sterilised.</p>
	<b>Syringes</b>	<p>Disposable, luer, sterile, fixed with/ without needle, plastic wrapping, 100 per box, sizes: 2, 5 or 10ml (Disposable syringe with fixed needles commonly available as: syringe with needle 2ml 23G and 21G 5ml 22G and 21G 10ml 21G 20ml 21G Each combination is available in boxes of 100)</p> <p><i>AND/OR</i></p> <p>Reusable, sterilisable plastic or glass, luer, non-sterile, sizes: 2, 5 or 10ml</p>	<p>Disposable: 1 syringe for each injection. At least 2ml x 4 box 5ml x 5 box 10ml x 2 box</p> <p>Reusable: at least 2ml x 20 5ml x 100 10ml x 40</p>	

Procedure	Item	Specification	No. required	Remarks
<b>Giving general injections</b> (continued)	<i>File</i>	<i>SS, 50mm, pack of 50</i>	<i>At least 1 pack</i>	<i>Metal file to open ampoules, which are not 'pop open' ampoules. Protect your fingers with a clean gauze square when opening the ampoule with metal file.</i>
	<i>Needle sharpening stone</i>	<i>Sharpening stone, white, approx. 70 x 25 x 7mm</i>	<i>At least 1</i>	<i>Sharpening of needles is possible but rarely done well. Only use if local policy permits sharpening of reusable needles. Common practice is to use sterilisable syringe with sterile disposable needle for each injection.</i>
	<i>Swabs alcohol (pre-injection swabs/wipes)</i>	<i>Isopropyl alcohol (60-70%) impregnated, 3 x 3cm, individually wrapped, pack of 100</i>	<i>At least 1 pack</i>	<i>Also available as ethanol (70%) impregnated swabs. If using alcohol swabs, the skin should be wiped thoroughly and allowed to dry before the injection is given. Alternatively use cotton swabs soaked in alcohol or boiled water. It is questionable whether pre-disinfection of skin is necessary before injection.</i>
	Additional items:		For each healthworker giving injections. At least	
	<b>Dressing tray</b>	30 x 20 x 3cm, see p117	1	Additional supplies needed for giving injections.
	<b>Kidney dish</b>	see p117	1	Sterilisation equipment needed for sterilising reusable syringes and needles.
	<b>Gallipot</b>	see p118	2	
<b>Cotton wool roll</b>	see p115	1		
<b>Drum</b>	see p118	1		
<b>Bottle</b>	100mls, see p118	1		
<b>Dressing scissors</b>	see p118	1		
<b>Nailbrush</b>	see p64	1		
<b>Steriliser – general purpose and sterilisation equipment</b>	see p87	1 set		
<b>Ear care</b>	<b>Ear syringe</b>  (aural, irrigating syringe)	Syringe, metal, with ear and catheter tips and shield, 2 finger rings on barrel and thumb ring on plunger, approx. 90mls (3oz)  OR Syringe, bulb, red, rubber, approx. 45-160ml, conical tip	At least 1	To remove wax, discharge or foreign bodies from the ear. Use with boiled lukewarm water (to prevent reflex vomiting). Bulb syringes are also commonly known as 'rat tail'.



Procedure	Item	Specification	No. required	Remarks
<b>Collecting sharps waste and minimising risk of accidental injury</b>	<b>Safety boxes</b> (sharps boxes, disposal boxes, sharps collector)	5l (holds 100-140 x 0.5ml syringe + needle), carton/board, puncture proof, leak proof, diameter of syringe insert hole 35-36mm, directions for use printed on box, with or without handles, flatpacked	At least 1 box per room where injections are given and 2 per mobile team	Safety boxes are special containers for collection of sharps waste including used syringes and needles, scalpel blades etc. A handle allows the box to be carried with one hand. Boxes are flat packed for ease of storage and transport. Keep container as close as possible to place where sharps waste produced. Before disposal and destruction, safety boxes should be closed and sealed (see Section 2.5). Alternatives sharps boxes include:- i. Safety box and incineration container for collection and disposal, burning by self-contained means of ignition. ii. Sharps collectors, disposable, rigid type plastic, available in range of styles and sizes with non-reopenable lids. Plastic containers should not be re-used for collection.
	OR <b>Puncture resistant sealable container</b>	Plastic container (e.g. empty drug pot) with close fitting lid with a small hole or triangle cut into it, puncture proof, sealable, labellable	At least 1 per room where injections are given and 2 per mobile team	Puncture proof means that needles cannot penetrate the container walls. Puncture proof containers are local and cheap (see Section 2.5)
	OR <b>Needle destroyer</b>	Needlyzer, battery operated, destroys 16-30G needles, battery capacity 150 needles, diameter syringe insert hole 5-22mm, cartridge (holds 3000-5000 needles, depending on size), portable, 12V rechargeable battery Accessories: battery charger, 110 VAC 60HZ Spare: cartridges	At least 2 (1 for health unit and 1 for mobile team)	Needlyzer destroys the needle all the way to the hub (metal or plastic) and totally eliminates the sharp (see Section 2.5). The needle is destroyed by being oxidised whilst still attached to the syringe.

Procedure	Item	Specification	No. required	Remarks
<b>Collecting sharps waste</b> (continued)	<b>OR</b> <b>Needle and syringe destructor</b>	Balcan, manual, SS, internal guillotine mechanism for chopping, destroys 18G-27G needles, diameter syringe insert hole 9mm, portable, 3 x 180ml debris pots Spare: debris pots	At least 2 (1 for health unit and 1 for mobile team)	Balcan destructor cuts the hub of the syringe whilst chopping the needle into several pieces, making both syringe and needle unusable. Alternatively, a simple lock mechanism allows needles to be safely removed from sterilisable syringes, and destroyed, leaving intact the sterilisable syringe. Each 180ml pot holds up to 250 chopped needles. Destructor is a simple and robust device requiring no batteries or other power sources (see Section 2.5)
	<b>IV infusion set</b>  (giving set, IV administration set, solution set, transfusion set)	Plastic perforator with cap, minimum tube length 150cm, filter, roller clamp, PVC drip chamber, latex injection connection with luer lock, sterile, disposable, plastic/paper wrapping, supplied with or without needle	At least 300	Suitable for use with infusion bags or bottles. Not suitable where precise drips rates are required. Roller clamp controls the flow, which is measured by counting drops. Standard set will dispense 20 drops per ml of clear fluid. Check that the number of drops per ml is listed on the outer packaging. Solution sets available as standard or economy sets.
	<b>Cannula</b>  (IV placement unit, catheter)	Cannula, trocar, sheath and hub, sterile, disposable, non-winged, individual paper and/or plastic wrapping, colour coded by size: 18G (green), 22G (blue), 24G (yellow), 25 or 50 per pack	At least 18G x 1 pack of 25 22G x 1 pack of 25 25G x 1 pack of 25	Cannula for prolonged intravenous infusion. Also available as winged with or without injection port.
<b>Scalp vein set</b>  (scalp vein infusion set/needles, butterflies)	SS needle, flexible PVC wing, tubing and cap (tubing and cap approx. 10-30cm in length), sterile, disposable, individual paper and/or plastic wrapping, colour coded by size: 21G (green), 25G (orange), 100 per pack	At least 21G x 1 pack 25G x 3 pack	Scalp vein sets for short term and bolus IV infusion. Soft wings for comfort and easy tape down.	

Procedure	Item	Specification	No. required	Remarks
<b>Catheterisation of patients having difficulty passing urine</b>	<b>Urine catheter</b> (urethral, urinary catheter)	 <p>Silicone coated latex, Foley, 2-way, valve for luer connection, length approx. 30-40 cm, balloon (standard size 10mls), rounded end, 2 side eyes (holes), sterile, disposable Adult: CH12, CH14, CH18 Child: CH8, CH10</p>	At least CH 8 or 10 x 5 CH12 x 10 CH14 x 5 CH18 x 5	Catheter 2-way (2 channels), central channel for urine drainage and side channel for inflating balloon with a valve for luer tip and/or luer lock syringe tips. Catheters with balloon (self-retaining catheters) can be left in the patient to continuously drain the bladder. Use sterile water to fill the balloon. Only catheterise if trained in this procedure.
		<p>OR</p> <p>Reusable, Nelaton, soft rubber, 1-2 eyes, available size: CH8-18, approx. 40cm length</p>	At least CH8 or 10 x 2 CH14 x 2 CH18 x 2 CH12 x 4	Reusable catheters do not have a balloon, so cannot be left in the patient to continuously drain urine. Must be sterilised before use. Soft rubber is highly resistant to kinking, has high degree of flexibility and can be sterilised.
	<b>Urine drainage bag</b> (urine collecting bag)	Plastic bag, 2000ml capacity, graduated in 100ml, with holes for suspending bag, connector, tubing approx. 90cm with a protective cap, non-return valve, bottom outlet with draining/emptying tap or push/pull outlet protected by a cap, available as sterile or non-sterile	At least 10	Bags with taps or push/pull mechanisms are recommended as they can be drained rather than having to be replaced when full. Alternative catheters include: leg bags, capacity 500–750ml, connector, non-return valves and drain tap with fastening straps made of latex.
	<b>Urine drainage bag holder</b>	Wire plastic coated holder, bedside or floor standing	At least 2	To keep catheter bags off the floor. Can be made locally.
	<b>Catheter spigot</b> (connector, plug)	 <p>Plastic, blunt nosed, 1 size fits CH7-30, available as sterile or non-sterile</p>	At least 5	Used to plug catheters when not using drainage bag. Suitable for all standard catheters.

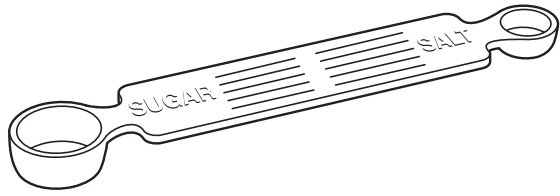

**ORS spoon**

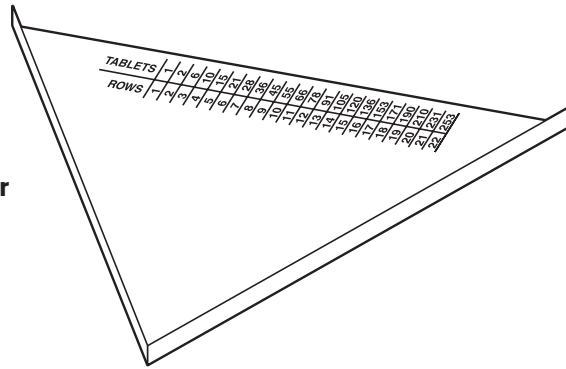

**Tablet counter**

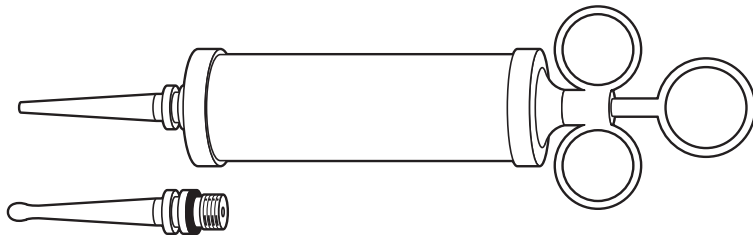

**Ear syringe - metal**

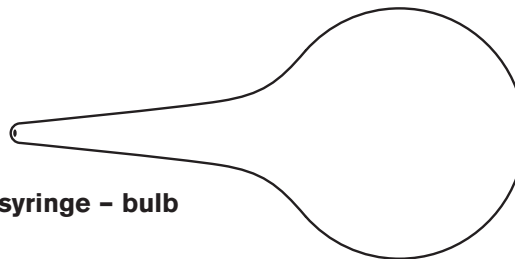

**Ear syringe - bulb**

**Feeding tube - luer tip with stopper**

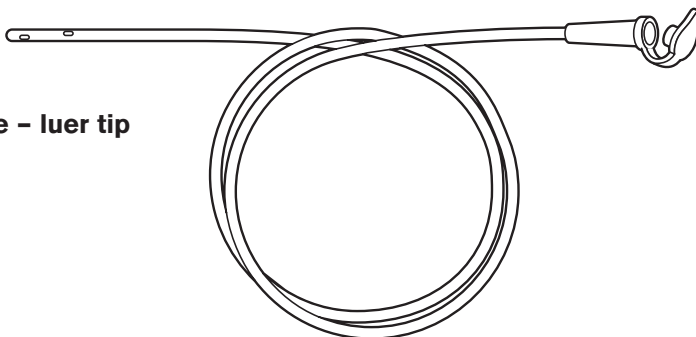

**Feeding tube - conical tip**

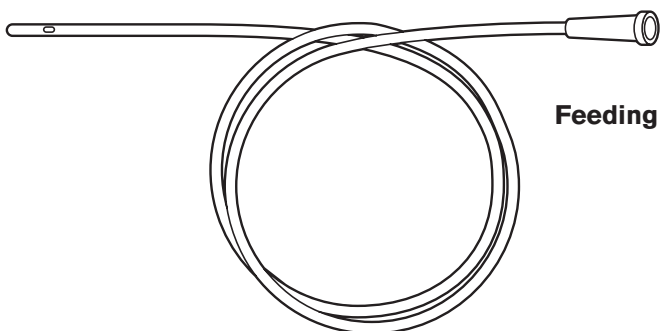

**Cannula - non winged**



**Infusion set with needle**

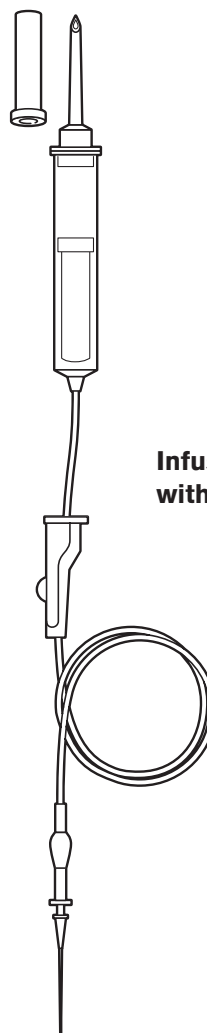

**Scalp vein set**

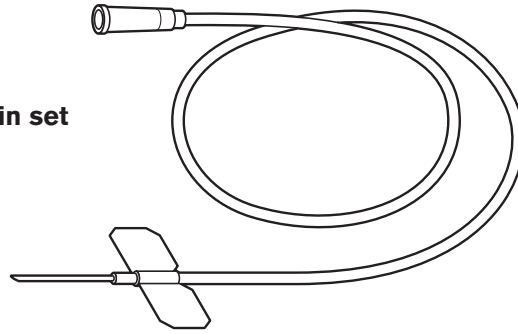

**Urine catheter - disposable**

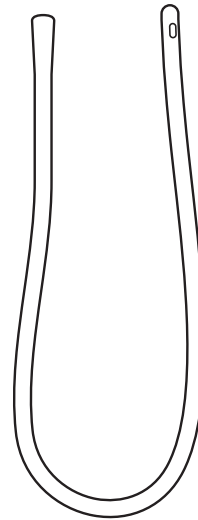







**Urine catheter - reusable**



**Catheter spigot**



Item	Specification	No. required	Remarks
<p><i>AND/OR</i></p> <p><b>Steriliser drum with needle and syringe rack</b> </p>	<p>Steriliser drum, SS, with vents, lid with clip lock and a carrying handle, forceps position in lid, syringe rack (Single rack holds approx. 42 x 0.05/0.5ml syringes, 2 x 5ml and 50 needles. Double drum holds approx. 84 x 0.05/5ml syringes, 4 x 5ml and 104 needles). Single drum approx. 18.5 x 12.5cm, double drum approx. 18.5 x 22.5cm</p>	At least 1	<p>Sterilising drums with racks can be used instead of racks. A 12l steriliser will take 1 or 2 standard drums. Sterilising drums are metal drums with holes (vents) by a shutter that can be opened and closed with a metal band. Before sterilisation, the vents are opened and the drum is put into the steriliser. Open air vents allow steam to circulate freely during sterilisation. After sterilisation, the drum is taken out, and the drum is sealed by closing the vents. Drums allow more flexible working practice, e.g. after sterilisation the sealed drum and its sterile contents can be carried to where the equipment will be used without the steriliser.</p> <p>Steriliser drums to hold other syringes/needles and/or specialised equipment are also available.</p>
<p><b>General purpose tray</b> </p> <p><i>AND/OR</i></p> <p><b>General purpose basket</b> (instrument container) </p> <p><i>AND</i></p> <p><b>Support</b> </p>	<p>Plastic tray, general purpose</p> <p>Plastic basket, with lifting handle</p> <p>V support, SS</p>	<p>At least 6 trays or 1 basket</p> <p>At least 1 per steriliser and 1 spare</p>	<p>Trays and baskets are used for sterilising instruments and reusable equipment, such as scissors, forceps, suture needles, suture threads and speculums. Tray fits on top of the basket (1 basket will fit into a 12l steriliser) <i>OR</i> trays can be stacked on top of each other in the steriliser (up to 6 trays can be stacked on top of each other in a 12l steriliser).</p> <p>V support is placed under the trays/ basket in the steriliser.</p>
<b>Lifter</b> 	Plastic lifter	At least 1 per steriliser	Used for easy removal of small instrument trays etc. Should be sterilised with each sterilisation.
<b>Forceps dissecting</b>	Forceps, dissecting, spring type, approx. 14-15.5cm, serrated round tips, SS	At least 2 per steriliser	Used for handling and assembling needles and syringes. 2 sterilised forceps are needed, if 1 is contaminated you still have 1 that is sterile. During sterilisation, forceps should be placed on the rack lid, positioned in the lid of the steriliser drum, or in the tray.
<b>Forceps steriliser</b> (serving forceps) 	Forceps steriliser, approx. 20-27cm, box joint, angled, SS, e.g. Cheatle, Vaughn	At least 2 per steriliser	Steriliser forceps are used for lifting hot sterilised instruments from the steriliser and also from boiler. Ideally avoid using these – if they are used, forceps should be sterilised daily and stored in fresh disinfectant solution between use.



Item	Specification	No. required	Remarks
<b>Jar forceps</b>	Plastic, sterilisable, approx. 114mm depth, tube diameter approx. 54mm, overall height approx. 132mm	At least 2	Holds steriliser (serving) forceps. Each jar should hold 1 forceps only. Can be sterilised. Also available in SS.
<b>Hard water pad</b>	Circular, stainless steel wire mesh, approx. diameter 20cm, thickness 1-3cm, individually wrapped	At least 1 per steriliser	Reduces build up of scale in sterilisers, by trapping hardwater deposits. In hard water areas, reusable syringe life is reduced by about a third, because salt deposits on the surface of the syringe barrel increases friction and reduces life of the piston seals. Alternatively use clean rainwater.
<b>Timer</b>	Mechanical timer with a bell, 60 min x 1 min, robust	At least 1	Used to time sterilisation cycles. Mechanical timers are particularly suitable for areas of high humidity or where batteries are difficult to obtain.
<b>Bowl</b>	Sterilisable plastic, approx. 400ml	At least 2 per steriliser	One for soaking and one for cleaning used syringes and instruments. Alternatively use kidney dishes.
<b>Needle containers</b>	SS or aluminium, box, with cover, round or square	At least 2 boxes	To hold needles if racks are unavailable. May require more than 1 box to hold different sizes of needles. Arrange needles so they all point in same direction.
<b>TST control strips</b> <i>OR</i> <b>TST spots</b>	Time Steam Temperature self adhesive strips, pack of 100  Self adhesive coloured spots, pack of 300 spot and 1 record sheet	At least 1 pack	TST is used to indicate successful sterilisation and should be included in each sterilisation load. TST strips or spots can be attached to a rack of syringes or steriliser drum, or placed in the centre of the load (where heat penetration is likely to be slowest). When the strip or spot is exposed to steam at 121°C which is free of air for 15 mins, a chemical reaction takes place and the strip or spot changes colour irreversibly from yellow to blue. This colour change will not occur if any of the essential criteria for sterilisation (time, steam, temperature) are not met.
<i>OR</i> <b>Autoclave tape</b> (sterilisation tape)	Adhesive paper tape with white lines, approx. 50m long x 2-5cm wide	At least 1 roll	The heat/moisture sensitive white lines change colour when the tape has been exposed to steam sterilisation process. This method is less reliable than TST and does not indicate whether all sterilisation conditions were met. The tape can be used as adhesive tape for packaging, or can be stuck on the load as a 'was sterilised' indicator. To prevent misuse, the tape should be clearly marked 'autoclave' on the inner surface of the roll.
<b>Instrument pin</b>	Safety pin forceps holder, SS, approx. 11.5-12.5cm	At least 2	To keep instruments in open position hang them on a 'mayo' safety pin.

Item	Specification	No. required	Remarks
<b>Disinfector</b> (boiler, sufuria, boiling pan)	Approx. size 41 x 25 x 10cm, SS, instrument boiler, seamless body, flat, overlapping cover (lid) with handle, perforated lift-out tray with straight turned up sides, resting on 4 studs and fitted with lifting handle, used with external heat source, e.g. primus stove, gas burner, electric plate, charcoal burner	At least 1	Used for boiling instruments and equipment. Boiling provides high level disinfection, but not sterilisation. If disinfectors are not available, use a saucepan or 'covered instrument tray' approx. 22 x 8 x 4cm, SS, with round corners, removable flat, overlapping lid with handle. Perforated tray for draining instruments and equipment dry after boiling. After each day's use, clean the disinfector. In hard water areas use rainwater to prevent corrosion, scaling and furring of the instruments and the disinfector. Do not boil items more than 24 hours before you need to use them. Disinfected items may become contaminated even if the pan is kept closed (see Section 2.4).
Plus: <b>Dressing tray</b> <b>Nailbrush</b> <b>Soap</b> <b>Soap dish</b>	see p117 see p64 see p66 see p68	At least 1 1 2 1	Additional supplies needed to carry out sterilisation and disinfection.

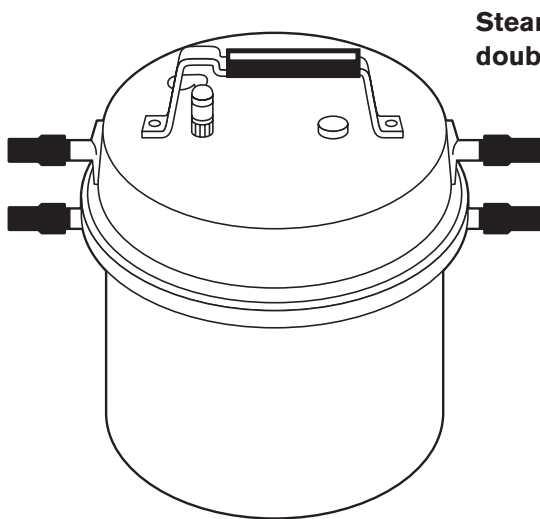

**Steam steriliser - double rack**

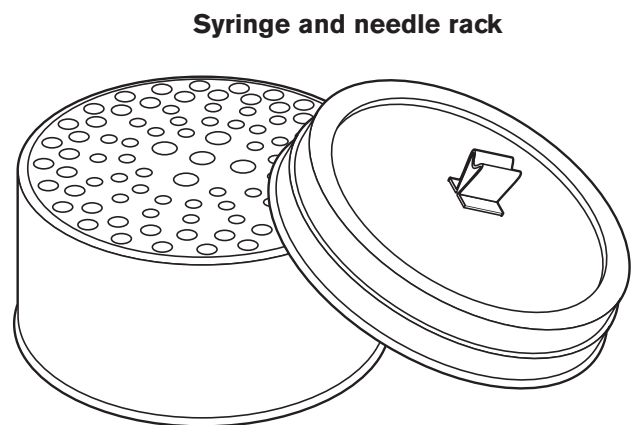

**Syringe and needle rack**

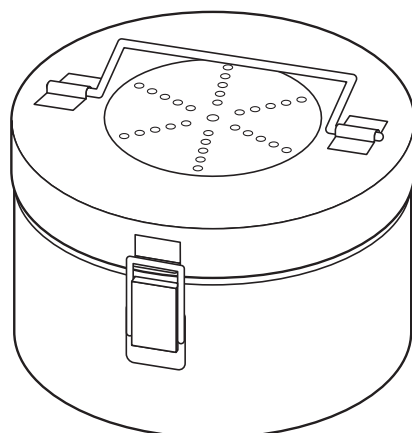

**Steriliser drum with syringe and needle rack**

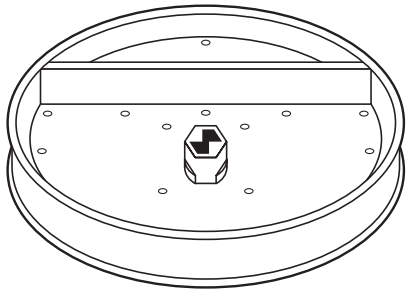

**General purpose tray**

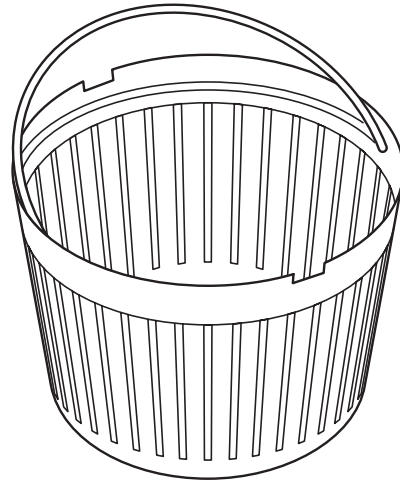

**General purpose basket**

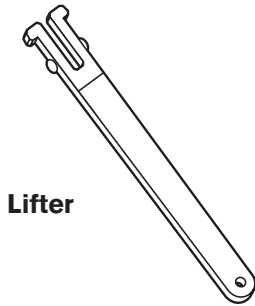

**Lifter**

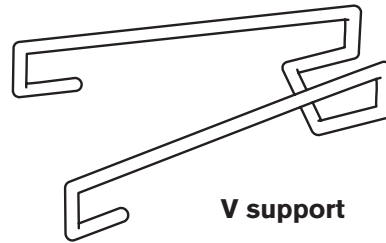

**V support**

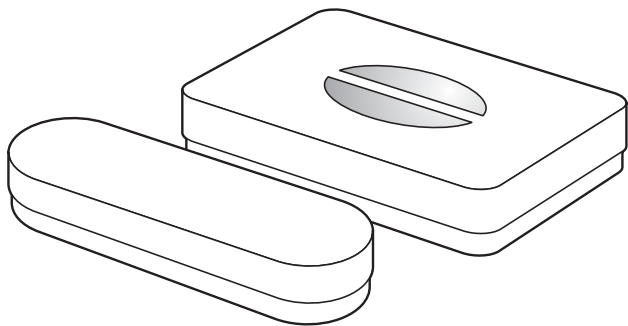

**Needle containers**

**Hard water pad**

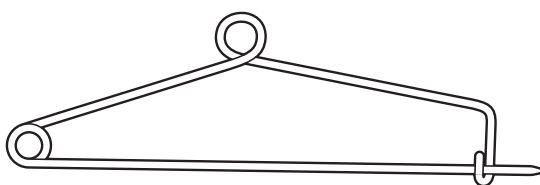
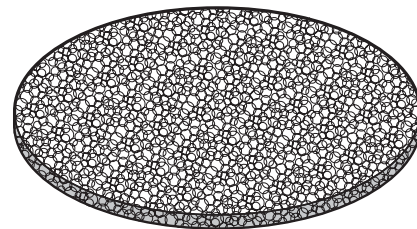

**Instrument pin**

**Forceps steriliser -  
cheatle**

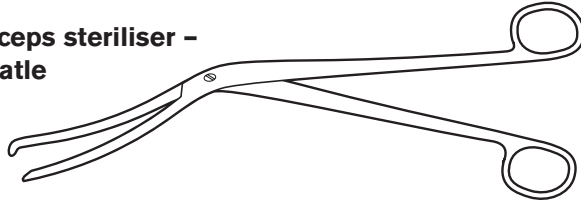

**Jar forceps**

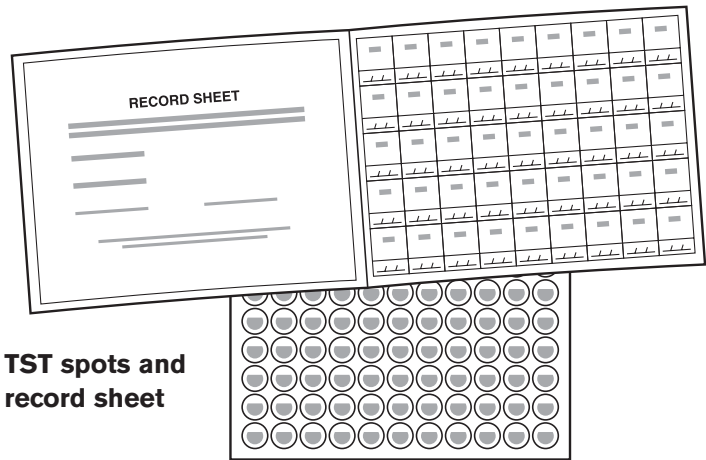

**TST spots and  
record sheet**

**Autoclave tape**

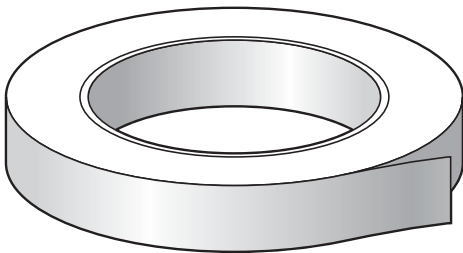

**Disinfector**

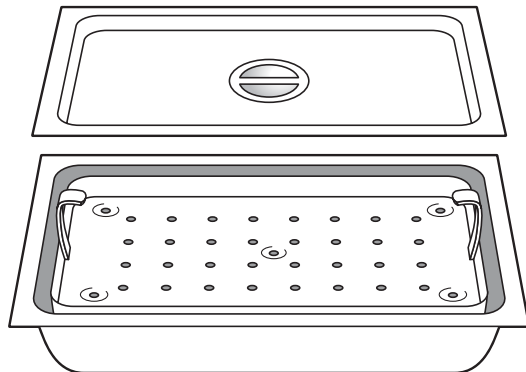



## 3.2 Supplies and equipment for primary health care activities

This sub-section describes the supplies and equipment required for core primary health care services, including: preventive child health; reproductive and sexual health; dressings, minor surgery and first aid; eye care; and health education and promotion.

### Preventive child health

The following list focuses on the supplies and equipment required for two key aspects of preventive child health, immunisation and growth monitoring.

Procedure	Item	Specification	No. required	Remarks
<b>Growth monitoring</b>	Weight measures: <b>Infant weighing scales</b>	Hanging (with sling and trousers) or beam balance, see p72	At least 2 (1 for clinic and 1 for outreach)	Growth monitoring is a useful tool, if it is part of an overall assessment of whether the child is thriving. The child should be weighed on every visit, whether for a routine check or because of illness. Weighing should be accurate as possible, scales should be calibrated daily with standard weights and adjusted to zero before use. Weigh the child without clothes and shoes or with light clothing only. Weight-for-age is probably the most useful tool for long term growth monitoring. Another way to assess a child's nutritional status is to measure the height and weight, and look up the weight-for-height on a chart.
	Height measures:  <b>Infant/child height measuring board</b> (standing up or lying down [length])	Wooden board, height 130cm (collapse to 75cm), width 30cm, free standing, portable, supplied with strap, sliding head-board and illustrated instructions for assembly and use	At least 2 (1 for clinic and 1 for outreach)	Could be made locally using strong but light wood and measuring tape. Measure children up to 2 years (height < or equal to 85cm) lying down, and children over 2 years (height > 85cm) standing up. Children < 65cm are

Procedure	Item	Specification	No. required	Remarks
Growth monitoring (continued)	OR <b>Weight-for-height chart</b> 	Wall mounted growth chart, heavy-duty plastic paper, with 3 coloured, curved bands (green = normal, yellow = moderately malnourished, red = malnourished), bottom axis weight in kg, side axis height in cm, e.g. TALC	At least 2	Used to monitor growth of children aged over 1 year and able to stand. Could be made locally. The health worker weighs the child and then stands the child against the column marked with their weight. The colour at the top of the head indicates the nutritional status. The coloured band indicates the child's weight for height.
	OR <b>Height measure rod</b>	Wall mounted height measure, with sliding arm hinged to fall back to the wall when not in use, approx. range 70-205cm with 5mm graduations	At least 2	Alternative height measures include TALC stadiometer/ infantometer. This is a red plastic headpiece, which slides up and down against a height measuring scale. The scale is printed on strong paper resistant to wear and tear. It can be adapted to measure the length of children under 2 years of age.
	OR <b>Length measure</b>	Length measuring mat, range 0-100cm, lightweight, non-stretch plastic foam with rigid plastic head board, supplied with plastic bag for storage/transport	At least 2	Used to monitor growth from birth to 3 years. For measuring (lying down) length only. Rolls up for easy carrying/storage. Could be made locally.
	Arm measures: <b>Mid upper arm circumference (MUAC) strip</b>  (MUAC measures, arm circumference strip, insertion tape)	PVC paper, flexible, tear resistant, non-stretch, washable, available as plain printed with mm scale or colour coded in red/orange/ yellow/green	At least 6 per health unit and 1 per community worker	Although a simple and fast method, MUAC is not as accurate as weighing and measuring a child. However, can be a useful way of checking if children aged 6 months-5 years (65-109.5cm if age unknown) are malnourished and to refer for further care. Useful tool for carrying out rapid evaluation, nutritional surveys and screening. MUAC is measured on the left arm, at the midpoint between the elbow and shoulder. The band must be threaded into itself and measurement read directly from the window of the tape. Plain tapes can be coloured to make them easier to use.

Procedure	Item	Specification	No. required	Remarks
Growth monitoring (continued)	MUAC strips			Multicoloured strips are particularly suitable for use by health workers with limited training and low literacy levels. To measure MUAC, you can also use tape measure or make your own MUAC strip from old X-ray film or strong thin card. MUAC strips are more accurate than an ordinary tape measure when measuring circumference.
	Child health (record) cards	National or WHO growth charts Road to Health or Weight for Height, made from strong card or non-tearing plastic paper, each with plastic envelope	1 per child under 5 years	Child health card combining personal growth record with indicators of development, family details, record of illness and treatment, immunisation record. Health workers should explain to parents how to use and understand the cards. Home-based cards offer greater continuity of care. Plastic envelope keeps the card clean and readable. Card should be strong enough to withstand frequent use.
Immunisation	BCG: Syringe with needle  OR Syringe with needle  AND/OR Syringe  AND Needle	Autodisable (AD) 0.05ml, fixed needle 27G, sterile  Disposable, luer 0.05ml or 0.1ml with fixed 26G (brown) or 27G (grey) needle or without needle  Reusable, luer 0.05 ml or 0.1ml, sterilisable, pack of 10  Reusable (intradermal), 26G (10mm), SS, luer, sterilisable, 15° bevel, SS, pack of 12	1 x 0.05ml AD syringe + 27G needle per vaccination  1 x 0.05ml or 0.1ml disposable syringe and 26G or 27G needle per vaccination  At least 1 pack of 0.05ml or 0.1ml  At least 2 packs of sterilisable needles 26G	Use a sterile syringe and sterile needle for each injection. There are health risks from cross infection, if either the syringe or needle or both are re-used without proper sterilisation. There are 2 types of single use syringes and needles: disposable (conventional/standard) and autodisable (AD or autodestruct). AD is a specially modified disposable syringe with fixed needle designed so that it is impossible to be used more than once. WHO/Unicef recommends AD syringes as the syringe of choice for immunisation. However, these are not always readily available. You can buy standard disposable syringes and needles either as separate sterile individual units or sterile syringe with fixed needle.



Procedure	Item	Specification	No. required	Remarks
<b>Immunisation</b> (continued)	All other EPI vaccines: <b>Syringe with needle</b>	Autodisable (AD), 0.5ml, fixed needle 23G, sterile	1 x 0.5ml AD syringe + 23G needle per vaccination	Disposable syringe and needles are available as paper or plastic wrapped. Plastic protects against humidity. If the sterile packaging is wet or torn, do not use the syringes or needles. Never re-use disposables, they cannot be sterilised properly as they are made from less durable plastic than reusables and are damaged by the high sterilisation temperature. Reusable syringes and needles are not supplied sterile, they must be sterilised before they are first used and after every use. Reusable needles and syringes are not suitable for emergency vaccination campaigns. Disposables: For each immunisation schedule (birth to 1 year), you need 6 disposable syringes + needles (5 injections for infant and 1 injection for mother). Also keep enough for at least 1 month of immunisation activities as a reserve stock. Keep a back-up supply of reusable equipment, in case of supply problems. Reusables: The minimum number you need is the maximum number who attend any immunisation clinic and extra necessary to cover accidental contamination and breakage. If you have fewer syringes and needles than required, you will need to sterilise during the session, which can be difficult and result in people waiting. Keep the equivalent of 10% more than the largest number of injections given in a single session as a reserve stock. For information about sterilising and disposal of syringes and needles, see Sections 2.4 and 2.5.
	<i>OR</i> <b>Syringe</b>	Disposable (standard), luer, 0.5ml or 1ml, sterile, plastic wrapped, box of 100	1 x 0.5ml disposable syringe per vaccination	
	<i>AND</i> <b>Needle</b>	Disposable, 23G (25mm), SS, luer, plastic wrapped, box of 100	1 x 23G disposable needle per vaccination	
	<i>AND/OR</i>			
	<b>Syringe</b>	Reusable, luer, 0.5ml or 1ml, sterilisable plastic or glass, pack of 10	At least 4 packs sterilisable syringe 0.5ml or 1ml	
	<i>AND</i> <b>Needle</b>	Reusable, 22G (32mm) and 23G (26mm), SS, luer, sterilisable, regular bevel, pack of 12	Sterilisable needles, at least 22G x 2 packs and 23G x 5 packs	
	Reconstituting (mixing) vaccines: <b>Syringe</b>	Disposable, luer, 5ml, sterile, 100 per box	1 x 5ml disposable syringe per vial needing reconstituting	
	<i>AND</i> <b>Needle</b>	Disposable 18G/19G, SS, luer	1 x 18G/19G disposable needle per vial needing reconstituting	
	<i>AND/OR</i>			
	<b>Syringe</b>	Reusable, luer, 5ml, sterilisable plastic or glass, pack of 10	At least 1 pack x 5ml sterilisable syringe	
<i>AND</i> <b>Needle</b>	Reusable 18G (76mm), SS, luer, sterilisable, regular bevel, pack of 12	At least 1 pack x sterilisable needle 18G		



Procedure	Item	Specification	No. required	Remarks
Immunisation (continued)	<b>Tally sheets</b>	Immunisation tally sheet	2 (1 for clinic and 1 for outreach)	Used to keep a summary record of each immunisation given, age groups and, at the end of the session, to count the number of immunisations. Tally sheets or immunisation registers are quicker and simpler to keep than detailed records. Use tally sheets and registers to prepare reports for your supervisor.
	<b>Immunisation register</b>	A4, hard back record, lined or pre-printed format	At least 1	
	<b>Bag</b>	Vinyl, approx. 35 x 20 x 22cm, top opening, lockable buckles, carrying handle, shoulder strap	At least 1 per outreach immunisation team	
	Additional supplies:		For each HW immunizing. At least	Additional items needed for immunisation:
	<b>Tray</b>	see p117	2	1 tray for mixing syringe, 1 for injection syringes
	<b>Gallipots</b>	see p118	2	Use 1 gallipot to hold dry swabs and 1 for wet swabs
	<b>Cotton wool roll</b>	see p115	1	Drum for storing cotton wool. Can use plastic container with a tight fitting lid instead of drums.
	<b>Drum</b>	see p118	1	Bottle for disinfectants.
	<b>Nail brush</b>	see p64	1	Sterilisation equipment for reusable syringes and needles
	<b>Bottle</b>	100 mls, see p118	1	
	<b>Scissors</b>	Dressing, see p118	1	
<b>Sterilisation equipment</b>	see p87	1		
<b>Sharps containers</b>	see p81	1		
<i>File</i>	<i>see p80</i>	<i>1</i>		
<i>Needle sharpening stone</i>	<i>see p80</i>	<i>1</i>	<i>Sharpening of reusable needles is possible, but rarely done satisfactorily. Only use if local policy permits.</i>	

Procedure	Item	Specification	No. required	Remarks
Cold chain	Refrigerator and freezer	Suitable for vaccine storage, 2 compartments (main storage and freezer), combined capacity approx. 100l-120l, with holdover time during power failure, lockable door, instruction manuals, spare parts list	At least 1	<p>The cold chain is a system that ensures the potency of a vaccine from time of manufacture to the time it is given. Current WHO/EPI recommendations for refrigerated storage of vaccines is 1 month at 0-8°C (some countries recommend between 2°C-4°C and 8°C). All vaccines are sensitive to excessive heat and cold. IPV, DPT, DT, TT and hepatitis B are irreversibly damaged by being frozen at temperatures below 0°C. Use the shake test to check if vaccine has been frozen. Polio, measles and BCG are especially sensitive to, and damaged by, heat and sunlight. The main storage compartment is used to keep vaccines cold and the freezer to make icepacks.</p> <p>Ideally, keep vaccines, diluents and icepacks in their own refrigerator, although it may be necessary to store items, such as heat-sensitive drugs, reagents or rapid tests in the refrigerator. Use vaccines on a First In and First Out (FIFO) basis. A range of cold chain refrigerators are available. Consider the following when deciding type to buy:</p> <ul style="list-style-type: none"> <li>• Power supply – if electricity is unavailable or unreliable, select absorption (combined) unit. If more than 8 hours of electricity in 24 hours select compression (electricity only) model.</li> <li>• Availability of spare parts and maintenance support.</li> <li>• Vaccine storage capacity – a refrigerator should hold at least 1 month's supply and 1-2 week's reserve stock of vaccines and diluents.</li> </ul> <p>Kerosene refrigerator – make sure you order the correct size of wick (the size is usually written on the side of the burner), burner and lamp glasses. See Section 2.3 for information on use + care.</p>
		Unreliable or no main power supply: Combined kerosene + electricity (230VAC/50Hz) (Absorption model)		
		OR Gas + electricity (Absorption model)		
		Stock and spares:		
		Kerosene/electricity refrigerator:	At least	
		Filter cloth	2	
		Wicks (cotton)	2	
		Burner	1	
		Lamp glasses	4 if glass or 1 if metal	
		Flue brush	1	
		Funnel	1	
		Wick trimmer (cotton wicks)	2	
		Door seal	1	
		Kerosene	1 can	
		Gas/electricity refrigerator:	At least	
Safety valve	1			
Thermocouple	1			
Gas jet	1			
Gas thermostat	1			
Gas cylinder	1			
Door seal	1			

Procedure	Item	Specification	No. required	Remarks
Cold chain (continued)	<b>Refrigerator and freezer</b>			Alternatively, consider solar refrigeration system for areas with unreliable and poor energy supply. Domestic refrigerators are unsuitable for vaccine storage unless they have been adapted. WHO/EPI have produced a simple modification kit to adapt domestic refrigerators (available from WHO).
	<b>Temperature record chart</b>	National or WHO record chart	1 per week	Used to record the refrigerator temperature twice a day (morning and evening). If you are taking out vaccines for the day, check the temperature at the same time. Helps to check that the temperature has remained between the correct range and that the refrigerator is working well.
	<b>STOP!Watch</b>	Refrigerator monitor card with 2 indicators: Strip 'monitor mark' which changes colour irreversibly if exposed to a temperature higher than + 10°C and + 34°C and a FreezeWatch vial which bursts at a temperature below 0°C, releasing coloured liquid which stains the white backing card	1 per refrigerator	To continuously monitor the range of refrigerator temperatures. Must be kept in the main refrigerator storage compartment and completed by the supervisor during each monthly supervision visit. Check and record expiry dates. All FreezeWatch vials should have an expiry date.
	<b>Thermometer</b>	Alcohol stem, plastic, range -40°C to +50°C  OR Bi-metal thermometer with non-corrosive casing, sealed mechanism, range -30°C to +50°C	At least 1  At least 1	Used for monitoring storage temperature, to ensure vaccines are not damaged by exposure to excessive heat or cold. Specify safe temperature range when ordering (e.g. 0-8°C). Both types are suitable for monitoring refrigerator storage temperature and storage temperature of vaccines during transport to health facilities. The bi-metal type can also be used when transporting vaccines to outreach immunisation sites.

Procedure	Item	Specification	No. required	Remarks
Cold chain (continued)	<b>Cold box</b>	Durable plastic box, preferably insulated with polyurethane foam (approx. 100mm thick), hinged and tight-fitting lid, carrying handles, complete with appropriate number of icepacks, storage capacity approx. 6-27l, cold life range 2-10 days	At least 1	<p>Cold box used to collect and deliver large quantities of vaccines and diluents. Vaccine carrier used for collecting and carrying small quantities of vaccines and diluents, suitable for outreach.</p> <p>Cold boxes and vaccine carriers are used to keep vaccines cold during transport. Range of models are available, with different storage capacity and cold life (the length of time the box can keep the vaccines at the appropriate temperature). The outside temperature and the number of times the box or carrier is opened will affect the cold life.</p> <p>Select cold boxes and carriers according to:</p> <ul style="list-style-type: none"> <li>• Capacity required (number of immunisations)</li> <li>• Length of time vaccines need to be kept at the correct temperature (consider how long it will take to reach and return from the outreach site – cold life should be twice as long as the trip to allow for delays)</li> <li>• Weight (this is determined by how the box will be transported e.g. bike, hand or vehicle).</li> </ul> <p>The foam pad fits on top of the icepacks. When the carrier lid is open, the pad acts as a temporary lid and helps to keep vaccines cool. At the same time it provides a place to hold and protect vaccine vials in use (EPI recommendations discourage the practice of standing vials in ice-pack holes or cups of ice during immunisation).</p> <p>After each use, leave the container lids open so that the insides can dry out. Examine insides for cracks on a regular basis and repair immediately.</p>
	<b>Vaccine carrier</b>	 Durable plastic box, preferably insulated with polyurethane foam (approx. 40mm thick), removable lid, with carrying handles and/or straps, and appropriate number of icepacks, storage capacity approx. 0.1-6l, cold life 24-72 hours, supplied with soft foam pad, approx. 3- 3.5cm thick with slits to hold vials	At least 1 for each outreach team	

Procedure	Item	Specification	No. required	Remarks
Cold chain (continued)	Icepack 	Plastic container (flat), screw caps, capacity: - for cold boxes: 0.6l - for vaccine carriers: 0.3-0.4l	At least 2 sets (1 in use and 1 being frozen). No. required will depend on the type of equipment.	Icepacks are used to maintain the cold chain during transport and immunisation activities. Two types available: pre-filled icepacks (usually not recommended); and open icepack, which you fill with clean, cold water, with some air left for ice to expand. It is not necessary to change water after each use, just refreeze. Icepacks that have melted should not be stored with vaccines, and should never be returned to the cold box or vaccine carrier. It takes approx. 48 hours to freeze an icepack in the freezer compartment of a refrigerator. Alternatively, you can use strong plastic bottles (not glass which can break when frozen) with leakproof lids. Throw away leaky icepacks.  To calculate the number of icepacks required for a cold box or vaccine carrier, halve the gross volume of the container, e.g. a 40l cold box will need 20l of icepacks.

Height measuring board

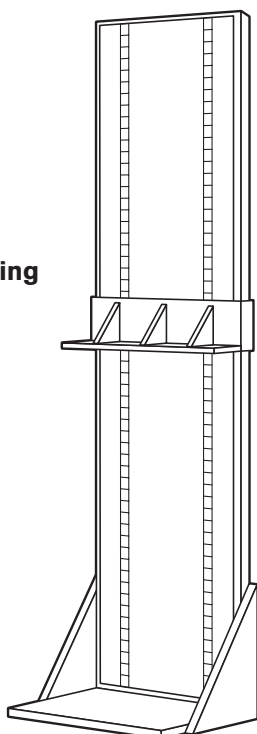

Weight-for-height chart

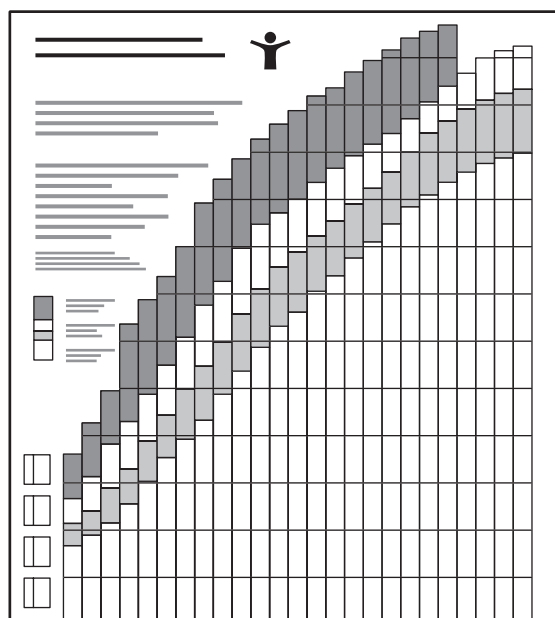



**MUAC strip**

**STOP!Watch**

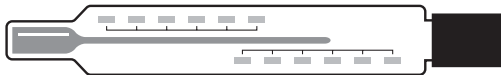
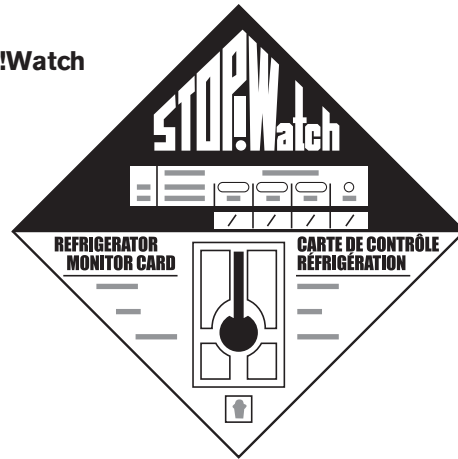

**Stem thermometer**

**Vaccine carrier with foam pad**

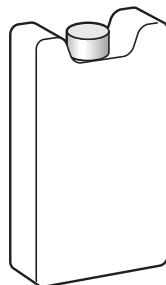
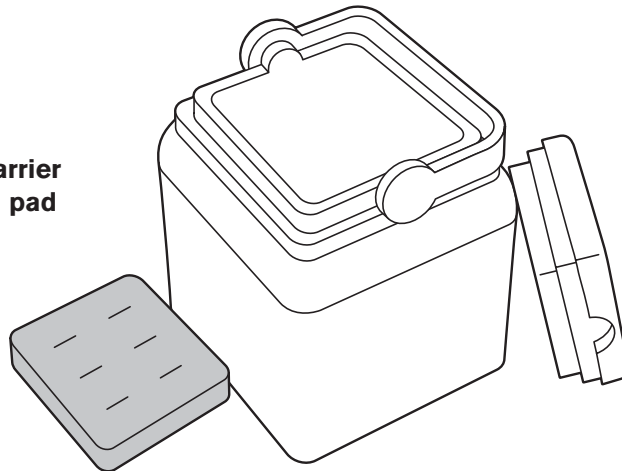

**Ice pack**



## Reproductive and sexual health

The following list describes the supplies and equipment required for the main sexual and reproductive health services at primary care level: maternal care (antenatal and postnatal care, safe delivery at home and at the clinic); child spacing; and prevention and care of sexually transmitted infections (STIs), including HIV. The information about supplies and equipment for delivery care is organised according to the skills and training of the health worker in attendance and where the birth takes place. So separate lists are provided for delivery at home with a trained TBA, delivery at home with a trained midwife (MW), and delivery at a health facility.

Procedure	Item	Specification	No. required	Remarks
<b>Maternal care including antenatal(ANC) and postnatal care (PNC)</b>	All items from diagnosis section plus	See Section 3.1	At least 1 of each	Good ANC is essential to prevent, detect and manage complications during pregnancy, and labour. Good PNC includes a postnatal check, within a week of delivery for early detection and management of maternal complications e.g. hypertension, haemorrhage and sepsis; prevention and management of infections in the newborn, e.g. cord infections, ophthalmia; and breastfeeding promotion and advice about child spacing.
	<b>Examination couch</b>	see p65		
	<b>Trolley</b>	see p65		
	<b>Sterilisation supplies</b>	see p87		
	<b>Injection supplies</b>	see p79		
	<b>Foetal stethoscope</b>  (fetoscope, stethoscope obstetrical, pinard)	Aluminium, plastic or wood, mono-aural, approx. 15cm	1 per trained TBA and outreach MW, and at least 2 per facility with ANC and delivery services	For monitoring/listening to foetal heartbeat. Can be made locally from clay or hollow tube of bamboo.
	<b>Mother's record</b> (health card)	National or WHO card, foldable, kept in a protective plastic bag	1 per pregnant woman	Provides a complete record of a woman's health during pregnancy and helps to detect any factors that may put mother and/or child at risk. Can be kept by the woman at home. The health worker keeps either a logbook or duplicate set of the information on the card. Home-based cards promote greater continuity of care. Cards can be adapted for mothers and health workers with limited literacy, using simple language or picture symbols. In some countries, integrated MCH cards are used.



Procedure	Item	Specification	No. required	Remarks
<b>Maternal care</b> (continued)	<b>Records</b>	Tally sheets for trained TBAs  <i>AND</i> A4, hard backed, lined book for trained MW	At least 1 record-keeping device per worker	Used for record keeping. Use formats appropriate to literacy level. Standardised forms are easy to use and analyse.
	<i>Gestogram (gestation calendar, obstetric calendar)</i>	 <i>Plastic disk, approx. 24cm diameter, graded in days, first foetal movement indicated at the 20th week, with instructions printed on both sides</i>	<i>At least 1 per trained midwife</i>	<i>Used for assessing gestational age, delivery date, by personnel trained in use. Also available as pocket version (diameter 7.6cm), with or without pouch.</i>
<b>Delivery (home with trained TBA)</b>	<b>Apron</b>	see p64	1 per TBA	Used to ensure clean and safe delivery at home. Keep delivery kits complete and ready for use, either as pre-packed kit (suitable for situations with less than 20 deliveries per year) or delivery box with reusable/restockable items (for more than 20 deliveries per year). Keeping everything clean (clean hands, clean birth area, clean cord) prevents infections during childbirth.
	<b>Torch</b>	see p72	1 per TBA	
	<b>Soap</b>	see p66	1 per TBA	
	<b>Soap dish</b>	see p68	1 per TBA	
	<b>Nailbrush</b>	see p64	1 per TBA	
<b>Cotton wool roll</b>	500g, see p115	1 per TBA		
<b>Foetal stethoscope</b>	see p103	1 per TBA		
<b>Plastic sheet</b>	see p64	1 per TBA		
	<b>Gauze</b>	Absorbent, 12 ply, 100% cotton, woven, sterile, paper wrapped, 7.5 x 7.5cm, pack of 20	At least 1 pack per TBA	Various uses including keeping any tears and wounds clean.
	<b>Blade</b> (razor blades)	Blade, double-edged, sterile, individually wrapped, pack of 5  <i>OR</i> <i>Surgical blade, see p117</i>	At least 5 packs per trained TBA  <i>25 units per TBA</i>	For hygienic cutting of cord. New sterile blade should be used for each delivery.
	<b>Gloves</b>	Non-sterile, medium, latex, 20 pairs per box	At least 1 box per TBA	For clean delivery and to protect TBA from direct contact with blood and other body fluids. Should be discarded after use or washed, disinfected and checked for damage before re-use.







Procedure	Item	Specification	No. required	Remarks
<b>Delivery (home with trained TBA)</b> (continued)	<b>Cord ties</b>  (umbilical ties/tape/ligatures)	Cotton, 3-4mm wide x 100m spool (roll), non-sterile, white woven cotton ligature	1 spool per TBA	Cord ties cut into approx. 25cm length pieces (length of a hand), can be sterilised by boiling and drying in the sun. Alternatively, use sterile cord clamps or thick threads.
	<b>Equipment case</b> (bag or box)	Aluminium box with tight-fitting lid, lockable, with handle, approx. 26.5 x 35.5 x 15cm (l x w x h)	1 per TBA	Alternatively, use wooden box or strong cloth or vinyl bag with top opening, lockable buckles, carrying handles, shoulder strap. Size will depend on quantity of contents. Must be easy to clean.
	<i>Timer</i>	<i>Pulsometer, 30 seconds, sand, transparent case</i>	<i>1 per TBA</i>	<i>For monitoring delivery.</i>
	<b>BirthWeigh</b>  (baby weighing scales, birth weight indicator, birth weight scale, Bebe Way)	<i>Colour-coded, low birth weight indicator scale (accurate within 100g), hand held, SS, spring, hook and handle, sling cotton, square shaped, 80 x 80cm</i>  <i>Spare: slings</i>	<i>1 per TBA</i>	<i>BirthWeigh is a simple and accurate tool for assessing newborn weight and easy identification of low birth weight babies (&lt; 2.5kg). Birthweigh II, a modification of Birthweigh I, is a colour-coded and tactile indicator. The TBA either looks at the colour or feels for the button on top of the scale. If the baby weighs less than 2.5kg the button is raised. A simple alternative to weighing a baby is to use a piece of string knotted at 30cm (see p153).</i>
	<i>Sanitary pads (maternity towels/pads, sanitary towels)</i>	<i>Unlooped, approx. 28cms, non-sterile</i>	<i>2 per delivery</i>	<i>Alternatively, use clean strips of cloth for bleeding after delivery. In many areas mothers supply their own clean cloths. You can advise them about making pads from old but clean cloths.</i>

Procedure	Item	Specification	No. required	Remarks
<b>Delivery (home with trained TBA)</b> (continued)	<i>Towels (drapes or cloths)</i>	<i>Cotton, clean, dry, approx. 100 x 120-50cm</i>	<i>At least 2 per TBA</i>	<i>1 to dry and 1 to wrap the newborn immediately after birth. In some areas mothers will supply their own. Advise them about how to boil and store these in a clean container with a lid, ready for use at delivery. Using warm materials helps to maintain the newborn's body temperature.</i>
	<i>Mucus extractor (mucus trap, mucus suction device)</i>	<p>Disposable, with filter, suction catheter, plastic, transparent, 20ml graduated mucus trap, with removable cap, sterile, e.g. De Lee</p> <p>OR</p> <p>Reusable, bulb type</p>	<p>Disposable: 1 per newborn</p> <p>Reusable: 1 per TBA</p>	<p>Filters prevent fluids being sucked into the operator's mouth when suctioning.</p> <p>Bulb extractors are difficult to clean. If using reusable extractors, strict cleaning and disinfection procedures must be followed.</p>
	<i>Nail clipper (cutter)</i>	Chrome plated, sterilisable, approx. 4cm	1 per TBA	For keeping fingernails short and clean.
<b>Delivery (home with midwife)</b>	<p>As trained TBA (including items in italics)</p> <p>Plus:</p> <p><b>Thermometer</b></p> <p><b>Stethoscope,</b></p> <p><b>Tape measure</b></p> <p><b>Tablet bags</b></p> <p><b>Sphygmo-</b> <b>manometer</b></p> <p><b>Bottle</b></p> <p><b>Catheters</b></p> <p><b>urinary</b></p> <p><b>Kidney dish</b></p> <p><b>Bowl</b></p> <p><b>Baby weighing scale</b> (midwife scales)</p>	<p>see p71</p> <p>Single cup, see p71</p> <p>see p65</p> <p>see p77</p> <p>see p71</p> <p>125mls, see p118</p> <p>Reusable, Nelaton, CH12, CH14, see p83</p> <p>see p117</p> <p>500mls, see p118</p> <p>Scale, spring, baby, tubular, hand hold bar, hook for sling, range 5kg x 25g or 10kg x 100g, sling cotton square, 80 x 80cm</p> <p>Spare: sling</p>	<p>Per MW at least</p> <p>1</p> <p>1</p> <p>1</p> <p>1 pack</p> <p>1</p> <p>1</p> <p>1 of each size</p> <p>2</p> <p>1</p> <p>At least 1 per MW</p>	<p>Tape measure for measuring fundal height.</p> <p>Bottle for antiseptic solution.</p> <p>Catheter to empty bladder before delivery.</p> <p>Separate basins and bowls to be used for cord care, cleaning eyes of the newborn with clean boiled water, and for the placenta.</p> <p>Alternatively, use round SS or sterilisable bowls instead of kidney dishes.</p> <p>For weighing newborns in the community. MW to use spring scale instead of the BirthWeigh used by TBAs.</p>

Procedure	Item	Specification	No. required	Remarks
<b>Delivery (home with midwife)</b> (continued)	<b>Delivery set</b>	4 instrument + box set	At least 1 set per MW, each set:	Sterilise or boil instruments before use. Buy good quality instruments.  Box for storing boiled/sterilised instruments.  Artery forceps – general use, e.g. clamping.  General toothed dissecting forceps for gripping/holding flesh.  Umbilical scissors for cord cutting. Keep 1 pack of 5 sterile razor blades as a back up.  Dressing scissors also known as 'surgical scissors'. Used for cutting threads, dressings and general use.
		– SS box, approx. 20 x 7 x 3cm	1	
		– Forceps artery, approx. 14-17cm, straight, box joint, SS, e.g. Rochester Pean	1	
		– Forceps dissecting, spring type, approx. 15cm, 1 x 2 teeth, SS,	1	
		– Scissors cord (umbilical), SS, either American pattern, 10cm OR Schumacher 15.5cm	1	
	– Scissors dressings, straight or curved, blunt/blunt, SS, 14-18cm	1		
	<b>Partograph</b> (partogram, labour progress charts)	National or WHO partographs	1 per pregnant woman	Practical aid for monitoring the well-being of mother and baby and referring if problems. Enables the midwife to track the progress of labour, and identify whether it is too slow or too prolonged. Not recommended for use by TBAs.
	<i>Emergency blanket (wrap, silver swaddlers, space blanket)</i>	<i>Infant, disposable foil, 122 x 100cm</i>	<i>1 per MW</i>	<i>For wrapping hypothermic newborn and premature babies to prevent heat loss. Can use dry, clean towels/blankets instead or skin-to-skin contact.</i>
<b>Delivery (health centre)</b>	<b>As above for MW</b>		Per delivery, at least:	
	Plus: <b>Low reading thermometer</b>	see p71	1	
	<b>Catheters urinary</b>	Disposable, size CH12, CH14, see p83	2 of each size	Catheter to empty bladder before delivery.
	<b>Trolley</b>	Approx. 95 x 55 x 100cm, see p65	1	Trolley used as clean, easy to reach place to lay out sterile items.
	<b>Dressing tray</b>	see p117	1	

Procedure	Item	Specification	No. required	Remarks
<b>Delivery (health centre)</b> (continued)	<b>Instrument tray</b>	see p117	1	
	<b>Gloves surgeons</b>	6.5 and 7.5, see p116	2 pairs of each size	Use sterile surgical gloves for deliveries instead of disposable gloves.
	<b>Bed labour and delivery (obstetric)</b>	Approx. body section 100 x 77 x 76cm, leg section 93 x 64 x 76cm (l x w x h), approx. 5cm thick polyurethane filled pads, with waterproof and washable cover, supplied with adjustable leg/knee supports, SS or epoxy-coated frame, castors (optional)	At least 1 Actual number will depend on the number of deliveries performed at the unit and catchment population.	May be ordered as flat packed, to be assembled at site. Can be made locally.
	<i>Cot (baby/infant crib)</i>	<i>Approx. 88 x 45 x 100 cm (l x w x h), epoxy-coated frame, 2 swivel castors, removable basket with perforated base plate, cotton felt pad, washable waterproof cover with zipper, flaps or ties</i>	<i>At least 1</i>	<i>For nursing newborns.</i>
	<i>Cord clamps (umbilical clamps)</i>	<i>Sterile, disposable</i>	<i>At least 2 per delivery</i>	<i>May be used instead of cord ties/tapes.</i>
	 <i>Forceps obstetric (midwifery forceps)</i>	<i>2 separate spoon-shaped (cephalic) blades each with handle and marked left and right, SS, rotational e.g. Kiellands, or non-rotational, e.g. Wrigley</i>	<i>At least 1 of each design</i>	<i>Used to grip the head of a baby to help in difficult vaginal delivery. Should only be used by those trained to carry out this procedure.</i>
<b>Care of episiotomies and perineal tears</b>	 <b>Scissors episiotomy</b>	Angled blades, blunt end blades, SS, approx. 12.5- 20cm, e.g. Braun-Stadtler (perineorrhaphy scissors), Barnes  OR Straight, SS, blunt/blunt, 24cm, e.g. Vant	At least 2	Only use if staff trained and qualified to perform episiotomies. Use with delivery set. Keep pre-packed episiotomy kit (consisting of 2 and 10ml disposable syringe, 21G and 18G needles, local anaesthetic, gauze swabs, episiotomy scissors) and suture set on hand during deliveries.

Procedure	Item	Specification	No. required	Remarks
<b>Care of episiotomies and perineal tears</b> (continued)	<b>Suture set</b>  <i>AND</i> <b>Sutures</b>	see p120  Atraumatic sutures (suture with needles attached): absorbable, synthetic or chromic catgut, 1/2 circle, round body needle, 2/0 (DEC3.5), approx. 45-75cm thread, sterile foil pack  <i>AND/OR</i>  Sutures: absorbable, without needle, rolls of 2/0, 0, 1  <i>AND</i> Needles: suture, 1/2 circle, round bodied, SS, size 12, 16	At least 1 set  At least 2 packs per delivery  At least 1 roll of each  At least 2 of each size	Keep at least 1 prepared suture set for use during deliveries.  Chromic catgut suture is preferable to plain catgut, as it has a slower absorption rate and holds its strength for approx. 20 days. If using sutures on rolls/reels, staff must be trained to cut, curl and sterilise before use, and to sterilise needles before use. See suturing and minor surgery sub-section (p120) for more information about suturing.  Staff trained to make episiotomy should be able to suture tears and episiotomies.
	<b>Gynaecological examinations</b>	<b>Speculum vaginal</b>    <b>Forceps sponge holding</b>    <b>Retractor vaginal</b>    <b>SS box</b>	Bi-valve (duckbill), SS, approx.: – 75 x 17-20mm – 95-105 x 25-35mm – 107-115 x 29-35mm  Forceps, polypus, swab holding, serrated, box joint, straight or curved on flat, approx. 18-24cm, SS, e.g. Foerster, Rampley  Retractor, vaginal, medium, e.g. Doyen 240mm, with blunt lateral edges and blade 60 x 35mm  SS, approx. 32 x 15 x 8cm	At least 2 At least 2 At least 1  At least 2  At least 2  At least 2

Procedure	Item	Specification	No. required	Remarks
Child spacing and prevention of STI and HIV	<b>Male condoms</b> (sheaths, skins, known by many different brand names)	Latex, individually sealed in aluminium foil pack, available as: lubricated <i>OR</i> dry (non-lubricated). General specifications: Wide: 50-54mm x 170-180mm Narrow: 47-51mm x 160-170mm	Estimated requirements per user approx. 144 condoms/year or 12 condoms/month	Male latex condoms come in variety of colours, sizes, textures, shapes and styles, lubricated with a spermicidal agent (such as nonoxynol-9) or dry. If you have a choice buy pre-lubricated condoms. Male condoms made with polyurethane (stronger material than latex) have recently become available but are more expensive. Foil package provides protection from light. Do not use if the condom is very sticky, dried out or if the package is cracked or torn. Male condoms must never be re-used.
	<b>Female condoms</b> (Femidon, Reality, Femy, Femshield)	 Lubricated, polyurethane sheath with 2 flexible rings, 17cm long, 0.43-0.53mm thick, 7.8cm diameter	Estimated requirements per user approx. 12 condoms/month/female (single use)	Female condoms are a woman-controlled method. Fits inside the woman's vagina, can be put into place up to several hours before sexual activity, does not have to be immediately removed after intercourse. Available in 1 size only. Marketed as single use, but research is ongoing into re-use.  Buy condoms manufactured to international established standards (see Section 2). Check for expiry dates or, if none, check date of manufacture. To avoid shortages ensure 3 month's reserve stock.  If consistently and correctly used, male and female condoms are barrier methods that provide dual protection against pregnancy and STI including HIV.
	<b>Lubricants</b>	Water based: glycerine, KY-jelly Oil based: vaseline (petroleum jelly), skin lotion, hand creams, moisturising lotion, oils (body, baby, vegetable)	Estimated yearly requirements per user, 6 tubes	Lubricants help reduce condom breakage and make the condom more comfortable to use. Be careful to use the right type of lubricant. Use water-based lubricant with male latex condoms as oil-based ones damage and weaken rubber, making the condom more likely to break.

Procedure	Item	Specification	No. required	Remarks
<b>Child spacing and prevention of STI and HIV</b> (continued)	<b>Lubricants</b>			Water-based or oil-based lubricants may be used with the female condom. To avoid confusion it may be better to recommend water-based lubricants for both types of condoms.
	<b>Spermicides</b>	Available in several forms: jelly (gel), cream, foaming tablets, aerosol foams, pessaries, film	Estimated yearly requirements per user: foaming tablets/pessaries 140 tabs; foam 2.5 cans; jelly/cream 6 tubes (25g tube)	Spermicides contain chemicals that inactivate or kill sperm. Main spermicidal chemicals are nonoxynol-9, octoxynol-9, menfegol + benzalkonium chloride. Although they are fairly good methods on their own, they are more effective if used with another barrier method such as condoms and diaphragms. Spermicides are placed in the vagina before sex. Foam, jelly and cream must be applied with special plastic applicators. Give enough for 3 month supply at a time and encourage return for replacements.
	<b>Diaphragm</b> 	Dome shaped, latex rubber with flexible circular rim, range of sizes from 55 to 100cm (in 5mm steps), storage case, 3 main types available: – Flat spring – Coiled spring – Arching spring	1 per user	Female barrier method. Soft rubber cap that fits into the vagina and covers the cervix. Only to be fitted by trained staff. Pelvic examination needed to estimate the size and type of diaphragm required. Keep a selection of fitting, teaching and practice diaphragms in all sizes at the health unit. Depending on usage and climate, the diaphragm must be replaced every 1-2 years or when torn or damaged. Effectiveness is increased if used with spermicide. Avoid oil-based lubricants, which will damage the rubber.

Procedure	Item	Specification	No. required	Remarks
<b>Child spacing and prevention of STI and HIV</b> (continued)			Note: the no. using each type of contraceptive and quantities required depend on national policies. In the absence of these, use % of sexually active population to estimate: <ul style="list-style-type: none"> <li>- Pills 50%</li> <li>- Injection 10%</li> <li>- IUD 15%</li> <li>- Condoms 20%</li> <li>- Others (foams, jellies etc.) 5%</li> </ul>	All contraceptive methods are only effective if used consistently and correctly. Supplies should be stored in a dry, clean, cool (about 24°C), well-ventilated area and protected from sunlight.  Contact MOH or WHO/UNFPA/UNAIDS country offices for advice about purchase of contraceptives.

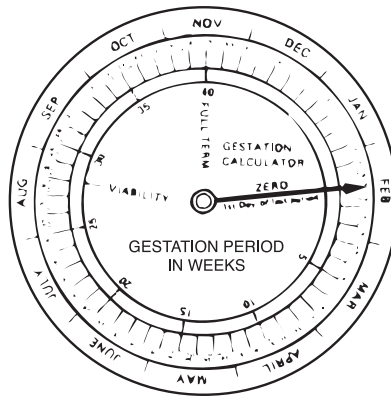
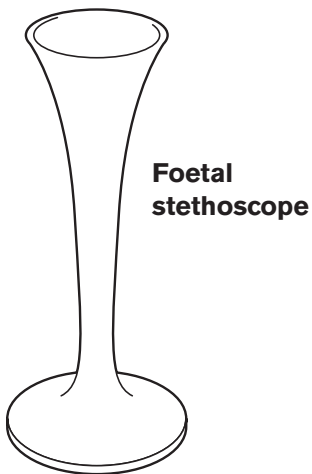

**Birth-weight scale for TBAs**

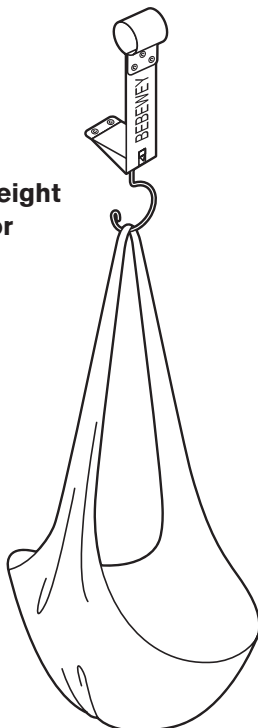

**Baby weighing scale for MWs**

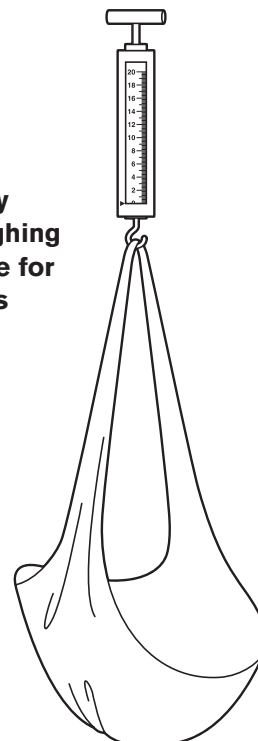



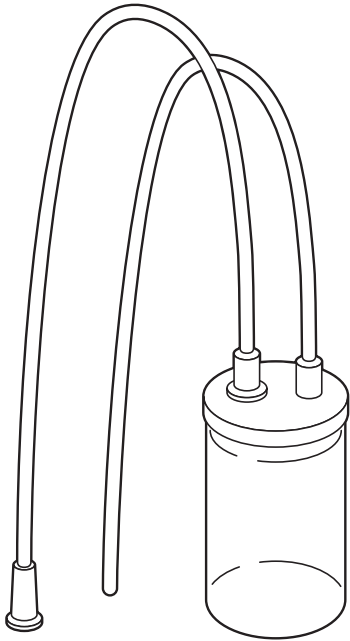

**Mucus extractor - disposable**

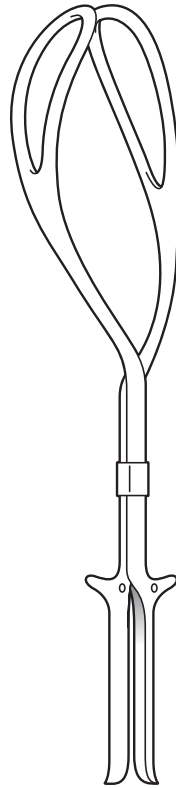

**Forceps obstetric - Keillands**



**Forceps obstetric - Wrigley**

**Nail clipper**

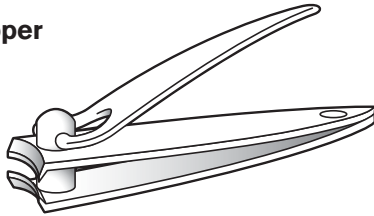

**Scissors episiotomy - straight**

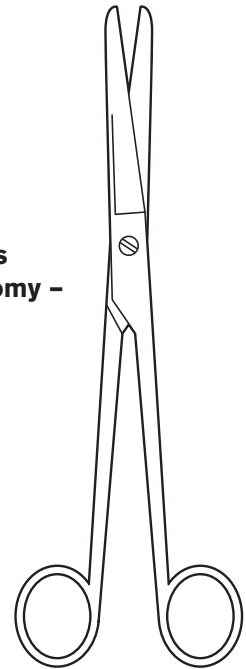

**Scissors episiotomy - angled**

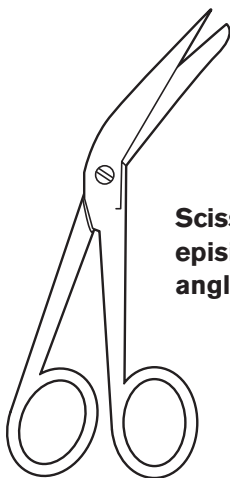

**Scissors cord - American pattern**

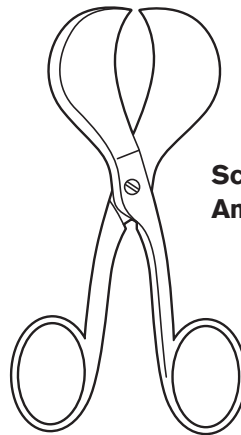

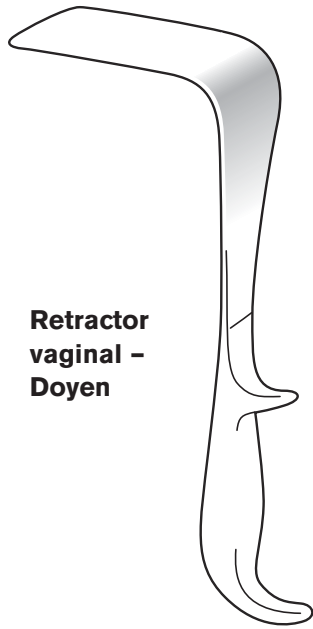

**Retractor vaginal - Doyen**

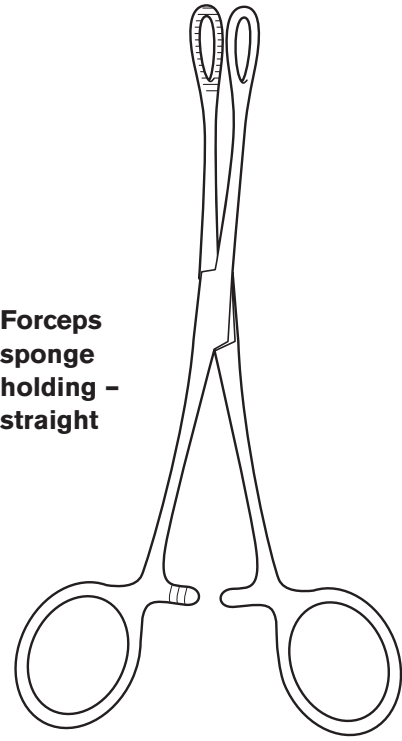

**Forceps sponge holding - straight**

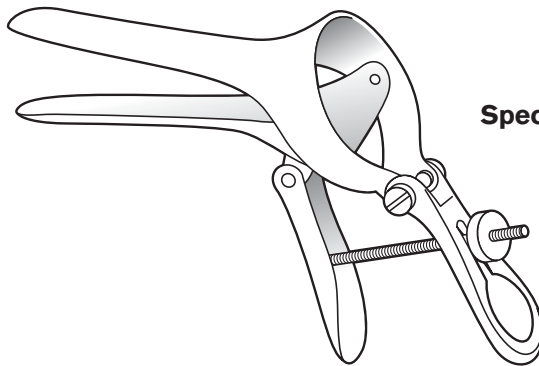

**Speculum vaginal - bi-valve**



**Female condom**

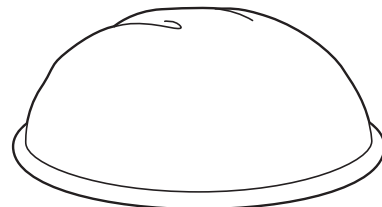

**Diaphragm**

## Dressings, minor surgery and first aid



This sub-section describes basic supplies and equipment required for dressings, minor surgical procedures and providing first aid to people (before sending them for further treatment) in the event of an emergency. Requirements will depend on the type of activities carried out by your facility, for example, some health centres carry out suturing of wounds, or incision and draining of abscesses.

### Dressings

Item	Specification	No. required	Remarks
<b>Bandages</b>	Gauze (cotton): 100% cotton gauze bandage, absorbent, with selvedge, non-sterile, individually wrapped in protective wrapping, roll(s): approx. 2.5-15cm x 4-5m, 12 per pack	At least 20 packs, mixed sizes	Gauze bandages for holding minor wound dressings in place. Selvedge protects against fraying. Non-elastic and non-adhesive.
	Elastic (crepe): 100% cotton crepe, non-adhesive, non-sterile, protective wrapping, roll(s): approx. 5-10cm x 2.5-5m, 12 per pack	At least 6 packs, mixed sizes	Elastic bandage used for applying pressure, suitable for first aid. Check that bandage keeps its elasticity after washing and stretching.
	Triangular: Cloth, approx. 80-90cm x 127cm	At least 12	Triangular bandage used as an arm sling.
	<i>Adhesive (elastic): Elastic cotton bandage with selvedge, impregnated with adhesive (zinc oxide) and protective (paper or polyethylene) strip, individually wrapped in protective wrapping, roll(s): approx. 5-7.5cm x 4-4.5m, 12 per pack</i>	<i>At least 1 pack</i>	<i>Adhesive bandage for supporting sprained or dislocated joints.</i>
<b>Cotton absorbent</b> (cotton wool)	100% cotton wool roll, absorbent, in protective wrapping (plastic or paper), non-sterile, roll sizes: 100g, 500g or 1kg	At least 1 kg	For general clinic use, e.g. making Q-tips, cleaning and disinfecting wounds. Plastic wrapping preferable as it protects against humidity.
<b>Gauze</b>	Roll, gauze absorbent, 100% cotton, protective wrapping (generally paper) non-sterile, approx. 20-22cm x 90m  <i>OR</i> <i>Folded, gauze absorbent, 100% cotton, with selvedge, protective wrapping (generally paper), non-sterile, approx. 65-90cm x 60-100cm</i>	At least 3 rolls  <i>Equivalent to 3 x 90m rolls</i>	For making up non-sterile pads to cover and protect wounds.

Item	Specification	No. required	Remarks
<b>Gauze swabs</b> (compress, pads)	<p>Non-sterile: Gauze absorbent, 100% cotton, woven, 8-12 ply, non-sterile, 10 x 10cm, paper wrapped, 100 per packet</p> <p><i>AND</i></p> <p>Sterile: Gauze absorbent, 100% cotton, woven, 12 ply, sterile, 10 x 10cm, each pack with peel-off protective wrapping, 5 per pack</p>	<p>At least 5 packets</p> <p>At least 200 packs</p>	<p>Ply indicates thickness (i.e. folds) of gauze. The thicker the gauze the better the absorption: 12 ply is thickest.</p> <p>Non-sterile used to cover wounds, make up dressings, suitable for first aid.</p> <p>Sterile used to clean wounds or skin, protect wounds, and make dressings.</p> <p>Sterile packs are also available in sizes 5 x 5cm and 7.5 x 7.5cm.</p>
<b>Gauze pads</b> paraffin (compress, paraffin gauze pads/dressings)	<p>Gauze absorbent, 100% cotton, woven, gauze impregnated with paraffin-based material, sterile, 10 x 10cm, box (tin) of 10 or 36</p> <p><i>OR</i></p> <p>Sterile, single units, individually wrapped, peel apart</p>	<p>Approx. 3 boxes of 10 pieces or equivalent</p>	<p>For covering and treating wounds, such as burns and scalds. Paraffin prevents dressings sticking to the wound. Can be locally made by mixing gauze squares with vaseline and sterilising.</p>
<b>Dressing pads</b>	<p>Gauze absorbent, 100% cotton, woven:</p> <ul style="list-style-type: none"> <li>- Non-sterile, approx. 10-20cm x 20cm, pack of 25</li> </ul> <p><i>AND</i></p> <ul style="list-style-type: none"> <li>- Sterile, individually wrapped, approx. 10-20cm x 20cm, pack of 25</li> </ul>	<p>At least 5 packs</p> <p>At least 5 packs</p>	<p>To cover heavily discharging wounds or as a protective second pad. Non-sterile pads can be locally made by wrapping thick piece of cotton wool with gauze.</p>
<b>Tape</b> (plaster)	<p>Adhesive roll:</p> <p>With zinc oxide, non-stretch, waterproof, colour white or skin tone, roll(s) approx. 2.5cm, 5cm or 7.5cm x 5m</p> <p><i>OR</i></p> <p>With mixture of rubber, resins and lanolin, non-stretch, waterproof, fissures, roll(s) approx. 2-2.5cm x 5m</p> <p><i>AND</i></p> <p>Microporous, hypo-allergic, waterproof, roll(s) approx. 1.25cm, 2.5cm, 5cm or 7.5cm x 9-10m</p>	<p>At least 30 rolls of mixed sizes</p> <p>At least 12 rolls of mixed sizes</p>	<p>Adhesive tape used for fixing and holding securely in place dressings, needles, etc. When buying, check that tape will stick strongly to the skin but can be removed easily and without causing damage to the skin. Waterproof tape does not become unstuck when wet.</p> <p>Hypo-allergic tape used for sensitive skin.</p>
<b>Gloves surgical</b> (surgeons)	<p>Latex, disposable, sterile, pre-powdered, individually wrapped in pairs, size 6.5, 7.5, 8.5, approx. 50 pairs per box</p>	<p>At least</p> <ul style="list-style-type: none"> <li>6.5 x 1 box</li> <li>7.5 x 3 boxes</li> <li>8.5 x 1 box</li> </ul>	<p>Sterile gloves should be used for procedures involving contact with normally sterile areas of body, e.g. during suturing, minor surgery and deliveries by trained health workers.</p>

Item	Specification	No. required	Remarks
<b>Pins</b> (safety pins)	Nickel-plated brass or steel, non-sterile, assorted sizes 38mm, 45mm, 57mm, 87mm	At least 100	To secure bandages. Tape over the pin to prevent accidental pin stick injury.
<b>Kidney dish</b> (basin, receivers)	SS or sterilisable plastic, kidney shape, approx. 26cm x 14cm	At least 3	For general use from holding soiled dressings to soaking instruments for cleaning.
<b>Dressing tray</b>	Rectangular tray with rounded corners, SS or sterilisable plastic, approx. 30 x 15-22cm x 3cm, non-sterile	At least 2	To carry miscellaneous materials, e.g. dressings, and injections, and set out instrument sets.
<b>Instrument tray</b>	SS, round corners, removable flat and overlapping cover fitted with handle, approx. 22 x 8 x 4cm	At least 2	To hold and store instruments. May also be used for boiling instruments.
<b>Dressing set</b>	3 instruments + box set: <ul style="list-style-type: none"> <li>– SS instrument box approx. 18 x 8 x 4cm</li> <li>– Forceps dissecting, spring type, approx. 12-16cm, serrated, rounded tips, SS</li> <li>– Forceps artery, approx. 12.5-14cm, 1 x 2 teeth, box joint, SS, e.g. Kocher</li> <li>– Scissors dressing, straight, sharp/blunt, approx. 12-14cm, SS</li> </ul>	At least 6 sets. Each set: 1 1 1 1	Box for storing and sterilising instruments. Check the box is watertight when closed. Use forceps for 'clean dressing technique'. Forceps can be short for working close to the surface or longer for working more deeply. Dressing scissors (also known as surgical scissors) for general use, e.g. cutting threads, dressings, should not be used for other purposes, such as cutting tissues. For each patient, use sterile set of instruments.
<b>Forceps dissecting</b>	Spring type, approx. 12-14cm, serrated rounded tips, SS  <i>AND</i> Spring type, approx. 12-15cm, 1 x 2 teeth, SS	At least 2 of each type	Commonly used in surgery and nursing procedures. For gripping and dissecting tissues. Forceps without teeth are used for dissecting delicate tissues and those with teeth for thick tissue.
<b>Forceps artery</b>	Approx. 12-14cm, straight, box joint, SS, e.g. Pean	At least 4	General forceps designed for grasping tissue and stopping bleeding from veins and arteries. Artery forceps are also commonly known as 'haemostatic forceps'.
<b>Scalpel blades</b> (surgical blades)	SS, sterile, each individually foil wrapped, disposable, length approx. 6cm, pack of 100 blades <ul style="list-style-type: none"> <li>– Blade size no. 10 to fit scalpel handle No. 3</li> <li>– Blade size no. 22 to fit scalpel handle No. 4</li> </ul>	At least 1 pack of each size	Sterile blades are basic cutting instruments for making incisions, e.g. abscess, cord. Blade No. 11, 12 and 15 will also fit No. 3 handle. Blade No. 20 and 21 will also fit No. 4 handle.

Item	Specification	No. required	Remarks
<b>Scissors</b>	 <p>Dressing, approx. 12.5-18cm, straight, sharp/blunt, SS</p> <p><i>AND</i></p> <p>Dressing, approx. 12.5-18cm, curved, sharp/blunt, SS</p>	At least 3 straight scissors and 1 curved	Dressing scissors, commonly known as surgical scissors, for general use e.g. cutting bandages and gauze, should not be used for anything else, e.g. cutting tissues or sutures. The best scissors have tungsten carbide, which makes their cutting edges last much longer but are more expensive.
<b>Bottles</b>	<p>Plastic HDPE (high density polyethylene), opaque:</p> <ul style="list-style-type: none"> <li>– Bottle 1l with screw cap</li> <li>– Bottle 100-250ml, round, narrow mouth, with spout (optional)</li> </ul>	At least 1l x 3 100-250ml x 2	For diluting and storing liquids such as antiseptics, and disinfectants. Opaque for light sensitive materials, HDPE bottles are resistant to chlorine and iodine. Check caps are firm fitting to prevent leakage.
<b>Gallipots</b> (cup, pot)	SS or sterilisable plastic, approx. 100-500 ml (8-12cm)	At least 3	For holding antiseptic lotions, cotton wool and swabs when carrying out dressings, giving injections.
<b>Bowls</b> (lotion bowl, sponge bowl)	<p>SS or sterilisable plastic, approx. 125mm capacity 500mls</p> <p><i>AND</i></p> <p>SS or sterilisable plastic, approx. 150-200mm, capacity 900-2000ml</p>	At least 2  At least 2	For general use from soaking instruments to holding materials.
<b>Razor and blades</b>	<p>Razor: Safety, SS, sterilisable, razor handle approx. 8cm, takes double-edged disposable blades</p> <p><i>AND/OR</i></p> <p>Plastic, disposable</p> <p>Blades: Razor blades, SS, double-edged, pack of 5 or 10</p> <p>Spare: blades, packs of 5 or 10</p>	<p>At least 2 sterilisable razors</p> <p>1 disposable razor per patient</p> <p>At least 10 packs of 10 blades</p>	<p>For shaving hair. If using sterilisable razors, clean and disinfect between each patient and change the blade.</p> <p>For use with reusable razors.</p>
<b>Drum</b>	 <p>SS, cylindrical drum with perforated sides and airtight sliding shutter to cover perforations, hinged lid with lifting handle and lateral eclipses, size 15 x 10cm and 15 x 15cm</p>	At least 2 of each size	For storing dressings (compresses, cotton wool). Alternatively use airtight plastic containers for storing these materials. Can also be used for sterilising reusable products and sterilising gauze.
<b>Trolley</b> (dressings)	see p65	At least 1	To lay out materials such as dressings in a clean and easy to reach place. Clean and dry trolley between each use. Trolley used for dressings should not be used for other purposes.

**Instrument tray**

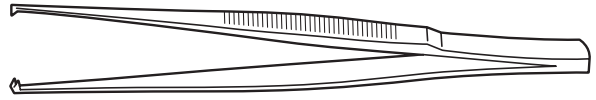
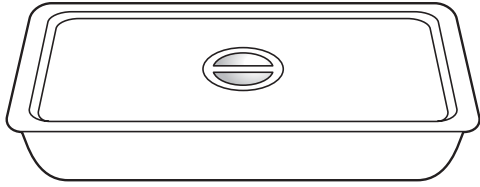

**Forceps dissecting - toothed**

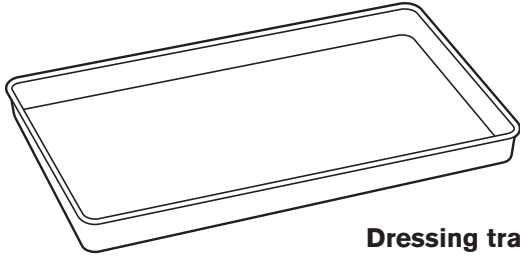

**Dressing tray**

**Scalpel handle**

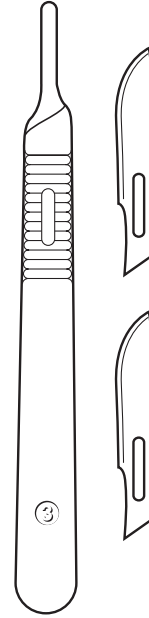

**Scalpel blades**



**Forceps artery - straight**

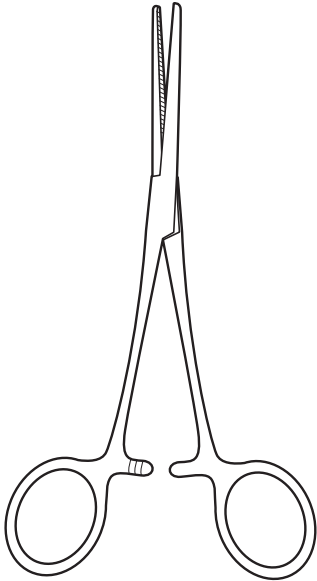

**Scissors dressing - curved**

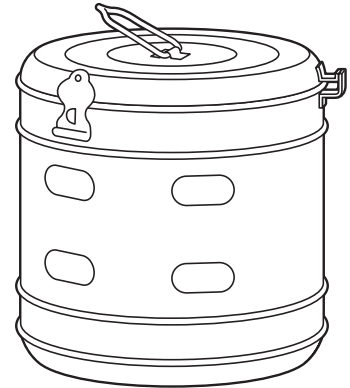
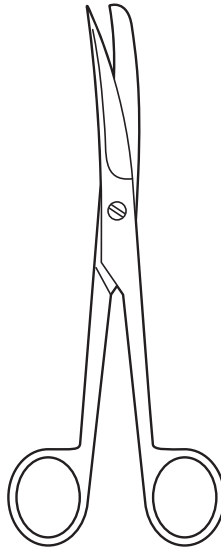

**Drum**

**Dressing set**

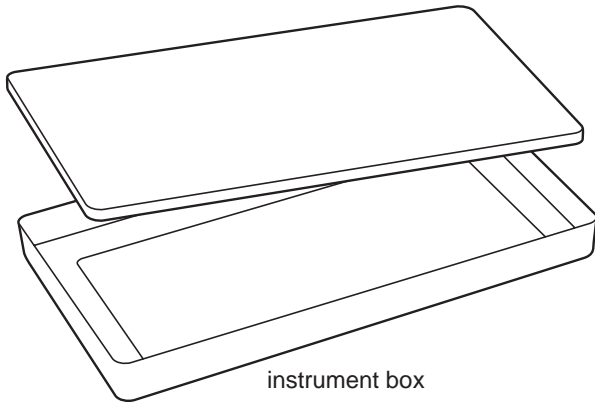

instrument box

forceps dissecting - round

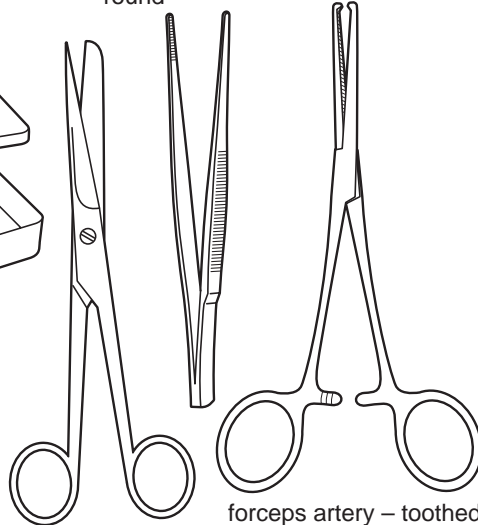

scissors dressing - straight

forceps artery - toothed

## Suturing and minor surgical procedures

Item	Specification	No. required	Remarks
<b>General suture/abscess set</b>	8 instruments + box set	At least 2 sets Each set :	Ideally at least one suture set should be set aside to be used only for episiotomies.
	– SS instrument box, approx. 20 x 10 x 5cm	1	<p>Check box for storing instruments is watertight.</p> <p>Probe used to explore wounds/abscesses. Needle holder used to hold suture needles while suturing. Holders can have plain jaws, or tungsten carbide inserts. If needle holders are high use, consider buying holders with tungsten inserts; although more expensive, they have greater resistance to wear and tear and last twice as long. Needle holders are one of the few instruments where metal is held by metal and are subject to considerable wear.</p> <p>Handle for holding blades for incisions must be good quality. Poor quality handles may not fit the blades. The number on the handle indicates the type of distal (blade) end and therefore the size of blades. No. 3 standard handle for blades 10, 11, 12 and 15. Blades No. 20, 21, 22 fit handle No. 4</p>
	– Forceps dissecting, approx. 12-16cm, see p117	1	
	– Forceps dissecting, approx. 12-14cm, with 1 x 2 teeth, see p117	1	
	– Forceps artery, approx. 12-14cm, 1 x 2 teeth, see p117	1	
	– Forceps artery, approx. 12-14cm, curved, SS e.g. Mosquito	1	
	– Scissors dressings, approx. 12-15cm, straight or curved, see p118	1	
	– Probe (dilator, spear), 1.5-2mm bulbous tip at both ends, SS, approx. 12-18cm	1	
	– Needle holder, approx. 14-18cm, serrated, straight, SS, e.g. Mayo-hegar	1	
	– Handle scalpel, nickel, No. 3 or No. 4	1	
<i>Abscess:</i> <i>Scoop (curette), single ended, SS, approx. 17cm length and spoon size 2-6mm</i>	1	<i>Refer if abscess is heavily infected or if you are not sure where to incise.</i>	
<b>Suture with needle (atraumatic suture)</b>	– Nylon, monofilament (synthetic, non-absorbable) 2/0(DEC3), <sup>3</sup> / <sub>8</sub> triangular reverse cutting 40mm needle, approx. length 45cm, single pack, sterile	At least 144 units of mixed sutures	<p>Sutures and needles come in many different material types, sizes, and lengths. Choice of sutures and needles will depend partly on user, the procedure and the tissue to be sutured. At PHC level, 2 types of sutures will usually be sufficient: an absorbable (for episiotomy, subcutaneous tissues, muscle) and a non-absorbable, monofilament (nylon) or braided (multifilament) (for skin suturing and minor surgery).</p> <p>Absorbable sutures are absorbed by the tissue and do not need to be removed. Non-absorbable sutures need to be removed if they are on the skin.</p> <p>Strength of suture is measured in 2 systems: USP (commonly used) and DEC metric (newer), both are included in the labelling. In the USP system, the strength is measured using the sequence from 6/0, 5/0, 4/0, 3/0, 2/0, 1/0, 0, 1, 2,</p>
	<i>AND/OR</i>		
	– Silk, braided (coated, non-absorbable), 3/0(DEC2), <sup>1</sup> / <sub>2</sub> triangular reverse cutting 22mm needle, approx. length 45cm, single pack, sterile		



Item	Specification	No. required	Remarks
<p><b>OR</b> <b>Needles without sutures</b></p> <p><b>AND</b> <b>Sutures without needles</b></p>	<p>☞ – Needle, suture, 1/2 circle, round-eyed, corrosion-resistant steel, reusable, size 2, 3, 4 and 7</p> <p><i>AND/OR</i></p> <p>– Needle, suture, 1/2 or 3/8 circle, triangular, regular eye, corrosion-resistant steel, size 2, 3, 4 and 7</p> <p>☞ – Suture silk, braided, coated, non-absorbable, 2/0(DEC2.5) or 1(DEC4), approx. length 1.8m, single pack, sterile</p> <p>– Polyglactin, absorbable, synthetic, braided, 2/0(DEC2.5) or 1(DEC 4), approx. length 1.8m, single pack, sterile</p> <p><i>OR</i></p> <p>– Suture, nylon, monofilament, 2/0, 2000m reel</p> <p>– Suture, silk, braided, 2/0, 100m reel</p>	<p>At least 6 of each size</p> <p>At least 50 units mixed or one type</p> <p>At least 1 reel of each</p>	<p>3, 4 (from finest to thickest, e.g. 6/0 being the finest and 4 being the thickest) whilst metric ranges from 0-8. Sutures between 3/0 and 1 will be appropriate for most situations; suture 2/0 is generally the most useful size. For example, if using non-absorbable sutures, you will need size 3/0 (DEC2.5) for the face, 2/0(DEC3) for the scalp, 3/0 or 2/0 (DEC2.5 or 3) for the body. If using absorbable sutures, use 2/0(DEC3) for sub-cutaneous tissue and 2/0(DEC3.5) for muscle.</p> <p>Monofilaments (nylon and prolene) are the most useful general purpose sutures for tropical conditions, because they are less likely to promote infection than multifilament silk or catgut.</p> <p>Single pack atraumatic sutures (sutures already mounted on a needle by the manufacturer) can be costly. It may be more useful to buy separate sterilisable needles and suture materials. If using non-sterile sutures, health workers need to be trained to store, prepare and sterilise sutures before use.</p> <p>Alternative non-absorbable materials that may be used include sterilised cotton and nylon fishing line.</p> <p>Use triangular curved cutting needles for suturing skin and round half circle needles for subcutaneous tissue and episiotomies.</p>
<b>Stitch removal set</b>	<p>3 instruments + 1 box set</p> <p>– SS instrument box approx. 18 x 8 x 4cm</p> <p>– Forceps dissecting, approx. 12-14.5 cm, see p117</p> <p>– Stitch scissors, approx. ☞ 8-14cm, with hook end lower blade, SS, e.g. Littauer</p>	<p>At least 1 set</p> <p>1</p> <p>2</p> <p>1</p>	<p>Alternative stitch scissors, Leeds Pattern stitch scissors, sharp/sharp, curved, SS, 14cm. Disposable stitch cutters may be used instead. These are available either as hand-held or for use with No. 3 scalpel handle. Hand-held stitch cutters are available in 2 sizes: long (SS) or standard, sterile, pack size 100 per pack.</p>



**Probe**

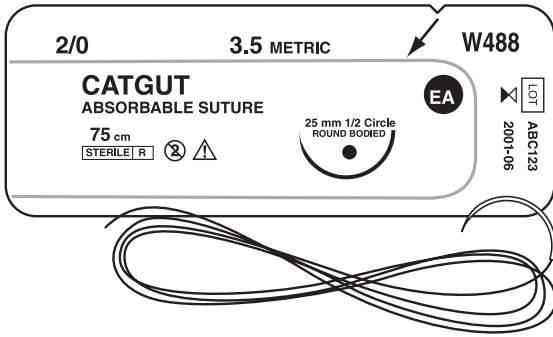

**Suture and needle pack - sterile**

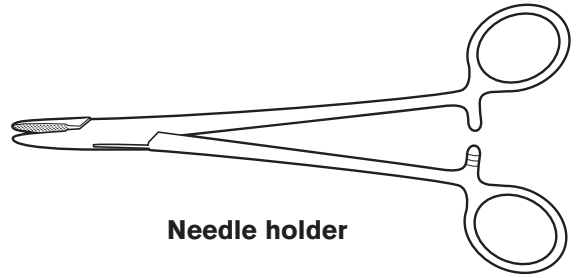

**Needle holder**

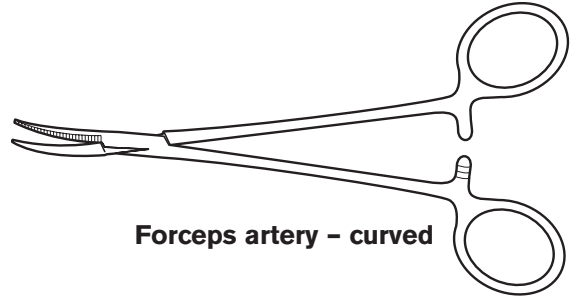

**Forceps artery - curved**

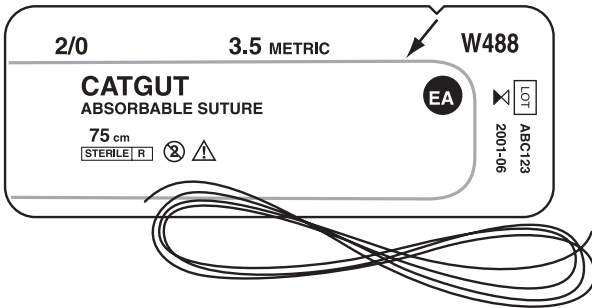

**Suture without needle pack - sterile**

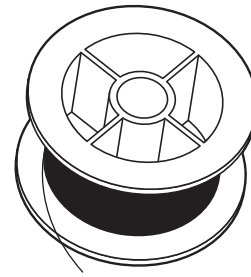

**Suture reel**

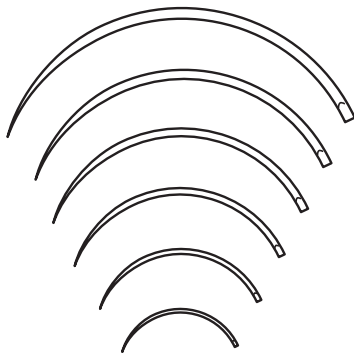

**Needles suture set - 3/8 circle**

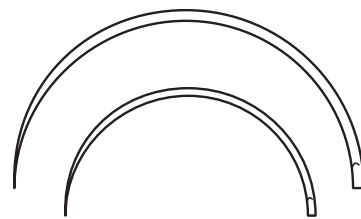

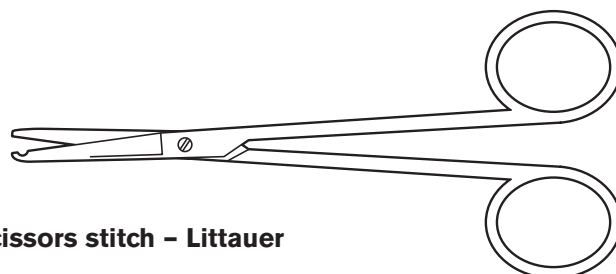

**Needles suture set - 1/2 circle**



**Scissors stitch - Littauer**

## First aid

Item	Specification	No. required	Remarks
<b>Stretcher</b>	See px	At least 1	For transporting patients.
<b>Plaster</b>	<p>Bandage: Plaster of Paris (POP), gauze with gypsum, approx. 10-15cm x 2-3m, rapid setting, each roll in protective airtight wrapping, pack of 12</p> <p>Bandage: Stockinette (Jersey), 100% cotton, unbleached, tubular without seam, plastic wrapping – 5cm x 20-25m roll – 10cm x 20-25m roll – 15cm x 20-25m roll</p> <p>Cotton wool 1kg, see p115</p> <p><i>Plaster shears (POP shears), serrated lower end, curved to side, with or without flattened probe end, SS, approx. 16-24cm, e.g. Bohler</i></p>	<p>At least 1 pack</p> <p>At least 1 roll of each size</p> <p>At least 1 roll</p> <p>At least 1</p>	<p>POP for partial or complete immobilisation or to support a part of the body. Follow manufacturer's instruction for use. POP is fast setting. Soaking temperature warm water 20-25°C. Drying time approx. 24-48 hours. Store in a dry place. On the plaster write the date it was applied and time needed for fracture to heal. Do not use 'damp rolls'. Do not get the cast wet.</p> <p>Tubular bandage for protecting the skin under a POP. When applying make sure it is not too tight, does not fold, is at least 5mm longer than the plaster at both ends. Look for bandage with good resistance to laddering. Plastic wrapping protects against humidity.</p> <p>At least 5mm thick cotton padding should cover all bony parts and skin folds.</p> <p><i>Used for cutting POP (opening or removing a plaster).</i></p>
<b>Set of splints</b> 	<p>Multipurpose splint (for arms and legs):</p> <ul style="list-style-type: none"> <li>– Splint, semi-rigid lattice, wire type, epoxy coated steel, e.g. Cramer, approx. 8 x 60cm and 15 x 10cm</li> </ul> <p>OR</p> <ul style="list-style-type: none"> <li>– Splint, inflatable, vacuum type, vinyl coated, lightweight, set of 3 splints</li> </ul>	<p>At least 1 of each</p> <p>1 set</p>	<p>For immobilising and supporting fractures before sending patients to hospital. Could be constructed locally from wood or bamboo sticks held together by strings.</p>
<b>Back board</b>	With straps to keep the patient in place	At least 1	For transporting back injuries. Can be constructed locally from wood.
<b>Airway</b> (oropharyngeal) 	<p>Semi-rigid, soft rubber with hard plastic insert, sterilisable, e.g. Guedel</p> <p>Sizes:</p> <ul style="list-style-type: none"> <li>– Infant (53-55mm)</li> <li>– Child (62-69mm)</li> <li>– Adolescent (67-86mm)</li> <li>– Adult (82-96mm)</li> </ul>	At least 1 of each size	Used to keep airway clear by preventing blockage by the tongue. Do not use unless trained to do so.

Item	Specification	No. required	Remarks
<b>Resuscitation bag</b> (Ambu bag)	<p>Made up of 3 parts:</p> <ul style="list-style-type: none"> <li>– Bag: hand operated (manual), self-inflating, black rubber bag, with patient valve and connector (inlet valve) for oxygen or anaesthetic gases</li> <li>– Non-return valve</li> <li>– Set of face masks (anaesthesia masks), transparent plastic dome, latex cuff-moulded shell and inflatable with or without hook ring, sterilisable</li> </ul> <p>Sizes:</p> <ul style="list-style-type: none"> <li>– Infant: (0 newborn; 1 older infant)</li> <li>– Child (2)</li> <li>– Adult (4)</li> </ul> <p>Carrying case</p>	1 self-inflating bag and 1 of each size set of face masks	<p>Do not use unless trained in procedure. Manual resuscitator used to deliver air and assist breathing in cases of respiratory distress. Self-inflating bag refills because of elasticity.</p> <p>Make sure the mask is the right size to connect to the valve on the bag (22 or 15mm) and provides a good seal with the face. A well-fitting mask leaks less air. Mask should cover the chin, mouth and nose. Before buying, check bags are easy to assemble/take apart, and bags and masks are easy to clean, disinfect and sterilise to prevent cross infection. Choose quality equipment that will not fail when needed.</p>

### Splint Cramer

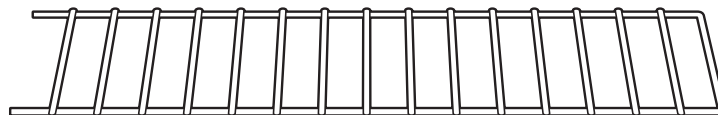



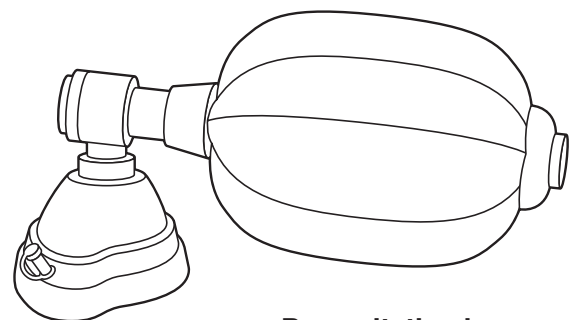
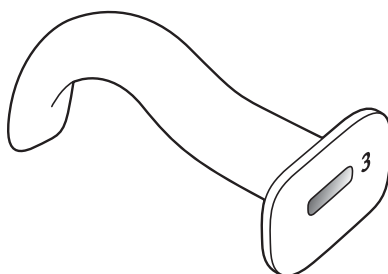

### Airway - Geudal



**Resuscitation bag with face mask**

## Eye care

This sub-section describes the supplies, equipment and essential drugs required for health workers to provide primary eye care. Primary eye care includes promotion of eye health, screening to identify children with visual problems, e.g. at school or in immunisation clinics, prevention, diagnosis and treatment of simple conditions, and referral of disorders and conditions that may lead to 'avoidable' visual loss.

Item	Specification	No. required	Remarks
 <b>Eye test charts</b> (visual acuity chart, vision testing chart, optotypes)	Snellen chart with letters of alphabet for the literate and E chart for the illiterate, washable vinyl plastic card, marked both in feet and metres, approx. 28 x 54cm with eyelet on top for hanging up	At least 1 of each for the health facility and for outreach	Can be bought or locally made and designed to meet local needs. Test is performed at a distance of 6m from the chart, vision in both eyes is checked separately by covering each eye in turn. Rough methods of checking vision range from counting number of fingers to seeing light.
<b>Torch</b>	Examination penlight (standard or heavy duty) 2 batteries 1.5V  OR Pocket torch with 2 batteries 1.5V  Spare: batteries and bulbs	At least 1 per worker carrying out examinations	For examining the eyes. Alternatively, use ordinary flashlight or otoscope (see px).
 <b>Magnifying lens</b>	Handheld, aluminium body, two plano convex lens, glass protected, magnifications either X8 or X10, diameter 1.7cm	At least 1 for the health centre and 1 for outreach	For detailed examination of the eyes for foreign bodies. Folding magnifier (plastic) or binocular (magnifying) loupe with headband, which free the hands, may be used instead.
 <b>Eye pads</b>	Approx. 8 x 6cm, oval shaped, non-woven cotton, either: – Sterile single units, individually packed  OR – Non-sterile, approx. 108 per pack	At least 100 single units  1 pack	Make sure the eye is closed before eye pad is applied. Pad helps to reduce discomfort and promote healing by stopping the eyelid moving over the injured part. Infected eyes should not be covered. Can be made locally using cotton wool placed between 2 pieces of gauze and cut to oval shape approx. 8 x 6cm.
 <b>Eye shield</b>	Approx. 8cm diameter, white, plastic, marked left and right for either left or right eye	At least 6 of each	Used for protecting the eye following penetrating eye injury. The shield allows the eye to open and close. Must be washed before being reapplied. Can be locally made using thin cardboard or old X-ray film.
 <b>Epilation forceps</b>	Forceps, dissecting, epilation, approx. 9-10cm, SS: – Straight end, e.g. Douglas  OR – Angled end, e.g. Whitfield  OR – Round end, e.g. Beer	At least 2	Essential in trachoma endemic areas. Forceps are used to remove inturned (ingrowing) eyelashes. Refer patients with inturned eyelashes to the nearest eye service for surgery. Without surgery inturned eyelashes will continue to grow and irritate and cause damage and blindness. Cutting the eyelash does more harm than good, making the lash stronger and more irritant.

Item	Specification	No. required	Remarks
<b>Teaching materials</b>	Colour slides and text sets of common eye problems, text books	At least 1 set	see p128
<b>Bandages</b>	Gauze, 5cm x 2.5-5m, see p115	At least 1 pack	For securing eye pads and eye shields.
<b>Adhesive tape</b>	see p116	At least 2 rolls	For securing eye pads and eye shields. Put the tape across the corners (not across the centre) of the eye, from forehead to cheek.
<b>Cotton buds</b> (Q tips)	see p64	At least 1 pack	For cleaning eyelids and everting the upper eyelid.
<b>Measuring jug</b>	see p65	At least 1	For washing the eyes. Alternatively use a cup.
<b>Essential drugs</b>			
<b>Eye ointments</b>	Tetracycline 1%, 5g tube	At least: 1 tube per patient	Best local treatment for red eyes (conjunctivitis), trachoma, corneal ulcers, eye injuries. Follow national treatment guidelines. Use as prophylaxis to prevent eye infections in newborns (apply within 1 hour of birth). Ideally, each patient should have their own tube, and a separate tube for each infected eye. Care should be taken to avoid eye dropper and tube contact with eyelids and lashes.
<b>Eye drops</b>	Chloramphenicol 0.5%	1 bottle per patient	Broad spectrum antibiotic for topical use in eyes. For treating chronic redness and itching, e.g. irritation from dust and allergies. Ideally, each patient should have their own bottle of eye drops. Eye drops have a shorter life than ointments and, if possible should be kept in a refrigerator at between 2-8°C.
<b>Vitamin A</b>	Capsules 200,000 IU, 1000 capsules per pack	1 pack	Used to treat children with vitamin A deficiency, measles and malnutrition, and to prevent vitamin A deficiency in communities where this problem is common.

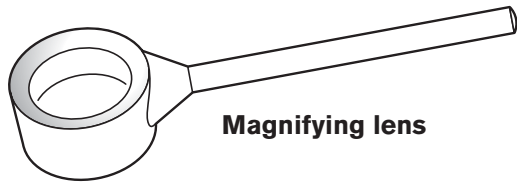

**Magnifying lens**

**Eye pads**

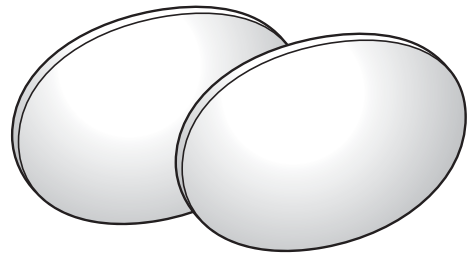

**Eye test chart**

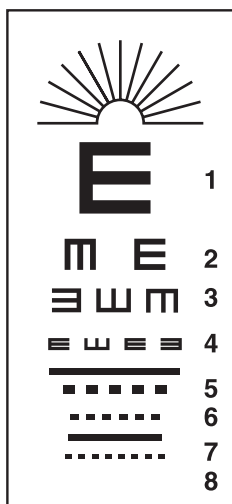

**Eye shield**

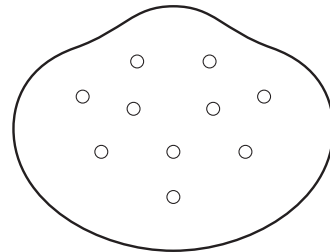

**Forceps epilation  
- round**



**Forceps epilation  
- straight**



**Forceps epilation  
- angled**



## Health education and promotion

This subsection describes the supplies and equipment required for health workers to carry out health education and promotion activities at the health centre and in the community. Using a mix of materials and methods, including those that do not need any teaching aids i.e. story telling, drama and songs, is most effective. When selecting materials, remember that they should be: acceptable to the community's culture and beliefs; appropriate for the local level of literacy; easy to understand; use local terms and words and show familiar situations; simple and convey one or two ideas at most; and relevant and support your message.

Item/Specification	Quantity	Remarks
<b>Chalkboard, chalks and board cleaner</b>	At least 1 chalkboard 1 box each of assorted coloured and white chalk. At least 144 sticks per box  1 board cleaner	Chalkboards, flipcharts and overhead projectors are visual aids used to display notes, pictures, words and diagrams. They are useful for educating small groups. People usually remember images more easily than words, and visual aids can add impact to your message. You can repaint old chalkboards with special blackboard paint or make your own permanent or portable chalkboards. Permanent chalkboards can be made by plastering a smooth surface onto a wall, approx. 1 m x 1.5m. Plaster is made by mixing four parts sand and one part cement. When the plaster is almost set, smooth carefully with a trowel and cover the wall with damp sacking or plastic to allow it to dry slowly, preventing cracking. Leave for several days to dry completely before painting. Portable chalkboards can be made from pieces of plywood. Cut a piece of wood into 2 halves and hinge together (using either metal hinges or a strip of strong cloth glued to both halves). One side of the wood is painted to use as a chalkboard. Sand the wood well before painting.
<b>Flipcharts</b>	No. depends on the no. of workers doing health education and range of topics covered.	Wide range available. Flipcharts are a series of posters bound in a set to teach about a particular subject. You can buy these or make your own.
<b>Slide projector, portable, mains and battery (12V) operated, with carriers for 35mm film strips and 35mm slides, mains and battery connecting leads, carry case and spare bulbs (tungsten halogen 12V/50 W)</b>	1 projector and variety of slide sets	Slide projectors can be used to project images against walls, sheets or screens.
<b>Posters (charts), come in a range of sizes and types, e.g. heavy duty paper or plasticised, laminated, wall hanging, mounted or non-mounted</b>	No. depends on the no. of workers doing health education and range of topics covered.	Wide range available. Posters are often available free of charge from national and international agencies and NGOs. Do not leave posters on the wall for too long, because they cease to have an impact after a while. Use posters in local language and replace regularly if possible.



Item	Quantity	Remarks
<b>Flannelgraphs</b> (clothboards) and <b>flannelette, 1m length,            5 colours</b>	At least 1 flannelgraph and 1 set flannelette	Flannelgraphs, also known as clothboards, are boards covered with rough cloth or flannel, or simply a piece of flannel or blanket pinned up on a wall. Figures and pictures can be added, easily moved about or removed from the board. They are useful for telling stories or describing situations that keep changing. Pictures are cut out of flannelette. Alternatively, draw or cut pictures out of magazines, mount on thin cards, glue small pieces of sandpaper on the back of pictures so they will stick to the cloth. You can use portable chalkboard as a flannelgraph by covering it with a cloth.
<b>Picture cards</b> (flash cards)	No. depends on the no. of workers doing health education and range of topics covered.	Wide range available. Picture cards show a series of pictures or messages linked to a special script. Can be used to tell stories or to teach skills step by step. Cards offer flexibility as they are not attached together in a given order so they can be re-arranged to tell different stories or to teach different ideas. Laminated picture cards will be more durable.
<b>Games and models</b>	No. depends on the no. of workers doing health education and range of topics covered.	Various types available. Games and models are very popular training aids, as they make learning fun and enjoyable. They can be bought or can be made using local materials. Use real objects rather than models where possible.
<b>Books</b>	No. depends on the no. of workers doing health education and range of topics covered.	Wide range available. Practical guides and sources of information can be adapted by healthworkers for use in their local situation.

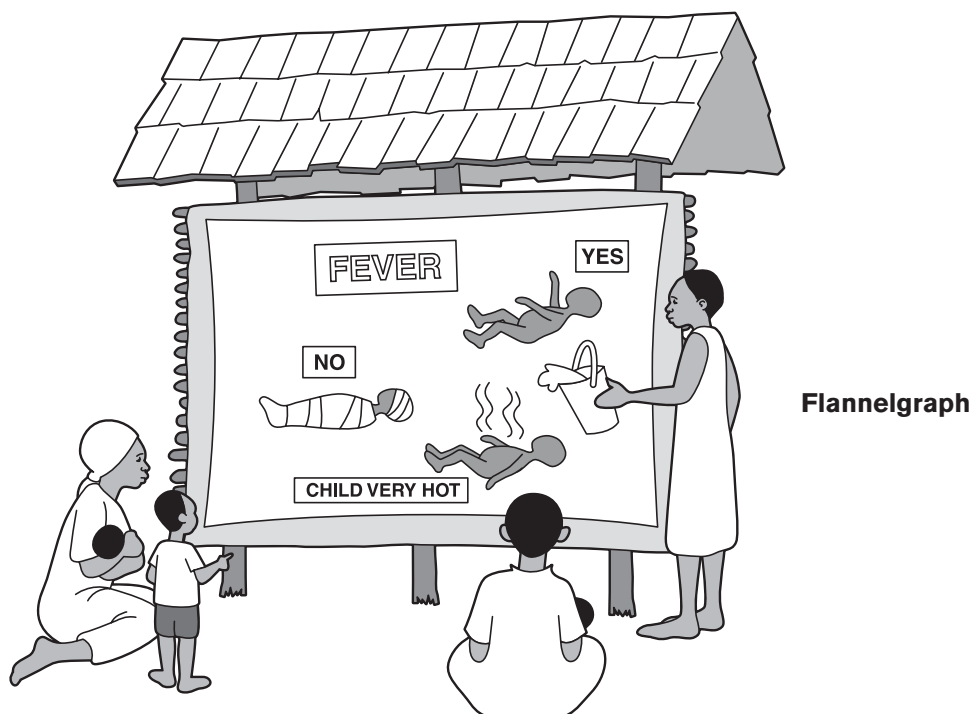

**Flannelgraph**



**Flipchart**



**Picture cards**

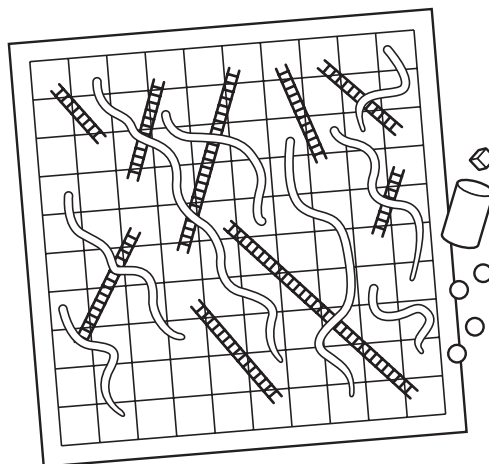

**Games**





Procedure	Item	Specification	No. required	Remarks
Measuring haemoglobin (continued)	DHT	<ul style="list-style-type: none"> <li>– DC/AC adapter, 5V</li> <li>– batteries, 1.5V LR1</li> </ul> Spare: Cuvettes, Batteries	At least 1 pack 3	Last readings can be recalled. In between measurements the meter remains automatically on standby mode. Volume of blood used must be exactly 20ml. (0.02ml) and must be diluted. Diluting fluid (ammonia water 0.04%) can be locally made (Ammonia solution, concentrated 0.2ml and distilled water). Ammonia solution is corrosive and irritating and must be handled with care. Store diluted solution at room temperature in screw cap bottle.
	OR BMS Haemoglobinometer	Battery operated (2 x size C or LR14) meter with built-in illumination from 2.5V 0.5A lamp and measuring range 4-20g in 2g intervals. Graduated scale on side in g Hb/100ml and as % of 13.8g, 14.5g or 15.6g Hb/100ml, dimensions: 170 x 70 x 40mm, weight 225g without batteries, supplied with: <ul style="list-style-type: none"> <li>– saponin (haemolysis) sticks, pack of 100</li> <li>– calibration standard,</li> <li>– blood chamber set, consisting of chamber, cover glass and clip</li> </ul>	At least 1	Visual comparative haemoglobin meter, estimates Hb by matching the colour of patient's sample against a standard. Hb concentration can be read in either g Hb or % g Hb. Requires no dilution or measuring of blood. Particularly suitable for clinics where only a few Hb tests are performed. Saponin-impregnated sticks for lysing the red blood cells to give a clear Hb solution. BMS needs be checked and recalibrated each time batteries or lamps are replaced. Need to order batteries separately as these are not supplied.
	OR HemoCue	Blood Haemoglobin photometer, battery (5 x AA or R6) or mains operated, direct read-out of Hb in g/l or mmol/l, measuring range 0-15.9 mmol/l, factory pre-calibrated, dimension: 15 x 21 x 9cm, weight 700g, supplied with: <ul style="list-style-type: none"> <li>– dried reagent-coated disposable cuvettes, pack of 50 x 4 (200 in total)</li> </ul>	At least 1	Direct read-out meter. Precise and accurate measurements because blood sample does not need to be diluted or measured. A small drop of blood (approx. 10 ml) is drawn into the cuvette by capillary action and mixes with dry reagents automatically. Results in less than 1 minute.

Procedure	Item	Specification	No. required	Remarks
<b>Measuring haemoglobin</b> (continued)	<b>Hemocue</b>	<ul style="list-style-type: none"> <li>– control cuvette</li> <li>– transformer</li> </ul> <p>Spare: Batteries Cuvettes</p>	At least: 1 set 50 x 4 packs	<p>Although convenient, HemoCue meter is costly and replacement reagent-filled cuvettes are expensive. Opened cuvettes are stable for approx. 3 months, unopened for 2 years. Must be kept moisture free. Cuvettes are single use and cannot be re-used.</p> <p>Clean, use, store and maintain Hb measuring devices according to manufacturer's instructions.</p>
<b>Making essential reagents and stains</b>	<b>Balance</b> e.g. Ohaus 5.0.5-10 and Ohaus 5.0.5-MO	<p>Mechanical single beam sliding scale, without separate weights, with:</p> <ul style="list-style-type: none"> <li>– readability of 0.01g</li> <li>– capacity of 50.5g</li> <li>– mechanical damping</li> <li>– zero balance adjustment</li> <li>– scoop or removable pan</li> </ul>	At least 1	<p>Easy to use. Clean, use, store and maintain according to instructions. Use a fine brush or rubber blower to remove dust particles. The accuracy of the balance should be checked regularly as recommended by manufacturer.</p>
<b>Sedimentation of cells, bacteria and parasites in body fluids such as urine, blood and CSF</b>	<b>Centrifuge bench</b> (general purpose)	<p>Hand-operated, steel frame, plastic housing, removable crank, screw clamp for fixing to table, with speeds up to 3000 RPM, 4 place head, 4 plastic buckets with 15 ml tubes (preferably plastic)</p> <p>OR</p> <p>Electric analogue dial controlled, fixed angle, 4-12 places (depending on work- load), rotor holding 15ml capped tubes, with:</p> <ul style="list-style-type: none"> <li>– brushless drive induction motor or brushed drive motor with supply of spare pair of carbon brushes</li> <li>– operating RCF not less than 900xg</li> <li>– fitted timer</li> <li>– safe lid interlock and automatic braking system</li> <li>– instruction manuals e.g. MediSpin analogue, 6 place</li> </ul>	At least 1	<p>Buy hand-operated centrifuges for facilities with unreliable or no electricity supply. Care must be taken in using these (danger of injury from rotating tubes breaking and risk of infection from aerosol/droplets). To reduce these dangers, use capped or stoppered plastic conical tubes instead of glass.</p> <p>Before buying electric centrifuge, check: centrifuge is fitted with safe lid interlock and system for opening centrifuge should power failure occur; that manufacturer has specified both RCF and RPM of which centrifuge is capable; and centrifuge can take capped plastic conical tubes. Also check whether fixed-angle rotors or swing-out. Fixed models are more efficient and less expensive. When ordering electrical model, specify voltage requirements.</p>

Procedure	Item	Specification	No. required	Remarks
<p><b>Sedimentation of cells, bacteria and parasites in body fluids such as urine, blood and CSF</b> (continued)</p>	<p><b>Centrifuge</b></p>			<p>Before ordering centrifuge tubes, check which tubes are recommended for use by the manufacture. When ordering, specify type, bottom shape, maximum RCF, length and diameter, capacity, graduate or not, with bung or cap (attached or separate) or without. Make sure caps and bungs are not loose fitting and do not cap tubes with cotton plugs (loose caps/bungs and cotton wool plugs will be forced down into the tube during centrifugation).</p>
<p><b>Power supply</b> (alternative to mains or generator)</p>	<p><b>Battery</b></p>	<p>12V, lead-acid rechargeable battery, vented (standard) or sealed</p>	<p>At least 1</p>	<p>Lead batteries are useful when power is needed and continuous reliable supply of electricity is not available. These batteries can be used to supply any item that runs on 12V, e.g. refrigerator. All batteries must be charged regularly but Vented have a longer life and require less rigid charge cycle control than Sealed. Recharge battery as soon as possible after discharge (can be re-charged from mains supply or car). Leaving the battery in a discharged state for long periods will damage and shorten its life. Repeated overcharging will also cause battery damage and failure. Vented batteries may be supplied dry and must be filled with electrolyte (battery acid) before use. Keep batteries upright, off the floor, in a secure, dry, cool place and away from direct sunlight. Check acid level regularly, at least monthly. If low, top up with distilled water and in emergencies clean rainwater but not tap water. (Acid levels fall as water evaporates, so water must be replaced and not battery acid). Keep a record of the amount of water added.</p>



## Supplies and minor equipment

The range and quantities of supplies required will depend on the type and number of tests being performed. Many general laboratory supplies are made of glass or plastic. Reusable and sterilisable plastic supplies are recommended as they are less expensive, safer to use, more durable and easier to transport.

Item	Specification	No. required	Remarks
<b>Microscope slides</b>	Approx. 1mm thick, plain or frosted end, 76 x 26mm, pack of 100	At least 2 packs	Slides with frosted ends are recommended. Label frosted ends in pencil. Before use, check slides are clean and free from damage and grease. Discard slides that are scratched, chipped or discoloured. Slides from TB smears should be discarded and never re-used.
<b>Cover glasses</b> (microscope cover glasses)	Glass, rectangular, 20 x 20mm, no. 1½ thickness, packed in plastic hinged box, pack of 200	At least 10 packs	Handle with care, easily breakable. For routine work no. 1½ are recommended. The larger 22 x 22mm cover glasses are used to preserve microscope slides. If ordering specialised cover glasses, e.g. for counting chamber, state purpose not size.
<b>Micro-pipettes</b>	Glass 20ml (0.02ml)	At least 20	Used for collecting capillary blood, measuring haemoglobin and white cell count.
<b>Pipettes</b>	Plastic, graduated, 1ml, 5ml and 10ml	At least 5 of each size	For measuring reagents and fluid specimens. Polypropylene pipettes are more chemically resistant and durable than polystyrene ones.
<b>Pasteur pipettes</b>	Glass, disposable, 150mm length, unplugged, non-sterile, pack of 150  PVC teats approx. 46 x 15mm with 7mm bore	At least 1 pack  At least 3	For dispensing specimens and reagents.
<b>Bulb pipettes</b> (pastettes)	Plastic, bulb, graduated or non-graduated 1ml and 3ml	At least 20 of each size	For dispensing specimens and reagents. Cannot be sterilised, but can be washed and disinfected and re-used several times for work not needing sterile pastettes.
<b>Pipette fillers</b>	Capillary and micropipette fillers, e.g. thumb wheel aspirator  <i>AND</i> Pipette filler, e.g. green 10ml Pi-pump 2500, plastic, thumb wheel, release valve, fitted with anti-slip tapered end, suitable for use with pipettes of 1-10mls	At least 2  At least 1	Equipment for 'safe' pipetting and dispensing. Pippetting by mouth is dangerous because of the high risk of infection from accidental swallowing of contaminated specimens and chemical reagents. Pi-pump 2500 offers precision filling and dispensing, the thumb wheel for controlled pipetting and release valve for rapid dispensing.
<b>Staining rods</b> (staining rack)	SS, adjustable length rods in holders with levelling screws, minimum length 290mm	At least 1	Rods fit across the sink or staining container. When staining, empty the containers regularly to reduce the risk of fire from flammable chemicals.



Item	Specification	No. required	Remarks
<b>Staining jar</b> (Coplin)	Plastic, with grooves, screw cap, holds up to 10 slides (76 x 26mm), vertically, back to back.	At least 2	Staining jar, also available in glass. Immersing slides in containers of stain can lead to contamination of stains and transfer of organisms from one smear to another. When staining, empty the containers regularly to reduce the risk of fire from flammable chemicals. Alternatively, use staining rods.
<b>Slide draining rack</b>	PVC or other plastic block with angled slots to hold 12 or more slides	At least 1	To allow slides to air-dry after staining. Slides should not be blotted dry with filter or blotting paper.
<b>Slide box</b> (microscope slide box)	Plastic or wooden box with lid and numbered slots to take 50 or more slides, and index	At least 1 At least 5	Needed for storing slides. Check the lid is close fitting. For transporting slides safely.
<b>Slide mailer</b> (slide transport box)	Plastic, leakproof, reusable box, for approx. 2 or more slides	At least 5	For transporting slides safely.
<b>Test tubes</b>	Glass, reusable, heavy walls, round bottomed, heat resistant: 75 x 12mm 100 x 13mm 150 x 16mm  Cork or red rubber stoppers, tapered, assorted sizes	At least 50 At least 100 At least 50  At least 20	Order test tubes by diameter and length. Different sizes are needed to carry out routine haematology, microbiology and clinical chemistry tests. Test tubes are available in variety of lengths and diameters, bottom shapes (round or conical), materials (glass and sterilisable or non-sterilisable plastic), and types (graduated or non-graduated, capped or non-capped).  To stopper (plug) test tubes. Assorted sizes to fit different diameter test tubes. When ordering, specify the test tube diameter. Alternatives include sterilisable rubber stoppers made from translucent silicone rubber.
<b>Rack test tubes</b> (test tube rack)	Plastic or nylon coated or aluminium rack, to hold 12 or more tubes, suitable for test tubes length and diameter: 75 x 10-13mm 100 x 11-13mm 125-150 x 15-20mm	At least 1 of each size	Racks should be bought based on test tube lengths and diameters, and no. of test tubes to be held. Racks should be made from materials that can be easily cleaned and disinfected.
<b>Rack drying for laboratory ware</b> (drying rack)	Peg rack, free standing support, epoxy coated, 24 pegs each 8cm long, approx. 41 x 30cm	At least 1	Locally made wall hanging board with wooden pegs is a good alternative.
<b>Tray</b>	Plastic, rectangular, approx. 20 x 15 x 5cm  <i>AND</i> approx. 25 x 20 x 6cm	At least 1 of each size	General purpose deep tray for holding specimen containers. Alternatives can be locally made.

Item	Specification	No. required	Remarks
<b>Universal containers</b> (bottle universal)	<p>Glass, approx. 28ml capacity, wide-neck (mouth), aluminium screw cap with rubber liner</p> <p><i>AND</i> Plastic, sterile, disposable, wide-neck, leak-proof cap, transparent, with or without labels, approx. 27-30ml and 60-150ml capacity</p> <p><i>AND</i> Sterilisable plastic, reusable, wide-neck, leak-proof cap, with or without labels, approx. 60-150ml capacity</p>	At least 200, mixed sizes and types	<p>Universal containers for multiple use including sputum, urine, stool etc. Containers must be sterile if sample is to be cultured. For all other samples the containers should be clean, dry and free from any traces of disinfectant. Check caps are leak-proof. Make sure you have enough sterilisable spare caps and liners for reusable bottles. Containers are available with and without labels. Transparent plastic allows easy sample viewing.</p> <p>Sputum: whenever possible use disposable containers.</p> <p>Infants' urine: as an alternative to universal containers, use clean plastic bags or infant self-adhesive urine bags, 100mls. Fix the bag in place and remove immediately after urine has been passed to avoid contamination.</p>
<b>Faecal container</b> (stool container, universal container)	Plastic, sterile, disposable, transparent with sample spoon, leak-proof cap, approx. 30ml capacity	At least 100	Alternatively use universal containers described above. Whenever possible, use disposables. If reusable containers are used, these must be disinfected and rinsed thoroughly before re-use.
<b>Basin</b> (bowl)	Plastic, rectangular, flat bottom, 12l	At least 2	General use from collecting to washing items. Alternatively, use round basins.
<b>Brushes</b>	<p>Bottle: Nylon or bristle head on galvanised or copper wire, with tufted end, size of head 75-100mm, overall length 350-400mm</p> <p><i>AND</i> Test tube: Nylon or bristle head on galvanised or copper wire, either with cotton tip, tufted or fan end, overall length from 185-300mm, head diameter approx. 12-50mm</p>	<p>At least 2 of different sizes</p> <p>At least 1 small approx. 12mm 1 medium approx. 18mm 1 large approx. 50mm</p>	When ordering test tube brushes, specify test tube bore (mm) to be used with. This will make sure you have the right sized brushes for your needs.
<b>Bottle bijou</b>	<p>Glass, with aluminium cap and rubber liner, approx. 5mls</p> <p>Spare: caps and liners</p>	At least 5	Sterilisable. Used to transport swabs in transport media.
<b>Bottle reagent</b>	<p>Glass, narrow neck with leak proof screw cap, size: 250ml, 500ml, 1000 ml</p> <p><i>AND</i> Glass amber, narrow neck, leak-proof screw cap, size: 250ml, 500ml, 100ml</p>	<p>At least 10 x 250ml + 500ml 2 x 1000ml</p> <p>At least 10 x 250ml + 500ml 2 x 1000ml</p>	Brown, for storing light sensitive reagents and stains. Alternatively use good quality plastic bottles. Caps that do not need liners are preferred. Caps should be resistant to all commonly used chemicals and sterilisable.

Item	Specification	No. required	Remarks
<b>Bottle dropping</b>	Glass amber, PVC teat and stopper, 60ml	At least 1	To dispense stains and reagents. Translucent plastic bottles are suitable for physiological saline and immersion oil, and amber bottles for iodine. To avoid evaporation or deterioration of stains and reagents, use bottles which can be closed between use.
	<i>OR</i> Glass amber, TK, with groove in stopper, 60-100ml capacity	At least 1	
	<i>AND</i> Plastic translucent, leakproof screw cap with pouring spout that can be closed when not in use, 100ml capacity	At least 3	
<b>Bottle washing</b> (wash bottle)	Plastic with screw cap and dispensing tube moulded in 1 piece, 250ml or 500ml capacity	At least 4	Dispensing water for washing smears during staining.
<b>Beakers</b>	Plastic, short form, graduated with spout 100ml, 250ml, 500ml	At least 2 of each size	For general use. There is wide variety of beakers of different capacity, shape (tall, short, conical, straight, tapered or sloping side), material (glass, plastic) and form (transparent or translucent). Decide upon your needs and order accordingly.
	<i>AND</i> Glass, short form, graduated with spout, 500ml	At least 1	
<b>Measuring cylinders</b>	Plastic, sterilisable, clear graduations with spout, 25ml, 100ml, 250ml, 500ml	At least 2 of each size	For measuring and preparing reagents.
<b>Funnels</b>	Plastic, preferably ribbed, diameters: 35-45mm 90-100mm 140-160mm	At least 2 At least 2 At least 1	For filtering stains and reagents. Ribs to prevent air locks and for rapid filtration.
<b>Petri dish</b>	Plastic, reusable, approx. 90mm diameter	At least 2	To use as a damp chamber, e.g. for sickle cell, platelet count.
<b>Spatula</b>	Plastic or SS, one end is flat the other spoon shaped, 120-180mm length	At least 1	General purpose spatula.
<b>Wire loop</b>	Nickel-chromium wire loop with handle, loop diameter approx. 2mm (holding 1/500ml), wire length no longer than 60mm, reusable	At least 1	Inoculating loops to inoculate culture media. Alternatively use disposable wire or plastic loops or make your own wire loops. The length of wire from the loop holder should be short (60mm) and the loop itself should be small (2mm diameter).
<b>Tourniquet</b>	Elasticated arm band with velcro fastening ends	At least 1	Applied to enable veins to be seen and felt. Alternatively use 36-75mm, soft flexible rubber tubing.

Item	Specification	No. required	Remarks
<b>Lancets</b> (prickers)	SS with fine point, disposable, sterile, each individually wrapped, box of 100	At least 5 packs	Fine point for piercing the skin for capillary blood collection.
<b>Counter tally</b> (hand counter)	Plastic or metal cased, mechanical, range 0-9999, with zero reset	At least 1	For counting blood cells. Zero after each count.
<b>Haemocytometer</b> (counting chamber) (e.g. Improved Neubauer Haemocytometer)	Double cell metallised 'bright line' counting chamber with improved neubauer ruling, cover glasses  Spare: cover glasses paired for double counting chamber	At least 1	For counting white blood cells and platelets. Available as non-metallised. Metallised preferred as they give better contrast between the rulings and the background, which makes it easier to count blood cells.  Avoid purchasing haemocytometer sets containing bulb pipettes, mouth piece and tubing because it is not possible to obtain reliable mixing of blood and diluting fluid inside the bulb pipette and also because mouth pipetting is unsafe practice. A capillary filler should be used to aspirate and dispense the blood. Use specially designed cover glasses. Ordinary ones are unsuitable and must not be used.
<b>Spirit lamp</b> (alcohol burner)	Metal spirit burner with wick and screw cap, approx. 120-130ml  Spare: wick	At least 1  At least 10	Alternatives are LabyGaz bunsen burner or glass spirit lamp.
<b>Vaccine carrier</b>	see p100	At least 1	Keep 1 vaccine carrier for transporting specimens only. Alternatively, for transporting a few specimens, use a wide-neck, shatterproof, plastic thermos flask containing ice cubes.
<b>Syringes</b>	Disposable, 2.5ml and 5ml, see p79	At least 50 x 2.5ml 10 x 5ml	For collecting venous blood. A sterile syringe should be used each time. Alternatively use plastic sterilisable syringes.
<b>Needles</b>	Disposable, 21G and 23G, see p79	At least 100 of each size	For collecting venous blood. A sterile needle should be used each time.
<b>Sharps disposal system</b>	see p81	At least 1	Keep close to place where sharps are produced.
<b>Water filter</b>	see p66	At least 1	Filtered water for preparing reagents.
<b>Clock</b>	see p66	At least 1	For timing staining reactions etc.
<b>Measuring jug</b>	1l, see p65	At least 1	Cheaper alternative to 1000ml cylinder.
<b>Forceps</b>	Dissecting, see p117	At least 2	For general use.
<b>Dressing tray</b>	see p117	At least 2	For general use.

Item	Specification	No. required	Remarks
<b>Gallipots</b>	see p118	At least 2	For general use.
<b>Kidney dish</b>	see p117	At least 2	For general use.
<b>Scissors</b>	Dressing scissors, see p118	At least 1	For general use, e.g. cutting gauze, tape.
	<i>AND</i> General scissors, see p66	At least 1	For general use, e.g. cutting paper.
<b>Sterilising equipment and supplies</b>	see p87	At least 1 set	For sterilising reusable items.
<b>Boiling equipment and supplies</b>	see p90	At least 1 set	For high level disinfection by boiling of reusable items.

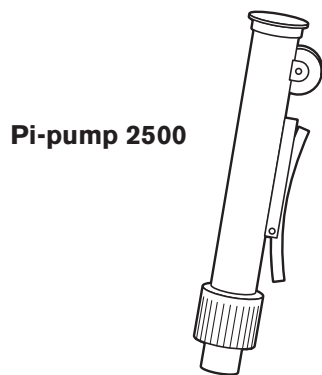

**Pi-pump 2500**

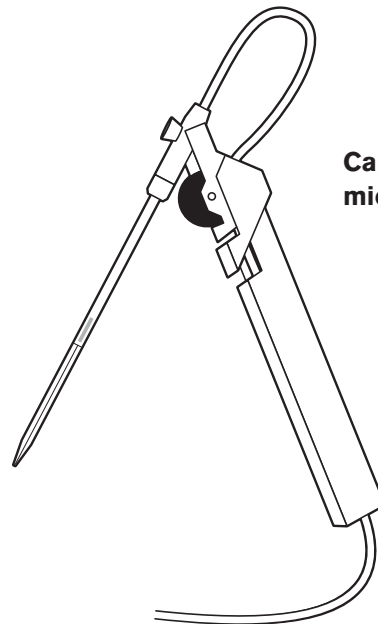

**Capillary and micropipette filler**

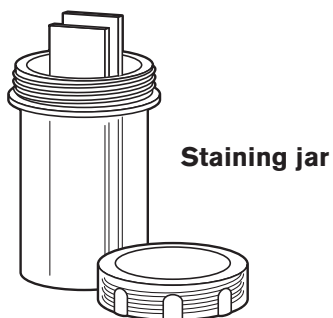

**Staining jar**

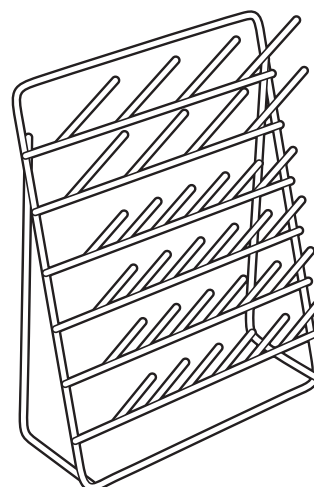

**Drying rack for laboratory ware**

**Universal container**



**Faecal container**

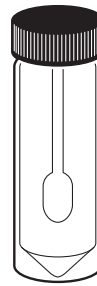

**Bottle dropping - TK**



**Bottle dropping -amber**



**Bottle dropping with spout**

**Lancet**

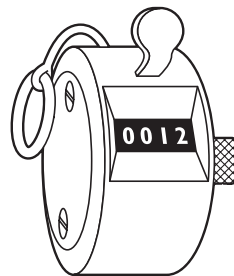

**Counter tally**



Item	Specification	No. required	Remarks
<b>Diamond pen</b>	Glass marking diamond pen with aluminium handle	At least 1	For writing and etching on glass. Handles made from wood tend to break.
<b>Wax pencil</b> (chinagraph, grease)	Grease pencil, black, round, wood encased, unsharpened	At least 1	For writing on glass slides, plastic etc. Also available in colours other than black.
<b>Black lead pencils</b>	Pencils with medium or soft lead	At least 1	For labelling the frosted end of glass slides. Pencil marks, unlike biro and grease pencil marks, will not be washed off during the staining process.
<b>Marker for slides</b>	Permanent marker, waterproof, fine-medium tip, black ink	At least 1	For permanent labelling of bottles and slides. Check the ink is resistant to solvents and most chemicals.
<b>Request forms</b>	National or WHO adapted for local use	1 per requested test	Should be as simple and clear as possible, with patient details including diagnosis and treatment, test required and date and time of specimen collection.
<b>Registers</b>	A4, hardback, lined	At least 1	For recording different laboratory tests and results. May need multiple registers depending on the number and types of tests being performed.
<b>Plus: Applicator sticks Cotton wool Gauze swabs Tape Gloves examination</b>	see p64  1 kg, see p115 Non-sterile, 100 per pack, see p116 see p116 Medium, non sterile, see p64	At least 1 pack  1 1 pack  6 rolls 1 pack	Applicator sticks to make sterile cotton wool swabs for collecting specimens. Tape to tape dressings, and to tape around the neck of specimen to ensure a complete seal (when transporting or mailing specimens).

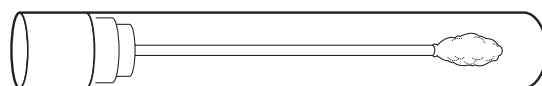

**Transport swab**



## Reagents and stains

Health facilities can make their own reagents and stains, although some are too complex to make or require chemicals that are difficult to obtain, expensive or only available in large quantities. For many health facilities, it may be easier and more economical to buy prepared reagents and stains, or use reagent strips or rapid kits. This sub-section provides information about essential tests. For advice about quantities, you should ask the district laboratory officer. Remember the following points:

- Non-clinical chemistry reagents and stains can be used with boiled or filtered tap or rainwater if distilled or de-ionised water is unavailable.
- Store reagents and stains at room temperature in clean containers with leakproof, airtight screw caps and stoppers.
- When selecting rapid tests, consider price, availability, clarity of instructions, size, format, stability, storage requirements and expiry dates.

Test	Method	Specification	Remarks
<b>Stool</b>	<b>Microscopy: Saline</b>	Test 1: 0.85% Sodium chloride (physiological saline)	Saline used for examination of motile parasites, e.g. cysts, red cells, pus cells. Iodine used for identifying cysts in stools. Eosin provides a pink background, which makes it easier to see the parasites. Reagents may be locally prepared. e.g. Dobell's iodine (Potassium iodide, iodine and distilled water), Eosin (Eosin and distilled water). Store both in brown reagent bottles and in the dark. Label iodine as harmful. Prepared iodine reagents are stable for several months, eosin indefinitely.
	<b>Eosin</b>	Test 2: Eosin	
	<b>Iodine</b>	Test 3: Dobell's iodine	
<b>Urine</b>	<b>Test strips</b> (reagents, dipsticks)	Selected fields, e.g. protein and glucose (Uristix, Ames )	Simple, rapid, reliable and easy to use. Several kinds commercially available. One strip can contain fields to test for one, two or several different substances (fields) in the urine. Buy strips according to your test needs. Using the one strip to test for two to three fields reduces the number of necessary tests and is more economical. However, strips containing more than a few tests (multiple) are considerably more expensive than the simple two or three field strips (selected fields). Strips can be split lengthways to get twice the number of tests and halve the costs. Protein and glucose are the essential urine tests. Protein and glucose test strips are recommended. Alternatively, test for protein using Sulphosalicylic acid 20% test, and for glucose using Benedict's test. Store test strips and reagents in a dry and cool place because of poor stability (and inaccurate results) in heat and humidity.
		OR Protein, glucose and pH (Combur, Combistix)	
		OR Multiple test strip measuring pH, protein, glucose, blood, ketones (Labstix, Combur 9, Multistix)	
	<b>Microscopy: Wet preparation</b>	No reagents required	Wet preparation for cells, casts, parasites, crystals and amorphous salts.
	<b>Gram stain</b>	0.5% Gentian or Crystal violet  AND Lugol's iodine  AND Acetone-alcohol decoloriser  AND Dilute Carbol fuchsin or neutral red	Gram stain used to identify and classify bacteria by their Gram reaction. Gram positive bacteria stain dark purple with crystal violet and are not decolorised by acetone. Gram negative bacteria stain red, as they are decolorised.

Test	Method	Specification	Remarks
<b>Malaria</b>	<b>Pre-staining thick and thin films</b>	<ul style="list-style-type: none"> <li>– Thick films: no fixing</li> <li>– Thin films: fix with Absolute Methanol (methyl alcohol) or Ethanol (ethyl alcohol)</li> </ul>	<p>Thick film for detection of parasites and thin film for confirmation of plasmodium species. Thick and thin films can be made on the same slide or separate slides. Thin films must first be fixed then stained.</p>
	<b>Staining thick and thin films</b>	<p>Field's stain</p> <ul style="list-style-type: none"> <li>– Thick film: Field's stain A and Field's stain B (no dilution of either stain)</li> <li>– Thin film: Field's stain B ('B' diluted 1:5 in buffered water pH 7.1-7.2) and Field's stain A</li> </ul> <p>OR</p> <p>Giemsa stain</p> <ul style="list-style-type: none"> <li>– Thick and thin film: Giemsa stain and buffered saline pH 7.1-7.2 (preferred) or buffered water pH 7.1-7.2</li> </ul>	<p>Field's stain is a water based Romanowsky stain and Giemsa is an alcohol based Romanowsky stain.</p> <p>Field's staining is a more stable, rapid and economical method than Giemsa staining. Giemsa method, however, is useful for batch staining of large numbers of thick and thin films and staining films that are several days old. When using Field's stain, fix and stain thin film before the thick film.</p> <p>Malaria blood films are best prepared directly from capillary blood.</p>
<b>Pus/ exudates</b>	<b>Gram Stain</b>	See Urine section, p145	Testing for bacteria.
<b>TB</b>	<b>Ziehl-Neelsen stain (Zn technique)</b>	<p>70% Alcohol(70% ethanol or 70% methanol)</p> <p><i>AND</i></p> <p>Strong Carbol fuchsin</p> <p><i>AND</i></p> <p>3% Acid alcohol</p> <p><i>AND</i></p> <p>0.1% Methylene blue or 0.5% Malachite green</p>	<p>To detect AFB (Acid Fast Bacillus) in sputum smears. Mycobacteria, unlike most other bacteria, do not stain well by the Gram technique. Ready-made Carbol fuchsin stains available. Methylene blue or Malachite green stains the background material, providing a contrast colour against which red AFB can be seen. TB dry smears can be heat fixed, instead of fixing with alcohol. Alcohol fixing is important when sputum is not stained immediately. Alcohol fixer is bactericidal. Label the slide with diamond pen, not lead pencil.</p>
<b>STI</b>	<b>Microscopy: High vaginal swab</b>	<p>Test 1: Physiological saline 0.85%</p> <p>Test 2: 10% KOH Preparation</p> <p>Test 3: Gram stain, see p145</p>	<p>Test 1 to detect C. albicans and T. vaginalis.</p> <p>Test 2 to screen for G. vaginalis.</p> <p>Test 3 to detect C. albicans and S. vaginalis.</p>
	<b>Direct examination of vaginal discharge</b>	No reagents necessary	To test for T. vaginalis.
	<b>Microscopy: Urethral discharge</b>	Gram stain, see p145	To detect N. gonorrhoea (Gram negative diplococci).

Test	Method	Specification	Remarks
<b>STI</b> (continued)	<b>RPR(Rapid Plasma Reagin) test</b>	RPR test kit, pack size: 100, 200 and 500 tests, each kit consists of Venereal Diseases Research Laboratory (VDRL) Carbon Antigen, positive and negative controls, dispensing bottle, needle dispenser, test card, plastic pipette stirrer (disposable), test procedure sheet	Screening test. Non-specific reagin (cardiolipin) test. Test kit detects and quantifies reagin antibodies. Simple, easy to perform and does not require specialised equipment. Results within 10 minutes and can be read with naked eye. Kit is heat sensitive and must be kept refrigerated 2-8°C. All positive tests should be confirmed by other diagnostic procedures. A positive test provides a presumptive diagnosis for syphilis and must be confirmed. Test may become non-reactive in late syphilis. Alternative non-specific tests include: VDRL test, which is read microscopically, and TRUST (Toluidine Red Unheated Serum Test) which is read in a similar way to RPR.
<b>HIV (Human immunodeficiency virus)</b>	<b>HIV antibody test</b>	HIV-1/HIV-2 simple, rapid tests, self-contained kits, visually read with positive and negative controls, e.g. Capillus, HIV CHEK, Determine R, Uni-Gold™ HIV-Recombinant	Used to screen blood, diagnose HIV infection, and carry out research or surveillance. Testing for diagnosis should only be carried out as part of integrated programme offering pre- and post-test counselling and care and support for those diagnosed with HIV infection. Simple/rapid tests are designed for testing individual samples and give accurate results. Depending on the test, results available within 10 minutes to 2 hours. All positive results should be confirmed by other diagnostic procedures. Suitable first line screening tests for low volume testing facilities, emergency settings and situations with limited or no laboratory facilities. The kits range from 20-100 tests/kit, are 'self-contained', and only require blood collection devices, disposable gloves and samples. No microscope necessary. Shelf life from date of manufacture is usually 12-18 months. Order appropriate quantities to meet your needs for around 3-4 months at any one time. Some kits need to be refrigerated.
<b>White cell</b>	<b>White blood cell (WBC) count</b>	WBC diluting fluid  <i>AND</i> EDTA anticoagulant bottle or capillary blood	WBC used to investigate infections and unexplained fevers. White cells are counted microscopically using improved Neubauer Haemocytometer. EDTA bottles may be stored for up to a year at room temperature.
<i>CSF (Cerebrospinal fluid)</i>	<i>Gram stain</i>  <i>White cell</i>  <i>Differential cell count</i>    <i>Total protein</i>	<i>Gram stain, see p145</i>  <i>WBC, as above</i>  <i>Differential cell count: Thin blood film – Field's staining for thin film or Giemsa staining, see p146</i>    <i>Total protein: Trichloroacetic acid (TCA) 5%</i>	<i>CSF used to investigate meningitis. Collected by lumbar puncture. Must only be performed by staff trained in this procedure.</i>           <i>Total protein in CSF can be measured using TCA colorimetric technique: CSF added to TCA solution (TCA + distilled water). Pandy's test (saturated Phenol solution) is an alternative, if it is not possible to measure Total protein. Handle TCA and phenol solutions with care, and label as corrosive.</i>

<b>Test</b>	<b>Method</b>	<b>Specification</b>	<b>Remarks</b>
<i>Sickle cell</i>	<i>Sickle cell slide test</i>	<i>Sodium Metabisulphite 2%</i>	<i>Reducing agent Sodium metabisulphite (also called di-sodium disulphite) is unstable and can be used only on the day prepared (up to 8 hours).</i>
<i>Pregnancy</i>	<i>Dipstick</i>	<i>Rapid 1 step pregnancy test kits, consisting of dipstick with control line or band, test strips in container with cap, packs of 25-100 tests, e.g.Hexagon 1-step (60 tests), 1 Step Pregnancy Test (25 tests)</i>	<i>Extensive range of pregnancy testing kits commercially available. Test kits detect human chorionic gonadotrophin (hCG) in urine. Rapid and simple test, results in 3-10 minutes. Some tests can be stored at room temperature, others must be refrigerated. Some tests can be used to detect hCG in both serum and urine. All positive results should be confirmed by other diagnostic procedures.</i>

## 3.4 Supplies and equipment for community care

This sub-section describes supplies and equipment for health workers providing basic care in the community. Health workers may include community health workers, traditional birth attendants, traditional healers and community carers who are trained, supervised and provided with supplies and equipment by health facility staff. The roles and activities of community-based workers vary. In some countries, their primary role is health promotion and education, in others it includes basic treatment and first aid. For community-based workers to provide an effective service, procedures must be in place to replenish supplies when necessary. The types of supplies and equipment they require will depend on the setting and services that they provide, which may include:

- Screening and identifying cases for referral, e.g. malnourished or non-immunised children, risk screening of pregnant women.
- Treating common conditions, e.g. pain, fever, worms and skin infections.
- Home care and follow up, e.g. for TB patients, people with HIV and monitoring pregnant women.
- Basic surveillance, e.g. reporting births and deaths.
- Community education, e.g. prevention and recognition of common health problems, preparing ORS, encouraging immunisation, promoting malaria control and nutrition education.

Item	Specification	No. required	Remarks
<b>Community Health Worker (CHW) kit</b>	Bag, vinyl, approx. 35 x 20 x 22cm, top opening, lockable buckles, carrying handles, shoulder strap, containing: <ul style="list-style-type: none"> <li>– Scissors dressings, sharp/blunt, see p118</li> <li>– Bottle 1l, see p118</li> <li>– Bottle 100ml, see p118</li> <li>– Bandages gauze, see p115</li> <li>– Cotton wool, see p115</li> <li>– Tape adhesive, see p116</li> <li>– Gauze swabs, non-sterile, see p116</li> <li>– Kidney dish, see p117</li> <li>– Gallipot, see p118</li>   <li>– Plastic sheet, see p64</li> <li>– Soap approx. 100g, see p66</li> <li>– Nail brush, see p64</li> <li>– Thermometer, see p71</li> <li>– Envelopes for tablets, see p77</li> <li>– Register, tally sheets, checklists</li>   <li>– MUAC, see p94</li> <li>– Teaching aids, e.g. flashcards, flannelgraphs, games, see p128</li>   <li>– Towel/cloth, see p106</li> <li>– BirthWeigh scales, see p105</li> </ul>	At least 1 1 2 1 pack 1kg 2 rolls 1 packet  1 1 At least 1 1  1 2 1 packet  1 of each  At least 1 At least 1 of each type  At least 2 At least 1	The kit described here is designed to allow CHWs to provide basic first aid care and treatment. Bag should be large enough to contain all the supplies but small enough to carry. It should also be strong enough for constant use and should be waterproof. Locally made, lockable metal box may be used instead.          Registers are to record activity information, e.g. households visited, children weighed, and to register births and deaths. These help CHWs to do their jobs effectively and help their supervisor. If CHWs are illiterate, use picture records to plan and monitor activities.
<b>TBA kit</b>	see p104	1 kit per trained TBA	Designed to promote good, safe and clean delivery.

Item	Specification	No. required	Remarks
<b>Family delivery kit</b> (clean home delivery kit, safe delivery kit, disposable delivery kit, single use kit)	Sealable plastic bag with: – Soap approx. 100g, see p66 – Applicator stick, see p64 – Plastic sheet approx. 1m x 1m, see p64 – Clean cord ties, approx. 25cm length, see p105 – Gauze swabs, approx. 7.5cm, non-sterile, see p104 – Sterile razor blade, see p104 – Pictorial instructions	1 1 1 3 ties 2 pieces 1 1	Designed to be simple and easy to use by women delivering alone at home or with the assistance of a relative or untrained TBA. They can also be used by trained TBAs. The items in the kit are intended to encourage safe delivery (clean hands and nails, clean delivery surface, clean umbilical cord care), and to decrease the risk of neonatal and maternal mortality from tetanus. Kit contents are disposable and designed to be used only once. A new kit should be used for each delivery. Kits can be provided free of charge, or sold for a small fee, or health workers can encourage pregnant women to prepare their own basic kits. Kit content may need to be adapted to local conditions e.g. you may want to add items such as disposable gloves or a torch. Users and their relatives or TBAs must be trained to use the kits.
<b>Home care kits</b>	Simple Home Based Care (HBC) kit: – Bag, see p97 – Gloves examination, see p64 – Plastic sheet 2m, see p64 – Measuring jug, see p65 – Soap approx. 100g, see p66 – Register – Cotton wool 500g, see p115 – Bandages gauze, see p115  Mobile nursing/medical team: All of the above plus: – Thermometer, see p71 – Sphygmomanometer, see p71 – Stethoscope, single cup, see p71 – Nasogastric tubes, see p78 – Catheter, disposable, see p83 – Torch, see p72 – Gauze swabs, non-sterile, see p116 – Gauze swabs, sterile, see p116 – Dressing pads, sterile, see p116 – Tape adhesive, see p116 – Surgical gloves, 7.5, see p116 – Kidney dish, see p117 – Dressing tray, see p117 – Gallipot, see p118 – Scissors dressing, sharp/blunt, see p118 – Register, treatment charts and forms, referral letters	At least 1 20 pairs 2 1 2 1 1 1 pack  At least 1 1 1 1 of each size 1 of each size 1 1 pack 4 packs 1 pack 2 rolls 2 pairs 2 1 2 1 1 of each	Designed to help community-based workers and families provide care and support for sick patients at home, particularly those with HIV/AIDS and TB. HBC programmes may involve home visits by local volunteers or staff from local health units. HBC kit contents will vary depending on the setting and the activities included in home care support. Home care can include medical and nursing care and treatment, basic hygiene, supervising medication, material assistance, education as well emotional, spiritual and social (welfare) support (e.g. food, clothes, blankets).

Item	Specification	No. required	Remarks
<b>Mosquito nets and net treatments</b>	<p>Mosquito nets: Multifilament (polyester), denier 75-100, mesh 156 inch<sup>2</sup>, rectangular or circular, with loops or rings, coloured or white, treated or untreated nets, size (w x l x h):</p> <ul style="list-style-type: none"> <li>– Family: approx. 190 x 180 x 150cm (sleeps 1 adult and up to 3-4 children under 5 years)</li> <li>– Single: approx. 70 x 180 x 150cm</li> </ul> <p>Treatment: Insecticide for net treatment (e.g. deltamethrin, lambda-cyhalothrin, permethrin):</p> <ul style="list-style-type: none"> <li>– Single dose kits for home treatment: insecticide treatment, gloves, measuring pouch, instructions</li> <li>– Bulk or communal treatment: approx. 0.5-1l bottle, instructions. Additional supplies needed: bowl or basin, gloves, measuring container</li> </ul>	<p>At least 1 family net per family</p> <p><i>AND</i> 1 single net per health centre bed</p> <p>1 initial treatment dose and 6-monthly or yearly re-treatment dose per net</p>	<p>Sleeping under mosquito nets treated with insecticides is a simple, practical method for reducing malaria illness and death, especially in pregnant women and young children. The insecticide kills or deters mosquitoes and other biting insects such as bedbugs and ticks. Many people already have or use mosquito nets. Fewer people know that treatment with insecticide increases the protection against malaria provided by nets.</p> <p>Treated and untreated nets are available. Buying untreated nets and treating them before distribution can help to promote retreatment messages. Nets typically last 3-5 years. Permanently treated nets are being developed by manufacturers and some are now on the market.</p> <p>Insecticide for treating single nets is available in single dose sachets or tablets suitable for home treatment. 1l or 0.5l bottles of insecticide can be used to make up larger quantities of solution for treating larger numbers of nets, e.g. community net treatment sessions. A 1l bottle will treat 50-150 nets depending on the concentration of insecticide formulation and size of net. It is important to buy insecticide suitable for treating nets and not for house spraying. Depending on the insecticide, treatment lasts from 6 months (e.g. permethrin) to 12 months (e.g. lambda-cyhalothrin or deltamethrin), less if washed more than 1 time (permethrin) or more than 3-4 times (lambda-cyhalothrin and deltamethrin). Nets therefore need periodic retreatment.</p>

**Family delivery kit**

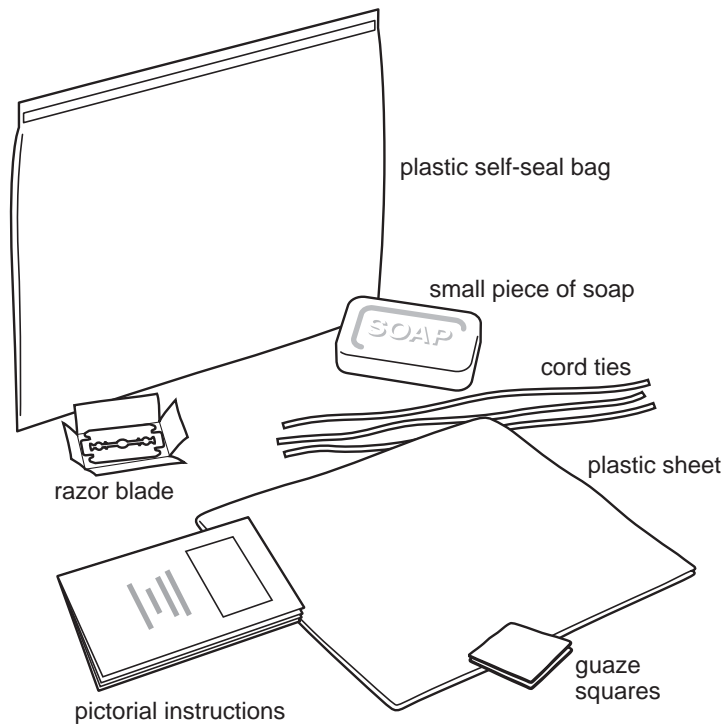

**Mosquito net - rectangular**

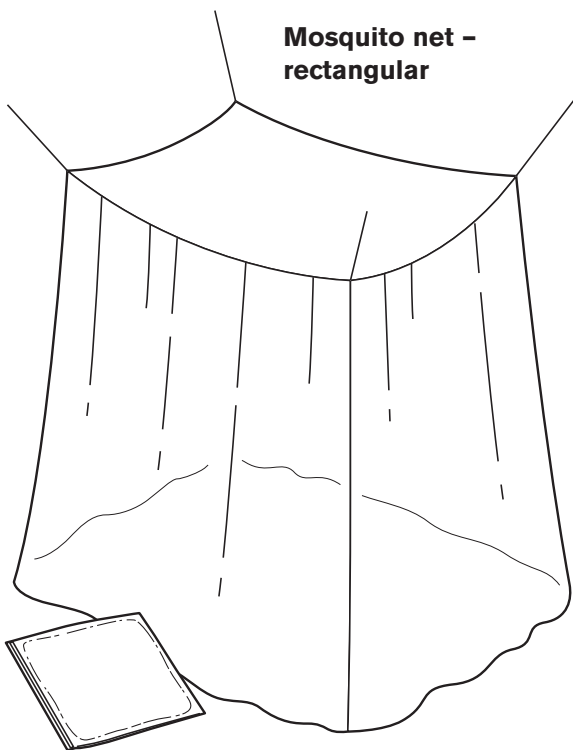

**Bottles**

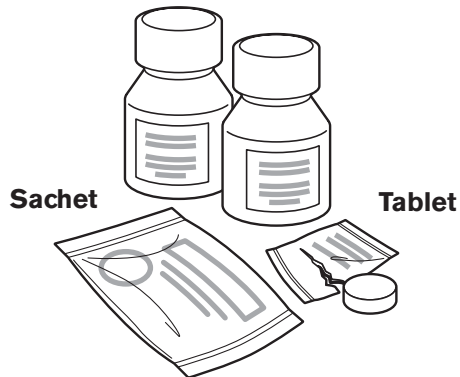

**Single dose insecticide treatments**

**Multi-dose insecticide treatment**

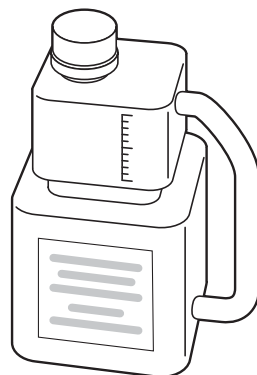



## 3.5 New developments

This sub-section provides an overview of new and simple, low-cost supplies and technologies for primary health care.

Purpose	Item	Description	Remarks
<b>Hypothermia indicator</b>	<b>ThermoSpot</b>	Liquid crystal temperature disc, black with 2 white dots, 12mm diameter, self-adhesive, 25 discs per pack + recording chart	A simple, accurate method for health workers and mothers to check that newborns and sick children are not hypothermic (cold) i.e. with an axillary (body) temperature of less than 36.5°C. Hypothermia can kill, and low birth weight and malnourished infants are especially at risk. The ThermoSpot disc is placed under the armpit or over the liver area in the epigastrium. At a body temperature below 35.5°C this disc is black, at 35.5°C the black disc starts to turn green, between 36.5-37.5°C, the black disc turns green and a smiling face appears. As the temperature drops below 35.5°C, the smiling face disappears and the disc changes back to black. The disc is water resistant so does not need to be removed when washing, and can be re-used.
<b>Measuring temperature</b>	<b>Zeal Single Use Thermometer (ZSUT)</b>	Clinical, non-glass, mercury-free, liquid crystal, re-usable, green dot matrix, oral and axilla thermometer with scale 35.5-40.4°C and accurate to within 0.1°C	The ZSUT can give a reading of body temperature under the tongue in 1 min and in the armpit in 3 min. It must be read immediately after being removed from the mouth or armpit. Temperature reading is taken by looking to see how many of the green dots have turned black. The spots change back to green if you rub them with your thumb. Suitable for use in wards, clinics and the community. Although described as 'single use', ZSUTs can safely be re-used after cleaning with a mild disinfection solution (soap and water, or alcohol, or dettol).
<b>Identifying low birth weight (LBW) newborn infants</b>	<b>String</b>	Non-stretch string with 2 knots, 30cm apart	Simple method to check for low birth weight, if it is not possible to weigh a newborn infant. This method is based on the fact that birth weight is closely related to chest circumference. To use, place the knotted string around the infant's chest at nipple level. If the knots overlap, the chest measure is less than 30cm, the infant is likely to be LBW and at risk.
<b>Anaemia screening</b>	<b>Haemoglobin colour scale</b>	Booklet with colour scale card with 6 shades of red that correspond to a range of Hb (haemoglobin) values (4, 6, 8, 10, 12 and 14g/dl) and absorbent test strips (special chromatography filter paper)  Accessories: supplies to obtain blood samples, e.g. lancet, disposable gloves	Developed by WHO for detecting the presence and severity of anaemia and for managing anaemia. Visual method using a simplified filter paper method of anaemia detection (similar in principle to, but not the Tallqvist test, which is unreliable and obsolete). Simple, easy to use and accurate test, which can help health workers decide whether a patient needs referral for investigation and treatment. Appropriate for use in rural health units (where laboratory facilities are unreliable or unavailable), ANC and child health clinics, and for management of malaria. Useful also as a point-of-care anaemia check in any setting. By matching the colour of a finger-prick drop of blood on a test strip with one of the shades of red (the 6 shades of red corresponding to the 6 different Hb values or closest match), you can see if the blood is anaemic and, if so, the severity of anaemia. Results are available within 1 min and must be read immediately. Only the special test strips that are provided with scale should be used, others may give inaccurate results.

Purpose	Item	Description	Remarks
<b>Reducing incidence of fly-borne diseases, e.g. trachoma</b>	<b>Fly trap</b>	2 large, clear plastic bottles with screw top, 1 small clear plastic tube, black or dark paint	A home-made fly trap can help to reduce trachoma. Two transparent plastic bottles are mounted, one above the other, to create a fly trap. Uses the fact that after feeding flies fly upwards and towards light. The flies are lured into the bottom 'bait' bottle through holes. The bottom bottle is painted with dark paint or covered with mud, so it is dark inside. You can use a mixture of goat droppings and cow's urine as bait. After feeding, the flies are attracted by the light and fly up into the transparent upper bottle, fitted over the top of the bait bottle, through a tube. The flies stay in the upper bottle until they die.
<b>Diagnosing malaria</b>	<b>Simple and rapid malaria tests</b>	<i>P. falciparum</i> rapid diagnostic test kits, visually read, with controls, each test individually packaged, e.g. Quorum rapid malaria test pack of 25 and 100 tests	Rapid diagnostic tests (RDT) are simple, rapid, easy to use and read tests that detect <i>P. falciparum</i> -specific antigens using a fingerprick blood sample, and give results within 15-30 minutes. RDT do not require technicians, training in microscopy or special equipment and are suitable for use in settings with limited, unreliable or no laboratory facilities. Many RDTs can be stored at room temperature but some require refrigeration. Several commercial RDTs are available, but are still too costly for routine clinical diagnosis. However, they may be appropriate for patients with suspected treatment failure or drug resistance, unclear diagnosis, severe and complicated cases. Also for suspected epidemics in settings without laboratory facilities and areas of low transmission with high levels of resistance to antimalarial drugs. Quick and accurate diagnosis in such situations may help to reduce morbidity rates and misuse of treatments. RDTs distinguishing between <i>P. falciparum</i> and <i>P. vivax</i> are being developed and some are now on the market.

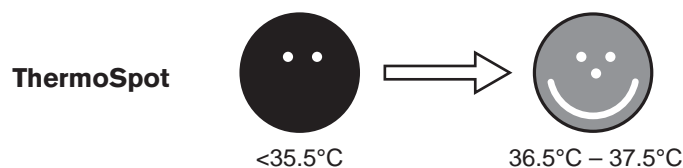

**Zeal thermometer**

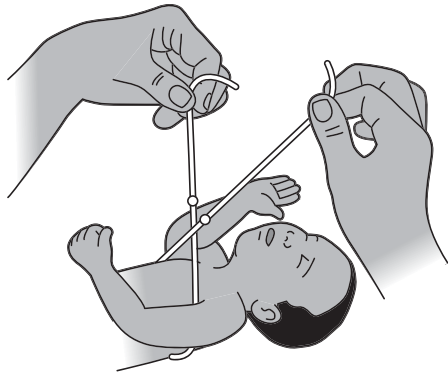

**Non-stretch string**

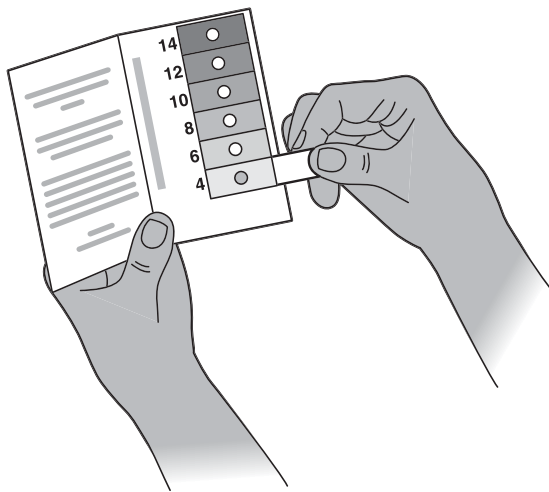

**Haemoglobin colour scale**

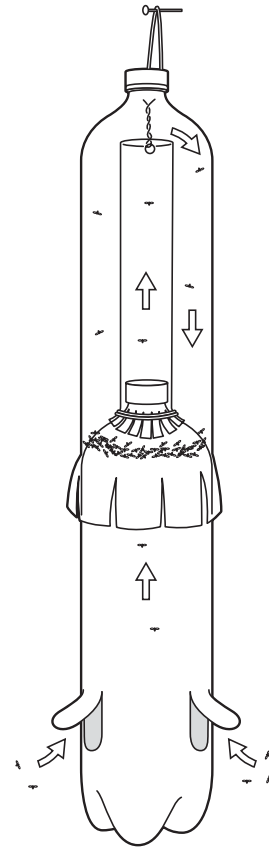

**Fly trap**



# Appendix 1 Useful resources

This list provides information about relevant low cost and free publications, and sources of supplies, equipment and information. It is organised in the following sections:

- i. Books and manuals
- ii. Free materials and guidelines
- iii. Sources of low cost supplies, equipment and pharmaceuticals
- iv. Sources of publications, and resource and information centres

## i. Books and manuals

The following books and manuals are listed in subject categories, for example, Essential drugs, Waste disposal. For each publication we have included the title, author(s), date of publication, publisher, a brief description of the content, and the main source(s). Contact details for the source organisations are included in sections iii and iv. Readers should note that most of the books and manuals listed are available at low cost from ECHO and TALC. In some countries it may also be possible to obtain these publications from local bookstores, as publishers and distributors increase efforts to ensure wider availability. Readers should check published prices with the supplier, since prices often depend on order size, discounts available and distribution method.

### Care and maintenance

**Care and safe use of hospital equipment**, Skeet M and Fear M, 1995, VSO.

Provides practical advice for hospital staff about proper management of equipment, including guidelines on preventive maintenance and service, simple user instructions, checklists for correct and safe use of equipment and basic technical information for training of first-line maintenance staff.

*Available from:* ECHO, TALC.

**How to look after a refrigerator**, Elford J, 1992, Healthlink (formerly AHRTAG).

Provides practical guidelines for care and maintenance of a range of kerosene, gas, electric and solar refrigerators.

*Available from:* Healthlink.

### Community health

**A handbook for managers: insecticide treated net projects**, Chavasse D, Reed C and Attawell K, 1999, Malaria Consortium.

Designed to be a practical decision-making tool for project managers, the handbook covers planning, implementing and monitoring treated net projects, illustrated with examples from more than 30 projects in 16 countries.

*Available from:* Malaria Consortium.

**The family planning clinic in Africa (3rd edition)**, Brown R and Brown J, 1998, Macmillan.

A practical manual for health practitioners providing contraceptive services and advice. It includes information about contraceptive methods such as advantages and disadvantages, and guidance for setting up and running a family planning clinic.

*Available from:* ECHO, TALC.

**Health workers' manual on family planning options**, Western Pacific Education in Action Series No.7, 1998, WHO.

Provides an overview of each of the available contraceptive methods, including how they work, advantages, disadvantages and contraindications.

*Available from:* WHO.

**Immunisation in practice: a guide for healthworkers who give vaccines**, WHO, 1996, Macmillan.

A guide for health workers giving immunisations. Explains about vaccinations and provides practical information on how to carry out immunisation, look after vaccines and on methods of sterilisation and boiling.

*Available from:* ECHO, TALC, WHO.

**Setting up community health programmes: a practical manual for use in developing countries,**

Lankester T, 2000, Macmillan.

Second edition, fully revised, practical manual for community-based health care programmes. Focuses on community-based approaches in planning, management and evaluation. Includes chapters on setting up a clinic, using village health workers, and community programmes for mothers and children.

Available from: ECHO, TALC.

**Where there is no doctor,** Werner D, 1993, Macmillan.

Highly practical health care manual providing easy to understand information on how to diagnose, treat and prevent common diseases.

Available from: ECHO, TALC.

**Where women have no doctor,** Burns A, Lovich R, Maxwell J and Shapiro K, 1997, Macmillan.

Practical manual to help healthworkers identify, treat and prevent many of the common health problems that affect women. Also a useful guide for any women who wants to understand and improve her own health. Covers sexual health, major diseases, pregnancy and childbirth, nutrition, disabilities, injuries and mental health.

Available from: ECHO, TALC.

## Essential drugs

**Estimating drug requirements: a practical manual,** WHO/DAP/88.2, 1988, WHO.

Includes 8 training modules which explain the steps in estimating drug requirements.

Available from: WHO.

**Guidelines to rational drug use,** von Massow Fr, Ndele J and Korte R, 1997, Macmillan.

Provides guidance on rational prescribing of a wide range of common drugs used in developing countries, giving details of dosage, administration, contraindications and side effects, and supplemented by information on comparative treatment costs.

Available from: AMREF, ECHO, TALC.

**Managing drug supply: the selection, procurement, distribution and use of pharmaceuticals**

(2nd edition), MSH, 1997, Kumarian Press.

Provides a complete overview and step-by-step advice on how to manage pharmaceutical systems effectively and make the best use of limited resources. An invaluable source of information for reference and practice for decision makers and staff responsible for procurement, management, supply and rational use of drugs in health systems.

Available from: Management Sciences for Health.

## Laboratory

**District laboratory practice in tropical countries (Part 1),** Cheesbrough M, 1998, Tropical Health Technology.

Covers selection and procurement of laboratory equipment and supplies, parasitological tests, clinical tests and training of personnel. Aimed at those responsible for organisation and management of district laboratory services, but can also be adapted for use by health centres.

Available from: ECHO, TALC, THT.

**District laboratory practice in tropical countries (Part 2),** Cheesbrough M, 2000, Tropical Health Technology.

Covers microbiological, haematological and blood transfusion techniques required at district level.

Available from: ECHO, THT.

**Practical laboratory manual for health centres in East Africa,** Carter J and Lema O, 1998, AMREF.

Practical laboratory manual providing information necessary to establish, select and use laboratory tests for patient management. Also includes material on implementation of safe working practices, reporting and recording test results, keeping an inventory of supplies and equipment, ordering supplies and maintaining equipment.

Available from: AMREF.

**Selection of basic laboratory equipment for laboratories with limited resources,** Johns W and El-Nageh M, 2000, WHO.

Provides a framework to help laboratory workers choose and buy laboratory equipment and consumables, including information about energy requirements for laboratory equipment, and buyer's guides.

Available from: ECHO, WHO.

## **Making equipment and teaching materials**

***A book for midwives***, Klein S, 1996, Hesperian Foundation.

Practical information on antenatal care, labour, birth and post-partum care, which also includes a section on making teaching materials and low-cost equipment.

*Available from:* ECHO, TALC.

***How to make and use visual aids***, Harford N and Baird N, 1997, VSO.

Describes a number of useful and practical methods for making visual aids quickly and easily, using low cost materials.

*Available from:* ECHO, TALC

***Making health care equipment***, Platt A and Carter N, 1990, Intermediate Technology.

Contains illustrated step-by-step instructions for making items such as folding beds, screens, drip stands, wheelchairs and aids for the disabled.

*Available from:* Intermediate Technology Publications.

## **Management**

***How to manage a health centre store***, Battersby A, 1994, Healthlink (formerly AHRTAG).

Describes in detail the structure and organisation of a store or dispensary, methods of arranging stocks, stock control, basic dispensing.

*Available from:* Healthlink.

***Medical administration for frontline doctors***, Pearson C, 1990, FSG.

Provides information for doctors who combine wide clinical responsibilities with administration and support for primary health care services. Covers a wide range of topics including records, hospital supplies, technical maintenance, support service and outreach programmes.

*Available from:* ECHO, TALC.

***On being in charge: a guide to management in primary health care*** (2nd edition), McMahon R, Barton E and Piot M, 1992, WHO.

Practical manual that serves both as a training and reference guide, covering all aspects of primary health care management including equipment and drugs.

*Available from:* ECHO, WHO.

## **Waste disposal**

***How are we managing our healthcare wastes?*** Coad A and Christen J, 1999, SKAT.

Looks at management of health care waste in low-income and middle-income countries using case studies from 6 cities in Africa, Asia and Middle East. Consists of a series of questions with comments to guide health care waste management.

*Available from:* Intermediate Technology Publications.

***Safe management of wastes from healthcare activities***, Pruss A, Giroult E and Rushbrook P, 1999, WHO.

A guide to the safe handling, treatment and disposal of health care waste, particularly in hospitals in developing country settings, but also relevant to health centres.

*Available from:* ECHO, WHO.

## ii. Free materials and guidelines

### Essential drugs

**Drug donation guidelines** (2nd edition), WHO, 1999.

Discusses the need for good donation practices, includes core principles and practical guidelines for drug donations, covering issues including selection, quality and expiry dates. Suitable for adaptation and use by donors and recipients at all levels.

*Available from:* Department of Essential Drugs and Medicines, WHO, and online at [www.who.int/medicines/](http://www.who.int/medicines/) and [www.drugdonations.org](http://www.drugdonations.org)

### **Practical pharmacy pack**

Discontinued quarterly practical pharmacy newsletters (issues 1-15) gathered into a set. Promotes the safe and rational use of drugs by providing appropriate information designed to increase understanding of drug management and supply and to improve practice. For health workers who have no specific training in this area of work, but whose job involves the supply and management of drugs. The pack covers topics such as selection, storage and dispensing of drugs, and handling drug donations.

*Available from:* ECHO.

### Equipment

**Guidelines on medical equipment donations**, WCC/CISS, 1998.

A practical guide for those accepting and making equipment donations, it is also useful for those planning to buy equipment.

*Available from:* WCC and ECHO and online at [www.echohealth.org.uk](http://www.echohealth.org.uk)

**Product information sheets (PIS)**, WHO.

These describe equipment used for immunisation programmes including refrigerators, cold boxes, vaccine carriers, syringes and needles, thermometers and sterilisers, and provide advice on how to choose the right equipment.

*Available from:* Department of Vaccines and Biologicals, WHO, and online at [www.who.int/vaccines-documents/](http://www.who.int/vaccines-documents/)

## iii. Sources of low-cost supplies, equipment and pharmaceuticals

### Medical supplies, equipment and pharmaceuticals

#### **Action Medeor**

St Toniser Strasse 2, 47918 Tonsivorst, Germany

Tel: (+49 21) 56 97880 Fax: (+49 21) 56 80632 e-mail: [info@medeor.org](mailto:info@medeor.org) [www.medeor.org](http://www.medeor.org)

Registered non-profit medical aid organisation specialising in supply of quality assured and affordable pharmaceuticals and medical supplies to the public health sector, NGOs and mission hospitals in developing countries and countries in transition.

#### **ECHO International Health Services Ltd**

Ullswater Crescent, Coulsdon, Surrey CR5 2HR, UK

Tel: (+44 20) 8660 2220 Fax: (+44 20) 8668 0751 e-mail: [cs@echohealth.org.uk](mailto:cs@echohealth.org.uk) [www.echohealth.org.uk](http://www.echohealth.org.uk)

Registered non-profit charity specialising in the supply of quality assured and affordable pharmaceuticals, medical supplies, equipment (new and reconditioned), teaching aids and books to the public and non-profit health sector in developing countries and countries in transition. Also provides advice and training, publishes practical information on medical supplies and equipment, and distributes TALC products and some WHO publications.

#### **IDA Foundation (International Dispensary Association)**

PO Box 37098, 1030 AB Amsterdam, The Netherlands

Tel: (+31 20) 4033051 Fax: (+31 20) 40301854 e-mail: [info@ida.nl](mailto:info@ida.nl) [www.ida.nl](http://www.ida.nl)

A non-profit organisation supplying quality assured and affordable medicines and medical supplies to the public and non-profit health sector in developing countries and countries in transition.



**JMS (Joint Medical Store)**

PO Box 4501, Kampala, Uganda

Tel: (+256 41) 269699 or 268482 Fax: (+256 41) 267298 e-mail: sales.jms@imul.com

Not-for-profit mission medical store supplying pharmaceuticals, medical supplies and equipment, with a technical department to deal with maintenance issues and capital equipment. Supplies the public and non-profit health sector in Uganda, East Africa and Great Lakes region.

**MEDS (Mission for Essential Drugs and Supplies)**

PO Box 14059, Nairobi, Kenya

Tel: (+254 2) 544244/5 Fax: (+254 2) 545062 or 540993 e-mail: sahibu@africaonline.co.ke

Not-for-profit mission medical store supplying pharmaceuticals, medical supplies and equipment to mission organisations and not for profit organisations in East Africa and Great Lakes region.

**Incinerators for medical waste****MSC Envirohealth Products**

25 Reedbuck Crescent, Corporate Park, PO Box 506 15 Randjesfontein, Midrand 683, South Africa

Tel: (+27 11) 314 7540 Fax: (+27 11) 314 7535 e-mail: scaine@mweb.co.za

Contact for further information about the Medcin 400 Gas Incinerator, a pre-assembled incinerator designed for rural and small-scale health care waste management.

**The Innovative Technology Group**

The Innovative Technology Centre, 26 Oaks Road, Great Glen, Leicester LE8 9EG, UK

e-mail: djp@picken98.co.uk or djpicken@iee.org.uk

Contact for further information on DMU incinerators and copies of the drawings and instruction plans for building, operation and maintenance. A range of DMU incinerators has been developed for use by rural PHC facilities, designed to be constructed on site using local materials. There may be small charge to cover the cost of printing and postage of the plans. Plans are also available from ECHO (hard copies and electronic copies) and at [www.echohealth.org.uk](http://www.echohealth.org.uk)

## iv. Sources of publications, and resource and information centres

**AMREF (African Medical Research Foundation)**

Headquarters, PO Box 30125, Nairobi, Kenya

Tel: (+254 2) 501301/2/3 Fax: (+254 2) 609518 e-mail: amref.info@amref.org [www.amref.org](http://www.amref.org)

Publishes practical books, journals and other literature, and provides advice on PHC. Runs training courses and seminars.

**FAKT (Association of Appropriate Technology)**

Gansheidestrasse 43, D-70184 Stuttgart, Germany

Tel: (+49 711) 21095/0 Fax: (+49 711) 21095/55 e-mail: fakt@fakt-consult.de [www.fakt-consult.de](http://www.fakt-consult.de)

Non-profit consultancy firm, that provides information on appropriate hospital and medical equipment and training in healthcare technologies. FAKT is not a supply organisation.

**Healthlink Worldwide (formerly AHRTAG)**

Cityside, 40 Adler Street, London E1 1EE, UK

Tel: (+44 20) 7539 1570 Fax: (+44 20) 7539 1580 e-mail: info@healthlink.org.uk [www.healthlink.org.uk](http://www.healthlink.org.uk)

Publishes a range of free and low-cost newsletters, resource lists, briefing papers and manuals about health and disability. Publications include *Free International Newsletters* list of over 130 print and electronic health-related newsletters and magazines which are available free to readers in developing countries, and *HIV testing: a practical approach* briefing paper on HIV counselling and laboratory testing.

### **Intermediate Technology (IT) Publications**

103-105 Southampton Row, London WC1B 4HH, UK

Tel: (+44 20) 7436 9761 Fax: (+44 20) 7436 2013 e-mail: adwoab@itpubs.org.uk www.itdgpublishing.org.uk

Publishes books and journals covering aspects of health, development and appropriate technology.

### **International Centre for Eye Health (ICEH)**

International Resource Centre, Institute of Ophthalmology, University College London,

11-43 Bath Street, London EC1V 9EL, UK

Tel: (+44 20) 7608 69 23/10/06 Fax: (+44 20) 7250 3207 e-mail: eyeresource@ucl.ac.uk www.ucl.ac.uk/iao

Advises and publishes information on all aspects of eye care including prevention of blindness. Produces *Community Eye Health* journal distributed free to developing countries, an annual standard list of medicines, equipment, instruments and optical supplies for eye care for developing countries, and teaching slides/text sets and videos.

### **Malaria Consortium**

London School of Hygiene and Tropical Medicine, Keppel Street, London WC1E 7HT, UK

Tel: (+44 20) 7927 2439 Fax: (+44 20) 7580 9075 e-mail: s.meek@lshtm.ac.uk

www.lshtm.ac.uk/itd/dcvbu/malcon/Malcon.htm

Provides technical assistance and advice on all aspects of malaria control. Publishes technical, research and practical information.

### **Management Sciences for Health**

165 Allandale Road, Boston MA 02130, USA

Tel: (+1 617) 524 7799 Fax: (+1 617) 524 2825 e-mail: bookstore@msh.org www.msh.org/publications

Publishes and distributes practical, experience based books and tools in multiple languages for health and development professionals, managers and policy makers.

### **TALC (Teaching Aids at Low Cost)**

PO Box 49, St Albans, Herts AL1 5TX, UK

Tel: (+44 1727) 853869 Fax: (+44 1727) 846852 e-mail: talc@talcuk.org www.talcuk.org

UK registered non-profit charity specialising in supplying affordable books, slides and teaching aids on health and community issues in developing countries, with a particular focus on materials for PHC and district levels. TALC products are also available through ECHO.

### **Tropical Health Technology (THT)**

14 Bevills Close, Doddington, March, Cambridgeshire PE15 OTT, UK

Tel: (+44 1354) 740825 Fax: (+44 1354) 740013 e-mail: thtbooks@tht.ndirect.co.uk www.tht.ndirect.co.uk

Primary focus is laboratory services, information and technology. Specialises in supply of laboratory equipment, books, bench aids, slide sets and microscopes.

### **World Council of Churches (WCC)**

PO Box 2100, 1211 Geneva, Switzerland

Tel: (+41 22) 791 6111 Fax: (+41 22) 791 0361 e-mail: info@wcc-coe.org www-coe.org

International fellowship of churches that produces publications and newsletters. Recent publications include *Guidelines on Medical Equipment*.

### **WHO (World Health Organisation)**

Distribution and Sales Office, 20 Avenue Appia, CH-1211 Geneva 27, Switzerland

Tel: (41 22) 791 2476 or 2477 Fax: (41 22) 791 4857 e-mail: publications@who.ch www.who.int/

WHO produces and distributes books, manuals, journals, practical guidelines and technical documents. Publications are also available from WHO regional offices. Contact your regional or field office for advice on all aspects of health care and WHO materials. WHO regional offices in Africa are:

#### **EMRO (Eastern Mediterranean Regional Office)**

Abdul Razzak Al Sanhoury Street, PO Box 7608, Nasr City, Cairo 11371, Egypt

Tel: (+20 2) 670 2535 Fax: (+20 2) 670 2492/94 e-mail: Postmaster@emro.who.int www.who.sci.eg

**AFRO (Regional Office for Africa)**

(Temporary office) Parienyatwa Hospital, Mazoe Street, PO Box BE 773, Harare, Zimbabwe

Tel: (+263 4) 703 580 or 684 Fax: (+263 4) 700742 e-mail: [regafro@whoafr.org](mailto:regafro@whoafr.org) [www.whoafr.org](http://www.whoafr.org)

**UNICEF (United Nations Children's Fund)**

UNICEF House, 3 UN Plaza, New York 10017, USA

Tel: (+1 212) 326 7000 Fax: (+1 212) 887 7465 or 7454 e-mail: [jando@unicef.org](mailto:jando@unicef.org) [www.unicef.org](http://www.unicef.org)

Provides a wide range of resource materials, journals, books and videos, games and posters. Contact your regional or field office for advice on all aspects of child health care and UNICEF materials. UNICEF regional offices in Africa:

**Eastern and Southern Africa Regional Office (ESARO)**

PO Box 44145 (UN Gigiri Compound), Nairobi, Kenya

Tel: (+ 254 2) 621 234 Fax: (+ 254 2) 622 678 e-mail: [nairobiro@unicef.org](mailto:nairobiro@unicef.org)

**West and Central Africa**

Boite Postale 443, Abidjan 04, Cote d'Ivoire

Tel: (+ 225) 20 213 131 Fax: (+225) 20 227 607 e-mail: [nyhq@unicef.org](mailto:nyhq@unicef.org)

**UNFPA (United Nations Population Fund)**

220 East 42nd Street, New York, NY 10017, USA

Tel: (+1 212) 297 5211 Fax: (+1 212) 297 4915 e-mail: [africainfo@unfpa.org](mailto:africainfo@unfpa.org) [www.unfpa.org/index.htm](http://www.unfpa.org/index.htm)

Provides assistance for reproductive health care services, procurement and distribution of contraceptives, training of health care providers, information and publications. For information about programmes and activities contact UNFPA representatives or field office.

**UNAIDS**

20 Avenue Appia, CH-1211 Geneva 27, Switzerland

Tel: (+41 22) 791 3666 Fax: (+41 22) 791 4187 e-mail: [unaids@unaids.org](mailto:unaids@unaids.org) [www.unaids.org](http://www.unaids.org)

UNAIDS, the joint UN programme on HIV/AIDS, publishes an extensive range of materials, including practical and technical guidelines. For information about programmes and activities and materials, contact country-based staff.



# Appendix 2 Essential drugs

Provision of effective primary health care (PHC) depends on the availability of drugs, as well as of supplies and equipment. The 1978 Alma Ata Conference on PHC recognised the importance of essential drugs, which are defined as those that satisfy the health care needs of the majority of the population, based on the commonly occurring diseases and on the skills of the health workers who use them at the different levels of the health system. Choice of drug is also based on drug effectiveness, quality, safety, availability and costs. Essential drugs should be available at all times, in adequate amounts, and in appropriate dosage forms.

Essential Drugs Lists (EDL) help to simplify quantification of drug requirements and the training of those responsible for prescribing and dispensing drugs. If only a limited number of drugs are used, health workers will be more familiar with indications, dosages, side effects and contraindications.

More than 120 countries now use a national EDL of some kind, adapted from the WHO Model EDL to suit local health needs and resources. Follow national guidelines on essential drugs for your level of health facility. You should be able to obtain the EDL for your country from the district health team.

A health facility with a clinical officer (medical assistant) or nurse in charge will use 30-40 essential drugs. The following is an example of an EDL commonly found at this level. It is not comprehensive, nor does it imply that other drugs are not useful. But it is intended to provide a list of the drugs that are most essential to provide health care for the majority of the population in most developing countries.

## Using the Essential Drugs List

Use the national EDL or the EDL below as the basis for standardised procurement in the same way as the lists of medical supplies and equipment. The EDL uses the international non-proprietary names (INN) classification. INN is the official shortened scientific name or generic name, based on the active ingredient used. Using the INN reduces the risk of duplication, confusion or errors in identifying a product. For example, cotrimoxazole (the official or generic name) is easier to recognise and remember than the range of alternatives, such as septrim, bactrim etc. and avoids mistakes in prescribing, dispensing and ordering. Generic drugs are also usually much cheaper than proprietary drugs.

## An example of an Essential Drug List

Essential Drug	Route/form	Strength	Use
Acetylsalicylic acid (aspirin)	tablet	300mg	analgesic; antipyretic; anti-inflammatory
Adrenaline	injection	1mg/ml	anaphylaxis; respiratory
Aluminium hydroxide	tablet	500mg	antacids
Aminophylline	tablet	200mg	respiratory
Amoxicillin	tablet or capsules	250mg/500mg	antibacterial
Ascorbic acid (Vitamin C)	tablet	100mg	vitamin
Atropine	injection	1mg/ml	antispasmodic
Benzylpenicillin	powder for injection	1MU	antibacterial
Benzathine benzylpenicillin	powder for injection	2.4MU	antibacterial
Chlorpromazine	tablet	25mg	sedative
Chlorpromazine	injection	50mg/2ml	sedative
Chlorphenamine	tablet	4mg	antiallergic
Chloroquine	tablet	150mg base	antimalarial

<b>Essential Drug</b>	<b>Route/form</b>	<b>Strength</b>	<b>Use</b>
Chloroquine	syrup	50mg/5ml	antimalarial
Chloroquine	injection	80mg/2ml	antimalarial
Cotrimoxazole	tablet	480mg	antibacterial
Cotrimoxazole	syrup	240mg/5ml	antibacterial
Diazepam	injection	10mg/2ml	anticonvulsant
Diazepam	rectal tube	5mg/2.5ml	anticonvulsant
Doxycycline hydrochloride	tablet or capsule	100mg	antibacterial
Ferrous sulfate + folic acid	tablet	200mg+ 0.25mg	anaemia
Folic acid	tablet	5mg, 1mg	anaemia
Hydrocortisone	powder for injection	100mg	antiallergic; anaphylaxis
Lidocaine hydrochloride	injection	2%/ 20ml/2%/50mls	local anaesthetic
Magnesium trisilicate	tablet	250mg	antacid
Mebendazole	tablet	100mg	antihelminthic
Methylethylmagnesium	injection	0.2mg/ml	labour; delivery
Metronidazole	tablet	200mg, 250mg	antiprotozoal; antibacterial
Niclosamide	tablet	500mg	antihelminthic
Nystatin	pessary	100,000IU	antifungal
Nystatin	tablet	500,000IU	antifungal
ORS	powder for 1l	WHO standard preparation	rehydration
Paracetamol	tablet	500mg	analgesic; antipyretic
Paracetamol	suppository	100mg	analgesic; antipyretic
Phenobarbitone	tablet	30mg	anticonvulsant
Phenoxyethylpenicillin	tablet	250mg	antibacterial
Promethazine	tablet	25mg	antiemetic; antihistamine
Procaine benzylpenicillin	powder for injection	3MU	antibacterial
Quinine	tablet	300mg	antimalarial
Quinine	injection	600mg/2ml	antimalarial
Tetracycline	tablet or capsule	250mg	antibacterial
Salbutamol	tablet	4mg	respiratory
Sulfadoxine + pyrimethamine (fansidar)	tablet	25mg + 500mg	antimalarial
Vitamin A (retinol)	capsules	50,000IU, 200,000IU	vitamin

Infusion/Parenteral	Route/form	Strength	Use
Glucose (dextrose)	infusion	5%,	drug administration
Water for injection	injection	5ml, 10ml, 100ml	drug administration

Topical drugs	Route/form	Strength	Use
Benzoic acid and salicylic acid	ointment	6% + 3%	antifungal
Benzyl benzoate	lotion	25%	antiparasitic
Calamine	lotion	15%	skin
Chloramphenicol	drops	0.5%	eye/ear infection
Gentian (crystal) violet	powder	25g	antifungal, antiseptic
Hydrogen peroxide	solution	3%	wounds
Paraffin	ointment	–	wounds; skin
Polyvidone iodine	solution	10%	antiseptic
Tetracycline	ointment	1%	eye infection
Zinc oxide	ointment	15%	skin

Vaccines	Route/form	No. doses/vial	Prevention
BCG	injection	20 doses/ in 10ml vial	TB
TT	injection	20 doses/in 10ml vial	Tetanus
DPT	injection	20 doses/in 10ml vial	Diphtheria, Tetanus, Pertussis
Measles	injection	10 doses/vial	Measles
Polio	oral solution	20 doses/vial	Polio

## Practical tips for procurement

Whether you order and receive drugs from a central medical store or from wholesalers and manufacturers, use the national or WHO Model EDL to guide you:

- **Specifications** – Check that you have specified the correct name (preferably generic), dosage strength (mg, ml, other measurement), unit size (e.g. 200mls, 1000 tablets), pack (unit) size, dosage form (e.g. tablet, capsule, injection, oral liquid, or other form) total quantities.
- **Expiry dates and quality** – Check that the shelf life is at least 12 months from time of arrival in country or at least 50% if shelf life is less than 12 months from the date of manufacture. Check appearance for colour changes and for unusual smells, in particular that: tablets are not chipped, broken, sticky or cracked; tubes of creams and ointments are not cracked; injections have no particles; clear vaccines are not cloudy; and bottles and vials are not cracked or chipped or seals broken.
- **Packaging and labelling** – Check that packaging is robust, not damaged or discoloured, and that lids have not come off and contents spilled. Make sure labelling (see Box, below) includes all the right information, including how the item should be stored.

## Labelling

Clear, informative labels promote good practice. As a minimum requirement, product labels should clearly state:

- INN (Generic name of active ingredient)
- Dosage form
- Quantity of active ingredients in the dosage form
- Number of units per package
- Batch number
- Date of manufacture
- Expiry date
- Pharmacopeial standard (e.g. BP)
- Storage instructions
- Manufacturer name and details

- **Certification** – Check that your supplier can provide the following certificates: Manufacturing Licence, Certificate of Analysis, current Good Manufacturing Practice, Certificate of Pharmaceutical Product, Free Sale Certificate (if importing), and Product Registration (see Box, below). Access to certification is particularly important if you are procuring from sources other than national medical stores.

## Certification

- Manufacturing licence – shows a manufacturer is legally licensed to produce pharmaceutical products.
- Certificate of Pharmaceutical Product (CPP) – relates to products that a manufacturer has been licensed to produce for sale and indicates whether the product is for export only or authorised for use in the country of manufacture.
- Free Sale Certificate – indicates a product is manufactured for the export market.
- Certificate of Analysis (CA) – applies to a specific batch of a product for sale, showing whether the product has been manufactured according to a stated international standard, by comparing chemical analysis of a sample of the batch with the minimum requirement set e.g. BP or USP.
- Current Good Manufacturing Practice (cGMP) – issued by national regulatory authorities after relevant inspection. Although not very useful for assessing quality because assessments are not carried out to the same standard in all countries, avoid buying any product from a manufacturer that lacks a current GMP.

- **If importing** – Check if the product and the manufacturer are registered in your country. An increasing number of countries now insist that products from their EDL should only be supplied from manufacturers that are registered to do so in that country. In an emergency this requirement may be waived, but in normal circumstances not complying with it will cause problems. Where this is an issue, the manufacturer should be able to provide you with evidence that the product is registered for importation.

See also Sections 1 and 2 of this book, as the same principles apply to procurement of essential drugs as to procurement of supplies and equipment.



## Quantification

The most commonly used quantification methods are the consumption method and the morbidity method. Each method has advantages and disadvantages (see Table A1). The usefulness of both methods depends on the accuracy of the information used to do the calculations. The choice of method will therefore depend on the availability of accurate stock receipts, issue records and morbidity data together with the existence and use of standard treatment guidelines.

**Table A1 Advantages and disadvantages of the consumption and morbidity methods of quantification**

Morbidity method	Consumption method
<p><b>Advantages:</b></p> <ul style="list-style-type: none"> <li>• Suitable for new or rapidly changing services.</li> <li>• Can be used as a basis for reviewing actual drug use and prescribing practice against recommendations in standard treatment guidelines.</li> <li>• Promotes reliable recording of morbidity data.</li> <li>• Provides information about the rate of use of drugs.</li> </ul> <p><b>Disadvantages:</b></p> <ul style="list-style-type: none"> <li>• Requires detailed and accurate morbidity data and agreed standard treatment guidelines for prescribing. Using incomplete or inaccurate data can result in over-estimates or under-estimates of quantities required.</li> <li>• Requires more detailed and time-consuming calculations than the consumption method.</li> <li>• Assumes staff correctly diagnose and follow standard treatment guidelines. Supply will not match use if standard treatments are not observed in practice.</li> </ul>	<p><b>Advantages:</b></p> <ul style="list-style-type: none"> <li>• Suitable for settings which are adequately funded, with well-established supply system and good stock control.</li> <li>• Does not require detailed morbidity data or standard treatment guidelines.</li> <li>• Is reliable if consumption is well recorded and stable.</li> <li>• Requires less detailed calculations than the morbidity data method, and is a quick method.</li> <li>• Easier to use in facilities dealing with a wide range of health problems and more complex treatments.</li> </ul> <p><b>Disadvantages:</b></p> <ul style="list-style-type: none"> <li>• Requires reliable drug consumption data, accurate stock record keeping and good stock management.</li> <li>• Not suitable for services experiencing changes in use.</li> <li>• Only provides information about rate of use, but does not provide a basis for reviewing rational drug use or prescribing. If prescribing is poor this method may perpetuate it.</li> <li>• Assumes items recorded as issued for use have been correctly prescribed and used.</li> </ul>

Different methods may be more useful or appropriate at different times. For example, for a new facility you will need to use the morbidity method (if you know the population size in the catchment area, the incidence of disease, and standard treatments for these diseases) to calculate how much to order initially, but later you could use the consumption method. Or, for example, a facility using the consumption method may occasionally find it helpful to use the morbidity method to review prescribing standards. The consumption method may be more appropriate for facilities using a wide range of drugs, and the morbidity method for facilities using a more limited range of drugs according to standard treatment guidelines.

Tables A2 and A3 show the steps in applying the consumption and morbidity methods.

**Step 1: Select the time period for calculating consumption**

For example: to calculate the quantity of cotrimoxazole 480mg tablets required for a 12 month period for 10,000 patients. You have the following data for 12 months:

Opening stock balance	1000 tablets
Items received	5000 tablets
Closing stock balance	2000 tablets
Wastage	0
Stockout	2 months

*12 months is the most practical time period to use for calculation, because it allows for seasonal variations in requirements. If the data you have available covers a shorter or longer time period, use Step 4 to adjust it to calculate requirements for 12 months*

**Step 2: Calculate the consumption for each item during the time period**

Recorded consumption = Opening stock balance + Stock received – Closing stock balance

Recorded consumption = 1000 + 5000- 2000 = 4000

*To calculate consumption you need accurate stock cards with a record of all items received and issued. Or you can calculate consumption for each item by adding together all the stock issues made (to do this you need a record of all items issued).*

**Step 3: Adjust consumption figures for wastage or stockouts**

**Wastage**

Real consumption (RC) = Recorded consumption – Wastage (avoidable losses)

Real consumption = 4000 – 0 = 4000

AND/OR

**Stockout**

Adjusted real consumption =  $RC \times \frac{\text{Period in calculation (months, weeks, days)}}{\text{Period in stock (months, weeks, days)}}$

Adjusted real consumption =  $4000 \times \frac{12}{10} = 4800$  tablets

*Wastage of 5-10% is considered to be unavoidable, but you will need to adjust the consumption figure if it is more than 10%. You can estimate wastage by checking the number of patients treated and items issued. For example, if your stock records show that you have issued 4000 tablets, but have treated 300 patients with a course of 10 tablets each, totaling 3000, there are 1000 you cannot account for. Check to see how many are in the dispensary. If there are 600, you know 400 have been wasted, i.e. 10%. You will also need to adjust the consumption figure for any item that has been out of stock for more than 1 month during the time period using the stock out formula. NB: If there are no stockouts, no adjustment is made. If there is no wastage, the recorded consumption is the real consumption*

**Step 4: Adjust to time period or patient numbers for which quantification is needed**

**Time Period** (e.g. 12 months)

Annual consumption =  $\frac{\text{Adjusted real consumption} \times 12 \text{ months}}{\text{Months in stock}}$

Annual consumption =  $\frac{4000 \times 12}{10} = 4800$  tablets

OR

**Patient figures** (e.g. 10,000 patients)

Consumption per 1000 patients =  $\frac{\text{Adjusted real consumption} \times 1000}{\text{Total number of patients}}$

Consumption per 1000 patients =  $\frac{4800 \times 1000}{10,000} = 480$  tablets

So for 10,000 patients you need: 480 x 10 = 4800 tablets

*This step is not needed if you have data for the period in calculation, e.g. if you are calculating for 12 months and you have data for 12 months. However, if the data available is for less or more than 12 months then you need to adjust the figure, in the same way as for 'out of stock' adjustment in step 3.*

*Use the patient figure formula, if you need to calculate the consumption figure in terms of patient numbers, e.g. amount of item used per 1000 patients. The number, 1000 patients is used for ease of calculating needs and for planning.*

**Step 1: List the diseases and the number of cases requiring treatment (including different classifications for severity and age)**

See Table A4

*You should be able to obtain this information from routine health unit patient records. When using standard treatments, you have to consider that the dosage, or even the choice of drug, will be different, depending on whether the patient is an adult or child, also treatment will be different depending on the severity of the case. For example, you may need both IV fluid as well as ORS for treating diarrhoea.*

**Step 2: Add details and quantities of drug(s) for standard treatment of each disease**

For example, the standard treatment for headaches is Aspirin 300mg, 10 tablets per course.

If you have 2000 cases, you will need  $10 \times 2000 = 20,000$  Aspirin tablets.

*For each disease identify all the drugs, and the quantities of each, required for standard treatment. It is important to enter all drugs for a standard treatment of a particular condition.*

**Step 3: Multiply the number of treatments by the drug quantities for each treatment**

Total quantity of drugs required for given problem =  

$$\frac{\text{Drug quantity for standard treatment course}}{\text{treatment course}} \times \text{No. of treatment episodes of the disease}$$

*Calculate the total quantity of drugs and supplies required to treat a disease or health problem by multiplying the number of cases by the quantity of drugs needed for standard treatment of each case. A 'treatment episode' refers to a patient contact for which a standard course of drug treatment is required. Single patient contact may give rise to more than 1 treatment episode, if several health problems are identified and a standard course of treatment is required for each.*

**Step 4: Add up the total quantity of each drug required (the same drug may appear in several different standard treatments)**

For example, if Aspirin is used to treat headache and toothache you will need:

Headache: Aspirin 300mg, 10 tablets per course, if you have 2000 cases of headache, then you need 20,000 Aspirin tablets

Toothache: Aspirin 300mg, 16 tablets per course, if you have 40 cases of toothache, then you need 640 Aspirin tablets.

If there is no other use for Aspirin then the total requirement for Aspirin is 20,640 tablets (20,000 + 640) for a 12 month period

*As the example shows, the same drugs may be included in more than one standard treatment. If a drug is used to treat several health problems, add up the total quantity required.*

**Step 5: Adjust the total quantities to allow for unavoidable losses (wastage) due to damage or leakage**

*You will need to consider and adjust for possible losses of products, through damage or leakage. Generally, you need to add an extra 5-10% to the total quantities required, to allow for this loss. However, in practice, it is advisable to make specific adjustments for each type of drug or supplies, because some items are more likely to be damaged, broken or expire than others and the extra % required will vary.*

## Step 6: Adjust the quantities from Step 5 into (a) required number of order packs and (b) quantity required per 1000 treatment episodes or patient contacts

### (a) Order packs

To calculate the number of order packs, use the formula:

No. of order packs =

$$\frac{\text{Total quantities of item required (in counting units)}}{\text{Pack size in which sold (in counting units)}}$$

For example,

Aspirin 300mg is supplied in tins of 1000. If you need 20,640 tablets then you need:

$$\frac{20,640}{1000} = 21 \text{ tins}$$

### (b) Per 1000 treatment episodes or patient contacts:

To calculate the requirements per 1000 treatments episodes or per 1000 patients, depending on what information is routinely recorded, use the formula:

Per 1000 treatment episodes or 1000 patient contacts =

$$\frac{\text{Total quantity of each drug x 1000}}{\text{Total no. of treatment episodes or patient contacts of all kinds}}$$

For example,

Aspirin total order quantity is 20,640 tablets (using the above example) and treatment episodes of all kinds is e.g. 23,812, then you need:

$$\frac{20,640 \times 1000}{23,812} = 867 \text{ tablets/1000 treatment episodes}$$

*Quantities are calculated in counting or prescribing units, but many drugs are supplied in packs of e.g. 500, 1000 or 5000 tablets or capsules.*

*In this example you need to order 21 tins, rounding up to the nearest whole number.*

*The purpose of using a treatment episode or patient contact calculation is to enable drugs to be purchased and allocated to individual facilities according to the total number of treatment episodes or patient contacts that require that particular drug.*

*In this example, a health facility dealing with 1000 treatment episodes or patient contacts a year would need 867 aspirin tablets.*

Table A4 shows how morbidity data and standard treatment information can be used to calculate quantities of a drug needed to treat the number of treatment episodes of each health problem. (This is the same as Steps 1, 2 and 3 of the morbidity method). For every health problem (Column 1), there is a standard treatment (Columns 2 + 3) and a number of treatment episodes (Column 4). Multiplying Column 3 and Column 4 gives the total quantity of each drug required (Column 5) for treating the number of treatment episodes.

<b>Table A4 Calculating drug requirements by health problems</b>				
<b>1. Health problem</b>	<b>2. Standard treatment</b>	<b>3. Quantity per standard treatment</b>	<b>4. No. of treatment episodes</b>	<b>5. Total quantity</b>
<b>Acute Diarrhoea</b>				
S1: A (no dehydration)	ORS(1l)	2 pkt	2000	4000
S2: C (no dehydration)	ORS(1l)	1 pkt	1800	1800
S2: A (some dehydration)	ORS(1l)	6 pkt	1080	6480
S2: C (some dehydration)	ORS(1l)	2 pkt	1440	2880
<b>Malaria</b>				
S1: A	Chloroquine tab 150mg base	10 tabs	6552	65,520
S2: C	Chloroquine tab 150mg base	2.5 tabs	2760	6900
<b>Scabies A + C</b>	Benzybenzoate lotion 25%	60mls	840	50,400
<b>Conjunctivitis A + C</b>	Tetracycline oint 1% 5g tube	1 tube	1920	1920
<b>Common cold</b>				
A	Paracetamol tab 500mg	8	1440	11,520
C	Paracetamol tab 500mg	4	1200	4800
<b>Toothache</b>				
A	Acetylsalicyclic acid tab 300mg	16	2040	32,640
C	Paracetamol tab 500mg	4	720	2880

Key: S – Severity; A – Adult; C – Child

Source: Adapted from *Methods of Quantification in the Management of Drug Supplies: A Distance Learning Course* (Commonwealth Pharmaceutical Association [CPA]).

As discussed in Section 2.1, quantification is useful for estimating annual requirements, but actual consumption often tends to be different from this estimate and relying on quantification alone may result in shortages or stockouts. To calculate routine order quantity in an established setting that uses periodic ordering or places orders whenever the need arises, you need to use the stock record systems. With drugs, as for supplies, you need to calculate orders taking account of factors such as lead time, reserve stock, minimum and maximum stock levels.



# Appendix 3 Common instrument features

## Shape

The instruments may be:

**Straight**

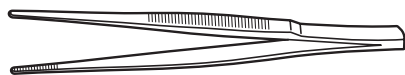

**Curved**

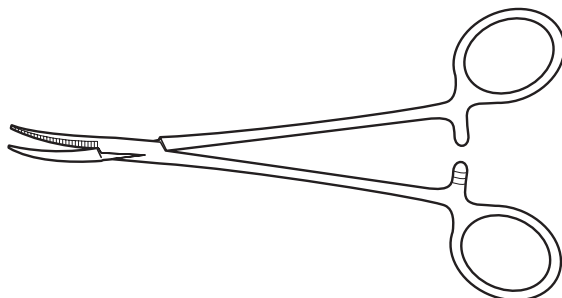

**Angled**

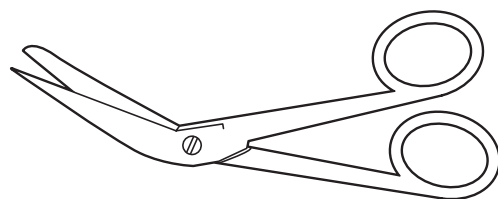

## Serrations and/or teeth

The instruments may have:

**Full serrations**



**Part serrations**

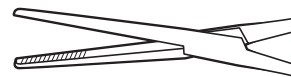

Instruments may have teeth as well as serrations and number of teeth will vary:

**1 x 2 teeth**



**2 x 3 teeth**



## Points

Instruments may be:

**Sharp/sharp**



**Blunt/blunt**



**Blunt/sharp**



**Round**



**Block**



**Angled**

