

# Medium Voltage technical guide

Basics for MV design according to IEC standards

2017 Edition



# General Contents

---

Presentations p. 4

---

Design rules p. 33

---

Switchgear definition p. 81

---

Units of measure p. 120

---

Standards p. 126

---

# Presentations

---

<b>MV Networks</b>	<b>p. 6</b>
<hr/>	
<b>Power transformers</b>	<b>p. 9</b>
General	p. 9
Service conditions	p. 10
Temperature rise limits	p. 11
Transformer Efficiency	p. 14
Voltage drop	p. 15
Parallel operation	p. 16
Three-Phase Common Transformer Vector Groups	p. 17
<b>Protection, Control and Monitoring</b>	<b>p. 18</b>
<hr/>	
<b>Smart grids</b>	<b>p. 19</b>
<hr/>	
<b>Environment</b>	<b>p. 20</b>
<hr/>	
<b>Prefabricated metal-enclosed and metal-clad switchgear</b>	<b>p. 22</b>
Introduction	p. 22
Voltage	p. 23
Current	p. 25
Frequency	p. 28
Switchgear functions	p. 28
Accessibility and service continuity	p. 29

---

(1) According to the IEC there is no clear boundary between medium and high voltage. Local and historical factors play a part, and limits are usually between 30 and 100 kV (see IEC 601-01-28). The publication IEC 62271-1:2011 "High-voltage switchgear and controlgear; common specifications" incorporates a note in its scope: "For the use of this standard, high voltage (see IEC 601-01-27) is the rated voltage above 1000 V. However, the term medium voltage (see IEC 601-01-28) is commonly used for distribution systems with voltages above 1 kV and generally applied up to and including 52 kV".

Protection of a power system depends on its architecture and the operating mode.

The term "medium voltage" is commonly used for distribution systems with voltages above 1 kV and generally applied up to and including 52 kV<sup>(1)</sup>.

For technical and economic reasons, the service voltage of medium voltage distribution networks rarely exceeds 36 kV.

The connection of an electrical installation to a MV utility distribution network is always realized by means of a dedicated MV substation usually designed "Main substation". Depending on its size and specific criteria, mainly related to the loads (Rated voltage, number, power, location, etc...), the installation may include additional substations designed "Secondary substations". The locations of these substations are carefully selected in order to optimize the budget dedicated to MV and LV power cables. These secondary substations are supplied from the main substation through the internal MV distribution.

Generally, most of the loads are supplied in low voltage by means of MV/LV step down transformers. Large loads such as asynchronous motors above or around 120kW are supplied in MV.

Only LV consumers are considered in this electrical guide. MV/LV step down power transformers are indifferently located either in the main substation or in the secondary substations. Small installations may only include a single MV/LV transformer installed in the main substation in most cases.

A main substation includes five basic functions:

- Function 1: Connection to the MV utility network
- Function 2: General protection of the installation
- Function 3: Supply and protection of MV/LV power transformers located in the substation
- Function 4: Supply and protection of the internal MV distribution
- Function 5: Metering.

A main substation includes basic devices:

- 1. Circuit breaker:** The circuit breaker is a device that ensures the control and protection of a network. It is capable of making, withstanding and interrupting load currents as well as fault currents, up to the short-circuit current of the network.
- 2. Switches:** The alternating current switches and switch-disconnectors for their switching function, with load making and breaking current ratings.
- 3. Contactors:** Contactors are used to switch off and to switch on loads requiring these operations during normal use, especially as used in a particular activity such as the MV public lighting and industrial motors.
- 4. Current-limiting fuses:** MV current-limiting fuses are primarily used in protection of transformers, motors and other loads. This is a device that, by the fusing of one or more of its specially designed and proportioned components, opens the circuit in which it is inserted when this exceeds a given value for a sufficient time. Current limiting fuses may have difficulties in clearing intermediate current values (exceeding service values by less than a factor of 6 to 10) and are therefore often combined with a switching device.
- 5. Disconnectors and earthing switches:** The disconnectors are used to get a separation between two circuits which could be live and independent, without impairing their insulation level. This is typically used at the open point of a loop network. They are often used to separate a part of installation from the power supply with better performances than those provided by another switching device. A disconnector is not a safety device. Earthing switches are dedicated devices to connect conductors to earth in a reliable manner so the conductors can be accessed safely. They may have a rated short-circuit making current to ensure they can withstand a mistake in operation like closing on live conductors.
- 6. Current transformer:** It is intended to provide a secondary circuit with a current proportional to the primary current (MV) current.

**7. Voltage transformer:** The voltage transformer is intended to provide its secondary circuit with a secondary voltage that is proportional to that applied to the primary circuit.

For installations including a single MV/LV power transformer, the general protection and the protection of the transformer are merged.

The metering can be performed either at MV level or at LV level. It is usually done at LV level for any installation including a single MV/LV transformer, provided that the rated power of the transformer remains below the limit fixed by the local utility supplying the installation.

In addition to the functional requirements the construction of both main and secondary substations shall comply with the local standards and regulation. IEC recommendations should also be taken into consideration in all circumstances.

The choice of neutral earthing for MV and HV power systems has long been a topic of heated controversy due to the fact that it is impossible to find a single compromise for the various types of power systems. Acquired experience now allows an appropriate choice to be made according to the specific constraints of each system.

### Power-system architecture

The various components of a power system can be arranged in different ways. The complexity of the resulting architecture determines the availability of electrical energy and the cost of the investment. Selection of an architecture for a given application is therefore based on a trade-off between technical necessities and cost.

Architectures include the following:

- radial systems
  - single-feeder,
  - double-feeder,
  - parallel-feeder,
- loop systems
  - open loop,
  - closed loop.
- systems with internal power generation
  - normal source generation,
  - replacement source generation.

### Earthing impedance

The neutral potential can be fixed or adjusted by five different methods of connection to the earth, according to type (capacitive, resistive, inductive) and the value (zero to infinity) of the impedance  $Z_N$ :

- $Z_N = \infty$  : isolated neutral, i.e. no intentional earthing connection,
- $Z_N$  is a resistance with a fairly high value,
- $Z_N$  is a reactance, with a generally low value,
- $Z_N$  is a compensation reactance, adjusted to compensate for the system capacitance,
- $Z_N = 0$ : the neutral is solidly earthed.

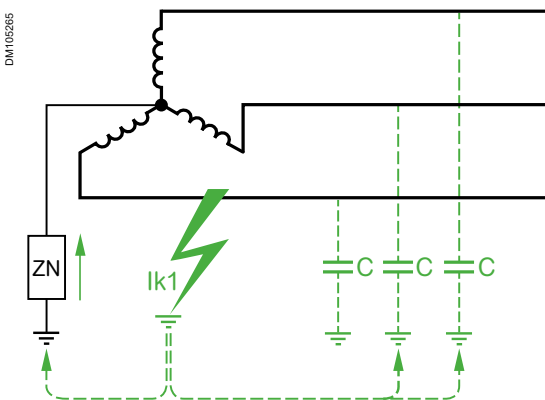

Equivalent diagram of a power system with an earth fault

## Difficulties and selection criteria

The selection criteria involve many aspects:

- Technical considerations (power system function, overvoltages, fault current, etc.);
- operational considerations (continuity of service, maintenance);
- safety (fault current level, touch and step voltages);
- cost (capital expenditure and operating expenses);
- local and national practices.

Two of the major technical considerations happen to be contradictory:

### Reducing the level of overvoltages

Excessive overvoltages may cause the dielectric breakdown of electrical insulating materials, resulting in short-circuits.

Overvoltages by installations have several origins:

- lightning overvoltage, by direct stroke or induced voltage on parts of overhead systems which are exposed, the overvoltage propagating to the user supply point and inside the installation;
- overvoltage within the system caused by switching and critical situations such as resonance;
- overvoltage resulting from an earth fault itself and its elimination.

### Reducing earth fault current (Ik1)

Fault current produces a whole series of consequences related to the following:

- damage caused by the arc at the fault point; particularly the melting of magnetic circuits in rotating machines;
- thermal withstand of cable shielding;
- size and cost of earthing resistor;
- induction in adjacent telecommunication circuits;
- danger for people created by the rise in potential of exposed conductive parts.

Reducing the fault current helps to minimize these consequences.

Unfortunately, optimizing one of these effects is automatically to the disadvantage of the other. Two typical neutral earthing methods accentuate this contrast:

- isolated neutral, which reduces drastically the flow of earth fault current through the neutral but creates higher overvoltages;
- solidly earthed neutral, which reduces overvoltage to a minimum, but causes high fault current.

As for the operating considerations, according to the neutral earthing method used:

- continued operation may or may not be possible under sustained first fault condition;
- the touch voltages are different;
- protection discrimination may be easy or difficult to implement.

An in-between solution is therefore often chosen, i.e. neutral earthing via an impedance.

## Summary of neutral earthing characteristics

Characteristics	Neutral earthing				
	Isolated	Compensated	Resistance	Reactance	Direct
Damping of transient overvoltages	-	+ -	+	+ -	++
Limitation of 50 Hz overvoltages	-	-	+	+	++
Limitation of fault currents	++	++	+	+	--
Continuity of service (no tripping, sustained fault means the fault current is much reduced)	+	+	-	-	-
Easy implementation of protection discrimination	-	--	+	+	+
No need for qualified personnel	-	-	+	+	+

+ advantage - particular attention



# Power transformers

## General

---

A power transformer is a static piece of equipment with two or more windings which, by electromagnetic induction, transforms a system of alternating voltage and current into another system of voltage and current usually of different values and at the same frequency for the purpose of transmitting electrical power.

Power transformers are covered by the series of standards IEC 60076 where the main requirements within MV networks are summarized as follows:

- IEC 60076-1 general;
- IEC 60076-2 temperature rise for liquid-immersed transformers;
- IEC 60076-7 loading guide for oil-immersed power transformers;
- IEC 60076-10 determination of sound levels;
- IEC 60076-11 dry-type transformers;
- IEC 60076-12 loading guide for dry-type power transformers;
- IEC 60076-13 self-protected liquid-filled transformers;
- IEC 60076-16 transformers for wind turbine applications.

According to the application guide, IEC 60076-8, it is intended to provide information needing for calculations during the parallel operation of transformers, voltage drops or rises under load, and load loss for three-winding load combinations. Information concerning loadability of power transformers is given in IEC 60076-7 for oil-immersed transformers, and IEC 60076-12 for dry-type transformers.

# Power transformers

## Service conditions

The standards define the normal service conditions for which the performances are specified.

These conditions are:

- **Altitude:** A height above sea-level not exceeding 1,000 m.
- **Temperature of cooling medium:**
  - The temperature of cooling air at the inlet to the cooling equipment
  - not exceeding: 40 °C at any time, 30 °C monthly average for the hottest month, 20 °C yearly average.
  - and not below: -25 °C in the case of outdoor transformers, -5 °C in the case of transformers where both the transformer and cooler are intended for installation indoors.

For water-cooled transformers, a temperature of cooling water at the inlet not exceeding: 25 °C at any time, 20 °C yearly average.

Further limitations, with regard to cooling are given for:

- liquid-immersed transformers in IEC 60076-2;
- dry-type transformers in IEC 60076-11.
- **Wave shape of supply voltage:** A sinusoidal supply voltage with a total harmonic content not exceeding 5 % and an even harmonic content not exceeding 1 %.
- **Load current harmonic content:** Total harmonic content of the load current not exceeding 5 % of rated current.

Transformers where total harmonic content of the load current exceeds 5% of rated current, or transformers specifically intended to supply power, electronic or rectifier loads should be specified according to IEC 61378 series, dealing with "converter transformers".

Transformers can operate at rated current without excessive loss of life with a current harmonic content of less than 5 %, however it should be noted that the temperature rise will increase for any harmonic loading and temperature rise limits at rated power may be exceeded.

- **Symmetry of three-phase supply voltage**
  - For three-phase transformers, a set of three-phase supply voltages which are approximately symmetrical.
  - "Approximately symmetrical" means that the highest phase-to-phase voltage is no more than 1% higher than the lowest phase-to-phase voltage continuously, or 2% higher for short periods (approximately 30 min) under exceptional conditions.
- **Installation environment**
  - An environment with a pollution rate (see IEC/TS 60815-1 for definition) that does not require special consideration regarding the external insulation of transformer bushings or of the transformer itself.
  - An environment not exposed to seismic disturbance which would require special consideration in the design (This is assumed to be the case when the ground acceleration level  $a_g$  is below 2 ms<sup>-2</sup> or approximately 0.2g).
  - When the transformer is installed in an enclosure not supplied by the transformer manufacturer, an attention shall be paid to assure a correct definition of the temperature rise limits of the transformer and the cooling capability of the enclosure which is defined by its own temperature rise class at full load (See IEC 62271-202).
  - Environmental conditions within the following definitions according to IEC 60721-3-4:
    - . climatic conditions 4K2 except that the minimum external cooling medium temperature is -25 °C;
    - . special climatic conditions 4Z2, 4Z4, 4Z7;
    - . biological conditions 4B1;
    - . chemically active substances 4C2;
    - . mechanically active substances 4S3;
    - . mechanical conditions 4M4.

For transformers intended to be installed indoors, some of these environmental conditions may not be applicable.

# Power transformers

## Temperature rise limits

Temperature rise limits are defined according to the temperature surrounding the transformer, taken as ambient temperature and the different load cycles of the transformer.

When transformer is installed within an enclosure, these temperature rise shall reflect the enclosure design. This enclosure is mainly defined by a temperature rise class and a degree of protection, both adapted to the local service conditions (See IEC 62271-202). For outdoor installation, to avoid any effect of solar radiation, it may be recommended to install a canopy over the transformer, and over a single layer of a non-thermal insulated metal enclosure, keeping the natural convection.

### Oil immersed transformer: Cooling methods

- First letter: Internal cooling medium:
  - O: mineral oil or synthetic insulating liquid with fire point  $\leq 300^\circ\text{C}$ ;
  - K: insulating liquid with fire point  $> 300^\circ\text{C}$ ;
  - L: insulating liquid with no measurable fire point.
- Second letter: Circulation mechanism for internal cooling medium:
  - N: natural thermo siphon flow through cooling equipment and in windings;
  - F: forced circulation through cooling equipment, thermo siphon flow in windings;
  - D: forced circulation through cooling equipment, directed from the cooling equipment into at least the main windings.
- Third letter: External cooling medium:
  - A: air;
  - W: water.
- Fourth letter: Circulation mechanism for external cooling medium:
  - N: natural convection;
  - F: forced circulation (fans, pumps).

If not otherwise agreed between manufacturer and purchaser, temperature rise limits are valid for both Kraft and upgraded paper (see also the "loading guide" IEC 60076-7).

Requirements for	Temperature rise limits K
Top insulating liquid	60
Average winding (by winding resistance variation):	
- ON... and OF... cooling systems	65
- OD... cooling system	70
Hot-spot winding	78

Recommended values of temperature rise corrections in case of special service conditions for air cooled oil immersed transformer.

Ambient temperatures $^\circ\text{C}$			Correction of temperature rise $\text{K}^{(1)}$
Yearly average	Monthly average	Maximum	
20	30	40	0
25	35	45	-5
30	40	50	-10
35	45	55	-15

(1) Refers to the values given in previous table

The loading guide IEC 60076-7 and the IEC 62271-202 standard explain the relation between the temperature rise of the transformer, the overheating due to the use of enclosure surrounding the transformer and its load factor as summarized here beside.

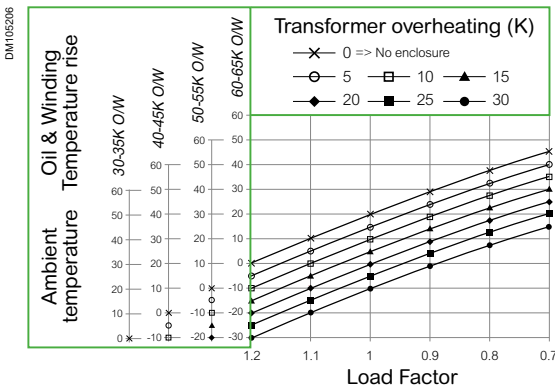

# Power transformers

## Temperature rise limits

### Dry type transformer: Cooling methods

Type of cooling medium is air which is defined by following letters:

- N when cooling is natural, air flow convection is generated by the transformer itself;
- G when cooling is forced, air flow being accelerated by fans.

Note: This air flow pushed through the windings of the transformer is preferred compared to any air flow pull by a fan installed on transformer room on a wall. However, both can be combined. When installed in an enclosure the limit of transformer load should be assessed, according to the temperature rises of the transformer and the enclosure according to IEC 62271-202.

The temperature rise of each winding of the transformer, designed for operation under normal service conditions, shall not exceed the corresponding limit specified in following table when tested in accordance IEC 60076-11.

The maximum temperature occurring in any part of the winding insulation system is called the hot-spot temperature.

The hot spot temperature shall not exceed the rated value of the hot-spot winding temperature specified in IEC 60076-11.

This temperature could be measured; however, an approximate value for practical purposes can be calculated by using the equation in IEC 60076-12 (Loading guide).

Insulation system temperature °C <sup>(1)</sup>	Average winding temperature rise limits at rated current K <sup>(2)</sup>	Maximum hot-spot winding temperature °C
105 (A)	60	130
120 (E)	75	145
130 (B)	80	155
155 (F)	100	180
180 (H)	125	205
200	135	225
220	150	245

(1) Letters refer to the temperature classifications given in IEC 60085.

(2) Temperature rise measured in accordance with temperature rise test of the IEC 60076-11.

When the transformer is installed inside a prefabricated substation the IEC 62271-202 standard is applicable, and the temperature rise class of the enclosure is defined, introducing requirements on the temperature behaviour of the substation (checked through a dedicated temperature rise test).

This class reflects the overheating of the transformer, compared with "open air".

The beside figure shows dry-type transformer load factor outside of the enclosure according to the electrical insulation system temperature of the transformer (see IEC 60076-11).

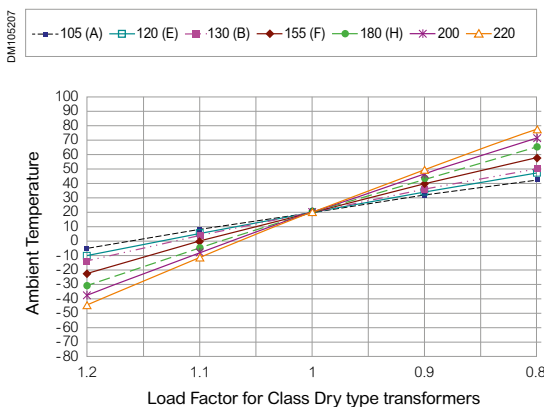

# Power transformers

## Temperature rise limits

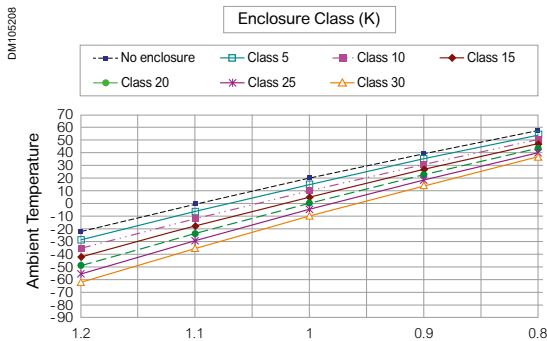

Note: Insulation class 155 °C (F) dry-type transformers load factor in an enclosure.

The beside figure shows the load factor of the dry type transformer depending on the class of the enclosure and for 155°C insulation system of the transformer. Respective figures for other insulation system can be found within IEC 62271-202.

The curves should be used as follows on the beside figure:

- a select the line for the class of enclosure;
- b select the average ambient temperature in a given period of time for the substation site on the vertical axis;
- c the intersection of the class of the enclosure line and the ambient temperature line gives the load factor of the transformer allowed.

### Overloading

#### Ambient Temperature

The rated power of the transformer is assigned for the normal service temperatures defined by the standards:

- maximum ambient temperature of 40°C
- average daily ambient temperature of 30°C
- average annual ambient temperature of 20°C

On request, transformers operating under different ambient temperature conditions can be produced.

#### Overloading

The rated overloading of a transformer depends on the transformer's previous load, the corresponding windings or oil temperature at the beginning of the overloading. Examples of the permissible duration and the respective levels of the acceptable overloadings are shown below in two different tables, respectively, for oil immersed and dry type transformers. For example, if the transformer is loaded with 50% of its rated power continuously, then the transformer can be overloaded to 150% or to 120%, only the time will be the difference

- Overloading for oil immersed transformer

Previous continuous loading	Oil temperature °C	Duration (min.) of overloading for specific levels of overloading (% of rated power)				
		10% min.	20% min.	30% min.	40% min.	50% min.
% of rated power	°C	10% min.	20% min.	30% min.	40% min.	50% min.
50	55	180	90	60	30	15
75	68	120	60	30	15	8
90	78	60	25	15	8	4

It should also be noted that the oil temperature is not a reliable measure for the winding temperature, since the time constant of the oil is 2 to 4 hours, while the time constant of the winding is 2 to 6 minutes. Therefore, the determination of the permissible duration of the overloading must be done very carefully, since there is a danger of the winding temperature exceeding the critical temperature of 105°C, without being visible for the oil temperature.

- Overloading for dry type transformer

According to IEC 60076-12 and for transformer with thermal class 155°C (F)

Previous continuous loading	Windings Temperature Winding / Hot Spot °C	Duration (min.) of overloading for specific levels of overloading (% of rated power) Max temperature for hot spot 145°C				
		10% min.	20% min.	30% min.	40% min.	50% min.
% of rated power	°C	10% min.	20% min.	30% min.	40% min.	50% min.
50	46/54	41	27	20	15	12
75	79/95	28	17	12	9	7
90	103/124	15	8	5	4	3
100	120/145	0	0	0	0	0

# Power transformers

## Transformer Efficiency

**Example:**

Let us assume that a three-phase transformer, 630 kVA, 20/0.4 kV, has 1200 W no-load losses and 9300 W load losses.

Determine the transformer efficiency at full load (case 1) and at 75% load (case 2) for power factor 1.0 and 0.8.

- Full load  $\cos\phi = 1$

$$\eta_{\text{asym}} = \frac{S \times \cos\phi}{S \times \cos\phi + \text{NLL} + \text{LL} \times (S/\text{SB})^2}$$

$$= \frac{630000 \times 1.0}{6300000 \times 1.0 + 1200 + 9300 \times (1.0)^2}$$

$$= 98.36 \%$$

- Full load  $\cos\phi = 0.8$

$$= \frac{630000 \times 0.8}{6300000 \times 0.8 + 1200 + 9300 \times (1.0)^2}$$

$$= 97.96 \%$$

- Load 0.75 &  $\cos\phi = 1$

$$\eta_{\text{asym}} = \frac{S \times \cos\phi}{S \times \cos\phi + \text{NLL} + \text{LL} \times (S/\text{SB})^2}$$

$$= \frac{0.75 \times 630000 \times 1.0}{472500 \times 1.0 + 1200 + 9300 \times (0.75)^2}$$

$$= 98.66 \%$$

- Load 0.75 &  $\cos\phi = 0.8$

$$= \frac{0.75 \times 630000 \times 0.8}{472500 \times 0.8 + 1200 + 9300 \times (0.75)^2}$$

$$= 98.33 \%$$

A high efficiency transformer corresponds to equipment designed for low level of losses to ensure reduced cost of ownership for end user.

The losses can be divided into two categories: load losses, which are proportional to the transformer load (square of current); and no-load losses, which are caused by the magnetisation of the core as long as the transformer is energised, and are constant - independent of the transformer load.

By reducing no-load losses, amorphous core transformers provide greater energy efficiency, as it consumes 70% to 80% less energy than conventional silicon steel transformers. They are thus more economical.

- What is Amorphous Core Technology?

Amorphous metal is a solid metallic material with high magnetic susceptibility and also rather high electrical resistance. The metal atoms are disordered and arranged in a non-crystalline way. Amorphous metal is easier to magnetise and demagnetize than conventional silicon steels. The thickness of the foils used for core, 0.02 mm is about 1/10 the thickness of conventional steel foils, also contributing to further decrease the losses (lower eddy currents).

**Advantages** of Amorphous Metal Magnetic Core

- Reduction of magnetising current;
- Lower temperature rise of core;
- Low-loss, especially no-load losses divided by three compare to conventional steel;
- Lower greenhouse emissions.

The following schema summarises the energy efficiency.

DM106269

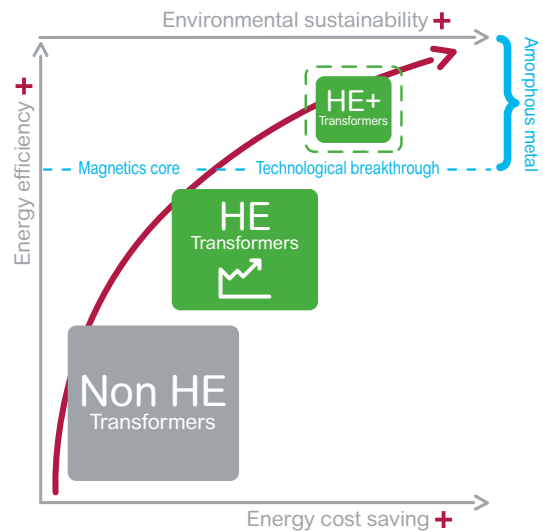

# Power transformers

## Voltage drop

**Example:**  
 Let us assume that a three-phase transformer, 630 kVA, 20/0.4 kV, has 9300 W load losses and 6% short-circuit impedance. Determine the voltage drop at full load (case 1) and at 75% load (case 2) for power factor 1.0 and 0.8. The voltage drop is given by the following equation:

- Full load  $\cos\phi = 1$   

$$U_{drop} = (1.0) \times (1.4762 \times 1 + 5.816 \times 0) + \frac{1}{2} \times \frac{1}{100} \times (1.0)^2 \times (1.4762 \times 0 + 5.816 \times 1)^2$$

$$= 1.645 \%$$
- Full load  $\cos\phi = 0.8$   

$$U_{drop} = (1.0) \times (1.4762 \times 0.8 + 5.816 \times 0.6) + \frac{1}{2} \times \frac{1}{100} \times (1.0)^2 \times (1.4762 \times 0.6 + 5.816 \times 0.8)^2$$

$$= 4.832 \%$$
- Load 0.75 &  $\cos\phi = 1$   

$$U_{drop} = (0.75) \times (1.476 \times 1 + 5.816 \times 0) + \frac{1}{2} \times \frac{1}{100} \times (0.75)^2 \times (1.476 \times 0 + 5.816 \times 1)^2$$

$$= 1.202 \%$$
- Load 0.75 &  $\cos\phi = 0.8$   

$$U_{drop} = (0.75) \times (1.476 \times 0.8 + 5.816 \times 0.6) + \frac{1}{2} \times \frac{1}{100} \times (0.75)^2 \times (1.476 \times 0.6 + 5.816 \times 0.8)^2$$

$$= 3.595 \%$$

The voltage drop is the arithmetic difference between the no-load voltage of a winding and the voltage developed at the terminals of the same winding at a specified load and power factor, with the voltage supplied to (one of) the other winding(s) being equal to:

- its rated value if the transformer is connected on the principal tapping (the no-load voltage of the winding is then equal to its rated value);
- the tapping voltage if the transformer is connected on another tapping.

This difference is generally expressed as a percentage of the no-load voltage of the winding.

Note: For multi-winding transformers, the voltage drop or rise depends not only on the load and power factor of the winding itself, but also on the load and power factor of the other windings (see IEC 60076-8).

### The need for voltage drop calculation

The IEC definitions concerning rated power and rated voltage of a transformer imply that rated power is input power, and that the service voltage applied to the input terminals for the active power (the primary terminals) should not, in principle, exceed the rated voltage. The maximum output voltage under load is therefore a rated voltage (or tapping voltage) minus a voltage drop. The output power at rated current and rated input voltage is, in principle, the rated power minus the power consumption in the transformer (active power loss and reactive power).

By North America habits, the MVA rating is based on maintaining the rated secondary voltage by impressing on the primary winding the voltage necessary to compensate for the voltage drop across the transformer at rated secondary current and at a lagging power factor of 80 % or higher.

The determination of the corresponding rated voltage or tapping voltage, which is necessary to meet a specific output voltage at a specific loading, therefore involves a calculation of voltage drop, using known or estimated figures of transformer short-circuit impedance.

$$U_{drop} = S/SB \times (e_r \cos\phi + e_x \sin\phi) + \frac{1}{2} \times \frac{1}{100} \times (S/SB)^2 \times (e_r \sin\phi + e_x \cos\phi)^2$$

Where respectively the resistive and reactive parts are:

<b>er</b>	The resistive part. $e_r = LL/SB$
<b>ex</b>	The reactive part. $e_x = \sqrt{(U_k^2 - e_r^2)}$

<b>Udrop</b>	Voltage drop ratio at a percentage of load	%
<b>LL</b>	Load losses	W
<b>SB</b>	Transformer power	W
<b>er</b>	Resistive part	VA
<b>Uk</b>	Short circuit impedance	%
<b>ex</b>	Reactive part	VA

**Example:**

Let us assume that three transformers operate in parallel.

The first transformer has 800 kVA rated power and 4.4% short-circuit impedance. The rated power and the short-circuit impedance of the other two transformers is 500 kVA and 4.8%, and 315 kVA and 4.0%, respectively. Calculate the maximum total load of the three transformers.

Among the three transformers, the third transformer has the minimum short-circuit impedance

- The load of transformer 1  

$$P_{n,1} = P_1 \times (U_{k,\min}) / (U_{k,1}) = 800 \times 4 / 4.4 = 728 \text{ kVA}$$
- The load of transformer 2  

$$P_{n,1} = P_2 \times (U_{k,\min}) / (U_{k,2}) = 500 \times 4 / 4.8 = 417 \text{ kVA}$$
- The load of transformer 3  

$$P_{n,1} = P_3 \times (U_{k,\min}) / (U_{k,2}) = 315 \times 4 / 4 = 315 \text{ kVA}$$
- The maximum load of the three transformers is:  

$$P_{\text{tot}} = P_{n,1} + P_{n,2} + P_{n,3}$$

$$= 728 + 417 + 315 = 1460 \text{ kVA}$$
- The three transformers have total installed power:  

$$P = P_1 + P_2 + P_3$$

$$= 800 + 500 + 315 = 1615 \text{ kVA}$$

From the above, it is concluded that the maximum total load (1460 kVA) represents the 90.4% of the total installed power (1615 kVA).

It should be noted that, in order the maximum total load to be equal to the total installed power, the transformers must have the same short-circuit impedance.

The informative annex of the IEC 60076-1 mentions it should be noted that while parallel operation is not unusual, it is advisable that users consult the manufacturer when paralleling with other transformers is planned and identify the transformers involved. If for a new transformer, parallel operation with existing transformer(s) is required, this shall be stated and the following information on the existing transformer(s) given:

- Rated power.
- Rated voltage ratio.
- Voltage ratios corresponding to tapings other than the principal tapping.
- Load loss at rated current on the principal tapping, corrected to the appropriate reference temperature.
- Short-circuit impedance on the principal tapping and on the extreme tapings, if the voltage on the extreme tapings is more than 5 % different to the principal tapping.
- Impedance on other tapings if available.
- Diagram of connections, or connection symbol, or both.

Note: On multi-winding transformers, supplementary information will generally be necessary.

In this section, parallel operation means direct terminal-to-terminal connection between transformers in the same installations. Only two-winding transformers are considered. This logic is also applicable to banks of three single-phase transformers. For successful parallel operation, the transformers require:

- the same phase-angle relation – clock-hour number (additional possible combinations are mentioned below);
- the same ratio with some tolerance and similar tapping range;
- the same relative short-circuit impedance – percentage impedance – with some tolerance. This also means that the variation of relative impedance across the tapping range should be similar for the two transformers.

These three conditions are elaborated further in the following sub-sections.

At enquiry stage, it is important that the specification for a transformer, which is intended for parallel operation with a specific existing transformer, contain the existing transformer information.

Some warnings are prudent in this connection.

- It is not advisable to combine transformers of widely different power rating (say, more than 1:2). The natural relative impedance for optimal designs varies with the size of the transformer.
- Transformers built according to different design concepts are likely to present different impedance levels and different variation trends across the tapping range.



# Power transformers

## Three-Phase Common Transformer Vector Groups

Phasor symbols	Terminal markings and phase displacement diagram		Winding connections	
	HV winding	LV winding		
Yy0				
Dd0				
Yd1				
Dy1				
Yd5				
Dy5				
Yy6				
Dd6				
Yd11				
Dy11				

# Protection, Control and Monitoring

---

Schneider Electric provides modern substation automation, protection, control and monitoring solutions for energy distribution from LV substations to EHV transmission grid solutions.

With leading expertise in protection, control and monitoring, and with worldwide presence, we focus on high quality, easy-to-use solutions with the latest industry standards and interoperability such as IEC 61850 to bring value throughout the entire energy lifecycle.

We provide products and solutions for the automation of energy in all segments including advanced solutions for Utilities. We master many domains including:

- Substation Control Systems
- Protection Relays
- MV Fault detection, Monitoring and Control
- RTUs
- Grid Automation Solutions

Advances in technology, together with significant changes in utility, industrial and commercial organizations, have resulted a new emphasis on secondary system engineering. In addition to the traditional roles of measurement, protection and control, secondary systems are now required to provide true added value to organisations such as reduction in lifetime cost of capital increasing system availability.

The evolution of all secondary connected devices to form digital control systems continues to greatly increase access to all information available within the substation, resulting in new methodologies for asset management.

In order to provide the modern, practicing substation engineer with reference material Schneider Electric produces a technical reference guide [1], dealing with all aspects of protection systems, from fundamental knowledge and calculations, basic technologies to topics like transient response and saturation problems that affect instrument transformers.

Useful links:

[1] See NPAG on Schneider Electric website.

Today's utilities have to transform into smart utilities. Those that succeed in this transition will operate an efficient smart grid, decarbonise their generation, and provide new services to their customers.

Schneider Electric shares [1][2] how utilities get started on this journey to becoming smarter utilities and how to address new business models while still attaining a high degree of grid reliability and safety.

Schneider Electric has a long history of involvement with the utility industry. Since the end of the 19<sup>th</sup> century, our experts have worked hand-in-hand with our utility partners to deliver stable power to homes and businesses.

Now the stakes are higher because the world is digitally connected, and human prosperity hinges upon the ability of power networks to deliver 24/7 around the globe.

Our people believe that our joint mission, can make life better for businesses and for the 1.3 billion people who have yet to access utility power. We are also keenly aware of the impact of power generation activities on the well-being of the planet.

Schneider also wrote this book [1] to describe how automation will help utilities modernize, extend their grids, and bridge the gap between information systems and operations to leverage data for improved customer service.

We discuss how utilities can better manage flexible demand to mitigate variable generation.

We also explore how utilities can cost-effectively enhance their plants, integrate renewables, and build micro-grids to generate cleaner, safer power.

The book includes the following chapters:

- 1 The utility industry: A current assessment
- 2 Asset management: Simplification despite big data proliferation
- 3 The smart grid: No longer just a myth
- 4 Ensuring nuclear stays relevant and contributes its share
- 5 Renewable energy integration: A delicate balancing act
- 6 Managing demand and the influence of 'Prosumers'
- 7 Why micro-grids are here to stay
- 8 Solving the riddle of network security
- 9 Outsource to accelerate: How to supersize skill levels

Useful links:

[1] [http://download.schneider-electric.com/files?p\\_Reference=SUBC1150901&p\\_File\\_Id=1725650608&p\\_File\\_Name=smart-utility-ebook-schneider-electric-chapter1.pdf](http://download.schneider-electric.com/files?p_Reference=SUBC1150901&p_File_Id=1725650608&p_File_Name=smart-utility-ebook-schneider-electric-chapter1.pdf)

[2] <http://schneider-electric.com/smart-utility-ebook>



The contribution of the whole electrical installation to sustainable development can be significantly improved through the design of the installation.

Actually, it has been shown that an optimised design of the installation, taking into account operating conditions, MV/LV substations location and distribution structure (switchboards, busways, cables, cooling methodology), can substantially reduce environmental impacts (raw material depletion, energy depletion, end of life), especially in term of energy efficiency.

Beside its architecture, environmental specification of the electrical component and equipment is a fundamental step for an eco-friendly installation, in particular to ensure proper environmental information and anticipate regulation.

In Europe several Directives concerning electrical equipment have been published, leading the worldwide move to more environmentally safe products.

### RoHS Directive (Restriction of Hazardous Substances)...

in force since July 2006 and revised on 2012. It aims to eliminate from products six hazardous substances: lead, mercury, cadmium, hexavalent chromium, polybrominated biphenyls (PBB) or polybrominated diphenyl ethers (PBDE) from most of end user electrical products.

Although electrical installations that are "large scale fixed installation" are not in the scope, RoHS compliance requirement may be a recommendation for a sustainable installation.

### WEEE

The purpose of WEEE Directive is to contribute to sustainable production and consumption by, as a first priority, the prevention of WEEE and, in addition, by the re-use, recycling and other forms of recovery of such wastes so as to reduce the disposal of waste and to contribute to the efficient use of resources and the retrieval of valuable secondary raw materials. It also seeks to improve the environmental performance of all operators involved in the life cycle of EEE, e.g. producers, distributors and consumers and, in particular, those operators directly involved in the collection and treatment of WEEE.

The WEEE Directive is applicable to all Member States of European Union. As for RoHS, electrical installations are not in the scope of this directive. However, End of Life Product information is recommended to optimise recycling process and cost.

Marking: In exceptional cases, where this is necessary because of the size or the function of the product, this symbol shall be printed on the packaging, on the instructions for use and on the warranty of the EEE.

- Medium voltage components are not in the EEE scope according to definition Art. 3.1. (a) of the WEEE Directive but attention shall be paid to electronic device embedded for monitoring.
- Energy Related Product, also called Eco-design.  
Apart for some equipment, such as lighting or motors, for which implementation measures are compulsory, there are no legal requirements that directly apply to installation. However, the trend is towards providing electrical equipment with their Environmental Product Declaration.  
This is also becoming true for Construction Products, in anticipation of Building Market future requirements.

## REACH: (Registration Evaluation Authorisation of Chemicals).

In force since 2009, is intended to control chemical use and restrict application when necessary, in order to reduce hazards to people and the environment. With regards to EE and installations, it calls for any supplier, upon request, to communicate to its customer the hazardous substances contained in its product (so called SVHC).

In this case, an installer must ensure that its suppliers have the appropriate information available. In other parts of the world, new legislation will follow the same objectives.

These European directives however are supported by international standards:

- Eco-design (IEC 62430),
- material and substance declaration (IEC 62474),
- RoHS compliance (IEC/TR 62476),
- recycling (IEC/TR 62635) and environmental declaration (PEP ecopassport® program) [2] (ISO 14025).

Some providers or suppliers may seek to meet the goals or requirements of these Directives and standards, beyond the scope of their own obligations.

Useful links:

[1] <http://www.pep-ecopassport.org/>

# Prefabricated metal-enclosed and metal-clad switchgear

## Introduction

---

To start with, here is some key information on MV switchboards! Reference is made to the International Electrotechnical Commission (IEC) and ANSI/IEEE.

All designers of medium-voltage installation using MV cubicle need to know the following basic magnitudes:

- Voltage
- Current
- Frequency
- Short-circuit power
- Service Conditions.
- Accessibility or Categories
- Degree of protection
- Internal Arc if applicable.

The voltage, the rated current and the rated frequency are often known or can easily be defined, but how can the short-circuit power or the short-circuit current at a given point in an installation be calculated?

Knowing the short-circuit power of the network allows the designer to choose the various parts of a switchboard which must withstand significant temperature rises and electrodynamic constraints. Knowing the service voltage (kV) will allow the designer to check, through insulation coordination, which dielectric withstand of the components is appropriate.

E.g.: circuit breakers, insulators, CT.

Disconnection, control and protection of electrical networks are achieved by using switchgear.

The classification of metal-enclosed switchgear is defined in the IEC standard 62271-200 globally and ANSI/IEEE C37.20.3 and IEEE C37.20.2 for America for markets under North-America influence, with a functional approach, using several criteria.

- Accessibility to compartments by persons
- Level of Loss of Service Continuity when a main circuit compartment is opened
- Type of metallic or insulated barriers, between live parts and opened accessible compartment
- Level of internal arc withstand in normal operating conditions.

# Prefabricated metal-enclosed and metal-clad switchgear

## Voltage

**Example:**

- Operating voltage 20kV
- Rated voltage 24kV
- Power frequency withstand voltage 50Hz 1min, 50kV rms
- Impulse withstand voltage 1.2/50 $\mu$ s: 125kV peak

### Operating voltage U (kV) of the network

It is applied across the equipment terminals.

It is the service or network voltage where the equipment is fitted. It is subjected to fluctuations linked to the network operation, load level, etc...

### Rated voltage Ur (kV) of the switchgear

This is the maximum rms (root mean square) value of the voltage that the equipment can withstand under normal operating conditions.

The rated voltage shall be selected higher than the highest value of the operating voltage and, is associated with an insulation level.

### Rated Insulation level Ud (kV, rms value) and Up (kV, peak value)

The insulation level is defined as a set of withstand voltage values and for Medium Voltage switchgear two withstand voltages are specified.

- **Ud: power frequency withstand voltage;** this withstand voltage is considered as covering all events at rather low frequency, typically overvoltages of internal origin, accompany all changes in the circuit: opening or closing a circuit, breakdown or shorting across an insulator, etc. The associated type test is specified as a power-frequency withstand test at rated value for a one-minute duration.
- **Up: lightning impulse withstand voltage;** this withstand voltage is considered as covering all events at high frequency, typically overvoltages of external origin or atmospheric origin occur when lightning falls on or near a line. The associated type test is specified as an impulse withstand test with a conventional wave shape (known as 1,2/50  $\mu$ s). This performance is also known as "BIL" for "Basic Impulse Level".

Note: IEC 62271-1:2011, article 4 sets the various voltage values together with, in article 6, the dielectric testing conditions. IEEE C37.100.1 shows rated insulation levels used in North America.

# Prefabricated metal-enclosed and metal-clad switchgear

## Voltage

### Standards

The table below mentions the rated voltage as defined by the IEC standard 62271-1:2011 common specifications for normal operating voltage in normal service conditions.

Rated voltage kV rms	Rated lightning impulse withstand voltage 1.2/50 $\mu$ s 50 Hz kV peak		Rated power-frequency withstand voltage 1 min kV rms	Normal operating voltage kV rms
	List 1	List 2		
7.2	40	60	20	3.3 to 6.6
12	60	75	28	10 to 11
17.5	75	95	38	13.8 to 15
24	95	125	50	20 to 22
36	145	170	70	25.8 to 36

Illustration of the IEC standardized voltages

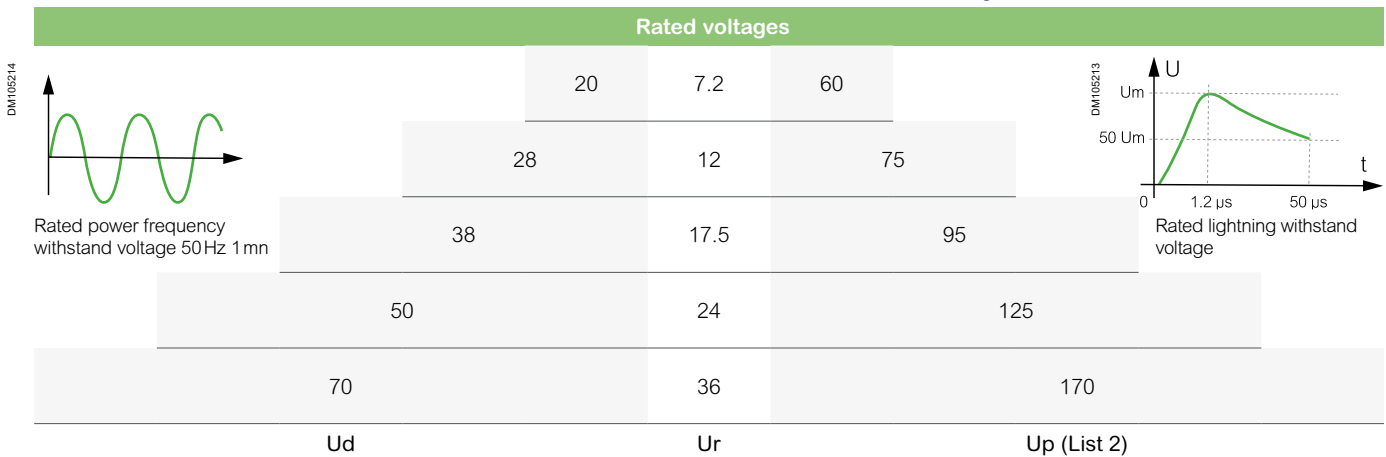

The values of withstand voltages in the tables are defined in normal services conditions at altitudes of less than 1000 metres, 20°C, 11 g/m3 humidity and a pressure of 101.3 kPa.

For other conditions, correction factors are applied for the tests. In case of use under different conditions, derating has to be considered.

For electrical installations, the relevant IEC 61936-1:2010, provides in its Table 1, clearances in air which are deemed to provide the required withstand voltage. Installations using such clearances do not need dielectric tests.

Rated voltage kV rms	Rated lightning impulse withstand voltage 1.2/50 $\mu$ s	Indoor distances to earth and phase to phase clearances in air cm
7.2	60	9
12	75	12
17.5	95	16
24	125	22
36	170	32



# Prefabricated metal-enclosed and metal-clad switchgear

## Current

### Rated normal current: $I_r$ (A)

This is the rms value of current that equipment can withstand when permanently closed, without exceeding the temperature rise allowed in the standards.

The table below gives the temperature rise limits authorised by the IEC 62271-1:2011 according to the type of contacts.

#### Temperature rise

Taken from table 3 of standard IEC 62271-1:2011 common specifications.

Nature of the part of the material and of the dielectric (Refer to points 1, 2 and 3) (Refer to note)	Temperature (°C)	( $\theta - \theta_n$ ) with $\theta_n = 40^\circ\text{CK}$
<b>1. Contacts (Refer to point 4)</b>		
Bare-copper or bare-copper alloy		
In air	75	35
In SF6 (Refer to point 5)	105	65
In oil	80	40
Silver-coated or nickel-coated (Refer to point 6)		
In air	105	65
In SF6 (Refer to point 5)	105	65
In oil	90	50
Tin-coated (Refer to point 6)		
In air	90	50
In SF6 (Refer to point 5)	90	50
In oil	90	50
<b>2. Connection bolted or the equivalent devices (Refer to point 4)</b>		
Bare-copper or bare-copper alloy or bare-aluminium alloy		
In air	90	50
In SF6 (Refer to point 5)	115	75
In oil	100	60
Silver-coated or nickel coated (Refer to point 6)		
In air	115	75
In SF6 (Refer to point 5)	115	75
In oil	100	60
Tin-coated (Refer to point 6)		
In air	105	65
In SF6 (Refer to point 5)	105	65
In oil	100	60

- Point 1** According to its function, the same part may belong to several categories as listed in table 3.
- Point 2** For vacuum switching devices, the values of temperature and temperature-rise limits are not applicable for parts in vacuum. The remaining parts shall not exceed the values of temperature and temperature-rise given in table 3.
- Point 3** Care shall be taken to ensure that no damage is caused to the surrounding insulating materials.
- Point 4** When engaging parts have different coatings or one part is of bare material, the permissible temperatures and temperature-rises shall be:  
a) For contacts, those of the surface material having the lowest value permitted in item 1 of table 3.  
b) For connections, those of the surface material having the highest value permitted in item 2 of table 3.
- Point 5** SF6 means pure SF6 or a mixture of SF6 and other oxygen-free gases.  
NOTE: Due to the absence of oxygen, a harmonization of the limits of temperature for different contact and connection parts in the case of SF6 switchgear appears appropriate. In accordance with IEC 60943 [1]1, which gives guidance for the specification of permissible temperatures, the permissible temperature limits for bare-copper and bare-copper alloy parts can be equalized to the values for silver-coated or nickel-coated parts in the case of SF6 atmospheres.  
In the particular case of tin-coated parts, due to fretting corrosion effects (refer to IEC 60943) an increase of the permissible temperatures is not applicable, even under the oxygen-free conditions of SF6. Therefore, the initial values for tin-coated parts are kept.
- Point 6** The quality of the coated contact shall be such that a continuous layer of coating material remains in the contact area:
- After the making and breaking test (if any),
  - After the short time withstand current test,
  - After the mechanical endurance test;
- according to the relevant specifications for each equipment. Otherwise, the contacts must be considered as "bare".

*N.B.: most common rated currents for MV switchgear are: 400, 630, 1250, 2500 and 3150 A.*

# Prefabricated metal-enclosed and metal-clad switchgear

## Current

The temperature limits and temperature rise of buses and connections shall not exceed the values listed in IEEE C37.20.2 for Metalclad, as summarised in the table below.

Type of bus or connection b,c,d <sup>(2)(3)(4)</sup>	Limit of hottest-spot temperature rise (°C)	Limit of hottest-spot total temperature (°C)
Buses and connections with unplated copper-to-copper connecting joints	30	70
Buses and connections silver-surfaced or equivalent connecting joints	65	105
Buses and connections tin-surfaced or equivalent connecting joints	65	105
Connection to insulated cables unplated copper-to-copper <sup>(1)</sup>	30	70
Connection to insulated cables silver-surfaced or equivalent <sup>(1)</sup>	45	85
Connections to insulated cables tin-surfaced or equivalent <sup>(1)</sup>	45	85

(1) Based on 90 °C insulated cable. The temperature of the air surrounding insulated cables within any compartment of an enclosed assembly shall not exceed 65 °C when the assembly is:  
 1. Equipped with devices having maximum current rating for which the assembly is designed.  
 2. Carrying rated continuous current at rated voltage and rated power frequency.  
 3. In an ambient air temperature of 40 °C.  
 This temperature limitation is based on the use of 90 °C insulated power cables. Use of lower temperature rated cables requires special consideration.  
 (2) All aluminum buses shall have silver-surfaced or equivalent, or tin-surfaced or equivalent connecting joints.  
 (3) Welded bus connections are not considered connecting joints.  
 (4) When buses or connections have differing materials or coatings, the allowable temperature rise and temperature values shall be those of the conductor or coating having the lowest value permitted in the table.

The temperature limits and temperature rise of connections shall not exceed the values listed in IEEE C37.20.3 for Metal enclosed, as summarised in the table below.

Nature of the part of the material and of the dielectric (Refer to point 1) (Refer to note)	Temperature (°C)	( $\theta - \theta_n$ ) with $\theta_n = 40^\circ\text{CK}$
<b>Connection bolted or the equivalent devices (Refer to point 1)</b>		
Bare-copper or bare-copper alloy or bare-aluminum alloy		
In air	70	30
Silver-coated or nickel-coated		
In air	105	65
Tin-surfaced		
In air	105	65

**Point 1** When engaging parts have different coatings or one part is of bare material, the permissible temperatures and temperature-rises shall be:  
 For connections, those of the surface material having the highest value permitted in this table.

# Prefabricated metal-enclosed and metal-clad switchgear

## Current

### Examples:

For a switchboard with a 630 kW motor feeder and a 1250 kVA transformer feeder at 5.5 kV operating voltage.

- Calculating the operating current of the transformer feeder; apparent power:

$$I = \frac{S}{U \times \sqrt{3}} = \frac{1250}{5.5 \times \sqrt{3}} = 130 \text{ A}$$

- Calculating the operating current of the motor feeder:  $\cos\phi$  = power factor = 0.9;  $\eta$  = motor efficiency = 0.9

$$I = \frac{S}{U \times \sqrt{3} \times \cos\phi \times \eta} = \frac{630}{5.5 \times \sqrt{3} \times 0.9 \times 0.9} = 82 \text{ A}$$

### Rated short-time withstand current: $I_k$ (A)

The r.m.s. value of the current which the switchgear and controlgear can carry in the closed position during a specified short-time under prescribed conditions of use and behaviour. Short-time is generally 1s, 2s and sometimes 3s.

### Rated peak withstand current: $I_p$ (A)

The peak current associated with the first major loop of the rated short-time withstand current which switchgear and controlgear can carry in the closed position under prescribed conditions of use and behaviour.

### Operating current: $I$ (A)

This is calculated from the consumption of the devices connected to the considered circuit. It is the current that really flows through the equipment. If the information is unknown, in order to calculate it, the customer should provide this information. The operating current can be calculated when the power of the current consumers is known.

### Minimal short-circuit current

$I_{sc \text{ min}}$  (kA rms value) of an electrical installation (see explanation in "Short-circuit currents" chapter.)

### Maximal short-circuit current

$I_{sc \text{ max}}$  (kA rms value 1s, 2s or 3 s) of an electrical installation (see explanation in "Short-circuit currents" chapter.)

### Peak value of maximal short-circuit

Value for an electrical installation: (value of the initial peak in the transient period) (see explanation in "Short-circuit currents" chapter.)

# Prefabricated metal-enclosed and metal-clad switchgear

## Frequency & Switchgear functions









### Frequency

Two frequencies are usually used throughout the world:  
 A short list could be summarized as follows, knowing some countries use both frequencies in different networks:

- 50 Hz in Europe – Africa – Asia - Oceania – South of South America except countries mentioned for 60Hz.
- 60 Hz in North America – North of South America – Kingdom of Saudi Arabia – Philippines –Taiwan – South Korea - South of Japan.

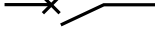
### Switchgear functions

The following table describes the different switching and protecting functions met in MV networks and their associated schema.

Designation and symbol	Function	Current switching	
		Operating current	Fault current
Disconnecter 	Isolates		
Earthing switch 	Connects to the earth		(short-circuit making capacity)
Load break switch 	Switches loads	•	
Disconnecting switch 	Switches Isolates	•	
Circuit-breaker 	Switches Protects	•	•
Contactor 	Switches loads	•	
Withdrawable contactor 	Switches Isolates if withdrawn	•	
Fuse 	Protects Does not isolate		• (once)
Withdrawable devices 	See associated function	See associated function	See associated function

• = yes

# Prefabricated metal-enclosed and metal-clad switchgear

## Accessibility and service continuity

---

Some parts of switchgear may be made accessible for the user, for various reasons from operation to maintenance, and such an access could impair the overall operation of the switchgear then decreasing the availability.

The IEC 62271-200 proposes user-oriented definitions and classifications intended to describe how a given switchgear can be accessed, and what will be the consequences on the installation. See IEEE C37.20.2 and C37.20.3 for enclosure categories for America.

The manufacturer shall state which are the parts of the switchgear which can be accessed, if any, and how safety is ensured. For that matter, compartments have to be defined, and some of them are going to be qualified as accessible.

Three categories of accessible compartments are proposed:

- **Interlock**-controlled access: the interlocking features of the switchboard ensure that opening is only possible under safe conditions
- **Procedure** based access: access is secured by means of, for instance, a padlock and the operator shall apply proper procedures to ensure safe access
- **Tool** based access: if any tool is needed to open a compartment, the operator shall be aware that no provision is made to ensure a safe opening, and that proper procedures shall be applied. This category is restricted to compartments where neither normal operation nor maintenance is specified.

When the accessibility of the various compartments is known, then the consequences of opening a compartment on the operation of the installation can be assessed; it is the concept of Loss of Service Continuity which leads to the LSC classification proposed by the IEC: "category defining the possibility to keep other high-voltage compartments and/or functional units energised when opening an accessible high-voltage compartment".

If no accessible compartment is provided, then the LSC classification does not apply.

Several categories are defined, according to "the extent to which the switchgear and controlgear are intended to remain operational in case access to a high-voltage compartment is provided":

- If any other functional unit, other than the one under intervention has to be switched off, then service is partial only: LSC1
- If at least one set of busbars can remain live, and all other functional units can stay in service, then service is optimal: LSC2
- If within a single functional unit, other compartment(s) than the connection compartment are accessible, then suffix A or B can be used with classification LSC2 to distinguish whether the cables shall be dead or not when accessing this other compartment.

**But is there a good reason for requesting access to a given function?**  
That's a key point.

# Prefabricated metal-enclosed and metal-clad switchgear

## Examples

PM102834



WI

### Example 1

Schneider Electric WI is a gas-insulated switchgear (GIS) with maintenance free vacuum circuit breaker (VCB) of first generation, launched in 1982, for up to 52kV in 600 mm cubicle width.

The tube design is typically coming from HV switchgears, but here with 3 phases per tube.

Switchgears in this upper MV segment are available as single- (SBB) and double-busbar (DBB) solution.

The circuit breaker and the busbar compartment are separated stainless steel tanks, filled with SF6-gas for insulation only.

Access is only given to the cable connection area, here from the switchgear back side. Tanks hermetically closed and earthed, means touchable under life, but considered as not accessible compartments. Loss of Service Continuity (LSC) is LSC2 and is defined by IEC 62271-200 standard.

PM103806



GHA

### Example 2

The more cubicle designed GIS (Schneider Electric GHA up to 40.5kV) with vacuum interrupters is designed to be filled with SF6-gas at the manufacturing site, in order to have no gas-handling on site.

All assembling is done in the factory with controlled conditions and the cubicles will be delivered on site "ready to connect".

Equipment in the gas-tank is maintenance free for its operational life time.

Components like instrument transformers or drive mechanism are located accessible outside the gas-compartment.

GHA is available as SBB and DBB solution. Design is metal enclosed and partition metal (PM) between the compartments with LSC2.

PE90687



CBGS-0

### Example 3

This SBB gas-insulated switchgear (Schneider Electric CBGS-0 up to 36kV/38kV) contains circuit-breaker and 3-position switch in one SF6-gas tank.

The busbar located on top, is a fully insulated, shielded and a connectable system. The busbar shielding is earthed and makes the busbar safe to touch.

Optionally instrument transformers can be installed in the busbar and cable compartment, accessible and outside the gas compartment.

All operation can be done from the front site to allow space saving rear wall installation.

Busbars and HV cables can be connected to a standard outer-cone bushing. Loss of Service Continuity (LSC) is defined by IEC 62271-200 to LSC2.

PE90206



GenieEvo

### Example 4

A mixed technology (Schneider Electric GenieEvo) with an air insulated connection compartment, and an air insulated main switching device which can be extracted with the busbar live, thanks to the disconnecter.

Single line diagram is similar to example 2.

If both the connection compartment and the circuit breaker compartment are accessible, and access to any of them means the cables are first switched off and earthed.

Category is LSC2A-PM.

# Prefabricated metal-enclosed and metal-clad switchgear

## Examples



### Example 5

A very classic structure of withdrawable air-insulated switchgear (Schneider Electric MCset), with interlock accessible compartments for the connections (and CTs) and the main switching device.

The withdrawing function provides the independence of the main switching device compartment from the other HV compartments; then, the cables (and of course the busbar) can remain live when accessing the breaker.

The LSC classification applies, and category is LSC2B-PM as Schneider-Electric PIX range.



### Example 6

A typical secondary distribution switch-disconnector switchgear, with only one interlock accessible compartment for the connection (Schneider Electric SM6).

When accessing one compartment within the switchboard, all other functional units are kept in service. Category is LSC2.

Similar situation occurs with most of the Ring Main Units solutions.



### Example 7

An unusual functional unit, available in some ranges: the metering unit which provides VTs and CTs on the busbar of an assembly (here a Schneider Electric RM6).

This unit has only one compartment, accessible to possibly change the transformers, or their ratio. When accessing such a compartment, the busbar of the assembly shall be dead, then preventing any service continuity of the assembly. This functional unit is LSC1.

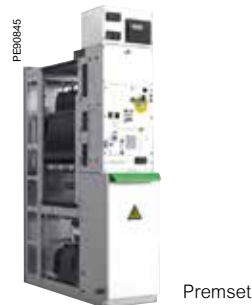

### Example 8

The new generation of MV Switchgear incorporates a wealth of innovations.

The Shielded Solid Insulation System (SSIS) drastically reduces the risk of internal arc faults, and makes it non sensitive to harsh environments.

A compact modular vacuum switchgear assembly (Schneider Electric PREMSET), with a wide choice of functions, designed to fit all applications.

This functional unit is LSC2A-PM.

# Design rules



---

<b>Service conditions</b>	<b>p. 34</b>
Normal service conditions for indoor MV equipment	p. 34
Special service conditions for indoor MV equipment	p. 35
How to specify real service conditions?	p. 36
<hr/>	
<b>Short-circuit power</b>	<b>p. 41</b>
Introduction	p. 41
<hr/>	
<b>Short-circuit currents</b>	<b>p. 42</b>
General	p. 42
Transformer	p. 43
Synchronous generators (alternators and motors)	p. 44
Asynchronous motor	p. 44
Reminder concerning the calculation of three-phase short-circuit currents	p. 45
Example of three-phase calculation	p. 48
<hr/>	
<b>Busbar calculation in switchgear</b>	<b>p. 51</b>
Introduction	p. 51
Thermal withstand	p. 52
Electrodynamic withstand	p. 56
Intrinsic resonant frequency	p. 58
Busbar calculation example	p. 59
<hr/>	
<b>Dielectric withstand</b>	<b>p. 66</b>
General	p. 66
The dielectric strength of the medium	p. 66
Dielectric tests	p. 67
The shape of parts	p. 71
Distance between parts	p. 71
<hr/>	
<b>Protection index</b>	<b>p. 73</b>
IP code according to IEC 60529 standard	p. 73
IK code	p. 74
NEMA classification	p. 75
<hr/>	
<b>Corrosions</b>	<b>p. 77</b>
Atmospheric	p. 77
Galvanic	p. 78
Atmospheric & Galvanic combined	p. 79

---

# Service conditions

## Normal service conditions for indoor MV equipment

Master the indoor service conditions contributes to master the lifespan of the electrotechnical components.

Before any description of the design rules for switchgear, it is necessary to recall where the switchgear should be installed.

MV switchgear is installed in various rooms with different designs which could affect ageing, or the expected lifespan, to a greater or lesser degree.

For this reason, it will be highlighted below, the impact of the service conditions linked to a design of an MV/LV installation.

Attention shall be paid to existing standardization differences within IEC for the service conditions between MV switchgear and LV switchgear, such as the altitude and the pollution levels as mains.

### Service conditions

The purpose of this chapter is to provide general guidelines to be taken into account during the design phases for services conditions.

The challenge for an operating room, prefabricated or not, is to transform the outdoor service conditions to the indoor service conditions for which the switchgears and controlgears are designed.

This chapter also provides guideline on how avoid or greatly reduce MV equipment degradation on sites exposed to humidity and pollution and overheating when installed in a transformer room with a non-adapted cooling system.

### Normal service conditions for indoor MV equipment

All MV equipment shall comply with their specific standards.

The IEC 62271-1 standard "Common specifications for high-voltage switchgear and controlgear" and the C37.100.1 for North America, define the normal service conditions for the installation and use of such equipment.

The ambient air temperature does not exceed 40 °C and its average value, measured over a period of 24 h, does not exceed 35 °C.

The preferred values of minimum ambient air temperature are -5 °C, -15 °C and -25 °C. For instance, regarding pollution, humidity associated with condensation, the standard states:

- **Pollution**  
The ambient air is not significantly polluted by dust, smoke, corrosive and/or flammable gases, vapours or salt. The manufacturer will assume that, in the absence of specific requirements from the user, there are none.
- **Humidity**  
The conditions of humidity are as follows:
  - The average value of the relative humidity, measured over a period of 24 h does not exceed 95%;
  - The average value of the water vapour pressure, over a period of 24 h does not exceed 2.2 kPa;
  - The average value of the relative humidity, over a period of one month does not exceed 90%;
  - The average value of water vapour pressure, over a period of one month does not exceed 1.8 kPa;

Under these conditions, condensation may occasionally occur.

NOTE 1: Condensation can be expected where sudden temperature changes occur in periods of high humidity.

NOTE 2: To withstand the effects of high humidity and condensation, such as a breakdown of insulation or corrosion of metallic parts, switchgear designed for such conditions should be used.

NOTE 3: Condensation may be prevented by special design of the building or housing, by suitable ventilation and heating of the station or by the use of dehumidifying equipment.



PM100021

# Service conditions

## Special service conditions for indoor MV equipoment

For installation in a place where the ambient temperature can be outside the normal service condition range stated, the preferred ranges of minimum and maximum temperature to be specified should be:

- a -50 °C and +40 °C for very cold climates;
- b -5 °C and +55 °C for very hot climates.

For instance, regarding pollution, humidity associated with condensation, the standard states:

- **Pollution**

For indoor installation, reference can be made to IEC/TS 62271-304 which defines design classes for switchgear and controlgear intended to be used in severe climatic conditions.

The severity classes 0, 1 and 2, are summarized as follows, where "L" is used for "Light" and "H" for "Heavy":

Pollution			
Severity		PL	PH
Condensation	CO	0	1
	CL	1	2
	CH	2	2

- **Humidity**

In certain regions with frequent occurrence of warm humid winds, sudden changes of temperature may occur resulting in condensation even indoors.

In tropical indoor conditions, the average value of relative humidity measured during a period of 24 h can be 98 %.

- **Others**

When special environmental conditions prevail at the location where switchgear and controlgear is to be put in service, they should be specified by the user by reference to IEC 60721.

# Service conditions

## How to specify real service conditions?

---

The various service conditions are linked to the design of the installation, the design of the operating room, the site and the application surrounding the installation, and finally, the seasons.

The combination of these parameters generates a matrix that can impact the lifespan of the products. Beyond atmospheric corrosion certain environments can become more severe for electrical MV components, and even in LV, if they have a definition of pollution level different in comparison with MV. The table below makes it possible to understand how applicable standards or technical specifications could interact, through easily identifiable installation criteria.

As indicated in the IEC 62271-1 standard, condensation may occasionally occur even under normal conditions. The standard goes on to indicate special measures concerning the substation facilities that can be implemented to prevent condensation.

However, when selecting environmental factors for a certain product application on-site it is recommended to check these conditions and influences for single, combined and sequential environmental factors as they occur. This analysis must be cross-checked with the ambient conditions for which the product has been designed, according to its respective standard.

### Use under severe conditions

Under certain severe conditions concerning humidity and pollution, largely beyond the normal conditions of use mentioned above, correctly designed electrical equipment can be subject to damage by rapid corrosion of metal parts and surface degradation of insulating parts.

### Remedial measures for condensation problems

- Carefully design or adapt substation ventilation.
- Avoid temperature variations.
- Eliminate sources of humidity in the substation environment.
- Install a Heating, Ventilation, Air Conditioning unit (HVAC)
- Make sure cabling is in accordance with applicable rules.

### Remedial measures for pollution problems

- Equip substation ventilation openings with chevron-type baffles to reduce entry of dust and pollution especially when the transformer is installed in the same room with switchgear or controlgear.
- Install the transformer in a different room, or use more efficient ventilation grids if any,
- Keep substation ventilation to the minimum required for evacuation of transformer heat to reduce entry of pollution and dust.
- Use MV cubicles with a sufficiently high degree of protection (IP).
- Use air conditioning systems or air forced cooling with filters installed in air inlet to restrict entry of pollution and dust.
- Regularly clean all traces of pollution from metal and insulating parts

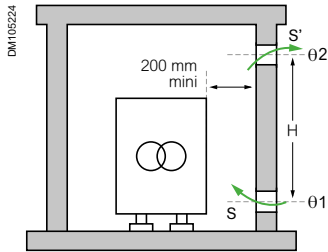
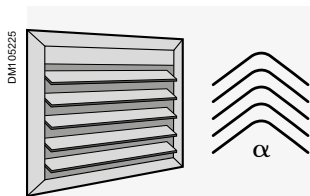

Fig. A Natural ventilation



**IP23 Chevrans blade**

( $\xi = 33$  if  $\alpha = 60^\circ$ , and  $\xi = 12$  if  $\alpha = 90^\circ$ )

Space between blade is extended to the maximum allowed by the degree of protection IP2x so below 12.5mm.

**Other openings:**

IP43 Additional vermin proof wire mesh with 1mm<sup>2</sup> openings using a wire thickness 0.6mm, complete covering ventilation grid  $\geq \xi + 5$

IP23 38mm x 10mm openings only:  $\xi = 9$

Fig. B Coefficient of pressure losses defined by air flow tests

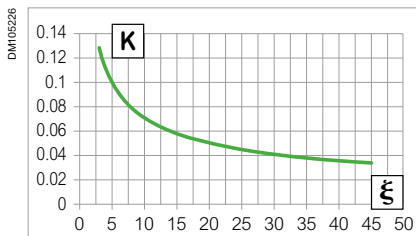

Fig. C Impact of the ventilation grids

### Ventilation

#### General

Substation ventilation is generally required to dissipate the heat produced by transformers and other equipment, and to allow drying after particularly wet or humid periods. However, a number of studies have shown that excessive ventilation can drastically increase condensation.

#### HV/LV Prefabricated substation

Any installation of any transformer in the same room with HV and LV switchgear compartment will impact the lifespan of the products, for the following reasons:

- Any air change generated by the transformer heating reduces the impact of irradiance. This air flow change is natural convection.
- Any separation of the transformer by a partition wall with the HV and LV switchgear compartment will improve the service condition of the switchgear for moderate climates.
- Any switchgear installation without a transformer in the room, resulting in no air change, should be installed in a thermal insulated enclosure protecting it from outdoor service conditions (Dust, humidity, solar radiation...) especially for very hot and cold climates.

Ventilation should therefore be kept to the minimum level required.

Furthermore, ventilation should never generate sudden temperature variations that can cause the dew point to be reached.

For this reason, natural ventilation should be used whenever possible. If forced ventilation is necessary, the fans should operate continuously to avoid temperature fluctuations. When forced ventilation is not enough to assure the indoor service condition of the switchgear or when the installation surrounding is a hazardous area, HVAC unit will be necessary to separate completely the indoor service conditions from the outdoor service conditions.

Natural ventilation, Fig A, being the most used for MV installations, a guideline for sizing the air entry and exit openings of HV/LV substations is presented hereafter.

#### Calculation methods

The scope is for buildings and prefabricated enclosures using same ventilation grids for air inlet and air outlet. A number of calculation methods are available to estimate the required size of substation ventilation openings, either for the design of new substations or the adaptation of existing substations for which condensation problems have occurred.

The basic method is based on transformer dissipation by natural convection.

The required ventilation opening surface areas S and S' can be estimated using the following formulas, with or without knowing the air flow resistance coefficient of the ventilation grids See Fig B. The definitions of terms are on next page.

1  $Q_{nac} = P - Q_{cw} - Q_{af}$  is the dissipation by natural air circulation [kW]

2

-  $S = 1.8 \times 10^{-1} Q_{nac} / \sqrt{H}$  if air flow resistance is unknown  
 $S' = 1.1 \times S$  - S and S' are efficient net area.

- Chevrans blade

$S = Q_{nac} / (K \times \sqrt{H \times (\theta_2 - \theta_1)^3})$  with  $K = 0.222 \sqrt{1/\xi}$  see Fig C  
 $S' = 1.1 * S$  - S and S' are the gross area.

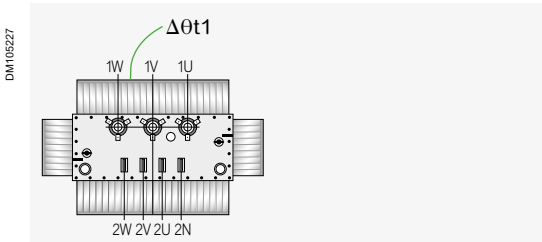

$\Delta\theta_{t1} = t_{t1} - t_{a1}$  where  $t_{t1}$  is the temperature 1 of the transformer at rated power (IEC 60076-2:2011 and IEC 60076-11:2004) and  $t_{a1}$  is the ambient temperature1 of the room.

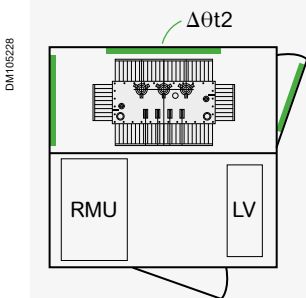

$\Delta\theta_{t2} = t_{t2} - t_{a2}$  where  $t_{t2}$  is the temperature 2 of the transformer at rated power (IEC 60076-2:2011 and IEC 60076-11:2004) and  $t_{a2}$  is the ambient temperature2 (Outside of the enclosure)

Fig D  $\Delta\theta_{t2} - \Delta\theta_{t1}$  is the overheating of the transformer due the use inside housing

Where:

$Q_{nac}$  is the dissipation by natural air circulation [kW]

$P$  is the sum of the power dissipated [KW] by:

- The transformer (dissipation at no load and due to load)
- The LV switchgear
- The MV switchgear

$Q_{cw}$  is the heat dissipation by conduction through the walls and ceiling [kW]

(Assumption  $Q_{cw} = 0$  in the example) Losses by conduction through the walls, the ceiling ( $Q_{cw}$ ) and the slab can be expected from 200W for a thermal insulated housing, up to 4kW for a 10m<sup>2</sup> prefabricated substations using concrete material.

$Q_{af}$  is the heat dissipation by forced air circulation [kW] (Assumption  $Q_{af} = 0$  in example)  $\theta_1$  &  $\theta_2$  are, respectively, the air temperatures of inlet and outlet [°C]  $\xi$  is the resistance coefficient of the pressure losses linked to the design of the ventilation grid.

$S$  is the lower (air entry) ventilation opening area [m<sup>2</sup>] as mentioned formulas 2.1 and 2.2

$S'$  is the upper (air exit) ventilation opening area [m<sup>2</sup>] as mentioned formulas 2.1 and 2.2

$H$  = Difference in height between mid-outlet surface and mid-height of transformer [m]

$(\theta_2 - \theta_1)$  is the air temperature rise which reflects the double of the transformer overheating for an oil immersed transformer (Loading guide IEC 60076-7)

and the single transformer overheating for dry-type transformer (Loading guide IEC 60076-11).

The overheating of the transformer is an extra temperature rise.

It is the maximum top oil temperature rise limit (See Fig E1) for liquid filled transformers or the average winding temperature rise (See Fig E2) for dry-type transformer due to the installation inside an enclosure.

Example: 60K for oil temperature rise of a liquid filled transformer will become 70K if it is overheating inside an enclosure is expected at 10K.

The formula 2.2 is near the formula 2.1 if  $\Delta\theta = (\theta_2 - \theta_1) = 15K$ , and if  $\xi=5$  then  $K = f(\xi) = 0,1$ . This is equivalent to free opening, without ventilation grid.

When  $K=0,1$  the formula 2.2 is the formula used in IEC 60076-16 standard for transformers for wind turbine applications.

When these transformer overheating are assessed by a test type according to IEC 62271-202 (HV/LV prefabricated substations) this overheating is the rated enclosure class. This overheating, combined to the average temperature, gives the load limit factor for maintaining the expected transformer lifespan according to the IEC transformer loading guides.

The oil and windings transformer temperature rise for oil immersed transformers and the temperature class of the insulating materials for dry-type transformers are linked to the ambient temperature as defined by the IEC 60076 series. Usually, under normal service conditions, a transformer is defined to be used at 20°C for yearly average, 30° monthly and 40°C at maximum.

For a masonry substation, the overheating of the transformer is considered unknown, as the calculation shall define the ventilation areas  $S$  and  $S'$ .

So only the ambient temperature and load factor can be known.

The following examples explain how to assess the overheating of transformer, then the temperature rise of air  $(\theta_2 - \theta_1)$  by using formulas 2.2.1 and 2.2.2.

Process to use graphs Fig E

- Select the average ambient temperature in a given period of time for the substation site on the vertical axis;
- Select the load factor of the transformer
- The intersection gives an expected overheating of the transformer corresponding to the maximum top oil temperature rise limit for liquid filled transformers (See Fig E1) or the average winding temperature rise for dry-type transformers (See Fig E2) (See 1.2.3 for wider graph)

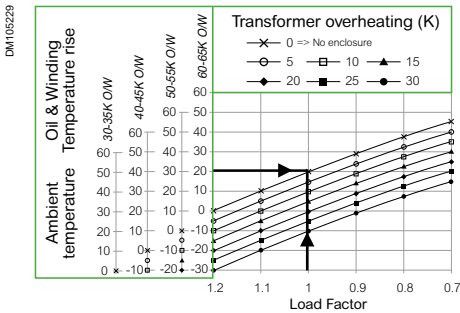

Fig E1 Liquid filled transformer load factor

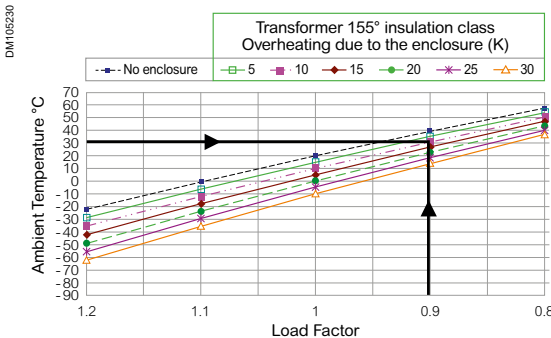

Fig E2 Dry-type transformer load factor (155°C insulation class)

Fig E Load factor limits

**Example for HV/LV substation:**

Oil immersed transformer 1 250 kVA  
 Ao (950W No load losses) Bk (11 000W Load losses)  
 Transformer dissipation = 11950 W  
 LV switchgear dissipation = 750 W  
 MV switchgear dissipation = 300 W  
 H the height between ventilation opening mid-points is 1.5 m.  
 $\xi$  is 12 for chevrons louvers if  $\alpha = 90^\circ$  then  $K = 0.064$   
 $(\theta_2 - \theta_1)$  air temperature rise taken at 20K for expected transformer overheating at 10K

**Calculation:**

Dissipated Power  $P = 11,950 + 0,750 + 0,300 = 13,000$  kW

Formula 2.1:

$$S = 1.8 \times 10^{-1} \frac{Q_{nac}}{\sqrt{H}}$$

$S = 1.91 \text{ m}^2$  and  $S' 1.1 \times 1.91 = 2.1 \text{ m}^2$  (Net area)

Formula 2.2: Chevrons Blade

$$S = \frac{Q_{nac}}{K \times \sqrt{(H \times (\theta_2 - \theta_1)^3)}}$$

$S = 1.85 \text{ m}^2$  and  $S' 1.1 \times S = 2.04 \text{ m}^2$  (Gross area)

Three ventilations with the following dimensions.

See Fig F: 1.2m x 0.6m, 1.4m x 0.6m, 0.8m x 0.6 give a gross area  $S'$  at 2.04m<sup>2</sup>

Conclusion: Accurate knowledge of the air flow resistance coefficient will optimize the sizing of ventilation if  $\xi < 13$  and if the ventilation grids are the same for air inlet and air outlet. An example is showed Fig G.

Examples:

- Moderate climate: 10°C as yearly average using a 60-65K respectively for oil and winding temperature rise of the transformer, can be used at full load. Expected overheating is 10K when air temperature rise  $(\theta_2 - \theta_1)$  is expected at 20K.
- Hot Climate: 30°C as summer average using 50-55K respectively for oil and winding temperature rise transformer can be used with a load factor at 0.9. Expected overheating is 10K when air temperature rise  $(\theta_2 - \theta_1)$  is expected at 20K.
- Cold Climate: -20°C as winter average using 60-55K respectively for oil and winding temperature rise transformer can be used with a load factor at 1.2. Expected overheating is 20K when air temperature rise  $(\theta_2 - \theta_1)$  is expected at 40K.
- Hot Climate: 30°C as summer average using a dry-type transformer at 155°C insulation thermal class can be used with a load factor at 0.9. Expected overheating is 10K when air temperature rise  $(\theta_2 - \theta_1)$  is expected at 10K.

For prefabricated substation, the overheating of the transformer at full load is known due the temperature rise class of the enclosure defined by type test. Any use with a defined enclosure class, limited by the maximum losses, will adapt the transformer load factor to the ambient temperature to assure the transformer lifespan.

The calculation methods use formulas reflecting specific cases of a general formula based on the Bernouilli equation and the stack effect due the transformer heating, ensuring the natural convection inside the transformer compartment as required by the IEC 62271-202 standard.

Indeed, the real air flow is strongly dependant:

- on the openings shape and solutions adopted to ensure the cubicle protection index (IP): metal grid, stamped holes, chevron louvers... Figure B
- on transformer temperature rise and overheating in °K (class) due to the use in an envelope as mentioned in Figure E.
- on internal components size and the whole layout as follows:
  - transformer and/or retention oil box position
  - distance from the transformer to the openings
  - transformer in a separate room using partition wall
- and on some physical and environmental parameters as follows:
  - outside ambient temperature  $\theta_1$  used in equation 2.2)
  - altitude
  - solar radiation

The understanding and the optimization of the related physical phenomena are subject to precise flow studies, based on fluid dynamics laws, and realized with specific analytic software. These can be separated in two categories as follows:

- Software used for thermo-dynamic studies of the building dedicated to for energy management for building efficiency.
- Software used for air flow study, especially when a component embeds its own air cooling system (Inverter, Grid Frequency Converter, Data centres...)

# Service conditions

## How to specify real service conditions?

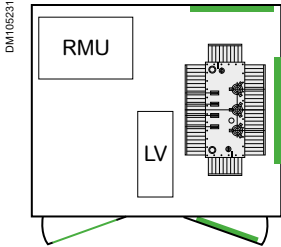

Fig F Example of layout for 13kW of total losses  $\Delta\theta_2 - \Delta\theta_1 =$  Air temperature rise = 20K corresponding to transformer overheating at 10K

### Ventilation opening locations

To favour evacuation of the heat produced by the transformer via natural convection, ventilation openings should be located at the top and bottom of the wall near the transformer. The heat emitted by the MV switchboard may be negligible. To avoid condensation problems, the substation ventilation openings should be located as far as possible from the switchboards (see Fig. H).

### Type of ventilation openings

To reduce the entry of dust, pollution, mist, etc., the substation ventilation openings should be equipped with chevron-blade baffles when the transformer is installed in a same room with the switchboards, otherwise a use of higher efficiency ventilation grids is allowed, and, especially, advised when total losses are above 15kW. Always make sure the baffles are oriented in the right direction (see Fig. B).

### Temperature variations inside cubicles

To reduce temperature variations, always install anti-condensation heaters inside MV cubicles if the average relative humidity may remain high over a long period of time. The heaters must operate continuously, 24 hours a day, all year long. Never connect them to a temperature control or regulation system as this could lead to temperature variations and condensation as well as a shorter service life for the heating elements. Make sure the heaters offer an adequate service life (standard versions are generally sufficient).

### Temperature variations inside the substation

The following measures can be taken to reduce temperature variations inside the substation:

- Improve the thermal insulation of the substation to reduce the effects of outdoor temperature variations on the temperature inside the substation.
- Avoid substation heating if possible. If heating is required, make sure the regulation system and/or thermostat are sufficiently accurate and designed to avoid excessive temperature swings (e.g. no greater than 1°C). If a sufficiently accurate temperature regulation system is not available, leave the heating on continuously, 24 hours a day all year long.
- Eliminate cold air drafts from cable trenches under cubicles or from openings in the substation (under doors, roof joints, etc.).



Fig G Example of HV/LV prefabricated substation with 1250 kVA liquid filled transformer, 19kW of losses before EU regulation change

### Substation environment and humidity

Various factors outside the substation can affect the humidity inside.

- Plants: Avoid excessive plant growth around the substation, and any closing or opening.
- Substation waterproofing: The substation roof must not leak. Avoid flat roofs for which waterproofing are difficult to implement and maintain.
- Humidity from cable trenches: Make sure cable trenches under any switchgear are dry. Tight cable penetration could be used if any. A partial solution is to add sand to the bottom of the cable trench avoiding any evaporation within the switchgear.

### Pollution protection and cleaning

Excessive pollution favours leakage current, tracking and flashover on insulators. To prevent MV equipment degradation by pollution, either protect the equipment against pollution or regularly clean the resulting contamination.

### Protection from harsh environment by enclosure

Indoor MV switchgear can be protected by enclosures providing a sufficiently high degree of protection (IP).

### Cleaning

If not fully protected, MV equipment must be cleaned regularly to prevent degradation by contamination from pollution. Cleaning is a critical process.

The use of unsuitable products can irreversibly damage the equipment. For cleaning procedures, operating instructions of the switchgear shall be applied.

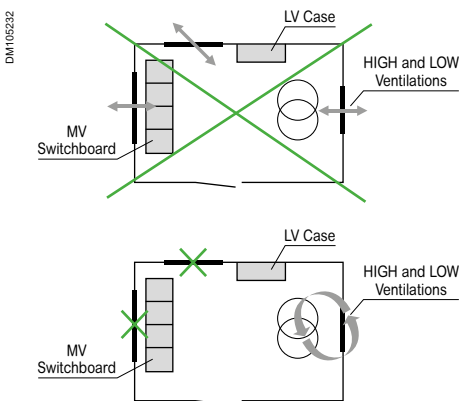

Fig. H Ventilation opening locations



# Short-circuit power

## Introduction

**Example 1:**

25 kA at an operating voltage of 11 kV

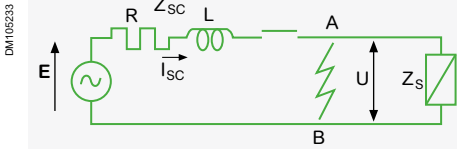

$$S_{sc} = 3 \times U \times I_{sc}$$

**Example for HV/LV substation**

**Example 2:**

Back-feed via LV I<sub>sc5</sub> is only possible if the transformer (T4) is powered by another source, and the LV tie-breaker is closed.

Three sources are flowing in the switchboard (T1-A-T2) with a possible contribution to a fault from T3 and M:

- Upstream circuit breaker D1 (s/c at A)  
I<sub>sc2</sub> + I<sub>sc3</sub> + I<sub>sc4</sub> + I<sub>sc5</sub>
- Upstream circuit breaker D2 (c/c at B)  
I<sub>sc1</sub> + I<sub>sc3</sub> + I<sub>sc4</sub> + I<sub>sc5</sub>
- Upstream circuit breaker D3 (c/c at C)  
I<sub>sc1</sub> + I<sub>sc2</sub> + I<sub>sc4</sub> + I<sub>sc5</sub>

The short-circuit power depends directly on the network configuration and the impedance of its components: lines, cables, transformers, motors... through which the short-circuit current flows.

It is the maximum power that the network can provide to an installation during a fault, expressed in MVA or in kA rms value for a given operating voltage.

U: Operating voltage (kV)

I<sub>sc</sub>: Short-circuit current (kA rms value) Ref: following pages

The short-circuit power can be assimilated to an apparent power.

The customer generally needs to be informed of the value of short-circuit power because usually the information required to calculate it are unknown. Determination of the short-circuit power requires analysis of the power flows feeding the short-circuit in the worst possible case.

Possible Sources are:

- Network incomer via power transformers.
- Generator incomer.
- Power back-feed due to rotary sets (motors, etc); or via MV/LV transformers.

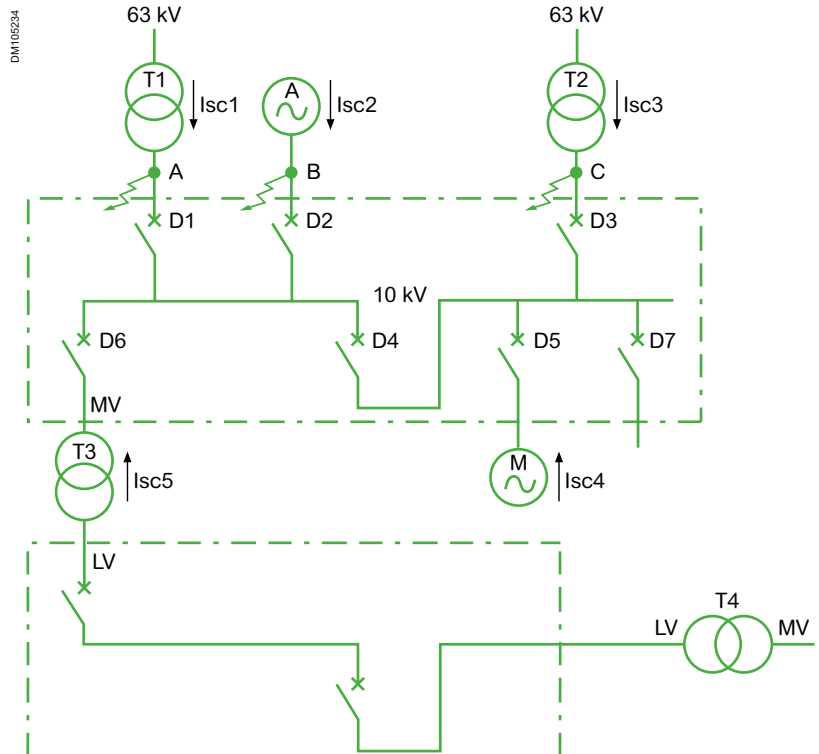

We have to calculate each of the I<sub>sc</sub> currents.

# Short-circuit currents

## General

All electrical installations have to be protected against short-circuits, without exception, whenever there is an electrical discontinuity; which more generally corresponds to a change in conductor cross-section. The short-circuit current shall be calculated at each stage in the installation for the various configurations that are possible within the network, in order to determine the characteristics of the equipment that has to withstand or break this fault current

In order to choose the right switchgear (circuit breakers or fuses) and set the protection functions, three short-circuit values must be known:

### Short-circuit current

$I_{sc}=(kA \text{ rms})$  (example 25 kA rms)

This corresponds to a short-circuit at one end of the protected link (fault at the end of a feeder (see fig.1) and not just behind the breaking device. Its value allows us to choose the setting of thresholds for overcurrent protection relays and fuses; especially when the length of the cables is high and/or when the source is relatively impedant (generator, UPS).

### rms value of maximal short time current

$I_{th}=(kA \text{ rms } 1 \text{ s or } 3 \text{ s})$  (example 25kA rms 1s)

This corresponds to a short-circuit in the immediate vicinity of the downstream terminals of the switching device (see fig.1). It is defined in kA for 1, 2 or 3 second(s) and is used to define the thermal withstand of the equipment.

### Peak value of the maximum short-circuit current:

(value of the initial peak in the transient period)

$I_{dyn}=(kA)$

(example:  $2.5 \cdot 25 \text{ kA} = 62.5 \text{ kA}$  peak for a DC time-constant of 45 ms and a frequency of 50 Hz (IEC 62271-1)

$I_{dyn}$  is equal to:

2.5 x  $I_{sc}$  for 50 Hz, for a DC time-constant of 45 ms

2.6 x  $I_{sc}$  for 60 Hz, for a DC time-constant of 45 ms

2.7 x  $I_{sc}$  for special time constants greater than 45 ms (Generator applications)

It determines the closing capacity of circuit breakers and switches, as well as the electrodynamic withstand of busbars and switchgear.

The usual uses in IEC are the following values:

8 - 12.5 - 16 - 20 - 25 - 31.5 - 40 - 50 kA rms.

The ANSI/IEEE uses the following values:

16 - 20 - 25 - 40 - 50 - 63 kA rms.

These are generally used in the specifications.

### N.B:

A specification may give one rms value in kA and one value in MVA as below:

$I_{sc} = 19 \text{ kA}$  or 350 MVA at 10 kV

- if we calculate the equivalent current at 350 MVA we find:

$$I_{sc} = \frac{350}{\sqrt{3} \times 10} = 20.2 \text{ kA}$$

The difference depends on how we round up the value and on local usages.

The value 19 kA is probably the most realistic.

- Another explanation is possible: in medium and high voltage, IEC 60909-0 applies a coefficient of 1.1 when calculating maximal  $I_{sc}$ .

$$I_{sc} = 1.1 \times \frac{U}{\sqrt{3} \times Z_{sc}} = \frac{E}{Z_{sc}}$$

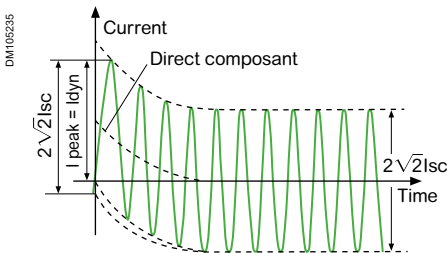

DM1105235

# Short-circuit currents

## Transformer

The short-circuit current depends on the type of equipment installed on the network (transformers, generators, motors, lines, etc).

In order to determine the short-circuit current across the terminals of a transformer, we need to know the short-circuit voltage ( $u_{sc}$  %).

$u$  % is defined in the following way:

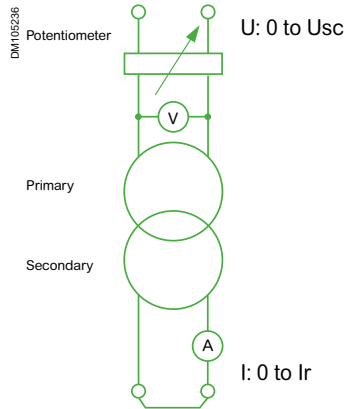

**Example:**

- Transformer 20 MVA
- Voltage 10 kV
- $U_{sc} = 10\%$
- Upstream power: infinite

$$I_r = \frac{S_r}{\sqrt{3} \times U_{no\ load}} = \frac{20000}{\sqrt{3} \times 10} = 1150\text{ A}$$

$$I_{sc} = \frac{I_r}{U_{sc}} = \frac{1150}{10/100} = 11.5\text{ kA}$$

- 1 The voltage transformer is not powered:  $U = 0$
- 2 Place the secondary in short-circuit
- 3 Gradually increase voltage  $U$  at the primary up to the rated current  $I_r$  in the transformer secondary circuit.

The value  $U$  read across the primary is then equal to  $U_{sc}$ .  
Then

$$U_{sc} (\%) = \frac{U_{sc}}{U_r \text{ primary}}$$

The short-circuit current, expressed in kA, is given by the following equation:

$$I_{sc} (\text{kA}) = \frac{I_r (\text{kA}) \times 100}{U_{sc} (\%)}$$

# Short-circuit currents

## Synchronous generators

### Asynchronous motor

## Synchronous generators (alternators and motors)

Calculating the short-circuit current across the terminals of a synchronous generator is very complicated because the internal impedance of the latter varies according to time.

When the power gradually increases, the current reduces passing through three characteristic periods:

- subtransient (enabling determination of the closing capacity of circuit breakers and electrodynamic constraints), average duration, 10 ms
- transient (sets the equipment's thermal constraints), average duration 250 ms
- permanent (this is the value of the short-circuit current in steady state).

The short-circuit current is calculated in the same way as for transformers, but the different states must be taken into account.

**Example:**  
Calculation method for an alternator or a synchronous motor

- Alternator 15MVA
- Voltage U=10kV
- X'd=20%

$$I_r = \frac{S_r}{\sqrt{3} \times U} = \frac{15}{\sqrt{3} \times 10000} = 870 \text{ A}$$

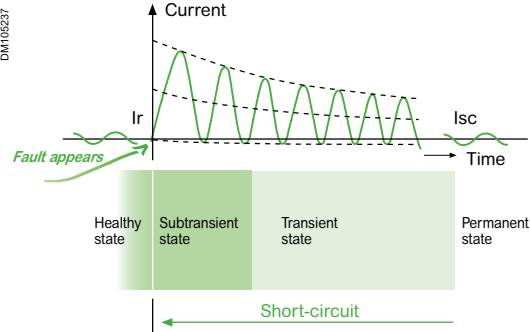
$$I_{sc} = \frac{I_r}{X_{sc \text{ trans}}} = \frac{870}{20/100} = 4350 \text{ A} = 4.35 \text{ kA}$$

The short-circuit current is calculated in the same way as for transformers, but the different states must be taken into account.

The short-circuit current is given by the following equation:

$$I_{sc} = \frac{I_r}{X_{sc}}$$

X <sub>sc</sub>	Instantaneous short-circuit reactance c/c
-----------------	---

The most common values for a synchronous generator are:

State	X <sub>sc</sub>	Subtransient X''d	Transient X'd	Permanent Xd
Turbo		10-20%	15-25%	200-350%
Exposed pole		10% to 20%	25% to 35%	70% to 120%

The high value of the permanent short-circuit impedance means that the established short-circuit current is lower than the rated current.

## Asynchronous motor

For asynchronous motors

The short-circuit current across the terminals equals the start-up current

$$I_{sc} \approx 5 \text{ at } 8 I_r$$

The contribution of the motors (back feed current) to the short-circuit current is equal to:  $I \approx 3 \sum I_r$

The coefficient of 3, takes into account motors when they are stopped.

# Short-circuit currents

## Reminder concerning the calculation of three-phase short-circuit currents

Some values are taken as assumption as usual. It is advised to use the correct values for installation according to the data sheet for the component supplied by the manufacturer.

### Three-phase short-circuit

$$S_{sc} = 1.1 \times U \times I_{sc} \times \sqrt{3} = \frac{U^2}{Z_{sc}}$$

$$I_{sc} = \frac{1.1 \times U}{Z_{sc} \times \sqrt{3}} \text{ with } Z_{sc} = \sqrt{(R^2 + X^2)}$$

### Upstream network

$$Z = \frac{U^2}{S_{sc}}$$

R 0.3 at 6kV  
 = 0.2 at 20kV  
 X 0.1 at 150kV

### Overhead lines

$$R = \rho \times \frac{L}{S}$$

X = 0.4 Ω/km HV	HV
X = 0.3 Ω/km	MV/LV
ρ = 1.8 • 10 <sup>-6</sup> Ω cm	Copper
ρ = 2.8 • 10 <sup>-6</sup> Ω cm	Aluminium
ρ = 3.3 • 10 <sup>-6</sup> Ω cm	Almélec

### Synchronous generator

$$Z (\Omega) = X (\Omega) = \frac{U^2}{Z_{sc}} \times \frac{X_{sc} (\%)}{100}$$

X <sub>sc</sub>	Subtransient	Transient	Permanent
Turbo	10% to 20%	15% to 25%	200% to 350%
Exposed pole	10% to 20%	25% to 35%	70% to 120%

### Transformers

(Order of magnitude: for real values, refer to data given by manufacturer)

E.g.:  20 kV/410 V; Sr = 630 kVA; U<sub>sc</sub> = 4%  
 63 kV/11 kV; Sr = 10 MVA; U<sub>sc</sub> = 9%

$$Z (\Omega) = \frac{U^2}{S_r} \times \frac{X_{sc} (\%)}{100}$$

	MV/LV	HV/MV
Sr (kVA)	100 to 3150	5000 to 50000
U <sub>sc</sub> (%)	4 to 7.5	8 to 12

# Short-circuit currents

## Reminder concerning the calculation of three-phase short-circuit currents

### Relation between rated short-circuit withstand current resistance density (Tkr = 1 s) and conductor temperature

Full lines, copper; dotted lines, low-alloyed steel

DM105238

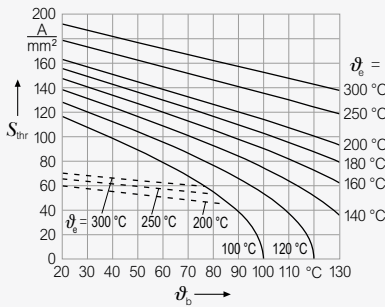

Aluminium, aluminium alloy, aluminium conductor steel reinforced (ACSR)

DM105238

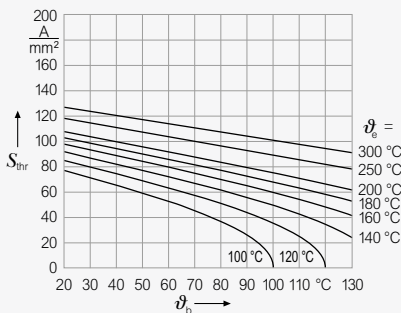

Bare conductors have sufficient thermal short-time strength as long as the following relationship holds for the thermal equivalent short-circuit current density S<sub>thr</sub> for all T<sub>kr</sub> values.

$$S_{thr} \leq S_{thr} \times \sqrt{(T_{kr}/T_k)}$$

The steel core of the steel reinforced aluminium conductor (ACSR) shall not be taken into account when calculating the cross-section area for the estimation of the current density.

When a number of short-circuits occur with a short time interval between them, the resulting short-circuits duration is:

$$I_{sc} = \sum_{i=1}^n T_{ki}$$

### Cables and conductors

- Temperature rise

All cables and conductors are defined by their ampacity which is the main rating to control the temperature rise in normal operation or in temporary use when dealing with a fault current.

The temperature rise could come from normal or abnormal overload, any connection which could become less efficient due to surrounding vibration. Since fault current is extinguished by protection relay, the frequency of emission due to temperature rise is reduced compared to normal conditions, which become abnormal due to ageing phenomena.

For this reason it is recommended to monitor the conductors using thermal sensors.

- Reactance

X = 0.10 at 0.15 Ω/km

Concentric core, three phase or single phased

- Calculation of temperature rise and rated short-time current withstand density for conductors

The temperature rise of a conductor caused by a short-circuit is a function of the duration of the short-circuit current, the thermal equivalent short-circuit current and the conductor material.

By use of the graphs, it is possible to calculate the temperature rise of a conductor when the rated short-time withstand current density is known, or vice versa.

The recommended highest temperatures during a short-circuit for different conductors are given in following table issued by the IEC 60865-1:2011 standard. If they are reached, a negligible decrease in strength can occur which does not empirically jeopardize safety in operation.

The maximum permitted temperature of the support shall be taken into account.

Type of conductor	Recommended highest conductor temperature during a short-circuit °C
-------------------	---

Bare conductors, solid or stranded: 200  
Cu, Al or Al alloy

Bare conductors, solid or stranded: steel 300

When the following constants of material are used for 20° as base-temperature the following formula is applicable:

Data at 20°C	c	ρ	k20	α20	θe
Alu	910	2700	34800000	0.004	200
Copper	390	8900	56000000	0.0039	200
Steel	480	7850	7250000	0.0045	300

$$S_{thr} = \frac{1}{\sqrt{T_{kr}}} \times \sqrt{\frac{k_{20} \times c \times \rho}{\alpha_{20}}} \times \ln \frac{1 + \alpha_{20} \times (\theta_e - 20)}{1 + \alpha_{20} \times (\theta_b - 20)}$$

S <sub>thr</sub>	Rated short-circuit withstand current density (Ampacity)	A/mm <sup>2</sup>
T <sub>kr</sub>	Time duration	s
c	Specific thermal capacity	J/(kg K)
ρ	Specific mass	kg/m <sup>3</sup>
k <sub>20</sub>	Specific conductivity at 20 °C	1/(Ωm)
α <sub>20</sub>	Temperature coefficient	1/K
θ <sub>b</sub>	Conductor temperature of the beginning of a short-circuit	°C
θ <sub>e</sub>	Conductor temperature at the end of a short-circuit	°C

# Short-circuit currents

## Reminder concerning the calculation of three-phase short-circuit currents

### Busbars

$X = 0.15\Omega/\text{km}$

### Synchronous motors and compensators

Xsc	Subtransient	Transient	Permanent
High speed motors	15%	25%	80%
Low speed motors	35%	50%	100%
Compensators	25%	40%	160%

### Asynchronous motors (only subtransient)

$$Z (\Omega) = \frac{I_d}{I_r} \times \frac{U^2}{S_r}$$

$I_{sc} \approx 5 \text{ to } I_r$

$I_{sc} \approx 3 \times \sum I_r$

Contribution to  $I_{sc}$  by current feedback with  $I$  rated =  $I_r$ .

### Fault arcing

$$I_d = \frac{I_{sc}}{1.3 \text{ to } 2}$$

### Equivalent impedance of a component through a transformer

For example, for a low voltage fault, the contribution of an HV cable upstream of an HV/LV transformer will be:

$$R_2 = R_1 \times \frac{U_2^2}{U_1^2} \text{ and } X_2 = X_1 \times \frac{U_2^2}{U_1^2} \text{ thus } Z_2 = Z_1 \times \frac{U_2^2}{U_1^2}$$

This equation is valid for all voltage levels in the cable, in other words, even for several series-mounted transformers.

Impedance seen from the fault location A

$$\sum R = R_2 + \frac{R_T}{n^2} + \frac{R_1}{n^2} + \frac{R_a}{n^2} \quad \sum X = X_2 + \frac{X_T}{n^2} + \frac{X_1}{n^2} + \frac{X_a}{n^2}$$

### Triangle of impedances

$$Z = \sqrt{(R^2 + X^2)}$$

DM105239

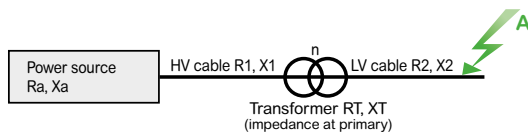

DM105240

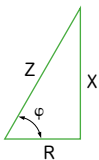

# Short-circuit currents

## Example of three-phase calculation

The complexity in calculating the three-phase short-circuit current basically lies in determining the impedance value in the network upstream of the fault location.

### Impedance method

All the components of a network (supply network, transformer, alternator, motors, cables, bars, etc.) are characterised by an impedance ( $Z$ ) comprising a resistive component ( $R$ ) and an inductive component ( $X$ ) or so-called reactance.  $X$ ,  $R$  and  $Z$  are expressed in ohms.

The relationship between these different values is given by:

$$Z = \sqrt{R^2 + X^2}$$

(Cf. to example 1 opposite)

The method involves:

- breaking down the network into sections
- calculating the values of  $R$  and  $X$  for each component
- calculating for the network:
  - the equivalent value of  $R$  or  $X$
  - the equivalent value of impedance
  - the short-circuit current.

The three-phase short-circuit current is:

$$I_{sc} = \frac{U}{Z_{sc} \times \sqrt{3}}$$

$I_{sc}$	Short-circuit current	kA
$U$	Phase-to-phase voltage at the point in question before the appearance of the fault	kV
$Z_{sc}$	Short-circuit impedance	$\Omega$

#### Example 1

Network layout

DM105241

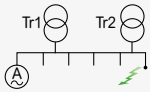

Equivalent layouts

DM105242

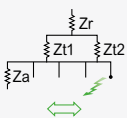

$$Z = Z_r + Z_{t1} // Z_{t2}$$

$$Z = Z_r + \frac{Z_{t1} \times Z_{t2}}{Z_{t1} + Z_{t2}}$$

DM105243



$$Z_{sc} = Z // Z_a$$

$$Z_{sc} = \frac{Z \times Z_a}{Z + Z_a}$$

DM105244



#### Example 2

- $Z_{sc} = 0.27 \Omega$
- $U = 10 \text{ kV}$

$$I_{sc} = \frac{10}{\sqrt{3} \times 0.27} = 21.38 \text{ kA}$$



# Short-circuit currents

## Example of three-phase calculation

Here is a problem to solve!

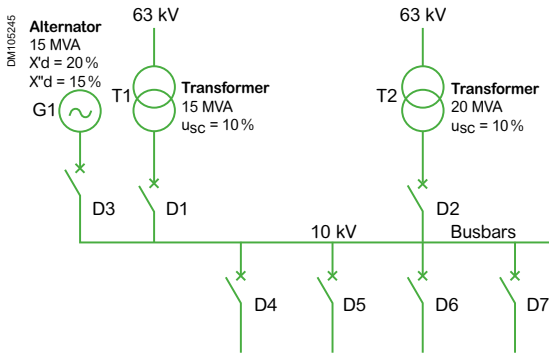

Single line diagram

### Exercise data

Supply at 63 kV  
Short-circuit power of the source: 2000 MVA

### Network configuration:

Two parallel mounted transformers and an alternator

### Equipment characteristics:

- Transformers:
  - voltage 63 kV / 10 kV
  - apparent power: 1 to 15 MVA, 1 to 20 MVA
  - short-circuit voltage:  $u_{sc} = 10\%$
- Alternator:
  - voltage: 10 kV
  - apparent power: 15 MVA
  - $X'd$  transient: 20%
  - $X''d$  subtransient: 15%

### Question:

- determine the value of short-circuit current at the busbars
- the breaking and making capacities of the circuit breakers D1 to D7.

Here is the solution to the problem with the calculation method

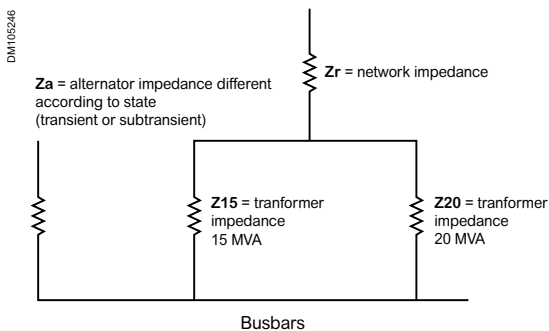

### Solving the exercise

- Determining the various short-circuit currents:  
The three sources which could supply power to the short-circuit are the two transformers and the alternator.  
We are supposing that there can be no back-feed of power through D4, D5, D6 and D7.  
In the case of a short-circuit downstream of a circuit breaker (D4, D5, D6, D7), then the short-circuit current flowing through it is supplied by T1, T2 and G1.

### Equivalent diagram:

Each component comprises a resistance and an induction. We have to calculate the values for each component.

The network can be shown as follows:

Experience shows that the resistance is generally low compared with reactance (0.15Ω/km), so we can therefore consider that the reactance is equal to the impedance ( $X = Z$ ).

- To determine the short-circuit power, we have to calculate the various values of resistances and inductions, then separately calculate the arithmetic sum:

$$R_t = R$$

$$X_t = X$$

- Knowing  $R_t$  and  $X_t$ , we can deduce the value of  $Z_t$  by applying the equation:

$$Z = \sqrt{(\sum R^2 + \sum X^2)}$$

NB: since  $R$  is negligible compared with  $X$ , we can say that  $Z = X$

# Short-circuit currents

## Example of three-phase calculation

And now here are the results!

Component	Calculation	Z= X (ohms)
<b>Network</b>		
Sc = 2000MVA Uop = 10kV	$Z_r = \frac{U^2}{S_{sc}} = \frac{10^2}{2000}$	0.05
<b>15 MVA transformer T1</b>		
(Usc = 10%) Uop = 10kV	$Z_{T1} = Z_{15} = \frac{U^2}{S_r} \times U_{sc} = \frac{10^2}{15} \times \frac{10}{100}$	0.67
<b>20 MVA transformer T2</b>		
(Usc = 10%) Uop = 10kV	$Z_{T2} = Z_{20} = \frac{U^2}{S_r} \times U_{sc} = \frac{10^2}{20} \times \frac{10}{100}$	0.5
<b>15 MVA Alternator</b>		
Uop = 10kV	$Z_a = \frac{U^2}{S_r} \times X_{sc}$	
Subtransient state (Xsc = 15%)	$Z_{at} = \frac{10^2}{15} \times \frac{15}{100}$	Zas ≈ 1
Transient state (Xsc = 20%)	$Z_{as} = \frac{10^2}{15} \times \frac{20}{100}$	Zat ≈ 1.33
<b>Busbars</b>		
Parallel mounted with the transformers	$Z_{T1//ZT2} = Z_{15//Z20} = \frac{Z_{15} \times Z_{20}}{Z_{15} + Z_{20}} = \frac{0.67 \times 0.5}{0.67 + 0.5}$	Zet ≈ 0.29
Series-mounted with the network and the transformer impedance	$Z_{er} = Z_r + Z_{et} = 0.05 + 0.29$	Zet ≈ 0.34
<b>Parallel-mounting of the generator set</b>		
Transient state	$Z_{er//Zat} = \frac{Z_{er} \times Z_{at}}{Z_{er} + Z_{at}} = \frac{0.34 \times 1.33}{0.34 + 1.33}$	≈ 0.27
Subtransient state	$Z_{er//Zas} = \frac{Z_{er} \times Z_{as}}{Z_{er} + Z_{as}} = \frac{0.34 \times 1}{0.34 + 1}$	≈ 0.25

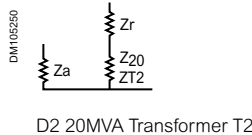
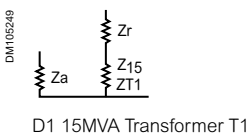
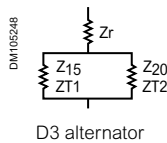
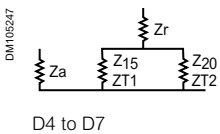

Circuit breaker	Equivalent circuit	Breaking capacity	Making capacity
	Z (Ω)	In (kA rms)*	2.5 Isc (in kA peak)
D4 to D7	Transient state Z=0.27 Subtransient state Z=0.25	21.5	53.9
D3 alternator	Z=0.34	17.2	43
D1 15MVA Transformer T1	Transient state Z=0.51 Subtransient state Z=0.46	11.4	28.5
D2 20MVA Transformer T2	Transient state Z=0.39 Subtransient state Z=0.35	14.8	37

$$*I_{sc} = \frac{U}{\sqrt{3} \times Z_{sc}} = \frac{10}{\sqrt{3}} \times \frac{1}{Z_{sc}}$$

N.B.: a circuit breaker is defined for a certain breaking capacity of an rms value in a steady state, and as a percentage of the aperiodic component which depends on the circuit breaker's opening time and on R/X of the network (about 30%).

For alternators, the aperiodic component is very high; the calculations must be validated by laboratory tests.

The breaking capacity is defined at the transient state. Subtransient period is very short (10 ms) and is approximatively the necessary duration for the protection relay to analyse the fault and give the trip order.

# Busbar calculation in switchgear

## Introduction

In practice, a busbar calculation involves checking that there is sufficient thermal and electrodynamic withstand and non-resonance.

**Examples**

- Flat mounted
- Edge mounted

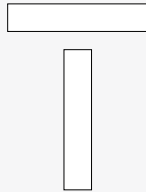

The dimensions of busbars are determined taking into account normal operating conditions. The rated insulation level for rated voltages (kV) determines the phase-to-phase and phase-to-earth distance and also determines the height and shape of the supports. The rated current flowing through the busbars is used to determine the cross-section and type of conductors. Several topics must be checked as follows:

- The supports (insulators) shall withstand the mechanical effects and the bars shall withstand the mechanical and thermal effects due to short-circuit currents.
- The natural period of vibration of the bars themselves must not be the same as the current period.
- To carry out a busbar calculation, we have to use the following physical and electrical characteristics assumptions:

**Busbar electrical characteristics**

Ssc	Network short-circuit power <sup>(1)</sup>	<input type="text"/>	MVA
Ur	Rated voltage	<input type="text"/>	43
U	Operating voltage	<input type="text"/>	28.5
Ir	Rated current	<input type="text"/>	37

*(1) It is generally provided by the customer in this form or we can calculate it having the short-circuit current I<sub>sc</sub> and the operating voltage U: (S<sub>sc</sub> = √3 • I<sub>sc</sub> • U; see chapter on "Short-circuit currents")*

**Physical busbar characteristics**

S	Bar cross-section	<input type="text"/>	cm <sup>2</sup>
d	Phase-to-phase distance	<input type="text"/>	cm
l	Distance between insulators for same phase	<input type="text"/>	cm
θ <sub>n</sub>	Ambient temperature (θ <sub>2</sub> – θ <sub>1</sub> )	<input type="text"/>	°C
θ – θ <sub>n</sub>	Permissible temperature rise <sup>(1)</sup>	<input type="text"/>	K
Profile	Flat	<input type="checkbox"/>	
Material	Copper	<input type="checkbox"/>	Aluminium <input type="checkbox"/>
Arrangement	Flat-mounted	<input type="checkbox"/>	Edge-mounted <input type="checkbox"/>
No. of bar(s) per phase		<input type="text"/>	

*(1) See table 3 of standard IEC 62271-1:2011 common specifications*

**In summary**

bar(s) of  x  cm per phase

# Busbar calculation in switchgear

## Thermal withstand

Let's check if the cross-section that has been chosen:  
 ... bar(s) of ... x ... cm per phase satisfies the temperature rises produced by the rated current and by the short-circuit current passing through them for 1 to 3 second(s)

Perimeter of bar (p) 

### For rated continuous current (Ir)

This section will highlight several parameters influencing the ampacity which is the current-carrying capacity of bare conductors.

The calculation of the ampacity can be summarized by the following formula 2.7.2.1.

The MELSOM & BOOTH, equation published in the "Copper Development Association" review, allows us to define the permissible current in a conductor:

$$I = K \times \frac{24.9 \times (\theta - \theta_n)^{0.61} \times S^{0.5} \times \rho^{0.39}}{\sqrt{(\rho_{20} [1 + \alpha \times (\theta - 20)])}}$$

with

**I** Permissible current expressed in amperes (A)  
 Derating in terms of current should be considered:

- For an ambient temperature greater than 40°C
- For a protection index greater than IP5

<b>θn</b>	Ambient temperature (θn ≤ 40°C)	<input type="text"/>	°C
<b>(θ - θn)</b>	Permissible temperature rise <sup>(1)</sup>	<input type="text"/>	K
<b>S</b>	Bar cross-section	<input type="text"/>	cm <sup>2</sup>
<b>p</b>	Bar perimeter (see opposite diagram)	<input type="text"/>	cm
<b>ρ<sub>20</sub></b>	Conductor resistivity at 20°C (IEC 60943):		
	• Copper 1.7241 μΩ cm		
	• Aluminium 2.8364 μΩ cm		
<b>α</b>	Temperature coefficient of the resistivity 0.00393		
	• Copper 0.00393		
	• Aluminium 0.0036		

**K** Conditions coefficient:  
 (product of 6 coefficients: k1, k2, k3, k4, k5, k6 described page ahead)

*(1) See "Current" section of this document stating the temperature rise limits as highlighted within IEC 62271-1 standards.*

Using the SI system, the formula is introduced by the average value of the heat dissipation by units of:

**W = r × I<sup>2</sup>** length of the conductor (m) formula 2.7.2.2.

**r** Resistance **r = ρ \* L / S = ρ / S** per unit of length (L= 1m)  
 And where **ρ = ρ<sub>20</sub> [1 + α × (θ - θn)]** where θn = 20°C

W is the total amount of heat generated by the current

$$W = \frac{I^2 \times \rho_{20} [1 + \alpha \times (\theta - 20)] \times 10^{-6}}{S} \text{ Formula 2.7.2.3}$$

$$h = \frac{W}{P} = \frac{r \times I^2}{p}$$

average value of heat dissipation per unit area formula 2.7.2.4.

$$h = \frac{r \times I^2}{p (\theta - \theta_n)}$$

average value of heat dissipation per degree formula 2.7.2.5

But the heat dissipation is mainly due to convection, being proportional θ<sup>5/4</sup>, (MELSOM & BOOTH), revised at θ<sup>1.22</sup> and the average value of the heat dissipation by units of degree by convection becomes:

$$h = \frac{r \times I^2}{p (\theta - \theta_n)^{1.22}}$$

average value of heat dissipation per degree by convection formula 2.7.2.6.

# Busbar calculation in switchgear

## Thermal withstand

Several experimental studies confirmed that the effect of variation of the perimeter of the bar for the majority of the values for both round and flat bars, whether copper or aluminum, are more linear. It follows from this that an approximate relation between h and p is existing, and this relation has been improved.

Melsom & Booth: heat emission in watts/cm<sup>2</sup> per degree

Formula 2.7.2.7	$h = \frac{0.000732}{p^{0.140}}$	Edge, flat, round bar
Formula 2.7.2.8	$h = \frac{0.00062}{p^{0.22}}$	Edge mounted flat bar
Formula 2.7.2.9	$h = \frac{0.00067}{p^{0.140}}$	Round bar

Using the flat bar, formula 2.7.2.8 is applicable for h which is replaced in formula 2.7.2.6.

The total amount of heat emitted per cm run and further formula 2.7.2.6.

$$W = r \times I^2 = \frac{0.00062 \times p \times (\theta - \theta_n)^{1.22}}{p^{0.22}} \quad \text{Formula 2.7.2.10}$$

Formula 2.7.2.3 and 2.7.2.10

$$\frac{I^2 \times \rho_{20} [1 + \alpha \times (\theta - 20)] \times 10^{-6}}{S} = \frac{0.00062 \times p \times (\theta - \theta_n)^{1.22}}{p^{0.22}}$$

$$I = \frac{10^3 \times \sqrt{0.00062} \times S^{0.5} \times p^{0.39} \times (\theta - \theta_n)^{0.61}}{\sqrt{(\rho_{20} [1 + \alpha \times (\theta - 20)])}}$$

Formula 2.7.2.1

$$I = K \left( \frac{24.9 \times (\theta - \theta_n)^{0.61} \times S^{0.5} \times p^{0.39}}{\sqrt{(\rho_{20} [1 + \alpha \times (\theta - 20)])}} \right)$$

### Definition of coefficients k1, 2, 3, 4, 5, 6

- Coefficient k1 is a function of the number of bar strips per phase for:
  - 1 bar (k1 = 1)
  - 2 or 3 bars, see table below:

No. of bars per phase	e/a								
	0.05	0.06	0.08	0.10	0.12	0.14	0.16	0.18	0.20
2	1.63	1.73	1.76	1.80	1.83	1.85	1.87	1.89	1.91
3	2.40	2.45	2.50	2.55	2.60	2.63	2.65	2.68	2.70

In our case:

e/a =	<input type="text"/>
The number of bars per phase =	<input type="text"/>
Giving k1 =	<input type="text"/>

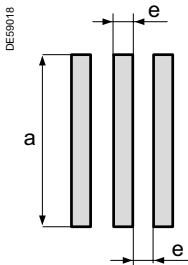

# Busbar calculation in switchgear

## Thermal withstand

- Coefficient k2 is a function of surface condition of the bars:
  - bare: k2 = 1
  - painted: k2 = 1.15
- Coefficient k3 is a function of the position of the bars:
  - edge-mounted bars: k3 = 1
  - 1 bar base-mounted: k3 = 0.95
  - several base-mounted bars: k3 = 0.75
- Coefficient k4 is a function of the place where the bars are installed:
  - calm indoor atmosphere: k4 = 1
  - calm outdoor atmosphere: k4 = 1.2
  - bars in non-ventilated ducting: k4 = 0.80
- Coefficient k5 is a function of the artificial ventilation:
  - without forced ventilation: k5 = 1
  - ventilation should be dealt with on a case by case basis and then validated by testing.
- Coefficient k6 is a function of the type of current:
  - for a alternating current of frequency ≤ 60 Hz, k6 is a function of the number of bars n per phase and of their spacing.
  - The value of k6 for a spacing equal to the thickness of the bars:

n	1	2	3
k6	1	1	0.98

In our case:

n =

giving k6 =

**In fact we have :**

$$K = \text{[input]} \times \text{[input]} \times \text{[input]} \times \text{[input]} \times \text{[input]} \times \text{[input]} = \text{[input]}$$

$$I = \text{[input]} \times \frac{24.9 \times (\text{[input]} - \text{[input]})^{0.61} \times \text{[input]}^{0.5} \times \text{[input]}^{0.39}}{\sqrt{(\text{[input]} [1 + 0.004 \times (\text{[input]} - 20)])}}$$

$$I = K \left( \frac{24.9 \times (\theta - \theta_n)^{0.61} \times S^{0.5} \times p^{0.39}}{\sqrt{(\rho_{20} [1 + \alpha \times (\theta - 20)])}} \right)$$

$$I = \text{[input]} \text{ A}$$

The chosen solution  bar(s) of  x  cm per phase

Is appropriate if I<sub>r</sub> of the required busbars ≤ I

# Busbar calculation in switchgear

## Thermal withstand

**Example:**

How can we find the value of I<sub>th</sub> for a different duration?

Knowing: (I<sub>th</sub>)<sup>2</sup> × t = constant

- If I<sub>th2</sub> = 26.16 kA rms 2 s, what does I<sub>th1</sub> correspond to for t = 1 s?

$$(I_{th2})^2 \times t = \text{constant}$$

$$(26.16 \times 10^3)^2 \times 2 = 137 \times 10^7$$

so  $I_{th1} = \sqrt{\text{constant}/t} = \sqrt{(137 \times 10^7/1)}$

**I<sub>th1</sub> = 37 kA rms for 1 s**

- In summary:
  - at 26.16 kA rms 2 s, it corresponds to 37 kA rms 1 s
  - at 37 kA rms 1 s, it corresponds to 26.16 kA rms 2 s

**For the short-time withstand current (I<sub>th</sub>)**

We assume that for the whole duration (1 or 3 seconds):

- all the heat that is given off is used to increase the temperature of the conductor
- radiation effects are negligible.

The equation below can be used to calculate the short-circuit temperature rise:

$$\Delta\theta_{sc} = \frac{0.24 \times \rho_{20} \times I_{th}^2 \times t_k}{(n \times S)^2 \times c \times \delta}$$

with

$\Delta\theta_{sc}$	Short-circuit temperature rise		
c	Specific heat of the metal: <ul style="list-style-type: none"> <li>• Copper 0.091 kcal/kg °C</li> <li>• Aluminium 0.23 kcal/kg °C</li> </ul>		
S	Bar cross-section	<input type="text"/>	cm <sup>2</sup>
n	Number of bar(s) per phase	<input type="text"/>	
I <sub>th</sub>	Short-time withstand current: (maximum short-circuit current, rms value)	<input type="text"/>	A rms
t <sub>k</sub>	Short-time withstand current duration (1 to 3s)		s
δ	Density of the metal: <ul style="list-style-type: none"> <li>• Copper 8.9 g/cm<sup>3</sup></li> <li>• Aluminium 2.70 g/cm<sup>3</sup></li> </ul>		
ρ <sub>20</sub>	Conductor resistivity at 20°C <ul style="list-style-type: none"> <li>• Copper 1.83 μΩ cm</li> <li>• Aluminium 2.90 μΩ cm</li> </ul>		
(θ - θ <sub>n</sub> )	Permissible temperature rise	<input type="text"/>	K

$$\Delta\theta_{sc} = \frac{0.24 \times 10^{-6} \times (\text{input})^2 \times (\text{input})}{(\text{input})^2 \times (\text{input}) \times (\text{input})}$$

$\Delta\theta_{sc} = \text{input} \text{ K}$

The temperature, θ<sub>t</sub> of the conductor after the short-circuit will be:

$$\theta_t = \theta_n + (\theta - \theta_n) + \Delta\theta_{sc}$$

$\theta_t = \text{input} \text{ K}$

Check:

θ<sub>t</sub> ≤ maximum admissible temperature by the parts in contact with the busbars.  
 Check that this temperature θ<sub>t</sub> is compatible with the maximum temperature of the parts in contact with the busbars (especially the insulator).

# Busbar calculation in switchgear

## Electrodynamic withstand

We have to check if the bars chosen withstand the electrodynamic forces

### Forces between parallel-mounted conductors

The electrodynamic forces during a short-circuit current are given by the equation:

$$F_1 = 2 \times \frac{l}{d} \times I_{dyn}^2 \times 10^{-8}$$

with

$F_1$	Force expressed in daN
$I_{dyn}$	Peak value of short-circuit expressed in A, to be calculated with the equation below:

$$I_{dyn} = k \times \frac{S_{sc}}{U\sqrt{3}} = k \times I_{th}$$

$S_{sc}$	Bar cross-section	<input type="text"/>	cm <sup>2</sup>
$I_{th}$	Short-time withstand current	<input type="text"/>	A rms
$U$	Operating voltage	<input type="text"/>	kV
$l$	Distance between insulators for same phase	<input type="text"/>	cm
$d$	Phase to phase distance	<input type="text"/>	cm
$k$	2.5 for 50Hz; 2.6 for 60Hz and 2.7 for special time constants greater than 45ms		

Giving:

$$I_{dyn} = \text{[input]} \text{ A and } F_1 = \text{[input]} \text{ daN}$$

### Forces at the head of supports or busducts

Equation to calculate the forces on a support:

$$F = F_1 \times \frac{H+h}{H}$$

with

$F$	Force	<input type="text"/>	daN
$H$	Insulator height	<input type="text"/>	cm
$h$	Distance from insulator head to bar centre of gravity	<input type="text"/>	cm

### Calculation of forces if there are N supports

The force  $F$  absorbed by each support is at maximum equal to the calculated force  $F_1$  (see previous chapter) multiplied by a coefficient  $k_n$  which varies according to the total number  $N$  of equidistant supports that are installed.

- number of supports =  $N$
- we know  $N$ , let us define  $k_n$  with the help of the table below:

$N$	2	3	4	$\geq 5$
$k_n$	0.5	1.25	1.10	1.14

Giving:

$$F = \text{[input]} (F_1) \times \text{[input]} (k_n) \times \text{[input]} \text{ daN}$$

The force found after applying a coefficient  $k$  should be compared with the mechanical strength of the support to which we will apply a safety coefficient:

- the supports used have a bending resistance

$$F' = \text{[input]} \text{ daN}$$

Check if  $F' > F$

- we have a safety coefficient of

$$F'/F = \text{[input]}$$

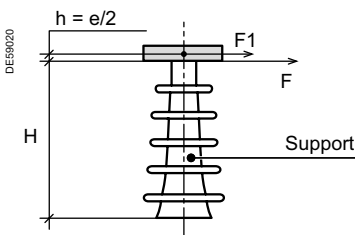
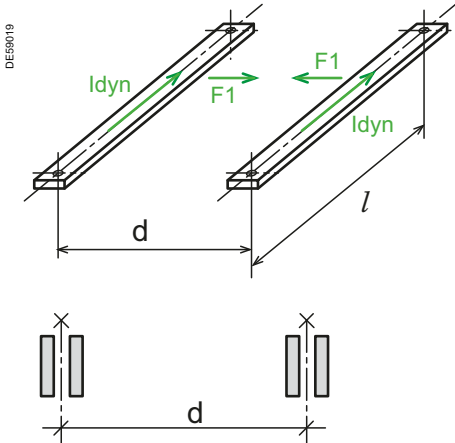



# Busbar calculation in switchgear

## Electrodynamic withstand

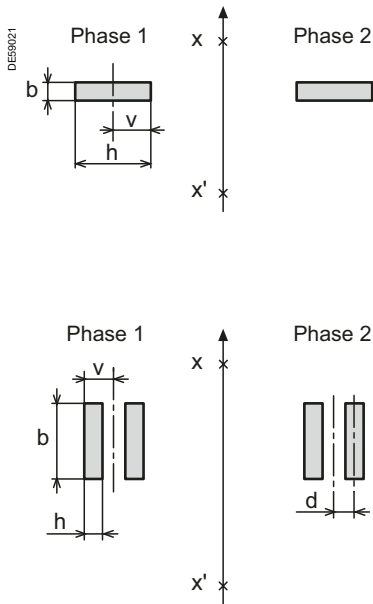

xx': perpendicular to the plane of vibration

### Mechanical busbar strength

By making the assumption that the ends of the bars are sealed, they are subjected to a bending moment whose resultant stress is:

$$\eta = \frac{F_1 \cdot x / v}{12} \cdot \frac{v}{I}$$

with

$\eta$  Is the resultant stress, it must be less than the permissible stress for the bars this is:

- Copper 1/4 hard 1200 daN/cm<sup>2</sup>
- Copper 1/2 hard 2300 daN/cm<sup>2</sup>
- Copper 4/4 hard 3000 daN/cm<sup>2</sup>
- Copper 1/2 hard 1200 daN/cm<sup>2</sup>

$F_1$	Force between conductors	<input type="text"/>	daN
$l$	Distance between insulators for same phase	<input type="text"/>	cm
$l/v$	Is the modulus of inertia between a bar or a set of bars (choose the value in the table on the following page)	<input type="text"/>	cm <sup>3</sup>
$v$	Distance between the fibre that is neutral and the fibre with the highest stress (the furthest)		

- One bar per phase:

$$I = \frac{b \cdot x \cdot h^3}{12} \quad \frac{l}{v} = \frac{b \cdot x \cdot h^2}{6}$$

- Two bars per phase:

$$I = 2x \left( \frac{b \cdot x \cdot h^3}{12} + S \cdot x \cdot d^2 \right) \quad \frac{l}{v} = \frac{2x \left( \frac{b \cdot x \cdot h^3}{12} + S \cdot x \cdot d^2 \right)}{1.5 \cdot x \cdot h}$$

$S$  Bar cross-section (in cm<sup>2</sup>)

Check

$$\eta < \eta \text{ Bars Cu or Al (in daN/cm}^2\text{)}$$

Choose your cross-section  $S$ , linear mass  $m$ , modulus of inertia  $l/v$ , moment of inertia  $I$  for the bars defined below:

Arrangement*	Bar dimensions (mm)											
			100 x 10	80 x 10	80 x 6	80 x 5	80 x 3	50 x 10	50 x 8	50 x 6	50 x 5	
	$S$	cm <sup>2</sup>	10	8	4.8	4	2.4	5	4	3	2.5	
	$m$	Cu	daN/cm	0.089	0.071	0.043	0.036	0.021	0.044	0.036	0.027	0.022
		A5/L	daN/cm	0.027	0.022	0.013	0.011	0.006	0.014	0.011	0.008	0.007
	$I$	cm <sup>4</sup>	0.83	0.66	0.144	0.083	0.018	0.416	0.213	0.09	0.05	
	$l/v$	cm <sup>3</sup>	1.66	1.33	0.48	0.33	0.12	0.83	0.53	0.3	0.2	
	$I$	cm <sup>4</sup>	83.33	42.66	25.6	21.33	12.8	10.41	8.33	6.25	5.2	
	$l/v$	cm <sup>3</sup>	16.66	10.66	6.4	5.33	3.2	4.16	3.33	2.5	2.08	
	$I$	cm <sup>4</sup>	21.66	17.33	3.74	2.16	0.47	10.83	5.54	2.34	1.35	
	$l/v$	cm <sup>3</sup>	14.45	11.55	4.16	2.88	1.04	7.22	4.62	2.6	1.8	
	$I$	cm <sup>4</sup>	166.66	85.33	51.2	42.66	25.6	20.83	16.66	12.5	10.41	
	$l/v$	cm <sup>3</sup>	33.33	21.33	12.8	10.66	6.4	8.33	6.66	5	4.16	
	$I$	cm <sup>4</sup>	82.5	66	14.25	8.25	1.78	41.25	21.12	8.91	5.16	
	$l/v$	cm <sup>3</sup>	33	26.4	9.5	6.6	2.38	16.5	10.56	5.94	4.13	
	$I$	cm <sup>4</sup>	250	128	76.8	64	38.4	31.25	25	18.75	15.62	
	$l/v$	cm <sup>3</sup>	50	32	19.2	16	9.6	12.5	10	7.5	6.25	

\* Arrangement: cross-section in a perpendicular plane to the busbars (2 phases are shown)

# Busbar calculation in switchgear

## Intrinsic resonant frequency

Check that the chosen bars will not resonate.

The intrinsic frequencies to avoid for the busbars subjected to a 50 Hz current are frequencies of around 50 and 100 Hz.

This intrinsic frequency is given by the equation:

$$f = 112 \times \sqrt{\frac{E \cdot I}{m \cdot x^4}}$$

with

<b>f</b>	Resonant frequency in Hz	
<b>E</b>	Modulus of elasticity: <ul style="list-style-type: none"> <li>• For copper 1.3 10<sup>6</sup> daN/cm<sup>2</sup></li> <li>• For aluminium A5/L 0.67 10<sup>6</sup> daN/cm<sup>2</sup></li> </ul>	
<b>S<sub>sc</sub></b>	Linear mass of the bar (choose the value on the table page ahead)	<input type="text"/> daN/cm
<b>l</b>	Length between 2 supports or busducts	<input type="text"/> cm
<b>I</b>	Moment of inertia of the bar cross-section relative to the axis x'x, perpendicular to the vibrating plane (see formula previously explained or choose the value in the table above)	<input type="text"/> cm <sup>4</sup>

Giving:

$$f = \text{[input]} \text{ Hz}$$

We must check that this frequency is outside of the values that must be avoided, in other words between 42-58 Hz and between 80-115 Hz.

# Busbar calculation in switchgear

## Busbar calculation example

Here is a busbar calculation to check.

Top view

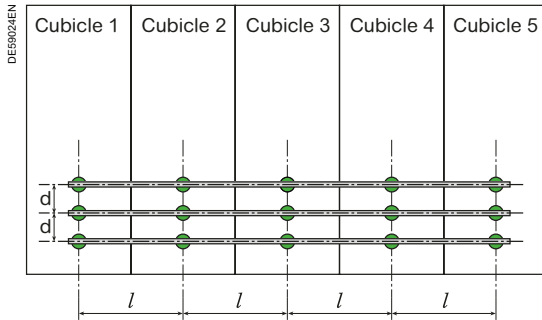

Side view

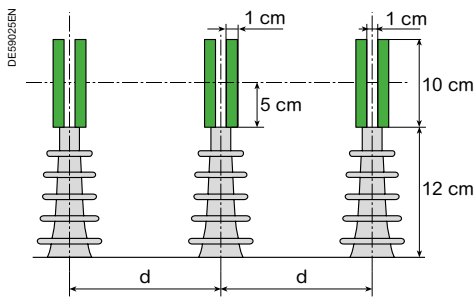

Drawing 1

### Exercise data

- Consider a switchboard comprised of at least 5 MV cubicles. Each cubicle has 3 insulators (1 per phase). Busbars comprising 2 bars per phase, inter-connect the cubicles electrically.

### Busbar characteristics to check:

S	Bar cross-section (10 x 1)	10	cm <sup>2</sup>
d	Phase to phase distance	18	cm
l	Distance between insulators for same phase	70	cm
$\theta_n$	Ambient temperature	40	°C
$(\theta - \theta_n)$	Permissible temperature rise (90-40-50)	50	°K
Profile	Flat		
Material	Bars in copper 1/4 hard, with a permissible stress $\eta = 1200$ daN/cm <sup>2</sup>		
Arrangement	Edge-mounted		
Number of bar(s) per phase:		2	

- The busbars must be able to withstand a rated current  $I_r = 2500$  A on a permanent basis and a short-time withstand current  $I_{th} = 31500$  A rms for a time of  $t_k = 3$  seconds.
- Rated frequency  $f_r = 50$  Hz.
- Other characteristics:
  - parts in contact with the busbars can withstand a maximum temperature of  $\theta_{max} = 100^\circ\text{C}$
  - the supports used have a bending resistance of  $F' = 1000$  daN

# Busbar calculation in switchgear

## Busbar calculation example

Let's check the thermal withstand of the busbars!

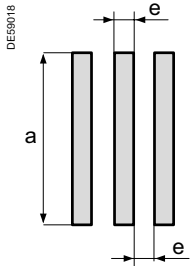

### For the rated current (I<sub>r</sub>)

The MELSOM & BOOTH, equation published in the "Copper Development Association" review, allows us to define the permissible current in a conductor:

$$I = K \times \frac{24.9 \times (\theta - \theta_n)^{0.61} \times S^{0.5} \times p^{0.39}}{\sqrt{(\rho_{20}[1 + \alpha(\theta - 20)])}}$$

with

I	Permissible current expressed in amperes (A)		
θ <sub>n</sub>	Ambient temperature	40	°C
(θ - θ <sub>n</sub> )	Permissible temperature rise <sup>(1)</sup>	50	K
S	Bar cross-section	10	cm <sup>2</sup>
p	Bar perimeter	22	cm
ρ <sub>20</sub>	Conductor resistance at 20°C (IEC 60943): Copper	1.83	μΩ cm
α	Temperature coefficient of the resistivity	0.004	
K	Conditions coefficient: (product of 6 coefficients: k <sub>1</sub> , k <sub>2</sub> , k <sub>3</sub> , k <sub>4</sub> , k <sub>5</sub> , k <sub>6</sub> described below)		

(1) See table 3 of standard IEC 62271-1 common specifications.

### Definition of coefficients k<sub>1</sub>, 2, 3, 4, 5, 6

- Coefficient k<sub>1</sub> is a function of the number of bar strips per phase for:
  - 1 bar (k<sub>1</sub> = 1)
  - 2 or 3 bars, see table below:

No. of bars per k <sub>1</sub> phase	e/a								
	0.05	0.06	0.08	0.10	0.12	0.14	0.16	0.18	0.20
2	1.63	1.73	1.76	1.80	1.83	1.85	1.87	1.89	1.91
3	2.40	2.45	2.50	2.55	2.60	2.63	2.65	2.68	2.70

In our case:

e/a =	0.10
The number of bars per phase =	2
Giving k <sub>1</sub> =	1.80

## Busbar calculation example

- Coefficient k2 is a function of surface condition of the bars:
  - bare: k2 = 1
  - painted: k2 = 1.15
- Coefficient k3 is a function of the position of the bars:
  - edge-mounted bars: k3 = 1
  - 1 bar base-mounted: k3 = 0.95
  - several base-mounted bars: k3 = 0.75
- Coefficient k4 is a function of the place where the bars are installed:
  - calm indoor atmosphere: k4 = 1
  - calm outdoor atmosphere: k4 = 1.2
  - bars in non-ventilated ducting: k4 = 0.80
- Coefficient k5 is a function of the artificial ventilation:
  - without forced ventilation: k5 = 1
  - ventilation should be dealt with on a case by case basis and then validated by testing.
- Coefficient k6 is a function of the type of current:
  - for a alternating current of frequency  $\leq 60$  Hz, k6 is a function of the number of bars n per phase and of their spacing.
  - The value of k6 for a spacing equal to the thickness of the bars:

n	1	2	3
k6	1	1	0.98

In our case:

n =	2
giving k6 =	1

In fact we have :

$$K = 1.80 \times 1 \times 1 \times 1 \times 1 \times 1 \times 1 = 1.44$$

$$I = 1.44 \times \frac{24.9 \times (90 - 40)^{0.61} \times 10^{0.5} \times 22^{0.39}}{\sqrt{1.83 [1 + 0.004 \times (90 - 20)]}}$$

$$I = K \left( \frac{24.9 \times (\theta - \theta_n)^{0.61} \times S^{0.5} \times p^{0.39}}{\sqrt{(\rho_{20} [1 + \alpha \times (\theta - 20)])}} \right)$$

$$I = 2689 \text{ A}$$

The chosen solution 2 bar(s) of 10 x 1 cm per phase is appropriate:  $I_r < I$  either  $2500 \text{ A} < 2689 \text{ A}$

Calculation of  $\theta_i$  must be looked at in more detail because the required busbars have to withstand  $I_r = 2500$  A at most and not 2689 A.

### For the short-time withstand current ( $I_{th}$ )

We assume that for the whole duration (1 or 3 seconds):

- all the heat that is given off is used to increase the temperature of the conductor
- radiation effects are negligible.

The equation below can be used to calculate the short-circuit temperature rise:

$$\Delta\theta_{sc} = \frac{0.24 \times \rho_{20} \times I_{th}^2 \times t_k}{(n \times S)^2 \times c \times \delta}$$

with

c	Specific heat of the metal: Copper 0.091 kcal/kg °C	
S	Bar cross-section	10 cm <sup>2</sup>
n	Number of bar(s) per phase	2
$I_{th}$	Short-time withstand current: (maximum short-circuit current, rms value)	31500 A rms
$t_k$	Short-time withstand current duration (1 to 3s)	3 s
$\delta$	Density of the metal: Copper 8.9 g/cm <sup>3</sup>	
$\rho_{20}$	Conductor resistivity at 20°C: Copper 1.83 μΩ cm	
( $\theta - \theta_n$ )	Permissible temperature rise	50 K

- The temperature rise due to the short-circuit is:

$$\Delta\theta_{sc} = \frac{0.24 \times 1.83 \times 10^{-6} \times (31500)^2 \times 3}{(2 \times 10)^2 \times 0.091 \times 8.9}$$

$$\Delta\theta_{sc} = 4 \text{ K}$$

- The temperature,  $\theta_i$  of the conductor after the short-circuit will be:

$$\theta_i = \theta_n + (\theta - \theta_n) + \Delta\theta_{sc}$$

$$\theta_i = 40 + 50 + 4 = 94 \text{ °C}$$

For  $I = 2689$  A (see calculation in the previous pages)

Let us fine tune the calculation for  $\theta_i$  for  $I_r = 2500$  A (rated current for the busbars)

- The MELSOM & BOOTH equation, allows us to deduce the following:

$$I = \text{constant} \times (\theta - \theta_n)^{0.61} \text{ and } I_r = \text{constant} \times (\Delta\theta)^{0.61}$$

Therefore

$$\frac{I}{I_r} = \left( \frac{\theta - \theta_n}{\Delta\theta} \right)^{0.61} \Leftrightarrow \frac{2689}{2500} = \left( \frac{50}{\Delta\theta} \right)^{0.61} \Leftrightarrow \frac{50}{\Delta\theta} = \left( \frac{2689}{2500} \right)^{1/0.61}$$

$$\Leftrightarrow \frac{50}{\Delta\theta} = 1.126 \Leftrightarrow \Delta\theta = 44.3 \text{ °C}$$

- Temperature  $\theta_i$  of the conductor after short-circuit, for a rated current  $I_r = 2500$  A is:

$$\theta_i = \theta_n + \Delta\theta + \Delta\theta_{sc}$$

$$\theta_i = 40 + 44.3 + 4 = 88.3 \text{ °C for } I_r = 2500 \text{ A}$$

The busbars chosen are suitable because  $\theta_i = 88.3$  °C is less than  $\theta_{max} = 100$  °C ( $\theta_{max}$  = maximum temperature that can be withstood by the parts in contact with the busbars).

# Busbar calculation in switchgear

## Busbar calculation example

Let's check the electrodynamic withstand of the busbars.

### Forces between parallel-mounted conductors

The electrodynamic forces during a short-circuit current are given by the equation:

$$F_1 = 2 \times \frac{l}{d} \times I_{dyn}^2 \times 10^{-8}$$

(see drawing 1 at the start of the calculation example)

with

<i>l</i>	Distance between insulators for same phase	70	cm
<i>d</i>	Phase to phase distance	18	cm
<i>k</i>	For 50 Hz according to IEC	2.5	
<i>I<sub>dyn</sub></i>	Peak value of short-circuit current = <i>k</i> x <i>I<sub>th</sub></i> = 2.5 x 31 500 =	78750	A

$$F_1 = 2 \times \frac{70}{18} \times (78750)^2 \times 10^{-8} = 482.3 \text{ daN}$$

### Forces at the head of supports or busducts

Equation to calculate the forces on a support:

$$F = F_1 \times \frac{H+h}{H}$$

with

<i>F</i>	Force expressed in daN		
<i>H</i>	Insulator height	12	cm
<i>h</i>	Distance from the head of the insulator to the busbar centre of gravity	5	cm

### Calculating a force if there are N supports

The force *F* absorbed by each support is at maximum equal to the calculated force *F*<sub>1</sub> (see previous chapter) multiplied by a coefficient *k<sub>n</sub>* which varies according to the total number *N* of equidistant supports that are installed.

- number of supports *N* ≥ 5
- we know *N*, let us define *k<sub>n</sub>* with the help of the table below:

<i>N</i>	2	3	4	≥ 5
<i>k<sub>n</sub></i>	0.5	1.25	1.10	1.14

Giving:

$$F = 683 (F_1) \times 1.14 (k_n) \times 778 \text{ daN}$$

The supports used have a bending resistance *F'* = 1000 daN; calculated force *F* = 778 daN. **The solution is OK.**

# Busbar calculation in switchgear

## Busbar calculation example

### Mechanical busbar strength

By making the assumption that the ends of the bars are sealed, they are subjected to a bending moment whose resultant stress is:







$$\eta = \frac{F_1 \times l}{12} \times \frac{v}{I}$$

with

$\eta$	Is the resultant stress in daN/cm <sup>2</sup>	
$l$	Distance between insulators for same phase	70 cm
$I/v$	Is the modulus of inertia between a bar or a set of bars (value chosen in the table bellow)	14.45 cm <sup>3</sup>

$$\eta = \frac{482.3 \times 70}{12} \times \frac{1}{14.45} \Leftrightarrow \eta = 195 \text{ daN/cm}^2$$

The calculated resultant stress ( $\eta = 195 \text{ daN/cm}^2$ ) is less than the permissible stress for the copper busbars 1/4 hard (1200 daN/cm<sup>2</sup>). **The solution is OK.**

Arrangement	Bar dimensions (mm)		
			100 x 10
	S	cm <sup>2</sup>	10
	m	Cu daN/cm	0.089
	A5/L	daN/cm	0.027
	$I$	cm <sup>4</sup>	0.83
	$I/v$	cm <sup>3</sup>	1.66
	$I$	cm <sup>4</sup>	83.33
	$I/v$	cm <sup>3</sup>	16.66
	$I$	cm <sup>4</sup>	21.66
	$I/v$	cm <sup>3</sup>	14.45
	$I$	cm <sup>4</sup>	166.66
	$I/v$	cm <sup>3</sup>	33.33
	$I$	cm <sup>4</sup>	82.5
	$I/v$	cm <sup>3</sup>	33
	$I$	cm <sup>4</sup>	250
	$I/v$	cm <sup>3</sup>	50



# Busbar calculation in switchgear

## Busbar calculation example

Let's check that the chosen bars do not resonate.

### Inherent resonant frequency

The inherent resonant frequencies to avoid for bars subjected to a current at 50 Hz are frequencies of around 50 and 100 Hz.

This inherent resonant frequency is given by the equation:

$$f = 112 \times \sqrt{\frac{E \times I}{m \times l^4}}$$

with

f	Resonant frequency in Hz	
E	Modulus of elasticity:	
	• For copper 1.3 10 <sup>6</sup> daN/cm <sup>2</sup>	
	• For aluminium A5/L 0.67 10 <sup>6</sup> daN/cm <sup>2</sup>	
S <sub>sc</sub>	Linear mass of the bar (choose the value on the table above)	0.089 daN/cm
l	Length between 2 supports or busducts	70 cm
I	Moment of inertia of the bar section relative to the axis x'x, perpendicular to the vibrating plane	21.66 cm <sup>4</sup>

$$f = 112 \times \sqrt{\frac{1.3 \times 10^6 \times 21.66}{0.089 \times 70^4}} \Leftrightarrow f = 406 \text{ Hz}$$

f is outside of the values that have to be avoided, in other words 42 to 58 Hz and 80 to 115 Hz. **The solution is OK.**

### In conclusion

The busbars chosen, i.e. 2 bars of 10.1 cm per phase, are suitable for an I<sub>r</sub> = 2500 A and I<sub>m</sub> = 31.5 kA 3 s

# Dielectric withstand

## General

### The dielectric strength of the medium

#### A few orders of magnitude

- Dielectric strength  
(20°C, 1 bar absolute): 2.9 to 3kV/mm
- Ionization limit  
(20°C, 1 bar absolute): 2.6 kV/mm

## General

The dielectric withstand depends on the following 3 main parameters:

- The dielectric strength of the medium  
This is a characteristic of the fluid (gas or liquid) making up the medium. For ambient air, this characteristic depends on atmospheric conditions and pollution.
- The shape of the parts
- The distance
  - Ambient air between the live parts
  - Insulating air interface between the live parts.

The required dielectric withstand for switchgear is stated through the insulation level, a set of rated withstand voltages values:

- the rated power frequency withstand voltage
- the rated lightning impulse withstand voltage.

#### Dielectric type tests (IEC 60060-1 and IEEE)

Dielectric test types are defined to check the rated withstand voltages.

The voltage to apply depends on atmospheric conditions, compared to the standard reference atmosphere.

$$U = U_0 \times K_t \quad (0.95 \leq K_t \leq 1.05)$$

$U$  is the voltage to be applied during a test on external conditions

$U_0$  is the rated withstand voltage (Lightning impulse or power frequency)

$K_t$  = 1 for the standard reference atmosphere

Standard reference atmosphere:

- Temperature  $t_0 = 20^\circ\text{C}$
- Pressure  $p_0 = 101.3 \text{ kPa}$  (1013 mbar)
- Absolute humidity  $h_0 = 11 \text{ g/m}^3$

#### Partial discharge

The measurement of partial discharges is a suitable means of detecting certain weaknesses of switchgear assembly.

However, it is not possible to establish a reliable relationship between the results of partial discharge measurement and service performance or life expectancy.

Therefore, it is not possible to give acceptance criteria for partial discharge tests carried out on a complete product.

## The dielectric strength of the medium

### Atmospheric conditions

Atmospheric conditions influence the dielectric strength on site and during the test period. Some of these are taken into account to evaluate the insulation performance in laboratories before the tests.

Atmospheric conditions influence Air Insulated Switchgear (AIS) more than Gas Insulated Switchgear (GIS) and Shielded Solid Insulation Switchgear (SSIS).

#### Pressure

The performance level of gas insulation is related to pressure.

A drop in pressure causes a drop in insulating performance.

#### Humidity (IEC 60060-1 and 62271-1)

In dielectric fluids such as gases and liquids, the presence of humidity can cause a change in insulating performance. In the case of liquids, it always leads to a drop in performance. In the case of gases, it generally leads to a drop (SF<sub>6</sub>, N<sub>2</sub> etc.) apart from air, where a low concentration (humidity < 70%) gives a slight improvement in the overall performance level, or so called "full gas performance".

### Temperature

The performance levels of gaseous, liquid or solid insulation decrease as the temperature increases. For solid insulators, thermal shocks can be the cause of micro-cracks which can lead very quickly to insulator breakdown. Great attention must also be paid to expansion phenomena: a solid insulation material expands by between 5 and 15 times more than a conductor.

## Dielectric tests

### Lightning impulse withstand tests (Basic Impulse Level)

A test is mandatory and must be performed on any new product during the design and certification process to demonstrate the rated withstand voltage. Distances (phase-to-phase and phase-to-ground), geometry of busbars, terminations of busbars, cable termination, and insulation properties are key factors to successfully achieve the dielectric withstand.

Since dielectrics withstands are influenced by environmental conditions such as temperature, atmospheric pressure, humidity, liquid immersion, etc., an atmospheric correction factor is needed when a device is tested at conditions other than standard ones.

The rated withstand voltage of the equipment shall also be determined according to the final location of the product, taking into account the possible influence of the environmental conditions.

### Short duration power-frequency withstand voltage tests

Switchgear and controlgear shall be subjected to short-duration power-frequency voltage withstand tests in accordance with IEC 60060-1.

The test voltage shall be raised for each test condition to the test value and maintained for 1 min. The tests shall be performed in dry conditions and also in wet conditions for outdoor switchgear and controlgear.

The isolating distance may be tested as follows.

- Preferred method: In this case, neither of the two voltage values applied to the two terminals shall be less than one-third of the rated withstand voltage phase-to-earth.
- Alternative method: for metal-enclosed gas-insulated switching devices with a rated voltage of less than 72,5 kV and for a conventional switching device of any rated voltage, the voltage-to-earth of the frame  $U_f$  need not be fixed so accurately and the frame may even be insulated.

NOTE: Due to the broad distribution of the results of the power-frequency voltage wet tests for switchgear and controlgear of rated voltage equal to 170 kV and 245 kV, it is agreed to replace these tests by a wet 250/2 500  $\mu$ s switching impulse voltage test, with a peak value equal to 1.55 times the r.m.s. value of the specified power-frequency test voltage.

Dielectric tests require a correction factor in order to assess the applied voltage. Two methods will be highlighted here after where the Method 1, based on IEC standard is more applied compared to the Method 2 which is used in countries applying ANSI standards.

# Dielectric withstand

## Dielectric tests

**Example:**

Impulse voltage test of a 72.5kV device with  $U_0 = 325\text{kV BIL}$ .

Atmospheric conditions:

- Pressure  $p = 997\text{ mbar}$
- Temperature  $t = 31.7^\circ\text{C}$
- Relative Humidity  $H = 71.5\%$
- $L = 0.630\text{ m}$

- Calculation of the air density  $\delta$ :

$$\delta = \frac{p}{p_0} \times \frac{273 + t_0}{273 + t} = \frac{997}{1013} \times \frac{273 + 20}{273 + 31.7} = 0.9464$$

- Calculation of the absolute humidity  $g/\text{m}^3$

$$h = \frac{6.11 \times 71.5 + e^{\frac{17.6 \times 31.7}{243 + 31.7}}}{0.4615 \times (273 + 31.7)} = 23.68\text{ g/m}^3$$

- Correction factor of humidity for impulse  $k$

$$k = 1 + 0.010 \times \left(\frac{h}{\delta} - 11\right) = 1.140$$

- Calculation of  $g$

$$g = \frac{1.1 \times 325}{500 \times 0.630 \times 0.964 \times 1.168} = 1.05$$

$m = 1$

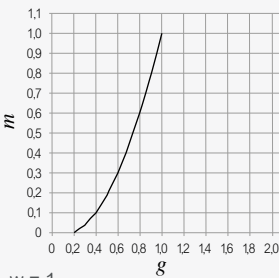

$w = 1$

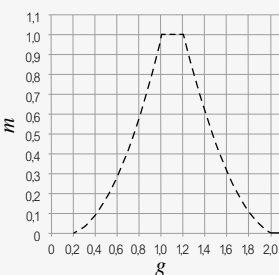

$k_1 = \delta^m = 0.946$  and  $k_2 = k^w = 1.14$

$K_t = k_1 \times k_2 = 1.079$

$U = U_0 \times K_t = 325 \times 1.079 = 350\text{kV}$

### Atmospheric correction factor Dielectric Tests IEEE std. 4-2013 Method 1/ IEC 60060-1 2010

- Air density correction factor  $k_1 = \delta^m$  where  $\delta$  is the air density:

$$\delta = \frac{p}{p_0} \times \frac{273 + t_0}{273 + t}$$

$t_0$	Temperature $t_0 = 20^\circ\text{C}$ , reference
$p_0$	Pressure $p_0 = 101.3\text{ kPa}$ (1013 mbar), reference
$t$	Temperature at site or within the lab
$p$	Pressure at site or within the lab

- Humidity correction factor  $k_2 = k^w$

- Absolute humidity  $h$ :

$$h = \frac{6.11 \times H + e^{\frac{17.6 \times t}{243 + t}}}{0.4615 \times (273 + t)}$$

$h_0$	Absolute humidity $h_0 = 11\text{ g/m}^3$ , reference
$H$	Relative humidity in %

- $k$  is a variable that depends on the type of test  
**DC**

$$k = 1 + 0.014 \times \left(\frac{h}{\delta} - h_0\right) - 0.00022 \times \left(\frac{h}{\delta} - h_0\right)^2$$

**AC**

$$k = 1 + 0.012 \times \left(\frac{h}{\delta} - h_0\right)$$

**Impulse**

$$k = 1 + 0.010 \times \left(\frac{h}{\delta} - h_0\right)$$

- Exponents  $m$  &  $w$  linked to  $g = f(\text{discharge})$  as a parameter

$$g = \frac{U_{50}}{500 \times L \times \delta \times k}$$

$U_{50}$  is the 50 % disruptive-discharge voltage at the actual atmospheric conditions, in kilovolt.

Note: In the case of a withstand test where an estimate of the 50 % disruptive-discharge voltage is not available,  $U_{50}$  can be assumed to be 1.1 times the test voltage,  $U_0$ .

$L$	is the minimum discharge path in m
$k$	is a variable that depends on the type of test

$g$	$m$	$w$
$< 0.2$	0	0
0.2 to 1.0	$g (g-0.2) / 0.8$	$g (g-0.2) / 0.8$
1.0 to 1.2	1.0	1.0
1.2 to 2.0	1.0	$(2.2-g) (2.0-g) / 0.8$
$> 2.0$	1.0	0

- Correction factor  $K_t = k_1 \times k_2$
- Voltage test  $U = U_0 \times K_t$

DM105251

DM105252

# Dielectric withstand Dielectric tests

**Example:**

Impulse voltage test of a 72.5kV device with  $U_0 = 325\text{kV BIL}$ .

Atmospheric conditions:

- Pressure  $p = 997\text{ mbar}$
- Temperature  $t = 31.7\text{ }^\circ\text{C}$
- Relative Humidity  $H = 71.5\%$
- $L = 0.630\text{ m}$
- $m=1$  and  $n=1$  for lightning impulse voltage. rod-rod gaps  
See Figure 1 and 2.

$$kd = \left(\frac{997}{1013}\right)^1 \times \left(\frac{273 + 20}{273 + 31.7}\right)^1 = 0.9464$$

- Absolute humidity = 23.68 See below or IEC method.

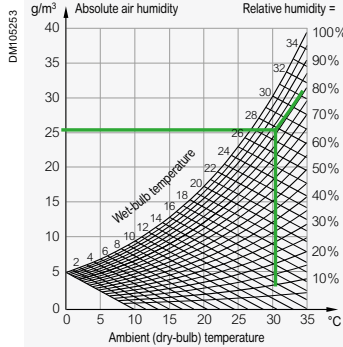

Figure 1 Humidity correction factor  $k_h = k^w = 0.905$

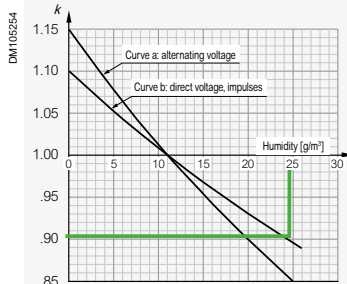
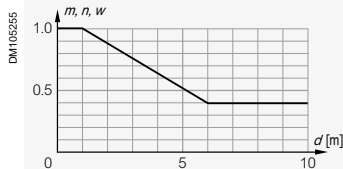

Figure 2 Value of the exponents  $m$  and  $n$  for air density correction and  $w$  for humidity corrections, as a function of sparkover distance  $d$ , in meters



Polarity  $+w=1.0$  & Polarity  $-w=0.8$

$$+k_h = k^w = 0.905^1 = 0.9050$$

$$-k_h = k^w = 0.905^{0.8} = 0.9232$$

$$+K = \frac{k_d}{+k_h} = \frac{0.9464}{0.9050} = 1.0457$$

$$-K = \frac{k_d}{-k_h} = \frac{0.9464}{0.9232} = 1.0251$$

$$+U = U_0 \times +K = 325\text{ kV} \times 1.0457 = 339.8\text{ kV}$$

$$-U = U_0 \times -K = 325\text{ kV} \times 1.0251 = 333.1\text{ kV}$$

**Correction factor for dielectric tests IEEE std4 Method 2.**

- Air density correction factor  $kd = \delta^m$  where  $\delta$  is the air density:

$$kd = \left(\frac{p}{p_0}\right)^m \times \left(\frac{273 + t_0}{273 + t}\right)^n$$

Type of rest voltage	Electrode form	Polarity	Air density correction exponents $m$ and $n$ (see Note 2)	Humidity correction Factor $k$	Exponent $w$
Direct voltage		+	1.0	See Figure 1 (curve b)	0
		-			0
		+			1.0
		-			1.0
		+			1.0
		-			0
Alternating voltage		+	1.0	See Figure 1 (curve a)	0
		-			See Figure 2
		+			See Figure 2
		-			See Figure 2
Lightning impulse voltage		+	1.0	See Figure 1 (curve b)	0
		-			0
		+			1.0
		-			0.8
		+			1.0
		-			0
Switching impulse voltage		+	1.0	See Figure 1 (curve b)	0
		-			0
		+			See Figure 2
		-			0 (see Note 1)
		+			See Figure 2
		-			0 (see Note 1)
Gaps giving an essentially uniform field					
Rod-rod gaps and test objects with electrodes giving a non-uniform field, but with essentially symmetrical voltage distribution					
Rod-plane gaps and test objects with similar characteristics such as support insulators; that is, electrodes giving a non-uniform field with a pronounced asymmetrical voltage distribution					

For any electrode arrangement not falling into one of the preceding classes, only the air density correction factor, using exponents  $m = n = 1$ , and no humidity correction, should be applied.

For wet tests, the air density correction factor should be applied but not the humidity correction factor. For artificial contamination tests neither correction factor should be used.

NOTE 1: Very little information is available. At present no correction is recommended.

NOTE 2: In Figure 1 and Figure 2, a simplification of the existing information is given. The available experimental data from different sources always show large dispersions and are often conflicting; moreover, relevant information for direct voltages and for switching impulses is scarce. The appropriateness of using equal exponents  $m$  and  $n$ , and of their numerical values as given, is therefore uncertain.

### On site, other factors may influence the insulation performance

#### Condensation

Phenomena involving the depositing of droplets of water on the surface of insulators which has the effect of locally reducing the insulating performance by a factor of 3.

#### Pollution

Conductive dust can be present in a gas, in a liquid, or be deposited on the surface of an insulator. Its effect is always the same: reducing the insulation performance by a factor of anything up to 10!

Pollution may originate: from the external gaseous medium (dust), initial lack of cleanliness, possibly the breaking down of an internal surface. Pollution combined with humidity causes electrochemical conduction which can increase the phenomenon of partial discharges.

The level of pollution is also linked to possible use outdoors.

#### Altitude

For installations at an altitude higher than 1 000 m, the required insulation withstand level of external insulation at the service location shall be determined according to IEC 60071-2. The rated insulation level of the switchgear and controlgear should be equal to or higher than this value; refer to IEC/TR 62271-306.

NOTE1: The basis of rating for switchgear is the standard reference atmosphere, commonly known as sea level conditions.

Experience has shown that switchgear and controlgear can be applied at altitudes up to 1000 m without the use of an altitude correction factor.

NOTE 2: For internal insulation, the dielectric characteristics are identical at any altitude and no special precautions need to be taken. For external and internal insulation, refer to IEC 60071-2.

NOTE3: For low-voltage auxiliary and control equipment, no special precautions need to be taken if the altitude is lower than 2 000 m.

For higher altitudes, refer to IEC 60664-1.

- IEC 60071-2

$$K_a = e^{m \times \left( \frac{H}{8150} \right)}$$

- IEC 62271-1:2011

$$K_a = e^{m \times \left( \frac{H - 1000}{8150} \right)}$$

m is taken as a fixed value in each case for simplification as follows:

- m = 1 for power-frequency, lightning impulse and phase-to-phase switching impulse voltages;
- m = 0.9 for longitudinal switching impulse voltage;
- m = 0.75 for phase-to-earth switching impulse voltage.

For polluted insulators, the value of the exponent m is tentative. For the purposes of the long-duration test and, if required, the short-duration power-frequency withstand voltage of polluted insulators, m may be as low as 0.5 for normal insulators and as high as 0.8 for anti-fog design.

#### Example:

- IEC 62271-1:2011 standard

Further the following graph if H=2000m and m=1:

$$K_a = 1.13$$

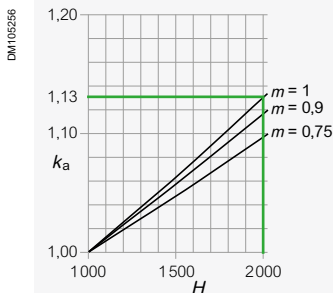

#### Calculation

$$K_a = e^{\left( \frac{2000 - 1000}{8150} \right)} = e^{\left( \frac{1000}{8150} \right)} = 1.13$$

- IEC 60071-2 standard

$$K_a = e^{\left( \frac{2000}{8150} \right)} = 1.278$$

# Dielectric withstand

## The shape of parts

### Distance between parts

## The shape of parts

This plays a key role in switchgear dielectric withstand. It is essential to eliminate any "peak" effect starting with any sharp edge, which would have a disastrous effect on the impulse wave withstand in particular and on the surface ageing of insulators:

Air ionization ► Zone production ► Breakdown of moulded insulating surface skin

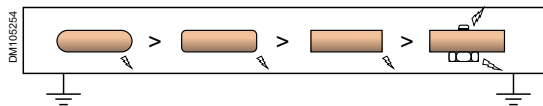

Example of MV conductors with different shapes reflecting their dielectric withstand to an earthed metallic enclosure, compared between each other, and where the best shape of conductor is at the left position.

## Distance between parts

### Ambient air between live parts

For installations in which, for various reasons, we cannot test under impulse conditions, the table in publication IEC 60071-2 table A1 gives, according to the required lightning impulse withstand voltage, the minimum distances to comply with in air either phase-to-earth or phase-to-phase.

These distances provide adequate dielectric withstand when the altitude is less than 1000 m.

Distances in air<sup>(1)</sup> between live parts and metallic earthed structures versus lightning impulse withstand voltage under dry conditions:

Lightning impulse withstand voltage (BIL)	Minimum distance in air phase to earth and phase to phase	
	d (mm)	d (in)
Up (kV)		
20	60	2.37
40	60	2.37
60	90	3.55
75	120	4.73
95	160	6.30
125	220	8.67
145	270	10.63
170	320	12.60
250	480	18.90

The values for distances in air given in the table above are minimum values determined by considering only dielectric properties. They do not include any increase may need to be considered in design tolerances, short circuit effects, wind effects, operator safety, etc.

(1) These indications are relative to a distance through a single air gap, without taking into account the breakdown voltage by tracking across the surfaces, related to pollution problems.

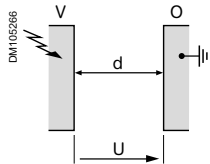

# Dielectric withstand

## Distance between parts

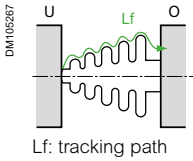

### Dielectric digital analysis

Thanks to numerical simulation software, it is possible to design more compact products if the maximum electrical field is less than given criteria.

### Insulator particular case

Sometimes insulators are used between live parts or between live parts and metallic earthed structures. The choice of an insulator shall take into account the level of pollution.

These levels of pollution are described in Technical Specification IEC TS 60815-1. Selection and dimensioning of high-voltage insulators intended for use in polluted conditions - Part 1 - definitions, information and general principles.

### Clearance for installation

Beyond the dielectric withstand and the degree of protection of the products, additional caution must be taken for installations. The electrical installation rules are set by local regulation. The IEC standard IEC 61936-1 highlights some precautions and some national deviations for the MV installations.

In North America, the National Fire Protection Association (NFPA) specifies minimum space separation in the document NFPA 70.

In field-fabricated installations, the minimum air separation between bare live conductors and between such conductors and adjacent grounded surfaces shall not be less than the values given in following table.

These values shall not apply to interior portions or exterior terminals of equipment designed, manufactured, and tested in accordance with accepted national standards.

Nominal voltage rating (kV)	Impulse withstand BIL (kV)		Minimum Clearance of Live Parts <sup>(1)</sup>							
			Phase-to-phase				Phase-to-ground			
	Indoors	Outdoors	Indoors	Outdoors	Indoors	Outdoors	Indoors	Outdoors		
2.4-4.16	60	95	115	4.5	180	7	80	3.0	155	6
7.2	75	95	140	5.5	180	7	105	4.0	155	6
13.8	95	110	195	7.5	305	12	130	5.0	180	7
14.4	110	110	230	9.0	305	12	170	6.5	180	7
23	125	150	270	10.5	385	15	190	7.5	255	10
34.5	150	150	320	12.5	385	15	245	9.5	255	10
	200	200	460	18.0	460	18	335	13.0	335	13
46		200		460	18		335	13		

(1) The values given are the minimum clearance for rigid parts and bare conductors under favorable service conditions. They shall be increased for conductor movement or under unfavorable service conditions or wherever space limitations permit. The selections of the associated impulse withstand voltage for a particular system voltage is determined by the characteristics of the surge protective equipment.



# Protection index

## IP code according to IEC 60529 standard

### Introduction

Protection of people against direct contact, and protection of equipment against certain external influences, is required by international standards for electrical installations and products. Knowing about the protection index is essential for the specification, installation, operation and quality control of equipment.

### Definitions

The IP code or protection index is a coding system to indicate the degrees of protection provided by an enclosure against access to hazardous parts, ingress of solid foreign objects, ingress of water and to give additional information in connection with such protection.

### Scope

The standard IEC 60529 applies to enclosures for electrical equipment with a rated voltage of less than or equal to 72.5 kV. However, the IP code is used in a larger scope, e.g. for transmission equipment as well. It does not concern a switching device, like circuit breaker, on its own, but the front panel must be adapted when the latter is installed within a cubicle (e.g. finer ventilation grids).

### The various IP codes and their meaning

A brief description of items in the IP code is given in the table below.

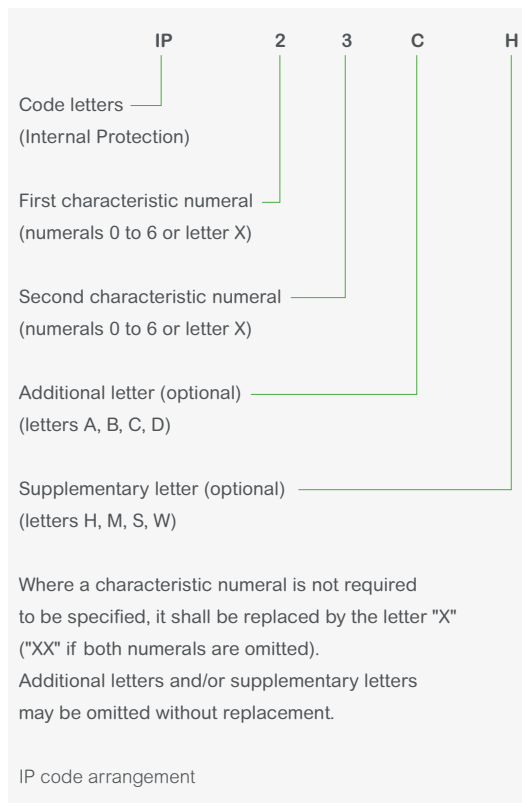

Item	Numerals or letters	Meaning for the protection of equipment	Meaning for the protection of persons
Code letters	IP	Against ingress of solid foreign objects	Against access to hazardous parts
First characteristic numeral			
	0	(non-protected)	(non-protected)
	1	≥ 50 mm diameter	back of hand
	2	≥ 12,5 mm diameter	finger
	3	≥ 2,5 mm diameter	tool
	4	≥ 1,0 mm diameter	wire
	5	dust-protected	wire
	6	dust-tight	wire
Second characteristic numeral			
	0	(non-protected)	(non-protected)
	1	vertically dripping	
	2	dripping (15° tilted)	
	3	spraying	
	4	splashing	
	5	jetting	
	6	powerful jetting	
	7	temporary immersion	
	8	continuous immersion	
	9	High pressure and temperature water jet	
Additional letter (optional)			
	A		Back to hand
	B		Finger
	C		Tool
	D		Wire
Supplementary letter (optional)		Supplementary information specific to:	
	H	High voltage apparatus	
	M	Motion during water test	
	S	Stationary during water test	
	W	Weather conditions	

DM105268

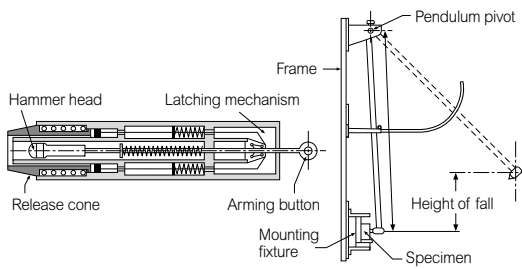

Spring hammer

Pendulum hammer

### Introduction

The degrees of protection provided by enclosures for electrical equipment against external impacts are defined in IEC 62262 standard. The classification of the degrees of protection in IK codes only applies to enclosures of electrical equipment of rated voltage up to and including 72.5 kV. However, the IK code is used in a larger scope, e.g. for transmission equipment as well.

According to IEC 62262, the degree of protection applies to the complete enclosure. If parts of the enclosure have different degrees of protection, they must be specified separately.

### Definitions

The protection index corresponds to impact energy levels expressed in joules

- Hammer blow applied directly to the equipment
- Impact transmitted by the supports, expressed in terms of vibrations, therefore in terms of frequency and acceleration.

The protection index against mechanical impact can be checked by different types of hammer; pendulum hammer, spring hammer or vertical hammer.

The test devices and the methods are described in IEC standard 60068-2-75 "Environmental testing, Test Eh: hammer tests".

### The various IK codes and their meaning

IK code	IK00	IK01	IK02	IK03	IK04	IK05	IK06	IK07	IK08	IK09	IK10
Energies in joules	(1)	0.14	0.2	0.35	0.5	0.7	1	2	5	10	20
Hammer radius mm		10	10	10	10	10	10	25	25	50	50
Equivalent mass (kg)		0.25	0.25	0.25	0.25	0.25	0.25	0.5	1.7	5	5
Height of fall (mm)		56	80	140	200	280	400	400	300	200	400
Hammer material											
Steel = A								•	•	•	•
Polyamide = P		•	•	•	•	•	•				
Hammer											
Pendulum (Eha)		•	•	•	•	•	•	•	•	•	•
Spring loaded (Ehb)		•	•	•	•	•	•	•			
Vertical (Ehc)		•	•	•	•	•	•	•	•	•	•

• = yes

(1) Not protected according to this standard

# Protection index

## NEMA classification

A sample of the NEMA classification definitions [Source from NEMA 250-2003] to be used for indoor MV switchgear or substations is described here after. In Non-Hazardous locations, a few specific enclosure types, their applications, and the environmental conditions they are designed to protect against, when completely and properly installed, are partially summarized as follows:

- Type 1: Enclosures constructed for indoor use to provide a degree of protection to personnel against access to hazardous parts and to provide a degree of protection of the equipment inside the enclosure against ingress of solid foreign objects (falling dirt).
- Type 2: Enclosures constructed for indoor use to provide a degree of protection to personnel against access to hazardous parts; to provide a degree of protection of the equipment inside the enclosure against ingress of solid foreign objects (falling dirt); and to provide a degree of protection with respect to harmful effects on the equipment due to the ingress of water (dripping and light splashing).
- Type 3: Enclosures constructed for either indoor or outdoor use to provide a degree of protection to personnel against access to hazardous parts; to provide a degree of protection of the equipment inside the enclosure against ingress of solid foreign objects (falling dirt and windblown dust); to provide a degree of protection with respect to harmful effects on the equipment due to the ingress of water (rain, sleet, snow); and that will be undamaged by the external formation of ice on the enclosure.
- Type 3R: Enclosures constructed for either indoor or outdoor use to provide a degree of protection to personnel against access to hazardous parts; to provide a degree of protection of the equipment inside the enclosure against ingress of solid foreign objects (falling dirt); to provide a degree of protection with respect to harmful effects on the equipment due to the ingress of water (rain, sleet, snow); and that will be undamaged by the external formation of ice on the enclosure.

Provides a Degree of Protection against the following conditions	Type of enclosure (Indoor Non-hazardous Locations)									
	1 <sup>(1)</sup>	2 <sup>(1)</sup>	4	4X	5	6	6P	12	12K	13
Access to hazardous parts	•	•	•	•	•	•	•	•	•	•
Ingress of solid foreign objects (falling dirt)	•	•	•	•	•	•	•	•	•	•
Ingress of water (Dripping and light splashing)		•	•	•	•	•	•	•	•	
Ingress of solid foreign objects (Circulating dust, lint, fibres, and flying materials <sup>(2)</sup> )			•	•		•	•	•	•	•
Ingress of solid foreign objects (Settling airborne dust, lint, fibres, and flying materials <sup>(2)</sup> )			•	•	•	•	•	•	•	•
Ingress of water (Hose down and splashing water)			•	•		•	•			
Oil and coolant seepage								•	•	•
Oil or coolant spraying and splashing										•
Corrosive agents				•			•			
Ingress of water (Occasional temporary submersion)						•	•			
Ingress of water (Occasional prolonged submersion)							•			

(1) These enclosures may be ventilated.

(2) These fibers and flying materials are non-hazardous materials and are not considered Class III type ignitable fibers or combustible flying materials. For Class III type ignitable fibers or combustible flying materials see the National Electrical Code, Article 500.

# Protection index

## NEMA classification

Provides a Degree of Protection against the following conditions	Type of enclosure (Outdoor Non-hazardous Locations)									
	3	3X	3R	3RX <sup>(1)</sup>	3S	3SX	4	4X	6	6P
Access to hazardous parts	•	•	•	•	•	•	•	•	•	•
Ingress of water (rain, snow, and sleet <sup>(2)</sup> )	•	•	•	•	•	•	•	•	•	•
Sleet <sup>(3)</sup>					•	•				
Ingress of solid foreign objects (Windblown dust, lint, fibres, and flying materials)	•	•			•	•	•	•	•	•
Ingress of water (Hose down)								•	•	•
Corrosive agents		•		•		•		•		•
Ingress of water (Occasional temporary submersion)									•	•
Ingress of water (Occasional prolonged submersion)										•

*(1) These enclosures may be ventilated.*

*(2) External operating mechanisms are not required to be operable when the enclosure is ice covered.*

*(3) External operating mechanisms are operable when the enclosure is ice covered.*

In Hazardous Locations, when completely and properly installed and maintained, Type 7 and 10 enclosures are designed to contain an internal explosion without causing an external hazard.

Type 8 enclosures are designed to prevent combustion through the use of oil-immersed equipment. Type 9 enclosures are designed to prevent the ignition of combustible dust.

See NEMA website for respective definition.

# Corrosion

## Atmospheric

The installation of electrical equipment Medium Voltage (MV) switchgear in adverse environments containing corrosive gases, liquids or dust can cause severe and rapid deterioration of the equipment.

Corrosion is defined as the deterioration of a base metal resulting from a reaction with its environment. Electrical components most affected are those fabricated of copper, aluminium; Steel, both carbon and stainless steel. An atmospheric condition where switchgear is installed is really critical to the aspects considered during design of switchgear and its components like Contacts, Enclosures, busbar and other critical components made by metals and alloys

### Atmospheric













The corrosivity of the atmosphere is classified by ISO 9223 in six categories. Protection by paint system are covered by ISO 12944 series of standards and for offshore ISO 20340 standard shall be used in addition.

Durability: (L) 2 to 5 years, (M) 5 to 15 years, (H) above 15 years.

Each category can be specified by the additional letter associated to the durability (Example: C2H could be specified for indoor equipment and C5MH could be specified for outdoor equipment installed near a coastal).

Beyond 15 years, the durability not being specified, inspection during the lifespan of the product is advised.

The ISO 9223 standard describes typical atmospheric environments related to the estimation of corrosivity categories and are summarized in the table here after.

Category <sup>a</sup>	Corrosivity	Indoor <sup>b</sup>		Outdoor <sup>b</sup>	
C1	Very low	Heated spaces with low relative humidity and insignificant pollution, e.g. offices, schools, museums		Dry or cold zone, atmospheric environment with very low pollution and periods of wetness, e.g. certain deserts, Central Arctic/Antarctica	
C2	Low	Unheated spaces with varying temperature and relative humidity. Low frequency of condensation and low pollution, e.g. storage, sport halls		Temperate zone, atmospheric environment with low pollution (SO <sub>2</sub> 5 µg/m <sup>3</sup> ), e.g. rural areas, small towns Dry or cold zone, atmospheric environment with short periods of wetness, e.g. deserts, subarctic areas	
C3	Medium	Spaces with moderate frequency of condensation and moderate pollution from production process, e.g. food-processing plants, laundries, breweries, dairies		Temperate zone, atmospheric environment with medium pollution (SO <sub>2</sub> : 5 µg/m <sup>3</sup> to 30 µg/m <sup>3</sup> ) or some effect of chlorides, e.g. urban areas, coastal areas with low deposition of chlorides Subtropical and tropical zone, atmosphere with low pollution	
C4	High	Spaces with high frequency of condensation and high pollution from production process, e.g. industrial processing plants, swimming pools		<ul style="list-style-type: none"> <li>Temperate zone, atmospheric environment with medium pollution (SO<sub>2</sub>: 5 µg/m<sup>3</sup> to 30 µg/m<sup>3</sup>) or some effect of chlorides, e.g. urban areas, coastal areas with low deposition of chlorides</li> <li>Subtropical and tropical zone, atmosphere with low pollution</li> </ul>	
C5 Paint C5I C5M	Very high	Spaces with very high frequency of condensation and/or with high pollution from production process, e.g. mines, caverns for industrial purposes, unventilated sheds in subtropical and tropical zones		Temperate and subtropical zone, atmospheric environment with very high pollution (SO <sub>2</sub> : 90 µg/m <sup>3</sup> to 250 µg/m <sup>3</sup> ) and/or significant effect of chlorides, e.g. industrial areas, coastal areas, sheltered positions on coastline	
CX	Extreme	Spaces with almost permanent condensation or extensive periods of exposure to extreme humidity effects and/or with high pollution from production process, e.g. unventilated sheds in humid tropical zones with penetration of outdoor pollution including airborne chlorides and corrosion-stimulating particulate matter		Subtropical and tropical zone (very high time of wetness), atmospheric environment with very high SO <sub>2</sub> pollution (higher than 250 µg/m <sup>3</sup> ) including accompanying and production factors and/or strong effect of chlorides, e.g. extreme industrial areas, coastal and offshore areas, occasional contact with salt spray	

# Corrosion

## Atmospheric

### Galvanic

NOTE 1 Deposition of chlorides in coastal areas is strongly dependent on the variables influencing the transport inland of sea salt, such as wind direction, wind velocity, local topography, wind sheltering islands outside the coast, distance of the site from the sea, etc.

NOTE 2 Extreme effect by chlorides, which is typical of marine splash or heavy salt spray, is outside of the scope of the ISO 9223 standard.

NOTE 3 Corrosivity classification of specific service atmospheres, e.g. in chemical industries, is outside of the scope of the ISO 9223 standard.

NOTE 4 Surfaces that are sheltered and not rain-washed in marine atmospheric environments where chlorides are deposited and cumulated can experience a higher corrosivity category due to the presence of hygroscopic salts.

NOTE 5 A detailed description of types of indoor environments within corrosivity categories C1 and C2 is given in ISO 11844-1. Indoor corrosivity categories IC1 to IC5 are defined and classified.

- a In environments with expected "CX category", it is recommended that the atmospheric corrosivity classification from one-year corrosion losses be determined.
- b The concentration of sulphur dioxide (SO<sub>2</sub>) should be determined for at least one year and is expressed as the annual average.

The following table gives several examples of coating as usual in industry of sheet metal transformation, for which products have been tested according to EN 12944-6.

Category	Corrosivity	Protection
C1	Very low	Electrogalvanized
C2	Low	Pre-galvanized
C3	Medium	Hot dip galvanized
C4	High	Pre-galvanized + powder coating (80µ)
C5	Very high	Pre-galvanized + powder coating (300µ)
CX	Extreme	Consultation is required

## Galvanic

Quality engineering and design requires an understanding of material compatibility. Galvanic Corrosion occurs when a metal or alloy is electrically coupled to another metal or conducting non-metal in the same electrolyte.

The three essential components are:

- Materials possessing different surface potential: Electrochemically dissimilar metals.
- A common electrolyte e.g. Salt water.
- A common electrical path - Conductive path for the metal ions to move from the more anodic metal to the more cathodic metal.

When dissimilar metals or alloys in a common electrolyte are electrically isolated from each other, they do not experience galvanic corrosion, regardless of the proximity of the metals or their relative potential or size.

If only one metal needs to be protected, the coating should be done to the one closest to the cathode.

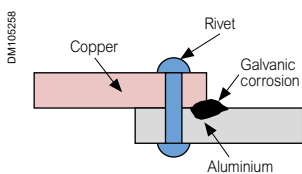

Galvanic voltage of the example 580 mV

# Corrosion

## Atmospheric & Galvanic combined

Often when design requires that dissimilar metals come in contact, the galvanic compatibility is managed by finishes and plating. The finishing and plating selected facilitate the dissimilar materials being in contact and protect the base materials from corrosion. Any design should assess an "Anodic Index" at 0 for the corrosivity class at C5, without dedicated verification tests. Example 50mV is taken as upper limit for outdoor product exposed to harsh environment normally requiring C5 as category.

For special environments, such as an outdoor product under high humidity, and salt environments. Typically, there should be not more than 0.15 V difference in the "Anodic Index". For example; gold and silver would have a difference of 0.15V, which is acceptable. (An equivalent atmospheric corrosion class would be C4).

For normal environments, such as an indoor product stored in warehouses under non-temperature and humidity controlled conditions. Typically there should not be more than 0.25 V difference in the "Anodic Index". (An equivalent atmospheric corrosion class would be C3)

For controlled environments, which are temperature and humidity controlled, 0.50 V can be tolerated. Caution should be maintained when deciding on this application, as humidity and temperature do vary across service conditions (An equivalent atmospheric corrosion class would be C2 up to 0.30 V and C1 up to 0.50 V). As information the technical report IEC/TR 60943 V2009 mentioned 0.35 V.

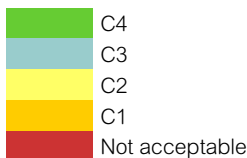
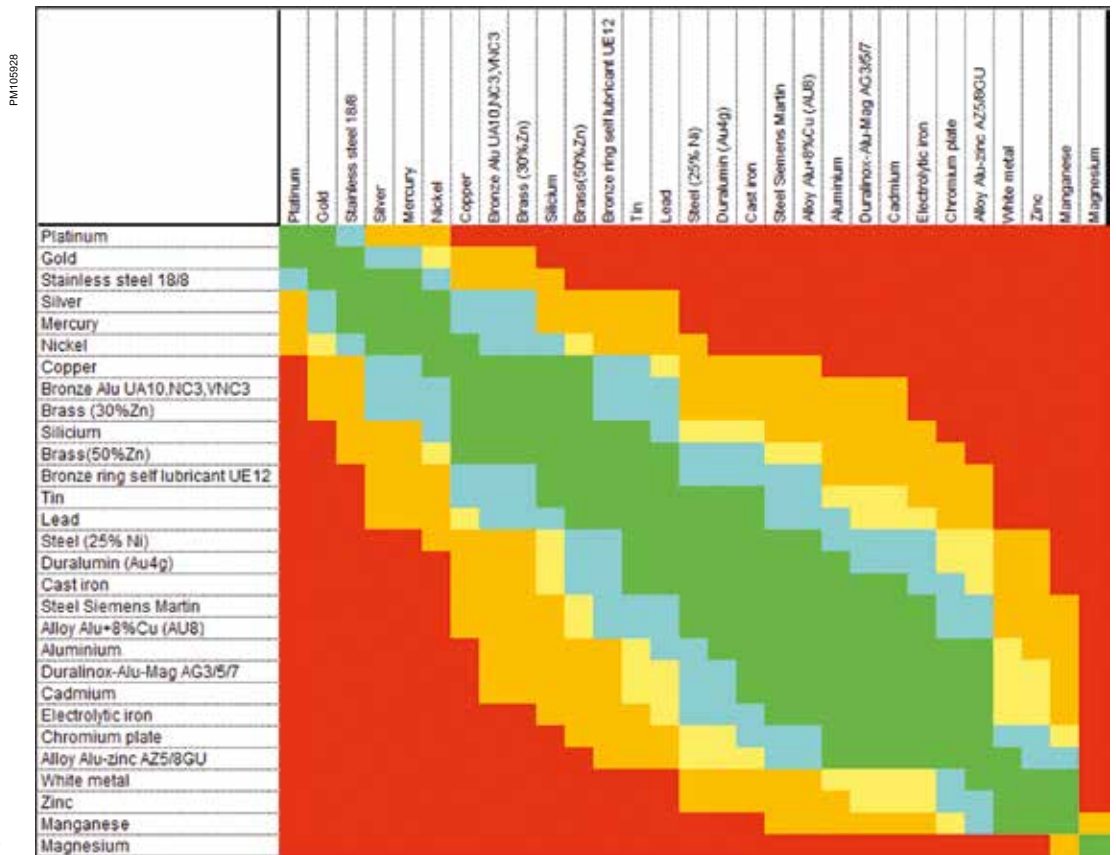

# Switchgear definition



<b>Medium voltage circuit breaker</b>	<b>p. 82</b>
Introduction	p. 82
Characteristics	p. 82
<b>Mechanism of Vacuum Circuit Breaker</b>	<b>p. 92</b>
Introduction	p. 92
Mechanical operating principles	p. 93
<b>Switches</b>	<b>p. 95</b>
Introduction	p. 95
Characteristics	p. 95
<b>Disconnecter and earthing switches</b>	<b>p.100</b>
Introduction	p. 100
Characteristics	p. 100
<b>Current-limiting fuses</b>	<b>p. 102</b>
Introduction	p. 102
Characteristics	p. 102
<b>Current transformer</b>	<b>p. 107</b>
Primary circuit's characteristics according to IEC standards	p. 107
Secondary circuit's characteristics according to IEC standards	p. 110
Differential protection	p. 112
<b>LPCT: Electronic current transformers</b>	<b>p. 113</b>
<b>Voltage transformer</b>	<b>p. 114</b>
Characteristics	p. 114
<b>LPVT: Electronic voltage transformers</b>	<b>p. 118</b>
<b>Derating</b>	<b>p. 119</b>
Introduction	p. 119
Insulation derating according to altitude	p. 119
Derating of the rated current according to temperature	p. 119

IEC 62271-100 and ANSI/IEEE C37-04, C37-06, C37-09 define on one hand the operating conditions, the rated characteristics, the design and the manufacture; and on the other hand the testing, the selection of controls and installation.

### Introduction

The circuit breaker is a device that ensures the control and protection of a network. It is capable of making, withstanding and interrupting operating currents as well as short-circuit currents.

The main circuit must be able to withstand without damage:

- The thermal stress caused by the short-circuit current during 1,2 or 3 s
- The electrodynamic stress caused by the peak of short-circuit current:
  - $2.5 \cdot I_{sc}$  for 50 Hz (standard time constant of 45 ms)
  - $2.6 \cdot I_{sc}$  for 60 Hz (standard time constant of 45 ms)
  - $2.7 \cdot I_{sc}$  (for longer time constant)
- The constant load current.

Since a circuit breaker is mostly in the "closed" position, the load current must pass through it without the temperature running away throughout the equipment's life.

### Characteristics

#### Compulsory rated characteristics (cf § 4 IEC 62271-100)

See ANSI/IEEE C37.09 for America.

- a rated voltage;
- b rated insulation level;
- c rated frequency;
- d rated normal current;
- e rated short-time withstand current;
- f rated peak withstand current;
- g rated duration of short-circuit;
- h rated supply voltage of closing and opening devices and of auxiliary circuits;
- i rated supply frequency of closing and opening devices and of auxiliary circuits;
- j rated pressures of compressed gas supply and/or of hydraulic supply for operation, interruption and insulation, as applicable;
- k rated short-circuit breaking current;
- l transient recovery voltage related to the rated short-circuit breaking current;
- m rated short-circuit making current;
- n rated operating sequence;
- o rated time quantities.

#### Special rated characteristics

Rated characteristics to be given in the specific cases indicated below

- p characteristics for short-line faults related to the rated short-circuit breaking current, for circuit-breakers designed for direct connection to overhead lines, irrespective of the type of network on the source side, and rated at 15 kV and above and at more than 12,5 kA rated short-circuit breaking current;
- q rated line-charging breaking current, for three-pole circuit-breakers intended for switching over-head transmission lines (mandatory for circuit-breakers of rated voltages equal to or greater than 72,5 kV)
- r rated cable-charging breaking current, for three-pole circuit-breakers intended for switching cables (mandatory for circuit-breakers of rated voltages equal to or less than 52 kV).

#### Rated characteristics to be given on request

- s rated out-of-phase making and breaking current;
- t rated single capacitor bank breaking current;
- u rated back-to-back capacitor bank breaking current;
- v rated capacitor bank inrush making current;
- w rated back-to-back capacitor bank inrush making current.

The rated characteristics of the circuit-breaker are referred to the rated operating sequence.

# Medium voltage circuit breaker

## Characteristics

### Rated voltage (cf § 4.1 IEC 62271-1:2011)

See ANSI/IEEE C37.100.1 for America

The rated voltage is the maximum rms value for which the equipment is designed. It indicates the maximum value of the "highest system voltage" of networks for which the equipment may be used (refer to Clause 9 of IEC 60038).

Standard values of 245kV and below are given below.

- **Series I:** 3,6 kV - 7,2 kV - 12 kV - 17,5 kV - 24 kV - 36 kV - 52 kV - 72,5 kV - 100 kV - 123 kV - 145 kV - 170 kV - 245 kV.
- **Series II (areas, like North America):** 4,76 kV - 8,25 kV - 15 kV - 15,5 kV - 25,8 kV - 27 kV - 38 kV - 48,3 kV - 72,5 kV - 123 kV - 145 kV - 170 kV - 245kV.

### Rated insulation level (cf § 4.3 IEC 62271-1:2011)

See ANSI/IEEE C37.100.1 for America

The insulation level is characterised by two values:

- the lightning impulse wave (1.2/50 µs) withstand voltage
- the power frequency voltage withstand for 1 minute.

Range I, series I

Rated voltage kV rms (Ur in kV)	Rated lightning impulse withstand voltage 1.2/50 µs 50 Hz kV peak (Up in kV)	Rated power-frequency withstand voltage 1 min kV rms (Ud in kV)
7.2	60	20
12	75	28
17.5	95	38
24	125	50
36	170	70

Range I, series II

Rated voltage kV rms (Ur in kV)	Rated lightning impulse withstand voltage 1.2/50 µs 50 Hz kV peak (Up in kV)	Rated power-frequency withstand voltage 1 min kV rms (Ud in kV)
4.76	60	19
8.25	95	36
15.5	110	50
27	150	70
38	200	95

### Rated normal current (cf § 4.4 IEC 62271-1:2011)

With the circuit breaker always closed, the load current must pass through it in compliance with a maximum temperature value as a function of the materials and the type of connections.

IEC sets the maximum permissible temperature rise of various materials used for an ambient air temperature not exceeding 40°C (cf. table 3 IEC 62271-1:2011).

### Rated short-time withstand current (cf § 4.5 IEC 62271-1:2011)

See ANSI/ IEEE C37.09 for America.

Ssc	Short-circuit power in MVA
U	Operating voltage in kV
Isc	Short-circuit current in kA

$$I_{sc} = \frac{S_{sc}}{\sqrt{3} \times U}$$

This is the standardised rms value of the maximum permissible short-circuit current on a network for the rated duration of short-circuit. Values of rated breaking current under maximum short-circuit (kA): 6.3 - 8 - 10 - 12.5 - 16 - 20 - 25 - 31.5 - 40 - 50 - 63 kA.

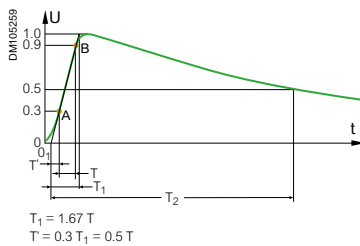

Figure 6: Full lightning impulse

# Medium voltage circuit breaker

## Characteristics

### Rated peak withstand current (cf. § 4.6 IEC 62271-1:2011) and making current (cf. § 4.103 IEC 62271-100)

See ANSI/IEEE C37.09 for America.

The making current is the maximum value that a circuit breaker is capable of making and maintaining on an installation in short-circuit.

It must be greater than or equal to the rated short-time withstand peak current.

$I_{sc}$  is the maximum value of the rated short-circuit current for the circuit breakers rated voltage.

The peak value of the short-time withstand current is equal to:

- $2.5 \times I_{sc}$  for 50 Hz
- $2.6 \times I_{sc}$  for 60 Hz
- $2.7 \times I_{sc}$  for special time constants greater than 45 ms.

### Rated short-circuit duration (cf. § 4.7 IEC 62271-1:2011)

The standard value of rated duration of short-circuit is 1 s.

Other recommended values are 0.5 s, 2 s and 3 s.

### Rated supply voltage for closing and opening devices and auxiliary circuits (cf. § 4.8 IEC 62271-1:2011)

See ANSI/IEEE C37.06 for America.

Values of supply voltage for auxiliary circuits:

- for direct current (dc): 24 - 48 - 60 - 110 or 125 - 220 or 250 volts,
- for alternating current (ac): 120 - 230 volts.

The operating voltages must lie within the following ranges (cf. § 5.6 and 5.8 of IEC 62271-1:2011):

- motor and closing release units: 85% to 110% of  $U_r$  in DC and AC
- opening release units:
  - 70% to 110% of  $U_r$  in dc
  - 85% to 110% of  $U_r$  in ac
- under voltage opening release unit:

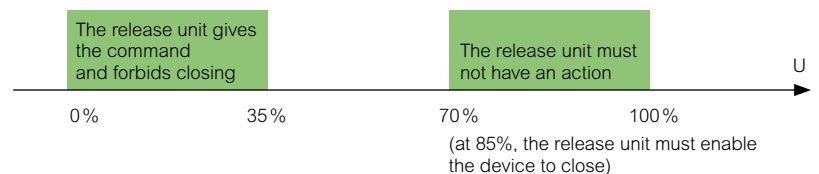

### Rated frequency (cf. § 4.3 and 4.10 IEC 62271-1:2011)

Two frequencies are currently used throughout the world:

50 Hz in Europe, 60 Hz in America, a few countries use both frequencies.

The rated frequency is either 50 Hz or 60 Hz.

# Medium voltage circuit breaker Characteristics

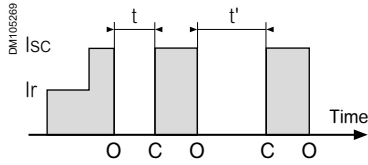

## Rated operating sequence (cf. § 4.104 IEC 62271-100)

See ANSI/IEEE C37.09 for America.

Rated switching sequence according to IEC, O - t - CO - t' - CO.

(cf. opposite diagram)

O	Represents opening operation
CO	Represents closing operation followed immediately by an opening operation

Three rated operating sequences exist:

- slow: O - 3 min - CO - 3 min - CO
- fast 1: O - 0.3 s - CO - 3 min - CO
- fast 2: O - 0.3 s - CO - 15 s - CO

N.B.: other sequences can be requested.

### Close/Open cycle

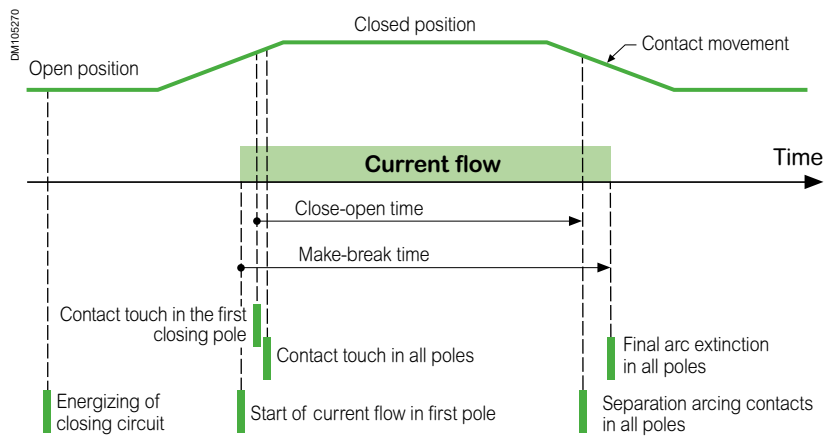

### Automatic reclosing cycle

Assumption: C order as soon as the circuit breaker is open,

(with time delay to achieve 0.3 s or 15 s or 3 min).

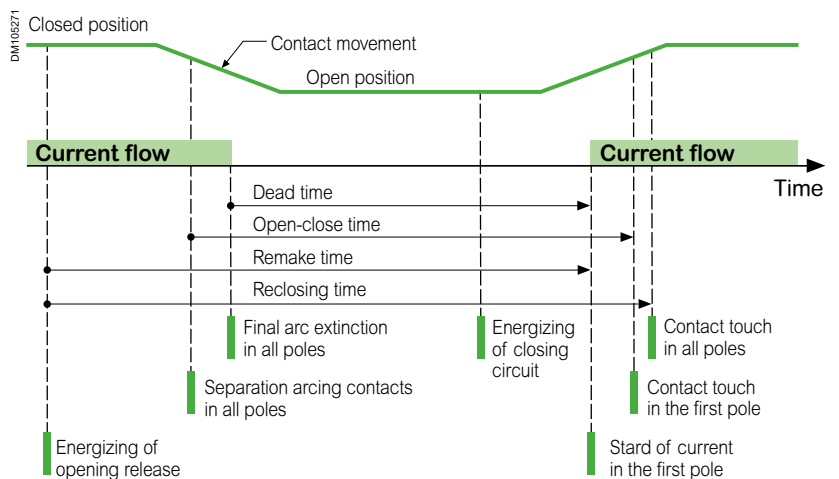

# Medium voltage circuit breaker Characteristics

Percentage of the aperiodic component (% DC) as a function of the time interval (t)

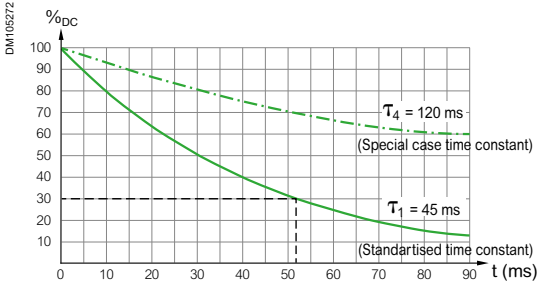

t: circuit breaker opening duration (Top), increased by half a period at the power frequency (Tr).

**Example1:**

For a circuit breaker with a minimum opening time of 45 ms (Top) to which we add 10 ms (Tr) due to relaying, the graph gives a percentage of the aperiodic component of around 30% for a time constant  $\tau_1 = 45$  ms:

$$\%DC = e^{-\frac{-(45 + 10)}{45}} = 29.5\%$$

**Example2:**

Supposing that %DC of a MV circuit breaker is equal to 65% and that the symmetric short-circuit current that is calculated (I<sub>sym</sub>) is equal to 27 kA. What does I<sub>asym</sub> equal?

$$I_{asym} = I_{sym} \times \sqrt{(1+2 \times (\%DC/100)^2)} \text{ [A]}$$

$$I_{asym} = 27 \text{ kA} \times \sqrt{(1+2 \times (0.65)^2)} = 36 \text{ kA}$$

Using the equation [A], this is equivalent to a symmetric short-circuit current at a rating of:

$$I_{asym} = \frac{36.7}{1.086} = 33.8 \text{ kA for a \% DC at 30\%}$$

The circuit breaker rating is greater than 33.8 kA. According to the IEC, the nearest standard rating is 40 kA.

**Rated short-circuit breaking current (cf. § 4.101 IEC 62271-100)**

The rated short-circuit breaking current is the highest value of current that the circuit breaker must be capable of breaking at its rated voltage.

It is characterised by two values:

- the rms value of its periodic component, given by the term: "rated short-circuit breaking current"
- the percentage of the aperiodic component corresponding to the opening time of the circuit breaker, to which we add a half-period of the rated frequency. The half-period corresponds to the minimum activation time of an overcurrent protection device, this being 10 ms at 50 Hz.

According to IEC, the circuit breaker must break the rms value of the periodic component of the short-circuit (= its rated breaking current) with the percentage of asymmetry defined by the graph beside.

As standard the IEC defines MV equipment for a time constant of 45 ms, for a peak value of maximum current equal to 2.5 x I<sub>sc</sub> at 50 Hz or 2.6 x I<sub>sc</sub> at 60 Hz. In this case use the  $\tau_1$  curve.

For low resistive circuits such as generator incomers,  $\tau$  can be higher, with a peak value of maximum current equal to 2.7 x I<sub>sc</sub>. In this case use the  $\tau_4$  curve.

For all time constants  $\tau$  between  $\tau_1$  and  $\tau_4$ , use the equation:

$$\%DC = 100 \times e^{-\frac{-(Top+Tr)}{\tau_{1...4}}}$$

**Values of rated short-circuit breaking current:**

6.3 - 8 - 10 - 12.5 - 16 - 20 - 25 - 31.5 - 40 - 50 - 63 kA.

**Short-circuit breaking tests must meet the five following test sequences:**

Sequence	% I <sub>sym</sub>	% aperiodic component % DC
1	10	≤ 20
2	20	≤ 20
3	60	≤ 20
4	100	≤ 20
5 <sup>(1)</sup>	100	According to equation

(1) For circuit breakers opening in less than 80ms

IMC	Making current
IAC	Periodic component peak value (I <sub>sc</sub> peak)
IDC	Aperiodic component value
DC	% asymmetry or aperiodic component

$$\frac{IDC}{IAC} = 100 \times e^{-\frac{-(Top+Tr)}{\tau_{1...4}}}$$

**Symmetric short-circuit current (in kA):**

$$I_{asym} = \frac{IAC}{\sqrt{2}}$$

**Asymmetric short-circuit current (in kA):**

$$I_{asym} = \sqrt{I_{sym}^2 + IDC^2}$$

$$I_{asym} = I_{sym} \times \sqrt{(1+2 \times (\%DC/100)^2)}$$

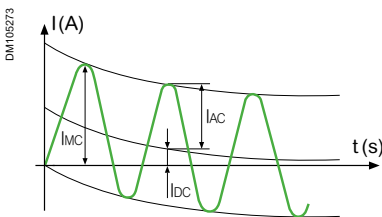

### Rated Transient Recovery Voltage (TRV) (cf. § 4.102 IEC 62271-100)

This is the voltage that appears across the terminals of a circuit breaker pole after the current has been interrupted.

The recovery voltage wave form varies according to the real circuit configuration. A circuit breaker must be able to break a given current for all transient recovery voltages whose value remains below the rated TRV.

#### First pole-to-clear factor

For three-phase circuits, the TRV refers to the pole that breaks the circuit initially, in other words the voltage across the terminals of the first open pole.

The ratio of this voltage to a single phase circuit voltage is called the first pole-to-clear factor, it is equal to 1.5 for voltages up to 72.5 kV (isolated neutral of the supply circuit).

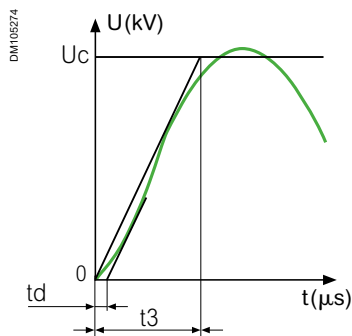

Value of rated TRV for class S1 circuit breaker (intended to be used in cable systems)

- the TRV is a function of the asymmetry, it is given for an asymmetry of 0%.

Rated voltage Range I, series I

Rated voltage (Ur in kV)	TRV peak value (Uc in kV)	Time (t3 in μs)	Delay (td in μs)	Rate of rise of TRV (UC/t3 in kV/μs)
7.2	12.3	51	8	0.24
12	20.6	61	9	0.34
17.5	30	71	11	0.42
24	41.2	87	13	0.47
36	61.7	109	16	0.57

Rated voltage Range I, series II ( North America)

Rated voltage (Ur in kV)	TRV peak value (Uc in kV)	Time (t3 in μs)	Delay (td in μs)	Rate of rise of TRV (UC/t3 in kV/μs)
4.76	8.2	44	7	0.19
8.25	14.1	52	8	0.27
15.5	25.7	66	10	0.39
25.8	44.2	91	14	0.49
38	65.2	109	16	0.6

$$U_c = 1.4 \times 1.5 \times (\sqrt{2}/\sqrt{3}) \times U_r = 1.715 \times U_r$$

$$t_d = 0.15 \times t_3$$

- a specified TRV is represented by a reference plot with two parameters and by a segment of straight line defining a time delay.

td	Time delay
t3	Time defined to reach Uc
Uc	Peak TRV voltage in kV
TRV rate of rise	Uc/t3 in kV/μs

# Medium voltage circuit breaker

## Characteristics

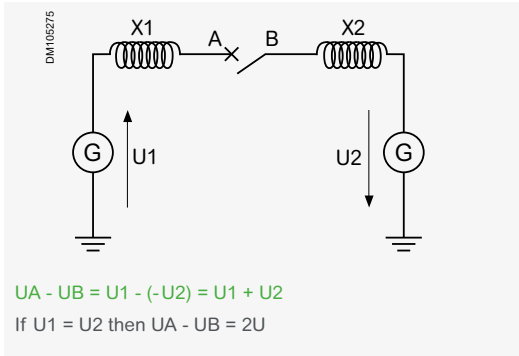

### Rated out-of-phase breaking current (cf. § 4.106 IEC 62271-100)

See ANSI/IEEE C37.09 for America.

When a circuit breaker is open and the conductors are not synchronous, the voltage across the terminals can increase up to the sum of voltages in the conductors (phase opposition).

In practice, standards require the circuit breaker to break a current equal to 25% of the fault current across the terminals, at a voltage equal to twice the voltage relative to earth.

If  $U_r$  is the rated circuit breaker voltage, the power frequency recovery voltage is equal to:

- $2 / \sqrt{3} U_r$  for networks with an effectively earthed neutral system.
- $2.5 / \sqrt{3} U_r$  for other networks.

Peak value of TRV for class S1 circuit breaker, for networks other than those with effectively earthed neutral system:

$$U_c = 1.25 \times 2.5 \times (\sqrt{2}/\sqrt{3}) \times U_r$$

Rated voltage Range I, series I

Rated voltage ( $U_r$ in kV)	TRV peak value ( $U_c$ in kV)	Time ( $t_3$ in $\mu s$ )	Rate of rise of TRV ( $U_c/t_3$ in kV/ $\mu s$ )
7.2	18.4	102	0.18
12	30.6	122	0.25
17.5	44.7	142	0.31
24	61.2	174	0.35
36	91.9	218	0.42

Rated voltage Range I, series II ( North America)

Rated voltage ( $U_r$ in kV)	TRV peak value ( $U_c$ in kV)	Time ( $t_3$ in $\mu s$ )	Rate of rise of TRV ( $U_c/t_3$ in kV/ $\mu s$ )
4.76	12.1	88	0.14
8.25	21.1	104	0.2
15.5	38.3	132	0.29
25.8	65.8	182	0.36
38	97	218	0.45



# Medium voltage circuit breaker

## Characteristics

### Rated cable-charging breaking current (cf. § 4.107 IEC 62271-100)

See ANSI/IEEE C37.09 for America.

The specification of a rated breaking current for a circuit breaker switching unloaded cables is mandatory for circuit breakers of rated voltage lower than 52 kV.

Normal rated breaking current values for a circuit breaker switching unloaded cables:

Rated voltage Range I, series I

Rated voltage (Ur in kV)	Rated breaking current for no-load cables (Ic in kA)
7.2	10
12	25
17.5	31.5
24	31.5
36	50

Rated voltage Range I, series II ( North America)

Rated voltage (Ur in kV)	Rated breaking current for no-load cables (Ic in kA)
4.76	10
8.25	10
15.5	25
25.8	31.5
38	50

### Rated line-charging breaking current (cf. § 4.107 IEC 62271-100)

See ANSI/IEEE C37.09 for America.

The specification of a rated breaking current for a circuit breaker intended for switching unloaded overhead lines is mandatory for circuit breakers of rated voltage  $\geq 72.5$  kV.

### Rated single capacitor bank breaking current (cf. § 4.107 IEC 62271-100)

The specification of a capacitor bank breaking current for a circuit breaker is not compulsory. Due to the presence of harmonics, the breaking current for capacitors is lower or equal to 0.7 times the device's rated current.

Rated current (A)	Breaking current for capacitor (max) (A)
400	280
630	440
1250	875
2500	1750
3150	2200

Two classes of circuit breakers are defined according to their restrike performances:

- Class C1: low probability of restrike during capacitive current breaking
- Class C2: very low probability of restrike during capacitive current breaking.

# Medium voltage circuit breaker

## Characteristics

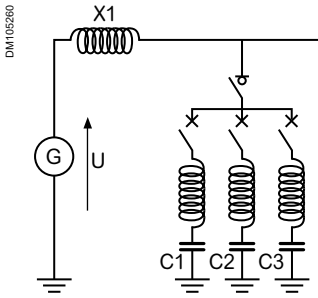

### Rated back-to-back capacitor bank breaking current (cf. § 4.107 IEC 62271-100)

The specification of a breaking current for multi-stage capacitor banks is not compulsory.

### Rated capacitor bank inrush making current (cf. § 4.107 IEC 62271-100)

The rated making current for capacitor banks is the peak current value that the circuit breaker must be capable of making at the rated voltage. The rated making current value of the circuit breaker must be greater than the inrush current for the capacitor bank.

Formulas for calculation of inrush currents for single and back-to-back capacitor banks can be found in Annex H of IEC 62271-100 or in clause 9 of the IEC/TR 62271-306.

Typically, the values of peak current and frequency for inrush currents are in the order of a few kA and some 100 Hz for single capacitor banks, and in the order of a few 10 kA and some 100 kHz for back-to-back capacitor banks.

### Switching of small inductive current (no rating assigned, cf. § 4.108 IEC 62271-100 and IEC 62271-110)

The breaking of low inductive currents (several amperes to several hundreds of amperes) may cause overvoltages.

Surge protection should be applied in some cases according to the type of circuit breaker in order to ensure that the overvoltages do not damage the insulation of the inductive loads (unloaded transformers, motors).

The figure beside shows the various voltages on the load side.

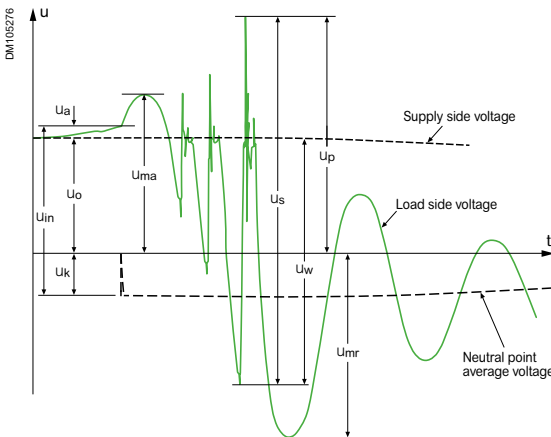

$U_o$	Power frequency voltage crest value to earth
$U_x$	Neutral voltage shift at first-pole interruption
$U_a$	Circuit breaker arc voltage drop
$U_{in}$	$= U_o + U_a + U_c$ Initial voltage at the moment of current chopping
$U_{ma}$	Suppression peak voltage to earth
$U_{mr}$	Load side voltage peak to earth
$U_w$	Voltage across the circuit breaker at re-ignition
$U_p$	Maximum overvoltage to earth (could be equal to $U_{ma}$ or $U_{mr}$ if no re-ignitions occur)
$U_s$	Maximum peak-to-peak overvoltage excursion at re-ignition

### Insulation level of motors

IEC 60034 stipulates the insulation level of motors.

Power frequency and impulse withstand testing is given in the table below (rated insulation levels for rotary sets).

Insulation	Test at 50 ( 60) Hz rms value	Impulse test
Between turns		$(4 U_r + 5)$ kV $4.9 pu + 5 = 31$ kV at 6.6 kV (50% on the sample) Front time 0.5 $\mu$ s
Relative to earth	$(2 U_r + 1)$ kV $2 U_r + 1 \blacktriangleright 2(2 U_r + 1) \blacktriangleright 0$ $14$ kV $\blacktriangleright 28$ kV $\blacktriangleright 0$	$(4 U_r + 5)$ kV $4.9 pu + 5 = 31$ kV at 6.6 kV front time 1.2 $\mu$ s

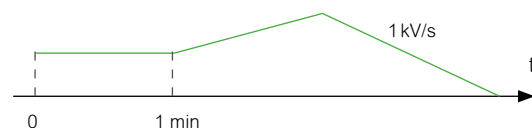

# Medium voltage circuit breaker

## Characteristics

### Normal operating conditions (cf. § 2 IEC 62271-1)

#### Switching of small inductive current

(no rating assigned, cf. § 4.108 IEC 62271-100 and IEC 62271-110)

For all equipment functioning under more severe conditions than those described below, derating should be applied (see derating chapter).

Equipment is designed for normal operation under the following conditions:

#### Temperature

°C	Installation	
	Indoor	Outdoor
Instantaneous ambient		
Minimal	-5 °C	-25 °C
Maximal	+40 °C	+40 °C

#### Humidity

Average relative humidity for a period (max value)	Indoor equipment
24h	95%
1month	90%

#### Altitude

The altitude does not exceed 1000 metres.

### Electrical endurance

Two classes are defined (cf. § 4.111 IEC 62271-100):

- Class E1 with basic electrical endurance
- Class E2 with extended electrical endurance, for circuit breakers which do not require maintenance of the interrupting parts of the main circuit during their expected operating life. Schneider Electric circuit breakers are tested according to class E2.

### Mechanical endurance

Two classes are defined (cf. § 4.110 IEC 62271-100):

- Class M1 with normal mechanical endurance (2000 operations)
- Class M2 with extended mechanical endurance (10 000 operations). Schneider Electric circuit breakers are tested according to class M2.

# Mechanism of Vacuum Circuit Breaker

## Introduction

---

The circuit-breaker is the ultimate electrical safety device, reliable short-circuit current interruption in case of network fault is paramount.

The operating mechanism is a key sub-assembly that has direct impact on the circuit-breaker reliability as well as its cost and size.

This section describes the principle of operation of MV VCB mechanisms, namely solenoid, spring and permanent magnet actuators.

### Standards

Two main standardization bodies are complied with: International Electrotechnical Commission (IEC) and American National Standards Institute (ANSI).

There are significant differences in ratings and performances required by IEC and ANSI/IEEE circuit-breaker standards.

As a result, global manufacturers usually have two different products.

Over the past few years IEC and IEEE standardization committees have made progress towards convergence on type test requirements for MV circuit-breaker standards.

All standards applicable to MV circuit-breakers consider the operating mechanism as a sub-assembly.

They specify ratings and requirements for mechanical functionalities as well as the test procedures to verify the mechanical and electrical performances.

Ratings are defined to meet real operational needs in terms of typical switching sequences and quantity of close-open (CO) cycles to be experienced by the circuit-breaker in its lifetime.

The standards also define rated operating sequences, which are expressed as close (C) and open (O) mechanical operations followed by a time interval (t) expressed in seconds or minutes.

The requirements defined in IEC or ANSI/IEEE standards for mechanical operations, in terms of quantity of operations and operating sequences reflect most of the needs found in the applications of circuit-breakers.

# Mechanism of Vacuum Circuit Breaker

## Mechanical operating principles

### Mechanism operating principles

Three types of operating mechanisms can be found in MV VCBs and auto-reclosers available in the global market today.

These are classed by the type of technology used to store the energy needed to close and open the vacuum interrupters.

- **Solenoid mechanism**

Solenoid mechanisms use a compressed spring to open the interrupter and a solenoid to close it as well as charging the opening spring. The energy required to operate the solenoid is supplied by the DC or AC auxiliary supply.

Solenoids take a high current surge when they are energized, which requires a stiff auxiliary power source (DC battery or LV AC) or a large capacitor discharge, and high rating auxiliary contacts. They are also bulkier and heavier than spring operated mechanism. For this reason, they are now rarely used in practice.

- **Spring mechanism**

Spring mechanisms use separate charged springs to store energy for opening and closing the interrupters.

The closing spring has sufficient energy to charge the opening spring and is recharged either manually or by a small motor supplied by the auxiliary supply.

There are two basic types of VCB spring mechanisms:

- Mechanisms for VCBs that do not require fast reclosing duty (e.g. O – 3 min – CO rated operating sequence);
- Mechanisms for VCBs able to perform fast reclosing duty (e.g. O – 0.3s – CO – 15 s – CO rated operating sequence)

- **Permanent Magnet Actuator (PMA) mechanism**

Permanent magnet actuator (PMA) mechanisms use energy stored in electrolytic capacitor for closing position and permanent magnets to latch in closed position. PMA mechanisms were developed specifically to be used with MV VCBs.

There are two families of PMA mechanisms: mono-stable (single magnetic latch) and bi-stable (double magnetic latch).

The principle of mono-stable PMA mechanism is similar to the solenoid one except that in closed position the mechanical latch is replaced by a permanent magnet latch. The closing force is designed to keep the vacuum interrupter closed with the correct contact pressure while charging the opening spring.

In the bi-stable PMA mechanisms, permanent magnets latch the armature in both closed and open position. To move the armature from one position to the other a high magnetic flux is created by a DC current in the opening or closing coil. This reduces the magnetic latch strength and generates an opposing force in the other air gap.

Energy for open and close operations is derived from two separate electrolytic capacitors that are discharged into the opening and closing coils.

Manual trip in case of loss of DC supply is complex because it requires the application of a high force using a lever to “unstick” the armature from the permanent magnet latch and to provide the opening energy.

Mono-stable PMA is often preferred to bi-stable for the following reasons:

- Eliminates risk of incomplete opening (tripping energy is stored by charging the opening spring).
- Simpler manual and electrical tripping (only requires cancelling the permanent magnet flux to open the VCB).

#### Electronic Control System

PMA mechanisms require an electronic control system that receives either DC or AC auxiliary power, provides DC power to charge the electrolytic capacitors, discharges the stored energy in the opening or closing coils and disconnects the energy source once the VCB has reached the open or closed position.

In most designs, the electronic control system is used to monitor the condition of the capacitors and operating coils, giving alarms in case of anomalies.

The electrolytic capacitor is a key component as it stores the necessary electrical energy that will generate the current pulse needed to operate the PMA. Typical capacitance of 100,000  $\mu\text{F}$  charged at 80 V DC gives a stored energy of 320 Joules, sufficient to carry out a VCB fast reclosing sequence, including short intervals between CO operations.

# Mechanism of Vacuum Circuit Breaker

## Mechanical operating principles

### Applications

VCB type	Application	Expected operation per year	Rated operating sequence	Rated mechanical endurance	Expected operating life	Best adapted VCB mechanism
General purpose	Cable /transformer / feeder /incomer	< 30	0 - 3 min - CO	M1 2000 ops		Spring
Frequent switching	Capacitor Motors Generators DRUPS Overhead feeder	< 300	0 - 0,3s - CO -15s - CO	M2 10000 ops	30 years routine maintenance every 3 years	Spring (Preferred) or PMA
	Pole mounted recloser		0 - 0,3s - CO -2s - CO - 5s - CO			PMA
Heavy duty	Arc furnace	< 3000	0 - 0,3s - CO -15s - CO	Special 30000 ops	10 years Full maintenance every year	PMA

### Reliability

Although spring and PMA mechanisms are based on different technologies, both of them are suitable for most of MV VCB applications.

VCB reliability is not linked to the maximum number of operations that a new device can perform in a laboratory. The real parameter to consider is operational MTBF (Mean Time Between Failures).

Spring mechanism reliability is determined by mechanical system failure rates only while PMA mechanism reliability is determined by the combination of mechanical and electronic failure rates.

Although spring mechanisms have a risk of performing a "slow open" operation after long periods of inactivity, the risk can be reduced by carrying out periodical VCB operation test.

In summary, the author's logical arguments challenge the idea that VCBs with PMA mechanism with higher mechanical endurance are more reliable than VCBs with motorized spring operation.

This qualitative analysis highlights just some aspects of the impact of operating mechanism on VCB reliability, thus opening debate among the MV switchgear experts. Further work is required to achieve accurate VCB reliability models.

# Switches

## Introduction

## Characteristics

---

### Introduction

Alternating current switches and switch-disconnectors for their switching function, have making and breaking current ratings, for indoor and outdoor installations, for rated voltages above 1 kV up to and including 52 kV and for rated frequencies from 162/3 Hz up to and including 60 Hz shall follow the IEC 62271-103 standard. This standard is also applicable to single-pole switches used on three phase systems.

It is assumed that opening and closing operations are performed according to the manufacturer's instructions. A making operation may immediately follow a breaking operation but a breaking operation should not immediately follow a making operation since the current to be broken may then exceed the rated breaking current of the switch.

### Characteristics

#### Common with IEC 62271-1:2011

- a rated voltage;
- b rated insulation level;
- c rated frequency;
- d rated normal current and temperature rise;
- e rated short-time withstand current;
- f rated peak withstand current;
- g rated duration of short-circuit;
- h rated supply voltage of closing and opening devices and of auxiliary circuits;
- i rated supply frequency of closing and opening devices and of auxiliary circuits;
- j rated pressures of compressed gas for controlled pressure systems;

#### Specific to switches IEC 62271-103

- k rated filling levels for insulation and/or operation
  - rated filling levels for insulation and/or switching
  - rated filling levels for operation
- l rated mainly active load-breaking current
- m rated closed-loop breaking current
- n rated cable-charging breaking current
- o rated line-charging breaking current
- p rated single capacitor bank breaking current for special purpose switches
- q rated back-to-back capacitor bank breaking current for special purpose switches
- r rated back-to-back capacitor bank inrush making current for special purpose switches
- s rated earth fault breaking current
- t rated cable- and line-charging breaking current under earth fault conditions
- u rated motor breaking current for special purpose switches
- v rated short-circuit making current
- w rated breaking and making currents for a general purpose switch
- x ratings for limited purpose switches
- y ratings for special purpose switches
- z ratings for switches backed by fuses
- aa Type and classes for general purpose, limited purpose and special purpose switches

# Switches

## Characteristics

---

### Rated pressures of compressed gas for controlled pressure systems (cf. § 4.10 IEC 62271-1 & 4.10 IEC 62271-103)

The preferred values of rated pressure (relative pressure) are: 0,5 MPa - 1 MPa - 1,6 MPa - 2 MPa - 3 MPa - 4 MPa. This rating applies only to power sources of operating devices.

NOTE: Controlled pressure systems for insulation or switching are no longer manufactured up to 52 kV level. Therefore, only gas supply for operating devices is considered.

### Rated filling levels for insulation and/or operation (cf. § 4.11 IEC 62271-1 & cf 4.11 IEC 62271-103)

The pressure in Pa (or density) or liquid mass shall be assigned by the manufacturer referred to atmospheric air conditions of 20 °C at which the gas- or liquid-filled switchgear is filled before being put into service.

- Rated filling levels for insulation and/or switching. This rating applies for any kind of liquid or gas used for insulation or switching.
- Rated filling levels for operation. This rating applies for any kind of liquid or gas used as power source for the operating device.

### Rated mainly active load-breaking current ( $I_{load}$ ) (cf. § 4.101 IEC 62271-103)

The rated mainly active load-breaking current is the maximum mainly active load current that the switch shall be capable of breaking at its rated voltage. Its value shall be equal to the rated normal current if no other value is indicated on the nameplate.

### Rated closed-loop breaking current ( $I_{loop}$ and $I_{ptr}$ ) (cf. § 4.102 IEC 62271-103)

The rated closed-loop breaking current is the maximum closed-loop current the switch shall be capable of breaking. Separate ratings for distribution line loop breaking current and parallel power transformer breaking current may be assigned.

### Rated cable-charging breaking current ( $I_{cc}$ ) (cf. § 4.103 IEC 62271-103)

The rated cable-charging breaking current is the maximum cable-charging current that the switch shall be capable of breaking at its rated voltage.

### Rated line-charging breaking current ( $I_{lc}$ ) (cf. § 4.104 IEC 62271-103)

The rated line-charging breaking current is the maximum line-charging current that the switch shall be capable of breaking at its rated voltage.

### Rated single capacitor bank breaking current for special purpose switches ( $I_{sb}$ ) (cf. § 4.105 IEC 62271-103)

The rated single capacitor bank breaking current is the maximum capacitor bank current that a special purpose switch shall be capable of breaking at its rated voltage with no capacitor bank connected to the supply side of the switch adjacent to the bank being switched.



# Switches

## Characteristics

---

### Rated back-to-back capacitor bank breaking current for special purpose switches ( $I_{bb}$ ) (cf. § 4.106 IEC 62271-103)

The rated back-to-back capacitor bank breaking current is the maximum capacitor bank current that a special purpose switch shall be capable of breaking at its rated voltage with one or more capacitor banks connected on the supply side of the switch adjacent to the bank being switched.

### Rated back-to-back capacitor bank inrush making current for special purpose switches ( $I_{in}$ ) (cf. § 4.107 IEC 62271-103)

The rated back-to-back capacitor bank inrush making current is the peak value of the current that a special purpose switch shall be capable of making at its rated voltage and with a frequency of the inrush current appropriate to the service conditions.

The assignment of a rated back-to-back capacitor bank inrush making current is mandatory for switches that have a rated back-to-back capacitor bank breaking current.

NOTE: The frequency of the inrush current for back-to-back capacitor banks may be in the range of 2 kHz to 30 kHz. The frequency and magnitude of the inrush current are dependent upon the size and configuration of the capacitor bank being switched, the capacitor bank already connected to the supply side of the switch and the inclusion of limiting impedances, if any.

The switch is not necessarily rated to break the inrush making current produced by the back-to-back capacitor bank installation.

### Rated earth fault breaking current ( $I_{ef1}$ ) (cf. § 4.108 IEC 62271-103)

The rated earth fault breaking current is the maximum earth fault current in the faulted phase that the switch shall be capable of breaking at its rated voltage, when used on a non-effectively earthed neutral system.

NOTE: The maximum earth fault breaking current is 3 times the cable-and line-charging current occurring in normal conditions. This covers the most severe case, which occurs with individually screened cables.

### Rated cable- and line-charging breaking current under earth fault conditions ( $I_{ef2}$ ) (cf. § 4.109 IEC 62271-103)

The rated cable-and line-charging breaking current under earth fault conditions is the maximum current in the non-faulty phases that the switch shall be capable of breaking at its rated voltage, when used on a non-effectively earthed neutral system.

NOTE: The maximum cable-and line-charging current under fault conditions is  $\sqrt{3}$  times the cable-and line-charging current occurring in normal conditions. This covers the most severe case, which occurs with individually screened cables.

# Switches

## Characteristics

### Rated motor breaking current for special purpose switches ( $I_{mot}$ ) (cf. § 4.110 IEC 62271-103)

The rated motor breaking current is the maximum steady-state current of a motor the switch shall be capable of opening at its rated voltage. Refer to IEC 62271-110 standard on inductive load switching. NOTE: Unless otherwise specified, the breaking current for the condition of a stalled motor is eight times the rated normal current of the motor.

### Rated short-circuit making current ( $I_{ma}$ ) (cf. § 4.111 IEC 62271-103)

The rated short-circuit making current is the maximum peak current that the switch shall be capable of making at its rated voltage.

### Rated breaking and making currents for a general purpose switch (cf. § 4.112 IEC 62271-103)

A general purpose switch shall have specific ratings for each switching duty as follows:

- rated mainly active load-breaking current equal to the rated normal current;
  - rated distribution line loop-breaking current equal to the rated normal current;
  - rated cable-charging breaking current as shown in Table 1;
  - rated line-charging breaking current as shown in Table 1;
  - rated short-circuit making current equal to the rated peak withstand current;
- and additionally for switches intended to be used in non-effectively earthed neutral systems:
- rated earth fault breaking current;
  - rated cable- and line-charging breaking current under earth fault conditions.

#### Range I, series I

Rated voltage	Rated cable charging	Rated line charging
$U_r$ (kV)	$I_{cc}$ (A)	$I_{lc}$ (A)
7.2	6	0.5
12	10	1
17.5	10	1
24	16	1.5
36	20	2

#### Range I, series II

Rated voltage	Rated cable charging	Rated line charging
$U_r$ (kV)	$I_{cc}$ (A)	$I_{lc}$ (A)
4.76	4	0.3
8.25	6	0.5
15	10	1
25.8	16	1.5
38	20	2

# Switches

## Characteristics

---

### Rated breaking and making currents for a general purpose switch (cf. § 4.113 IEC 62271-103)

A limited purpose switch shall have a rated normal current, a rated short-time withstand current, and one or more, but not all, switching capabilities of a general purpose switch. If other ratings are specified, values from the R10 series specified in IEC 60059 standard, should be selected.

### Ratings for special purpose switches (cf. § 4.114 IEC 62271-103)

A special purpose switch shall have a rated normal current, a rated short-time withstand current and may have one or more switching capabilities of a general purpose switch.

Ratings and capabilities shall be assigned for the specific special service application for which the switch is designed. The rated values should be selected from the R10 series. One or more of the following ratings and capabilities may be assigned:

- parallel power transformer breaking capacity;
- single capacitor bank breaking capacity;
- back-to-back capacitor bank switching;
- motor breaking capacity.

### Ratings for switches backed by fuses (cf. § 4.115 IEC 62271-103)

General purpose, limited purpose and special purpose switches may be backed by fuses.

If this is the case, short-circuit ratings, short-time withstand currents, and making currents of switches may be selected by consideration of the limiting effect on the duration and value of the short-circuit current by fuses.

IEC 62271-105 standard about alternating current switch-fuse combinations may be used for this purpose.

### Type and classes for general purpose, limited purpose and special purpose switches (cf. § 4.116 IEC 62271-103)

Every switch complying with this standard shall be designated by type as general purpose, limited purpose, or special purpose.

In addition, a switch shall be also designated by its class of:

- mechanical endurance (M1 or M2);
- electrical endurance (E1, E2 or E3) for general purpose switch;
- capacitive switching (C1 or C2).

All of this endurance classification are described within the IEC 62271-103 standard.

IEC 62271-102 defines on one hand the operating conditions, the rated characteristics, the design and the manufacture; and on the other hand the testing, the selection of controls and installation.

### Introduction

In the MV applications, the disconnector switches are used to get a separation from a circuit which could be live, with better performances than those provided by another switching device. The performance for the dielectric withstand between open contacts is expressed through two values, for industrial frequency voltage and lightning impulse voltage, and checked with usual acceptance criteria, meaning an acceptable flashover occurrence of 2/15 under test (for self-restoring insulation).

A disconnector switch is not a safety device.

The most dangerous misunderstanding would be to consider that a disconnector alone is able to ensure the safety for people downstream.

### Characteristics

Common with IEC 62271-1

- a rated voltage;
- b rated insulation level;
- c rated frequency;
- d rated normal current;
- e rated short-time withstand current;
- f rated peak withstand current;
- g rated duration of short-circuit;
- h rated supply voltage of closing and opening devices and of auxiliary circuits;
- i rated supply frequency of closing and opening devices and of auxiliary circuits;
- j rated pressures of compressed gas for controlled pressure systems;

Specific to disconnector and earthing switches

- k rated short-circuit making current (for earthing switches only);
- l rated contact zone (for divided support disconnectors only);
- m rated mechanical terminal load;

and for rated voltages 52 kV and above:

- n rated values of the bus-transfer current switching capability of disconnectors;
- o rated values of the induced current switching capability of earthing switches.

For all voltage ranges:

- p Rated values of mechanical endurance for disconnectors
- q Rated values of electrical endurance for earthing switches

#### Rated short-time withstand current (cf § 4.5 IEC 62271-1 & IEC 62271-102)

The rated short-time withstand current of an earthing switch forming an integral part of a combined function earthing switch shall be equal to the rated short-time withstand current of the combined function earthing switch, unless otherwise specified.

#### Rated peak withstand current (cf. § 4.6 IEC 62271-1 & 6 IEC 62271-102) and making current (cf. § 4.101 IEC 62271-102)

The rated peak withstand current of an earthing switch forming an integral part of a combined function earthing switch shall be equal to the rated peak withstand current of the combined function earthing switch, unless otherwise specified.

#### Rated contact zone (cf. § 4.102 IEC 62271-102)

# Disconnecter and earthing switches

## Characteristics

### Rated mechanical terminal load (cf § 4.103 IEC 62271-102)

The mechanical terminal loads are applicable for the disconnectors even for rated voltages under 52kV and the recommended values can be used. A additional check according to the stresses coming from local service conditions is advised.

Disconnectors and earthing switches shall be able to close and open while subjected to their rated static mechanical terminal loads.  
Disconnectors and earthing switches shall be able to withstand their rated dynamic mechanical terminal load under short-circuit.

The stresses to the insulators to assure the whole function shall be taken into account during the design phase.

Recommended static mechanical terminal loads

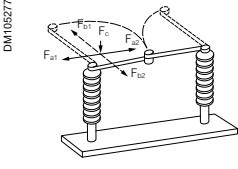
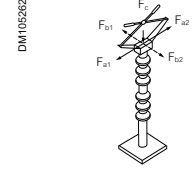
Rated voltage (Ur) kV	Rated normal current A	Two- and three-column disconnectors		Divided support disconnectors		Vertical Force $F_c^{(1)}$ N
		Straight load $F_{a1}$ and $F_{a2}$	Cross-load $F_{b1}$ and $F_{b2}$	Straight load $F_{a1}$ and $F_{a2}$	Cross-load $F_{b1}$ and $F_{b2}$	
						
		N	N	N	N	
52_72,5	800_1250	800_1250	130	800	200	500

(1)  $F_c$  simulates the downward forces caused by the weight of the connecting conductors. With flexible conductors the weight is included in the longitudinal or perpendicular forces.

### Rated values of the bus-transfer current switching capability of disconnectors (cf § 4.104 IEC 62271-102)

### Rated values of the induced current switching capability of earthing switches (cf § 4.105 IEC 62271-102)

### Rated values of mechanical endurance for disconnectors (cf § 4.106 IEC 62271-102)

A disconnector shall be able to perform the following number of operations taking into account the programme of maintenance specified by the manufacturer:

Class	Type of disconnector	Number of operating cycles
MO	Standard disconnector earthing switch (normal mechanical endurance)	1000
M1	Disconnector intended for use with a circuit-breaker of equal class (extended mechanical endurance)	2000
M2	Disconnector intended for use with a circuit-breaker of equal class (extended mechanical endurance)	10000

### Rated values of electrical endurance for earthing switches (cf § 4.107 IEC 62271-102)

Following table provides a classification of earthing switch for electrical endurance:

Class	Type of earthing switch
E0	Earthing switches with no making capability
E1	Earthing switches with capability to withstand two short-circuit making operations
E2	Earthing switches with capability to withstand five short-circuit making operations

# Current-limiting fuses

## Introduction

## Characteristics

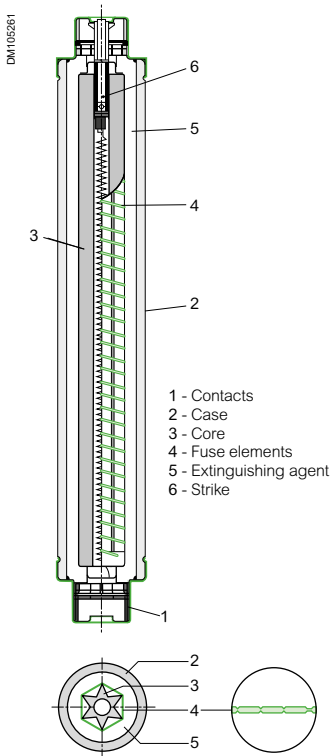

Sectional view of a fuse link

## Introduction

MV current-limiting fuses are primarily used to protect transformers, and also motors, capacitors and other loads.

## Characteristics

### Ratings of the fuse-base

- Rated voltage
- Rated current
- Rated insulation level (power-frequency, dry, wet and impulse withstand voltages)

### Ratings of the fuse-link

- Rated voltage
- Rated current
- Rated maximum breaking current
- Rated frequency
- Rated minimum breaking current for Back-Up fuses.
- Rated TRV

### Characteristics of the fuse-link

- Temperature rise
- Class
- Switching voltages
- Time-current characteristics
- Cut-off characteristics
- $I^2t$  characteristics
- Mechanical characteristics of the strikers
- Maximum application temperature

### Rated voltage ( $U_r$ ) (cf. § 4.2 IEC 60282-1)

A voltage used in the designation of the fuse-base or fuse-link, from which the test conditions are determined.

The rated voltage of a fuse and should be selected from the following table.

Series I (kV)	Series II (kV)
3,6	2,75
7,2	5,5
12	8,25
17,5	15
24	15,5
36	25,8
40,5	38

NOTE 1: This rated voltage represents the highest voltage for the equipment (see IEC 60038).

NOTE 2: On three-phase solidly earthed systems, fuses may only be used provided that the highest system voltage is less than or equal to their rated voltage. On single phase or non-solidly earthed systems, fuses may only be used provided that the highest system voltage is less than or equal to 87 % of their rated voltage, unless specific testing has been performed (see IEC/TR 62655:2013, 5.1.3).

# Current-limiting fuses

## Characteristics

Voltage across the fuse

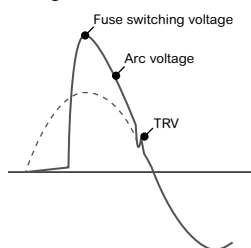

Current through the fuse

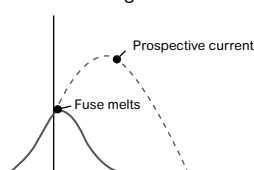

High current interruption for current limiting fuse

### Rated insulation level (fuse-base) (cf. § 4.23 IEC 60282-1)

Fuse-base rated insulation levels – Series I

It is based on practice in Europe, and standard reference conditions of temperature, pressure and humidity are 20 °C, 101,3 kPa and 11 g/m<sup>3</sup>, respectively, of water.

Rated voltage of the fuse kV	Rated lightning impulse withstand voltage (negative and positive polarity)				Rated 1 min power-frequency withstand voltage (dry and wet) kV (r.m.s.)	
	List 1 kV (peak)		List 2kV (peak)		To earth and between poles	Across the isolating distance of the fuse-base (see note)
	To earth and between poles	Across the isolating distance of the fuse-base (see note)	To earth and between poles	Across the isolating distance of the fuse-base (see note)		
3,6	20	23	40	46	10	12
7,2	40	46	60	70	20	23
12	60	70	75	85	28	32
17,5	75	85	95	110	38	45
24	95	110	125	145	50	60
36	145	165	170	195	70	80
40,5	180	200	190	220	80	95
52	250	290	250	290	95	110
72,5	325	375	325	375	140	160

NOTE: An isolating insulation level should be specified only for those fuse-bases to which isolating properties are assigned.

Fuse-base rated insulation levels – Series II

It is based on practice in the U.S.A. and Canada where standard reference conditions of temperature, pressure and humidity are 25 °C, 101,3 kPa and 15 g/m<sup>3</sup>, respectively, of water.

Rated voltage of the fuse kV	Rated lightning impulse withstand voltage (negative and positive polarity) kV (peak)				Rated power-frequency withstand voltage kV (r.m.s.)					
	To earth and between poles		Across the isolating distance of the fuse-base (see note)		To earth and between poles			Across the isolating distance of the fuse-base (see note)		
					Outdoor		Outdoor			
					1 min dry	10 s wet	1 min dry	10 s wet	1 min dry	10 s wet
2,75	45		50		15			17		
4,76	60		70		19			21		
8,25	75	95	80	105	26	35	30	29	39	33
15	95		105		36			40		
15,5	110	110	125	125	50	50	45	55	55	50
25,8	125	150	140	165	60	70	60	66	77	66
38	150	200	165	220	80	95	80	88	105	88
48,3		250		275		120	100		132	110
72,5		350		385		175	145		195	160

Note: An isolating insulation level should be specified only for those fuse-bases to which isolating properties are assigned.

### Rated frequency (cf. § 4.4 IEC 60282-1)

Standard values of rated frequency are 50 Hz and 60 Hz.

# Current-limiting fuses

## Characteristics

### Rated current of the fuse-base (cf. § 4.5 IEC 60282-1)

The rated current of the fuse-base should be selected from the following values: 10 A, 25 A, 63 A, 100 A, 200 A, 400 A, 630 A, 1 000 A.

### Rated current of the fuse-link (I<sub>r</sub>) (cf. § 4.6 IEC 60282-1)

The rated current in amperes of the fuse-link should be selected from the R10 series. For special cases, additional values for the rated current of the fuse-link may be selected from the R20 series.

NOTE : The R10 series comprises the numbers 1; 1,25; 1,6; 2; 2,5; 3,15; 4; 5; 6,3; 8 and their multiples of 10. The R20 series comprises the numbers 1; 1,12; 1,25; 1,40; 1,6; 1,8; 2; 2,24; 2,5; 2,8; 3,15; 3,55; 4; 4,5; 5; 5,6; 6,3; 7,1; 8; 9 and their multiples of 10.

### Temperature-rise limits (cf. § 4.7 IEC 60282-1)

Component or material	Maximum value of Temperature $\theta$ (°C)	Temperature rise K
<b>Contacts in air</b>		
Spring-loaded contacts (copper or copper alloy)		
bare	75	35
silver- or nickel-coated	105	65
tin-coated	95	55
other coatings <sup>(1)</sup>		
Bolted contacts or equivalent (copper, copper alloy and aluminium alloy)		
bare	90	50
silver- or nickel-coated	105	65
tin-coated	115	75
other coatings <sup>(1)</sup>		
<b>Contacts in oil (copper or copper alloy)</b>		
Spring-loaded contacts (copper or copper alloy)		
bare	80	40
silver- tin, or nickel-coated	90	50
other coatings (footnote a)		
Bolted contacts or equivalent		
bare	80	40
silver- tin, or nickel-coated	100	60
other coatings <sup>(1)</sup>		
<b>Bolted terminals in air</b>		
bare	90	50
silver- tin, or nickel-coated	105	65
other coatings <sup>(1)</sup>		
<b>Metal parts acting as springs<sup>(2)</sup></b>		
<b>Materials used as insulation and metal parts in contact with insulation of following classes<sup>(3)</sup></b>		
Class Y (for non-impregnated materials)	90	50
Class A (for materials immersed in oil)	100	60
Class E	120	80
Class B	130	90
Class F	155	115
Enamel: oil base / synthetic	100 / 120	60 / 80
Class H	180	140
<b>Other classes<sup>(4)</sup></b>		
Oil <sup>(5)(6)</sup>	90	50
Any part of metal or of insulating material in contact with oil except contacts and springs	100	60

(1) If the manufacturer uses coatings other than those indicated in this table, the properties of these materials should be taken into consideration.

(2) The temperature or the temperature rise should not reach such a value that the elasticity of the metal is impaired.

(3) Classes according to IEC 60085.

(4) Limited only by the requirement not to cause any damage to surrounding parts.

(5) At the upper part of the oil.

(6) Special consideration should be given with regard to vaporisation and oxidation when low-flash-point oil is used.

The given temperature value may be exceeded for transformer-type applications and/or if synthetic or other suitable insulating liquids are used (see 8.3.2 and IEC 60076-7).



# Current-limiting fuses

## Characteristics

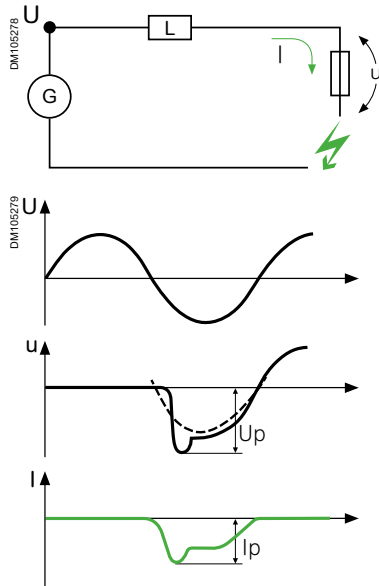

Disconnection at I1, Maximum breaking capacity

### Rated breaking capacity (cf. § 4.8 IEC 60282 and IEC/TR 62655)

Rated maximum breaking current (I1)

The rated maximum breaking current in kA of the fuse-link should be selected from the R10 series.

NOTE: The R10 series comprises the numbers 1; 1,25; 1,6; 2; 2,5; 3,15; 4; 5; 6,3; 8 and their multiples of 10.

### Rated minimum breaking current and class

The manufacturer shall indicate the class as follows:

- Back-Up fuses & its rated minimum breaking current (I3)  
Fuses capable of breaking all currents from their rated minimum breaking current, up to their rated maximum breaking current.
- General-Purpose fuses & if any the minimum breaking current  
Fuses capable of breaking all currents from a value, equal to a current that causes the fuse to melt in one hour, up to the rated maximum breaking current of the fuse.
- Full-Range fuses  
Fuses capable of breaking all currents that cause the fuse to melt, up to the rated maximum breaking current of the fuse.

### Limits of switching voltage (cf. § 4.9 IEC 60282 and IEC/TR 62655)

The significance of any fuse design exceeding the proscribed limits would be in terms of possible external insulation breakdown or even flashover during fuse operation and arrester failure.

The value of switching voltages during operation in all test duties shall not exceed those mentioned in following table. Other maximum switching voltage values for higher rated voltages for certain fuse-links of small current ratings are detailed within the IEC 60282-1.

Series I		Series II	
Rated voltage kV	Maximum switching voltage kV	Rated voltage kV	Maximum switching voltage kV
3,6	12	2,75	8
7,2	23	5,5	18
12	38	8,25	26
17,5	55	15	47
24	75	15,5	49
36	112	22	70
40,5	126	25,8	81

### Rated Transient Recovery Voltage (TRV) (cf. § 4.10 IEC 60282-1)

The rated Transient Recovery Voltage is the reference voltage which constitutes the upper limit of the prospective transient recovery voltage of circuits which the fuse shall be capable of breaking in the event of a short circuit. IEC 60282-1 establish appropriate values of TRV for each test current duties at short-circuit levels.

However, because of the forced current zero occurs close to the circuit voltage zero, current limiting fuses are much less sensitive to TRV than other non-limiting switching devices.

# Current-limiting fuses

## Characteristics

### Time-current characteristics (cf. § 4.11 IEC 60282-1)

For each type of fuse link, there is a fusing or pre-arc duration that corresponds to an rms current value.

The duration of the pre-arc for each current value can be determined by plotting a curve on a standardized logarithmic scale (see figure below). This curve relates only to the pre-arc.

Mention must also be made at this point of the pre-arc durations for values of current less than I<sub>3</sub>. In this case, the curve is plotted as a dotted line.

It is also possible to determine the value of I<sub>3</sub> (solid line limit) on this diagram. This curve extends until it reaches a pre-arc duration of >600 s (depending on the fuse class.)

Time-current characteristic is given always with a tolerance (current values are +20%, +10% or +5%) with respect to the current.

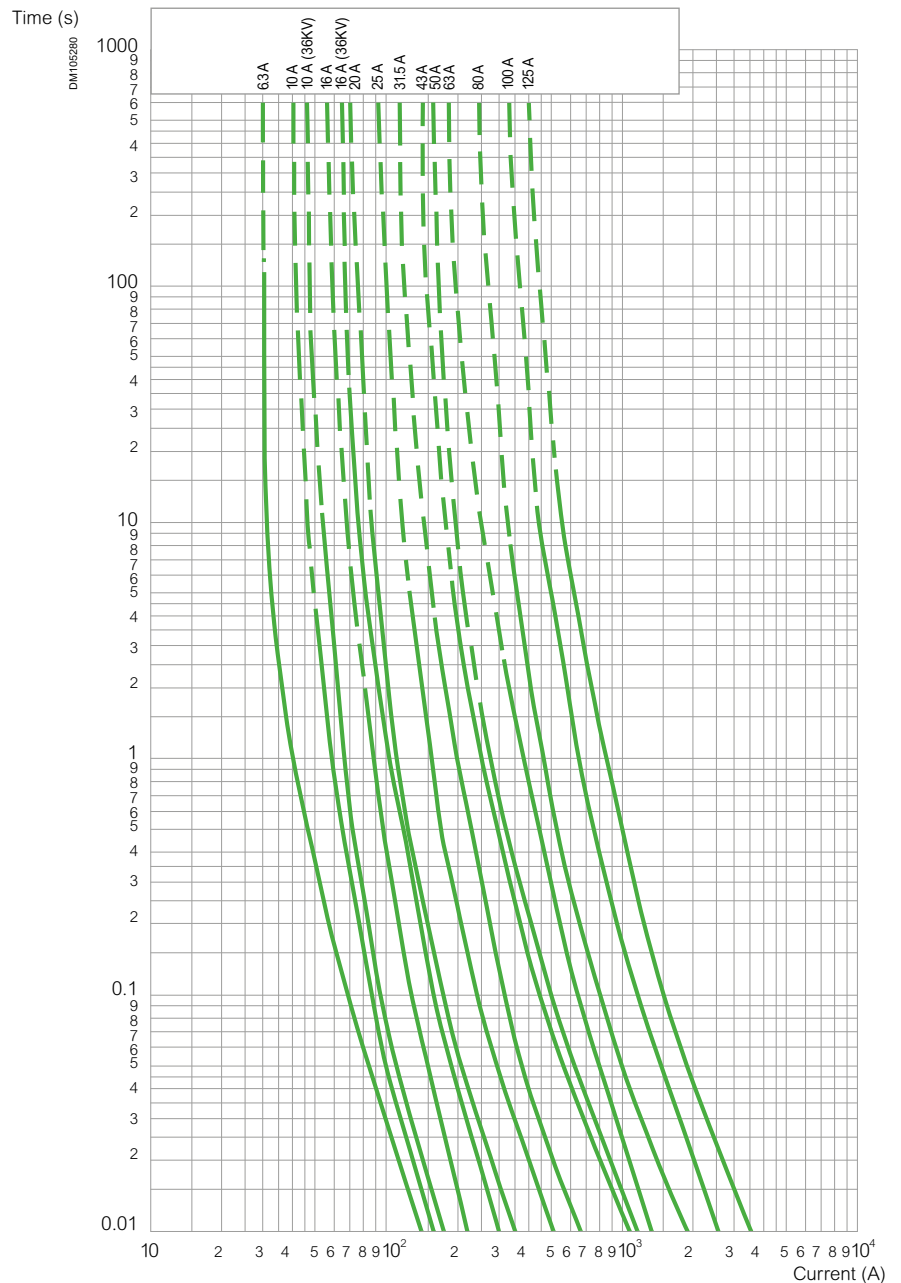

# Current transformer

## Primary circuit's characteristics according to IEC standards

Please note!  
Never leave a CT in an open circuit.

This is intended to provide a secondary circuit with a current proportional to the primary current.

### Rated transformation ratio (Kr)

$$K_r = \frac{I_{pr}}{I_{sr}} = \frac{N_2}{N_1}$$

N.B.: current transformers must be in conformity with IEC standard 61869-2 but can also be defined by other standards (ANSI, BR...).

It comprises one or several primary windings and one or several secondary windings each having their own magnetic circuit, and all being encapsulated in an insulating resin.

It is dangerous to leave a CT in an open circuit because dangerous voltages for both people and equipment may appear across its terminals.

## Primary circuit's characteristics according to IEC standards

### Rated frequency (fr)

A CT defined at 50 Hz can be installed on a 60 Hz network. Its precision is retained. The opposite is not true.

### Rated primary circuit voltage (Upr)

**General case:**

Rated CT voltage  $\geq$  rated installation voltage

The rated voltage sets the equipment insulation level (see "Introduction" chapter of this guide). Generally, we would choose the rated CT voltage based on the installation operating voltage U, according to the chart:

U	3.3	5	5.5	6	6.6	10	11	13.8	15	20	22	30	33
Upr	7.2 kV		12 kV			17.5 kV			24 kV		36 kV		

**Special case:**

If the CT is a ring CT installed on a bushing or on a cable, the dielectric insulation is provided by the cable or bushing insulation.

# Current transformer

## Primary circuit's characteristics according to IEC standards

### Primary operating current (I<sub>ps</sub>)

An installation's primary operating current I (A) (for a transformer feeder for example) is equal to the CT primary operating current (I<sub>ps</sub>) taking account of any possible derating.

If:

S	Apparent power in kVA
U	Primary operating voltage in kV
P	Active power of the motor in kW
Q	Reactive power of capacitors in kvars
I <sub>ps</sub>	Primary operating current in A

We will have:

- Incomer cubicle, generator set incomer and transformer feeder

$$I_{ps} = \frac{S}{\sqrt{3} \times U}$$

- motor feeder

$$I_{ps} = \frac{P}{\sqrt{3} \times U \times \cos \phi \times \eta}$$

η	Motor efficiency
---	------------------

If you do not know the exact values of  $\phi$  and  $\eta$ , you can take as an initial approximation:  $\cos \phi = 0.8$ ;  $\eta = 0.8$ .

- capacitor feeder  
1.3 is a derating coefficient of 30% to take account of temperature rise due to capacitor harmonics.

$$I_{ps} = \frac{1.3 \times Q}{\sqrt{3} \times U}$$

- bus sectioning

The current I<sub>ps</sub> of the CT is the greatest value of current that can flow in the bus sectioning on a permanent basis.

### Rated primary current (I<sub>pr</sub>)

The rated current (I<sub>pr</sub>) will always be greater than or equal to the operating current (I) for the installation.

Standardised values: 10 - 12.5 - 15 - 20 - 25 - 30 - 40 - 50 - 60 - 75 A and their decimal multiples or fractions.

For metering and usual current-based protection devices, the rated primary current must not exceed 1.5 times the operating current. In the case of protection, we have to check that the chosen rated current enables the relay setting threshold to be reached in the case of a fault.

N.B.: current transformers should be able to withstand 1.2 times the rated current on a constant basis to avoid too high temperature rise in the switchgear installation.

In the case of an ambient temperature greater than 40°C for the CT, the CT's nominal current (I<sub>pn</sub>) must be greater than I<sub>ps</sub> multiplied by the derating factor corresponding to the cubicle.

The table 5 of the IEC 61869-1 gives the temperature rise limits.

As a general rule, the derating could be of 1% I<sub>pn</sub> per degree above 40°C. (See "Derating" chapter in this guide).

#### Example1:

A thermal protection device for a motor has a setting range of between 0.3 and  $1.2 \times I_r$ TC.

In order to protect this motor, the required setting must correspond to the motor's rated current.

If we suppose that I<sub>r</sub> for the motor = 25 A, the required setting is therefore 25 A;

- if we use a 100/5 CT, the relay will never see 25 A because:  $100 \times 0.3 = 30 > 25$  A.
- if on the other hand, we choose a CT 50/5, we will have:  $0.3 < I_r < 1.2$  and therefore we will be able to set our relay. This CT is therefore suitable.

# Current transformer

## Primary circuit's characteristics according to IEC standards

### Rated thermal short-circuit current (I<sub>th</sub>)

The rated thermal short-circuit current is generally the rms value of the installation's maximum short-circuit current and the duration of this is generally taken to be equal to 1 s.

Each CT must be able to withstand the short-circuit current which can flow through its primary circuit both thermally and dynamically until the fault is effectively broken.

If S<sub>sc</sub> is the network short-circuit power expressed in MVA, then:

$$I_{ps} = \frac{S_{sc}}{\sqrt{3} \times U}$$

When the CT is installed in a fuse protected cubicle, the I<sub>th</sub> to use is equal to 80 I<sub>r</sub>.

If 80 I<sub>r</sub> > I<sub>th</sub> 1 s for the disconnecting device, then I<sub>th</sub> 1 s for the CT = I<sub>th</sub> 1 s for the device.

### Overcurrent coefficient (K<sub>si</sub>)

Knowing this allows us to know whether a CT will be easy to manufacture or otherwise.

$$K_{si} = \frac{I_{th} \text{ 1 s}}{I_{pr}}$$

The lower K<sub>si</sub> is, the easier the CT will be to manufacture.

A high K<sub>si</sub> leads to over-dimensioning of the primary winding's section.

The number of primary turns will therefore be limited together with the induced electromotive force; the CT will be even more difficult to produce.

Order of magnitude	Manufacture
<b>K<sub>si</sub></b>	
K <sub>si</sub> < 100	Standard
100 < K <sub>si</sub> < 300	Sometimes difficult for certain secondary characteristics
100 < K <sub>si</sub> < 400	Difficult
400 < K <sub>si</sub> < 500	Limited to certain secondary characteristics
K > 500 V	Very often impossible

A CT's secondary circuit must be adapted to constraints related to its use, either in metering or in protection applications.

# Current transformer

## Secondary circuit's characteristics according to IEC standards

### Rated secondary current (I<sub>sr</sub>) 5 or 1 A?

General case:

- for local use I<sub>sr</sub> = 5 A
- for remote use I<sub>sr</sub> = 1 A

Special case: for local use I<sub>sr</sub> = 1 A

N.B.: using 5 A for a remote application is not forbidden but leads to an increase in transformer dimensions and cable section, (line loss:  $P = R I^2$ ).

### Accuracy class

- Metering: class 0.1 - 0.5
- Switchboard metering: class 0.5 - 1
- Overcurrent protection: class 5P
- Differential protection: class PX
- Zero-sequence protection: class 5P.

### Real power that the TC must provide in VA

This is the sum of the consumption of the cabling and that of each device connected to the TC secondary circuit.

Consumption of copper cabling (line losses of the cabling), knowing that:

$$P = R \times I^2 \quad \text{and} \quad R = \rho \times \frac{L}{S} \quad \text{then} \quad (VA) = k \times \frac{L}{S}$$

$k = 0.44$  if I<sub>sr</sub> = 5 A

$k = 0.0176$  if I<sub>sr</sub> = 1 A

L Length in metres of link conductors (feed/return)

S Cabling section in mm<sup>2</sup>

I<sub>ps</sub> Primary operating current in A

Indicative secondary cabling consumption

Cables (mm <sup>2</sup> )	Consumption (VA/m)	
	1A	5A
2.5	0.008	0.2
4	0.005	0.13
6	0.003	0.09
10	0.002	0.05

### Consumption of metering or protection devices

Consumptions of various devices are given in the manufacturer's technical data sheet.

Indicative metering consumptions

Device		Max. consumption in VA (per circuit)
Ammeter	Electromagnetic	3
	Electronic	1
Transducer	Self-powered	3
	External powered	1
Meter	Induction	2
	Electronic	1
	Wattmeter, varmeter	1

Indicative protection consumptions

Device	Max. consumption in VA (per circuit)
Static overcurrent relay	0.2 to 1
Electromagnetic overcurrent relay	1 to 8

#### Example:

- Cable section: 2.5 mm<sup>2</sup>
- Cable length feed/return): 5.8 m
- Consumed power by the cabling: 1 VA

# Current transformer

## Secondary circuit's characteristics according to IEC standards

### Rated output

Take the standardised value immediately above the real power that the CT must provide. The standardised values of rated output are: 2.5 - 5 - 10 - 15 VA.

### Instrument security factor (FS)

Protection of metering devices in the case of a fault is defined by the instrument security factor FS. The value of FS will be chosen according to the consumer's short-time withstand current:  $5 \leq FS \leq 10$ .

FS is the ratio between the limit of rated primary current ( $I_{pl}$ ) and the rated primary current ( $I_{pr}$ ).

$$F_s = \frac{I_{pl}}{I_{pr}}$$

$I_{pl}$  is the value of primary current for which the error in secondary current = 10%. A transducer is generally designed to withstand a short-time current of  $50 I_r$ , i.e. 250 A for a 5 A device. To be sure that this device will not be destroyed in the case of a primary fault, the current transformer must be saturated before  $50 I_r$  in the secondary. A safety factor of 10 is suitable.

In accordance with the standards, Schneider Electric CT's have a safety factor of 10. However, according to the current consumer characteristic a lower safety factor can be requested.

### Accuracy limit factor (ALF)

In protection applications, we have two constraints: having an accuracy limit factor and an accuracy class suited to the application.

We will determine the required ALF in the following manner:

- Definite time overcurrent protection  
The relay will function perfectly if:

$$\text{ALF real of CT} > 2 \times \frac{I_{re}}{I_{sr}}$$

$I_{re}$	Relay threshold setting
$I_{sr}$	Rated secondary current of the CT

For a relay with two setting thresholds, we will use the highest threshold

- for a transformer feeder, we will generally have an instantaneous high threshold set at  $14 I_r$  max., giving the real ALF required  $> 28$
- for a motor feeder, we will generally have a high threshold set to  $8 I_r$  max., giving a real ALF required  $> 16$ .

- Inverse definite time overcurrent protection

In all cases, refer to the relay manufacturer's technical datasheet.

For these protection devices, the CT must guarantee accuracy across the whole trip curve for the relay up to 10 times the setting current.

$$\text{ALF real} > 20 \times I_{re}$$

Special cases:

- if the maximum short-circuit current is greater than or equal to  $10 I_{re}$ :

$$\text{ALF real} > 2 \times \frac{I_{re}}{I_{sr}}$$

- if the maximum short-circuit current is less than  $10 I_{re}$ :

$$\text{ALF real} > 2 \times \frac{I_{sc \text{ secondary}}}{I_{sr}}$$

- if the protection device has an instantaneous high threshold that is used, (never true for feeders to other switchboards or for incomers):

$$\text{ALF real} > 2 \times \frac{I_{r2}}{I_{sr}}$$

$I_{r2}$	instantaneous high setting threshold for the module
----------	---

# Current transformer

## Differential protection

Many manufacturers of differential protection relays recommend class PX CT's. Class PX is often requested in the form of:

$$E_k \leq a \cdot I_f (R_{ct} + R_b + R_r)$$

The exact equation is given by the relay manufacturer.

Values characterising the CT

<b><math>E_k</math></b>	Knee-point voltage in volts
<b><math>a</math></b>	Asymmetry coefficient
<b><math>R_{ct}</math></b>	Max. resistance in the secondary winding in Ohms
<b><math>R_b</math></b>	Loop resistance (feed/return line) in Ohms
<b><math>R_r</math></b>	Resistance of relays not located in the differential part of the circuit in Ohms
<b><math>I_f</math></b>	Maximum fault current seen by the CT in the secondary circuit for a fault outside of the zone to be protected
	$I_f = \frac{I_{sc}}{K_n}$
<b><math>I_{sc}</math></b>	Primary short-circuit current
<b><math>K_n</math></b>	CT transformation ratio

### What values should $I_f$ be given to determine $E_k$ ?

The short-circuit current is chosen as a function of the application:

- generator set differential
- motor differential
- transformer differential
- bar differential.

- For a generator set differential:  
if  $I_{sc}$  is known:  $I_{sc}$  short-circuit current for the generator set on its own

$$I_f = \frac{I_{sc}}{K_n}$$

if the  $I_r$  gen is known: we will take

$$I_f = \frac{7 \times I_r \text{ gen}}{K_n}$$

if the  $I_r$  gen is unknown: we will take

$$I_f = 7 \times I_{sr} \text{ (CT)} \quad I_{sr} \text{ (CT)} = 1 \text{ or } 5A$$

- For a motor differential:  
if the start-up current is known: we will take

$$I_f = I_{sc} \text{ start-up} \quad I_f = \frac{I_{sc}}{K_n}$$

if the  $I_r$  motor is known: we will take

$$I_f = \frac{7 \times I_r}{K_n}$$

if the  $I_r$  motor is not known: we will take

$$I_f = 7 \times I_{sr} \text{ (CT)} \quad I_{sr} \text{ (CT)} = 1 \text{ or } 5A$$

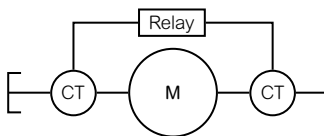
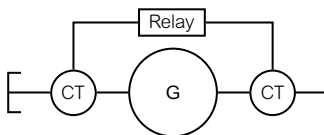



LPCT's (Low Power Current Transformers) meet IEC standard IEC 60044-8. These are current sensors with a direct voltage output which has the advantage of having a very wide range of applications, simplifying selection.

## LPCT low power current transformers

LPCT's are specific current sensors with a direct voltage output of the "Low Power Current Transformers" type, in conformity with standard IEC 60044-8. LPCT's provide metering and protection functions.

They are defined by:

- The rated primary current
- The extended primary current
- The accuracy limit primary current or the accuracy limit factor.

These have a linear response over a large current range and do not start to saturate until beyond the currents to be broken.

## Examples of LPCT ratings according to IEC standard 60044-8

These characteristics are summarized in the curves below.

They show the maximum error limits (as an absolute value) on the current and the phase corresponding to the accuracy class for the given examples.

Example for metering class 0.5

- Rated primary current  $I_{pn} = 100 \text{ A}$
- Extended primary current  $I_{pe} = 1250 \text{ A}$
- Secondary voltage  $V_{sn} = 22.5 \text{ mV}$  (for 100 A on the secondary)
- Class 0.5:
  - accuracy on:
    - the primary current module 0.5% (error  $\pm 0.5\%$ )
    - the primary current phase 60 min (error 30 minutes) over a range of 100 A to 1250 A
  - accuracy 0.75% and 45 min at 20 A
  - accuracy 1.5% and 90 min at 5 A.

which are two metering points specified by the standard.

Example for class 5P protection

- Primary current  $I_{pn} = 100 \text{ A}$
- Secondary voltage  $V_{sn} = 22.5 \text{ mV}$
- Class 5P:
  - accuracy on:
    - the primary current module 5% (error  $y \pm 5\%$ )
    - the primary current phase 60 min (error  $y$  60 minutes) on a range of 1.25 kA to 40 kA.

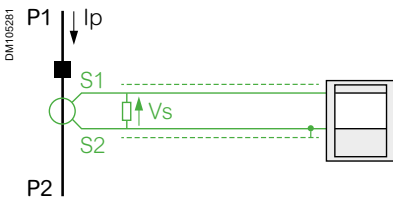

The LPCT and Sepam guarantee a very high coverage range and flexibility of usage. Example: protection system with CLP1 or CLP2 and Sepam guaranteeing a usage range of 5 A to 1250 A

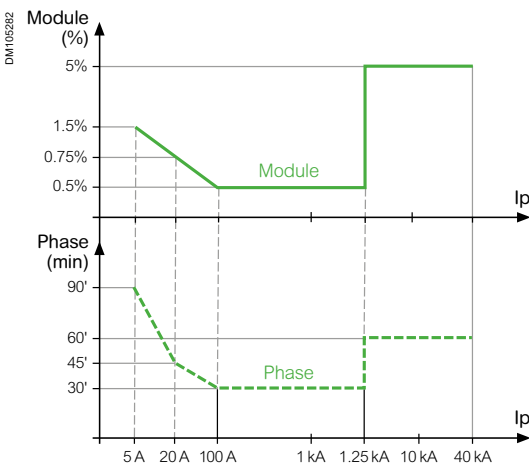

Accuracy characteristics of a LPCT (example of Schneider Electric's CLP1): the accuracy classes are given for extended current ranges (here class 0.5 for metering from 100 to 1250 A and protection class 5P from 1.25 to 40 kA).

# Voltage transformer

## Characteristics

We can leave a voltage transformer in an open circuit without any danger but it must never be short-circuited.

The voltage transformer is intended to provide the secondary circuit with a secondary voltage that is proportional to that applied to the primary circuit. N.B.: IEC standard 61869-3 defines the conditions which voltage transformers must meet.

It comprises a primary winding, a magnetic core, one or several secondary windings, all of which is encapsulated in an insulating resin.

### Characteristics

#### The rated voltage factor (VF)

The rated voltage factor is the factor by which the rated primary voltage has to be multiplied in order to determine the maximum voltage for which the transformer must comply with the specified temperature rise and accuracy recommendations.

According to the network's earthing arrangement, the voltage transformer must be able to withstand this maximum voltage for the time that is required to eliminate the fault.

Normal values of the rated voltage factor		
Rated voltage factor	Rated duration	Primary winding connection mode and network earthing arrangement
1.2	Continuous	Phase to phase on any network, Neutral point to earth for star connected transformers in any network
1.2 1.5	Continuous 30s	Phase to earth in an earthed neutral network
1.2 1.9	Continuous 30s	Phase to earth in a network without an earthed neutral with automatic elimination of earthing faults
1.2 1.9	Continuous 8h	Phase to earth in an isolated neutral network without automatic elimination of earthing faults, or in a compensated network with an extinction coil without automatic elimination of the earthing fault

N.B.: lower rated durations are possible when agreed to by the manufacturer and the user.

Generally, voltage transformer manufacturers comply with the following values: VT phase/earth 1.9 for 8 h and VT phase/phase 1.2 continuous.

#### Rated primary voltage (U<sub>pr</sub>)

According to their design, voltage transformers will be connected:

- Either phase to earth

$$\frac{3000V}{\sqrt{3}} / \frac{100V}{\sqrt{3}} \quad U_{pr} = \frac{U}{\sqrt{3}}$$

- or phase to phase

$$3000V / 100V \quad U_{pr} = U$$

# Voltage transformer

## Characteristics

### Rated secondary voltage (U<sub>sr</sub>)

- For phase to phase VT the rated secondary voltage is 100 or 110 V (EU).
- For single phase transformers intended to be connected in a phase to earth arrangement, the rated secondary voltage must be divided by  $\sqrt{3}$ .

E.g: 
$$: \frac{100}{\sqrt{3}}$$

Standard values for single-phase transformers in single-phase systems or connected line-to-line in three-phase systems and for three-phase transformers

#### Standard values for single-phase transformers in single-phase systems or connected line-to-line in three-phase systems and for three-phase transformers

Application	Europe U <sub>sr</sub> (V)	United States & Canada. U <sub>sr</sub> (V)
Distribution systems	100 & 110	120
Transmission systems	100 & 110	115
Extended secondary circuits	200	230

### Rated output

Expressed in VA, this is the apparent power that a voltage transformer can provide the secondary circuit when connected at its rated primary voltage and connected to the nominal load. It must not introduce any error exceeding the values guaranteed by the accuracy class ( $S = \sqrt{3} \times U \times I$  in three-phase circuits). Standardised values are: 10 - 15 - 25 - 30 - 50 - 75 - 100 VA.

### Accuracy class

This defines the limits of errors guaranteed in terms of transformation ratio and phase under the specified conditions of both power and voltage.

Measurement according to IEC 61869-3

Classes 0.5 and 1 are suitable for most cases, class 3 is very little used.

Application	Accuracy class	Phase displacement in min
Not used industrially	0.1	5
Precise metering	0.2	10
Everyday metering	0.5	20
Statistical and/or instrument metering	1	40
Metering not requiring great accuracy	3	Not Specified

# Voltage transformer

## Characteristics

### Protection according to IEC 61869-3

Classes 3P and 6P exist but in practice only class 3P is used.

The accuracy class is guaranteed for values:

- of voltage of between 5% of the primary voltage and the maximum value of this voltage which is the product of the primary voltage and the rated voltage factor ( $kT \times U_{pr}$ )
- for a secondary load of between 25% and 100% of the rated output with a power factor of 0.8 inductive.

Accuracy class	Voltage error as $\pm$ %		Phase displacement in minutes	
	Between 5% $U_{pr}$ and $kT \cdot U_{pr}$	Between 2% and 5% $U_{pr}$	Between 5% $U_{pr}$ and $kT \cdot U_{pr}$	Between 2% and 5% $U_{pr}$
3P	3	6	120	240
6P	6	12	240	480

*Phase displacement = see explanation next page*

$U_{pr}$  rated primary voltage

$kT$  voltage factor

### Rated transformation ratio ( $k_r$ )

$$k_r = \frac{U_{pr}}{U_{sr}} = \frac{N_1}{N_2} \quad \text{for a VT}$$

### Voltage ratio error ( $\epsilon$ )

$$\epsilon = \frac{k_r \times U_s - U_p}{U_p} \times 100$$

$k_r$  is the rated transformation ratio

$U_p$  is the actual primary voltage

$U_s$  is the actual secondary voltage when  $U_p$  is applied under the conditions of measurement

### Phase displacement or phase error ( $\epsilon$ )

For sinusoidal voltages, this is the difference in phase between the primary voltage ( $U_{pr}$ ) and the secondary voltage ( $U_{sr}$ ) phasors, the direction of the phasors being so chosen that the angle is zero for an ideal transformer.

It is expressed in minutes or centiradians of angle.

# Voltage transformer

## Characteristics

### Rated thermal limiting output (cf. § 6.4 IEC 61869-1 and IEC 61869-2)

This is the value of the apparent power at rated voltage which can be taken from a secondary winding without exceeding the limits of temperature rise set by the standards.

The rated thermal limiting output shall be specified in voltamperes; the standard values are: 25 - 50 - 100 VA and their decimal multiples, related to the rated secondary voltage with unity power factor.

Part of instrument transformers	Temperature $\theta$ (°C)	$(\theta - \theta_n)$ with $\theta_n = 40^\circ\text{C}$ (K)
<b>Contacts (Refer to point 4)</b>		
Oil-immersed instrument transformers		
top oil	90	50
top oil, hermetically sealed	95	55
winding average	100	60
winding average, hermetically sealed	105	65
other metallic parts in contact with oil	As for winding	As for winding
Solid or gas insulated instrument transformers		
winding (average) in contact with insulating materials of the following classes <sup>(1)</sup> :		
Y	85	45
A	100	60
E	115	75
B	125	85
F	150	110
H	175	135
other metallic parts in contact with the above insulating material classes	As for winding	As for winding
<b>Connection bolted or the equivalent</b>		
Bare-copper or bare copper alloy or bare-aluminium alloy		
In air	90	50
In SF6	115	75
In oil	100	60
Silver-coated or nickel coated		
In air	115	75
In SF6	115	75
In oil	100	60
Tin-coated		
In air	105	65
In SF6	105	65
In oil	100	60

(1) Insulating class definitions according to IEC 60085.

The temperature rise of a voltage transformer at the specified voltage, at rated frequency and at rated burden, or at the highest rated burden if there are several rated burdens, at any power factor between 0,8 lagging and unity, shall not exceed the appropriate value given in previous from Table of IEC 61869-1:2007.

When the transformer is fitted with a conservator tank or has an inert gas above the oil, or is hermetically sealed the temperature rise of the oil at the top of the tank or housing shall not exceed 55 K.

When the transformer is not so fitted or arranged, the temperature rise of the oil at the top of the tank or housing shall not exceed 50 K.

# LPVT: electronic voltage transformers

LPVT (Low Power Voltage Transformers) meet IEC standard IEC 60044-7. They are voltage sensors with a direct low voltage output. LPVT are smaller and easier to integrate in MV cubicle than standard VT.

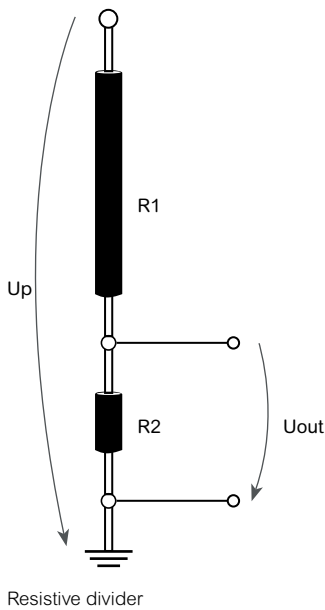

## LPVT Low Power Voltage Transformers

LPVT are specific voltage sensors with a direct voltage output of the “Low Power Voltage Transformers” type, in conformity with standard IEC 60044-7. LPVT provide metering and protection functions.

They are defined by:

- The rated primary voltage, usual value of IEC 60038
- The rated secondary voltage
  - 1,625 – 2 – 3,25 – 4 – 6,5 V line to line
  - 1,625/ $\sqrt{3}$  – 2/ $\sqrt{3}$  – 3,25/ $\sqrt{3}$  – 4/ $\sqrt{3}$  – 6,5/ $\sqrt{3}$  V line to earth
  - 1,625/3 – 2/3 – 3,25/3 – 4/3 – 6,5/3V for three phase networks
  - 1,625/2 – 2/2 – 3,25/2 – 4/2 – 6,5/2 for two phase networks

## Examples of LPVT ratings according to IEC standard 60044-7

Characteristics given below are an example of a LPVT which applies for a large range of primary voltage.

### Example for metering class 0.5

- Rated primary voltage  $U_{pn}$ : from 3/ $\sqrt{3}$  kV to 22/ $\sqrt{3}$  kV
- Rated secondary voltage  $U_{sn}$ : 3.25/ $\sqrt{3}$  V at 20/ $\sqrt{3}$  kV
- Class 0.5:
  - accuracy on:
    - the primary voltage module 0.5% (error  $\pm 0.5\%$ )
    - the primary voltage phase 20 min (error  $\pm 20$  minutes) over a range of 80% to 120% of  $U_{pn}$  (from 0.8\*3/ $\sqrt{3}$  kV to 1.2\*20/ $\sqrt{3}$  kV)

### Example for class 3P protection

- Rated primary voltage  $U_{pn}$ : from 3/ $\sqrt{3}$  kV to 20/ $\sqrt{3}$  kV
- Rated secondary voltage  $U_{sn}$ : 3.25/ $\sqrt{3}$  V at 20/ $\sqrt{3}$  kV
- Class 3P:
  - accuracy on:
    - the primary voltage module 3% (error  $\pm 3\%$ )
    - the primary voltage phase 120 min (error  $\pm 120$  minutes) over a range of 5% to 190% of  $U_{pn}$  (from 0.05\*3/ $\sqrt{3}$  kV to 1.9\*22/ $\sqrt{3}$  kV)

# Derating

## Insulation derating according to altitude Derating of the rated current according to temperature

**Example of application:**

Can equipment with a rated voltage of 24 kV be installed at 2500 metres?

The impulse withstand voltage required is 125 kV.

The power frequency withstand 50 Hz is 50 kV 1 min.

For 2500 m

- k is equal to 0.85
- the impulse withstand must be:  $125/0.85 = 147.05$  kV
- the power frequency withstand 50 Hz must be:  $50/0.85 = 58.8$  kV

No, the equipment that must be installed is:

- rated voltage = 36 kV
- impulse withstand = 170 kV
- withstand at 50 Hz = 70 kV

N.B.: In some cases, 24 kV equipment may be used if appropriate test reports proving the compliance with the request are available.

The various standards or recommendations impose validity limits on product characteristics. Normal conditions of use are described in the "Medium voltage circuit breaker" chapter.

Beyond these limits, it is necessary to reduce certain values, in other words to derate the device. Derating has to be considered:

- in terms of the insulation level, for altitudes over 1000 metres
- in terms of the rated current, when the ambient temperature exceeds 40°C and for a protection index over IP3X, (see chapter on "Protection index").

These different types of derating can be cumulated if necessary.

N.B.: there are no standards specifically dealing with derating. However, table 3 of IEC 62271-1 deals with temperature rises and gives limit temperature values not to be exceeded according to the type of device, the materials and the dielectric used.

### Insulation derating according to altitude

Standards give a derating for all equipment installed at an altitude greater than 1000 metres. As a general rule, we have to derate by 1.25% U peak every 100 metres above 1000 metres. This applies for the lightning impulse withstand voltage and the power frequency withstand voltage 50 Hz - 1 min.

Altitude has no effect on the dielectric withstand of circuit breakers in SF6 or vacuum, because they are within a sealed enclosure.

Derating, however, must be taken into account when the circuit breaker is installed in cubicles. In this case, external insulation is in air.

Schneider Electric uses correction coefficients:

- for circuit breakers outside of a cubicle, use the graph below
- for circuit breakers in a cubicle, refer to the cubicle selection guide (derating depends on the cubicle design).

Exception of some markets where derating starts from zero metres (cf. dotted line on the graph below) or where standard defines factors as the IEEE C37.20.9 (cf following table).

Altitude (m)	Voltage factor	Current factor
1000 m (3300 ft) and below	1.00	1.00
1500 m (5000 ft)	0.95	0.99
3000 m (10 000 ft)	0.80	0.96

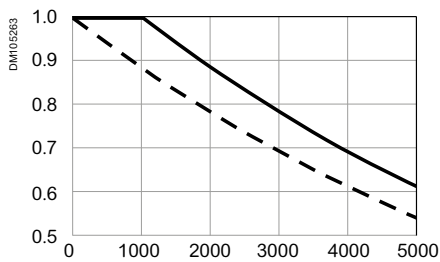

Correction coefficient k

### Derating of the rated current according to temperature

IEC standard 62271-1 table 3 defines the maximum permissible temperature rise for each device, material and dielectric medium with a reference ambient temperature of 40°C.

As a general rule, derating is of 1% for every 100 m in excess of 2 000 m in altitude of the site of the installation. This correction is generally unnecessary because the higher temperature rise at altitude due to the reduced cooling effect of the air is compensated by the reduced maximum ambient temperature at altitude as mentioned here after as defined by IEC 60943 standard:

Altitude (m)	Maximum ambient air temperature (°C)
0 -2000	40
2000-3000	30
3000-4000	25

In fact, this temperature rise depends on three parameters:

- the rated current
- the ambient temperature
- the cubicle type and its IP (protection index).

Derating will be carried out according to the cubicle selection tables, because conductors outside of the circuit breakers act to radiate and dissipate calories.

# Units of measure



---

<b>Names and symbols of SI units of measure</b>	<b>p. 122</b>
Basic units	p. 122
Common magnitudes and units	p. 123
Correspondence between imperial units and international system units (SI)	p. 125

---

# Names and symbols of SI units of measure

## Basic units

Magnitude	Symbol of the magnitude <sup>(1)</sup>	Unit	Symbol of the unit	Dimension
<b>Basic units</b>				
Length	l, (L)	Metre	m	L
Mass	m	Kilogramme	kg	M
Time	t	Second	s	T
Electrical current	I	Ampere	A	I
Thermodynamic temperature <sup>(2)</sup>	T	Kelvin	K	Q
Quantity of material	n	Mole	mol	N
Light intensity	I, (Iv)	Candela	cd	J
<b>Additional units</b>				
Angle (plane angle)	$\alpha, \beta, \gamma \dots$	Radian	rad	A
Solid angle	$\Omega, (\omega)$	Steradian	sr	W

(1) The symbol in brackets can also be used

(2) The temperature Celsius  $t$  is related to the thermodynamic temperature  $T$  by the relationship:  
 $t = T - 273.15$

# Names and symbols of SI units of measure

## Common magnitudes and units

Name	Symbol	Dimension	SI Unit: name (symbol)	Comments and other units
<b>Magnitude: space and time</b>				
Length	l, (L)	L	Metre (m)	Centimetre (cm): 1 cm = 10 <sup>-2</sup> m (microns must no longer be used, instead the micrometre (µm))
Area	A, (S)	L <sup>2</sup>	Metre squared (m <sup>2</sup> )	Are (a): 1 a = 10 <sup>2</sup> m <sup>2</sup> Hectare (ha): 1 ha = 10 <sup>4</sup> m <sup>2</sup> (agriculture measure)
Volume	V	L <sup>3</sup>	Metre cubed (m <sup>3</sup> )	
Plane angle	α, β, γ ...	N/A	Radian (rad)	Gradian (gr): 1 gr = 2π rad/400 Revolution (rev): 1 tr = 2π rad Degree (°): 1° = 2π rad/360 = 0.017 453 3 rad Minute ('): 1' = 2π rad/21600 = 2.908 882 • 10 <sup>-4</sup> rad Second ("): 1" = 2π rad/1296 000 = 4.848 137 • 10 <sup>-6</sup> rad
Solid angle	Ω, (ω)	N/A	Steradian (sr)	
Time	t	T	Second (s)	Minute (min) Hour (h) Day (d)
Speed	v	L T <sup>-1</sup>	Metre per second (m/s)	Revolutions per second (rev/s): 1 tr/s = 2π rad/s
Acceleration	a	L T <sup>-2</sup>	Metre per second squared (m/s <sup>2</sup> )	Acceleration due to gravity: g = 9.80665 m/s <sup>2</sup>
Angular speed	ω	T <sup>-1</sup>	Radian per second (rad/s)	
Angular acceleration	α	T <sup>-2</sup>	Radian per second squared (rad/s <sup>2</sup> )	
<b>Magnitude: mass</b>				
Mass	m	M	Kilogramme (kg)	Gramme (g): 1 g = 10 <sup>-3</sup> kg Ton (t): 1 t = 10 <sup>3</sup> kg
Linear mass	ρ <sup>l</sup>	L <sup>-1</sup> M	Kilogramme per metre (kg/m)	
Mass per surface area	ρ <sup>A</sup> (ps)	L <sup>-2</sup> M	Kilogramme per metre squared (kg/m <sup>2</sup> )	
Mass per volume	ρ	L <sup>-3</sup> M	Kilogramme per metre cubed (kg/m <sup>3</sup> )	
Volume per mass	v	L <sup>3</sup> M <sup>-1</sup>	Metre cubed per kilogramme (m <sup>3</sup> /kg)	
Concentration	ρ <sup>B</sup>	M L <sup>-3</sup>	Kilogramme per metre cubed (kg/m <sup>3</sup> )	Concentration by mass of component B (according to NF X 02-208)
Density	d	N/A	N/A	d = ρ/p water
<b>Magnitude: periodic phenomena</b>				
Period	T	T	Second (s)	
Frequency	f	T <sup>-1</sup>	Hertz (Hz)	1 Hz = 1s <sup>-1</sup> , f = 1/T
Phase shift	φ	N/A	Radian (rad)	
Wavelength	λ	L	Metre (m)	Use of the angström (10 <sup>-10</sup> m) is forbidden. Use of a factor of nanometre (10 <sup>-9</sup> m) is recommended λ = c/f = cT (c = celerity of light)
Power level	Lp	N/A	Decibel (dB)	

# Names and symbols of SI units of measure

## Common magnitudes and units

Name	Symbol	Dimension	SI Unit: name (symbol)	Comments and other units
<b>Magnitude: mechanical</b>				
Force	F	$L M T^{-2}$	Newton	$1 N = 1 m \times kg/s^2$
Weight	G, (P, W)			
Moment of the force	M, T	$L^2 M T^{-2}$	Newton-metre (N.m)	N.m and not m.N to avoid any confusion
Surface tension	$\gamma, \sigma$	$M T^{-2}$	Newton per metre (N/m)	$1 N/m = 1 J/m^2$
Work	W	$L^2 M T^{-2}$	Joule (J)	$1 J: 1 N m = 1 W s$
Energy	E	$L^2 M T^{-2}$	Joule (J)	Watt-hour (Wh): $1 Wh = 3.6 \times 10^3 J$ (used in determining electrical consumption)
Power	P	$L^2 M T^{-3}$	Watt (W)	$1 W = 1 J/s$
Pressure	$\sigma, \tau, p$	$L^{-1} M T^{-2}$	Pascal (Pa)	$1 P = 10^{-1} Pa.s$ (P = poise, CGS unit)
Dynamic viscosity	$\eta, \mu$	$L^{-1} M T^{-1}$	Pascal-second (Pa.s)	$1 P = 10^{-1} Pa.s$ (P = poise, CGS unit)
Kinetic viscosity	$\nu$	$L^2 T^{-1}$	Metre squared per second (m <sup>2</sup> /s)	$1 St = 10^{-4} m^2/s$ (St = stokes, CGS unit)
Quantity of movement	p	$L M T^{-1}$	Kilogramme-metre per second (kg x m/s)	$p = mv$
<b>Magnitude: electricity</b>				
Current	I	I	Ampere (A)	
Electrical charge	Q	TI	Coulomb (C)	$1 C = 1 A.s$
Electrical potential	V	$L^2 M T^{-3} I^{-1}$	Volt (V)	$1 V = 1 W/A$
Electrical field	E	$L M T^{-3} I^{-1}$	Volt per metre (V/m)	
Electrical resistance	R	$L^2 M T^{-3} I^{-2}$	Ohm ( $\Omega$ )	$1 \Omega = 1 V/A$
Electrical conductivity	G	$L^{-2} M^{-1} T^3 I^2$	Siemens (S)	$1 S = 1 A/V = 1 \Omega^{-1}$
Electrical capacitance	C	$L^{-2} M^{-1} T^4 I^2$	Farad (F)	$1 F = 1 C/V$
Electrical inductance	L	$L^2 M T^{-2} I^{-2}$	Henry (H)	$1 H = 1 Wb/A$
<b>Magnitude: electricity, magnetism</b>				
Magnetic induction	B	$M T^{-2} I^{-1}$	Tesla (T)	$1 T = 1 Wb/m^2$
Magnetic induction flux	$\Phi$	$L^2 M T^{-2} I^{-1}$	Weber (Wb)	$1 Wb = 1 V.s$
Magnetisation	$H_i, M$	$L^{-1} I$	Ampere per metre (A/m)	
Magnetic field	H	$L^{-1} I$	Ampere per metre (A/m)	
Magneto-motive force	F, Fm	I	Ampere (A)	
Resistivity	$\rho$	$L^3 M T^{-3} I^{-2}$	Ohm-metre ( $\Omega.m$ )	$1 \mu\Omega.cm^2/cm = 10^{-8} \Omega.m$
Conductivity	$\gamma$	$L^{-3} M^{-1} T^3 I^2$	Siemens per metre (S/m)	
Permittivity	$\epsilon$	$L^{-3} M^{-1} T^4 I^2$	Farad per metre (F/m)	
Active power	P	$L^2 M T^{-3}$	Watt (W)	$1 W = 1 J/s$
Apparent power	S	$L^2 M T^{-3}$	Voltampere (VA)	
Reactive power	Q	$L^2 M T^{-3}$	var (var)	
<b>Magnitude: electricity, magnetism</b>				
Thermodynamic temperature	T	$\theta$	Kelvin (K)	Kelvin and not degree Kelvin or °Kelvin
Temperature Celsius	t, $\theta$	$\theta$	Degree Celsius (°C)	$t = T - 273.15$
Energy	E	$L^2 M T^{-2}$	Joule (J)	
Heat capacity	C	$L^2 M T^{-2} \theta^{-1}$	Joule per Kelvin (J/K)	
Entropy	S	$L^2 M T^{-2} \theta^{-1}$	Joule per Kelvin (J/K)	
Specific heat capacity	c	$L^2 T^{-2} \theta^{-1}$	Watt per kilogramme-Kelvin (J/(kg.K))	
Thermal conductivity	$\lambda$	$L M T^{-3} \theta^{-1}$	Watt per metre-Kelvin (W/(m.K))	
Quantity of heat	Q	$L^2 M T^{-2}$	Joule (J)	
Thermal flux	$\Phi$	$L^2 M T^{-3}$	Watt (W)	$1 W = 1 J/s$
Thermal power	P	$L^2 M T^{-3}$	Watt (W)	
Coefficient of thermal radiation	$h_r$	$M T^{-3} \theta^{-1}$	Watt per metre squared-Kelvin (W/(m <sup>2</sup> x K))	

# Names and symbols of SI units of measure - Correspondence between imperial units and international system units (SI)

Name	SI Unit: name (symbol)	SI Unit: name (symbol)	SI Unit: name (symbol)
Acceleration	Foot per second squared	ft/s <sup>2</sup>	1 ft/s <sup>2</sup> = 0.304 8 m/s <sup>2</sup>
Calory capacity	British thermal unit per pound	Btu/lb	1 Btu/lb = 2.326 x 10 <sup>3</sup> J/kg
Heat capacity	British thermal unit per cubic foot.degree Fahrenheit	Btu/ft <sup>3</sup> .°F	1 Btu/ft <sup>3</sup> .°F = 67.066 1 x 10 <sup>3</sup> J/m <sup>3</sup> .°C
	British thermal unit per (pound.degree Fahrenheit)	Btu/lb.°F	1 Btu/lb.°F = 4.186 8 x 10 <sup>3</sup> J/(kg.°C)
Magnetic field	Oersted	Oe	1 Oe = 79.577 47 A/m
Thermal conductivity	British thermal unit per square foot.hour.degree Fahrenheit	Btu/ft <sup>2</sup> .h.°F	1 Btu/ft <sup>2</sup> .h.°F = 5.678 26 W/(m <sup>2</sup> .°C)
Energy	British thermal unit	Btu	1 Btu = 1.055 056 x 10 <sup>3</sup> J
Energy (couple)	Pound force-foot	lbf.ft	1 lbf.ft = 1.355 818 J
	Pound force-inch	lbf.in	1 lbf.in = 0.112 985 J
Thermal flux	British thermal unit per square foot.hour	Btu/ft <sup>2</sup> .h	1 Btu/ft <sup>2</sup> .h = 3.154 6 W/m <sup>2</sup>
	British thermal unit per second	Btu/s	1 Btu/s = 1.055 06 x 10 <sup>3</sup> W
Force	Pound-force	lbf	1 lbf = 4.448 222 N
Length	Foot	ft, '	1 ft = 0.304 8 m
	Inch <sup>(1)</sup>	in, "	1 in = 25.4 mm
	Mile (UK)	mile	1 mile = 1.609 344 km
	Knot	-	1 852 m
	Yard <sup>(2)</sup>	yd	1 yd = 0.914 4 m
Mass	Once (ounce)	oz	1 oz = 28.349 5 g
	Pound (livre)	lb	1 lb = 0.453 592 37 kg
Linear mass	Pound per foot	lb/ft	1 lb/ft = 1.488 16 kg/m
	Pound per inch	lb/in	1 lb/in = 17.858 kg/m
Mass per surface area	Pound per square foot	lb/ft <sup>2</sup>	1 lb/ft <sup>2</sup> = 4.882 43 kg/m <sup>2</sup>
	Pound per square inch	lb/in <sup>2</sup>	1 lb/in <sup>2</sup> = 703.069 6 kg/m <sup>2</sup>
Mass per volume	Pound per cubic foot	lb/ft <sup>3</sup>	1 lb/ft <sup>3</sup> = 16.018 46 kg/m <sup>3</sup>
	Pound per cubic inch	lb/in <sup>3</sup>	1 lb/in <sup>3</sup> = 27.679 9 x 10 <sup>3</sup> kg/m <sup>3</sup>
Moment of inertia	Pound square foot	lb.ft <sup>2</sup>	1 lb.ft <sup>2</sup> = 42.140 gm <sup>2</sup>
Pressure	Foot of water	ft H <sub>2</sub> O	1 ft H <sub>2</sub> O = 2.989 07 x 10 <sup>3</sup> Pa
	Inch of water	in H <sub>2</sub> O	1 in H <sub>2</sub> O = 2.490 89 x 10 <sup>2</sup> Pa
Pressure - stress	Pound force per square foot	lbf/ft <sup>2</sup>	1 lbf/ft <sup>2</sup> = 47.880 26 Pa
	Pound force per square inch <sup>(3)</sup>	lbf/in <sup>2</sup> (psi)	1 lbf/in <sup>2</sup> = 6.894 76 • 10 <sup>3</sup> Pa
Calorific power	British thermal unit per hour	Btu/h	1 Btu/h = 0.293 071 W
Surface area	Square foot	sq.ft, ft <sup>2</sup>	1 sq.ft = 9.290 3 x 10 <sup>-2</sup> m <sup>2</sup>
	Square inch	sq.in, in <sup>2</sup>	1 sq.in = 6.451 6 x 10 <sup>-4</sup> m <sup>2</sup>
Temperature	Degree Fahrenheit <sup>(4)</sup>	°F	TK = 5/9 (q °F + 459.67)
	Degree Rankine <sup>(5)</sup>	°R	TK = 5/9 q °R
Viscosity	Pound force-second per square foot	lbf.s/ft <sup>2</sup>	1 lbf.s/ft <sup>2</sup> = 47.880 26 Pa.s
	Pound per foot-second	lb/ft.s	1 lb/ft.s = 1.488 164 Pa.s
Volume	Cubic foot	cu.ft	1 cu.ft = 1 ft <sup>3</sup> = 28.316 dm <sup>3</sup>
	Cubic inch	cu.in, in <sup>3</sup>	1 in <sup>3</sup> = 1.638 71 x 10 <sup>-5</sup> m <sup>3</sup>
	Fluid ounce (UK)	fl oz (UK)	fl oz (UK) = 28.413 0 cm <sup>3</sup>
	Fluid ounce (US)	fl oz (US)	fl oz (US) = 29.573 5 cm <sup>3</sup>
	Gallon (UK)	gal (UK)	1 gaz (UK) = 4.546 09 dm <sup>3</sup>
Force	Gallon (US)	gal (US)	1 gaz (US) = 3.785 41 dm <sup>3</sup>

(1) 12 in = 1 ft

(2) 1 yd = 36 in = 3 ft

(3) Or p.s.i.: pound force per square inch

(4) T<sub>k</sub> = temperature kelvin with q°C = 5/9 (q°F - 32)

(5) °R = 5/9 °K

# Standards

---

<b>The standards mentioned in this document</b>	<b>p. 128</b>
<hr/>	
<b>IEC - ANSI/IEEE comparison</b>	<b>p. 130</b>
IEC - ANSI/IEEE harmonization process	p. 130
IEC - ANSI major discrepancies	p. 131

---

# The standards mentioned in this document

## Where can you order IEC publications?

IEC central office  
3, rue de Varembe  
CH - 1211 Geneva 20 Switzerland  
[www.iec.ch](http://www.iec.ch)

LPCT Electronic current transformer	IEC 60044-8
High voltage test techniques General definitions and test requirements	IEC 60060-1
Insulation coordination: Application guide	IEC 60071-2
Power transformers - Part 11: dry-type transformers	IEC 60076-11
Power transformers - Part 12: loading guide for dry-type power transformers	IEC 60076-12
Power transformers - Part 13: self-protected liquid-filled transformers	IEC 60076-13
Power transformers - Part 15: gas-filled power transformers	IEC 60076-15
Power transformers - Part 16: transformers for wind turbines application	IEC 60076-16
Power transformers - Part 6: reactors	IEC 60076-6
Power transformers - Part 7: loading guide for oil-immersed power transformers	IEC 60076-7
High-voltage fuses - Part 1 : current-limiting fuses	IEC 60282
Railway applications - Traction transformers and inductors on board rolling stock	IEC 60310
Degrees of protection provided by enclosures	IEC 60529
Classification of environmental conditions - Part 3-3: classification of groups of environmental parameters and their severities - Stationary use at weather protected locations	IEC 60721-3-3
Classification of environmental conditions. Part 3: classification of groups of environmental parameters and their severities. Section 4 : stationary use at non-weather-protected locations-protected locations	IEC 60721-3-4
Short-circuit currents in three-phase AC systems calculation of currents	IEC 60909-0
Converter transformers - Part 1: transformers for industrial applications	IEC 61378-1
Converter transformers - Part 2: transformers for HVDC applications	IEC 61378-2
Instrument transformers - Part 1: general requirements	IEC 61869-1
Current transformers	IEC 61869-2
Inductive voltage transformers	IEC 61869-3
Power installations exceeding 1 kV a.c. - Part 1: common rules	IEC 61936-1
Degrees of protection provided by enclosures for electrical equipment against external mechanical impacts (IK code)	IEC 62262
High-voltage switchgear and controlgear - Part 1: Common specifications	IEC 62271-1
Alternating current circuit breakers	IEC 62271-100
High-voltage switchgear and controlgear - Part 102: alternating current disconnectors and earthing switches	IEC 62271-102
High-voltage switchgear and controlgear - Part 103: switches for rated voltages above 1 kV up to and including 52 kV	IEC 62271-103
Inductive load switching	IEC 62271-110



# The standards mentioned in this document

Environmentally conscious design for electrical and electronic products	IEC 62430
Material declaration for products of and for the electrotechnical industry	IEC 62474
AC metal-enclosed switchgear and controlgear for rated voltages above 1 kV and up to and including 52 kV	IEC 62271-200
High-voltage switchgear and controlgear - Part 202 : high-voltage/low-voltage prefabricated substation	IEC 62271-202
High-voltage switchgear and controlgear - Part 306 : guide to IEC 62271-100, IEC 62271-1 and other IEC standards related to alternating current circuit-breakers	IEC/TR 62271-306
Guidance for evaluation of products with respect to substance-use restrictions in electrical and electronic products	IEC/TR 62476
Guidelines for end-of-life information provided by manufacturers and recyclers and for recyclability rate calculation of electrical and electronic equipment	IEC/TR 62635
Tutorial and application guide for high-voltage fuses	IEC/TR 62655
High-voltage switchgear and controlgear - Part 304: design classes for indoor enclosed switchgear and controlgear for rated voltages above 1 kV up to and including 52 kV to be used in severe climatic conditions	IEC/TS 62271-304
Selection and dimensioning of high-voltage insulators intended for use in polluted conditions - Part 1: Definitions, information and general principles	IEC/TS 60815-1
IEEE Standard Test Procedure for AC High-Voltage Circuit Breakers Rated on a Symmetrical Current Basis	IEEE C37.09
IEEE Standard of Common Requirements for High Voltage Power Switchgear Rated Above 1000 V	IEEE C37.100.1
IEEE Standard for Metal-Clad Switchgear	IEEE C37.20.2
IEEE Standard for Metal-Enclosed Interrupter Switchgear (1 kV–38 kV)	IEEE C37.20.3
Environmental labels and declarations - Type III environmental declarations - Principles and procedures	ISO 14025
Corrosion of metals and alloys - Corrosivity of atmospheres - Classification, determination and estimation	ISO 9223
Enclosures for Electrical Equipment (1000 Volts Maximum)	NEMA 250
Standard for Electrical Safety in the Workplace®	NFPA 70 E

# IEC - ANSI/IEEE comparison

## IEC - ANSI/IEEE harmonization process

Basically, the differences between IEC and ANSI/IEEE standards come from their respective philosophies.

IEC standards are based on a functional approach. Devices are defined by their performances and this allows for various technological solutions.

ANSI/IEEE standards were based on the description of technological solutions. These solutions are used by the legal system as “minimum safety and functional requirements”.

A few years ago, IEC and ANSI/IEEE organizations began a harmonization process on some topics. This is now supported by an agreement on joint IEC – IEEE development project, established in 2008. Due to the process of harmonization, the standards are today in a transition phase.

This harmonization allows simplifying the standard on places where the “minor” differences exist. This is specifically true for the definitions of short circuit current and transient recovery voltages.

ANSI/IEEE has developed standards for special applications such as for instance “Auto-reclosers” and “Generator Circuit-breakers”. These documents will be transformed into equivalent IEC standards after harmonization of definitions and ratings. Harmonization should not be understood as Unification. IEC and IEEE are by nature very different organisations. The structure of the former is based on National Committees, whereas the latter is based on Individuals. Therefore, IEC and ANSI/IEEE will keep their own revised harmonized standards also in the future. Physically different network characteristics (overhead lines or cable networks, in- or out-door application) and local habits (voltage ratings and frequencies) will continue to impose their constraints on the switchgear equipment.

### Rated voltages

See clause 3.1

### TRV Harmonization

One of the main purpose was to define common switching and breaking tests in both IEC and ANSI/IEEE standards.

Since 1995, three main actions have been undertaken:

- Harmonization of TRVs for breaking tests of circuit breakers rated 100 kV and higher,
- Harmonization of TRVs for breaking tests of circuit breakers rated less than 100 kV.
- Harmonization of ratings and test requirements for capacitive current switching.

IEC introduced 2 classes of circuit breakers, defined by 2 TRV characteristics in IEC 62271-100 (2007): ANSI/IEEE is using the same classes in C37.06 (2009) standard.

- S1 for cable-systems
- S2 for line-systems,

As some S2 breakers of voltages below 52 kV may be directly connected to an overhead line, they have to pass a short line fault breaking test.

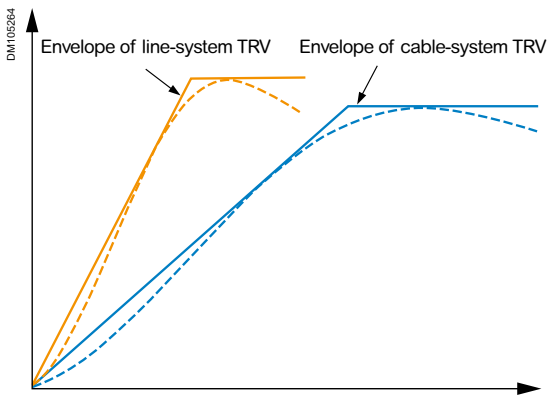

### Classes of circuit breakers

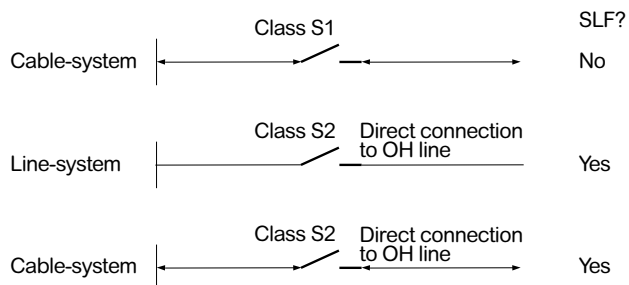

# IEC - ANSI/IEEE comparison

## IEC - ANSI/IEEE harmonization process

---

### Capacitive switching

Capacitive switching tests are also harmonized.

Class C1 of circuit breakers with low probability of restrikes and a new class C2 of circuit breakers with very low probability of restrike were introduced. The rated values and acceptance criteria still remain different for the two standards. IEEE will have a C0 classification.

### Assembled product

There is no harmonization for assembled products.

Assembled products include metal-enclosed or insulation enclosed MV switchgear or Gas insulated switchgear. Today, no coordinated action exists to harmonize the assembly standards in IEC and IEEE/ANSI. Therefore, many salient differences persist. These are caused by network and local habits as stated earlier.

# IEC - ANSI/IEEE comparison

## IEC - ANSI major discrepancies

### Identified difference

Two main categories are listed, according to influence on the design or on the qualification tests. In each case of design difference, it should be clear if the point is a requirement which does exist in one system and not in the other, or if a requirement is expressed in conflicting manners between the two systems.

For testing procedure differences, the question concerns the possibility to cover one system requirements by the qualification according to the other system.

A major difference in the two systems especially for the MV range is the need for 3<sup>rd</sup> party witness certification. This also includes "follow-up" services.

This program is called labelling.

### Ratings

ANSI/IEEE has two characteristics in the rating structure; Requirement and preferred values

Requirements are non-negotiable and preferred ratings are values achieved when the requirement are met.

**C37.20.2, which covers metalclad switchgear, considers a minimal bus rating of 1200 A for metal-clad (withdrawable).**

Short-circuit withstand is expressed in two different ways:

- IEC defines the rms value of the alternative component (duration to be assigned) and the peak value (2.5)
- ANSI defines the rms value to the alternative component for 2 seconds, and the "momentary current" which means the rms value, including DC component, during major first peak (2.6 or 2.7).

**C37.20.3, which covers metal-enclosed switches, considers the "normal" short time withstand current duration to be 2 s (the preferred value for the IEC is 1 s).**

### Design

- Max. allowed temperatures differ; reference for IEC is provided by 62271-1; reference for ANSI is provided by IEEE C37.100.1, as well as C37.20.2, C37.20.3, C37.20.4.
- acceptable temperature rises are much lower in ANSI than IEC. For instance, for bare copper-copper joints, the C37.20.3 (& C37.20.4) specifies a max. overhaul temperature of 70°C, while IEC accepts up to 90°C. Furthermore, ANSI considers all plating materials as equivalent (tin, silver, nickel) while IEC specifies different acceptable values. ANSI/IEEE requires that the lower temperature limit be used when two different contact surfaces are mated. Special values are provided by ANSI when connecting an insulated cable (value lower than the equivalent joint between two bare bars)
- acceptable temperatures for accessible parts are also lower for ANSI (50°C versus 70°C, when touched for normal operation, and 70°C versus 80°C, when not touched during normal operation). Not accessible external parts have also a maximum allowed temperature in ANSI: 110°C.
- Mechanical endurance for withdraw operations is stated as 500 operations for ANSI C37.20.2, 50 for ANSI C37.20.3. It is the same for IEC 62271-200, except if the withdraw capability is intended to be used as disconnecting function (to be stated by the manufacturer), then minimum 1000 operations as for disconnectors
- Other design discrepancies
  - insulating materials have minimum fire performances stated in ANSI, not currently in the IEC.
  - ANSI C37.20.2 and C37.20.3 requires ground bus with momentary and short-time current capability. IEC accepts current flowing through the enclosure, and the performance test is performed as a functional test (if bus is made of copper, minimum cross section is expressed).
  - ANSI C37.20.2 requires that VT are fitted with current limiting fuses on HV side. ANSI C37.20.2 & 3 requires the CTs to be rated at 55°C.
  - ANSI C37.20.2 and C37.20.3 specify minimum thickness for metal sheets (steel equivalent: 1.9 mm everywhere, and 3 mm between vertical sections)

# IEC - ANSI/IEEE comparison

## IEC - ANSI major discrepancies

and between “major parts” of primary circuit; larger values apply for large panels). IEC 62271-200 does not specify any material nor thickness for the enclosure and partitions, but functional properties (electrical continuity, by means of a DC test with maximum drop of voltage).

- ANSI C37.20.2 specifies minimum number of hinges and latch points according to dimensions.
- ANSI metalclad shall have insulated primary conductors (minimum withstand = phase to phase voltage)
- ANSI metalclad shall have barriers between sections of each circuit. That applies to the busbar, the compartment of which shall be split in “sections” along the switchboard
- for ANSI, withdrawable CBs shall be prevented by interlock from complete draw-out until their mechanism is discharged
- ANSI expresses dimensional requirements for the connection points of switches (NEMA CC1-1993)
- position indicators differ by color and markings
- auxiliary power supplies shall have a short-circuit protection within the switchgear for ANSI C37.20.2 & 3
- ANSI: primary connections of VTs shall incorporate fuses. Secondary connections according to the application.

### Basic testing procedures

- For withdrawable cubicles, power frequency dielectric tests between upstream and downstream conductors in the withdrawn position are specified as 110% of the value phase to ground in ANSI in all cases. For IEC, a test at the open gap value of disconnectors is required only if the withdraw capability is intended to be used as disconnecting function (to be stated by the manufacturer).
- Momentary current test to be at least 10 cycles long for ANSI, peak current withstand test to be at least 300 ms long for the IEC (and making tests to have at least 200 ms current after).
- For ANSI, all insulating materials, bulk or applied, need to demonstrate minimum flame-resistance (C37.20.2 § 5.2.6 and 5.2.7). The topic is not yet addressed by the IEC, but under discussion for the revision of the “common specifications” standard.
- For ANSI, paint on external ferrous parts needs to demonstrate protection against rust by mean of salted fog test.
- Switches according to ANSI C37.20.3 and C37.20.4 shall withstand an “open gap” dielectric test voltages (both power frequency and impulse) 10% higher than the phase to ground value; in IEC, similar requirement is expressed only for disconnectors.
- BIL tests have different sequences and criteria between IEC and ANSI (2/15 in IEC, 3 by 9 in ANSI). Equivalence between the two approaches is a controversial issue, and could not be considered valid.
- ANSI/IEEE temperature rise tests: cross sections of the supplying and shorting connections are defined by the standards, with no tolerances... Therefore, they can't comply with both standards at the same time.
- For routine tests, auxiliary circuits are checked at 1500 V x 1 min in ANSI (C37.20.3) instead of 2 kV x 1 min for IEC.
- ANSI switches according to C37.20.4 shall perform load-breaking tests before any of the optional rating tests (fault making for integral switch-fuse, cable charging switching current, unloaded transformer switching current).
- Dielectric test as condition check after power tests or mechanical endurance tests is specified at 80% of the rated power frequency withstand voltage by IEC (common clauses), and only at 75% by ANSI (C37.20.4).
- Fuse to checked current to ground during power tests of switches is specified differently in IEC and ANSI (100 mm long and 0.1mm diameter for IEC, 3 A rating or 2 inches long and #38AWG for ANSI).
- Circuit breakers require single phase testing per C37.09 Table 1 lines 6 & 7.
- Circuit breakers require the accumulation of 800% Ksi within the type test sequence.





