

User Manual

ANYCUBIC i3 MEGA

Thank you for choosing **ANYCUBIC** products.



Please read the user manual carefully.



Please visit www.anycubic3d.com for more information.



Email us on support@anycubic3d.com or james@anycubic3d.com for technical support.

If you experience any issues with this product, or the performance is not what you had expected, please contact us first. We are here to solve any problems for you.



Team **ANYCUBIC**



www.anycubic3d.com



[Facebook group](#)



[Youtube channel](#)

Safety Instructions

Please carefully read the safety instructions before get started.



ANYCUBIC 3D printer generates high temperature. Do not reach inside of the printer during operation. Allow time for the printer to cool down after printing. Contact with extruded materials may cause burns. Wait for printed objects to cool before removing them from the build platform.



ANYCUBIC 3D printer includes moving parts that can cause injury.



Vapors or fumes may be irritating at operating temperature. Always use the **ANYCUBIC** 3D printer in an open, well ventilated area.



Be cautious when using the scraper. Never direct the scraper towards your hand.



ANYCUBIC 3D printer **MUST NOT** be exposed to water or rain.



ANYCUBIC 3D printer is designed to be used within ambient temperature ranging 8°C-40°C, and humidity ranging 20%-50%. Working outside those limits may result in low quality printing.



It is recommended to use protection glasses when cleaning/sanding the printed models to avoid small particles contacting eyes.



In case of emergency, immediately turn off the **ANYCUBIC** 3D printer and contact us or consult for professional advice.

Never leave the **ANYCUBIC** 3D printer unattended during operation.。

Contents

1. Product overview	1
2. Part list	4
3. Assembly instruction	5
4. Leveling	9
5. Software installation	15
5.1 Driver installation	15
5.2 Cura Installation	17
6. Printing	26
7. Manual filament change	28
8. Resume from outage	29
9. Trouble shooting	32

Technical Specification

Printing

Technology:	FDM (Fused Deposition Modeling)
Build Size:	210×210×205 (mm ³)
Layer Resolution:	0.05-0.3 mm
Positioning Accuracy:	X/Y 0.0125mm , Z 0.002mm
Extruder Quantity:	Single
Nozzle/Filament Diameter:	0.4 mm/1.75mm
Print Speed:	20~100mm/s (suggested 60mm/s)
Travel Speed:	100mm/s
Supported Materials:	PLA, ABS, HIPS, Wood

Temperature

Ambient Operating Temperature:	8°C - 40°C
Operational Extruder Temperature:	max 260°C
Operational Print Bed Temperature:	max 110°C

Software

Slicer Software:	Cura
Software Input Formats:	.STL, .OBJ, .DAE, .AMF
Software Output Formats:	GCode
Connectivity:	SD card; USB port(expert users only)

Electrical

Input rating:	110V/220V AC, 50/60Hz
Working Voltage:	12V DC

Physical Dimensions

Printer Dimensions:	405mm×410mm×453mm
Net Weight:	~11kg

1. Product overview

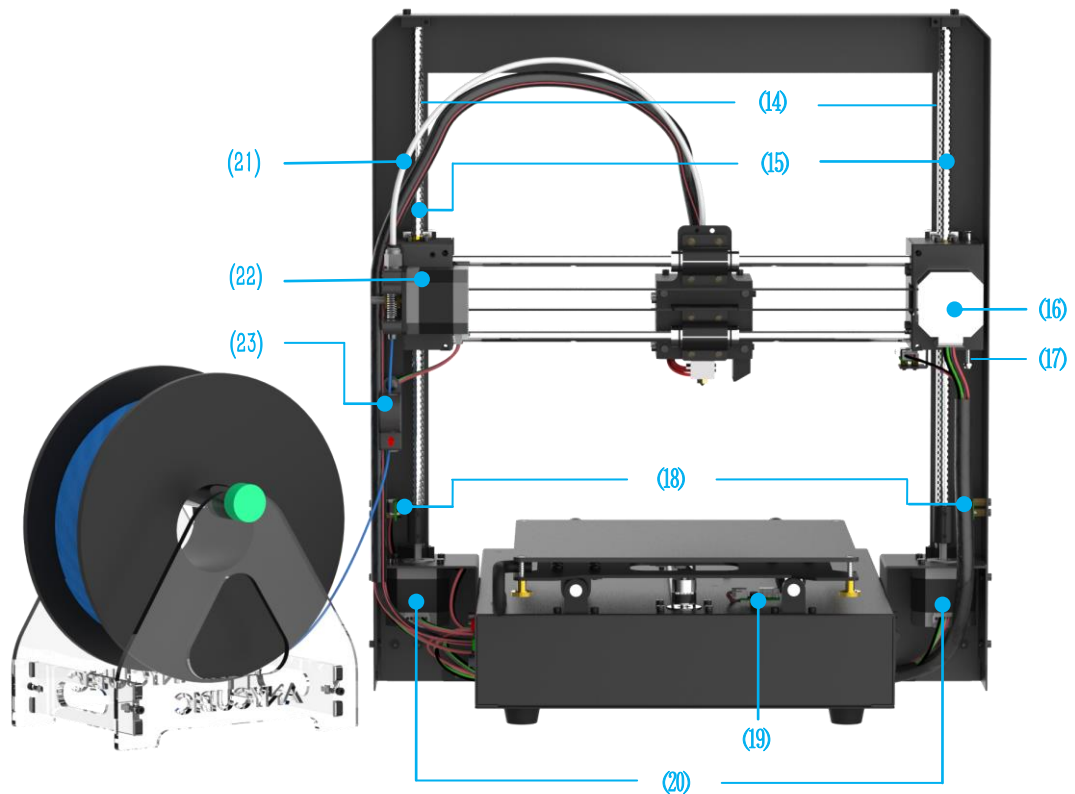
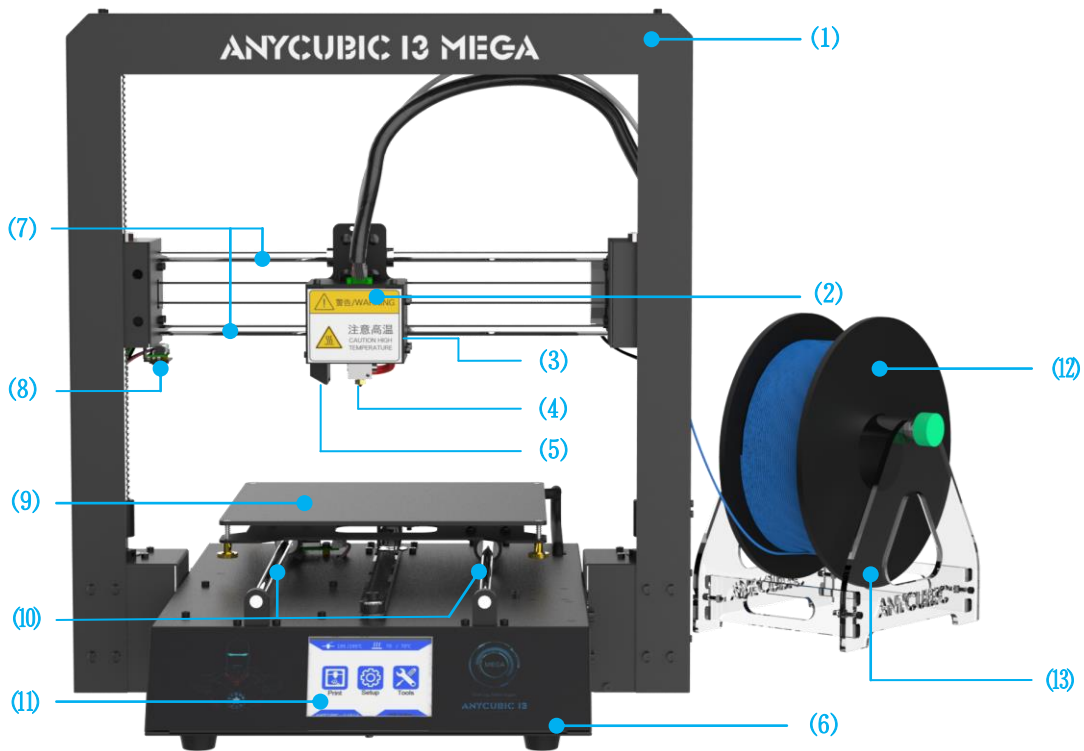

- (1)Frame (2)Print head (3)Hotend cooling fan (4)Nozzle (5)Model cooling fan (6)Base (7)X smooth rods (8)X end stop (9)Print platform (10)Y smooth rods (11)Touch screen (12)Filament spool (13)Spool holder (14)Z smooth rods (15)Z lead screw (16)X motor (17)Z adjustable nut (18)Z end stop (19)Y end stop (20)Z motors (21)Teflon tubing (22) Extruder (23) Filament sensor

Menu Directory

Home Menu

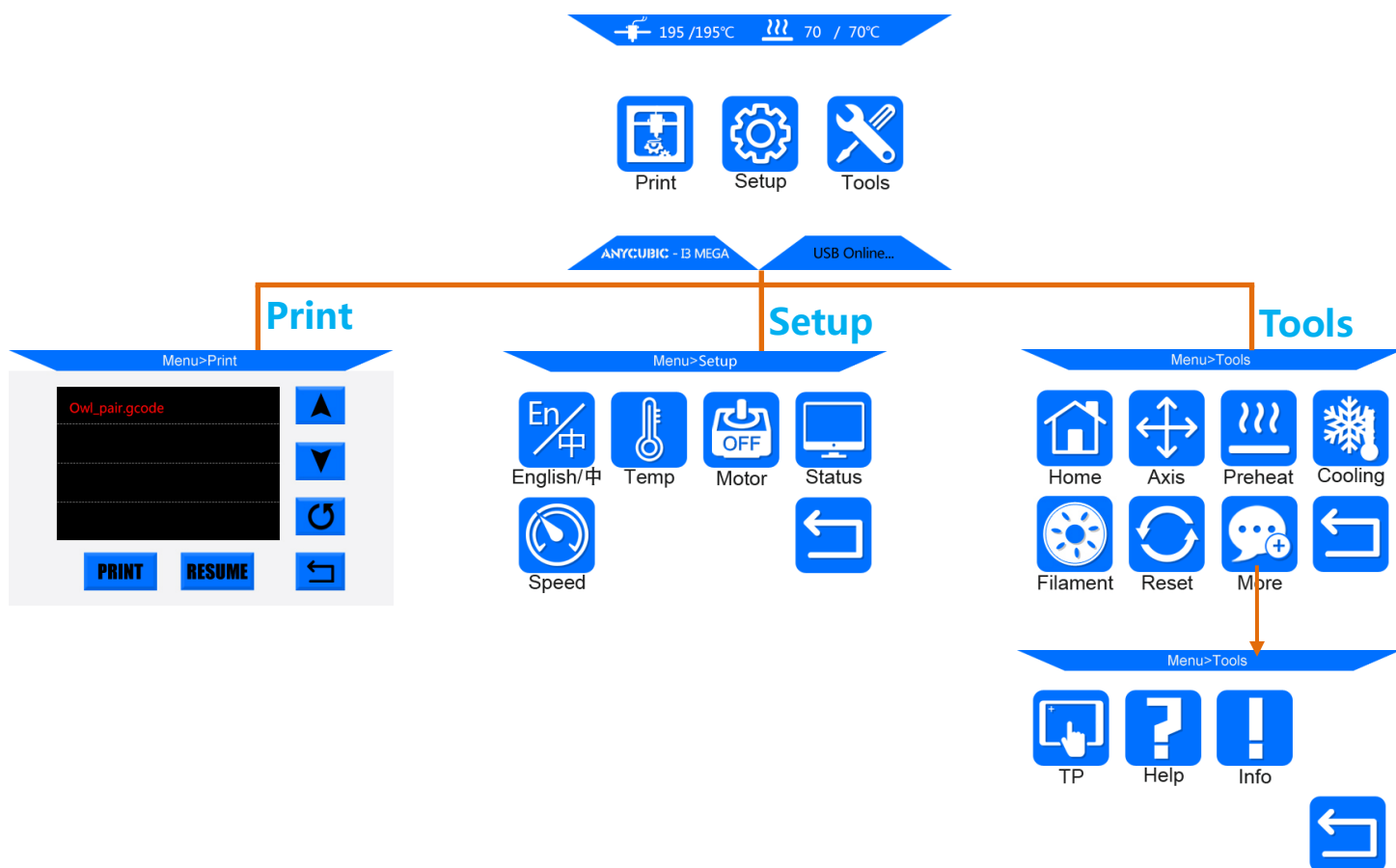

Home menu

Print: enter the print list

Setup: enter the setup menu

Tools: enter the tools menu

(Other information: ①nozzle temperature ②heated bed temperature ③printer status)

Print

Print: print the selected files in SD card

Resume: Resume from outage (only valid for offline print via SD card)

(Other information: ①Page up and down ②Refresh the list ③Return to the home menu)

Setup

En/中: Change language (English/Chinese)

Temp: Enter the menu to adjust ① E0 (hotend) Temp (170-260°C) ② Bed Temp (0-120°C)

Motor: Disable all motors (only valid when machine is not printing)

Status: Enter the sub-menu with Print/Pause/Resume icon (only valid for offline print)

(Other information: ① Files ② Print Rate ③ Time ④ Progress ⑤ E0 Temp ⑥ Bed Temp ⑦ coordinates for X/Y/Z axis ⑧ Return to previous menu)

Speed: Enter the menu to adjust ① Fan speed (0-100) ② Print Rate (50-999)

Return: Return to Home Menu

Tools

Home: ① Home X ② Home Y ③ Home Z ④ Home All ⑤ Return (only valid when machine is not printing)

Axis: ① Home all axis ② Move X/Y/Z axis by 0.1/1/10 ③ Speed mode for axis move Low/Medium/High (only valid when machine is not printing)

Preheat: ① Preheat PLA ② Preheat ABS (only valid when machine is not printing)

(Other information: ① E0 Temp ② Bed Temp)

Cooling: Cut off the power of hotend and heated bed (only valid when machine is not printing)

Filament: ① Filament In ② Filament Remove (will automatically heating to 200°C for filament in or remove) ③ Stop (only valid when on print job)

Reset: Popup window to decide if reboot the mainboard

More: Enter the next page of Tools sub-menu











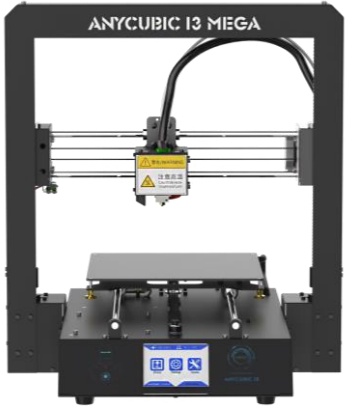

TP: Touch panel alignment (click on the cue points)

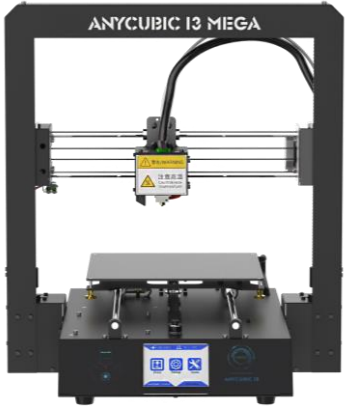
Help: Basic description of the Menu

Info: Information about the product

Return: Return to Home Menu

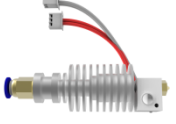
2. Packing list

				
	Tool kit	M5*8 screws	SD card	SD Card reader
				
	Gloves	Power cord	Tweezer	Spool holder
				
PLA filament (Random color)	USB cable	Extra hotend	Scraper	Plier

3. Assembly instruction

Step 1.Unpack and take out the printer and accessories.

Wear gloves because the smooth rods and lead screw may be greased in factory.

Step 2.Follow ① ② ③ in Fig. 1. Carefully lift the base to fit into the frame and fix them by 8 pieces of M5*8mm hex cap screws. The screw locations are indicated by red squares in ③. The screws can be installed in **diagonal order** and can be tightened after all screws installed in place.

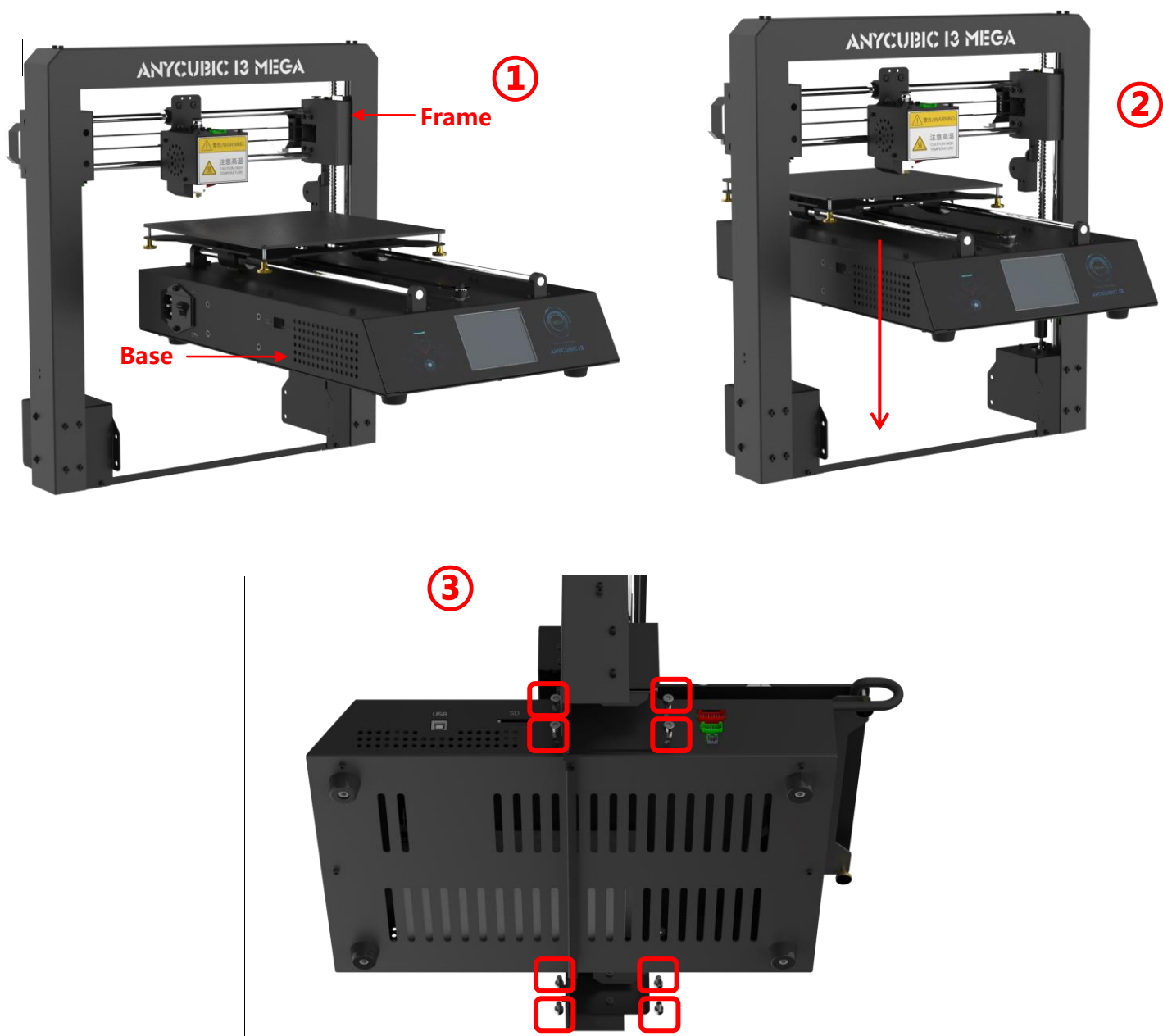

Figure 1

Step 3. Wiring

- (1) **Fig.2**, select the correct voltage mode according to your local voltage ratings (110V/220V). The **switch** is inside the bottom left of the base and **220V is default**. Allan keys can be used to move the switch inside.



(Figure 2)

- (2) There are 3 ports with different color (**Red/Green/Black**) at the bottom right side of the base, and there are 3 different color cable connectors respectively. Accordingly, insert those connectors to the ports **by the same color**, as shown in **Fig. 3**.

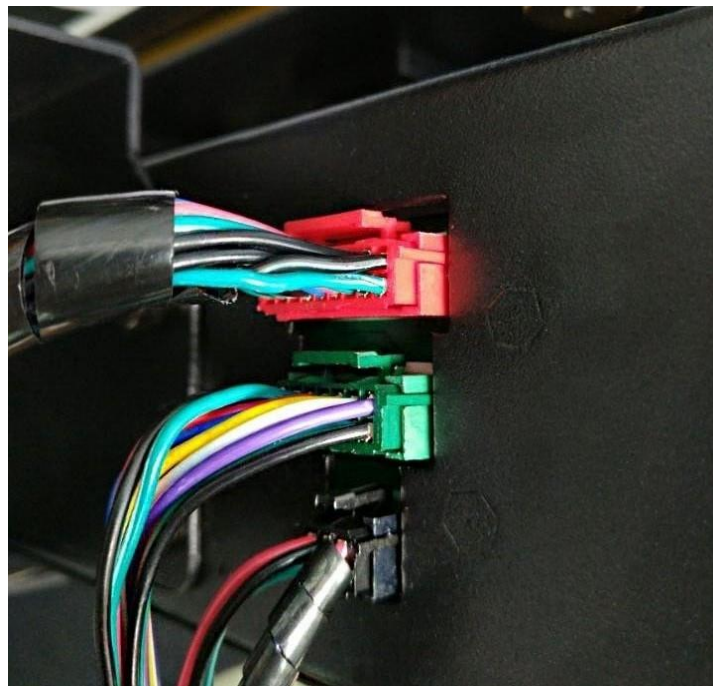

(Figure 3)

- > Make sure the connectors are well inserted, and no pins are bent inside.
- > Wrong or loose connection would lead to malfunction of the machine.

(3) **Fig. 4**, customers may notice there is a ring of zip tie attached just below the plastic ring of the quick connector. **Do not cut it off.**

Only cut this zip tie when swapping or repairing the hotend.

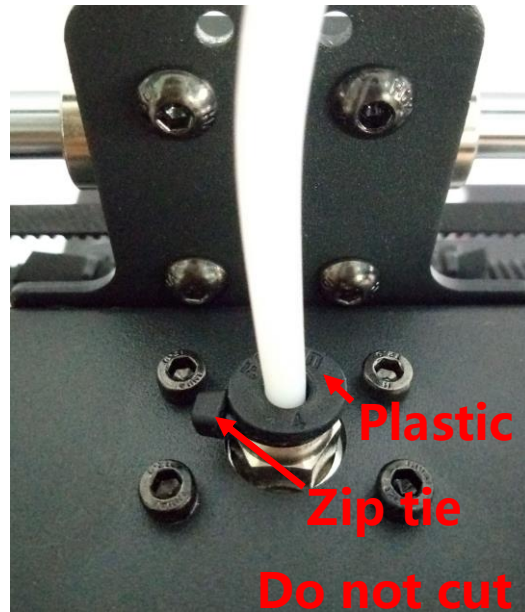

(Figure 4)

Step 4. Spool holder and filament sensor

(1) Assemble the spool holder as shown in **Fig. 5**, and tighten 4 pairs of screw and nuts at the lower 4 corner. (Customers may firstly peel off the protective cover on the acrylic plates)

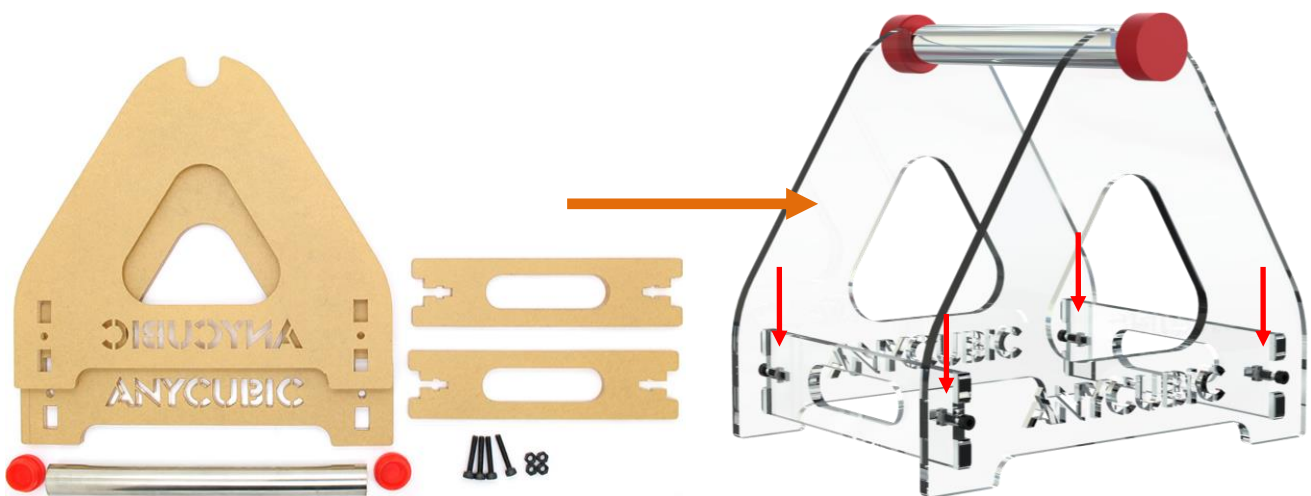

(Figure 5)

- (2) As shown in **Fig.6**, manually install the filament spool to the spool holder. Pass the filament through the filament sensor. Insert the filament into the extruder and Teflon tubing, but do not fully reach it into the hotend (until preheat the hotend later).

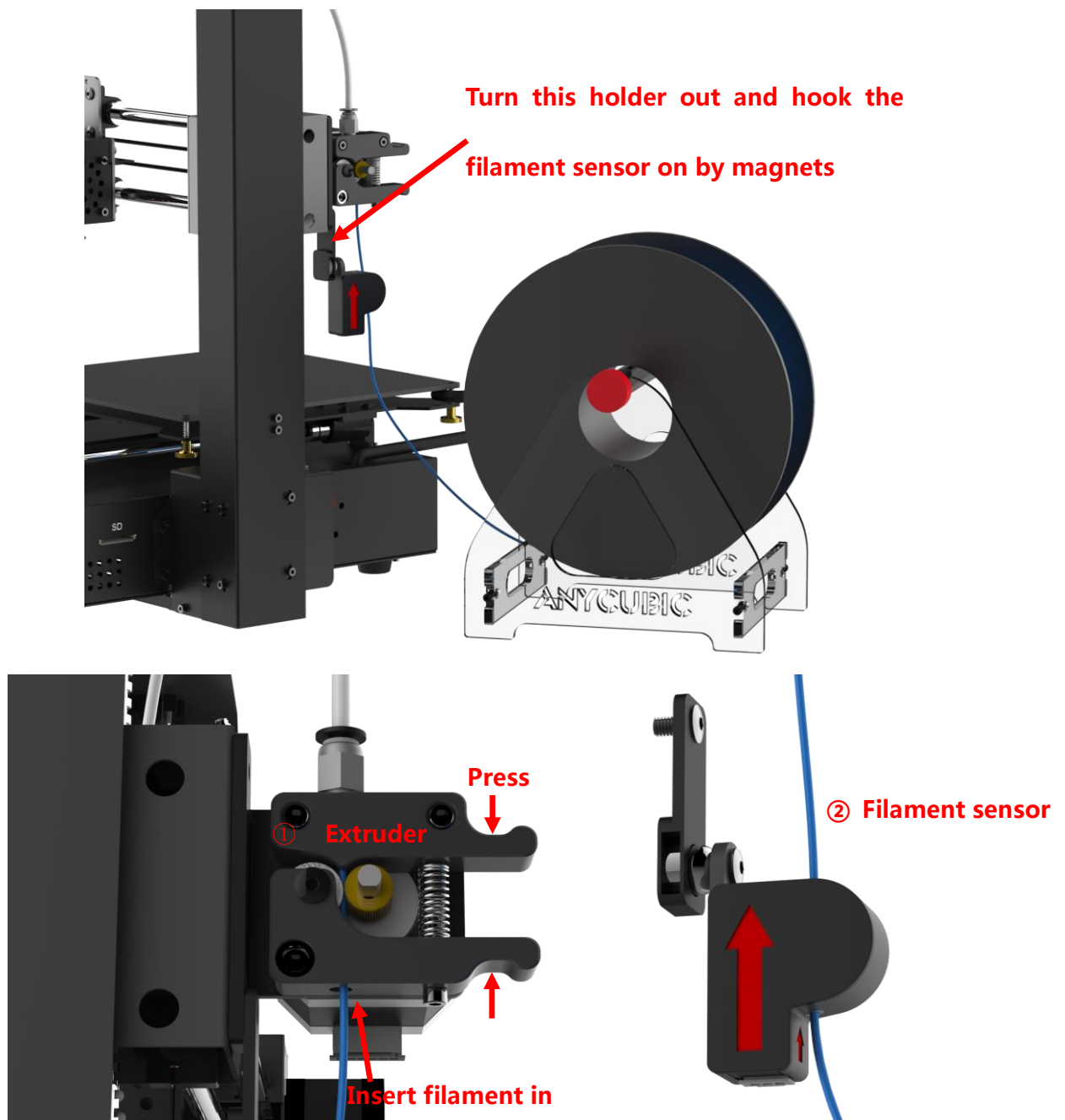

Figure 6

- > Only insert filament into the hotend after "Preheat" it later.
- > It is suggested to cut off the bent tip of the filament, and rotate the filament if feels any resistance during installation.
- > It is important to make sure there is no tied or tangle on the spool.

4. Leveling

It is essential to level the platform for 3D printer. Please follow procedures below:

Step 1. Check and ensure all wirings are OK. Connect the machine to the power outlet by power cord. Switch on the machine.

Step 2. As shown in Fig. 7, on Home Menu, click “Tools” --> “Home” --> “Home All” .

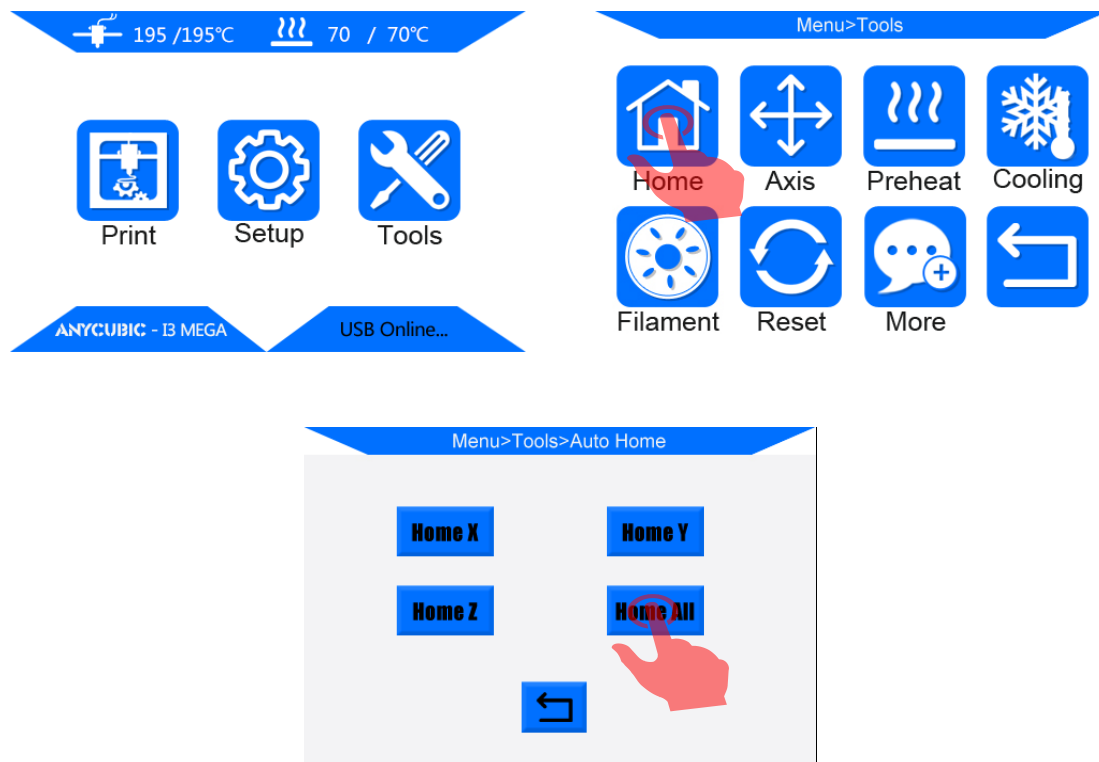

(Figure 7)

Step 3. As shown in Fig. 8, return to the “Home Menu” , click “Setup” --> “Motor” to disable the motors so the motors/axis could be moved freely.

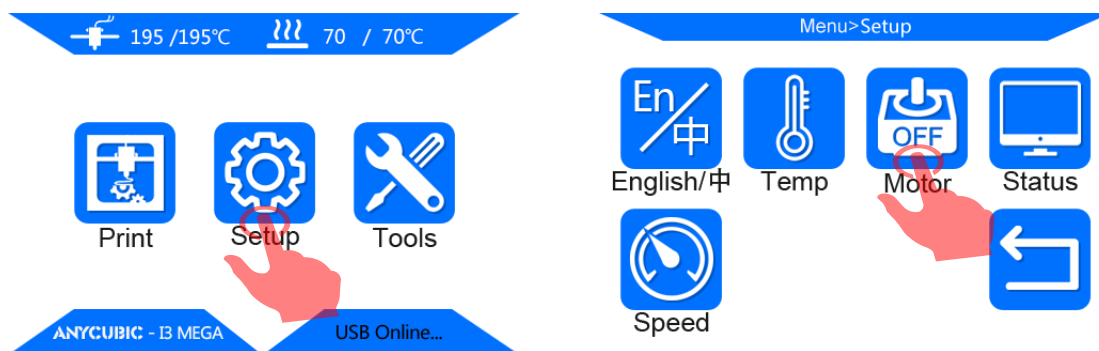

(Figure 8)

Step 4. Put a piece of paper onto the print platform, and then manually move the print head and platform back and forth to let the print head travel to the 4 corners and center one by one (①→②→③→④→⑤), as shown in **Fig.9.** (**Avoid nozzle rub against the platform directly without the paper in-between**)

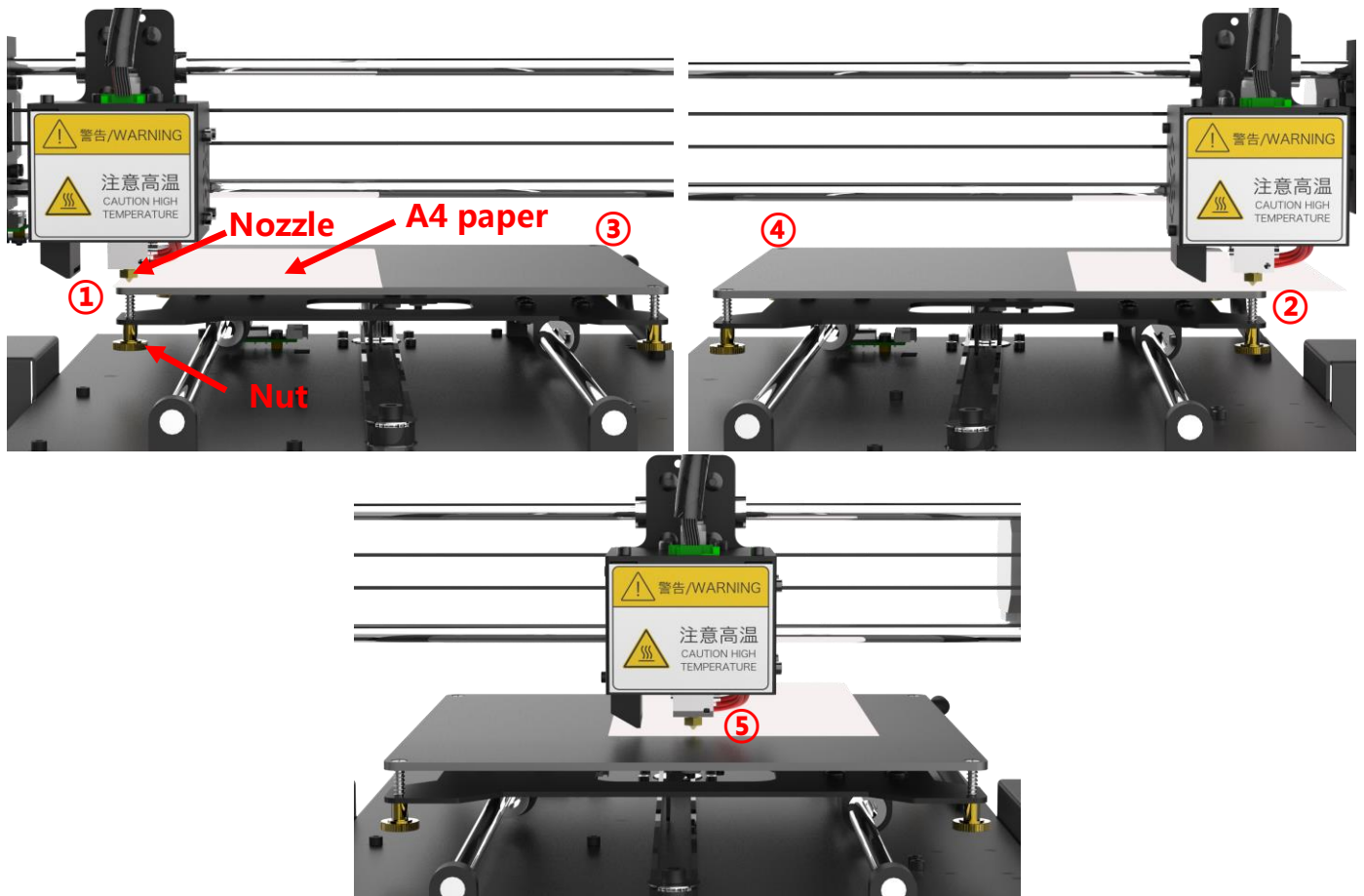

(Figure 9)

Step 5. When nozzle has been moved to corner ①, manually adjust (tighten or loose) the corresponding nut underneath the print platform.

The purpose is to **adjust the distance between nozzle and print platform to about a piece of paper thin (~0.1-0.2mm)**. Therefore, when just feel the drag resistance as pulling the paper, it means good leveling for this particular corner.

(Note: “just feel the drag resistance” means the paper can be moved, but with resistance)

Please do so to the rest of corners and center area. Perform double check to ensure the results, and **check the corners in diagonal order: ①→③, ②→④.**

Step 6. Ideally, after the 4 corners are leveled, the center should be spontaneously leveled, and you may proceed to do a test print on the platform. (see details in **Step 7**)

However, please be mindful that in some cases, the platform may not be perfectly flat (concave or convex) due to many factors in manufacture and usage.

ANYCUBIC promise that the flatness of the print platform is in the range of 0~0.2mm variation, means every piece of the platforms has been tested by a 0.2mm feeler gauge (**both sides of the platform have been respectively laid on a flat marble table and the 0.2mm feeler gauge could not be inserted in-between the platform and marble table).

There will be more details for the fine adjustment of the leveling in **Step 8**.

Step 7. Test print: insert the SD card (back side facing up) into the SD card slot at the base.

Click on the Home Menu "Print" to enter the file list (**Fig. 10**). There is a printable test file included -- "owl_pair" (author: etotheipi, www.thingiverse.com).

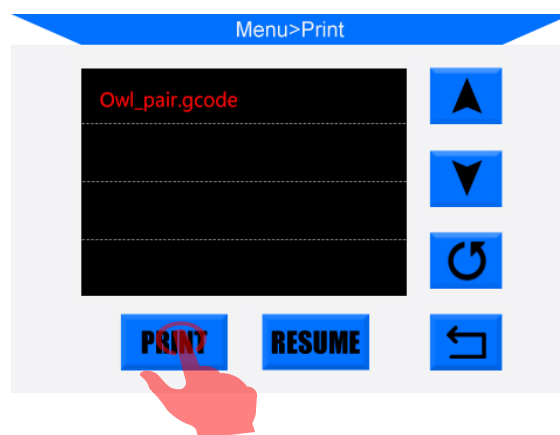

(Figure 10)

Single click on "owl_pair" , and click "Print" . The machine will be automatically heating the platform and nozzle before printing.

- **Now, as the temperature rises, please manually insert the filament through the Teflon tubing all the way into the hotend. (Refer to previous Fig.6)**
- The filament should flow through when temperature reaching to over ~180-190°C, otherwise the filament has not been inserted properly.

- Customers may use tweezers to carefully remove the extruded filament at the nozzle tip before printing.

Step 8. There might be 3 kinds of results for the first layer of the test prints (**Fig. 11**).



Nozzle too close
Lack of extrusion

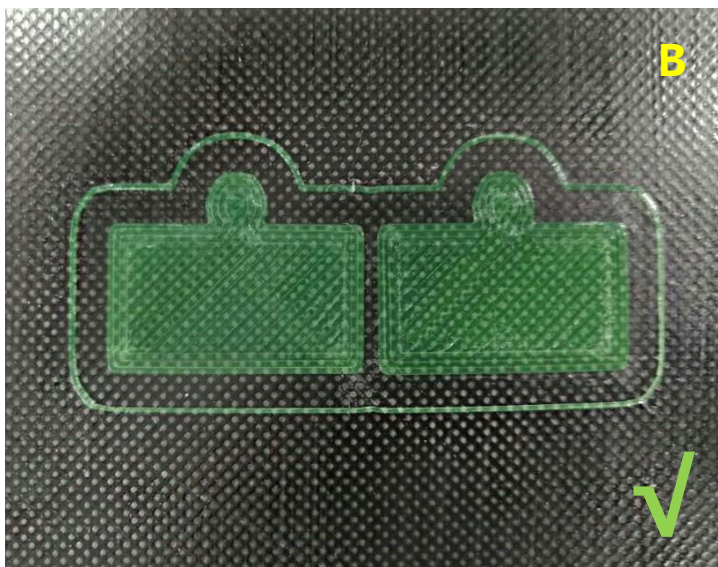
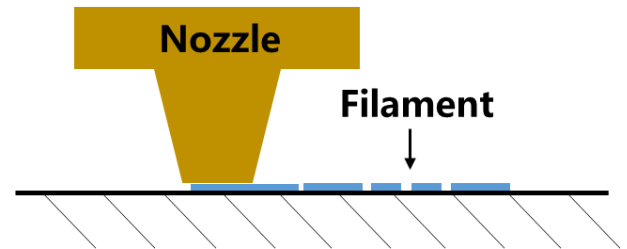

Proper nozzle height
Good extrusion and adhesion

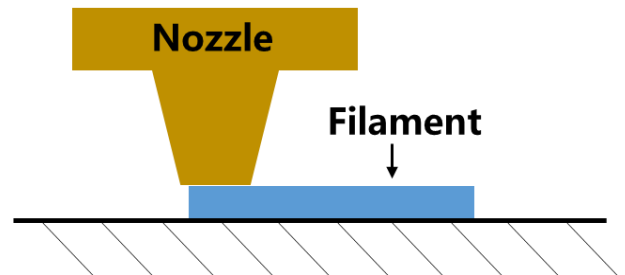

Nozzle too high
Poor adhesion

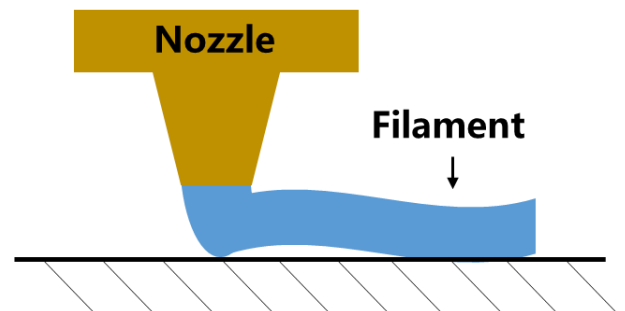

(Figure 11)

In case of “nozzle too close” or “nozzle too high” (**Fig. 11 A or C**), please click

“Stop” on the screen, raise the nozzle (click “Tools” --> “Axis” --> “10” on +Z column), and manually fine tune the corresponding nuts under the platform.

Particularly, when “nozzle too high” slowly loosen the corresponding nuts underneath the platform by half circle, while “nozzle too close” , slowly tighten the corresponding nuts underneath by half circle. After that, clean the platform with scraper, and run test file again to verify.

It may need adjustment for few times until satisfying results such as Fig. 11 B.

Supplements to leveling:

In some rare cases, after “Home All” , the nozzle can be still much lower than the platform, even after fully tighten the 4 nuts underneath. On the opposite, sometimes the nozzle is still too high from the platform, even after fully loosen the 4 nuts underneath.

How to solve this:

- (1) Raise the nozzle by click “Tools” --> “Axis” --> “10” on +Z column, adjust the 4 nuts under the platform, let the height in-between the support plate and the heated bed is ~**15mm** for all the 4 corners.

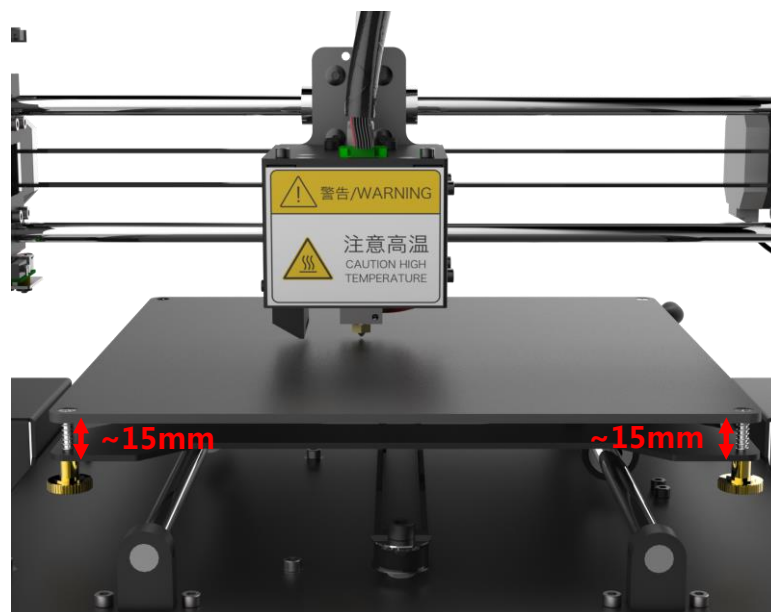

(Figure 12)

- (2) As shown in **Fig. 13**, at both ends of X axis, there is a Z adjustable nut. The lower tip of Z adjustable nut can trigger the Z end stop when Home (going down), and

'tell' the machine Z axis is getting to zero and stop moving.

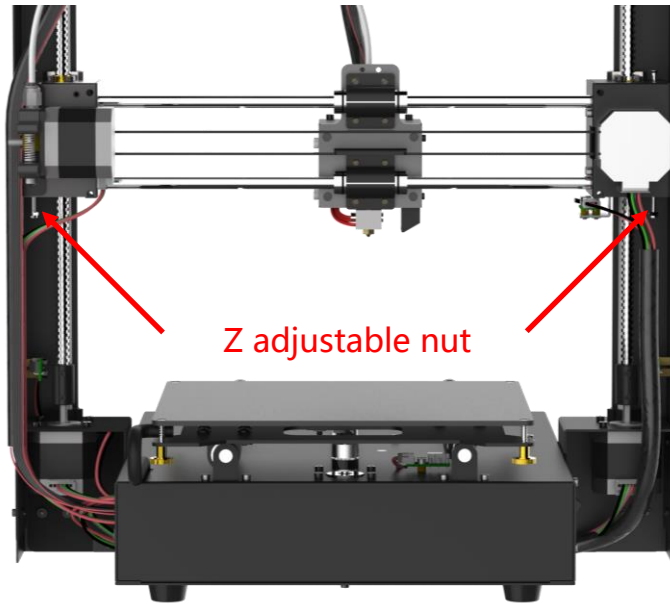

(Figure 13)

- (3) Therefore, tighten Z adjustable nut by X mm if nozzle is lower than the platform (X is defined by how much the nozzle is under the platform), while loosen it by Y mm if nozzle is too high from the platform (Y is defined by how much the nozzle is above the platform). It may need adjustment for few times.

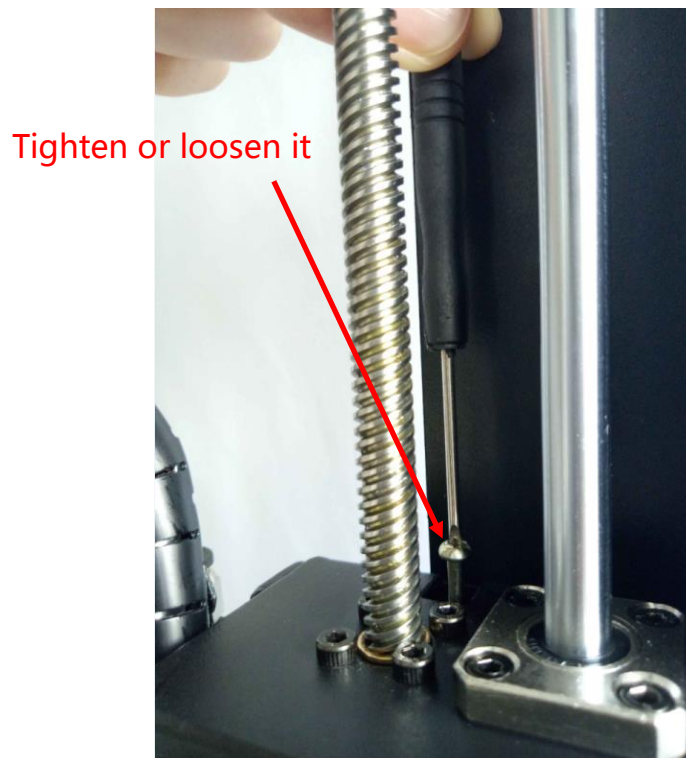

(Figure 14)

- (4) Click "Tools" --> "Home" --> "Home all" to verify the results. After this, please level the platform again from **Step 3**.

5. Software installation

There are two operation mode for **ANYCUBIC** Mega 3D printer, print offline (via SD card) and print online (controlled by PC via USB). **Print offline:** After leveling the platform, insert SD card, click “Print” at the Home menu and select a file (gcode file) to print. **Print online:** Install CP2102 driver to bridging PC and machine, and install Cura to control the machine via USB.

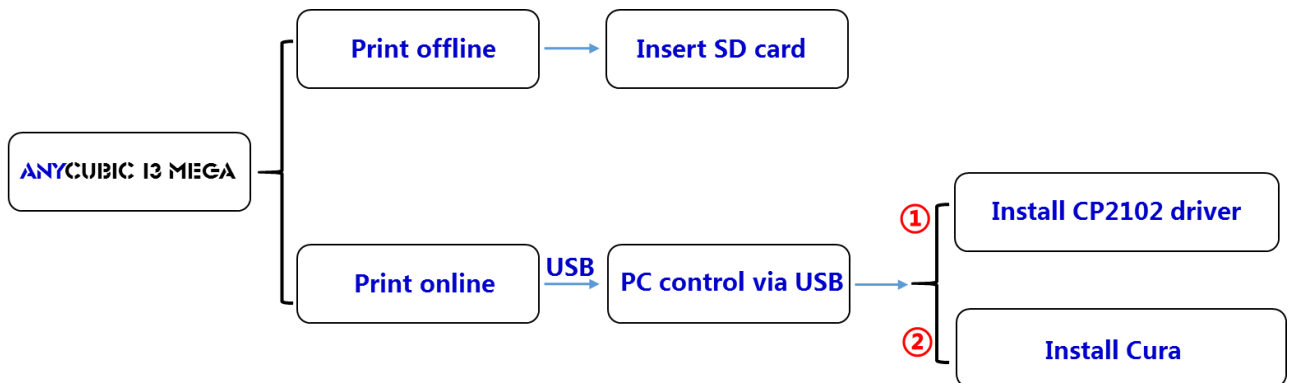

Generally, it is suggested to use Print offline to minimize the noisy signal via USB. The preparation steps for Print Online are shown as below.

5.1 Driver installation

ANYCUBIC Mega 3D printer uses CP2102 chip for communication. So, it is necessary to install CP2102 driver so the printer could be recognized by PC.

- Firstly, power on the machine and connect it to PC via USB cable.
- CP2102 driver is copied in the SD card. “Files_Engish_Mega” ---> “Driver_CP2102” . There are two versions, Windows and Mac version.
- For Windows, specifically, “CP210xVCPInstaller_x64” is for 64 bit system and “CP210xVCPInstaller_x86” is for 32 bit system.
- Here we take Windows 7-64 bit PC system for example, while there is “Installation for Mac PC” in SD card for those who use Mac system.
- On PC, right click on “Computer” ---> “Properties” ----> “Device Manger” , and

then follow the steps in **Fig. 15** below.

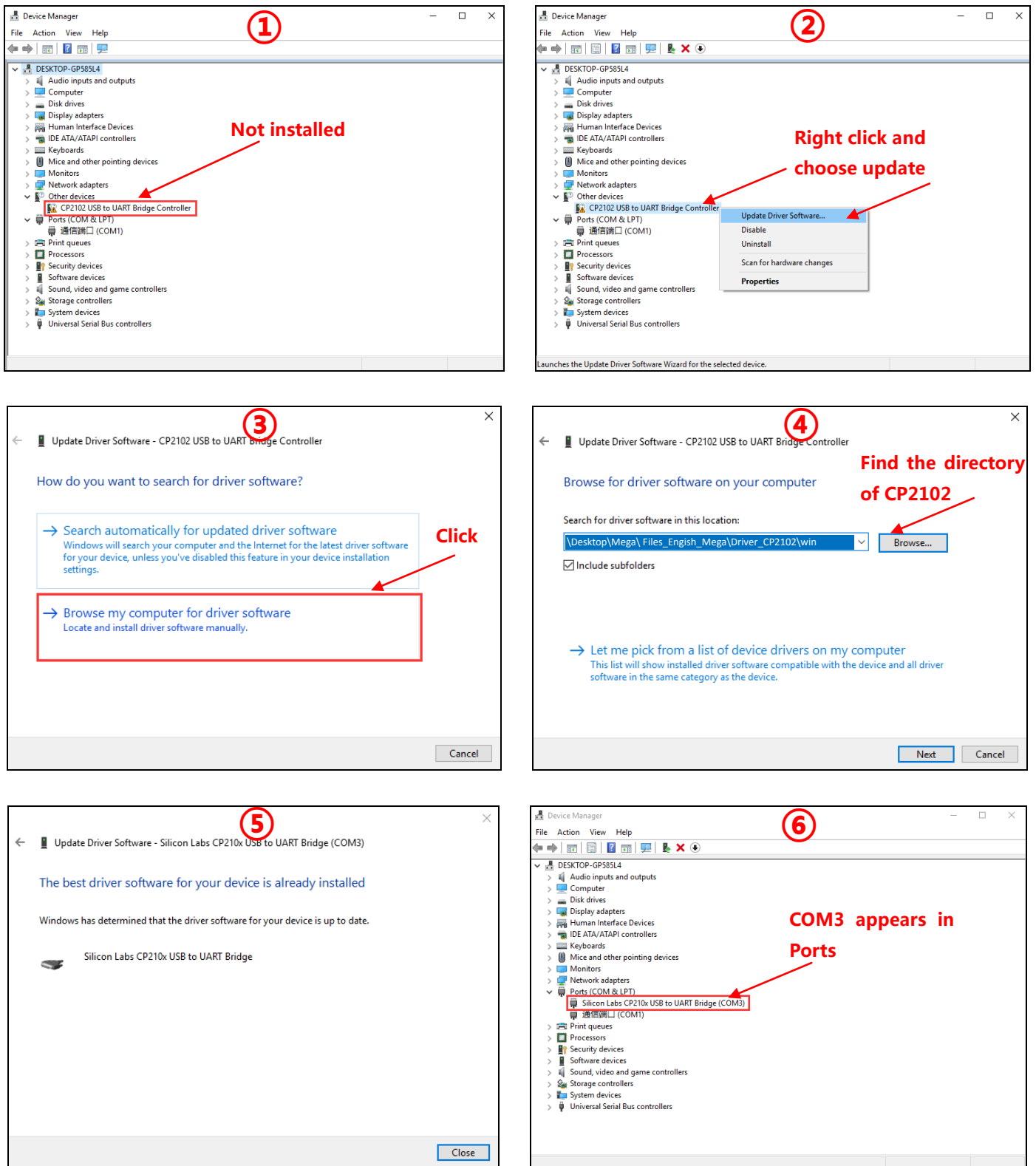

(Figure 15)

After successfully installation, a **COM x** would appear in the Ports of Device Manager, x is random (as here is COM3), customers will have their own COM x depends on their PC. This COM x port will be used for communication between the printer and PC later.

- If the PC has been installed CP2102 driver before, then there should be a COMx in Ports of Device manager already.
- Sometimes, even the driver is not installed properly, it may still show an abnormal COMx in Ports, please just uninstall the COMx and try to install the driver again.

5.2 Cura Installation

ANYCUBIC Mega 3D printer reads Gcode file and prints. It is necessary to convert 3D files (such as stl file) into Gcode files for machine to recognize. Software that convert 3D files into Gcode files is called slicing software. Cura_15.04.6 is used for example here.

Location of Cura: SD card---> "Files_English_Mega" ---> "Cura" ---> "Windows" .

Double click "Cura_15.04.6" , and follow the procedures as shown in **Fig. 16**:

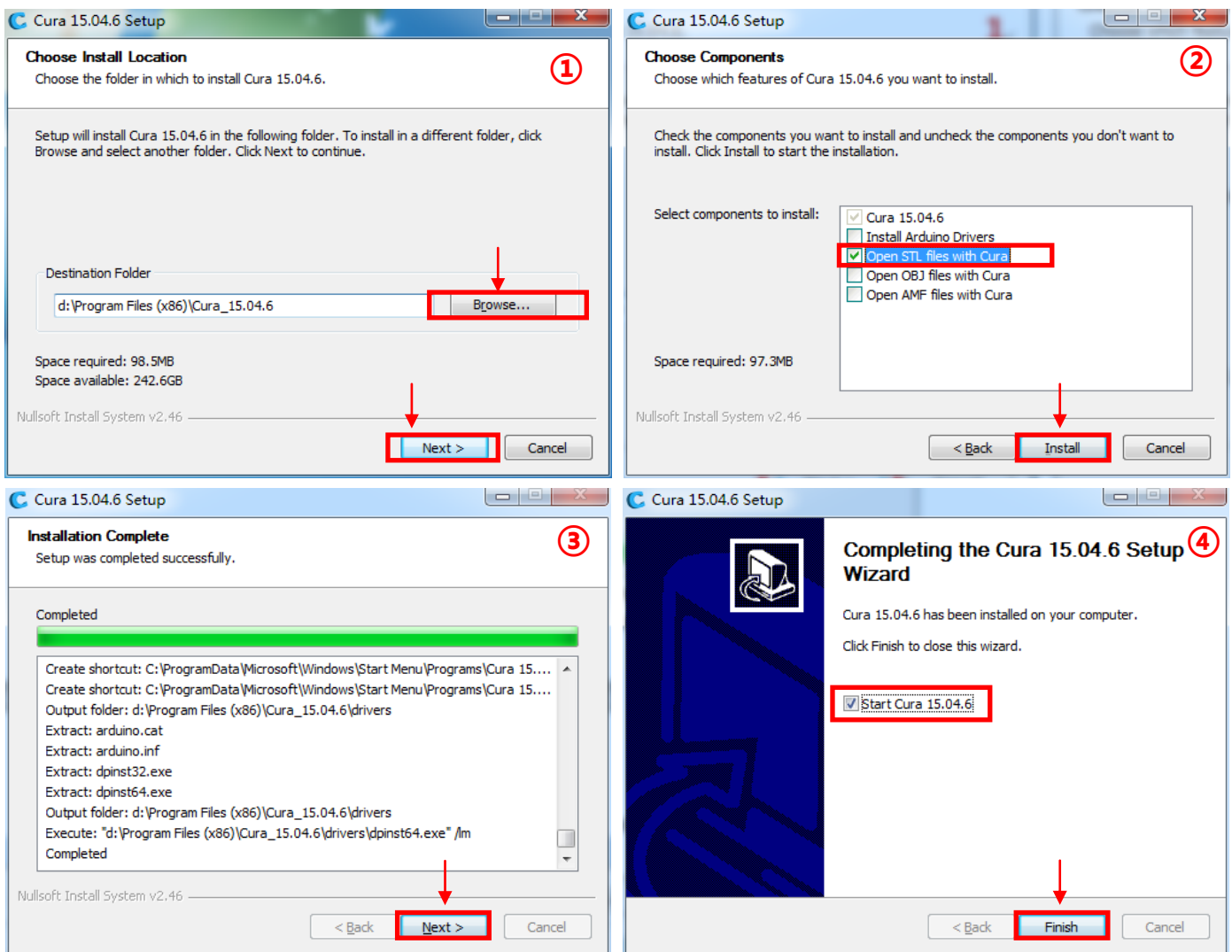

(Figure 16)

Next, before start Cura for the first time, there will be more settings about the language and machine types, as show in **Fig. 17**.

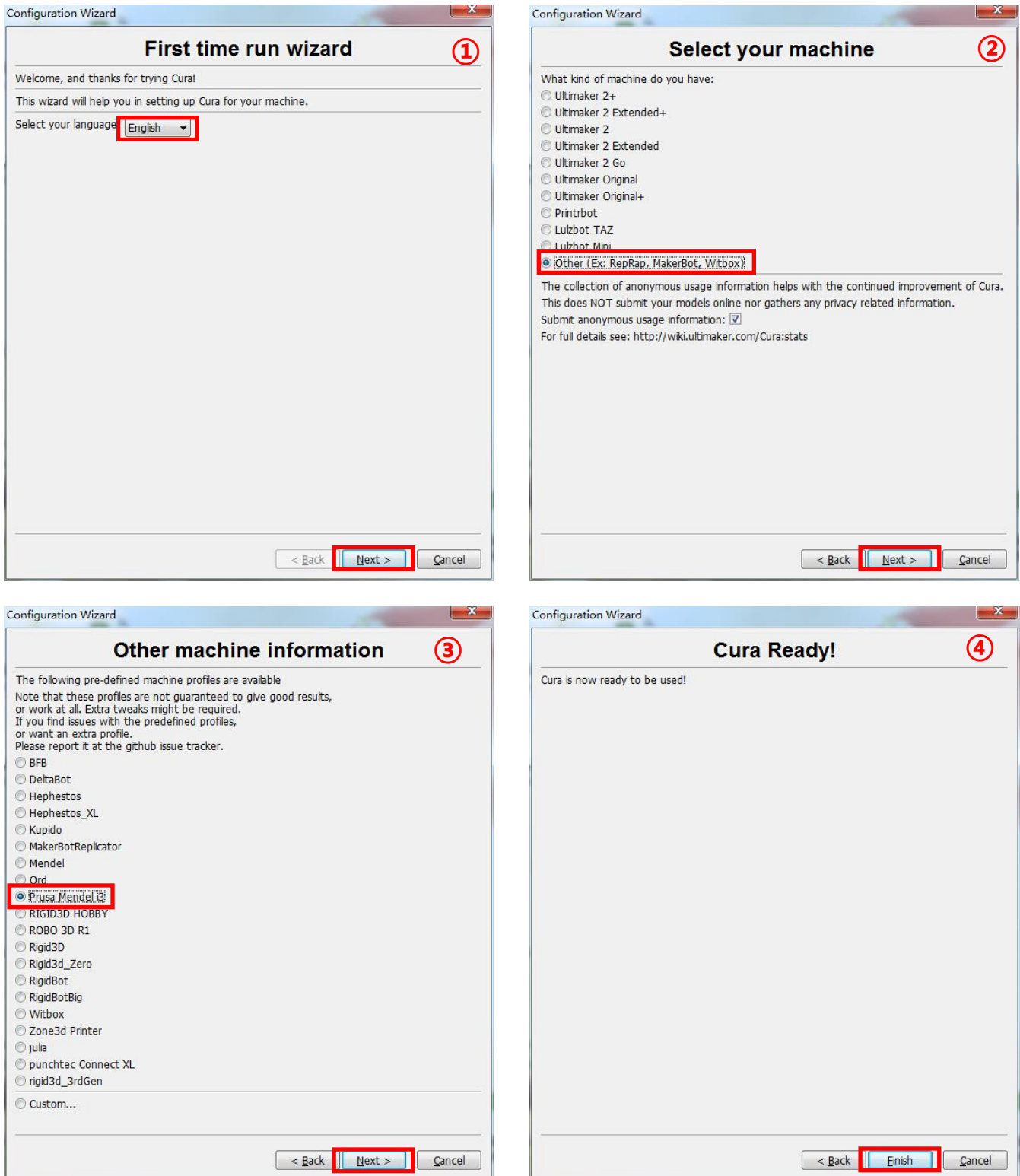

(Figure 17)

Upon finish, open Cura for the first time, there might be a default robot model appears, customers may click "File" ---> "Clear platform" to delete it.

5.2.1 Load 3D model into Cura

- (1) Clear the platform by clicking "File" ---> "Clear platform"
- (2) Load 3D files onto the platform by "File" ---> "Load model file...". Files with extension such as "STL" , "OBJ" , "DAE" and "AMF" can be loaded.

Model in grey means it is outside of the printable area and needs to be moved or scaled to fit in.

5.2.2 Manipulate 3D model in Cura

- (1) Zoom in/out: scroll the mouse wheel
- (2) Change viewing angle: right click the model, hold on and move the mouse
- (3) Position change: left click on the model, hold on and drag the model to move.
- (4) Rotate: single left click on the model and several icons will appear at the bottom left of the window (**Fig. 18**). Click the rotate button, 3 circles will surround the model. Rotate the model by moving the circle lines.

- Lay flat: it is very important to ensure the flat portion of the model is well attached to the platform. So, please use Lay Flat option everytime after rotating the model, as it will minimize the adhesion issues during printing. (**Fig. 18**)
- Reset: click it to return the model to the original orientation.

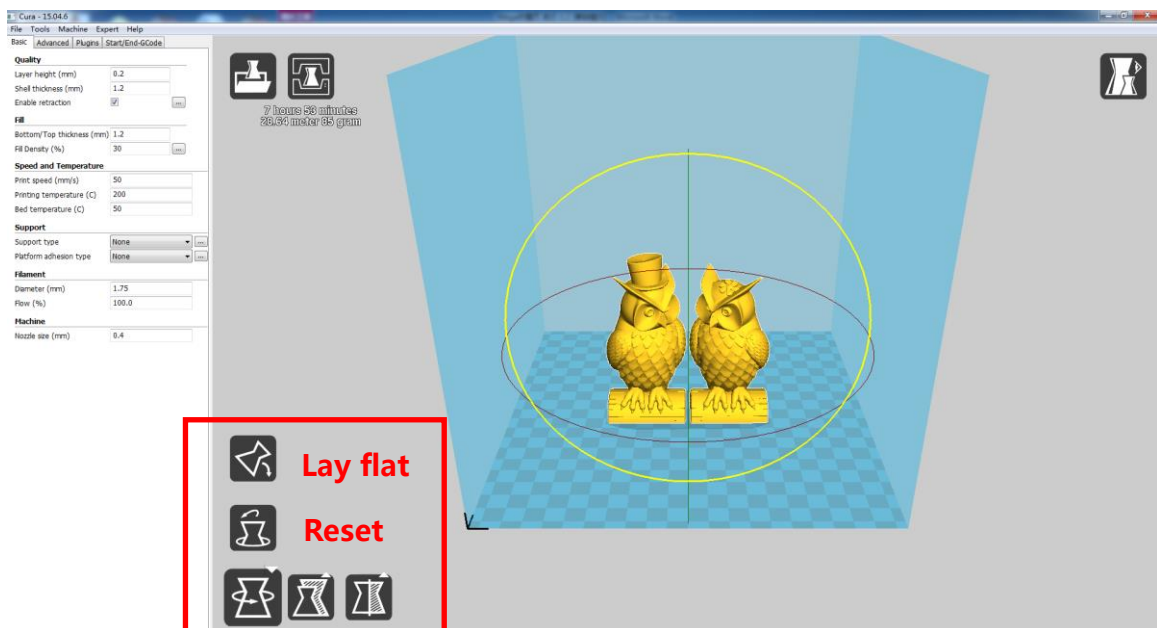

(Figure 18)

(5) Scale: to uniformly scale the model along X/Y/Z dimensions. To disable uniform scaling, click the lock in the lower section of the scaling window. (**Fig. 19**)

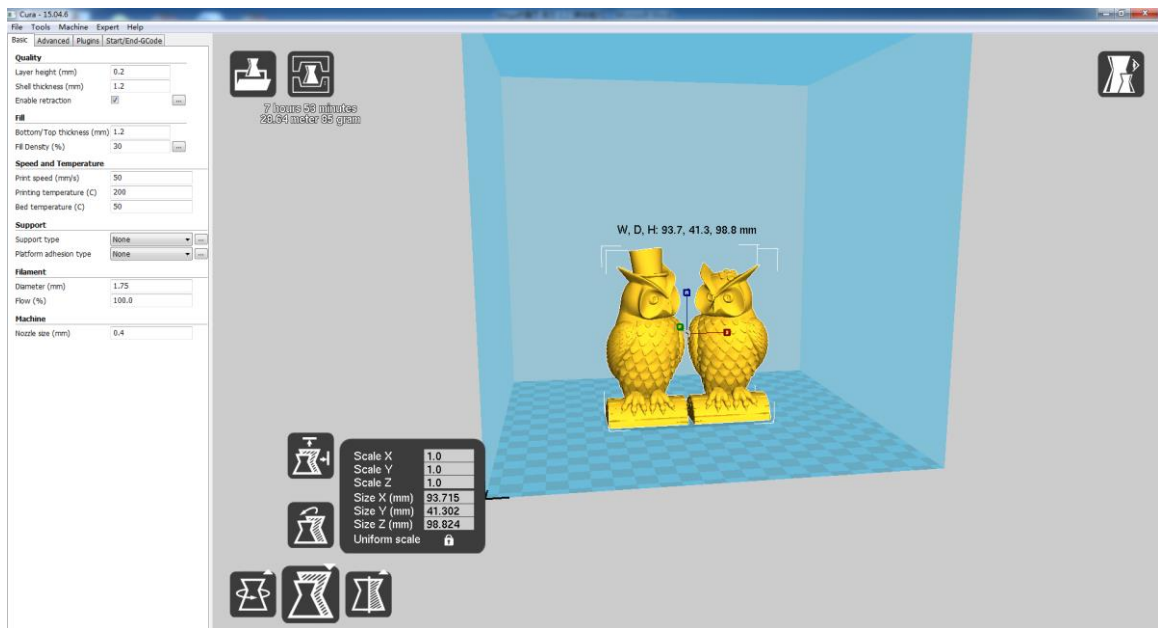

(Figure 19)

(6) View mode (**Fig. 20**): to view the model in different ways and helps to spotting issues before print starts. Such as “Layers” mode: to view the toolpath of the print head to check if there are skipped layers or gaps.

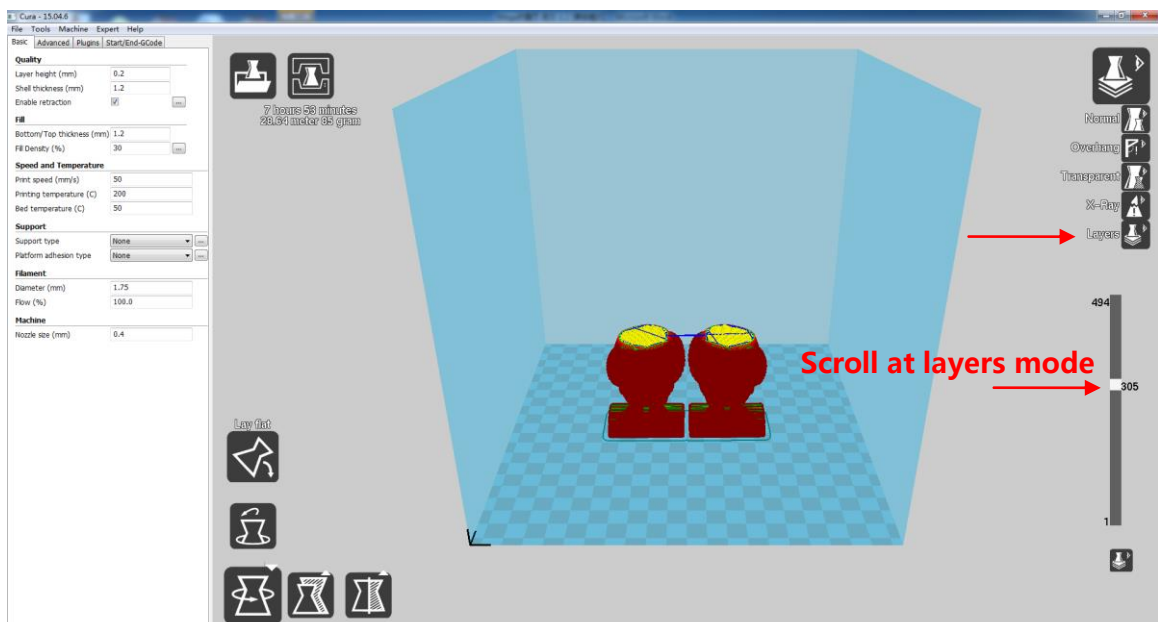

(Figure 20)

5.2.3 Cura settings

(1) Machine settings

Refer to **Fig. 21**, click “Machine” ---> “Machine settings” to input those suggested parameters into the corresponding column. Please choose the Serial Port (COM) as shown in your PC→Device Manager→Port (refer to **Fig. 15** ⑥, customers may have a different COMx other than the example COM3), and set the Baudrate to 250000. Those two parameters are essential for Cura to connect to the printer.

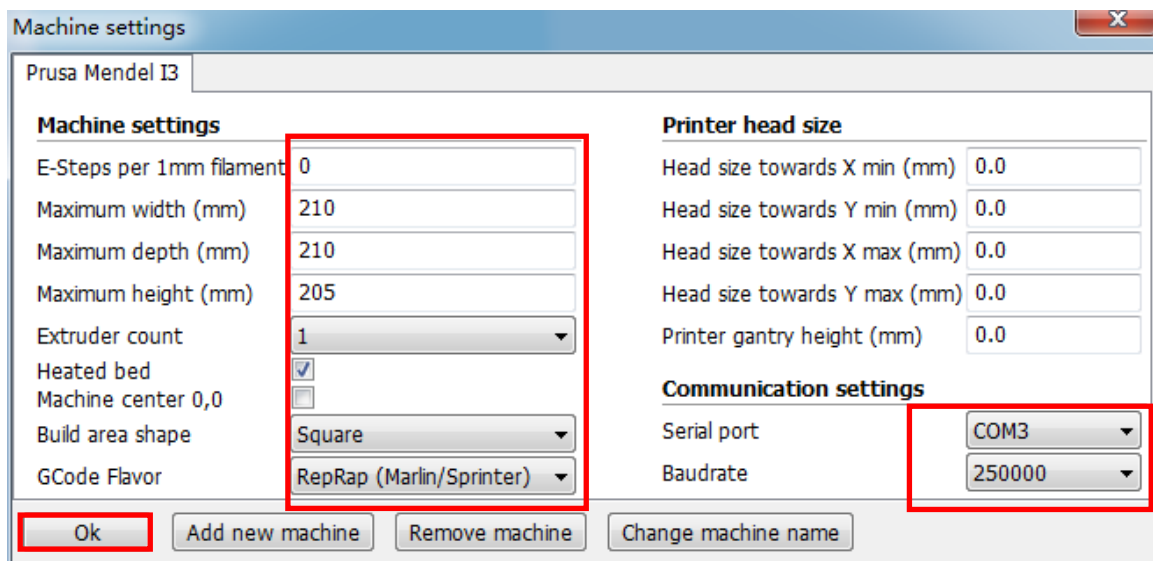

(Figure 21)

(2) Basic and Advanced options

Suggested “Basic” and “Advanced” settings are shown in **Fig. 22**. Stay the mouse upon each box and there will be explanation for it.

Those parameters are suggested for **ANYCUBIC** Mega 3D printer to print **ANYCUBIC** PLA filament. Generally, those settings are also compatible with other brand of PLA, but customers may need to fine tune the parameters to get the best results, for example, customers could try different ‘printing temperature’ based on the suggestion from a particular filament supplier. Especially, in order to get a good adhesion for the first layer, the ‘Bottom layer speed’ should not be too fast (20mm/s suggested).

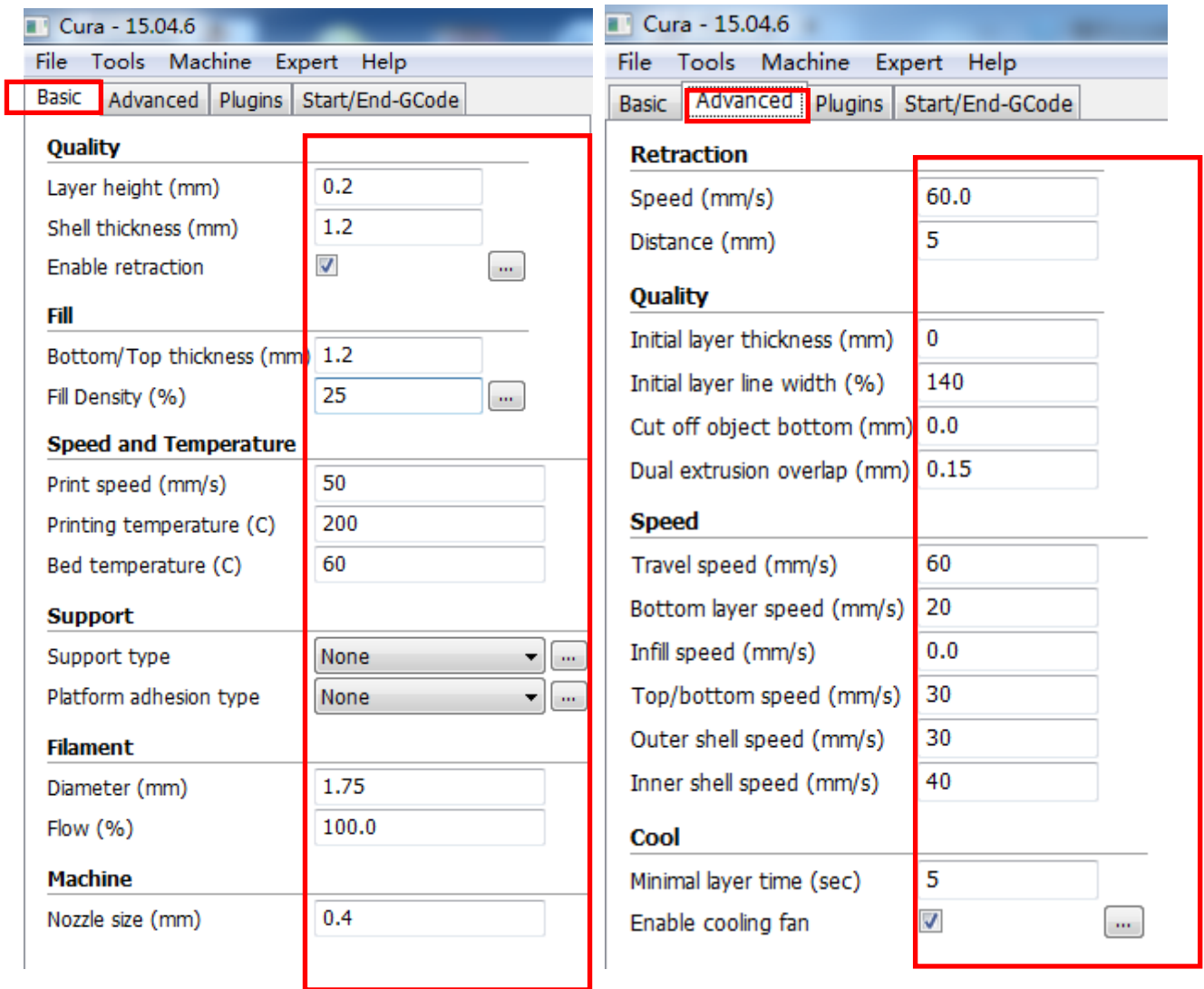

(Figure 22)

(3) Plugins

*It is recommended for new user to leave the plugins as default (i.e. no plugins enabled).

Plugins are custom settings which will active at specific point during printing. There are two pre-loaded plugins with Cura: Pause at height and Tweak At Z. More plugins can be found via: <http://wiki.ultimaker.com/Category:CuraPlugin>

As shown in **Fig. 23**, to enable one of the plugins, such as Pause at height, first click it and then click the drop-down arrow to enter the setting interface.

“Pause at height” will allow the printing to pause at a specified height, as well as where the print head would move to and how much filament to retract to prevent extruded filament blobs. So, customers could do filament change during printing.

“**Tweak at Z**” would allow custom changes at specified Z height. Customers may decide the Z height or layer counts at which to make a change. Then there are more settings for how you would like to change, such as temperature, fan speed and print speed. Fine tune those for specific model would produce better results.

If wish to delete the plugins, stay mouse at the edge, hold the left button and drag mouse to show the Delete icon.

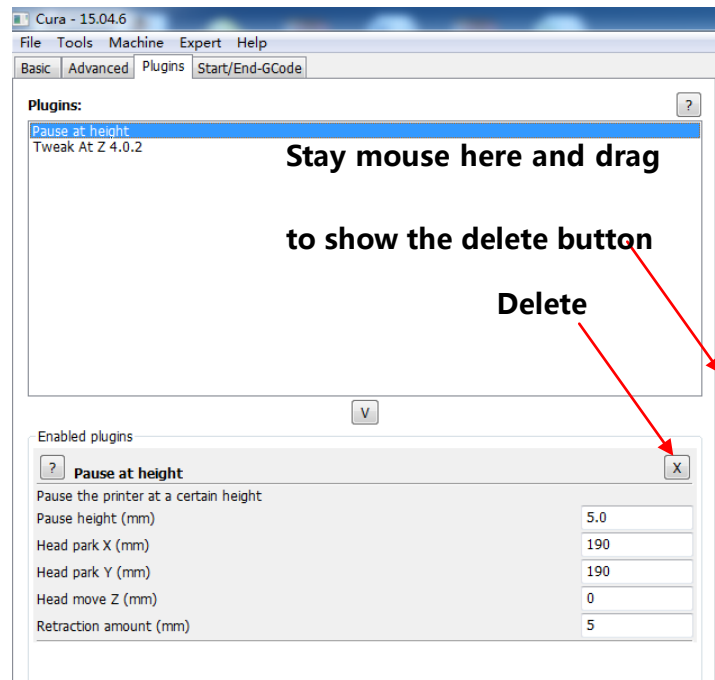

(Figure 23)

(4) Start/End-GCode

As shown in **Fig. 24**, custom Gcode allows for complex automatic printer movements and operations. By adding custom Gcode into the start or end of the Gcode file, customer could change how it prints. A detailed list of Gcode commands can be found via: <http://reprap.org/wiki/G-code>

There will be explanation later about how to add command to start-gcode to achieve the function of resume from outage.

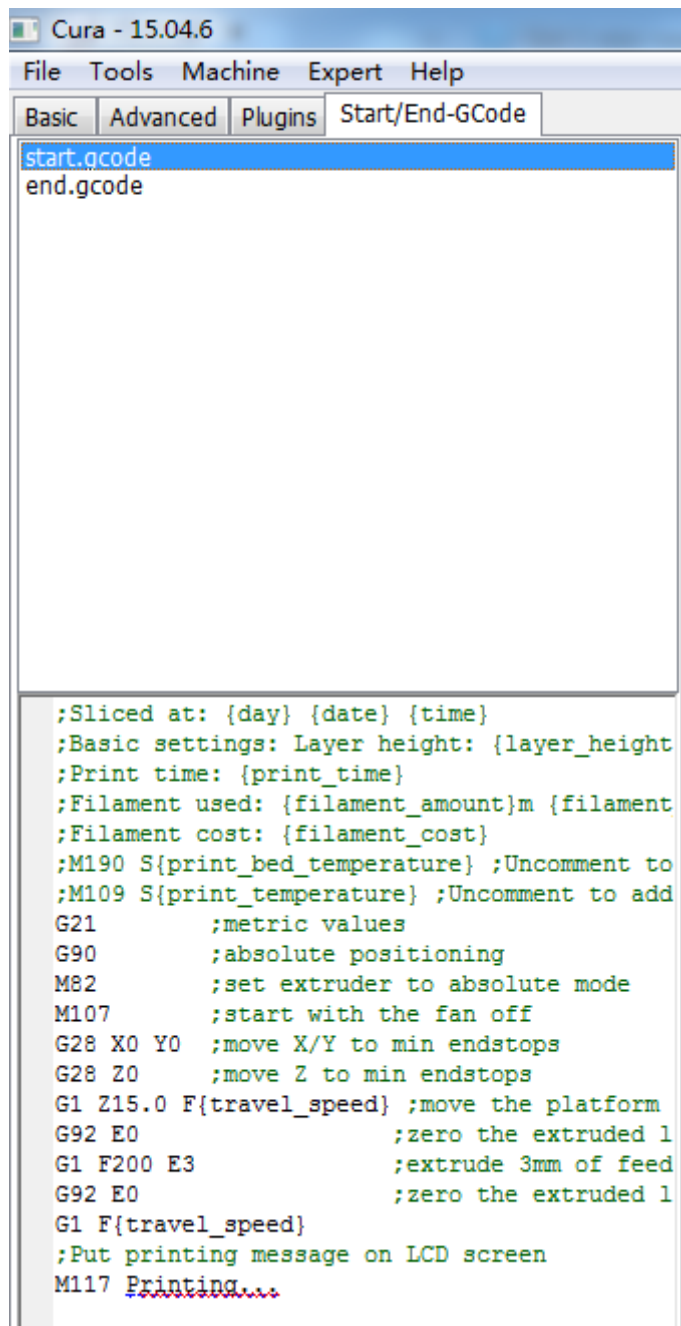

```
start.gcode
end.gcode

;Sliced at: {day} {date} {time}
;Basic settings: Layer height: {layer_height}
;Print time: {print_time}
;Filament used: {filament_amount}m {filament_color}
;Filament cost: {filament_cost}
;M190 S{print_bed_temperature} ;Uncomment to
;M109 S{print_temperature} ;Uncomment to add
G21          ;metric values
G90          ;absolute positioning
M82          ;set extruder to absolute mode
M107         ;start with the fan off
G28 X0 Y0    ;move X/Y to min endstops
G28 Z0       ;move Z to min endstops
G1 Z15.0 F{travel_speed} ;move the platform
G92 E0       ;zero the extruded l
G1 F200 E3    ;extrude 3mm of feed
G92 E0       ;zero the extruded l
G1 F{travel_speed}
;Put printing message on LCD screen
M117 Printing...
```

(Figure 24)

5.2.4 Print online by Cura

After parameter settings, customer can print online by Cura with USB connection.

Click “File” ---> “Print...” enter the printing popup window (**Fig. 25**). (If a simplified version of printing window appears, please click “File” ---> “Preferences...” to choose the ‘Pronterface UI’ in the “Printing window type” drop-down menu)

Click “Print” icon when it is available after auto connect with the printer. Then the temperature would rise and it will start to print when reaching to the target temperature.

Use tweezers to carefully get rid of the pre-extruded filament.

Note: If it fails to connect the printer in the popup “Printing window” (in a case that the “Print” icon is gray and unavailable), check with the COMx or Baudrate in “Machine settings” , and re-open the printing window to proceed.

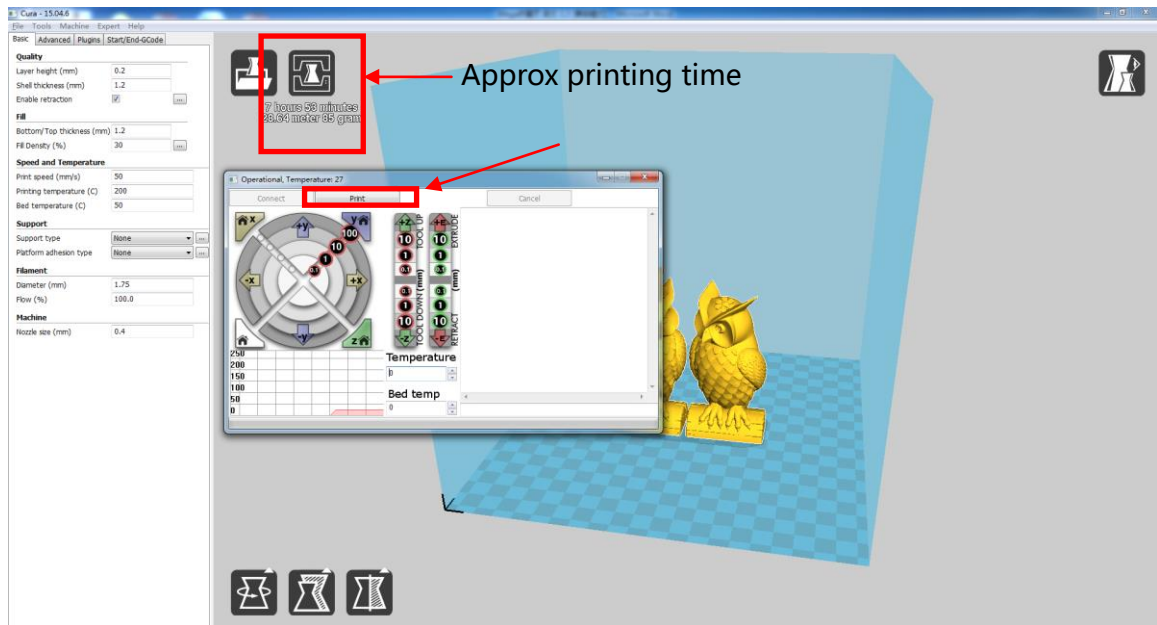

(Figure 25)

5.2.5 Save GCode in Cura

In Cura, click “File” ---> “Save GCode...” to save the file to a desired directory. And it is highly recommended to save the Gcode in a SD card for printing offline.

- Re-open the Gcode file again in Cura to confirm that all slices of the model have been included by check it in the “Layers view” (refer to previous **Fig. 20**).
- **The file name should only contain English letters, underscore and space. File name contains special characters could not be recognized by the printer.**

6. Printing

Here shows the steps of printing offline (via SD card), print online please refer to **5.2.4**.

1. Click "Tools" --> "Preheat" --> "Preheat PLA (for example)" , **Fig. 26**.

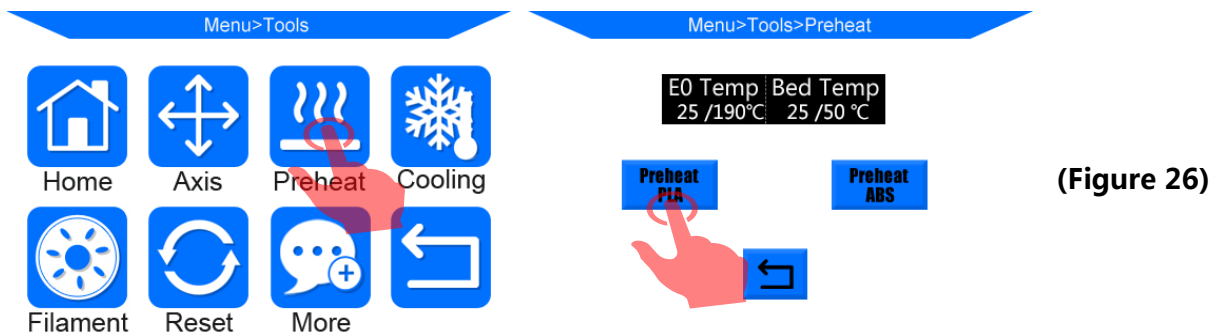

2. After the pre-heat is finished, please click on Home screen "Tools" --> "Filament" --> "Filament in" (**Fig. 27**). The extruder motor will start to feed the filament into the hotend. There might be some excessive filament melt through the nozzle at high temperature, use tweezers to carefully remove it from the nozzle tip before print.

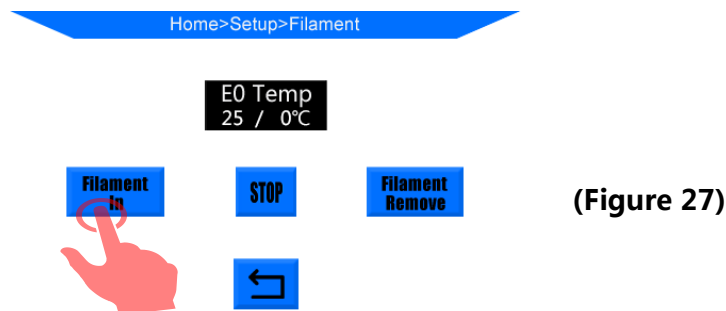

3. Insert the SD card into the SD card slot at the base. On Home Menu, Click "Print" to enter the files list. Click a exist file (e.g. "owl_pair"), and click "Print" (**Fig. 28**). The machine will be sequentially heating the heated bed and nozzle and then print.

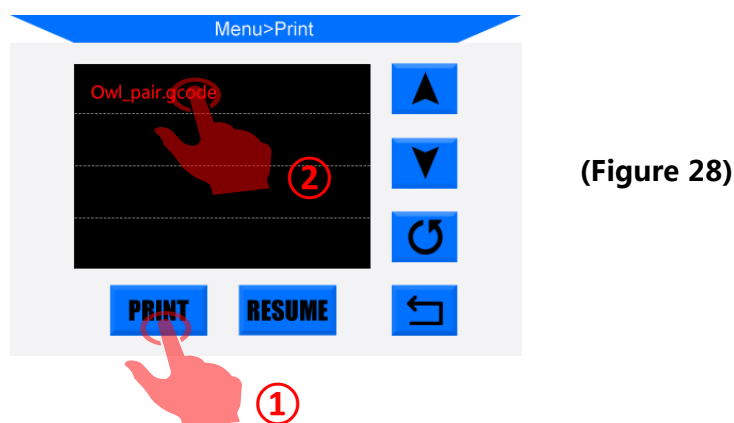

4. Upon finishing, the print head and heated bed will be automatically cooling down. Only remove the printed object from the heated bed when it is cooled completely. Pull the print platform to the front side, and use scraper to carefully remove the object as shown in **Fig. 29**. Never direct scarper to your hands.

- **Please be mindful that the nozzle and heated bed are still hot after operation.**

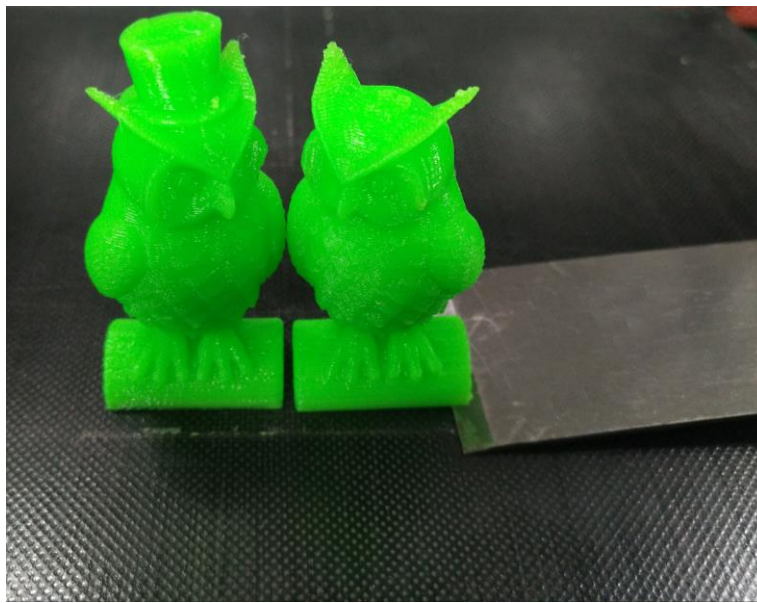

(Figure 29)

5. **ANYCUBIC** Mega 3D printer equipped with **ANYCUBIC** Ultra-base (a novel print platform) which could be used for very long time without adding any masking tape, “hair spray” or glue stick. Customers only have to clean it by alcohol or similar after every few prints.

- **Suggested nozzle (print) temperature for PLA: 190-210°C, ABS: 230-240°C, Bed temperature for PLA: 60°C, ABS: 80-100°C. (it is suggested to disable the model cooling fan for ABS in Advanced settings of Cura)**
- After operation, do not immediately switch off the printer. Only turn it off after the nozzle cools to room temperature, because the heat sink still needs fan for cooling to minimize the risk of nozzle clogging.

7. Manual filament change

1. **Feed the filament:** click via the Home menu: "Tools" --> "Preheat" --> "Preheat PLA (for example)" . After it reaches to the target temperature, press down the handle at the extruder as shown in **Fig. 30**, and manually push the filament through the Teflon tubing till the hotend and there should be filament melt through the nozzle.
 - Make sure the filament passes through the filament sensor first before reaching into the extruder.
 - For easier feed in the filament, it is suggested to cut off the bent tip before insert.
2. **Remove the filament:** at the Home menu, click "Tools" --> "Preheat" --> "Preheat PLA (for example)" . After it reaches to the target temperature, press down the handle at the extruder as shown in **Fig. 30**, manually push in the filament firstly until seeing the filament melt through the nozzle, then quickly draw out the filament. The purpose of pushing in the filament is to minimize the risk of nozzle clogging.

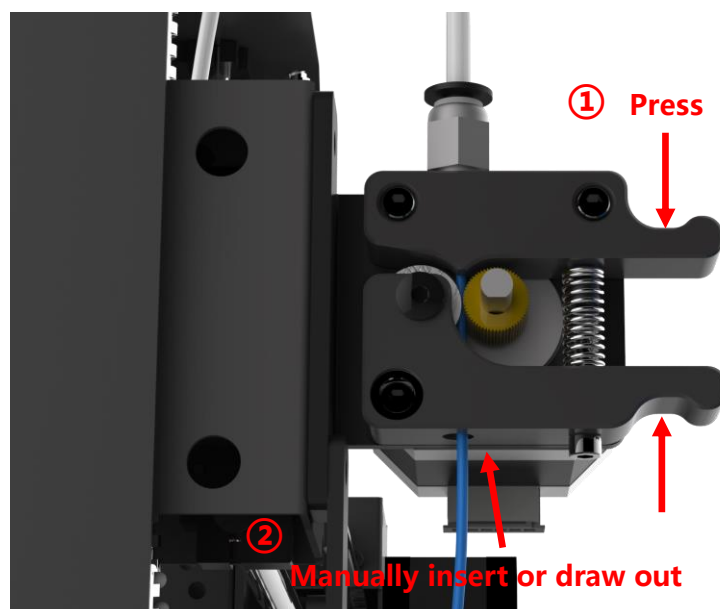

(Figure 30)

8. Resume from outage

ANYCUBIC Mega 3D printer allows resume print job after accidentally power loss.

*This function only valid when print offline (via SD card only).

1. As shown in **Fig. 31**, in slicing software (i.e. Cura), it is required to place the model at the rear of platform. Because during “Resume from outage” , machine will home first and could touch/interfere with the unfinished object if the model was placed in the front area (**Fig. 32**).

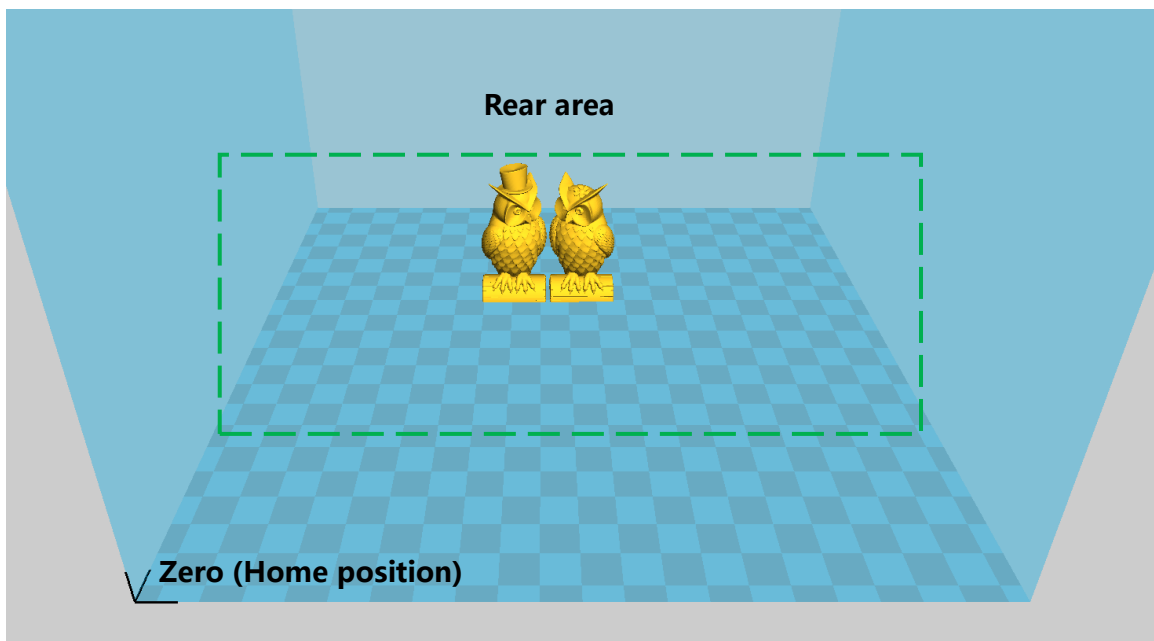

(Figure 31)

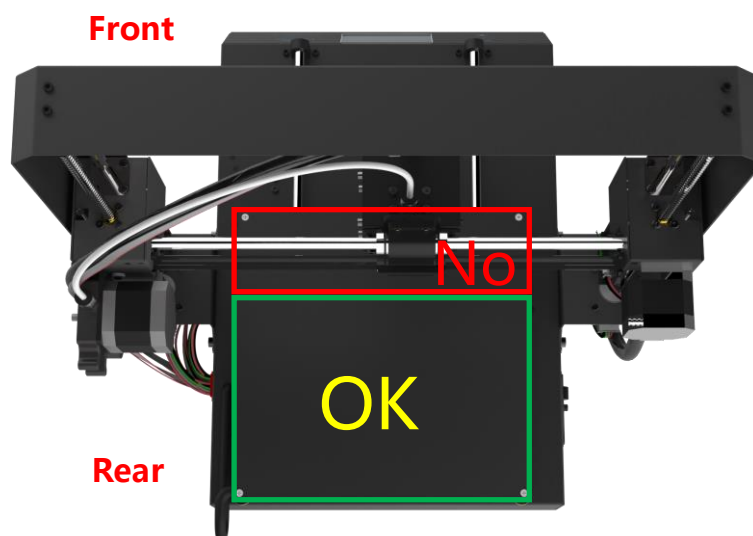

(Figure 32)

- For the first time of using this function, customers are required to add "G5" to the start.gcode, as shown in **Fig. 33**. Then, save the model as Gcode file to the SD card by "File" ---> "Save GCode..." .

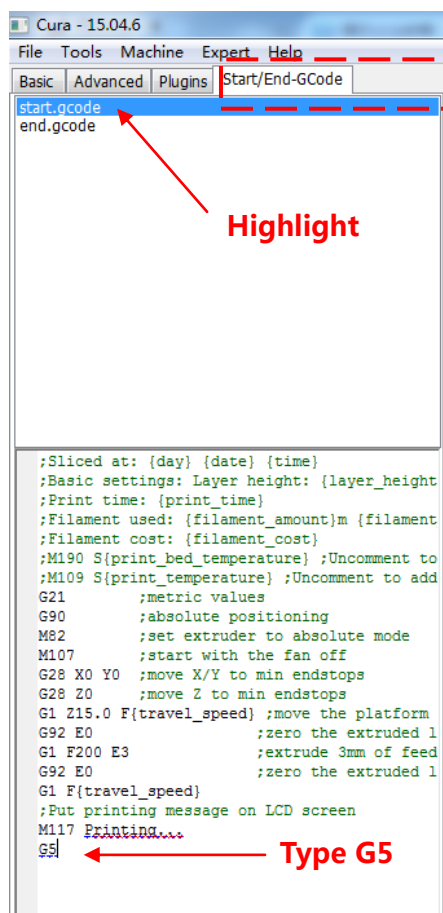

(Figure 33)

- Insert the SD card (back side facing up) into the SD card slot at base. Print the just saved file (i.e. "owl_pair"). The machine will automatically heating on and print. During this printing, if there is an accident power loss, the print will stop immediately. But after power comes back, customers could just choose the unfinished file and click "Resume" (**Fig. 34**). Machine will home first and continuing on the unfinished object.

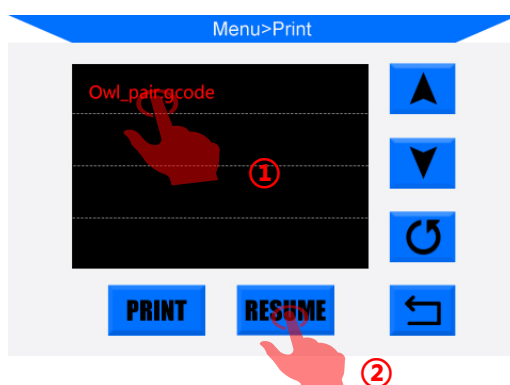

(Figure 34)

Note:

- In order to get smooth surface, use tweezers to carefully remove the excessive filament at nozzle before continuing print upon the last point.
- Do not move Z axis after power off otherwise resume will be invalid.
- **ANYCUBIC** Mega 3D printer supports resume from outage only when print offline
- This function is developed based on Cura. We could not guarantee this function compatible with other slicing software.
- Due to the differences of filaments, temperature, extrusion, etc...we could not guarantee a perfect surface at the point of "Resume from outage" , especially for small object.

9. Trouble shooting

1. Motor shaking or abnormal sound

- ① The corresponding end stop could not be triggered when Home, check the wirings, and inspect any obstacles by manually moving the corresponding axis
- ② The motor cable are not connected properly, check each connection and then inspect the cable routing for any faults

2. File not printing or SD card failure

- ① Remove the SD card and insert into PC. Open the Gcode files using text editor (eg. Notepad), and inspect if Gcode is readable or not. If files contains of multiple "ÿÿÿ" symbol, then file has been corrupted. Try reformatting the SD card to FAT32 format and reloading the Gcode file
- ② SD card is not readable, ensure file name does not contain special characters or Change SD card
- ③ Touch screen freeze, reboot the machine and try again

3. No extrusion or extrusion motor knocking

- ① Ensure that the nozzle temperature has been set to match the filament
- ② Filament tangled on spool
- ③ Not enough cooling for the hotend
- ④ Nozzle clogged please try to replace it or clean it
- ⑤ Teflon tubing has been tangled, squeezed or bent

4. Filament leaking

Nozzle or throat tube is tightened properly, try to fix/change it after cooling

5. No sticking to the bed

- ① Print too fast at the bottom layer speed, reduce it to ~20mm/s
- ② Ensure that the print platform is clean (use alcohol if necessary)

- ③ Check if the bed is proper leveled
- ④ add a brim or raft to the model in slicing software
- ⑤ Check the bed temperature matches the filament

6. Warping/curling of the printed object

- ① Check the bed temperature matches the filament
- ② Check the infill % of the Gcode. The higher the infill, the more likely to warp
- ③ add a brim or raft to the model in slicing software.

7. Layer shifting

- ① Print head moving too fast, slow down the print speed.
- ② Check X/Y belt and the driving wheel and ensure they are properly installed.
- ③ Grease the rods and check all nuts and bolts remain tightened.

8. Freezing screen

- ① Inspect if the touch screen has been pressed by the metal frame at the edge
- ② Check if screen has cracks, if so, please contact us at support@anycubic3d.com

9. T0 sensor abnormal

- ① Check the wiring of the hotend and ensure a good connection
- ② Check if there is any pins bent inside the connector

10. Print head move abnormal

- ① Check if choosing the right machine type in slicing software
- ② Check if any plugins in the slicing software

11. Print stopped halfway

- ① Check if the Gcode file is corrupted
- ② Delete plugins in the Gcode file
- ③ Use print offline mode (SD card) instead of print online via USB