

MAY 29 1950

NBS MONOGRAPH 8

Mercury Barometers and Manometers

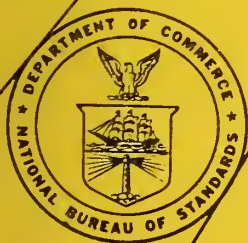

U.S. DEPARTMENT OF COMMERCE
NATIONAL BUREAU OF STANDARDS

THE NATIONAL BUREAU OF STANDARDS

Functions and Activities

The functions of the National Bureau of Standards are set forth in the Act of Congress, March 3, 1901, as amended by Congress in Public Law 619, 1950. These include the development and maintenance of the national standards of measurement and the provision of means and methods for making measurements consistent with these standards; the determination of physical constants and properties of materials; the development of methods and instruments for testing materials, devices, and structures; advisory services to government agencies on scientific and technical problems; invention and development of devices to serve special needs of the Government; and the development of standard practices, codes, and specifications. The work includes basic and applied research, development, engineering, instrumentation, testing, evaluation, calibration services, and various consultation and information services. Research projects are also performed for other government agencies when the work relates to and supplements the basic program of the Bureau or when the Bureau's unique competence is required. The scope of activities is suggested by the listing of divisions and sections on the inside of the back cover.

Publications

The results of the Bureau's work take the form of either actual equipment and devices or published papers. These papers appear either in the Bureau's own series of publications or in the journals of professional and scientific societies. The Bureau itself publishes three periodicals available from the Government Printing Office: The Journal of Research, published in four separate sections, presents complete scientific and technical papers; the Technical News Bulletin presents summary and preliminary reports on work in progress; and Basic Radio Propagation Predictions provides data for determining the best frequencies to use for radio communications throughout the world. There are also five series of nonperiodical publications: Monographs, Applied Mathematics Series, Handbooks, Miscellaneous Publications, and Technical Notes.

Information on the Bureau's publications can be found in NBS Circular 460, Publications of the National Bureau of Standards (\$1.25) and its Supplement (\$1.50), available from the Superintendent of Documents, Government Printing Office, Washington 25, D.C.

UNITED STATES DEPARTMENT OF COMMERCE • Frederick H. Mueller, *Secretary*
NATIONAL BUREAU OF STANDARDS • A. V. Astin, *Director*

Mercury Barometers and Manometers

W. G. Brombacher, D. P. Johnson, and J. L. Cross



National Bureau of Standards Monograph 8

Issued May 20, 1960



Foreword

Preparation of this Monograph on mercury barometers and manometers was undertaken to fill the need of manufacturers and users for information which is now scattered through the literature and in some cases unpublished. This information is primarily on the sources of error and methods for their correction. Moderately extensive tables of corrections for temperature, gravity, capillarity, and other errors are included, mainly for application to portable instruments. The various types of instruments are defined and design features affecting the accuracy discussed in some detail.

The preparation of this monograph is part of the work on pressure standards now in progress in the Mechanics Division, B. L. Wilson, Chief, under the direct supervision of E. C. Lloyd, Chief of the Mechanical Instruments Section.

A. V. ASTIN, *Director.*

Contents

	Page		Page
Foreword.....	III	8. Scale errors.....	22
1. Introduction.....	1	8.1. Zero error.....	22
2. Definitions.....	1	8.2. Methods of test.....	23
3. Principle of measurement and standards.....	2	8.2.1. Fortin barometers.....	24
3.1. Principle of measurement.....	2	8.2.2. Altitude barometers.....	24
3.2. Standard conditions.....	3	8.2.3. Manometers.....	25
3.3. Pressure units.....	3	8.3. Barostat.....	25
4. Properties.....	4	9. Temperature errors.....	26
4.1. Density of mercury.....	4	9.1. Basic formula.....	27
4.2. Vapor pressure of mercury.....	4	9.2. Fortin barometers, U-tube barometers and manometers.....	28
4.3. Surface tension of mercury.....	4	9.2.1. Scale accurate at 0° C.....	28
4.4. Compressibility of mercury.....	5	9.2.2. Fortin barometers, scale accurate at 62° F.....	28
4.5. Purity and composition.....	5	9.2.3. Scale accurate at unknown tem- perature.....	29
4.6. Electrical resistance of mercury.....	6	9.2.4. Scale indicates pressure, instru- ment temperature not 0° C.....	29
5. Types of barometers and manometers.....	6	9.3. Fixed cistern barometers and manometers.....	29
5.1. Fortin barometers.....	6	9.3.1. Scale accurate at 0° C.....	30
5.2. U-tube barometers and manometers.....	7	9.3.2. Scale accurate at unknown tem- perature.....	30
5.3. Fixed cistern barometers and manometers.....	7	9.3.3. Scale indicates pressure, instru- ment temperature not 0° C.....	30
5.4. Standard barometers.....	8	9.3.4. Fixed cistern barometers with an altitude scale.....	31
5.5. Recording mercury barometers.....	8	9.4. Method of test.....	31
5.6. High pressure manometers.....	9	9.5. Temperature correction tables.....	32
5.6.1. Single U-tube high pressure ma- nometers.....	9	10. Gravity errors.....	33
5.6.1. Multiple tube manometers.....	9	10.1. Basic relations.....	33
5.6.3. Ring balance.....	10	10.2. Value of gravity at the instrument loca- tion.....	33
6. Design elements of barometers.....	10	10.3. Variation of gravity error with latitude and elevation.....	34
6.1. Methods of detecting the mercury surface.....	10	10.4. Gravity correction tables.....	34
6.1.1. Sighting on the meniscus by eye.....	10	11. Capillary errors.....	34
6.1.2. Sighting on an index.....	10	11.1. Tube.....	35
6.1.3. Mercury float.....	11	11.2. Cistern.....	35
6.1.4. Sighting with a telescope.....	11	11.3. Correction table.....	36
6.1.5. Photocell detector.....	12	12. Return head and elevation correction.....	36
6.1.6. Capacitance detector.....	13	12.1. Definition of symbols.....	37
6.1.7. Optical reflection detectors.....	13	12.2. Change in gas pressure with elevation.....	37
6.1.8. Interference fringes.....	14	12.3. Return head correction.....	38
6.1.9. Resistance wire.....	14	12.4. Elevation correction, gas head.....	39
6.1.10. Gamma-ray pickup.....	15	12.4.1. U-tube manometers.....	40
6.2. Measurement of mercury column height.....	15	12.4.2. Cistern manometers.....	40
6.2.1. Scale and vernier.....	15	12.4.3. Barometers.....	40
6.2.2. Cathetometer and scale.....	15	12.5. Elevation correction, liquid head.....	40
6.2.3. Precision screw.....	16	13. Vacuum error of barometers.....	41
6.2.4. Gage blocks.....	16	14. Compression of mercury.....	41
6.3. Illumination of the mercury surface.....	16	15. Computation of corrections.....	42
6.4. Vacuum above mercury column.....	17	15.1. Fortin barometer.....	42
6.4.1. Mercury sealed valve.....	17	15.2. Altitude barometer, fixed cistern.....	43
6.4.2. Pump.....	18	15.3. Manometer, U-tube.....	43
6.5. Tubing.....	18	16. Testing at National Bureau of Standards.....	44
6.6. Alinement of scales and sighting devices.....	18	17. References.....	45
6.7. Instrument temperature.....	19		
6.7.1. Measurement of temperature.....	19		
6.7.2. Control of the temperature.....	19		
6.8. Automatic compensation for temperature and gravity error.....	20		
6.9. Damping and lag.....	21		
7. Sources of error.....	21		

Mercury Barometers and Manometers

W. G. Brombacher, D. P. Johnson, and J. L. Cross

The various designs of mercury barometers and manometers are briefly described, with a more extended discussion of the various design elements which may affect the achievable accuracy. Sources of error in measuring pressures are described in considerable detail, particularly for portable instruments, including scale, temperature, gravity, capillarity, vacuum errors and return gas column. Methods of minimizing those errors and of making the corrections, including extensive tables, are presented. Standard conditions are defined and the pertinent properties of mercury given. The paper contains 65 literature references.

1. Introduction

Mercury barometers and manometers are widely used in aeronautics, meteorology, science, and industry. In aeronautics they are used to calibrate a multitude of pressure measuring instruments, including altimeters, rate-of-climb meters, airspeed indicators, manifold pressure gages and Mach meters, many of these instruments demanding continually increasing accuracy [581].¹ In meteorology, mercury barometers are used to measure the atmospheric pressure. In industry and industrial research laboratories barometers are used principally to measure atmospheric pressure, whereas the mercury manometer has a multitude of applications.

The principal objectives in preparing this Monograph are: (a) To outline the inherent errors of mercury barometers and manometers and to provide information and tables for correcting these errors; (b) to briefly describe the variety of design elements of these instruments which are critical

in obtaining precision and accuracy; and (c) in some measure to contribute to national standardization of practices and methods of measuring pressure with mercury columns.

A great deal of the material in this report reflects the experience of the National Bureau of Standards in this field of pressure measurement. However, a number of manufacturers have made substantial contributions to the art.

Present day needs are not only for increased accuracy in pressure measurements, but also for an extension of the range of mercury barometers and manometers. Mercury barometers and manometers up to 10 ft in height are now being required but such instruments are relatively awkward to transport and use. The reading difficulty is in a fair way of being eliminated by the use of the photocell detector coupled with automatic setting of the photocell to the mercury level.

2. Definitions

1. Pressure is the force per unit area exerted by a gas, liquid, or solid.

2. Absolute pressure is the total pressure.

3. Differential pressure is the difference in pressure of a fluid at any two levels or of two fluids at any two levels. The height of a liquid column, corrected to standard conditions, measures the differential pressure existing between the two menisci; when the pressure above one meniscus is zero, the absolute pressure is measured.

4. Gage pressure is differential pressure with respect to atmospheric pressure. Gage pressure plus the atmospheric pressure equals the absolute pressure.

5. Barometers (from *baro*—, weight+*meter*, measure) are instruments for measuring the pressure of the atmosphere. Manometers on the other hand (from *mano*—, thin, rare+*meter*) are instruments for measuring the pressures of gases or vapors. In both instruments the pressure may be balanced against a column of mercury in a tube or against the elastic force of a spring, an elastic diaphragm, or the like, as in an aneroid barometer.

Manometers are frequently used with other liquids than mercury and often are used differentially in a U-tube with one end either open to the atmosphere or to a gas under pressure. One authority [231] considers all manometers to be differential manometers and says, "The barometer as generally understood, is a particular case of a manometer in which one of the two pressures is zero."

Thus, all of the instruments considered here are strictly speaking, manometers, whether used to measure absolute or differential pressure.

In course of application of barometers to other purposes than given above, the definition of barometers has been extended by common consent to include many types of portable manometers which measure absolute pressure. This distinction between barometers and manometers will be followed in view of its convenience.

6. Aneroid barometers are barometers, the pressure sensitive element of which is an evacuated corrugated diaphragm capsule, a metal bellows or a Bourdon tube in contrast to mercury barometers in which the height of a column of mercury is a measure of the pressure.

¹ Figures in brackets indicate the literature references on page 45.

7. U-tube manometers are those which have two tubes the same in bore, commonly having the shape of an elongated U. The U-tube is filled with mercury or other liquid so that two liquid surfaces exist in the tube. The difference in pressure applied to the two liquid surfaces is measured by the difference in height of the two liquid surfaces.

8. U-tube barometers are U-tube manometers in which the pressure on one liquid surface, usually mercury, is maintained at essentially zero pressure, as by evacuating the space above the tube and sealing the tube.

9. Cistern barometers or manometers are those in which the diameter of one mercury column is much larger than the other to provide a reservoir which is usually called a cistern. A single scale mounted along the side of the tube is used to measure the height of the mercury column. There are many forms of cistern barometers, some of which have reasonably well accepted names, as indicated below.

(a) Fortin barometers are cistern barometers in which the height of the mercury surface in the cistern can be adjusted by eye to the level of a fixed index, which insures a fixed zero reference for the scale. These barometers are primarily used to measure atmospheric or ambient absolute pressure.

(b) Fixed cistern barometers usually have a single scale ruled so as to compensate for the change in zero position due to the rise and fall of the mercury in the cistern with change in pressure.

(c) Fixed cistern barometers often are designed to measure only ambient pressure in which case the space above the mercury in the cistern is not gas tight. The Kew barometer, developed in England and the Tonnelot, developed in France, are of this type.

10. Altitude barometers are fixed cistern or U-tube barometers in which the design is such that the absolute pressure in closed systems can be measured. For this purpose the cistern of cistern barometers is entirely sealed except for a connecting nipple. The U-tube barometer needs only a suitable nipple. Altitude barometers of the fixed cistern type, when used to calibrate altimeters, may sometimes have a scale calibrated in altitude

units corresponding to the altitude pressure relation of a standard atmosphere, in addition to a pressure scale.

11. Standard, sometimes called normal, barometers strictly speaking are barometers of the highest precision and accuracy. More loosely they are barometers used to calibrate other barometers, to be suitable for which their errors must be known, and their precision and accuracy should be superior to that of the barometers to be tested.

12. The sign of an error in indication of an instrument is determined by the relation

$$E = R - T$$

and of a correction by

$$C = T - R$$

where E is the error; R , the reading; T , the true value; and C is the correction. It follows that

$$E = -C.$$

13. Scale error is the error in the reading of a barometer or manometer caused by errors in graduation of the scale and vernier. Practically for portable barometers it is the residual error remaining after corrections normally made are applied for other errors.

14. Zero error is the error in reading of a barometer or manometer when the differential pressure applied to the two liquid surfaces is zero.

15. Correction for temperature is the correction required to reduce the reading of the barometer or manometer to a reading corresponding to the density of mercury and the length of the scale at selected standard temperatures. See section 3.2 for the selected standard temperatures.

16. Correction for gravity is the correction required to reduce the reading of the barometer or manometer to a reading corresponding to a selected standard gravity, discussed in section 3.2.

17. Capillary error is the amount that a mercury meniscus is depressed below the height corresponding to the applied differential pressure of which the primary cause is the surface tension of mercury.

3. Principle of Measurement and Standards

3.1. Principle of Measurement

In measuring pressure by the height of a liquid column, the weight (not mass) of a column of unit area numerically equals the pressure difference. For a liquid column in which the upper surface is subjected to a vacuum, the fundamental relation for the pressure it exerts is

$$P = \rho gh \quad (1)$$

where

P is the absolute pressure in dynes per square centimeter or poundals per square inch at the lower liquid surface, if

ρ is the density of the liquid in g/cm^3 or lb/in.^3 ;

g is the acceleration of gravity in cm/sec^2 or in./sec^2 ; and

h is the height of the liquid column in centimeters or inches.

If the pressure is desired at some other point in the system differing in elevation from the lower liquid surface, correction must be made for the weight of the intervening column of gas or liquid. (See sec. 12). For manometers which measure either the differential or gage pressure, the fundamental relation is similar to eq (1)

$$p = P_2 - P_1 = \rho gh \quad (2)$$

where

p = differential or gage pressure in dynes per square centimeter or poundals per square inch.

P_1 and P_2 = the absolute pressures at the upper and lower liquid surfaces of the manometer. The other terms have been defined.

Strictly speaking, the differential pressure defined in eq (2) is the difference between the pressures impressed upon the upper and lower liquid surfaces. At some other elevation or level, correction must be made for the weight of the intervening column of gas or liquid (see sec. 12).

For both eq (1) and (2) $\rho gh/g_s$ is the pressure expressed in grams per square centimeter or in pounds per square inch where g_s is standard gravity, 980.665 cm/sec² or 386.088 in./sec²;

$$P \text{ or } p = \frac{\rho gh}{g_s} \quad (1.1)$$

3.2. Standard Conditions

In many cases the height of the liquid column is taken as a measure of the pressure, then

$$h = \frac{P}{\rho g} \text{ or } \frac{p}{\rho g} \quad (1)$$

Since both ρ and g are only approximately constant, some ambient condition must be selected as standard so that this pressure unit bears a fixed relation to the metric or English unit pressure.

The density of mercury at any one pressure is fixed by its temperature, hence it is general practice to use the density of mercury at 0° C subjected to a pressure of 1 atm. Since measurements are rarely made at 0° C, readings generally require correction for deviation from 0° C. these are discussed in section 9.

The height of mercury columns as a measure of pressure has been based for many years on a value of the acceleration of gravity of 980.665 cm/sec² (32.1740 ft/sec²) by physicists and engineers [011]. While this value was selected because it was believed to be the value at 45 deg lat, there is little merit in tying a pressure standard to a latitude, and uniform acceptance of a value is of greater importance. Meteorologists have varied in their choice from time to time, using 980.62 cm/sec² up to 1953, when the International Meteorological Organization also adopted 980.665

cm/sec² for this purpose [533, 534, and 556]. Corrections are usually necessary for deviation of ambient gravity from the standard value, which are discussed in section 10.

Mercury manometers and barometers are often calibrated to indicate the height of the mercury column in terms of mercury at 0° C, when the instrument is at another temperature, for example, 20° C, 25° C, 62° F, or 100° F.

3.3. Pressure Units

In cgs units the fundamental pressure unit is the dyne/cm². By definition, 1 bar = 10⁶ dyne/cm², and accordingly the convenient unit, 1 mb = 1,000 dynes/cm².

In English units, the primary pressure unit is the poundal per square foot, but the practical unit is the pound per square inch (psi).

Another unit is the pressure of one atmosphere defined for fixed points on the International Temperature Scale as 1013.250 mb [493]. This definition provides for stability in the definition of the pressure unit in atmospheres. This pressure is equivalent to that exerted by a column of mercury 760 mm high, having a density of 13.5951 g/cm³ and subject to a gravitational acceleration of 980.665 cm/sec². The value of 13.5951 g/cm³ was taken for the density of mercury at 0° C; it differs only slightly from the value reported in a recent determination at the National Physical Laboratory [571], also table 4.

Note that owing to the slight compressibility of mercury under its own weight, multiples or submultiples of 760 mm of mercury do not precisely correspond to the same multiples or submultiples of 1013.250 mb. Except for very precise pressure measurements, this difference is neglected.

Conversion factors for a number of commonly used pressure units are given in table 1. The conversion factors for centimeters and inches of water are based on a value of the density of water at 20° C of 0.998207 g/cm. For values of the primary units involved in computing table 1 (see ref. [551]), except for the value of the pound in terms of the kilogram and the inch in terms of the centimeter. Changes in the conversion factors have recently been adopted, retaining as standard the mass of 1 kg and the length of 1 cm. The change is 2 parts per million in the length of the inch (shorter) and 2 parts per 15 million in the pound (smaller). Most of the table is also accurate for the obsolete units.

The units, gram per square centimeter, pound per square inch, etc., involve a force of 1g or of 1 lb. This force is a mass of 1 g or 1 lb. subjected to the standard value of gravity, 980.665 cm/sec² or its equivalent, where required.

Other units often used are: (a) barye = 1 dyne/cm² (b) micron = 0.001 mm of mercury; (c) tor (or torr) = 1/760 of 1 atm, closely, 1 mm of mercury; pieze (French) = 10 mb.

4. Properties of Mercury

Only the properties of mercury of importance in manometry will be discussed. The melting point is -38.9°C and the boiling point at 1 atm, about 357°C . For general information on mercury see ref. [421, 522, and 574].

4.1. Density of Mercury

A redetermination of the density of mercury is in progress at the National Physical Laboratory; the density by one method of measurement [571] is 13.5458924 g/cm^3 at 20°C under a pressure of 1 atm. This value reduces to 13.5950889 g/cm^3 at 0°C , a value not significantly different from that generally accepted, 13.5951 g/cm^3 .

Based on the value for the density of mercury at 0°C , the density at other temperatures is obtained from the relations:

$$V = V_0 (1 + 0.0001818 t), \quad t \text{ in } ^{\circ}\text{C} \quad (4)$$

$$V = V_0 (1 + 0.0001010 (t - 32)), \quad t \text{ in } ^{\circ}\text{F} \quad (5)$$

$$\rho = \frac{1}{V} \quad (6)$$

where V , V_0 = specific volume at temperature t and at 0°C

ρ = the density.

Equations (4) and (5) apply primarily when mercury is subjected to a pressure of 1 atm. Practically they are useful up to the point where the compression of mercury becomes significant, certainly up to at least 1 atm.

The value of the coefficient of cubical expansion $m = 1,818 \times 10^{-7}$ per $^{\circ}\text{C}$ is a sufficiently accurate approximation which is widely used, and standard for most purposes. More accurate values, based upon the relation,

$$m \times 10^8 = 18144.01 + 0.7016t + 0.0028625t^2 + 0.000002617t^3$$

are given in ref. [413], where t is the temperature in $^{\circ}\text{C}$, from 0° to 350°C . The exact mean values of $m = (V_t - V_0)/V_0 t$ are given below for a few temperatures; for a more extended table see table 10 of ref. [413].

The value of the density of mercury at temperatures above 0°C is less than the true value when computed using $m = 1,818 \times 10^{-7}$. It is seen that for room temperatures, the approximate value m is sufficiently accurate for use in manometry in all but the most precise work.

The ratio of the density of mercury at $t^{\circ}\text{C}$ to that at 0°C are presented in table 2. These are taken from table 12 of ref. [413] and are based

Temperature	True coefficient	Error in density using eq (4)
$^{\circ}\text{C}$	$m \times 10^8$	Parts per million
0	18,144	0
10	18,151	2.9
20	18,159	4.2
30	18,168	3.6
40	18,177	1.2
50	18,187	3.5

upon the precise value of the coefficient of expansion, not the average value $1,818 \times 10^{-7}$ per $^{\circ}\text{C}$.

Values of the density of mercury are given in tables 3 and 4 for various temperatures. These are based upon the ratios given in table 2; in table 3 upon the value of 13.5951 g/cm^3 at 20°C , all when the mercury is under a pressure of 1 atm. The density in g/cm^3 is given in table 3A, and in lb/in.^3 in table 3B. In table 3B the recently adopted values for the inch and the pound given in table 1 were used to obtain the density in lb/in.^3 ; these densities are 5.9 parts per million smaller than those based upon the previous values.

Tables of the specific volume of mercury at various temperatures and of the true temperature coefficient of mercury, $dV/V_0 dt$, are given in ref. [413].

4.2 Vapor Pressure of Mercury

The vapor pressure of mercury is given in table 3A, computed from the equation

$$\log P = 11.0372 - \frac{3,204}{T}$$

where P is the vapor pressure in microns of mercury; and T is the absolute temperature in $^{\circ}\text{K}$. This is an empirical equation derived by Ernberger and Pitman [558] to fit the data of previous investigators and fits their experimental values within 1 percent in the temperature range 12° to 53°C . These values agree closely with the computed values given in ref. [516] and are about 2 percent lower than the computed values in ref. [535]. The vapor pressures given in the International Critical Tables and in ref. [531] are about 10 percent lower, and those in ref. [414], still lower. See ref. [471] for data at temperatures higher than listed in table 3A and for references to earlier original work.

4.3. Surface Tension of Mercury

The best value for the surface tension of mercury [461] and [494] is 484 at 25°C , 479 at 50°C , and 474.5 dynes/cm. at 75°C . This refers to mercury in a vacuum. For mercury in contact with air no valid data appears to exist [494] but is expected

to be somewhat less than for a vacuum. Impurities and particularly oxidation will affect the surface tension of mercury, probably lower it, but the amount of change is speculative. See section 11 for a more detailed discussion.

4.4. Compressibility of Mercury

The decrease in volume, ΔV , per unit volume of mercury with increasing pressure P in bars at 25° C is [121, 542]:

$$\Delta V = 4.0391 \times 10^{-6} P - 0.7817 \times 10^{-10} P^2 + 0.191 \times 10^{-14} P^3. \quad (7)$$

For most manometer applications the approximate relation given below is satisfactory:

$$\Delta V = aP - bP^2 \quad (8)$$

where

$$a = 4.04 \times 10^{-6}, \quad b = 0.78 \times 10^{-10} \text{ for } P \text{ in bars}$$

$$a = 4.09 \times 10^{-6}, \quad b = 0.80 \times 10^{-10} \text{ for } P \text{ in atmospheres}$$

$$a = 5.38 \times 10^{-9}, \quad b = 0.81 \times 10^{-16} \text{ for } P \text{ in millimeters of mercury}$$

$$a = 137 \times 10^{-9}, \quad b = 89 \times 10^{-15} \text{ for } P \text{ in inches of mercury}$$

Computations based on eq (8) follow:

Pressure bars	Decrease in unit volume	Density of mercury
0	0	g/cm^3 13.59505
1	4.04×10^{-6}	13.5951
10	40.4×10^{-6}	13.59565
100	40.3×10^{-6}	13.60058
1,000	$3,960 \times 10^{-6}$	13.6478

It follows that for pressures below 10 atm the last term in eq (8) can usually be neglected, and

$$\Delta V = aP \quad (9)$$

or

$$V = (1 - aP)V_0 \quad (10)$$

and

$$\rho = \frac{\rho_0}{1 - aP} = \rho_0(1 + aP), \quad (11)$$

where a is a constant with values given above for various units of pressure: V is the volume at unit pressure P ; ρ_0 , ρ are respectively the density of mercury at zero pressure and at P .

C. H. Meyers at the National Bureau of Standards, based on Bridgman's data, arrived at the following values for constant a in eq (11), to cover the pressure range up to 1,000 in. of mercury: $a = 1.36 \times 10^{-7}$ for P in in. of mercury, and $a = 5.36 \times 10^{-9}$ for P in mm of mercury. These data are unpublished.

4.5. Purity and Composition

The possible variation of isotopic composition of mercury from various sources and subject to various processes, primarily distillation, affects the density and is therefore important in precise manometry. Estimates based upon some data indicate that the variation in the density of mercury will not exceed one part in 30,000 due to extreme variation in isotopic composition. However, exact data on isotopic composition of mercury secured from different sources or subjected to various procedures in distilling are lacking to a large extent. See ref. [571] for a review of the present situation.

The effect and methods of removal of impurities are of particular interest. All but traces of metals dissolved in mercury can be removed by a procedure of distillation [574]. Methods of testing for purity of mercury are discussed in ref. [571], which indicate that with isotope tracers one part in 10^8 of base metals can be detected. Very small quantities of base metals which form an amalgam with mercury, rise to the surface and are easily detected by the surface contamination.

Air is not absorbed by mercury, as is indicated by the fact that barometers have maintained a good vacuum above the mercury column for years. However, air bubbles may be trapped in the mercury, and should be removed, usually accomplished by subjecting the instrument to several pressure cycles while jarring the instrument sharply.

Water trapped in mercury can only be removed by subjecting the mercury to a temperature above 100° C. Water in a barometer is particularly troublesome since a satisfactory vacuum cannot be obtained above the mercury column.

In general, mercury compounds are formed as a result of contact of air and other gases with the mercury surface, and remain there. Gases containing sulfur are particularly active in forming such compounds. Detection of such compounds, even in small amounts is simple; accurate observations on the mercury surface become difficult or impossible.

On procedures for cleaning mercury, see refs. [531, 561, 571, 574, 591].

Experience indicates that mercury remains free from contamination when stored in bottles of soft glass, at least more so than in containers of other materials on which extended experience is available.

4.6. Electrical Resistance of Mercury

The electrical resistivity K of mercury is:

$$K = \frac{SR}{l} \quad (12)$$

where R is the resistance, l the length of the column

5. Types of Barometers and Manometers

Barometers and manometers are basically simple instruments where the primary measurement to be made is the height of the mercury column. Other measurements must be made also in order to convert the indicated height of the mercury column to accepted or standard pressure units.

Many factors must be considered in the design of a barometer or manometer such as portability, range, accuracy, convenience and degree of automation in making readings, and usefulness for the application. As a result many designs have been evolved. The principal designs will be only briefly considered, since the emphasis here is on performance rather than design. The descriptions in this section will be augmented in the next section by some design details of the means which are used to meet problems more or less common to all barometers and manometers.

The essential features and components of a first class barometer are indicated in figure 1. Alternatives for detecting the position of the mercury surface and for measuring the column height are indicated; these and the other components will be discussed in this and the succeeding section. When the accuracy required is not high, some of the

components or accessories can be and are omitted, but for highest accuracy the function of all is significant and where selection is possible, those producing the greater accuracy must be chosen.

At 0°C , $K=94.07$ and at 100°C , $K=103.25$ $\mu\text{ohm-cm}$ [531]. These values are for a pressure of 1 atm and they decrease measurably as the pressure increases [191].

components or accessories can be and are omitted, but for highest accuracy the function of all is significant and where selection is possible, those producing the greater accuracy must be chosen.

There are a large number of clever schemes for amplifying the indicated height of a mercury column, particularly in measuring small differential pressures. The precision of reading is thereby increased, also the accuracy, but not to the same degree as the precision. Most of the schemes require some extra manipulation. The devices described in ref. [453, 513], are exceptions in that they are automatic in operation. Another device, not automatic but easily made so, is described in ref. [483]. See also ref. [391] for descriptions of a number of designs. These devices all come under the general head of micromanometers, which include mechanical devices also; detailed consideration of these is in general outside of the scope of this report.

5.1. Fortin Barometers

The Fortin barometer is one of the oldest forms of commercial barometers, having been used for measuring atmospheric pressure by meteorological services for about 100 years [301]. The barometer tube is surrounded, except for reading slits, by metal tubes one fixed to the cistern assembly and another short one, movable up and down within the first. The movable tube carries the vernier and ring used for sighting on the mercury meniscus. The fixed tube has the pressure scale, usually plated brass, adjustably attached to it.

The cistern has an index fixed to its top wall, usually a thin ivory or bone rod, tapering to a point at the lower end. The cistern is essentially a leather bag which can be raised or lowered by a metal plate at the end of a screw, which can be turned by hand at the bottom of the cistern.

To take a reading the mercury in the cistern is brought up until it is just in contact with the index, thus bringing the mercury surface into alinement with the zero of the scale. Valid readings are made only when the mercury level in the cistern is so adjusted. Since the lower end of the scale does not extend to the cistern, the distance from the cistern mercury surface to a point on the graduated scale must be determined, usually by comparing at the same pressure the reading of the Fortin barometer with that of a standard barometer.

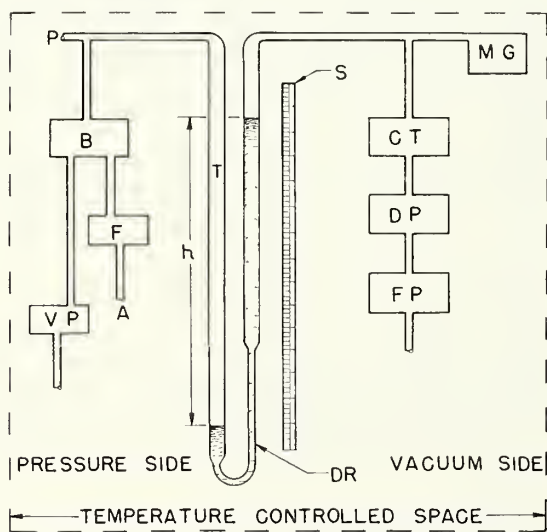

FIGURE 1. Principal elements of a precise laboratory barometer system.

T , barometer tube; DR , restriction in tube bore for damping; S , scale, or precision screw plus controls, or gage blocks; sighting device, not shown, either telescope, photocell or other optical devices; MG , McLeod or other vacuum gage; CT , liquid air trap; DP , diffusion pump; FP , forepump; F , filter; B , barostat; A , air supply; VP , vacuum pump; and P , line to point where pressure is to be measured.

The Fortin barometer can be used only to measure ambient pressure and is widely used by meteorological services and in laboratories to measure atmospheric pressure. Pressure equilibrium with the ambient gas is obtained in the cistern by a vent at its top or through the chamois seal above the mercury.

The most common range of the Fortin barometer is 28 to 31 in. of mercury (about 950 to 1,050 mb; about 710 to 790 mm of mercury). For use at stations well above sea level, barometers with ranges extending from 20 to 31 in. of mercury have been built. With no great trouble the range could be from 4 to 5 in. of mercury upward to any value within reason, but in practice it is tailored to the range of pressures expected at its location.

The quality of Fortin barometers is measured practically by the bore of the tubing used, which in large measure also determines the diameter of the cistern. Fortin barometers are commonly made in this country with tubing either 0.25, 0.6 or 0.8 in. bores. For modest accuracy measurements, which is for the most laboratory requirements the irreducible limit, the tubing bore is 0.25 in. (6.35 mm). For the highest accuracy reasonably attainable with Fortin barometers, the tubing bore is about 0.8 in. (20.3 mm). The slight increase in accuracy obtained with the 0.8 in. bore is balanced by the greater degree of portability of the 0.6 in. bore barometer.

The Fortin barometer is designed to be safely portable in the upside down position. Before slowly tipping it over, the cistern mercury level control is operated to force mercury up the tube until the cistern is nearly filled. Thus splashing of the mercury is practically eliminated and the vacuum in the tube preserved. See [591] for detailed instructions.

5.2. U-tube Barometers and Manometers

In its simplest form the U-tube barometer or manometer consists of a U-tube containing mercury and a scale between the legs of the U for reading the position of the two mercury surfaces. If precision bore tubing is used, reading the position of the mercury surface in one leg may be sufficient. In manometers the pressure to be measured is applied to one leg and the other leg left open to the atmosphere if gage pressure is to be measured, or connected to the reference pressure if differential pressure is to be measured. In barometers the space above the mercury surface in one leg is evacuated.

The above described design of U-tube manometer is widely used; of barometers, less so. The described reading means are crude so that both the precision and accuracy are low. A big step in improving the accuracy is to add a vernier and a means for sighting on the mercury surfaces. This and other reading means are discussed more fully in sec. 6.

In order to reduce the error due to the capillary depression in fixed cistern barometers, discussed in a later section, barometers of the highest precision and accuracy are of the U-tube type. Diverse reading means and additional accessories are used as discussed in sec. 6.

U-tube manometers are used conveniently to measure gage pressures up to about 50 psi (about 3 to 3½ atm); for this range the mercury column is about 10 ft (3 m) high. Manometers for measuring differential pressures at high pressures are discussed below in section 5.5. Manometers may be used to measure absolute pressures if the space above one mercury surface is evacuated.

5.3. Fixed Cistern Barometers and Manometers

Mercury barometers in which the mercury level in the cistern cannot be adjusted during the reading process are called fixed cistern barometers. Here the barometer tube extends below the surface of the mercury in a cistern of much larger cross section than the tube so that the rise and fall of mercury level is small, but not negligible, in comparison to that in the tube. The larger the cross section of the cistern, within limits, the less the zero shift due to change in the meniscus height of the cistern mercury.

To compensate for the rise and fall of the mercury level in the cistern with pressure, the scale graduations are foreshortened, that is 1 mm differences in reading on the scale are less than 1 mm apart. Thus

$$D = \frac{AR}{A+a} \quad (13)$$

where

D = the distance between two graduations

R = the indicated interval between two graduations

A = the cross sectional area of the mercury in the cistern

a = the internal cross sectional area of the tube.

In practical designs D/R will vary from about 0.97 to 0.985.

In fixed cistern barometers used to measure only ambient atmospheric pressure, the cistern is vented to the atmosphere. This form of barometer, heavily damped by a restriction in the tube bore, is commonly used on shipboard by the meteorological services of the world, but is being superseded gradually by aneroid barometers because they are less sensitive to acceleration. In Great Britain the fixed cistern barometer of this type is called a Kew pattern barometer and is the type chiefly used by the British Meteorological Office. A French design which has had, and probably still has, some application is known as the Tonnelot barometer. The chief virtue of the Tonnelot barometer is that an adjustment is provided for reducing the cistern volume, as in the Fortin, so that the tube and cistern can both be completely filled with mercury to obtain safe portability.

The fixed cistern barometer lends itself to securing a leak tight cistern so that gas pressures in a closed system can be measured. It has been and is widely used as a working standard for calibrating altimeters and aneroid barometers. For such use the cistern is made airtight except for a nipple, to which a chamber or instruments themselves are connected by tubing. Pressure control means are connected to the system.

In earlier designs the cistern and barometer tube were made coaxial. However, as lower and lower absolute pressures have had to be measured, it has been found necessary to have an offset cistern so that readings can be made down to zero pressure. Obviously, fixed cistern manometers have also necessarily had to have offset cisterns if differential pressures below about 3 in. of mercury were to be measured. Reasonable accuracy is difficult to attain at pressures below about 1 mm of mercury in designs having a range to an atmosphere and above from either the cistern or U-tube instruments. Measurements of absolute pressures below 1 mm of mercury are in the realm of vacuum measurement which is outside of the scope of this report.

Fixed cistern barometers have generally been constructed to measure pressures below about 1 atm. Barometers have been built to have a range up to 2 or $2\frac{1}{2}$ atm, but these instruments are bulky and unwieldy to transport.

The scale is usually graduated in pressure units but often has an added altitude scale based upon the altitude-pressure relation of the standard atmosphere. A vernier sensitivity as low as 0.05 mm of mercury (0.002 in.) is sometimes provided with the idea of realizing this accuracy. However, the accuracy of a fixed cistern barometer is limited by uncertainty in surface tension effects in the cistern to at least 0.1 mm of mercury, as discussed in sec. 11.

5.4. Standard Barometers

A primary or standard barometer may be defined as a barometer which measures absolute pressures with precision, and requires no comparison test with another barometer to determine its errors. Perhaps, and preferably, a standard barometer is an instrument which measures absolute pressure with an accuracy greater than that of the barometer or pressure gage under test. A better term in many cases is working or secondary standard. Under the latter definition a calibrated Fortin barometer with a tube bore of 0.6 in. is a suitable standard for testing Fortin barometers with a tube bore less than about 0.4 in. Also a fixed cistern barometer when used to calibrate altimeters and aneroid barometers is a standard barometer.

Discussion here will be limited to standard barometers the calibration of which is made in terms of the basic standards of mass, length, and time and thus require no calibration by compari-

son with another barometer. Highly precise and accurate barometers or manometers have been constructed at the National Physical Laboratory [333, 552], Massachusetts Institute of Technology [412], International Bureau of Weights and Measures [592], and the National Bureau of Standards [545, 553]. In these a great deal of attention has been given to the reduction insofar as possible, of all sources of error and uncertainty in order to obtain an accuracy of at least 0.001 mm of mercury. Convenience in making readings, however, has had to be sacrificed to accuracy.

The National Physical Laboratory standard barometer [333] has also been constructed, with some modifications to extend its pressure range, by the South African National Physical Laboratory [557]. The Physikalisch-Technischen Bundesanstalt, Braunschweig, also has constructed a standard barometer with an accuracy of 0.005 mm of mercury [576] (see sec. 6.1.2).

All of the above instruments are of the U-tube type; other design details will be discussed in sec. 6.

A standard barometer constructed at the University of Helsinki [554], has an estimated accuracy of 0.01 mm of mercury.

For calibrating portable barometers the National Bureau of Standards has another standard barometer of the U-tube type which can be read to 0.01 mm of mercury, and has an accuracy of 0.02 to 0.03 mm of mercury. This accuracy is sufficient for most portable barometers submitted, but improvements to increase accuracy are inevitably becoming necessary as requirements for portable barometers become stringent. This barometer is briefly described in reference [491], but many of the design features will be touched upon in sec. 6.

5.5. Recording Mercury Barometers

A number of designs for recording atmospheric pressure based upon the mercury barometer were developed in the period around 1900 [301]. These never came into general use, in view of the greater convenience and portability of the barograph based upon aneroid capsules, particularly since the latter proved adequate in performance for meteorologists. Principally, the primary designs were based upon: (a) The rise and fall of a float in the mercury of the barometer cistern; and (b) the use of a beam balance to weigh either the barometer tube or cistern which varies approximately as the atmospheric pressure.

For relatively rough measurements, the height of a mercury column has been recorded by recording the change in resistance or voltage of a fine wire extending through the mercury column. The resistance or voltage drop varies regularly as the length of wire immersed in the mercury column changes and thus is a measure of the pressure. (See ref [532] and sec. 6.1.6.)

A record can be obtained of the height of a mercury column if the position of a photocell is

governed by a precision screw or other means. Since power is available to drive the screw, its angular deflection can be recorded by various means. One such recorder is described by Haynes [511] for obtaining a record of the calibration of the baroswitches of radiosondes.

5.6. High-Pressure Manometers

Mercury amalgamates with steel at high pressures, causing the failure of steel vessels containing mercury, more likely in the case of hardened than soft steel. Experiments [496] indicate that ultimate failure of steel tubes will occur at pressures in the range 4,000 to 6,000 atm. No data are available on stainless steels.

For practical reasons high pressure mercury manometers have generally been limited to about 60 ft, giving a pressure range of about 24 atm (360 psi). To obtain higher pressures, two designs are available. The first, practically useful only to calibrate piston gages, consists of a single U-tube and requires in addition two piston gages in order to transfer the measurements as the mercury column is subjected to steps of absolute pressure to the ultimate range desired, which may be many times the differential pressure measurable with the U-tube manometer. See the next section for additional details.

The second design is the multiple manometer consisting of a series of U-tube mercury columns, with the low pressure side of one mercury column connected to the high pressure side of the next mercury column. (See sec. 5.6.2.)

For measuring small differential pressures at high pressure a ring balance has had some application. (See sec. 5.6.3.)

5.6.1. Single U-tube High Pressure Manometers

Keyes and Dewey [271], Michels [321], and Bett, Hayes, and Hewitt [541] have constructed single U-tube mercury manometers for measuring differential pressures at high pressure. All were primarily used to calibrate piston gages. The essential features of the Bett et al., manometer are typical and will be described.

The manometer is about 30 ft high, with the tubes water jacketed to maintain them at constant temperature. The two mercury surfaces are detected by fixed electrical contacts, requiring adjustment of both the pressure and volume of mercury in the system to obtain a valid reading. Keyes and Dewey also used electrical contacts to detect the mercury surfaces, but made them vertically movable with means to measure the movement. An invar tape is used to measure the differential in height between the electrical contacts, which is necessary since compression effects can be expected to change this distance as the absolute pressure is increased. Elaborate provision is made for transferring the position of the electrical contacts horizontally to the measuring tape.

The manometer can be used to calibrate piston gages at pressure steps equal to its differential pressure range. Two piston gages are required. These, installed at levels between the mercury surfaces, are connected to the manometer, alternately to the lower and higher pressure leg of the manometer at each pressure step. The connecting lines are filled with a petroleum derivative which has relatively good viscosity characteristics at high pressure. Valves are provided to connect the piston gages to either leg of manometer, as desired.

In operation, the pressure difference of each step is determined from a knowledge of the height of the mercury column, of necessity corrected to standard temperature and gravity, and corrected for compressibility of the mercury. This pressure difference must be transferred to the piston of the piston gages, which requires a knowledge of the difference in elevation between the mercury surface and the piston, and of the density and compressibility of the transmitting liquid. To obtain pressure continuity so that the total pressure on the piston gages can be determined, a reference pressure must be established in passing from one pressure step to the next. This is done by a pressure balance on one piston gage when connected to the lower leg of the manometer (high pressure) and then, without changing the weights, connecting it to the upper leg of the manometer (low pressure). The pressure in the low pressure side of the manometer is then adjusted so the reference piston is in balance. Except for some small relatively constant corrections involving the transfer liquid column, the pressure continuity is preserved.

It is obvious that the sum of the differential pressures (plus atmospheric pressure) equals the total pressure. From the weight balancing the pressures acting on the pistons at each step, the effective area of the piston can be computed.

It is of interest to note that Bett and his co-workers plan to calibrate piston gages to 2,000 bars (nearly 2,000 atm, 30,000 psi) involving 175 transfers. Keyes and Dewey had a manometer about 28 ft high and calibrated piston gages to nearly 600 atm (about 9,000 psi). Michels avoided the labor of the continuous step-by-step process and used his manometer to calibrate piston gages against differential pressure only at selected absolute pressures, known only approximately.

An elaborate discussion of the sources and amounts of the errors in high pressure U-tube manometers is given by Bett et al. [541].

5.6.2. Multiple Tube Manometers

Multiple tube manometers have been extensively developed for use in measuring pressure in physical experiments by Meyers and Jessup [311] and Roebuck and his coworkers Crain, Miller, and Ibsen [371, 544]. The manometer of Jessup and Meyers, using glass tubes, had a range of 1,000 psi while that of Roebuck went to 3,000 psi (200 atm).

The Roebuck manometer will be briefly described. The instrument has U-tubes connected in series so as to secure nine mercury columns. The transmitting liquid from the top of one mercury column to the bottom of the next was toluene. The tubes were of steel, $\frac{1}{16}$ in. in bore, about 1,746 cm (57 ft) high. Electrical contacts were first used to detect the position of the mercury surfaces, and later advantageously changed to a sighting device by using a section of transparent material in the tubes. Invar measuring tubes were used to measure the column heights. Many accessories were required to meet problems, notably a barostat, for details of which see ref. [544].

The differential pressure between the two terminal mercury surfaces is simply the sum of the heights of the individual mercury columns (here nine) times the difference in the densities of mercury and the transmitting liquid. Obviously the liquid column heights must be individually reduced to standard conditions which involves applying corrections for deviations from standard temperature and for compressibility of the two liquids. Further correction is needed if the pressure is desired at a level differing from that of the lower mercury surface.

The ring balance has been applied to measuring small pressure differences at high pressure [361]. This is a torus or hollow doughnut of small cross section. At the top, the two sides of the hollow space are sealed from each other; sufficient mercury is placed in the hollow to seal off each side from the other. The gas at a slightly different pressure is fed to each compartment of the ring balance through entrances which will not affect the weighing operation to be described. The entire ring balance is hung from a knife edge placed at a point just above the center of gravity of the torus. A beam mounted on the outside of the torus permits weights to be applied to rotate the torus. When a small differential pressure exists in the ring balance, the mercury is displaced, upward on one side and downward on the high pressure side. This causes the torus and beam unit to rotate about the knife edge to a new equilibrium position. Weights are then added to the beam until the beam is restored to the original equilibrium position. The weights are a function of the differential pressure.

6. Design Elements of Barometers and Manometers

Many new developments in mercury manometry have been produced in the last few years and are still being evolved as a result of needs in various laboratories for greater accuracy and precision in measuring absolute and differential pressures. Such needs as greater speed and ease in measuring and controlling pressures and safer portability have also greatly stimulated development work. The principal directions of development and its status will be briefly discussed.

6.1. Methods of Detecting the Mercury Surface

These methods cannot always be completely separated from the means of measuring the height of the column which however, insofar as feasible, is considered separately in sec. 6.2. Quite a few methods are used to detect the position of the surface of the mercury in barometers and manometers.

6.1.1. Sighting on the Meniscus by Eye

In sighting on the meniscus by unaided eye, if there is any pretense to accuracy, a sighting ring is provided. The lower edge of the sighting ring, in front and behind the meniscus, is used as a reference and is lined up with the top of the meniscus. The sighting ring is usually attached to the vernier and must bear a known relation with the zero of the vernier in order to obtain a valid reading. This relation offers no difficulty in determination if the barometer is calibrated or its zero correction determined. It is obvious that

the plane of the sighting ring should be horizontal and not move with respect to the vernier. The final adjustment of the sighting ring and vernier combination is usually made with a control screw of limited travel.

If the meniscus height is to be measured, the sighting ring is also set upon the line of contact of mercury to glass, usually with much less accuracy than on the meniscus, due to the raggedness of this line of contact and the difficulty of securing good illumination. Tapping the tube helps if done before making any settings on the mercury surface.

Illumination of the meniscus so as to sharply define the crown of the meniscus is essential for accuracy. In some situations a miniature electric lamp behind a translucent screen illuminating the mercury surface from behind has been found helpful.

It is estimated that the precision of sighting by eye probably is not better than 0.001 in. (0.025 mm). This estimate assumes optimum viewing conditions as to illumination and sharpness of the meniscus. In portable barometers and manometers the sighting precision is ordinarily not the factor that limits the accuracy.

6.1.2. Sighting on an Index

An index, such as an ivory point, which can be lowered to the mercury surface, or the mercury raised to it, is with proper illumination a very precise detecting means. If the mercury is bright, and parallel lines on paper are reflected from the

surface to viewer's eye, the point of contact can be determined to 0.001 mm (ref. [141]).

The contact is judged to be made when a small dimple in the mercury just disappears as the mercury level is lowered, or the index is raised.

The use of an index has the disadvantage of an extra operation, since it has to be adjusted before making a reading. However, in some designs it is quite feasible to make the setting automatically. The index makes an electrical contact with a small voltage output, which, amplified, can be used to operate a mechanical device which adjusts the mercury level. See ref. [453] for an example.

The index is used in the cistern of Fortin barometers to set the mercury level to a predetermined height. It may be remarked that the cleanliness of the mercury surface is preserved much longer if the index be kept above the mercury when readings are not being taken.

In some fixed cistern barometers a fixed index is installed in the cistern and the pressure determined when the index contacts the mercury. If subsequently this pressure is found to change, the change may be incorporated into the scale correction, or the need of other corrective action is indicated; also it is used as an indicator of the amount of mercury required for the barometer, if the barometer is shipped dry and filled with mercury in the field.

In general the use of an adjustable index on a mercury surface subject to a pressure differing from atmospheric pressure requires a stuffing box. One manufacturer, in order to increase the accuracy of a fixed cistern barometer used as a working standard, installed an index in the cistern and adjusted it through a stuffing box with a micrometer head, in this way measuring the rise and fall of the cistern mercury. The cistern was made of glass.

In the Braunschweig standard barometer [576], a fixed index is installed above the mercury surface in the vacuum space and a movable index above the lower mercury surface. Only atmospheric pressure is measured. At any pressure in its range, the mercury is forced up the tubes by a plunger in an auxiliary cistern so the upper index just touches the mercury; the lower index, together with a short scale, is then adjusted to contact with the mercury. Contact is observed with a microscope. The movement of the short scale is measured with reference to a fixed mark on the barometer support, the distance of which to each index had been previously measured.

Another manufacturer, to facilitate calibration at fixed pressures (barometer thermostatted) installed tungsten contacts at selected intervals in a glass barometer tube [495]. These were adjusted to within 0.001 in. of the desired values. By means of a selection switch a selected contact was connected to a low voltage. When the proper pressure was attained by adjustment, an audible buzzing signal was heard in earphones by the operator. Probably visual observation was also

needed to make sure the contact did not dip into the mercury. This system could also be made automatic by adaptation of the means described in ref [453].

When sighting by eye on an index the mercury surface can be detected to a precision of at least 0.001 mm. With a fresh mercury surface detection by electrical contact has a precision of about 0.005 mm; this precision falls markedly as the mercury surface fouls.

6.1.3. Mercury Float

A float has been installed in the tube on the mercury by one manufacturer. A horizontal mark on the float is sighted on by eye. The barometer requires comparison with a standard barometer to determine the relation of the mark to the meniscus level.

In another design the same manufacturer mounts a thin steel disk on the float in the barometer tube. The movable sighting and vernier unit carries with it a small magnet on a shaft free to rotate. Proper alinement of the sighting device is indicated when a pointer attached to the shaft rotates to indicate zero on the vernier as a result of the force of attraction between the magnet and disk. When the sighting device is again moved so that the vernier zero is alined with the next scale division of the main scale, the pointer will indicate on the vernier the distance the sighting device has moved. From scale and vernier readings, the pressure can be deduced. Again at least one barometer reading must be compared with that of a standard barometer.

In another design by another manufacturer, the float carries a piece of magnetically permeable material. A differential transformer encircling the tube can be moved up or down to detect the position of the core piece on the float. The signal from the differential transformer is amplified to operate a servomotor to position automatically the differential transformer symmetrically with respect to the core piece. The angular motion of the servomotor is used to secure an indication of the pressure.

For reproducible capillary error the float should be shaped so that the mercury surface always contacts the float at a fixed level. This can be secured by a sharp corner on the float where contact is made. If the mercury surface is nearly level in the vicinity of the line of contact, the depression of the float due to capillarity will be of the same order as the capillary depression of mercury in a tube having a radius equal to the clearance between the float and the tube wall.

6.1.4. Sighting With a Telescope

As a matter of convenience manometers and barometers are often read by cathetometers. To push the accuracy to the limit requires attention to the details discussed below.

In this method the observer views the mercury surface with a telescope. The telescope is mounted

on a cathetometer so that it can be raised and lowered as needed to view the mercury surface. For convenience two telescopes are best used so that both legs of a U-tube instrument can be observed independently, and with greater simultaneity. If one telescope is used and the inability to measure low pressures is permissible, the two mercury surfaces should be one directly above the other. Preferably the scale should be installed alongside of the barometer or manometer tubes, and read at some optical distance through the telescope; the need for this installation will be discussed in section 6.2. If the scale is so read, the vernier is provided by means of a reticule in the telescopes or a filar eyepiece. The reticule requires that the magnification of the telescope be fixed, so that the distance of the scale from the telescope is fixed. The filar eyepiece with its screw requires an additional reading to transfer the reading to a scale graduation.

To locate the meniscus top accurately and with ease, it must be illuminated. For this purpose it has been found reasonably satisfactory to use miniature electric lamps with a green translucent material between the lamp and mercury column. The lamp units are mounted behind each mercury column and are movable vertically by hand or preferably by small motors to the best position with reference to the mercury surface. The meniscus must be sharply defined and be without highlights. A more elaborate method is described in ref. [412].

The cathetometer must be rigidly built so as not to flex appreciably when small torques are applied which tend to turn it about a horizontal axis. The cathetometer must be free to rotate about a vertical axis and for the angle of turn needed to view the mercury surfaces and scale, must rotate truly vertical. If the axis of rotation is off the vertical one degree of arc, a rotation of $1\frac{1}{2}$ deg may change the height sighted on at 2 m by as much as 0.9 mm. It must therefore be possible to plumb the cathetometer. For essential details on the design of a cathetometer for precision applications see ref. [351, 412]. For details on the alinement errors see sec. 6.6.

When the distances from the mercury meniscus and from the scale to the telescope are the same and the optical axes of the two telescopes are parallel, it is not necessary that the telescope axes be precisely horizontal. In some cases, it may be desirable to set the telescopes at a slight angle off horizontal to gain the maximum illumination. A horizontal indication of the level bubble mounted on the telescope may not necessarily indicate that the optical axis of the telescope is horizontal. To check this, the telescope is sighted on the scale and the scale reading noted; the telescope is reversed in its mounting, the cathetometer rotated 180° and the scale reading again observed. The difference between the two readings is an indication of the deviation of the optical axis of the telescope from horizontal.

Since in telescopic sighting the barometer and sighting device are separated by distances up to 5 ft it is essential, for precision measurements, that there be no relative motion of the parts while readings are in process. If mounted on the concrete or wood floor of a building, walking in the vicinity of the installation may cause measurable changes in readings. Vibrations are also troublesome. In general, for accuracy better than 0.1 mm of mercury it is necessary to install the unit in a basement room, on a foundation separate from that of the building. The working standard at the National Bureau of Standards is so installed on a separate cork-concrete platform. Other installations may be just as satisfactory; the barometer and associated apparatus described in ref. [412] is mounted on structural members of considerable rigidity.

The working standard barometer at the National Bureau of Standards used to calibrate barometers and precision aneroid barometers is of the U-tube type, utilizing two telescopes on a cathetometer for making the readings. The overall accuracy is now estimated at 0.02 to 0.03 mm of mercury (0.0008 to 0.0012 in.) with a precision of reading of 0.01 mm. The limitation, however, is probably not in the sighting means which has a precision of the order of 0.005 mm.

The ultimate in developing the telescopic sighting method is perhaps in the MIT barometer [412], where special attention was given to all sources of error or difficulty. The accuracy aimed for was 0.001 mm of mercury; that attained was estimated at 0.005 mm of mercury.

Two micrometer microscopes are used in the NPL standard barometer [333, 552], sighting on the mercury surfaces through optical flats. The settings are transferred to a line standard to obtain the column height. Only atmospheric pressure is measured, with an estimated uncertainty of 0.01 mb (0.003 in. of mercury).

6.1.5. Photocell Detector

The essential features of detecting the position of a mercury surface, with a photocell are: (a) A light source to silhouette or illuminate the mercury surface; (b) one or more photocells in a circuit to provide an electrical signal dependent on the position of the mercury surface; and (c) an indicator that responds to the electrical signal. The electrical signal is a more or less invariable function of the position of the optical system with respect to the mercury surface. The position indicator thus reads zero when the photocell is at the desired position, goes to the left or right when the photocell position is too high or low. The electrical signal, amplified, may be used to drive a servomotor which keeps the photocell at a position corresponding to the mercury surface. As an aid to detecting malfunctioning, provision is usually made for visual sighting on the mercury surface.

Restricting comments to the mercury surface

detecting system, it is seen that any change in characteristics of the light source, or the photocell, may affect the balancing position of the unit relative to the mercury surface. In a barometer used to calibrate radiosondes, [511] where photocell detection was used, a second photocell was used to compensate for changes in the characteristics of the light source. Light from the light source was permitted to fall upon the compensating photocell, the output of which was fed to one arm of the Wheatstone bridge so as to achieve compensation. This was believed necessary because it was doubtful whether the bright light source remained constant. Fully as important, and probably less easy to eliminate, is the effect of film forming on the inside tube surface. The change in intensity of the light reaching the photocell directly affects the position of the photocell, since it must move to a position admitting more light in order to secure a balanced position. In at least one device, the light passes through the barometer tube before reaching the compensating photocell. If the film is uniform in density, compensation for the effect of the film is thus achieved. If not uniform, the tube must be cleaned or replaced. However, with two photocells, any change in characteristics of either will affect the position of the photocells with reference to the mercury surface at the balance point.

A photocell detector unit has been developed [572] in which no compensation is used for the light source variation. The photocell is primarily sensitive to red and infrared so that the light source is operated at low filament temperatures, and variations in characteristics are less likely to occur. However, changes in the balancing position of the photocell detector with reference to the mercury surface can still occur if a film forms on the tube surface.

Barometers and manometers of both the U-tube and cistern types are being made with photocell detectors. In the U-tube instruments, two photocell detectors each with its own accessories are required.

One advantage, perhaps doubtful, of the power amplification possible with the photocell is that a selected pressure can be maintained. The photocell can be set to the position corresponding to a selected pressure and, instead of positioning the sighting device, the servomotor can operate a valve to maintain the pressure constant. A barostat, independent of the barometer, may be preferable for several reasons, as discussed in the section on Scale Errors.

The accuracy of commercially available barometers and manometers with clean mercury and tubes in setting the photocell detector is of the order of 0.001 in. (0.025 mm). This accuracy or precision is not realized over all. No data are available on the variation expected as the instrument and components age. One manometer [572] is stated to have a repeatability of reading within 0.05 mm (0.002 in.) which includes all sources of error in the mechanical and electronic system.

Stimson [454, 553] used a capacitance type pickup in the U-tube manometer designed to measure gas pressures accurately. A steel plate, 35 mm (1.38 in.) in diameter, electrically insulated was installed above the mercury surface in each of two shallow cells 7.3 mm (2.87 in.) in diameter. A reference capacitance was installed in a shielded chamber above each cell. The electrical capacitance between the steel plate and the mercury surface is a measure of the separation between the plate and the mercury surface. A means for comparing the capacitance of the reference capacitor and the mercury capacitor is provided. One of the two cells is wrung to a pile of Hoke gage blocks (end standards) so its height can be changed.

A description of the measuring procedure will aid in visualizing the design. First the pile of gage blocks under the movable cell is found that will make height of the steel plates in both cells nearly the same. The cells are evacuated and the mercury level is adjusted so that the separation between the mercury meniscus and the steel plates is approximately 0.15 mm. One reference capacitor is then adjusted slightly so that each reference capacitor has a value equal to the capacitance between its steel plate and the mercury surface. The pressure to be measured is applied to the mercury surface in one cell and the other cell (still evacuated) is raised on a higher pile of gage blocks. The quantity of mercury in the system and the pressure are then adjusted so that the capacitance of the mercury to the plate in each cell is equal to its reference capacitance. The change in height of the pile of gage blocks is the measure of the pressure applied.

The precision of detecting the vertical position of the mercury surface in this manner stated to be less than 0.0001 mm (4×10^{-6} in.).

Los and Morrison [513] used the capacitance between an invar plate and a mercury surface to measure differential pressures in the range 0 to 2.5 mm of mercury (0.1 in.). The variation in beat frequency of two oscillators to which the capacitances were singly connected served to measure the pressure. Column heights were not measured directly, so that calibration was necessary, for which an improved design of McLeod gage was used. Data are given to show the nonlinearity of beat frequency with change in height of the invar plates above the mercury surface. In this design a precision of 0.1 to 0.2 μ of mercury was claimed for the range 0 to 0.2 mm of mercury, and 0.1 percent or better for the range above 0.2 mm of mercury.

6.1.7. Optical Reflection Detectors

An optical probe which is being applied to a U-tube barometer has been developed by the National Physical Laboratory [573]. The U-tube barometer is vertical while the optical probe is hori-

zontal, a right angle prism being used to transmit reflections from the mercury surface to the probe. Two horizontal tubes movable as a unit on a track have their axes intersect at a selected angle. A light source at the end of one tube passes through a grid to the mercury surface. The light reflected from the mercury surface passes through the second tube and through a grid exactly similar to the first. If the mercury surface is precisely at the intersection of the two tube axes, maximum illumination is received at the exit of the second grid. At any other position the brightness of the light at the exit is less. The accuracy of setting is stated to be about 0.5μ (20×10^{-6} in.).

For detection of brightness a photocell is placed at the exit of the second grid. For reference a second photocell receives some of the reflected light from a lightly aluminized glass plate placed ahead of the second grid. The output of the two photocells is amplified and passed through a Wheatstone bridge, which in the balanced condition indicates the maximum brightness of the reflected light coming through the second grid.

The optical tubes are mounted on precision ways for adjusting their position to that where the light received by the grid exit photocell is a maximum. A fixed line standard, with optical accessories for viewing, serves to measure the position of the tubes on the ways. Alinement of the ways must be held within close tolerances; the errors introduced, and their amounts, are discussed in ref. [573].

The barometer, not discussed in ref. [573], consists of a stainless steel U-tube, 4 in. in diameter. The range is 1 atm or more. Any glass plate between the light and mercury surface should preferably be optically flat.

In order to obtain observations on the two mercury surfaces, the difference in height of which is to be measured, two optical probe systems as described above are used. These can be coordinated by measurements made when both legs of the barometer are subjected to the same pressure.

Another optical probe, described by Moser [555, 575], detects equality in the meniscus curvature. It was used to establish the equality of two pressures and, while possibly applicable in detecting a mercury surface in connection with precise pressure measurement, has not so far as is known been so applied. A brief description of the probe as used may be of interest.

The operation of the probe depends upon the fact that at a hole ending with a sharp edge the mercury meniscus is captured by the sharp edge. Moser desired to obtain an equality of gas pressure in two systems. The gas pressures from the two systems were brought into two vertical chambers about 3 mm in diameter and 15 mm high. The bottom ends of these chambers ended in sharp edges, at the same level, in a manifold filled with mercury. The tops of the chambers were sealed with glass windows. Gas pressures were adjusted

in the chambers till the menisci were nearly plane at the sharp edges. Light from point sources above the chambers passed down through 45° semireflecting plates, through the chamber windows to the mercury menisci, whence they were reflected back through the windows to the 45° plates, and out horizontally to telescopes. Small changes of pressure in the chambers changed the curvature of the menisci. When the radii of curvature were equal to half the distance to the point light sources the reflected light beams became parallel and the field was uniformly illuminated. The uncertainty of equality in the pressure settings was said to be ± 0.002 mm of mercury.

6.1.8. Interference Fringes

Terrien [592] describes three ways in which interference fringes from two mercury surfaces can be used to detect the relative vertical distance apart of the mercury surfaces. In all cases the length of the significant light paths must be equal. This is secured by a mechanical adjustment of the position of a reflector or reflectors, the amount of which is used as a measure of the column height.

One of the methods originates in Japan, another in Russia, and the third is due to Terrien. Briefly, in the design due to Terrien, a beam of white light is split by a half-silvered surface. One beam passes through a Michelson interferometer, and is reflected to one of the mercury surfaces. The other beam is reflected to the other mercury surface. Upon reflection the beams reverse their paths and are reunited as they issue from the interferometer. If the optical path lengths are exactly equal, and if the mercury surface has infinitesimal ripples, a condition difficult to prevent, the observed fringes are white, not colored. The fringes are detected by a photocell. To obtain exact equality in the light paths two horizontal prism reflectors are adjusted horizontally as a unit. The amount of the horizontal motion is a measure of the height of the mercury column.

Both the Japanese and Russian interferometer methods require two light sources.

6.1.9. Resistance Wire

One method of transducing a pressure to an electrical quantity which can be easily recorded, or indicated as desired, is to stretch a wire through the mercury column. A voltage is applied to the upper end of the wire and to the mercury. The electrical resistance of the wire must be greater than that of the mercury column; sensitivity increases with difference in resistance per unit length. As the mercury column falls, the resistance of the circuit rises.

Either the resistance of the circuit is measured with a Wheatstone bridge or the drop in potential with a potentiometer. The use of a recording potentiometer is discussed in ref. [532]. A nichrome wire has been used [501, 532]; a carbon

rod [543]; and in tandem, a 9H lead from a lead pencil and a steel wire to complete the electrical circuit [562].

Apparently none of the experimenters with this form of pressure indication required high accuracy, since in most cases rather small bore tubing was used. Variable capillary effects can be expected to affect the accuracy, both at the glass and mercury surface and at the wire and mercury surface. About the latter boundary not much can be done to effect an improvement beyond an uncertainty of several tenths of a millimeter. This limitation seriously limits the method in any application to really precise and accurate measurements. Its convenience merits its use when high accuracy or precision are not required.

6.1.10. Gamma Ray Pickup

This method of detecting a mercury surface is useful in measuring differential pressures at high pressure where a steel tube must be used to secure adequate strength [514]. A narrow beam of gamma rays from a radium source are projected through the tube. On the other side of the tube an ionization chamber is placed. The ionization chamber and radium are mounted as a unit with an indicator of their position on a scale. A discontinuity in the intensity of received gamma radiation received by the ionization chamber is observed when the unit moves vertically by the mercury surface. A precision of $\pm \frac{1}{2}$ mm is claimed.

6.2. Measurement of Mercury Column Height

Methods of measuring the height of a mercury column have been discussed to some extent in previous sections but some elaboration is needed. A simple, widely used, method is to visually estimate the height of the column by comparison with a scale alongside of the mercury column, either with or without a sighting ring.

Refinements in measuring, to which further discussion is limited, are: (a) the use of a scale and vernier; (b) a cathetometer; (c) a precision screw; and (d) gage blocks.

6.2.1. Scale and Vernier

Ordinarily the scale is a separate member, more convenient to calibrate in this form, which is attached to the structure supporting the glass tubes containing the mercury. A sighting ring, free to slide or controlled in position by a rack and pinion arrangement, and a vernier with its zero alined with the sighting ring, form a unit. In taking a reading the bottom of the sighting ring is alined with the top of the mercury meniscus and its position determined on the scale.

Verniers are customarily made with a least reading not below 0.05 mm or 0.002 in., since the overall accuracy achievable does not warrant greater precision.

Scales on portable instruments are commonly

made of brass. In one design a plastic scale is used, which is discussed in sec. 6.8.

For precise measurements of pressure the scale must be ruled on a first class ruling engine under controlled conditions of temperature. If the reference temperature for the scale is 0° C, a convenient, but not necessarily essential reference temperature, the ruling engine can be manipulated so that the scale is accurate at 0° C. This practice is commonly followed, theoretically at least, for portable barometers, with one exception. This exception is the Fortin barometer commonly used in meteorology the scale of which when in inches of mercury is graduated to be accurate at 62° F. The scale so graduated is becoming obsolete because meteorologists now use the millibar as the unit of measurement, and transition is well under way to barometers so calibrated. The temperature at which scales may be graduated to be accurate will be discussed in more detail in the section on temperature errors.

Scales attached to the barometer or manometer have to be read by an observer so close to the barometer, that he affects its temperature. Since this affect is normally a transient, some uncertainty is introduced in the accuracy of the measured temperature of the barometer, particularly since in most instrument designs the thermal lag of the thermometer, of the scale, and of the mercury all differ measurably. This uncertainty can be reduced, if the desired accuracy justifies it, by obvious expedients, such as reading the thermometer before initiating the pressure measuring process and by making the thermal lag of the thermometer about the same as that of the mercury in the barometer. This effect is mentioned here, because it is one of the principal reasons for instrument designs in which readings are made by an observer at a distance from the barometer or manometer [563].

6.2.2. Cathetometer and Scale

In the preferred method, used as long ago as 1889 by Professor Morley in determining the density of air, a scale is placed alongside of the mercury tubes and is read through a telescope or telescopes mounted on a cathetometer. The telescopes are from about a foot to six feet away from the scale and tubes in the various designs. The mercury meniscus and scale should be at equal optical distances from the focal plane of the objective lenses of the telescope.

The other method is to locate the mercury meniscus with the telescope mounted on the cathetometer and determine its height by reading the position of the telescope on the scale attached to the cathetometer. This method is not usually used in precise work unless the telescope is quite close to the mercury column, in itself undesirable because of uncertainties introduced in the mercury and scale temperature. The objection to the method is the necessity for maintaining the optical axes of the telescope or telescopes horizontal

within close limits. For example, if the telescope objective is 1 m away from the scale, the telescope axes must be held horizontal within $3\frac{1}{2}$ min of arc in order to avoid errors up to 0.1 mm in measurement. This source of error is practically eliminated in the preferred method.

Returning now to the preferred method, the scales may be either of invar, stainless steel or other reasonably noncorrosive material with a known temperature coefficient of expansion and stable in dimensions. They are graduated in either 0.5 or 1.0 mm divisions. If the barometer or manometer is of the U-tube type and is to be used as a standard, it is only necessary to have the scale calibrated against a standard scale and to establish or know its linear coefficient of expansion in order to apply the correction for temperature. If the scale is calibrated at a temperature close to that of its use, less accurate knowledge of its coefficient of expansion is needed.

To determine subdivisions of the scale divisions, that is fractions of 0.5 or 1.0 mm, two methods have been followed. In the first, a sight is taken on the mercury meniscus, the telescope is rotated about a vertical axis to sight on the scale and the telescope raised or lowered until the sighting cross hair is coincident with a scale division. A micrometer screw is used to raise or lower the telescope and is read to give the fractional scale division. Thus two adjustments of the cross hair position are required. In the other method a reticule is placed in the focal plane of the telescope, and can be used as a vernier when the telescope is at the proper distance from the scale, a distance which can be adjusted when installing the cathetometer. In taking a reading the cross hair in the telescope is brought into coincidence with the mercury meniscus, the telescope rotated to the scale and the reading obtained similarly as on a scale with a vernier.

From experience limited to one arrangement of a reticule it was found that considerable training is required to obtain reliable readings and that some attention must be paid to the illumination in order to distinguish clearly between the divisions of the scale and of the reticule. It does have the advantage that only one adjustment of cross hair position is needed.

6.2.3. Precision Screw

Use of the rotation of a precision screw to measure the height of a mercury column appears to be the logical method if automatic indications are desired; particularly if mechanical means are used. The lead screw, mounted in a vertical position, can be used to raise or lower the sighting mechanism. A counter connected to the screw by means of a gear train may be used to count the revolutions of the screw and so provide a digital indication of the pressure. A photocell detector of the mercury surface position, or other sensing device which provides an electrical signal indicating the position of the mercury surface may be used to

drive a servo system connected to the screw to achieve automatic positioning of the sighting mechanism.

There is nothing to preclude the use of the precision screw as a means of manual measurement of the height of the mercury column, though it may not prove practical, except as a check on the automatic reading. It is merely necessary to have a sighting ring adjusted by manually rotating the screw through gearing and read the rotations of the screw on a suitable indicator.

The screw can be made to measure as precisely as desired, possibly to a part in 100,000, for the length required in barometers. The only barrier is the expense in securing the precision, which of course increases as the length of screw increases. Uniformity of pitch is highly desirable. The pitch will vary with temperature for the materials of which the screw would ordinarily be made, but this effect on the accuracy can be eliminated by maintaining the barometer or manometer at constant temperature or by applying corrections. The latter procedure in the present applications of the screw to manometry will prove inconvenient.

6.2.4. Gage Blocks

For high accuracy, Stimson [454, 553], has used gage blocks, calibrated to two parts in a million, to measure the height of the mercury column in a manometer. The manometer is of the U-tube type; it has articulate joints in one leg, and the mercury menisci are in cells of large diameter in order to minimize errors from capillary depressions. The amount of the mercury and the pressure can be adjusted to bring the mercury menisci to reference positions in the cells. These reference positions are determined with the capacitance pickup, described in sec. 6.1.6. The height of the pile of gage blocks for the zero reference is obtained when both cells are evacuated. When gage blocks are subsequently added and the pressure adjusted to bring the mercury to the same reference positions in the cells, the added blocks give the direct measure of the height of the mercury column.

Obviously to realize the accuracy inherent in the use of the gage blocks, many precautions must be taken. Principally, temperature control and temperature equilibrium to about 0.01°C before taking a reading are both necessary. Coupled with the necessity of obtaining a zero reference reading sometime before and after each pressure determination, it is seen that pressure measurements are a time-consuming operation. In the present state of the development, realizing the accuracy possible from gage blocks is essentially a research operation.

6.3. Illumination of the Mercury Surface

For sighting on the mercury meniscus by eye, guided by a sighting ring, only simple means of illumination are justified. If the installation is such that the mercury meniscus is poorly defined

in daylight, it is only necessary to install a low-wattage (flashlight) lamp behind the mercury meniscus with a ground glass, or better a green translucent paper, in front of the lamp. A similar arrangement helps with setting the index in the cistern of Fortin barometers.

For more precise measurements made by sighting on the meniscus with a telescope, the above described lamp installation is often adequate. The height of the lamp and diffuser assembly can be best adjusted by a small motor operated by the observer. The adjustment of the lamp height may be critical in order to obtain a well-defined meniscus repeatably the same. Highlights on the mercury meniscus from other sources of illumination can be troublesome but can be avoided by shielding or better by eliminating the sources while making a setting.

In order to secure the ultimate in precision in sighting on the meniscus through a telescope, experimenters [333, 412], agree in the necessity of having parallel or nearly parallel light on the meniscus. A further refinement, [412], is to have the illumination nearly parallel in the vertical direction, but diffuse horizontally; this illumination can be secured with a cylindrical lens. In the end, experimentation is necessary to determine the invariant optical configuration associated with the meniscus on which to sight. This may be an outstanding reflection from the meniscus, rather than the outline of the meniscus, which may be indefinite when a precision of the order of 0.001 mm is desired.

6.4. Vacuum Above Mercury Column

This discussion relates only to instruments where a vacuum must be maintained above the mercury column. In fixed cistern and Fortin barometers used only to measure atmospheric pressure, no provision is made, beyond a careful procedure in filling the barometer tube, for maintaining the vacuum. The design is usually such that, following a precautionary procedure to prevent admitting air into the tube, the barometer can be tipped upside down, or better if the design permits nearly horizontal with the upper end of the tube lower than the cistern, and the air bubble removed by tapping the tube. This procedure in the hands of experienced persons is usually reasonably effective. However, in practically all barometers a small gas bubble will be visible when the barometer is tipped just enough to fill the tube with mercury, in fact will also exist in freshly filled barometers.

The situation is not serious in barometers used solely to measure atmospheric pressure. Such barometers are known to have maintained a satisfactory degree of vacuum for many years without attention.

The procedure of filling a barometer tube may be of interest. First, the tube must be clean. In filling the tube with mercury by any practical

procedure it is almost necessary that the mercury be above 100° C in order to eliminate water vapor entirely. In the end the only really satisfactory method is to distill the mercury into the tube in a system which is kept evacuated, preferably with a diffusion pump. The tube being filled should be kept at a temperature somewhat above 100° C and should be outgassed by well known procedures before the filling operation.

The situation is different in fixed cistern barometers which are more or less continuously used to calibrate altimeters and aneroid barometers where large cyclic changes in the pressure in the cistern are required. In a relatively short time of such use, the vacuum seriously deteriorates. If the space above the mercury column is observed in a darkened room while the pressure in the cistern is reduced, luminescence of the mercury vapor in the tube will be seen, probably caused by the discharge of an electrical charge on the walls of the tube resulting from the contact difference of potential between the mercury and glass. This seems to accelerate the formation of gaseous products or promote outgassing of the glass. In any event painting the outside wall of the glass tubing, but not where it would interfere with visibility of the meniscus, with a metallic electrically conducting paint greatly reduces the rate at which the vacuum deteriorates.

To facilitate removal of gas above the mercury column, fixed cistern barometers are designed so that the open end of the glass tube is covered by the mercury in the cistern, independent of its orientation, vertical, horizontal, or upside down. This makes it possible to eliminate much of the gas from the tube by a simple procedure. The cistern is evacuated, the barometer is oriented to an almost horizontal position with the open end of the tube a little above the closed end, thus tremendously increasing the volume of the gas bubble by reducing the pressure. As mercury flowed back into the tube the gas bubble moved up the tube and out. However, for complete removal the bore of the tube at the open end has to exceed 3 mm.

Shipment of fixed cistern barometers has also been a problem. Usually the barometer has been shipped in an upside down position, suspended in a box, but breakage of the tube due to rough handling occurred frequently.

6.4.1. Mercury Sealed Valve

The situation just described led to the development of barometer tubes with a mercury sealed valve at the top. Barometers with these tubes are shipped unfilled with mercury, and thus more safely, and the procedure of maintaining a vacuum is much simplified. The valve is so designed that it opens outward, but is normally kept closed by a force, usually produced by its own weight. A small cup around the seal holds a small amount of mercury for a more positive seal. The gas that accumulates above the mercury column may be

removed by evacuating the space above the seal while the mercury in the tube is forced up by applying pressure to the system until it is forced out through the mercury seal. It is sometimes necessary to manually lift the valve slightly off its seat to permit the gas bubbles to escape. Some idea of the quantity of gas in the tube can be obtained by observing the number of bubbles that come through the mercury seal.

With this valve, a barometer can be shipped free of mercury and the mercury added at the place of installation. Securing a vacuum requires many repetitions of the above described procedure at intervals up to a week, and the procedure can be repeated when there is any doubt about the vacuum.

6.4.2. Pump

The vacuum above the mercury column can be maintained by the use of a vacuum pump, which can produce a vacuum better than the accuracy required for portable barometers. These pumps are operated while the barometer is being used.

For standard barometers and where high precision in absolute pressure measurement is desired, more elaborate pumping systems are used. In its simplest form, the top of the tube is connected to a diffusion pump backed up by a mechanical vacuum pump. To prevent oil vapor from the diffusion pump entering the barometer vacuum system, a liquid air trap can be used. To measure the vacuum a McLeod gage or other type vacuum gage may be connected to the system.

6.5. Tubing

At present for portable barometers, precision bore Pyrex tubing is generally used. There is some evidence that less chemical interaction and less scum develops at the mercury-glass interface with some other kinds of glass, but any definite conclusion is probably debatable in the present state of our knowledge.

Precision bore tubing apparently has satisfactory optical properties in the bore, but its external surface may have irregularities which deviate the light rays as they pass from the glass into the atmosphere. Thus the position of the meniscus as seen may be up or down from its position. This deviation may be called a prismatic error since it is similar to the deviation of rays passing through a prism. The deviation is generally kept within bounds by selection of the tubing and in occasional cases by grinding the outside of the precision bore tubing to uniformity.

Precision bore tubing is exceedingly useful in fixed cistern barometers and manometers and in U-tube instruments where the height of mercury in only one leg is measured. When using precision bore tubing the scale contraction is a constant; if the tubing were irregular in bore, the difference in the two column heights would still be unchanged, but the scale error of the readings on a single scale would fluctuate with the irregularity in the bore.

As will be discussed in detail in sec. 11, the uncertainty in capillary error can only be reduced by increasing the bore of the tubing. Barometers with any pretense to accuracy must have a tubing bore of at least $\frac{1}{4}$ in.; the uncertainty in pressure measurement for this bore is about 0.01 in. of mercury (0.25 mm). Increasing the bore to 0.6 in. (15 mm) lessens the uncertainty to about 0.004 in. (± 0.10 mm), if no capillary corrections are made to the readings.

In precise measurements, if the mercury meniscus is sighted upon through glass, the tubing is enlarged at the sighting levels and optical flats form part of the mercury container in the line of sighting. (See ref. [333].)

If metal tubing is used in whole or in part, steel or preferably stainless steel must be used. Most other metals amalgamate with mercury. Barometer or manometer cisterns are generally made of stainless steel or glass.

6.6. Alinement of Scales and Sighting Devices

In manometry it is necessary to measure the vertical height of the mercury column. The errors introduced by misalignment of the scale and accessories, may be divided into two types, one the cosine error, the other the sine error.

The cosine error is caused by the scale not being vertical; it, in general, equals the scale reading times $1 - \cos a$, where a is the angle of tilt. An error of one part in 10,000 is produced by the scale tilting 49 min of arc. There is usually no difficulty in reducing this error to practical limits, by adjustments provided in most portable barometers. Most barometers designed to hang from a hook do not hang vertically; their scales are adjusted to be vertical by means of a separately supported ring encircling the cistern, with screws to control its horizontal position. Platform barometers and manometers are provided with leveling screws.

The sine error is some function of the separation of the mercury columns, or the distance of the scale from the mercury columns, or some other distance significant in the measurement; all multiplied by the sine of the angle of misalignment. It usually occurs when a measurement requires transfer from one vertical to another. In general, the sine error is a constant, independent of the height of the mercury column, if the misalignment does not vary in amount. It is often corrected for as part of the zero error, discussed in section 8.1, and indistinguishable from other causes of it.

In general the sine error equals the pertinent distance times the sine of the angle of misalignment; for an error of 0.1 mm, this angle is 34 min of arc for 1 cm of distance, 17 min for 2 cm, or for an error of 0.01 in., 34 min of arc for 1 in. of distance. Several examples of sources of this error are outlined below.

Some barometers, such as the Fortin, are equipped with a zero index in the cistern for setting

the mercury surface in the cistern. If the scale does not hang vertically, both a sine and cosine error are introduced. The sine error equals the product of the distance of the index to the center of the tube times the sine of the deviation angle. To eliminate the sine error, the Fortin barometer is adjusted to hang so that, upon rotating the barometer, the relative vertical position of the index and mercury surface in the cistern is invariant. If the scale is then vertical, the cosine error is also eliminated.

In sighting upon the mercury meniscus with a telescope, with the scale attached to the cathetometer, the sine error is proportional to the distance of the scale to the mercury column. To reduce the error to a reasonable amount, the optical axis of the telescope must be maintained horizontal within excessively close limits; therefore this location of the scale should be avoided, as discussed in section 6.2.2.

In making readings with a telescope, where the scale is in the preferred position along side of the mercury column, a sine error may be introduced if the cathetometer does not rotate about a true vertical axis. If the cathetometer axis is displaced from the vertical at right angles to the vertical plane of sight, the sine error is a maximum; if tilted in the vertical plane of sight the sine error is zero. Assume, for example, that a scale is between the two legs of a U-tube barometer. To transfer the observed level of one meniscus to the scale, assume that the telescope sighting line runs uphill; to the other meniscus it runs downhill. If the maximum rotation of the cathetometer required is over an arc l at the scale, and A is the angle of tilt of cathetometer axis in the vertical plane at right angles to the plane of sight, the rise r of the sighting line of the telescope is to a good approximation $l \sin A$. For the practical case of an arc length of 10 cm a total rise r , or an error, of 0.1 mm is obtained for a tilt of about 4 min. The large effect of small tilts indicates the necessity of reducing the transfer distance l to the minimum and most important, the need for a rugged, rigid cathetometer, since constancy in axial alignment is a primary necessity.

If the ways along which a sighting ring and vernier unit of an instrument slide are not vertical in the vertical plane of sighting, a sine error is introduced. If the scale is not vertical, a cosine error is additionally introduced. The sine error equals the product of the distance of the scale from the center of the tube and the sine of the angle of tilt. For a distance of 2 cm and an error of 0.1 mm the tilt of the ways is 17 min of arc.

Misalignment giving rise to the sine error which varies with the reading can be avoided to the degree needed for the designed accuracy by good design and care in the construction of instrument.

6.7. Instrument Temperature

If the uncertainty in pressure measurement is to be held to 0.01 percent (0.1 mb at 1 atm) the

mercury temperature must be known within $\pm 0.6^\circ \text{C}$, and proportionately smaller for better accuracy. The scale temperature, if brass, needs to be known to only approximately ten times this uncertainty (that is 6°C) for the same accuracy limits (0.01%). For precise pressure measurements it is seen that the mercury temperature must be known to very close limits, which involves both the measurement and control of temperature.

6.7.1. Measurement of Temperature

In simple portable barometers the temperature is measured by mercury thermometers, with their bulbs imbedded in a metal shield. Thermal lag is thus introduced in the thermometer which it is hoped will equal that of the mercury in the barometer or manometer, but in the nature of things, can only approximate it. A better arrangement sometimes used in laboratory instruments is to place the thermometer in a tube of mercury, more or less simulating the barometer tube [576]. Since at best the mercury thermometer cannot be depended upon for an accuracy better than 0.01°C , resistance thermometer or thermocouples are preferable when better accuracy is needed.

It is generally assumed, probably without significant error, that the scale and mercury column temperatures are identical. In view of the lower temperature coefficient of the scale, the error is held to a minimum if the effort is directed to obtaining the mercury temperature.

In the absence of continual control of the instrument temperature, special attention must be given to thermal lags if the ambient temperature is varying or has varied. It takes hours for an unventilated barometer or manometer to come to temperature equilibrium with its surroundings after an abrupt shift in the ambient temperature. See ref. [563] for some data. The thermal lags of the barometer and attached thermometers in spite of all effort are unlikely to be the same. Within limits the two temperatures, instrument and thermometer, are reasonably identical only if the thermometer reading has not changed appreciably, say a few tenths of a degree, over a period of time, say at least $\frac{1}{2}$ hr.

In portable barometers where the observer performs operations while standing close to the instrument the temperature is influenced if the barometer temperature differs from body temperature. With care to reduce this time to the minimum, and by reading the thermometer first, this uncertainty can be reduced to manageable limits, say of the order to 0.2°C .

6.7.2. Control of the Temperature

Two methods of controlling the temperature of the instruments are in use. In the first, the barometer is enclosed in a cabinet in which air is circulated and thermostatted at a selected temperature above the expected ambient temperature. This temperature should be as low as practical in

order to avoid evaporation of mercury into the cooler lines where amalgamation of metal and mercury may occur. Generally the cabinet is divided vertically into two compartments except for necessary ducts; the barometer or manometer is installed in one and the electrical heater and circulating fan, in the other. The thermostat is in the same compartment as the barometer. The air is forced to flow in a circuit, down the heater compartment and up the barometer compartment. Refinements are incorporated in order to eliminate temperature differences along the length of the barometer, but these cannot be eliminated entirely, since even with no heat exchange the temperature falls nearly $0.01^{\circ}\text{C}/\text{m}$ of elevation, i.e., adiabatic change.

The other method is to install the barometer in a room in which the temperature is maintained constant. Primary standards and others where high precision is required are usually so installed. A subbasement room is desirable because its temperature will have a smaller diurnal variation. Generally such a room will require a source of both heat and cooling, thermostatically controlled. Ventilation will be required, so directed as to eliminate vertical temperature gradients as far as practical. The closeness and stability of the temperature control is determined by the accuracy desired in the pressure measurements.

Controlling the instrument temperature with reasonable accuracy must be continuous night and day because securing thermal equilibrium of the instrument with its surroundings requires many hours.

6.8. Automatic Compensation for Temperature and Gravity Error

Both the corrections for deviation from standard temperature and gravity are directly proportional to the height of the mercury column, as discussed in detail in secs. 9 and 10. Mechanical means have been developed so that readings on fixed cistern barometers may be automatically compensated for these errors.

In one design a long auxiliary rod is hinged at the zero of the scale and is adjustable angularly about a horizontal axis. Actually, the hinge is slightly below the scale zero in cistern barometers in order to include a correction for the change in mercury height in the cistern with temperature. Any change in angular position thus causes a vertical displacement at any point along the rod which is a function of the radius, i.e., the barometer reading. The sighting device and vernier unit is connected to the rod through a lever system and is free to slide up or down the rod as a unit during adjustments needed to make a reading. The arrangement is such that when the auxiliary rod is vertical, the vernier position is unaffected by the lever system. This corresponds to zero temperature and gravity correction. If the auxiliary rod deviates angularly from its vertical position, the vernier is moved up or down relative to the sight-

ing device by the lever system. The amount of motion of the vernier is proportional to the chord defined by the deflection of the auxiliary rod from the vertical. This chord length is approximately proportional to the height of the mercury column. Two additive adjustments of the angular position of the auxiliary rod angle are provided, one for gravity error and one for temperature error compensation. The auxiliary rod can be manually set to the angular position corresponding to local gravity and then to an angular position determined by the measured instrument temperature. A scale graduated in gravity units and one graduated in temperature are provided to indicate the adjustment to be made [515].

The permitted angular motion in one design is about 2° , while about 6° is needed. This need is taken care of by amplification of the rod motion by the lever system.

Another design of mechanical automatic compensator for temperature and gravity error has been developed. A fixed vertical rack is used instead of the hinged rod. A gear forming part of the vernier and sighting unit of the barometer runs on this vertical rack. A screw on the same shaft as the gear positions a wedge in contact with a lever which controls the vertical position of the sighting device. The rack makes this control proportional to the height of the mercury column and thus to the temperature and gravity correction. The gravity and instrument temperature for which correction is desired can be set into the corrector by manual adjustment of the angle the control lever makes with the horizontal.

A variation of the design just described and developed by the same manufacturer depends upon a vertical wire extending the entire scale length. A pulley attached to the sighting device and vernier unit has the wire looped around it, so that its angular motion, as the sighting device moves up and down, is proportional to the height of the mercury column, and thus to the gravity and temperature correction. Through a system of gears, a rack, and a lever the sighting device and vernier position is controlled as a function of the height of the mercury column. By this design sliding contacts are eliminated. The effective radius of the lever is adjustable, by which the gravity and temperature for which correction is desired can be set into the corrector.

A novel method of automatic compensation for temperature error which is also commercially available is the use of a plastic scale which is stretched between rigid supports to a length determined by the mercury temperature and local gravity. As the scale is stretched the distance between scale graduations is expanded proportional to its length starting at the bottom. This gives readings corrected for temperature as required. A scale graduated in temperature units indicates the degree of stretch necessary.

It is obvious that the extension of the plastic scale between two temperatures is the sum of the

linear expansion of the scale support with increase in temperature and an extension produced by the adjustment of a screw. The total stretch must be repeatable time after time, that is, the scale must be taut when in use. In the design now available this condition is met for temperature variations ordinarily experienced by the instruments.

The accuracy of automatic compensators need be considered practically only for the range of temperatures differing from the temperature at which the instrument is calibrated. At the calibration temperature of the instrument, the error is automatically incorporated into the scale error, or adjustments made on the instrument to correct it. The accuracy on this basis can be held to ± 0.1 mm of mercury (0.004 in.), perhaps even better, an amount which is well within uncertainties in measurement due to other causes.

6.9. Damping and Lag

Mercury column instruments have little application in making dynamic pressure measurements. However some remarks on the dynamic characteristics may be pertinent.

Damping is usually necessary and generally incorporated in the form of a restriction or a short length of capillary tubing between the two legs of a U-tube instrument or in between the tube and cistern of a fixed cistern instrument. This damping reduces the effect of undesired column pulsations or pumping, such as would occur on an undamped barometer on a ship at sea.

Consider a manometer consisting of a U-tube connecting two cisterns of equal area. Assume it filled so that a mercury surface exists in both cisterns. In oscillation the differential equation governing the motion is, assuming laminar flow:

$$\frac{\rho L A_c \ddot{x}}{A_t} + \frac{8\pi\eta L A_c \dot{x}}{A_t^2} + 2\rho g x = 0. \quad (13)$$

From which it follows that the period T is

$$T = \frac{2\pi}{\left[\frac{2g A_t}{L A_c} - \frac{16\pi^2 \eta^2}{\rho^2 A_t^2} \right]^{1/2}} \quad (14)$$

Ordinarily the readings of portable barometers and manometers are corrected only for scale errors and for deviations of the instrument from the standard temperature and gravity. The scale error is determined by a calibration of the portable barometer against a standard instrument. It includes a correction for many other factors, including capillarity and vacuum, which while assumed to be constants, may change with time.

and the undamped free period T_0

$$T_0 = 2\pi \left(\frac{A_c L}{2A_t g} \right)^{1/2}. \quad (15)$$

For critically damped motion the two terms in the denominator of eq (14) are equal, achievable by controlling A_t . Separating the variables with which damping may be controlled from the constants, this equality becomes

$$\frac{L A_c}{A_t^3} = \frac{\rho^2 g}{8\pi^2 \eta^2}. \quad (16)$$

When the column oscillates at about 0.8 of the critical damping, it will return to rest in a time equal to 67 percent of the free period T_0 , which appears to be an optimum value for the damping. On this, eq (16) becomes

$$\frac{L A_c}{A_t^3} = \frac{0.8\rho^2 g}{8\pi^2 \eta^2}. \quad (17)$$

In the above equations:

- L = length of the tubing connecting the cisterns
- A_c = area of each cistern
- A_t = internal area of the tube
- x = displacement or amplitude of the oscillation of the mercury in the cistern from its equilibrium position
- \dot{x} = velocity of the mercury in the tube
- \ddot{x} = acceleration of the mercury in the tube
- ρ = density of mercury
- η = viscosity of mercury
- g = acceleration of gravity
- T and T_0 = period and undamped free period of oscillation of the mercury column, respectively.

Equation (15) shows that the undamped mercury column has a free period depending only upon its length and the ratio of the areas of the cistern and tubing. Ordinarily this period cannot be found experimentally because of the viscous damping of the flowing mercury, and the restriction offered to flow by the finite size of the tubing.

7. Sources of Error

For measurements to the limit of accuracy of most portable instruments this assumption is reasonably tolerable.

The situation is quite different for instruments from which a high degree of accuracy is required. More corrections, and to higher accuracy, must be made, and of course, greater care must be exercised in designing the parts significantly affecting the accuracy and in controlling the

environment of the barometer. The following table illustrates the situation for barometers, where corrections and controls are given to secure in one case, an accuracy of 0.1 mm of mercury and in the other, 0.01 mm of mercury in each factor. Obviously to increase the overall accuracy of the measurement, each factor must have a proportionately smaller tolerance.

The overall error can be easily held within 0.1 mm of mercury except for the temperature un-

The tolerance for each factor is for an error in that factor of either 0.10 or 0.01 mm of mercury.

Accuracy, mm of mercury— Inch of mercury—	0.10 0.004	0.01 0.0004
Factor	Tolerance	Tolerance
1. Zero error (stability of zero).....mm.	0.10	0.01
2. Scale error (reliability of scale).....mm.	.10	.01
3. Sensitivity of vernier or detecting means.....mm.	.10	.01
4. Temperature uncertainty at 1 atm.....° C.	.8	.08
at ½ atm.....° C.	1.6	.16
5. Capillary depression error.....mm.	0.10	.01
6. Alinement uncertainty (sec. 6.6):		
(a) Cosine error, at 1,000 mm of Hg.....	0°49'	0°15'
(b) Sine error, in practical cases.....	4 to 10'	0.4 to 1'
7. Vacuum uncertainty, mm of mercury.....	0.10	0.01
8. Gravity in cm/sec ² must be known at 45° latitude within at 1 atm.....	.13	.013
at ½ atm.....	.26	.026
9. Altitude difference in feet between measured and desired point, at 1 atm.....	3.6	.36

certainty, zero stability and capillary depression. Some care is necessary to be certain that the barometer temperature is known to an accuracy well within 0.8° C. The change in capillary error with time is such that in barometers with tubes less than about 12 mm bore, calibration will be frequently needed. For this a criterion is the degree of fouling of the mercury surface. For fixed cistern barometers, particularly if the cistern is opaque so the surface can not be seen, the zero shift in calibration due to volume changes in the cistern meniscus probably limits the accuracy at best to 0.1 mm of mercury.

On the other hand no portable barometer has as yet been developed which can meet all of the above tolerances for an accuracy of 0.01 mm of mercury. Items 2, 3, 4, 5, and 7 require special design features in the barometer to secure an accuracy sufficient to hold the overall error within 0.01 mm of mercury. This can be achieved apparently only in a precision type, laboratory instrument, not readily portable.

A number of the errors of barometers for which corrections can be more or less readily made, particularly for portable barometers, are considered in detail in the following sections. Other sources of error and methods and means for their correction for barometers of high precision are discussed in sec. 6.

8. Scale Errors

Strictly speaking, scale errors are the errors in the graduation of the scale at the chosen standard temperature. For standard barometers of high accuracy this definition holds. The scale can be checked against a standard meter bar and corrections are applied to the scale readings as found needed as a result of the calibration.

While many manufacturers take no less care in graduating the scales of portable barometers and manometers, the accuracy required does not ordinarily justify the expense of testing the scale alone. Uniformity in spacing the graduations which is absolutely essential, can be checked adequately by using the vernier as a length standard at various points on the scale.

This practice leads to a more practical definition of scale error. The portable instrument is calibrated against a standard barometer or manometer, and its readings corrected for temperature and gravity errors, zero error if obtainable, and possibly for capillary errors. The difference in the reading so corrected, and the pressure determined by the standard instrument is defined as the scale error.

The scale error thus derived may include errors: (a) Caused by installing the scale so that its zero or zero projected is not at the zero pressure point; (b) caused by overfilling or underfilling the instrument with mercury; (c) due to the effect in fixed cistern instruments of a tube bore different from

that for which the scale is graduated (foreshortening constant is in error); (d) due to incorrect alinement of sighting ring and vernier zero; (e) due to capillary error, if not separately corrected for; (f) due to sighting errors introduced by poor optical quality of the tubing; (g) due to the imperfection in the vacuum above the mercury column; and (h) due to temperature error if the installed thermometer is in error. Naturally in barometers and manometers of good design and where care is used in assembly, many of these errors are insignificant. An exception is the capillary error, which will change with time, as discussed in sec. 12. The size, and more important, the uniformity at various readings, of the scale error, together with the precision of reading, is a measure of the quality of the barometer or manometer.

8.1. Zero Error

The difference in reading of a U-tube, and the reading of a cistern, barometer or manometer when both mercury surfaces are subjected to the same pressure is defined as the zero error. The design may be such that the zero error cannot be obtained, notably Fortin and cistern instruments which do not have scales going to zero. It can be obtained on practically all U-tube instruments. Usually the zero error in barometers is determined when both mercury surfaces are subjected to a vacuum, but often when subjected to atmospheric

8.2. Method of Test

pressure. The value usually differs slightly in the two procedures, if no correction is made for capillarity, because of variability in the capillarity in the two surfaces, or because of possible flexure of the cistern of a fixed cistern barometer when vacuum is applied. It is usually more convenient to determine the zero error in barometers when both mercury surfaces are subjected to a vacuum; in manometers, when subjected to atmospheric pressure.

The zero error may include any error introduced by: (a) Failure to adjust the zero of the scale so as to indicate the height of the mercury column; (b) misalignment involving a sine error; and (c) capillary errors, to some degree.

If a U-tube barometer is installed; (a) To have no cosine error of misalignment; (b) has an adequate vacuum above the mercury column; (c) has a constant value of the sine error of misalignment; and (d) has a scale known to have adequate accuracy, a determination of the zero error, is all that is theoretically necessary to calibrate it. All of these assumptions can be verified without serious difficulty, and in fact must be met if any calibration is to have validity. Actually, as a check, comparison with a standard barometer at some pressure well above zero is advisable. The error thus found should agree, within the expected accuracy of the barometer, with the zero error.

The foregoing discussion applies also to a U-tube manometer, except of course, vacuum may not be involved.

The accuracy of a barometer is no greater than the accuracy with which its zero error can be determined. The probable error, and the average deviation and maximum deviation of a single observation of a number of independent observations of the zero error are all useful in determining the accuracy.

Knowledge of the zero error is extremely valuable to the ultimate user of the barometer or manometer, when it can be determined at any time with little trouble. If it differs significantly from the originally determined value, the installation can be checked for misalignment, the vacuum adequacy checked and the amount of mercury in cistern instruments corrected, as necessary. If a difference develops with time, capillarity change (dirty mercury) or loss of mercury from fixed cistern barometers is probably the cause, in which case the instrument tubing will need cleaning, or mercury needs to be added. If the change in zero error has some cause which it is not desired to correct, the calibration errors at all readings may be shifted by the amount of the change.

It should be noted that the zero error for U-tube instruments is not affected by normal changes in instrument temperature. The zero error of cistern barometers varies with temperature, in most practical designs, by an amount which does not exceed 0.1 mm for a 10° C (18° F) shift from the temperature at which it was originally determined.

The test for scale error at a single ambient temperature is often called a calibration test. It, and the zero determination if possible, are usually the only laboratory tests made on portable barometers or manometers. The test essentially consists in comparing the readings of the instrument under test at controlled pressures within its range with those of a standard instrument when both are subjected to the same pressure and to constant environmental conditions, mainly temperature.

Standard barometers or manometers are either primary standards or working standards. The primary standard has its precision and accuracy fixed by the excellence of its design and workmanship and by the application of corrections determined either theoretically or by test of its components against standards of the requisite accuracy. A working standard is one used to calibrate other instruments; in this sense a primary standard may also be a working standard. A working standard should ideally have a precision and accuracy about ten times that of the instrument under calibration; actually this is often of necessity violated in practice. In many cases the working standard of a manufacturer is a barometer or manometer of the same design as the instrument under calibration but is one selected for better quality which has been carefully calibrated.

As indicated in the table in sec. 7, the uncertainty in the temperature of both the working standard and the instrument under test must be much less than 0.8° C at 1 atm of pressure if an accuracy of 0.1 mm of mercury is to be obtained, and less than 0.08° C for an accuracy of 0.01 mm of mercury. These temperature uncertainties are proportional to the pressure, greater if the pressure is greater, and less if the pressure is less. This indicates the necessity of control of the ambient temperature. Due to the large thermal lag of barometers, the safest procedure is to maintain the instrument temperature constant within the necessary limits during the entire period of the test, and obviously during use afterwards also. Practically this requires installation in an air conditioned room, adequately ventilated, except for the short time when the room pressure has to be measured, when the ventilation may introduce undesirable pressure gradients. The scale error test is commonly made at a temperature between 22° and 25° C; at the National Bureau of Standards, 25° C.

In making readings the top of the mercury meniscus is always sighted upon.

In computing the scale error, the reading of the barometer under test is first corrected for zero, temperature and gravity error, which are discussed in other sections. The difference, corrected barometer reading minus the pressure determined from the reading of the standard barometer, is

the scale error. The scale correction is of the opposite algebraic sign.

If a correction is made for the capillary error, (see sec. 12), which is rarely applied to the readings of portable barometers, this correction is also applied to the reading, after applying the corrections for temperature and gravity error. The scale error is then computed as outlined above.

The procedure given above for computing the scale error is strictly speaking in error in that the temperature correction has also been applied to the scale error. This procedure could be corrected as follows: first determine an approximate scale error by the procedure outlined, then apply this scale correction to the reading and correct this reading for temperature and gravity error. The scale error is the original reading minus the last obtained corrected reading.

This refinement is ordinarily unnecessary for portable barometers. For example, assume a scale error of 4 mm of mercury (which is really excessive), and a temperature deviation of 15°C from the test temperature, then the error introduced is 0.01 mm of mercury (0.0004 in.), an insignificant amount. In effect this error is a measure of the undesired dependence of the scale error upon temperature.

8.2.1. Fortin Barometers

The distinguishing feature of barometers which are designed to measure atmospheric pressure only is that the air-space of the cistern is always connected to the ambient air. This class includes Fortin barometers and fixed cistern barometers, such as the Kew-pattern and Tonnelot. The construction of these barometers is such that the zero error can not be determined by direct observation; consequently the zero error is incorporated into the scale error. Normally, the barometers are tested when subjected to ambient atmospheric pressure.

The readings of these barometers are compared with those of a working standard for at least 10 days in order to obtain a valid correction. The thermometer attached to each barometer is also read. The comparison readings should be made when the atmospheric pressure is most free from oscillations, and sudden changes, which can be determined from the trace being made by a micro-barograph. These atmospheric pressure oscillations may occur suddenly and be 0.1 and more millimeters of mercury and are most troublesome when there is a high, gusty wind. Under these conditions simultaneity in the readings of the standard and the barometer under test is almost impossible to obtain. In Washington the most quiescent pressure period during normal working hours is from about 4 to 5 p.m.; normally valid comparisons can be made at this time three or four days each week.

The atmospheric pressure variation will almost never cover the pressure range of the barometer, normally about 75 mm of mercury or 100 mb.

Actually for this pressure range a single correction suffices, if the graduations of the scale are uniformly spaced, a condition which can be checked independently by readings made with the vernier at a number of positions on the scale.

However, barometers which have to be used at high elevations have a measuring range up to 250 mm of mercury. These are generally Fortin barometers. In these cases it is not entirely safe to assume that the scale error can be represented by a single number obtained in a test at sea level pressure. One way of testing these long-range barometers requires that they be installed in a chamber the internal pressure of which can be controlled and measured, as discussed in sec. 9.4.

Another way of obtaining a calibration of these long-range barometers, if accuracy requirements can be met, is to use as the working standard a fixed cistern barometer with an airtight cistern which has been tested as described in the next section. The scale error test as above described is then made at the high-altitude location of the barometer. This procedure is practical for the meteorological services, since the barometers at the various stations need to be tested from time to time, probably more conveniently done at the barometer station.

In testing atmospheric pressure barometers having a tubing bore of $\frac{1}{4}$ in. (6.35 mm), a Fortin barometer of known scale error having a tubing bore of 0.6 in. (15 mm) or more is adequate as a working standard. Fixed cistern barometers of the quality used to test aviation altimeters or precision aneroid barometers are equally serviceable as a working standard if their scale errors have been determined.

The average of the scale errors determined by the comparison readings is taken as the scale error of the barometer, if all are considered equally valid and there is no indication that the scale error varies with the scale reading. Maximum deviations from the average and the probable error of a single observation, if at least about ten comparisons are available, are computed, and are indicators of the quality of the barometer.

8.2.2. Altitude Barometers

Testing altitude barometers requires a closed system essentially such as shown schematically in figure 2. Altitude barometers include all those in which the cistern is airtight except for a nipple, and U-tube barometers. In figure 2, *S* is a standard barometer of the U-tube type with its scale; *B*₁, *B*₂, and *B*₃ are barometers to be tested; *VP* is a vacuum pump; *F* is a filter; *M* is a large volume manifold; *B* is a barostat; and *A* is an air supply.

The system must be leaktight in order to avoid pressure gradients in the system which will affect the accuracy of the readings. Insofar as possible metal or glass tubing should be used, using butyl rubber or plastic tubing only to make short length connections. Rubber tubing can be used only if

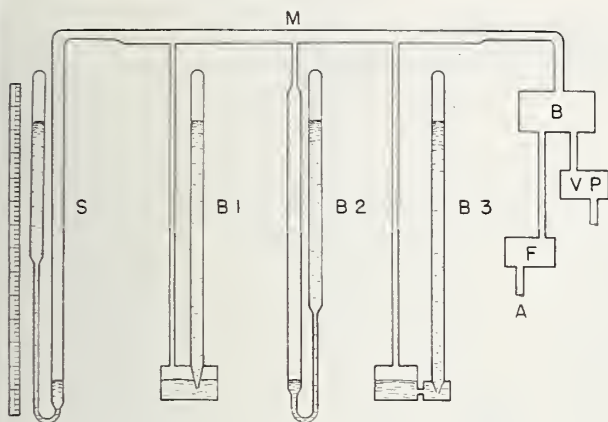

FIGURE 2. Set up for testing altitude barometers.

S, standard barometer (see fig. 1); B1, fixed cistern barometer; B2, U-tube barometer; B3, high altitude range fixed cistern barometer; B, barostat; F, filter; M, large volume manifold or plenum chamber; A, air supply, VP, vacuum pump.

practically free from sulfur. Satisfactory tubing of rubber or plastic is hard to find, since some give up gasses which contaminate the mercury and others are permeable to air or water vapor to an objectionable degree. To test for tightness, the system is subjected to the lowest pressure indicated by the barometers. The barometers are read, and the procedure is repeated again the next day. A rise in pressure of about a centimeter of mercury is considered excessive. To locate leaks, various parts of the system, including individual barometers, can be isolated by pinch clamps after making the initial readings.

The barostat, used to maintain the absolute pressure in the system at constant selected value, is a valuable accessory. It will be described in sec. 8.3.

The test procedure is simple in principle. The absolute pressure in the system is controlled by operating the vacuum pump, control valves and setting the barostat if one is available. At each pressure step, the standard barometer, barometers under test, and the thermometers associated with each barometer are read. It is preferable to make readings on both the down and up side of the pressure cycle. From these readings the pressure is obtained by applying the necessary corrections to readings made on the standard barometer. The readings of the barometers under test are corrected for zero, temperature and gravity errors. The scale errors are then computed. Obviously if the barometer under test has an automatic corrector for temperature and gravity errors, this is set to the correct ambient values of these quantities, and the scale error is the difference, barometer reading minus the pressure. Again, if the barometer under test is maintained at a constant temperature in its own chamber and its scale is graduated to read free from temperature error, only the gravity correction need be applied to its reading.

Usually, due to the labor and expense involved, only two tests on different days are ordinarily made on a given instrument to determine the scale errors. Several independent readings at each test point are a big aid in fixing limits to the accuracy, as well as giving an average value to use as the scale error.

8.2.3. Manometers

The apparatus and procedure for calibrating differential mercury manometers are similar in details to those for altitude barometers shown in figure 2. Since differential (usually gage) pressure is measured, the standard manometer has no evacuated space above the mercury column.

Instead of the barostat, a pressure controller is used. A commercially available diaphragm type pump in combination with a ballast chamber and pressure controller is convenient for the purpose.

Perhaps the most important difference is in the range of the manometers now needed, which now extends to 4 atm and more. Portability becomes a problem, so that testing against a standard at some other laboratory becomes impractical. This means that the scale only can be checked for accuracy and the desired accuracy must be designed into the manometer and its installation.

8.3. Barostat

The barostat designed and used at the National Bureau of Standards is shown in cross section in figure 3. Plates *B* and *H* are fixed in relative positions by four rods. Plates *F* and *G* are free to move between limit stops. Bellows *E* is sealed gastight to plates *F* and *H*, and is evacuated. Bellows *A* is sealed by plates *B* and *G* and has three connections through plate *B*, one at *P* for an air intake, one at *S* for connection to a vacuum pump, and one at *T* connecting into the system the absolute pressure of which is to be controlled. The pressure control valve consists of a ball *V* attached to spring *L*. Spring controlled plunger *D* operates the valve. The ball seats into a conical opening. The plates *F* and *G* are connected to a scale pan on which weights *M* can be placed.

In operation weights, corresponding to a pressure approximately the value desired, are placed upon the pan. If chamber *A* is originally at atmospheric pressure the plates *F* and *G* remain against the upper stop and the valve *KV* is consequently wide open. With air entering tube *P* and being evacuated through tube *S*, the pressure in bellows *A* falls until the pressure therein balances the weights. At this pressure the valve *KV* closes sufficiently so that the air flowing in through *P* equals that flowing out through *S*. Any deviation in flow changes the upward force on *FG* and either opens or closes valve *KV*, which changes the air-flow through *S* until the pressure in *A* again balances the weights.

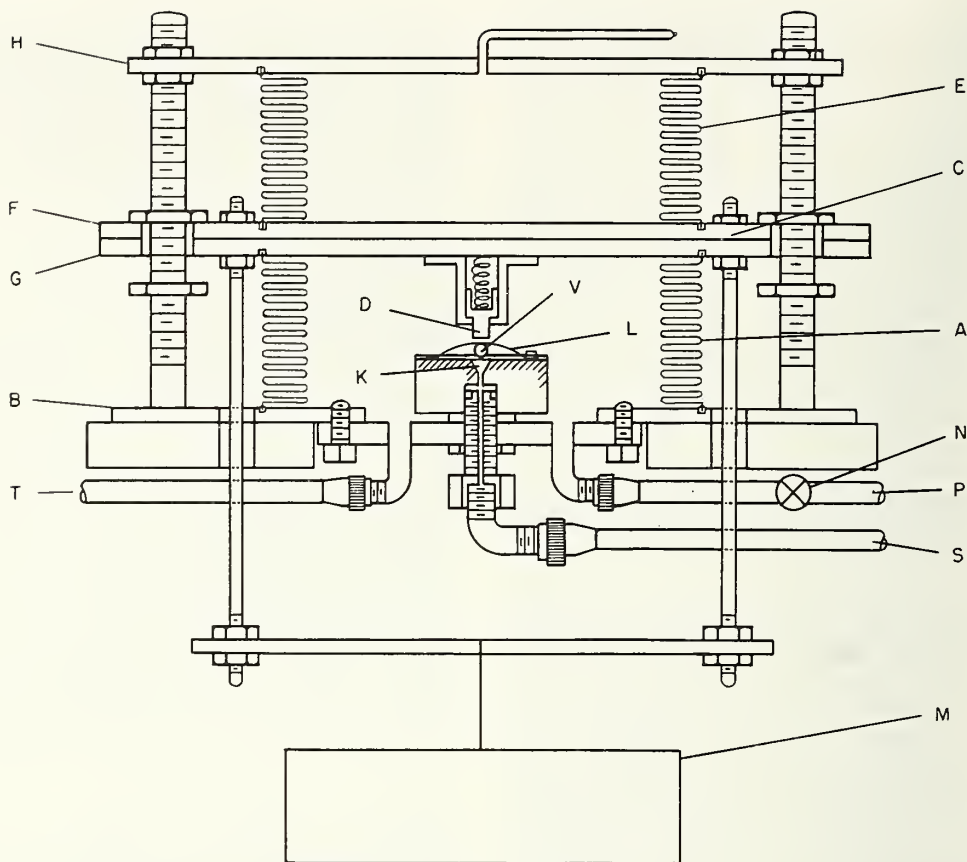

FIGURE 3. NBS barostat.

E, evacuated bellows; *A*, bellows maintained at desired pressure; *H* and *B*, fixed mounting plates; *F* and *G*, floating mounting plates; *M*, weights attached to *F* and *G*; *D*, spring controlled plunger; *V*, ball valve attached to spring *L*; *K*, valve seat; *P*, pressure line; *S*, suction or vacuum line; *N*, a valve; *T*, line to system the pressure of which is controlled by the barostat.

The performance is dependent upon the flow of air into bellows *A* through *P*; for optimum pressure control this airflow is about 1 liter/min secured by valve *N* and a suitable rotameter in line *P*, not shown in figure 3.

The bellows are copper plated brass and are about $5\frac{1}{4}$ in. in diam. The weight required to balance at 1 atm is nominally 330 lbs. These weights are applied manually; a mechanical weight lifter would be a desirable improvement.

The barostat controls the pressure to within 0.01 mm of mercury during the time needed to make readings, about 10 min.

The barostat fails as an absolute pressure gage by a few tenths of a millimeter of mercury, that is the pressure obtained at various times by a given weight does not repeat by this amount. Perfection of the barostat in this respect has not been undertaken.

9. Temperature Errors

It is evident that mercury barometers and manometers can read correctly at only one temperature principally because of the thermal expansion of the mercury and the scale, but also of certain other parts of the instrument. The height of the mercury column in terms of the density of mercury at 0°C (32°F) is desired. Deviations from the selected standard temperature requires the application of corrections to the instrument readings.

Generally the scale is graduated so that the column height is indicated when the scale is at 0°C . Exceptions are that manometers fre-

quently, and barometers more rarely, have scales graduated to indicate the height of the mercury column at 0°C when the instrument temperature is at some selected value, commonly 20° or 25°C (68° or 77°F). Also, an exception are the scales of Fortin barometers still in use in meteorology graduated in inches, which are specified to indicate inches accurately when the scale is at 62°F (16.67°C). The requirement now is that the scale be graduated to be accurate at 0°C (32°F) [564].

The temperature correction for all types of

barometers and manometers is generally computed from formulas derived from the pertinent design constants of the instruments and the coefficients of thermal expansion of the pertinent parts. For any particular design, tests are essential in order to check the validity of the assumptions made in deriving the correction formula; these tests are particularly essential if the barometer or manometer temperature is much different from that at which the zero and scale errors were determined.

The thermometers attached to barometers and manometers may be in error. If no correction is applied for such error, either during calibration or service use of the barometer, and the error has a small constant value at all temperatures experienced, the resultant error in the temperature correction of the barometer will be almost entirely absorbed in the scale error. Variable errors in the attached thermometer over a few tenths of a degree may introduce significant errors in the pressure determination, unless corrected. If there are errors in the thermometer, any correction table which is set up for the barometer should obviously be based upon the reading of the thermometer, not the true temperature.

9.1. Basic Formula

The basic temperature correction formula is applicable to all portable barometers and manometers in which the height of the column is measured with a scale not foreshortened. It is directly applicable to Fortin and U-tube barometers and U-tube manometers, and as will be discussed later, with some modification to fixed cistern instruments.

The following terms are defined:

C_t = temperature correction of barometer reading to secure height of column at t_0

R_s = barometer reading corrected for scale error

R_t = barometer reading corrected for scale and temperature error

t = barometer temperature

t_0 = standard temperature for height of mercury column, usually 0°C or 32°F

t_1 = temperature at which the scale indicates the true height

m = cubical coefficient of thermal expansion of mercury per $^\circ\text{C}$ or $^\circ\text{F}$ as applicable

s = linear coefficient of thermal expansion of the scale per $^\circ\text{C}$ or $^\circ\text{F}$, as applicable

h = height of the mercury column at t

F = a factor defined in eq (24) and (25).

The basic formula for the temperature correction will be derived for the general case where the reference temperature for both the mercury column and scale is unspecified.

First, to determine the height h of the mercury column at temperature t , it is seen that as the temperature of the scale decreases from t to t_1 , the reading on the scale at the meniscus level increases. The height h of the column at t_1 is the original reading R_s plus the contraction of the scale in going from t to t_1 , or

$$h = R_s[1 + s(t - t_1)]. \quad (18)$$

The contraction of the mercury column from temperature t to t_0 can now be written,

$$h = R_d[1 + m(t - t_0)]. \quad (19)$$

If

$$R_t = R_s + C_t, \quad (20)$$

it follows from eq (18) and (19) that

$$C_t = \frac{s(t - t_1) - m(t - t_0)}{1 + m(t - t_0)} R_s. \quad (21)$$

Ordinarily the coefficient of expansion s is listed with reference either to 0°C or 32°F ; therefore s in eq (18) and (21) differs from the ordinarily defined value if t_1 is not 0°C or 32°F . Let s_1 be the value of s at t_1 . Then

$$L_2 = L_0[1 + s(t - t_1)] \quad (22)$$

$$L_2 = L_1[1 + s_1(t - t_1)] \quad (22a)$$

where L_0 , L_1 , and L_2 are the scale lengths at 0°C , t_1 , and t , respectively.

It follows that

$$s_1 = \frac{L_0}{L_1} \left(\frac{1}{t - t_1} + s \right) - \frac{1}{t - t_1} = \frac{sL_0}{L_1}. \quad (23)$$

Since L_0/L_1 is very nearly unity, the approximation sL_0/L_1 is justified; in fact with usually insignificant error in all but precise manometry, $s = s_1$.

The choice of the form of the above formulas is based upon the premise that it is more convenient to apply a small correction, derived from convenient tables than to make basic computations. A constant value of the thermal expansion of mercury, m , is assumed, which is sufficiently accurate for all but precise manometry. (See sec. 4.1.)

If an electric computer is available, a more fundamental procedure is outlined in section 10.1, eq (45), where the temperature and gravity corrections are made in one operation.

9.2. Fortin Barometers, U-tube Barometers and Manometers

Since pressure in terms of the height of a mercury column is defined in terms of the density of mercury at 0° C (32° F), t_0 in eq (21) is either 0° or 32°, depending upon whether t is in degrees Celsius (Centigrade) or Fahrenheit.

While generally scales are used or specified to have the indicated length at 0° C, exceptions exist. These cases will be discussed in the sections immediately following.

It is assumed that the scales are graduated to indicate a length accurately, that is the scale is not foreshortened, as in the case of cistern instruments. It is also assumed that the scale, or metal the same as the scale material, extends downward to the level of the mercury in the cistern. This assumption is usually violated in Fortin barometers to some degree in that diverse materials are used in the cistern. Thus the coefficient of expansion s may not apply for a short length just above the cistern mercury level. Only the difference from the coefficient of expansion of the scale introduces an error. Neglect of these sources of error does not seriously affect the accuracy if the ambient barometer temperatures do not differ greatly from the temperature at which the barometer was tested. The error in the applied temperature correction is completely absorbed by the applied scale correction when the barometer is at the temperature at which the scale error test was made, and to a major amount at other barometer temperatures.

9.2.1. Scale Accurate at 0° C

When the scale is graduated to be accurate at 0° C, $t_0 = t_1$. Equation (21) then becomes, when t is in °C

$$C_t = R_t - R_s = \frac{(s-m)tR_s}{1+m} = FR_s \quad (24)$$

and when t is in degrees Fahrenheit

$$C_t = \frac{(s-m)(t-32)R_s}{1+m(t-32)} = FR_s \quad (25)$$

The factor F is identical in value in eq (24) and (25) at the same temperature. It follows therefore that a table of corrections against temperature in either °C or °F is equally applicable for all units of pressure, including millibars, millimeters or inches of mercury, if entered with the temperature in the unit for which the table was computed. Note, however, that F is not identical in the two equations if the scales are not accurate at 0° C or 32° F.

When a mechanical computer is available, the following relation is useful, particularly when many readings are taken at the same temperature.

$$R_t = \left[1 + \frac{(s-m)(t-t_0)}{1+m(t-t_0)} \right] R_s = YR_s \quad (26)$$

where $Y = 1 + C_t$.

The value of Y can be obtained from a computed table of Y against temperature t or table 7 as discussed in sec. 9.5.

For portable barometers it is sufficiently accurate to use a constant value of m , the cubical expansion of mercury, over the temperature range normally expected; if more precision is necessary, see sec. 4.1. The accepted value of m is 181.8×10^{-6} per °C or 101.0×10^{-6} per °F.

The value of the linear coefficient of expansion varies somewhat for a given scale material, depending upon its exact composition and the degree of cold work. The exact value when required must be determined experimentally. Average values for a number of materials used either for the scale or cistern are given in table 5. The value for brass is taken from ref [512]; the others, from other published data.

Commonly the scales of Fortin and other barometers are made of yellow brass for which the value of s , the coefficient of linear expansion, is generally assumed to be 18.4×10^{-6} per °C. Using this value of s and 181.8×10^{-6} for m , the cubical expansion of mercury, eq (24) becomes

$$C_t = -\frac{163.4 \times 10^{-6} t R_s}{1 + 181.8 \times 10^{-6} t} \quad (27)$$

and eq (25) where t is in °F, becomes

$$C_t = -\frac{90.78 \times 10^{-6} (t-32) R_s}{1 + 101.0 \times 10^{-6} (t-32)} \quad (28)$$

In these equations C_t will be in the same unit of pressure as R_s , and apply equally for scales graduated in any pressure unit. The correction C_t is negative for temperatures above 0° C or 32° F, and the correction is therefore to be subtracted from reading R_s , corrected for scale error.

Correction tables based upon eq (27) are given in table 6 of this report (see sec. 9.5. for discussion), and also in ref [512]. If the barometer temperature is measured in °F, as indicated in eq (28), these tables are equally applicable if they be entered with the equivalent temperature in °C. Tables based upon eq (28) are given in ref [591].

9.2.2. Fortin Barometers, Scale Accurate at 62° F

Fortin barometers graduated in inches of mercury used in meteorology have the scale specified graduated to be accurate at 62° F (16.67° C). In view of the adoption of the millibar as the international standard unit of pressure by the meteorological services, Fortin barometers calibrated in inches of mercury are becoming obsolete; however, some of these are still used in industry. It is advocated that in the future the scales of all

Fortin barometers be calibrated accurate at 0° C, to secure agreement with the calibration practice followed for Fortin barometers calibrated in other pressure units.

For barometer scales graduated to be accurate at 62° F, formula (22) becomes, when t is in °F.

$$C_t = \frac{(t-62)s - (t-32)m}{1+m(t-32)} R_s. \quad (29)$$

Inserting the value of s for a brass scale, 10.2×10^{-6} per °F and m , the volume expansion coefficient of mercury, 101.0×10^{-6} per °F, eq (29) becomes

$$C_t = \frac{(90.8t - 2599.6) 10^{-6}}{1 + 101 \times 10^{-6}(t-32)} R_s. \quad (30)$$

Here t is in °F and C_t and R_t are customarily in inches of mercury only.

The temperature correction is zero at all values of R_s at 28.6° F and is negative at all temperature above this value, meaning that the correction is to be subtracted from the barometer reading.

Correction tables based upon eq (30) are available [301, 512, 591].

9.2.3. Scale Accurate at Unknown Temperature

It is necessary to consider the case where the temperature at which the scale is accurate is unknown. It is assumed that the scale is graduated uniformly.

For U-tube instruments and Fortin barometers with a thermometer graduated in °C, eq (22) can be modified to give

$$C_t = \frac{[s(t-t_1) - mt] R_s}{1+mt} = \frac{(s-m)t R_s}{1+mt} - \frac{st_1 R_s}{1+mt}, \quad (31)$$

where t_1 is the temperature at which the scale correctly indicates the height of the column.

The last member of the equation contains the factor $1+mt$ which affects the value of the last member only 0.7 percent at $t=40^\circ$ C, and less at lower temperatures and C_t not more than 0.1 percent. Without significant error eq (31) then becomes

$$C_t = \frac{(s-m)t R_s}{1+mt} - st_1 R_s. \quad (32)$$

The last term in eq (32) is therefore a constant at a given reading R_s well within the accuracy of barometers of this quality and therefore can be incorporated into the scale correction. To do so may require determining the scale error against reading over the range of indication. In determining the scale error, the temperature correction applied is the same as that for the case when the scale reads correctly at 0° C or 32° F given by eq (24) or (25). The residual error, after applying the usual gravity correction to the reading, is the

scale error. Thus, at the calibration temperature, the term $st_1 R_s = 0$.

If the barometer has a brass scale, table 6 can be used to obtain the temperature correction.

9.2.4. Scale Indicates Pressure, Instrument Temperature Not 0° C

Assume that the scale indicates the height of the mercury column at 0° C when the instrument is at a temperature t_s . This procedure is fairly common for U-tube manometers and barometers but rarely for Fortin barometers. A temperature between 20° to 25° C (68° to 77° F) is commonly selected and it is here assumed that the temperature of the barometer or manometer is not subsequently controlled.

When the ambient temperature, that is the instrument temperature t , differs from t_s , the temperature at which the barometer reads free from temperature error, the temperature correction is (noting the discussion on the value of s in sec. 9.1.):

$$C_t = \frac{(s-m)(t-t_s) R_s}{1+mt}. \quad (33)$$

It is seen that table 6 can be used to obtain approximate temperature corrections based upon eq (33), if the scale is of brass, by entering the table with R_s , the reading corrected for scale error and the temperature difference $(t-t_s)$ in degree centigrade. Obviously, the correction is to be subtracted from R_s if $(t-t_s)$ is positive; otherwise, added. In the table the computation is for $1+mt$ instead of $1+mt$ given in the equation; the error in the correction is less than 0.3 percent when $t_s=25^\circ$ C and $t-t_s$ does not exceed 10° C.

Some manometers designed for relatively rough measurements have scales graduated as described. With the advent of air conditioning for most laboratories, the need for any temperature correction for manometers of this quality almost disappears. In any event, corrections based upon eq (33) are accurate.

Many manometers and barometers of high quality are installed in a temperature controlled room or in a cabinet the temperature within which is controlled to give readings free from temperature errors. The only temperature error which may need to be applied is that for minor deviations, of the order of 1° C, from the supposedly maintained temperature. Greater temperature deviations indicate improper functioning which should be corrected. The temperature correction can be obtained without significant error from table 6, or computed accurately from eq (33).

9.3. Fixed Cistern Barometers and Manometers

The temperature correction for fixed cistern instruments differs only from that of U-tube instruments in that the differential expansion of the

mercury in the cistern and of the cistern changes the zero position of the mercury surface with reference to the scale zero.

If the zero error of a fixed cistern instrument can be determined at several temperatures, as is the case for many modern designs, it is only necessary to apply the zero correction for the particular barometer temperature. Only the temperature correction as discussed for U-tube instruments needs then to be applied.

9.3.1. Scale Accurate at 0° C

When the zero error can not be determined, the temperature correction of fixed cistern barometers and manometers is difficult to compute accurately because simplifying assumptions must be made as to the construction of the parts affecting the change in reading with temperature, in order to obtain formulas practical to use. In the end it is essential to test each design of fixed cistern barometer at two or more temperatures in order to be able to compute a valid temperature correction.

Assume most simply that the fixed cistern instrument is so designed that the scale extends down to the level of the mercury in the cistern, reads zero at zero pressure and 0° C and is graduated to be accurate at 0° C. Also assume that the cistern is made of materials having the same coefficient of expansion. In this simple case the temperature correction C_t is, neglecting second order terms,

$$C_t = \frac{(s-m)tR_s}{1+mt} + \frac{V_0(3s_c-m)t}{A_0(1+mt+2s_c t)} \quad (34)$$

The terms not previously defined are:

V_0 = the volume of mercury at zero pressure and at 0° C

A_0 = the effective area of the cistern at 0° C, assumed to be uniform

s_c = the linear coefficient of thermal expansion of the cistern material

t = barometer temperature in ° C.

If the cistern is made of diverse materials, s_c is not a simple constant, but is a function of several constants. For example if the cistern has a steel base and glass walls, $3s_c$ becomes $s_g + 2s_s$ and $2s_c$ becomes $2s_s$ where the subscripts g and s refer to glass and steel, respectively.

With obvious modifications the formula applies also if the temperature is measured in degrees Fahrenheit.

The first term of eq (34) is the same as the temperature correction for Fortin barometers; the second term corrects for the rise of level of mercury in the cistern with temperature which introduces an error because the scale, and its zero point, are in a fixed position.

The term V_0/A_0 in eq (34) equals the height of the mercury in the cistern at zero pressure.

More or less approximately, in eq (34)

$$\frac{(s-m)}{1+mt} = \frac{3s_c-m}{1+(m-2s_c)t} \quad (35)$$

since in general s_c is much less than s and m . Approximately therefore eq (34) becomes

$$C_t = \frac{(s-m)t}{1+mt} (R_s + K), \quad (36)$$

where K is a constant approximately equal to V_0/A_0 which can be added to the reading corrected for scale error R_s [231]. This simplifies computation and permits using table 6 if the scale is brass, which is entered with $R_s + K$ and the barometer temperature.

In various designs of fixed cistern barometers the computed K will vary from about 35 to 75 mm, with an uncertainty up to 20 percent due to deviations from the simple assumptions made. If K is determined by tests made at two or more temperatures, the uncertainty of course disappears, but some lack of constancy may remain, in the practical case usually negligible. It is a matter of convenience whether this deviation is incorporated in the temperature error or in the scale error; if the latter, the scale error will vary with temperature.

The difficulties in determining the exact temperature correction of fixed cistern barometers is a limitation upon the attainable accuracy. When the accuracy must be better than about ± 0.1 mm of mercury (0.004 in.) it is necessary to maintain the barometer at constant temperature, so that the temperature error can be incorporated once for all into the scale error. This remark applies particularly to altitude barometers.

9.3.2. Scale Accurate at Unknown Temperature

In some barometers and manometers of the fixed cistern type of relatively low precision and accuracy, scales, desired to be correct at 0° C, are ruled without care being taken to have them read correctly at precisely 0° C. This case is discussed in some detail for Fortin barometers in section 9.1.2. For fixed cistern instruments the last term of eq (31) or (32) needs to be added to eq (36). Again this approximately constant term can be absorbed into the scale error with negligible error in the practical case.

9.3.3. Scale Indicates Pressure, Instrument Temperature Not 0° C

In this case the barometer or manometer is to be maintained at some constant temperature in the range 25° to 45° C, and the scale is ruled so that the pressure is indicated, that is, no temperature (and no gravity) correction needs to be

applied. For small deviations in temperature from the selected constant temperature, t_s , the temperature correction, is with negligible error,

$$C_i = \frac{(s-m)(t-t_s)}{1+mt} (R_s+K). \quad (37)$$

This relation is based upon eq (33) and (36) and the assumptions made in their deviation also apply. The equation should only be used if the zero error can not be measured at the two temperatures t and t_s . If it can, the procedure outlined in section 9.3. is preferable and more accurate.

9.3.4. Fixed Cistern Barometers With An Altitude Scale

In calibrating altimeters it is often required that the altimeter be subjected to pressures corresponding to definite pressure altitudes. The barometer is always equipped with a pressure scale and sometimes with an auxiliary scale graduated at 1,000 or 500 ft intervals. Having an altitude scale only is impractical because the graduations are nonuniform, making the use of a vernier impractical.

On the above basis, it follows that accuracy in producing fixed pressure altitudes from an altitude scale is obtainable only when the barometer is maintained at a constant temperature and has no scale error. The altitude scale should be graduated so that allowance is made for the temperature error (and the gravity error at any one location).

If the barometer temperature is allowed to vary with uncontrolled ambient temperature, the most practical procedure is to precompute the barometer reading in pressure units for the desired pressure altitudes. The pressure in the system is then successively brought to correspond with these readings. In precomputing, it must be remembered that the available corrections are to be applied to the readings, not the pressure. Therefore, the temperature (and gravity) corrections (with reversed signs) are first applied to the pressure giving an approximate reading. Repeating the process, using the approximate reading instead of the pressure usually gives a sufficiently accurate reading. The process can be repeated if greater accuracy is warranted. The scale (and zero, if determined,) corrections (with reversed signs) need still to be applied to the reading corrected for temperature (and gravity) to obtain the reading corresponding to the pressure.

Since pressure altitude varies as the logarithm of the pressure, the limiting sensitivity or accuracy in altitude units varies with pressure. Thus, if the accuracy of the barometer in measuring pressure is 0.1 mm of mercury, in pressure altitude units this equals 3.6 ft at 0; 6.8 ft at 20,000 ft; 14.8 ft at 40,000 ft; and 39 ft at 60,000 ft of pressure altitude.

Theoretically it is of interest that the temperature correction c_h of a fixed cistern barometer in pressure altitude units,

$$c_h = \frac{RT}{gP} \frac{(m-s)t}{(1+mt)} (R_s+K) \quad (38)$$

is almost constant at all values of the pressure, since $(R_s+K)T/P$ is almost constant in value. Here R is the gas constant for air, T and P are respectively the temperature and pressure in the standard atmosphere and g is the acceleration of gravity.

9.4. Method of Test

The method of testing for temperature errors differs only from that for scale error for the various types of instruments described in sec. 8.1. in that control of the temperature of the barometers and manometers is required. The standard instrument is probably best maintained at its usual operating temperature, but it is advantageous to operate working standards at the same temperature as the instrument under test.

Generally U-tube instruments do not require temperature tests. It is ordinarily only necessary to check their scales, or the precision screw if used, at several temperatures in order to determine its thermal coefficient of expansion, or its length at the temperature of use, if the instrument temperature is controlled. The temperature correction can then be accurately computed.

This makes it only necessary to test Fortin and fixed cistern barometers, particularly the latter. The choice of temperature chamber lies between a small one in which manipulation of the sighting means, sighting, and reading are done from the outside and a temperature chamber large enough for personnel to enter to make the adjustments and reading. The large temperature chamber is definitely more advantageous for fixed cistern instruments with airtight cisterns. Only temperature control is needed which offers no primary difficulty.

For Fortin barometers and fixed cistern barometers which measure ambient pressure only, and thus have cisterns which are not gastight, pressure and temperature must both be simultaneously controlled in the temperature chamber. This is more difficult in a large temperature chamber, but the difficulty is balanced by the difficulty of adding means for operation and reading from the outside of a small temperature pressure chamber. It is debatable which of the two sizes of chamber is preferable; experience indicates a preference for the large chamber.

It appears necessary to test instruments at least three temperatures if they will experience large temperature differences in service. For computing, it is the aim to divide the overall error into a scale error constant at any one reading, and into a temperature error linear with the reading corrected for scale error. The temperature error so derived should be reasonably consistent with the applicable equation for temperature correction, after insertion of the values of the constants computed from the test results. Any other test

result gives rise to the suspicion that either the test results are unreliable or the design or construction of the barometer needs improvement.

A procedure is outlined in ref. [591] whereby the temperature and scale errors of cistern barometers can be determined from tests at three temperatures, if the pressure is adjusted so that the cistern barometers have precisely the same readings at each temperature.

9.5. Temperature Correction Tables

As has been stated correction tables are given in table 6, based upon the equation

$$C_t = \frac{(s-m)tR_s}{1+mt} = \frac{163.4 \times 10^{-6} t R_s}{1 - 181.8 \times 10^{-6} t} \quad (27)$$

The table covers the temperature range 0° to 50° C and barometer readings (corrected for scale error) from 100 to 1,195 in steps of 5. The table may be entered with the barometer reading in any unit of pressure, ordinarily millibars, inches or millimeters of mercury to obtain a correction in the same unit of pressure.

The table applies only when the scale is graduated to indicate length accurately at 0° C and has a thermal coefficient of expansion of 18.4×10^{-6} per degree Celsius (centigrade) which is closely that of yellow brass. The volume coefficient of expansion of mercury assumed is 181.8×10^{-6} per degree Celsius (centigrade).

All corrections given in table 6 are to be subtracted from the instrument reading, corrected for scale error.

Temperature corrections can be obtained with sufficient accuracy from table 6 for practically all portable barometers which have brass scales. The instruments for which it can be used are listed below, together with a discussion of the limitations.

(a) The table applies to all Fortin barometers and U-tube barometers and manometers which have brass scales graduated to be accurate at 0° C in any pressure unit, particularly millibars, inches, or millimeters of mercury, and when the instrument temperature of which is measured in, or converted to ° C.

(b) The table applies to all Fortin barometers and U-tube barometers and manometers which have brass scales graduated presumably to measure length, or a length proportional to pressure, accurately at 0° C but actually do so at some temperature between about -10 to 25° C. The instrument temperature must be measured, or converted to, degrees Centigrade. Using the table may necessitate applying a scale error determined by test which will vary with the reading as indicated by eq (32). For example, if the scale is accurate at 20° C, the scale error will vary linearly from 0.20 to 0.30 mm at readings varying from 543 to 815 mm.

(c) The table can be used usually with negligible error to obtain the temperature correction of

U-tube barometers and manometers the scales of which are graduated to read free from temperature error at a selected temperature other than 0° C, if the temperature of the instrument differs only slightly from the selected temperature. The scale must be brass and the temperature deviation must be in deg Celsius (Centigrade). The table is entered with the deviation in temperature and the instrument reading corrected for scale error. The resulting correction is subtracted if the instrument temperature is greater than the selected temperature, and vice versa.

(d) The table can be used to obtain the temperature corrections of fixed cistern barometers and manometers with brass scales graduated in any pressure unit, particularly millimeters or inches of mercury or millibars and the instrument temperature is known in deg Celsius (Centigrade). The table is entered with the instrument temperature and with the sum of two quantities as indicated in eq (36), the barometer reading corrected for scale error, and the approximate constant K . This K is approximately the height at 0° C of the mercury in the cistern at zero pressure difference in the tube and cistern, but should be determined by testing the instrument at several temperatures. There is somewhat less uncertainty in the computed value of K if the brass scale is graduated to be accurate at 0° C and extends down to the mercury level in the cistern and if the cistern is made of materials having a low value of the thermal coefficient of expansion.

(e) The table can be used usually with negligible error to obtain the temperature corrections of fixed cistern barometers and manometers, the brass scales of which are calibrated to read free from temperature error at a selected barometer temperature other than 0° C, if the instrument temperature differs only slightly from the selected temperature. The table is entered with the deviation of the instrument temperature from the selected temperature, instead of the instrument temperature. With this exception the discussion in (d) above applies. The correction obtained from the table is subtracted from the reading where the instrument temperature is higher than the selected temperature, and vice versa.

It is perhaps unnecessary to add that for highly precise measurements for which correspondingly high quality instrumentation is required, table 6 is not sufficiently accurate. The temperature errors of the scale may need to be determined more precisely and more accurate values of the density of mercury as given in tables 2, 3, or 4 may need to be used.

The temperature correction factor F defined in eq (24) and (25), that is

$$F = \frac{(s-m)t}{1+mt} \quad (39)$$

is given in table 7 as a function of instrument temperature and of the thermal coefficient of

expansion s of the scale. These are useful for making computations when table 6 does not apply. The values are for a value of the thermal coefficient of the volume expansion of mercury m of 181.8×10^{-6} per deg Centigrade. Values of Y , eq (26) can be obtained from table 6 by adding 1 to the value of F , if $t_1 = t_0 = 0$ in eq (26).

The factor F given in table 7 can be used for computing the temperature correction with an accuracy sufficient for most portable barometers

and manometers having scales of the material indicated. For greater accuracy the precise value of the expansion coefficient s must be known for the scale.

If the corrections for the expansion of the scale and of mercury are determined separately, the value of F in table 7 for invar ($s=0$) applies for the effect of the expansion of mercury.

The factor F given for brass ($s=18.4 \times 10^{-6}$) was used in computing table 6.

10. Gravity Errors

10.1 Basic Relations

It is necessary to correct the observed height of all mercury columns for the deviation of the acceleration of gravity from the standard value, 980.665 cm/sec² (32.1740 ft/sec²). The standard acceleration of gravity is assumed in the definition of the inch and millimeter of mercury as a unit of pressure and in the graduation of barometer scales in millibars.

The correction, derived from eq (1) is

$$C_g = \frac{g - g_s}{g_s} R_t = F_g R_t \quad (40)$$

$$R_g = R_t + C_g \quad (41)$$

where C_g is the gravity correction; g and g_s , the acceleration of gravity at the location of the instrument and the standard value, respectively; R_t and R_g , the instrument reading corrected for temperature and for gravity, respectively.

If no additional corrections are to be applied, as is often the case with portable instruments, R_g is the pressure in any unit in which the instrument is calibrated.

With equal accuracy

$$C_g = \frac{g - g_s}{g_s} R_s = F_g R_s \quad (42)$$

$$R_{sg} = R_s + C_g \quad (43)$$

Here R_s is the instrument reading corrected for scale error and R_{sg} is the same corrected for scale and gravity error. The temperature correction is then obtained for R_{sg} and applied to R_{sg} to obtain the reading corrected for both temperature and gravity errors.

It may be preferable in precise measurements to compute the temperature and gravity corrections in a single operation, particularly if corrections are first and separately made for the calibration and temperature errors of the scale. The temperature error of the scale is given by eq (19). From eq (1)

$$\rho_s g_s h_s = \rho g h \quad (44)$$

and

$$h_s = \frac{\rho g h}{\rho_s g_s} \quad (45)$$

Here ρ_s and ρ are respectively the densities of mercury at 0° C and at the instrument temperature; h is the true height of the mercury column at the instrument temperature and ambient gravity; h_s is the desired true height under standard conditions, that is the pressure, if no other corrections are to be applied; and g and g_s have been defined.

The ratio of the densities of mercury can be obtained from table 2, or computed from table 3 or table 4.

10.2. Value of Gravity at the Instrument Location

It remains to discuss how the acceleration of gravity g may be obtained. The U.S. Coast and Geodetic Survey has determined the acceleration of gravity at many points in the United States and using these values, the U.S. Geological Survey has made determinations at additional locations. At the moment the gravity values are based upon the Potsdam primary determination; later primary determinations indicate that the Potsdam value is 0.013 cm/sec² too high. The International Meteorological Organization has adopted the latest primary value; gravity data given in ref. [512] are also based on the latest primary value. If the location of the instrument is reasonably close to a point or points where the value is known, interpolation and application of the elevation correction to be discussed below, may serve to obtain the value of g to sufficient accuracy.

For precise work it is necessary to have the value of gravity measured at the instrument location.

When due to the lack of observed values, interpolation and computation can not be used to determine g , its value may be obtained by entering table 9, discussed later, with the latitude of the instrument location. The value so obtained is for sea level and requires a correction for elevation, as also discussed below. The value of g so obtained

has a relatively low accuracy, particularly in mountainous regions where the elevation correction is approximate and where anomalies in the value of gravity in the United States may amount to 0.110 cm/sec² or 0.011 percent.

For a general discussion of the acceleration of gravity as applied to manometry and for pertinent tables, see ref [512].

10.3. Variation of Gravity With Latitude and Elevation

The value of gravity at sea level varies with latitude as follows, based upon simple assumptions and taking no account of anomalies:

$$g_\phi = 980.616(1 - .0026373 \cos 2\phi + 5.9 \times 10^{-6} \cos^2 2\phi). \quad (46)$$

Here g_ϕ is the value in cm/sec² at latitude ϕ and 980,616 cm/sec² is the presently accepted value at sea level and 45 deg lat. See ref. [512]. Values of g_ϕ computed from eq (46) are given in table 9.

The empirical relation for the value of gravity g at elevations above sea level is

$$g = g_\phi - 0.0003086h + .0001118(h - h') \quad (47)$$

where g_ϕ = the acceleration of gravity at sea level; h = the elevation in meters of the instrument above sea level; and h' = the elevation in meters of the general terrain for a radius of 100 miles. For further details and sample computations, see ref. [591].

It is quite obvious that arriving at an accurate value of h' is difficult in mountainous terrain.

For a relation similar to eq (47) but applying to a station under water, see ref [512].

10.4. Gravity Correction Tables

Gravity corrections are given in two tables, Nos. 8 and 9. They are alike in that the corrections are given for selected values of gravity and

of instrument reading. They differ only in that in table 9 the selected values of gravity are associated with latitude.

Correction table 8 was computed from eq (40) for various value of g and R_t . The table is entered with g and R_t to obtain the gravity correction to be applied. The correction is subtracted from R_t if the sign is minus, and added to R_t , if plus.

Table 8 can be entered equally well with R_s , the reading corrected for scale error only. The correction is applied to R_s which gives R_{gs} , the reading corrected for scale and gravity error. Table 5 can be entered with R_{gs} to obtain the temperature error, which must however be applied to R_{gs} . The final result is a reading corrected for both temperatures and gravity errors.

Table 8 can be entered with R_s in any pressure unit, generally millibars, inches or millimeters of mercury, to obtain a correction in the same unit. The correction varies linearly with R_s so that by interpolation or other obvious numerical manipulation of R_s and the corrections, a correction for any reading can be obtained. A table computed for a given location is more convenient, in the preparation of which table 8 may be helpful.

The values of gravity are given in table 8 in cm/sec². If available in ft/sec², multiply by 30.48006 (or 30.48 if the international inch is used) to convert to cm/sec².

Table 8 also includes the value of $(g - g_s)/g_s$ used in making the calculations. This value when algebraically added to unity gives the value of g/g_s , needed if eq (45) is used in computing corrections.

Table 9 differs from table 8 only in that it is entered with latitude instead of g , the acceleration of gravity. The value of gravity, g , and the ratio $(g - g_s)/g_s$ are also given. The correction obtained is applicable only if the instrument is at sea level; further correction for elevation may be necessary using eq (47).

The value of g at a given latitude in table 9 was determined from eq (46). Otherwise, the discussion of table 8 presented above applies.

11. Capillary Errors

The meniscus of mercury in containers, either tubes or cisterns, is drawn down at the line of contact at the container wall. As a result the center of the meniscus is depressed somewhat below the level of an infinite surface of mercury. The amount of the depression tends to vary with the age of the barometer, with the direction of the change in pressure, and with local differences in the condition of the surface of the container. Theoretically, the amount of the depression is a function of the bore of the container, the meniscus height and the value of the surface tension of mercury. Foreign material on the container wall, such as grease, and contamination of the mercury surface, affect the meniscus height.

It has been reported that greater uniformity in

the meniscus height may be secured by putting mercurous nitrate at the interface [291] or coating the container surface with a material to stabilize the meniscus height. Neither of these procedures have found serious application in manometry.

A serious difficulty is lack of knowledge of the surface tension of mercury, except in a freshly distilled state under a vacuum. When in contact with air, it is known to be less than 484 dynes/cm at 25° C, the value for freshly distilled mercury in a vacuum. Surface contamination, even apparently trivial, will affect the value of the surface tension. Kistemaker, [451] in a series of careful experiments deduces from measurements of the capillary depression of mercury in a series of clean tubes of various bores up to over 30 mm (1.2 in.)

that the surface tension of mercury in contact with air at about 18° C was 430 ± 5 dynes/cm. There is no certainty that this value holds for the mercury in other tubes.

Thus the capillary depression, a function of the surface tension for a given bore of tube and meniscus height, can not be accurately determined. Hopefully, the error in the determination of the capillary depression is estimated to be less than ± 20 percent but the error will exceed this amount in many circumstances.

For highest accuracy there is only one safe recourse for avoiding excessive capillary corrections, that is making the areas of the mercury surface large enough so that the capillary depression is negligible. In precision manometry and barometry, if the capillary depression is not negligible, it is always considered desirable to measure the heights of the menisci and to apply the capillary correction.

It is common practice with ordinary barometers and manometers to incorporate the capillary depression into the zero correction (if one is applied). In the case of U-tube instruments it is often neglected on the assumption that the capillary depression is the same within the accuracy expected, for each mercury surface. When and if a correction is applied it is obtained from tables (see sec. 11.3).

11.1. Tube

It is practical only to correct the indicated position of the mercury surface in transparent tubes for the capillary depression. If the correction is to be made, the height of the mercury meniscus must be measured, in effect requiring, in addition to the usual measurements, the measurement of the position of the mercury-glass-gas boundary. This can be done only if the mercury surface is clean. Also tapping of the barometer or manometer is normally required to obtain a continuous, level boundary to measure and to eliminate nonuniform sticking of mercury to the cistern wall. The capillary depression is obtained from tables such as table 10, entered with the tube diameter and the meniscus height.

In view of the lack of inherent accuracy in determining the capillary depression, it seems hardly worthwhile to apply the correction for tubes less than 10 mm in diameter. In fact, the uncertainty in the capillary correction is such that if an accuracy of 0.1 mm of mercury is desired, a tube of not less than 12 to 16 mm in diameter should be used.

Kistemaker [452] describes a procedure for determining the capillary depression in tubes which is of interest, but not often as practical as using tubes of bore so large that the variations in the capillary depression can be neglected. An additional tube of smaller bore is used in parallel with the primary, subjected to the same pressure and of the same kind of glass and degree of cleanliness. The measurements made are: d ,

difference in heights of the mercury column in the two tubes, which should be of the order of 1 mm, in effect the difference in the capillary depression of the two tubes; m_1 and m_2 , the meniscus heights in the primary and secondary tubes, respectively. Entering an accepted table, as described in sec. 11.3, with m_1 and m_2 and the applicable bore of the tubes, the capillary depressions c_1 and c_2 are secured. The difference, $c_2 - c_1 = d_c$ is compared with d , the measured difference. If the difference, $d_c - d$, is significant, the values given in the table 10 for the primary tube are adjusted percentage-wise to give $d_c - d = 0$, and then used to make the corrections for the capillary corrections for that primary tube. One obvious assumption is made that the condition of the mercury surface in the two tubes is directly comparable and that this relative condition remains stable. It is claimed that, while the method is theoretically an approximation, an accuracy of ± 2 percent in determining the capillary correction is obtained.

11.2. Cistern

Corrections for the capillary depression of the mercury in the cistern of manometers and barometers can not be applied because the meniscus height can not be measured as a routine. The cistern is usually, or should be, large enough in diameter so that the depression itself is negligible.

Ordinarily with time the mercury surface in the cistern, and the cistern walls, foul up so that the meniscus height changes. In fixed cistern barometers or manometers where the scale zero is fixed, there are two effects acting to give rise to errors in measuring the pressure. First, the actual height of the mercury column falls by the amount of the capillary depression. Second, a readjustment of the volumes of mercury in the cistern and tube takes place which affects the relation between the zero of the scale and the cistern mercury surface. Due to the elimination of capillary depression, when the meniscus flattens, a slight rise takes place in the mercury level in the cistern; also as the meniscus flattens, the volume of the meniscus decreases, which decrease must result in the lowering of the level of the mercury in both the cistern and the tube. The latter, the volume effect, is predominant so that at constant pressure the barometer reading on the fixed scale falls as the meniscus flattens. The combination of these effects can be reduced somewhat by using cisterns of large diameter. The error occurs at any pressure, and may vary with time, pressure and the manner in which the pressure is changed.

The capillary effects just described also occur in the cistern of Fortin barometers. Since the mercury level in the cistern is adjusted in height to a fixed index, the residual error is only that due to the change in the capillary depression. Change in the volume of the meniscus does not affect the reading. In an extreme case of mercury fouling

in the cistern of a Fortin barometer, with a $\frac{1}{4}$ in. bore tube, the change in reading of a good meniscus to no meniscus, was 0.02 in. (0.5 mm) of mercury.

It is thus necessary to calibrate both Fortin barometers and fixed cistern barometers and manometers more or less frequently.

11.3. Correction Table

The correction table for the capillary depression in table 10 is given by Gould and Vickers [521]; it was computed from a mathematical development described in ref. [401]. It is seen that knowledge of the surface tension of mercury is needed, as well as the meniscus height and bore of the tube, in order to enter the table. Since it is not practical to measure the surface tension of the mercury in the barometer, some value must be assumed.

Kistemaker [452] has computed a table of values for the capillary depression based upon observations made on the depression of the mercury in tubes of various bores and partly on the theory given in ref. [401]. The menisci were in contact with atmospheric air at 75 ± 5 percent relative humidity for 24 hr before the tests and the temperature was $19 \pm 1^\circ \text{C}$ during the tests. These data are compatible with a surface tension of 430 dynes/cm for mercury. On this basis the values of the capillary depression should be about 5 percent less than those given in table 10 for a surface tension of 450 dynes. Actually for a 12 mm tube the values in table 10 are higher, rising from 10 to 20 percent for meniscus heights from 0.2 to 1.8 mm. Again, for a 19 mm tube, the values in the capillary depression are practically identical up to a meniscus height of 1.0 mm; those in table 10 rise to 10 percent higher for meniscus heights from 1.2 to 1.8 mm. In general, the capillary depressions given by Kistemaker are intermediate to

those for surface tensions of 400 and 500 dynes/cm given in table 10; however, at high meniscus heights and small bore tubes (10 mm and below), Kistemaker's values are lower than those for 400 dynes/cm.

The capillary depression given in table 10 for a surface tension of 450 dynes/cm are from 5 to 10 percent lower than those of a much used correction table [231], a discrepancy made greater by the fact that the latter table was computed for a surface tension of 432 dynes/cm. Both tables were prepared in the National Physical Laboratory of Great Britain.

Since there is no practical way to know the applicable value of surface tension of the mercury under the various conditions of use, in contact with air or vacuum, and degree of surface cleanliness of the mercury, there is little to gain in choosing one set of tables over another. For the moment, Gould's table (table 10), for 450 dynes/cm seems as applicable as any.

For one important purpose any table is adequate, that is for the selection of a bore of tube sufficiently large so that the variations in the capillary depression will have negligible effect on the required overall accuracy. In this connection note that the percentage variation in the capillary depression with surface tension at all meniscus heights presented in table 10 is greater the larger the bore of the tube. Thus for a change in surface tension from 400 to 500 dynes/cm the capillary depression varies as much as 100 percent.

Note that for Fortin and fixed cistern barometers, the capillary depression given in the table is added to the reading of the mercury barometer. For U-tube barometers and manometers the capillary depression at the upper mercury surface is added to, and at the lower mercury surface subtracted from, the indicated height of the mercury column.

12. Return Head and Elevation Corrections

Usually a differential pressure is measured simply by the height of the mercury column. Actually the differential pressure, measured at the level of the mercury surface on the high pressure side of a mercury manometer, is the difference of the specific weight of the mercury column and of the column of equal height of the gas or liquid on the high pressure side. The specific weight of the latter column is defined as the head correction.

Both differential pressure and absolute pressure measured with any manometer or barometer, liquid or mechanical, applies only to the elevation at which made. In the case of mercury manometers this level is that of the mercury surface of the high pressure side of the barometer. If pressures are desired at any other level above or below, the decrease or increase in absolute pressure with

elevation due to the intervening head of gas or liquid in both legs of a manometer must be considered. The elevation correction is defined as the correction which needs to be applied to transfer the pressure measured at an elevation to another elevation.

Elevation corrections discussed in this section are mainly restricted to elevation differences of several hundred feet and pressures of several atmospheres. These are conditions commonly met with in laboratories and industry. Determination of sea level pressure from readings of a barometer installed at elevations well above sea level are outside the scope of this paper; this computation is discussed in the publications of the U.S. Weather Bureau.

12.1. Definition of Symbols

e = base of natural logarithms = δ
2.71828

g = acceleration of gravity. In this section assumed to be the standard reference value, 980.665 cm/sec²

h = vertical height of the gas column (see fig. 4)

h_0 = the elevation with reference to the level at zero differential pressure of a barometer or a manometer (see fig. 4)

h_i = the height above or below a mercury surface of a liquid used to transmit the pressure

H = scale height = RT/g

P = absolute pressure

P_0 = absolute pressure in a gas column at elevation h_0 (see fig. 4)

P_{00} = absolute reference pressure, measured at some level other than h_0

P_1, P_2 = absolute pressures at various levels on the low pressure side of the system (see fig. 4)

P_{10}, P_{11}, P_{12} = absolute pressures at various levels on the high pressure side (see fig. 4)

p = differential pressure measured by the mercury column (see fig. 4)

R = a constant for a gas

T = absolute temperature of the gas at any level; assumed to be constant at all levels of the gas column

ρ = density of the gas at temperature T and pressure P

ρ_l = density of the liquid which is used to transmit pressure

12.2. Change in Gas Pressure with Elevation

The return head correction or the elevation correction involves the computation of the change in gas pressure in going from one level to another. Since a gas compresses under its own weight, its density at a higher elevation is less than at a lower elevation; this necessitates an integration.

The basic relation is

$$\frac{dP}{dh} = -\rho g. \quad (48)$$

Substituting for ρ in eq (48) its value

$$\rho = \frac{P}{RT} \quad (49)$$

there is obtained

$$dP = -\frac{Pg dh}{RT}. \quad (50)$$

Integrating eq (50)

$$P = P_0 e^{-\frac{gh}{RT}} = P_0 e^{-\frac{h}{H}}. \quad (51)$$

Approximately, with an accuracy within 0.1 mm of mercury for h equal to several hundred feet and P_0 equal to several atmospheres:

$$P = P_0 \left(1 - \frac{h}{H}\right). \quad (52)$$

Here T is the temperature of the gas at pressure P ; and P_0 and P are the absolute pressures of the gas at the reference level $h=0$ and level h , respectively. If the level of P is above the level of P_0 , h is plus; if below, h has a minus sign. See section 12.1 for other definitions.

The temperature of the gas column ordinarily can be assumed to be constant. If the gas temperature varies in the gas column an arithmetic average of the temperature based on equal increments of $\log p$ or here with sufficient accuracy, of equal increments of elevation, will give the temperature T to use in computing H . The factor H is called "scale height" because it has the dimensions of a length.

Equations (51) or (52) are primary for computing the difference in pressure at two elevations due to a head of gas. In its derivation it has been assumed that the gas law given in eq (49) holds, and of course that the gas does not condense anywhere in the system.

For each gas a table of values of H against temperature will be useful. In computing H the gas constant R , varies with the gas. It equals the universal gas constant, 8.31439×10^7 erg/mole deg, divided by the molecular weight of the gas. Values of R for a few gases are given below [531]. Using these values of R , g in cm/sec² and T in degrees Kelvin, gives H in centimeters which can readily be converted to be in the same unit as the elevation h .

Gas	Constant R cm ² /sec ² °K	Molecular weight
Air, dry	2.8704×10^6	28.996
Carbon dioxide	2.0800×10^6	44.01
Hydrogen	41.242×10^6	2.016
Helium	38.910×10^6	4.003
Nitrogen	2.9673×10^6	28.02
Oxygen	2.5982×10^6	32.00

From some points of view the method of computation to be presented is preferable, although it is an approximation with about the same accuracy as eq (52). In the absence of a mechanical computer it is definitely less laborious. This method will be used in all of the examples given below; if the use of eq (51) or (52) is preferred, the substitutions to be made are straightforward.

In eq (48), dP/dh is the rate of change of pressure per unit change in elevation. This rate varies directly as the product of the gas density, inde-

pendent of its composition, and the acceleration of gravity. The latter varies less than 0.3 percent over the surface of the earth, and, as will develop, introduces an error of this amount in a small correction term and therefore can be assumed to be a constant.

Thus, if precomputed values of dP/dh are available, changes in pressure with elevation can be computed by the relation

$$P = P_0 - \Delta P = P_0 - \frac{dP_0}{dh} h \quad (53)$$

In order to facilitate computation using eq (53), tables 11 and 12 have been prepared. The value of dP/dh , the rate of change of pressure per unit change in height of the gas column, is presented in table 11 for selected values of the gas density and for five different convenient units of measurement. For convenience the absolute pressure for air only is given for three air temperatures. Three assumptions underly table 11: (a) The value of gravity is 980.665 cm/sec²; (b) the gas is dry and does not condense in the system; and (c) the air temperature of the gas column is constant, usually the case to a sufficient degree in laboratories. It should be noted that the gas density and the corresponding rates of change of absolute pressure given in table 11 are independent of the composition of the gas, pure or mixtures.

Table 12 is presented as an aid in determining the density of dry air when the air pressure and temperature are known. Air is assumed to have an air density of 0.001293 g/cm³ at 0° C and a pressure of 760 mm of mercury. The coefficient of expansion of air is assumed to be 1/273; the slight error thus introduced is inconsequential in the practical use of the table.

An example will illustrate the utility of the tables in computing the pressure difference caused by a head of gas. Assume the pressure of air to be 810 mm of mercury and the temperature 21° C, to determine the pressure at a point 11 ft higher in elevation. From table 12, the air density corresponding to 810 mm of mercury and 21° C is, by interpolation, 0.001280 g/cm³. Entering table 11 with this value, it is found that $dP/dh = 0.02861$ mm of mercury per foot. The difference in pressure at the two levels is

$$\Delta p = -\frac{dP}{dh} h = -0.0286 \times 11 = -0.31 \text{ mm Hg}$$

and

$$P = 810 - 0.31 = 809.69 \text{ mm Hg.}$$

It is seen that variations in gravity up to 0.3 percent affect the pressure decrease of 0.31 in. of mercury to an insignificant degree. Two sources of error should be considered. First the density itself and therefore dP/dh , may be in error. An error in temperature measurement of 1° C,

unlikely in practice, introduces roughly an error of 0.3 percent in gas density or in dP/dh . This error is usually insignificant. Second, the value of dP/dh varies with gas density, so that its value is not precisely the same at 810 and 809.69 mm of mercury. The difference here is less than 0.04 percent, obviously insignificant. In this example the method is accurate to at least 0.01 mm of mercury.

In the second case the accuracy is about the same as the ratio of the pressure difference to the reference pressure. If excessive, the error may be reduced approximately one-half by two computations, first determining an approximate pressure difference as outlined above, and finally, determining the pressure by using a value of dP/dh given by the average of two values of dP/dh , one for the density at the measured pressure at $h=0$ and the other for the density determined by the approximate pressure computed for level h .

12.3. Return Head Correction

In many cases the differential pressure at the level of the lowest mercury surface is desired. In figures 4 and 5 this differential pressure is

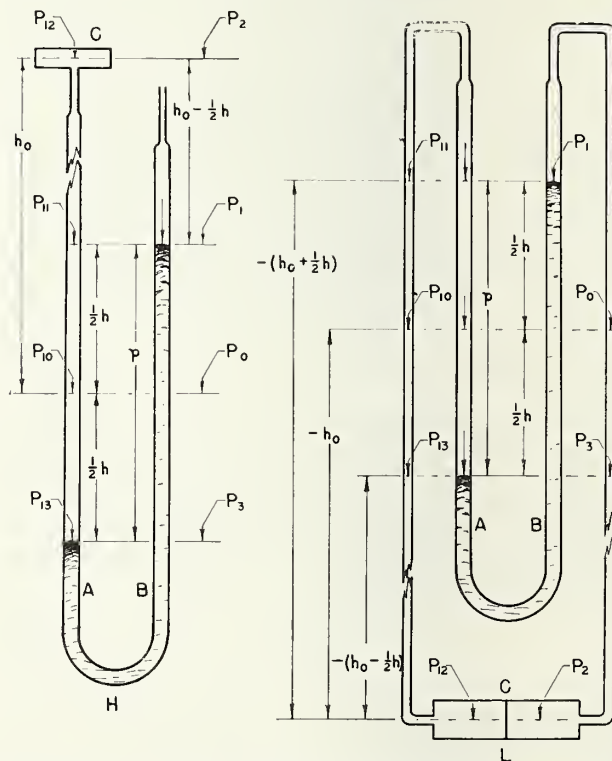

FIGURE 4. Diagram illustrating computation of gas pressure at two levels from differential pressure measured with U-tube manometer.

H, system with unknown pressure at high level; *L*, system with unknown level at lower level. *A*, tube connected to system the pressure of which is to be measured; *B*, manometer tube open to the atmosphere or connected to pressure reference; *C*, level at which pressure is desired; P_{10} , P_{11} , P_{12} , absolute pressure in system at various levels; P_0 , P_1 , P_2 , absolute atmospheric or reference pressure at various levels. p , the measured differential pressures h , h_0 , differences in elevation.

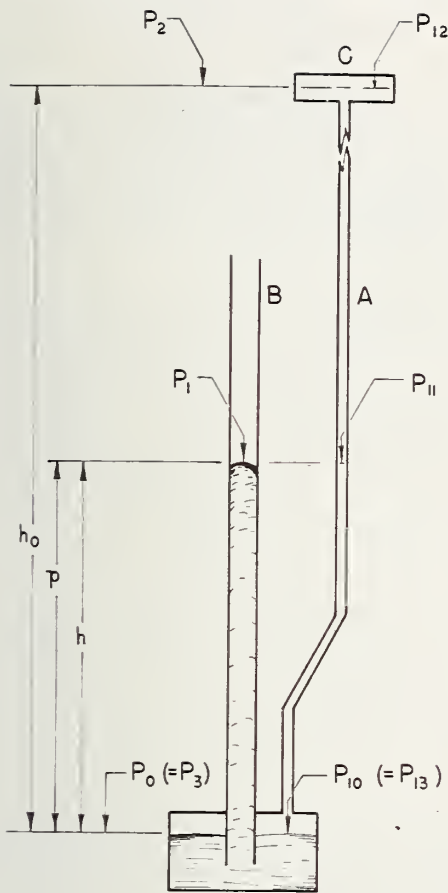

FIGURE 5. Diagram illustrating computation of gas pressure at two levels from gage pressure measured with cistern manometer.

See figure 4 for meaning of symbols.

$P_{13}-P_3$. The gas pressure impressed upon the mercury surface at the upper level is P_1 , figures 4 and 5, and must be known or obtainable. The problem reduces to the computation of P_3 in terms of P_1 . The significant elevation here is h which is also the height of the mercury column.

From eq (53)

$$P_3 = P_1 + \frac{dP_0}{dh} h \quad (54)$$

The absolute pressure P_3 is greater than P_1 , therefore the correction is additive.

$$P_{13} = P_1 + p \quad (55)$$

and

$$P_{13} - P_3 = p - \frac{dP_0}{dh} h \quad (56)$$

Alternatively, based upon eq (51) and (52)

or

$$P_{13} - P_3 = p + P_1(1 - e^{h/H}) \quad (57)$$

$$= p - \frac{h}{H} P_1 \quad (58)$$

The terms $-(dP_0/dh)h$, $P_1(1 - e^{h/H})$ and $-h/HP_1$ are nearly equivalent various forms of the return head correction; only the term in eq (57) is strictly rigorous, but the accuracy of the others is usually quite adequate.

For all practical purposes, in eq (56)

$$\frac{dP_0}{dh} = \frac{dP_1}{dh}$$

a fact which often simplified computations.

Equations (56), (57), and (58) give the return head correction for all forms of U-tube manometers and for cistern manometers, with a change in notation as indicated in figure 5.

For mercury barometers of all forms, the return head correction is zero.

All of the above discussion is for the case when the low pressure side of manometer has a gas above the mercury surface. In some applications this space is filled with a liquid, that is for example the line from P_1 to P_2 in figure 4L may be filled with a liquid of density ρ_l . It is unlikely that the differential pressure $P_{13}-P_3$ is of any interest, but if so, it is

$$P_{13} - P_3 = p - \rho_l g h \quad (59)$$

where $\rho_l g h$ is the return head correction. Here ρ_l is the density of the liquid at the pressure P_1 and at its temperature. Compression effects can ordinarily be neglected.

If ρ_l is in grams per cubic centimeter, g in centimeters per second squared in h in centimeters, the head correction is in dynes per square centimeter, which can be converted to the units of p with the aid of table 1.

12.4. Elevation Correction, Gas Head

The basic relations for pressure change with elevation enable computation to be made of the absolute pressure at the significant levels in any pressure system. The difference in the absolute pressures at a given level in the two legs of a manometer gives the required gage or differential pressure. For barometers one of the absolute pressures is essentially zero. The computations will be made based only upon eq (53).

Generally, measurements of p , h_0 , and h as indicated in figures 4 and 5 need to be available. To compute dP/dh using table 11, it is necessary to enter table 11 with the density of the gases involved. This, most simply requires that measurements be made of the gas temperature and the absolute pressure of the two gas columns at the zero reference level; absolute pressures at other

levels can be substituted without significant error if these levels are within the height of the liquid column.

In making computations a choice must be made of the reference level from which elevations are measured. This zero elevation can be one of the mercury surfaces but this choice has the disadvantage that the zero reference level then varies with pressure. Computations are often more conveniently made if the zero elevation of the gas column is chosen to be the level at which the differential pressure indicated by the barometer or manometer is zero. The height of the gas column is then, as indicated in figure 4, $h_0 \pm h/2$ for U-tube instruments, or $h_0 \pm h$ for cistern instruments.

12.4.1 U-tube Manometers

Consider the pressure system figure 4H, where one leg of the manometer is open to the atmosphere and the other leg connected to a chamber at a level above the manometer. It is required to determine the gage pressure $P_{12} - P_2$.

In leg *B* of the manometer the absolute gas pressures are:

$$P_1 = P_0 - \frac{dP_0}{dh} \frac{h}{2} \quad (60)$$

$$P_2 = P_0 - \frac{dP_0}{dh} h_0 \quad (61)$$

If the atmospheric pressure is measured at some other elevation h_{00} than at the zero elevation level,

$$P_0 = P_{00} - \frac{dP}{dh} h_{00} \quad (62)$$

If the level of P_0 is below that of P_{00} , the minus sign in eq (62) changes to plus.

In leg *A* of manometer *H*, the significant gas pressures are, based upon eq (53) and (61).

$$P_{13} = p + P_0 - \frac{dP_0}{dh} \frac{h}{2} \quad (63)$$

$$\begin{aligned} P_{12} &= P_{13} - \frac{dP_{10}}{dh} \left(h_0 + \frac{h}{2} \right) \\ &= p + P_0 - \frac{dP_0}{dh} \frac{h}{2} - \frac{dP_{10}}{dh} \left(h_0 + \frac{h}{2} \right). \end{aligned} \quad (64)$$

The gage pressure at level h_0 is (eq 61 and 64)

$$P_{12} - P_2 = p + \frac{dP_0}{dh} \left(h_0 - \frac{h}{2} \right) - \frac{dP_{10}}{dh} \left(h_0 + \frac{h}{2} \right). \quad (65a)$$

For cases, such as illustrated in figure 4L, where the level at which the differential pressure is below the level of P_0 , it is only necessary to change the sign of h_0 . Equation (65a) becomes

$$P_{12} - P_2 = p - \frac{dP_0}{dh} \left(h_0 + \frac{h}{2} \right) + \frac{dP_{10}}{dh} \left(h_0 - \frac{h}{2} \right). \quad (65b)$$

12.4.2. Cistern Manometers

For cistern manometers, figure 5, the zero reference level is at the mercury surface in the cistern, which ordinarily can be assumed not to vary significantly with pressure. Then for reference absolute pressures in leg *B*,

$$P_1 = P_0 - \frac{dP_0}{dh} h \quad (66)$$

$$P_2 = P_0 - \frac{dP_0}{dh} h_0 \quad (67)$$

and for absolute pressures in leg *A*,

$$P_{10} = p + P_1 = p + P_0 - \frac{dP_0}{dh} h \quad (68)$$

$$P_{12} = P_{10} - \frac{dP_{10}}{dh} h_0 = p + P_0 - \frac{dP_0}{dh} h - \frac{dP_{10}}{dh} h_0. \quad (69)$$

The differential pressure at level P_{12} is:

$$P_{12} - P_2 = p + \frac{dP_0}{dh} (h_0 - h) - \frac{dP_{10}}{dh} h_0. \quad (70)$$

Again, if the level of P_2 is below the level of P_0 , eq (70) applies if the sign of h_0 is changed, as indicated in eq (65a) and (65b).

12.4.3. Barometers

In all cases the pressures $P_0 = P_1 = P_2 = P_3 = 0$, since the space above the mercury column is evacuated.

In U-tube barometers the absolute pressure at an elevation differing from that of P_{10} is simply, using the notation in figure 4,

$$P_{12} = P_{10} \pm \frac{dP_{10}}{dh} h_0 = P_{13} - \frac{dP_{13}}{dh} \left(\frac{h}{2} \pm h_0 \right). \quad (71)$$

In cistern barometers the absolute pressure at an elevation above or below the level of the mercury surface in the cistern, where the pressure is P_{10} , is:

$$P_{12} = P_{10} \pm \frac{dP_{10}}{dh} h_0. \quad (72)$$

12.5. Elevation Correction, Liquid Head

To consider this case, assume in figure 4L that the tubing from both mercury surfaces to chamber *C* are filled with the same pressure transmitting liquid of density ρ . Assume that the pressures are low so that compression of the transmitting liquid and of mercury can be neglected. It is then seen in figure 4L that

$$P_{10}-P_0=P_{13}-P_3=P_{12}-P_2=p-\rho_1gh. \quad (73)$$

Thus, the differential pressure at any level requires only a correction for the return head, as discussed in connection with eq (59).

13. Vacuum Error of Barometers

The vacuum above the mercury column of barometers is never perfect; mercury vapor and some air, and perhaps other gases are always present. The pressure of the gases in the vacuum space results in an error in the measured pressure, and when known either by computation or measurement must be added to the measured pressure to secure the pressure.

In precise measurements the vacuum is maintained below a value set by the desired precision of measurement by means of a diffusion pump. The vacuum can be checked with a McLeod gage to an accuracy of the order of ± 10 percent. In this procedure however the effect of the mercury vapor is neither eliminated nor measured. If the precision desired warrants, a correction must also be applied for the pressure of the mercury vapor, obtained from tables of observed values, as table 3. The operation schedule of the diffusion pump and temperature conditions must be such that equilibrium values of the mercury vapor pressure exist at the time readings are made.

The precision in measurement desired may be such that a less elaborate procedure than that just described can be followed. The correction to be applied is the sum of the mercury vapor pressure at the barometer temperature and of the pressure measured by the McLeod gage. The diffusion pump is only operated when the vacuum has deteriorated to a value where the uncertainty of the McLeod gage measurement is of the same order as the desired precision in the measured pressure. It should be noted the vacuum correction varies with the height of the mercury

To take care of compression of the transmitting liquid it is only necessary to modify the value of the density ρ_1 in eq (73).

It is unusual for the transmitting liquids to differ in the two legs of the manometer, so that this case is not considered here.

column, since the volume of the vacuum space varies and the mass of the gas, except the mercury vapor, is approximately constant.

In portable barometers no correction is ordinarily made, or justified, for the back pressure in the vacuum space above the mercury column. If the barometer tube is equipped with a mercury seal valve, the vacuum can be kept within requirements for precision in pressure measurement by periodic evacuation of the tube through the valve. The frequency of evacuation needed can be determined only by experience; in general evacuation is needed after subjecting the barometer to some definite number of pressure cycles.

If the portable barometer is not equipped with a valve in the top of the tube, a poor vacuum may be detected by tipping the tube with suitable precautions to avoid damage or uncovering the bottom of the tube, so that the gas is subjected to about one-fourth of an atmosphere. If the apparent size of the bubble is greater than about two or three millimeters the vacuum needs improvement. In general barometers in the best of condition will have a bubble upon tipping, of the order of about one millimeter in size. Barometers subjected only to ambient atmospheric pressure have been known to maintain a satisfactory vacuum for years; on the other hand, altitude barometers in frequent use over a large pressure range may maintain a satisfactory vacuum only for periods as short as a month. The vacuum is reestablished either by a complete overhaul job on the barometer, or if the design permits, by removing the gas within satisfactory limits by the procedure described in sec. 6.4.

14. Compression of Mercury

The compression of mercury with pressure affects its density as discussed in sec. 4.4. The standard values of the density of mercury are generally for mercury subjected to 1 atm of pressure. The compression of mercury must be considered particularly in high pressure manometers (sec. 5.6) and only in very precise measurements at relatively low pressures. In barometry and for all portable barometers and manometers the accuracy usually obtainable makes application of any correction for mercury compression insignificant.

Consider a manometer in which mercury surface in the two legs are subjected to pressures P and P_1 .

Then

$$P - P_1 = \rho gh; \quad (48)$$

The mercury at the lower mercury level is compressed by pressure P or $P_1 + \rho gh$. Assuming that the compression of mercury is given by $\rho = \rho_0(1 + aP)$, eq (11), sec. 4.4

$$\rho = \rho_0 [1 + a(P_1 + \rho gh)]. \quad (74)$$

In a more accurate derivation for the compression effect due to a column of mercury the relation is

$$\rho = \rho_0 [1 + a (P_1 + \rho_0 g h)]. \quad (75)$$

Here ρ and ρ_0 are respectively the densities of mercury at pressure $P_1 + \rho g h$ and at zero pressure; h is the height of the mercury column; and a is the volume coefficient of compression per unit pressure.

The standard density ρ_s applies to mercury under a pressure of one atmosphere. Therefore, if a_s is the compression coefficient per atmosphere,

$$\rho_s = \rho_0 (1 + a_s). \quad (76)$$

Without significant error eq (75) now becomes

$$\rho = \rho_s [1 - a_s + a_s (P_1 + \frac{h}{h_s})]. \quad (77)$$

and eq (48) where in atmospheres $P - P_1 = \rho h / \rho_s h_s$

$$P - P_1 = \frac{h}{h_s} [1 - a_s + a_s (P_1 + \frac{h}{h_s})]. \quad (78)$$

All of the quantities in the right hand side of the equation are either constants or measured. The pressure $P - P_1$ is in atmospheres and h_s is the height of the mercury column at 1 atm of absolute pressure.

Consider the case of the barometer where 1 atm of pressure is defined as a mercury column 760 mm in height subjected to standard gravity with the density of mercury equal to 13.5951 g/cm³. This density is the commonly accepted value at 0° C and under a pressure of 1 atm. To consider

this case, eq (78) can be written, since $P_1 = 0$.

$$P = \frac{h}{h_s} [1 - a_s + a_s \frac{h}{h_s}]. \quad (79)$$

At the bottom of the mercury column where the mercury is subjected to 1 atm of pressure, eq (79) gives $P = \text{unity}$. At the top of the column the term $a_s h / h_s$ is practically zero and $P = h(1 - a_s) / h_s$. Two conclusions can be derived. First, an interval of 1 mm will represent a higher pressure at the bottom than at the top of the column, specifically for 1 atm difference in compressing pressure, about 4 parts per million. Second, a pressure of 1 atm is defined as 1,013.250 dynes/cm², which when converted to a mercury column of 760 mm implies a mean density of mercury of 13.5951 g/cm² at 0° C. Thus in a mercury column of 760 mm representing 1 atm of absolute pressure, the density of mercury assumed is 2 parts per million greater than 13.5951 g/cm² at the bottom of the column and the same amount less at the top of the column. Thus the assumed density at 0° C and at 1 atm differs from the presently accepted value by about 2 parts per million. For most purposes the point is academic.

In manometers measuring gage pressure (differential pressure with reference to atmospheric pressure) the situation is the reverse of that for barometers, since the mercury is generally subjected to pressures above atmospheric. A millimeter of column height is equivalent to a pressure greater than 1 mm of mercury under standard conditions, roughly amounting to 4 parts per million per atmosphere of applied pressure.

15. Computation of Corrections

Representative examples of the computation of corrections as outlined in the previous sections may be useful. For many types of portable barometers and manometers the only corrections ordinarily applied are for scale, temperature and gravity errors. Two examples of such cases will be given.

One additional example will be presented where higher accuracy is desired and corrections for the more significant errors will be applied. Some errors will remain uncorrected, such as for the compressibility of mercury, since the accuracy attainable normally makes them insignificant.

The application of the corrections is based upon: (a) adequate primary data; and (b) upon the use of tables such as presented in this paper. It must be emphasized that valid alternative methods of computing the corrections exist and that the methods here used are justified only by their convenience.

15.1. Fortin Barometer

The following readings are taken:

Reading: 1021.15 mb

Barometer temperature: 23.2° C.

Other needed data or information are:

Acceleration of gravity: 979.640 cm/sec²

Scale correction (includes correction for zero, capillary and vacuum errors) +0.35 mb

Brass scale calibrated to be accurate at 0° C.

(a) Scale Correction

Reading = 1021.15

Scale correction = +0.35

$R_s = 1021.50$ mb

(b) Temperature Correction.

Table 6 is entered with 1021.50 and 23.2° C to obtain by interpolation -3.86 mb for the temperature error C_t .

$R_s = 1021.50$

$C_t = -3.86$

$R_t = 1017.64$ mb

R_t is the reading corrected for temperature error.

(c) Gravity Correction.

Table 8 is entered with 1017.64 mb and 979.640 cm/sec² to obtain by interpolation -1.06 mb for the gravity correction C_g .

$$R_s = 1017.64$$

$$C_g = -1.06$$

$$P = 1016.58 \text{ mb}$$

The pressure P is then 1016.58 mb at the level of the mercury surface in the cistern.

15.2. Altitude Barometer, Fixed Cistern

This example is included as an illustration of the application of the temperature correction. The following readings are taken:

Reading: 352.7 mm of mercury

Barometer temperature: 23.6°C .

Other needed data or information are:

Acceleration of gravity = 979.640 cm/sec^2

Constant K to be added to reading to obtain the temperature correction: 65 mm

Scale correction (includes correction for zero, capillary and vacuum errors): -0.5 mm of mercury at the reading.

Brass scale calibrated to be correct at 0°C or if not, error is absorbed in the scale correction.

(a) Scale correction

$$\text{Reading} \quad R = 352.7$$

$$\text{Scale correction} \quad C_s = -0.5$$

Corrected reading $R_s = 352.2 \text{ mm}$ of mercury

(b) Temperature correction

$$R_s = 352.2$$

Constant $K = 65.0$ (see eq (36) sec. 9.3.1.)

$$R_s + K = 417.2 \text{ mm of mercury.}$$

Temperature correction table 6 is entered with $R_s + K$ and 23.6°C to obtain -1.6 mm as the temperature correction C_t

$$R_s = 352.2$$

$$C_t = -1.6$$

$R_t = 350.6 \text{ mm}$ of mercury = reading corrected for scale and temperature errors.

(c) Gravity correction

Gravity correction table 8 is entered with the acceleration of gravity 979.640 cm/sec^2 and R_t , to obtain -0.37 mm as the correction.

$$R_t = 350.6$$

$$C_g = -0.4$$

$$P = 350.2 \text{ mm of mercury.}$$

Thus, the pressure at the level of the mercury surface in the cistern is 350.2 mm of mercury.

15.3. Manometer, U-tube

In this example all corrections normally applied will be made based upon an accuracy of 0.01 mm of mercury in a pressure by a U-tube manometer.

The procedure is essentially the same for a U-tube barometer, except for differences, easy to handle, due to the fact that the pressure above one mercury surface is nominally zero in the barometer; this fact may however make a vacuum correction necessary.

The following readings are taken on a manometer illustrated in figure 4L.

Reading on scale:

upper mercury surface 1150.92 mm

lower mercury surface 130.27 mm

Manometer temperature: 23.21°C

Meniscus heights: upper 1.0 mm; lower 1.3 mm

Other needed data or information are:

Bore of tube: 20 mm

Acceleration of gravity: 979.640 cm/sec^2

Absolute pressure P_0 , figure 4L: 380.22 mm of mercury

Elevation at which differential pressure is desired: 20 ft below the mercury surface at which the differential pressure is zero (h_0 in fig. 4L).

Zero correction: the reading at zero differential pressure averages 0.02 mm higher in tube A, figure 4L (high-pressure side), after applying the capillary correction. While it is questionable if this correction is a constant independent of differential pressure, it will be applied.

Scales and vernier will be assumed to measure column heights accurately at 0°C .

Thermal coefficient of expansion of scale: 17.2×10^{-6} per $^\circ \text{C}$

Alignment errors are assumed to be zero.

(a) Nominal height of mercury column

$$R_1 = 1150.92$$

$$R_2 = -130.27$$

Nominal height = 1020.65

(b) Zero correction

Since the reading tube A reads higher at zero differential pressure, the nominal reading should be increased 0.02 mm and becomes 1020.67 mm.

(c) Capillary correction

From table 10 the correction for a meniscus height of 1.0 mm, tube bore, 20 mm = $+0.024 \text{ mm}$; for a meniscus height of 1.3 mm = $+0.030 \text{ mm}$. The nominal reading, corrected for capillarity is $1020.67 - 0.030 + 0.024 = 1020.66 \text{ mm}$, which is h_t , the corrected scale reading at 23.21°C .

(d) Actual height of mercury column at 23.21°C

To reduce the nominal height h_t to the actual height h at 23.21°C , a correction must be made for the thermal expansion of the scale. In the absence of tables,

$$h = \frac{h_t}{1 + st} = \frac{1020.66}{1 + 17.2 \times 23.21 \times 10^{-6}} = 1020.25 \text{ mm.}$$

(e) Temperature and gravity correction

These corrections can be made in one of two ways, both of which will be presented. In the first procedure a correction to be applied to h will be computed. The sum of the temperature correction C_t and the gravity correction C_g is:

$$C_t + C_g = \left(\frac{mt}{1 + mt} + \frac{g - g_s}{g_s} \right) h.$$

The term $mt/(1 + mt)$ is obtained from table 7,

the column headed invar, since here the thermal expansion of the scale is zero. For 23.21° C, $F = -0.0042018$.

The term $(g - g_s)g_s$ is obtained from table 8 from the column headed "Correction factor". For 979.640 cm/sec² it equals -0.0010452 .

Their sum gives

$$C_t + C_g = -0.0052470(1020.25) = -5.35 \text{ mm.}$$

The reading corrected for temperature and gravity errors, the differential pressure p in figure 4L is then

$$p = 1020.25 - 5.35 = 1014.90 \text{ mm of mercury.}$$

Alternatively, the differential pressure P can be computed directly from

$$p = \frac{\rho g h}{\rho_s g_s} \quad (45)$$

Here ρ_s , and ρ are the density of mercury respectively at 0° C and 23.21° C, 13.5951 and 13.5380 (from table 3) g/cm³; and g_s and g are the standard and ambient accelerations of gravity, 980.665 and 979.640 cm/sec², respectively.

Inserting these values, and the value for h in (d) above, in eq (45)

$$p = \frac{13.5380 \times 979.640 \times 1020.25}{13.5951 \times 980.665} = 1014.90 \text{ mm of mercury.}$$

A slight difference of the order of a few microns (0.001 mm) in the values of p by the two methods of computation can be expected from the fact that m , the volume coefficient of thermal expansion of mercury is an average value. The latter value of p is the more accurate.

(f) Return head correction

If the differential pressure (fig. 4L)

$P_{13} - P_3$ is desired:

$$P_{13} - P_3 = p - \frac{dP_0}{dh} h. \quad (57)$$

Here $p = 1014.90$ mm of mercury and $h = 1020.25$ mm (3.347 ft).

For an air pressure $P_0 = 380.22$ mm of mercury and temperature of 23.21° C, the air density is obtained by interpolation from table 12 to be 595.7×10^{-6} g/cm³. From table 11, dP_0/dh corresponding to this density is found to be 0.0133 mm Hg/ft. Then

$$\begin{aligned} P_{13} - P_3 &= 1014.25 - 0.0133 \times 3.347 \\ &= 1014.21 \text{ mm of mercury.} \end{aligned}$$

The return head correction is 0.04 mm of mercury.

(g) Differential pressure at level 20 ft below P_0 level

In this case, referring to figure 4L:

$$P_{12} - P_2 = p - \frac{dP_0}{dh} \left(h_0 + \frac{h}{2} \right) + \frac{dP_{10}}{dh} \left(h_0 - \frac{h}{2} \right). \quad (65b)$$

Here $p = 1014.25$ mm of mercury; $dP_0/dh = 0.0133$ mm of mercury / ft;

$$h_0 + \frac{h}{2} = 20 + 1.673 \text{ ft.; and } h_0 - \frac{h}{2} = 18.327 \text{ ft.}$$

To compute dP_{10}/dh , P_{10} to sufficient accuracy = $p + P_0 = 1014.25 + 380.2 = 1394.4$ mm of mercury. Following the procedure outlined above under (f) using tables 11 and 12, $dP_{10}/dh = 0.0489$ mm of mercury / ft for $p + P_0$ and 23.21° C, therefore

$$\begin{aligned} P_{12} - P_2 &= 1014.25 - 0.0133 \times 21.7 + 0.0489 \times 18.3 \\ &= 1013.64 \text{ mm of mercury.} \end{aligned}$$

The elevation correction is +0.61 mm of mercury ($P_{12} - P_2 - P_{13} + P_3$).

16. Testing at the National Bureau of Standards

For testing mercury barometers, the National Bureau of Standards has a standard barometer and barostat installed in a subbasement room the temperature of which is maintained closely at 25° C. See secs. 5.4, 6.1.3, 6.2.2, and 8.2 for details. The accuracy, now 0.02 to 0.03 mm of mercury, is not considered entirely adequate for testing portable barometers with accuracies approaching 0.05 mm of mercury. Continuing effort is made to improve the accuracy.

For testing manometers the Bureau has a mercury manometer with a range of 50 psi (100 in. of mercury). Piston gages of the air type are under development for use as standards in order

to improve the accuracy and convenience of operations.

The National Bureau of Standards accepts for test mercury barometers and manometers which are: (a) the reference standard or one working standard of an organization or laboratory; and (b) reference tests when the measurement of pressure is in dispute. The accuracy of the instruments submitted must be at least ± 0.1 mm of mercury. See ref. [582] for details regarding the acceptance of instruments for test.

Instruments submitted for test should be sent to "National Bureau of Standards, Attn: Mechanical Instruments Section, Washington 25, D.C."

A purchase order issued to the National Bureau of Standards authorizing the test must be supplied. It is advisable to arrange for the test by correspondence or telephone previous to shipping the instrument. Tests fees are listed in the current NBS Test Fee Schedules which are based on cost.

The experience of the Bureau is available to laboratories and manufacturers on the various

problems associated with the precise measurement of pressure. Visits of technical personnel to discuss problems should be arranged in advance.

The authors are grateful to Dr. H. F. Stimson and to L. F. Harrison, of the Weather Bureau for many suggestions and correction.

17. References

The first two digits in each number are the year of publication of the reference.

- [011] Comptes rendus des séances de la troisième conférence générale des poids et mesures, réunie à Paris en 1901. Travaux et mémoires de Bureau International des Poids et Mesures.
- [121] P. W. Bridgman, Mercury, liquid and solid under pressure, *Proc. Am. Acad. Arts Sci.* **47**, 347 (1912).
- [141] M. H. Stillman, Note on the setting of a mercury surface to a required height, *BS Sci. Pap.* **10**, 371 (1914) S214.
- [191] P. W. Bridgman, The measurement of high hydrostatic pressures; a secondary mercury resistance gauge, *Proc. Am. Acad. Arts Sci.* **44**, 221 (1919).
- [231] F. A. Gould, Barometers and manometers, *Dict. Applied Physics* **3**, 140 (Macmillan & Co. London, 1923).
- [271] F. G. Keyes and J. Dewey, An experimental study of the piston pressure gage to 500 atmospheres, *J. Opt. Soc. Am.* **14**, 491 (1927).
- [291] K. C. D. Hickman, The mercury meniscus, *J. Opt. Soc. and Rev. Sci. Instr.* **19**, 190 (1929).
- [301] U.S. Weather Bureau, Barometers and the measurement of atmospheric pressure, Circular F, Instrument Division, reprinted (1930).
- [311] C. H. Meyers and R. S. Jessup, A multiple manometer and piston gauges for precision measurements, *BS J. Research* **6**, 1061 (1931) RP324.
- [321] A. Michels, The calibration of a pressure balance in absolute units, *Proc. Krinkl. Akad. Wetenschap., Amsterdam* **35**, 994 (1932).
- [331] F. E. Fowle, *Smithsonian physical tables*, 8th rev. ed., (Smithsonian Inst., 1933).
- [332] F. A. Gould and J. C. Evans, A new form of barostat, *J. Sci. Instr.* **10**, 215 (1933).
- [333] J. E. Sears and J. S. Clark, New standard barometer, *Proc. Roy. Soc. (A)* **139**, 130 (1933).
- [341] I. B. Smith and F. G. Keyes, Steam research, III A. Compressibility of liquid mercury from 30° to 300° C, *Proc. Am. Acad. Arts Sci.* **69**, 313 (1934).
- [351] C. Moon, A precision cathetometer, *J. Research NBS* **14**, 363 (1935) RP774.
- [361] E. Schmidt, Measurement of small pressure differences at high pressure, *VDI* **80**, 635 (1936). (In German).
- [371] J. R. Roebuck and W. Cram, A multiple column mercury manometer for pressures to 200 atmospheres, *Rev. Sci. Instr.* **8**, 215 (1937).
- [391] J. Reilly and W. N. Rae, *Physico-chemical methods*, 1, (D. Van Nostrand Co., N.Y., 1939).
- [401] B. E. Blaisdell, The physical properties of fluid interfaces of large radius of curvature. II. Numerical tables for capillary depressions and meniscus volumes, in moderately large tubes, *J. Math. and Phys.* **19**, 217 (1940).
- [411] J. A. Beattie, B. E. Blaisdell, and J. Kaye, An experimental study of the absolute temperature scale. IX. The determination of the capillary depression and meniscus volume of mercury in a manometer, *Proc. Am. Acad. Arts Sci.* **74**, 389 (1941).
- [412] J. A. Beattie, D. D. Jacobus, J. M. Gaines, Jr., M. Benedict, and B. E. Blaisdell, An experimental study of the absolute temperature scale. VI. The

- gas thermometer assembly and the experimental method, *Proc. Am. Acad. Arts Sci.* **74**, 327 (1941).
- [413] J. A. Beattie, B. E. Blaisdell, J. Kaye, H. T. Gerry, and C. A. Johnson, An experimental study of the absolute temperature scale. VIII. The thermal expansion and compressibility of vitreous silica and the thermal dilation of mercury, *Proc. Am. Acad. Arts Sci.* **74**, 370 (1941).
- [414] G. W. C. Kaye, and T. H. Laby, Physical and chemical constants (Longman, Green & Co., 1941).
- [421] E. Wickers, Pure mercury, *Chem. Eng. News* **20**, 1111 (1942).
- [451] J. Kistemaker, On the volume of mercury meniscus and the surface tension of mercury and deduced from them, *Physica* **11**, 270 (1945).
- [452] J. Kistemaker, The capillary depression of mercury and high precision manometry, *Physica* **11**, 277 (1945).
- [453] D. J. LeRoy, An automatic differential manometer, *Ind. Eng. Chem. Anal. Ed.* **17**, 652 (1945).
- [454] H. F. Stimson, The measurement of some thermal properties of water, *J. Wash. Acad. Sci.* **35**, 201 (1945).
- [461] C. Kemball, On the surface tension of mercury, *Trans. Faraday Soc.* **42**, 526 (1946).
- [471] D. R. Stull, Vapor pressure of pure substances, *Ind. Eng. Chem.* **39**, 517 (1947). (References and data on vapor pressure of mercury.)
- [481] D. P. Johnson, Calibration of altimeters under pressure conditions simulating dives and climbs, *NACA Tech. No. 1562*, (1948).
- [482] W. G. Bromacher and H. E. Ferguson, Manometer tables, *Inst. Soc. Am. RP2.1*, 32 pp. (1948).
- [483] I. E. Puddington, Sensitive mercury manometer, *Rev. Sci. Instr.* **19**, 577 (1948).
- [491] W. G. Brombacher, Some problems in the precise measurement of pressure, *Instruments* **22**, 355 (1949).
- [492] H. Ebert, Establishment of a pressure scale and experimental realization up to 20,000 atmospheres, *Z. angew. Phys.* **1**, 331 (1949). (In German.)
- [493] H. F. Stimson, The international temperature scale of 1948, *J. Research NBS* **42**, 209 (1949) RP1962.
- [494] R. S. Burden, Surface tension and the spreading of liquids, (Cambridge Univ. Press, 2d ed., 1949).
- [495] W. D. Wood, The development and maintenance of calibrating standards by an instrument manufacturer, *Instruments* **22**, 1004 (1949).
- [496] P. W. Bridgman, *The physics of high pressure* (G. Bell & Sons, London, 1931 ed. with suppl., 1949).
- [501] F. P. Price and P. D. Zemany, A simple recording manometer, *Rev. Sci. Instr.* **21**, 261 (1950).
- [511] S. Haynes, Automatic calibration of radiosonde baroswitches, *Electronics* **24**, 126 (May 1951).
- [512] R. G. List, *Smithsonian Meteorological Tables* 6th Rev. ed. (Smithsonian Instit., 1951).
- [513] J. M. Los and J. A. Morrison, A sensitive differential manometer, *Rev. Sci. Instr.* **22**, 805 (1951).
- [514] R. Meaken, Determination of mercury level in steel-tube manometer. *J. Sci. Instr.* **28**, 372 (1951).
- [515] E. C. Hass, Correcting mechanism for mercury column type measuring instruments, U.S. Patent No. 2,542,671 (Feb. 20, 1951).

- [516] T. B. Douglas, A. F. Ball, and D. C. Ginnings, Heat capacity of liquid mercury between 0° and 450°C; calculation of certain thermodynamic properties of the saturated liquid and vapor, *J. Research NBS* **46**, 334 (1951) RP2204.
- [521] F. A. Gould and T. Vickers, Capillary depression in mercury barometers and manometers, *J. Sci. Instr.* **29**, 85 (1952).
- [522] J. B. Lawrence, *Mercury, Instruments* **25**, 310 (1952).
- [531] Charles D. Hodgman, ed. *Handbook of physics and chemistry* (Chemical Publishing Co., 35th ed., 1953-54).
- [532] H. J. Svec and D. S. Gibbs, Recording mercurial manometer for pressure range 0-760 mm Hg, *Rev. Sci. Instr.* **24**, 202 (1953).
- [533] World Meteorological Organization, Commission for Instruments and Methods of Observation, Abridged final report of the first session, Toronto, 1953. WMO No. 19, RP 9, p. 73, Secretariat of the WMO, Geneva, Switzerland, 1953.
- [534] World Meteorological Organization, Fourth session of the Executive Committee, Geneva, 1953. Abridged report with resolutions. WMO No. 20, RC5, p. 86, Secretariat of the WMO, Geneva, Switzerland, 1953.
- [535] R. H. Busey and W. F. Giaque, The heat capacity of mercury from 15 to 330°C. Thermodynamic properties of solid, liquid and gas. Heat of fusion and vaporization, *J. Am. Chem. Soc.* **75**, 806 (1953).
- [541] K. E. Bett, P. F. Hayes, and D. M. Newitt, The construction, operation and performance of a primary standard mercury column for the measurement of high pressure. *Phil. Trans.* **247**, 59 (1954).
- [542] K. E. Bett, K. E. Weale, and D. M. Newitt, The critical evaluation of compression data for liquids and a revision of the isotherms of mercury, *Brit. J. Appl. Phys.* **5**, 243 (1954).
- [543] T. F. W. Embleton, A semi-automatic electrical manometer designed to calibrate a Mack-Zehnder interferometer system for the recording of transient pressure changes. *Rev. Sci. Instr.* **25**, 246 (1954).
- [544] J. R. Roebuck and H. W. Ibsen, Precision multiple-mercury-column-manometer, *Rev. Sci. Instr.* **25**, 46 (1954).
- [551] L. V. Judson, Units of weight and measure; definitions and tables of equivalents, *NBS Misc. Publ.* **214**, (1955).
- [552] National Physical Laboratories, Teddington, Measurement of pressure with the mercury barometer, Notes on App. Sci. No. 9, (1955).
- [553] H. F. Stimson, Precision resistance thermometry and fixed points; Temperature, its measurement and control, *Am. Inst. Phys.* **2**, 141 (1955).
- [554] E. T. Levanto, A new normal barometer, *Ann. Acad. Sci. Fennicae AI*, No. 191, (1955).
- [555] Helmut Moser, High temperature gas thermometry. Temperature, its measurement and control, *Am. Inst. Phys.* **2**, 103 (1955).
- [556] Second Congress of the World Meteorological Organization, Geneva, 1955. Final report, vol. II, Technical regulations. WMO No. 48, RC10, p. 23, Secretariat of the WMO, Geneva, Switzerland, 1956.
- [557] E. C. Halliday and H. J. Richards, The barometer calibrating facilities at the South African National Physical Laboratory. *S. African J. Sci.* **51**, 217 (1955).
- [558] F. M. Ernsberger and H. W. Pitman, New absolute manometer for vapor pressures in the micron range, *Rev. Sci. Instr.* **26**, 584 (1955).
- [561] N. Fuschillo, Improved method for cleaning mercury, *Rev. Sci. Instr.* **27**, 410 (1956).
- [562] M. Ross and E. E. Suckling, Permanent record from a mercury manometer, *Rev. Sci. Instr.* **27**, 409 (1956).
- [563] E. C. Halliday, Temperature corrections for commercial barometers. *S. African J. Sci.* **52**, 178 (1956).
- [564] World Meteorological Organization Technical Regulations, Secretariat of the WMO, Geneva, Switzerland **1**, WMO No. 49, Bd 2 (1956).
- [571] A. H. Cook and N. W. B. Stone, Precise measurements of the density of mercury at 20° C. I. Absolute displacement method. *Phil. Trans. [A]* **250**, 279 (1957).
- [572] J. Farquharson and H. A. Kermicle, Precise automatic manometer reader, *Rev. Sci. Instr.* **28**, 324 (1957).
- [573] K. W. T. Elliot and D. C. Wilson, An optical probe for accurately measuring displacements of a reflecting surface, *J. Sci. Instr.* **34**, 349 (1957).
- [574] C. L. Gordon and E. Wichers, Purification of mercury and its physical properties, *Ann. N.Y. Acad. Sci.* **65**, 369 (1957).
- [575] H. Moser, J. Otto and W. Thomas, Gasthermometrische Messungen bei hohen Temperaturen, *Z. Physik* **147**, 59 (1957).
- [576] J. Gielessen, Ueber ein Normalbarometer neuerer Konstruktion, *Z. Instrumentenk.* **65**, 63 (1957).
- [581] A. J. Eberlein, Laboratory pressure measurement requirements for evaluating air data computer, *Aeronaut. Eng. Rev.* **17**, 53 (1958).
- [582] Test for schedules of the National Bureau of Standards, *Mechanics*, Reprinted from Federal Register **23**, No. 188, (1958).
- [591] WBAN Manual of barometry. Published under sponsorship of U.S. Weather Bureau, Dept. of the Air Force, Air Weather Service and Dept. of the Navy, Naval Weather Service Division. Govt. Printing Office **1** (1959). In press.
- [592] Jean Terrien, Méthodes optiques pour mesurer la hauteur de mercure d'un manomètre; nouveau manomètre interférentiel, *Rev. d'Optique* **38**, 24 (1959).

TABLE 1. Conversion factors for various pressure units equivalent for unit value in first column

Pressure unit value	mb	mm mercury 0° C	in. mercury 0° C	g/cm ²	lb/in. ²	lb/ft ²	cm water 20° C	in. water 20° C
1 atm.....	1013.250	760.000	29.9213	1033.23	14.69595	2116.22	1035.08	407.513
1 mb.....	1	0.75006	0.029530	1.0197	0.014504	2.0886	1.0215	0.40218
1 mm mercury.....	1.3332	1	.03937	1.3595	.019337	2.7845	1.3609	.53577
1 in. mercury.....	33.864	25.400	1	34.532	.49116	70.727	34.566	13.609
1 g/cm ²	0.98066	0.73556	0.028959	1	.014223	2.0482	1.0010	0.39409
1 lb/in. ²	68.94752	51.715	2.0360	70.307	1	144	70.376	27.707
1 lb/ft ²	0.47880	0.35913	0.014139	0.48824	0.0069444	1	0.48872	0.19241
1 cm water 20° C.....	.97891	.73424	.028907	.99821	.014198	2.0445	1	.3937
1 in. water 20° C.....	2.4864	1.8650	.073424	2.5355	.036063	5.1930	2.5400	1

1 atm = 10332.3 Kg/m² = 1.03323 Kg/cm².

1 bar = 1000 mb = 10⁶ dynes/cm².

1 in. = 2.54 cm (old value, 2.54000508 cm; 2 parts per million greater).

1 lb = .45359237 Kg (old value, 0.45359243 Kg; 2 parts per 15 million greater).

TABLE 2. Ratio of the density of mercury at t° to the density at 0° C at 1 atm of pressure

$^\circ$ C	0	1	2	3	4	5	6	7	8	9
0	1.0000 0000	0.9998 1859	0.9996 3722	0.9994 5591	0.9992 7465	0.9990 9344	0.9989 1229	0.9987 3118	0.9985 5012	0.9983 6911
10	0.9981 8816	.9980 0725	.9978 2639	.9976 4559	.9974 6483	.9972 8412	.9971 0346	.9969 2285	.9967 4228	.9965 6177
20	.9963 8130	.9962 0088	.9960 2051	.9958 4019	.9956 5991	.9954 7968	.9952 9950	.9951 1936	.9949 3927	.9947 5923
30	.9945 7923	.9943 9928	.9942 1938	.9940 3952	.9938 5970	.9936 7993	.9935 0021	.9933 2053	.9931 4089	.9929 6130
40	.9927 8175	.9926 0225	.9924 2279	.9922 4337	.9920 6400	.9918 8467	.9917 0538	.9915 2614	.9913 4694	.9911 6777
50	.9909 8866	.9908 0958	.9906 3054	.9904 5155	.9902 7260	.9900 9369	.9899 1482	.9897 3598	.9895 5719	.9893 7844

TABLE 3A. Density and vapor pressure of mercury

The density is based upon the value 13.5951 g/cm³ at 0° C and the ratios of Table 2.

Temperature		Density	Vapor pressure 0.001 mm of mercury	Temperature		Density	Vapor pressure 0.001 mm of mercury
$^\circ$ C	$^\circ$ F	g/cm^3		$^\circ$ C	$^\circ$ F	g/cm^3	
-20	-4	13.6446	0.024	30	86	13.5214	2.94
-10	14	13.6198	.073	31	87.8	13.5190	
0	32	13.5951	.203	32	89.6	13.5165	
1	33.8	13.5926		33	91.4	13.5141	
2	35.6	13.5902		34	93.2	13.5116	
3	37.4	13.5877		35	95	13.5092	4.37
4	39.2	13.5852		36	96.8	13.5067	
5	41	13.5828	.300	37	98.6	13.5043	
6	42.8	13.5803		38	100.4	13.5018	
7	44.6	13.5779		39	102.2	13.4994	
8	46.4	13.5754		40	104	13.4970	6.32
9	48.2	13.5729		41	105.8	13.4945	
10	50	13.5705	.540	42	107.6	13.4921	
11	51.8	13.5680		43	109.4	13.4896	
12	53.6	13.5655		44	111.2	13.4872	
13	55.4	13.5631		45	113	13.4848	9.26
14	57.2	13.5606		46	114.8	13.4823	
15	59	13.5582	.829	47	116.6	13.4799	
16	60.8	13.5557		48	118.4	13.4775	
17	62.6	13.5533		49	120.2	13.4750	
18	64.4	13.5508	1.08	50	122	13.4726	13.26
19	66.2	13.5484		51	123.8	13.4702	
20	68	13.5459	1.28	52	125.6	13.4677	
21	69.8	13.5435		53	127.4	13.4653	
22	71.6	13.5410	1.52	54	129.2	13.4629	
23	73.4	13.5385		55	131	13.4604	18.78
24	75.2	13.5361	1.80	56	132.8	13.4580	
25	77	13.5336		57	134.6	13.4556	
26	78.8	13.5312	2.12	58	136.4	13.4531	
27	80.6	13.5287		59	138.2	13.4507	
28	82.4	13.5263	2.50	60	140	13.4483	26.32
29	84.2	13.5239					

TABLE 3B. Density of mercury

The density is based upon the conversion factor: unit $g/cm^3=0.03612729$ lb/in.³ in which 1 in.=2.54 cm and 1 lb=453.59237 g

Temperature		Density	
$^\circ$ F		lb/in. ³	g/cm^3
0		0.49274	13.6391
10		.49225	13.6253
20		.49175	13.6116
32		.491154	13.5951
40		.49076	13.5841
50		.49026	13.5704
60		.48977	13.5568
70		.48928	13.5431
80		.48878	13.5295
90		.48829	13.5159
100		.48780	13.5023
110		.48731	13.4888
120		.48683	13.4753
130		.48633	13.4617

TABLE 4. Density of mercury

Based upon the value of 13.5458 925 g/cm³ at 20° C and the ratios of table 2

Temperature		Density	Temperature		Density
$^\circ$ C	$^\circ$ F	g/cm^3	$^\circ$ C	$^\circ$ F	g/cm^3
0	32.00	13.5950 889	30	86.00	13.5213 930
1	33.80	13.5926 226	31	87.80	13.5189 466
2	35.60	13.5901 569	32	89.60	13.5165 009
3	37.40	13.5876 919	33	91.40	13.5140 556
4	39.20	13.5852 277	34	93.20	13.5116 110
5	41.00	13.5827 641	35	95.00	13.5091 670
6	42.80	13.5803 014	36	96.80	13.5067 237
7	44.60	13.5778 392	37	98.60	13.5042 809
8	46.40	13.5753 777	38	100.40	13.5018 387
9	48.20	13.5729 168	39	102.20	13.4993 971
10	50.00	13.5704 568	40	104.00	13.4969 561
11	51.80	13.5679 973	41	105.80	13.4945 158
12	53.60	13.5655 385	42	107.60	13.4920 761
13	55.40	13.5630 805	43	109.40	13.4896 368
14	57.20	13.5606 230	44	111.20	13.4871 983
15	59.00	13.5581 663	45	113.00	13.4847 603
16	60.80	13.5557 102	46	114.80	13.4823 228
17	62.60	13.5532 548	47	116.60	13.4798 860
18	64.40	13.5507 999	48	118.40	13.4774 498
19	66.20	13.5483 459	49	120.20	13.4750 139
20	68.00	13.5458 924	50	122.00	13.4725 789
21	69.80	13.5434 395	51	123.80	13.4701 443
22	71.60	13.5409 874	52	125.60	13.4677 103
23	73.40	13.5385 359	53	127.40	13.4652 769
24	75.20	13.5360 850	54	129.20	13.4628 440
25	77.00	13.5336 347	55	131.00	13.4604 117
26	78.80	13.5311 852	56	132.80	13.4579 806
27	80.60	13.5287 362	57	134.60	13.4555 486
28	82.40	13.5262 878	58	136.40	13.4531 180
29	84.20	13.5238 402	59	138.20	13.4506 878

TABLE 5. Coefficients of linear expansion

Multiply all values by 10^{-8}

Material	Coefficient	
	per $^\circ$ C	per $^\circ$ F
Aluminum.....	24.5 \pm 0.5	13.6
Brass, yellow.....	18.4 \pm 0.8	10.22
Cast iron.....	8.5 \pm 0.5	4.7
Duralumin.....	23.5 \pm 1	13.1
Glass, soda lime.....	8.5 \pm 0.5	4.7
Glass, Pyrex.....	3.0	1.7
Invar.....	0 to 5	0 to 3
Monel metal.....	14 \pm 0.5	7.8
Stainless steel (18+8).....	17 \pm 1	9.4
Stainless steel, Carpenter No. 8.....	17 \pm 0.5	9.4
Steel, low carbon.....	11.5 \pm 0.5	6.4

TABLE 6. *Temperature corrections for Fortin barometer with brass scales*

All corrections are to be subtracted from the reading.

Temperature	Correction factor	Barometer reading, millibars, inches or millimeters of mercury																		
		100	105	110	115	120	125	130	135	140	145	150	155	160	165	170	175	180	185	190
° C	%	0.00	0.00	0.00	0.00	0.00	0.00	0.00	0.00	0.00	0.00	0.00	0.00	0.00	0.00	0.00	0.00	0.00	0.00	0.00
0	.081626	.16	.09	.09	.09	.10	.10	.11	.11	.11	.12	.12	.13	.13	.14	.14	.15	.15	.16	.16
5	.16310	.18	.17	.18	.19	.20	.20	.21	.22	.23	.24	.24	.25	.26	.27	.28	.29	.30	.31	.32
11	.17938	.18	.19	.20	.21	.22	.22	.23	.24	.25	.26	.27	.28	.29	.30	.31	.32	.33	.34	.35
12	.19565	.20	.21	.22	.22	.23	.24	.25	.26	.27	.28	.29	.30	.31	.32	.33	.34	.35	.36	.37
13	.21192	.21	.22	.23	.24	.25	.26	.28	.29	.30	.31	.32	.33	.34	.35	.36	.37	.38	.39	.40
14	.22818	.23	.24	.25	.26	.27	.29	.30	.31	.32	.33	.34	.35	.37	.38	.39	.40	.41	.42	.43
15	.24443	.24	.26	.27	.28	.29	.31	.32	.33	.34	.35	.37	.38	.39	.40	.42	.43	.44	.45	.46
16	.26068	.26	.27	.29	.30	.31	.33	.34	.35	.36	.38	.39	.40	.42	.43	.44	.46	.47	.48	.50
17	.27692	.28	.29	.30	.32	.33	.35	.36	.37	.39	.40	.42	.43	.44	.46	.47	.48	.50	.51	.53
18	.29316	.29	.31	.32	.34	.35	.37	.38	.40	.41	.43	.44	.45	.47	.48	.50	.51	.53	.54	.56
19	.30939	.31	.32	.34	.36	.37	.39	.40	.42	.43	.45	.46	.48	.50	.51	.53	.54	.56	.57	.59
20	.32562	.33	.34	.36	.37	.39	.41	.42	.44	.46	.47	.49	.50	.52	.54	.55	.57	.59	.60	.62
21	.34183	.34	.36	.38	.39	.41	.43	.44	.46	.48	.50	.51	.53	.55	.56	.58	.60	.62	.63	.65
22	.35805	.36	.38	.39	.41	.43	.45	.47	.48	.50	.52	.54	.55	.57	.59	.61	.63	.64	.66	.68
23	.37426	.37	.39	.41	.43	.45	.47	.49	.51	.52	.54	.56	.58	.60	.62	.64	.65	.67	.69	.71
24	.39046	.39	.41	.43	.45	.47	.49	.51	.53	.55	.57	.59	.61	.62	.64	.66	.68	.70	.72	.74
25	.40665	.41	.43	.45	.47	.49	.51	.53	.55	.57	.59	.61	.63	.65	.67	.69	.71	.73	.75	.77
26	.42284	.42	.44	.47	.49	.51	.53	.55	.57	.59	.61	.64	.66	.68	.70	.72	.74	.76	.78	.80
27	.43903	.44	.46	.48	.50	.53	.55	.57	.59	.61	.64	.66	.68	.70	.72	.75	.77	.79	.81	.83
28	.45520	.46	.48	.50	.52	.55	.57	.59	.61	.64	.66	.68	.71	.73	.75	.77	.80	.82	.84	.86
29	.47137	.47	.49	.52	.54	.57	.59	.61	.64	.66	.68	.71	.73	.75	.78	.80	.82	.85	.87	.90
30	.48754	.49	.51	.54	.56	.59	.61	.63	.66	.68	.71	.73	.76	.78	.80	.83	.85	.88	.90	.93
31	.50370	.50	.53	.55	.58	.60	.63	.65	.68	.71	.73	.76	.78	.81	.83	.86	.88	.91	.93	.96
32	.51986	.52	.55	.57	.60	.62	.65	.68	.70	.73	.75	.78	.81	.83	.86	.88	.91	.94	.96	.99
33	.53600	.54	.56	.59	.62	.64	.67	.70	.72	.75	.78	.80	.83	.86	.88	.91	.94	.96	.99	1.02
34	.55215	.55	.58	.61	.63	.66	.69	.72	.75	.77	.80	.83	.86	.88	.91	.94	.97	.99	1.02	1.05
35	.56828	.57	.60	.63	.65	.68	.71	.74	.77	.80	.82	.85	.88	.91	.94	.97	.99	1.02	1.05	1.08
36	.58442	.58	.61	.64	.67	.70	.73	.76	.79	.82	.85	.88	.91	.94	.96	.99	1.02	1.05	1.08	1.11
37	.60054	.60	.63	.66	.69	.72	.75	.78	.81	.84	.87	.90	.93	.96	.99	1.02	1.05	1.08	1.11	1.14
38	.61666	.62	.65	.68	.71	.74	.77	.80	.83	.86	.89	.92	.96	.99	1.02	1.05	1.08	1.11	1.14	1.17
39	.63277	.63	.66	.70	.73	.76	.79	.82	.85	.89	.92	.95	.98	1.01	1.04	1.08	1.11	1.14	1.17	1.20
40	.64888	.65	.68	.71	.75	.78	.81	.84	.88	.91	.94	.97	1.01	1.04	1.07	1.10	1.14	1.17	1.20	1.23
41	.66498	.66	.70	.73	.76	.80	.83	.86	.90	.93	.96	1.00	1.03	1.06	1.10	1.13	1.16	1.20	1.23	1.26
42	.68108	.68	.72	.75	.78	.82	.85	.89	.92	.95	.99	1.02	1.06	1.09	1.12	1.16	1.19	1.23	1.26	1.29
43	.69717	.70	.73	.77	.80	.84	.87	.91	.94	.98	1.01	1.05	1.08	1.12	1.15	1.19	1.22	1.25	1.29	1.32
44	.71325	.71	.75	.78	.82	.86	.89	.93	.96	1.00	1.03	1.07	1.11	1.14	1.18	1.21	1.25	1.28	1.32	1.36
45	.72933	.73	.77	.80	.84	.88	.91	.95	.98	1.02	1.06	1.09	1.13	1.17	1.20	1.24	1.28	1.31	1.35	1.39
46	.74541	.75	.78	.82	.86	.89	.93	.97	1.01	1.04	1.08	1.12	1.16	1.19	1.23	1.27	1.30	1.34	1.38	1.42
47	.76147	.76	.80	.84	.88	.91	.95	.99	1.03	1.07	1.10	1.14	1.18	1.22	1.26	1.29	1.33	1.37	1.41	1.45
48	.77744	.78	.82	.86	.89	.93	.97	1.01	1.05	1.09	1.13	1.17	1.21	1.24	1.28	1.32	1.36	1.40	1.44	1.48
49	.79359	.79	.83	.87	.91	.95	.99	1.03	1.07	1.11	1.15	1.19	1.23	1.27	1.31	1.35	1.39	1.43	1.47	1.51
50	.80964	.81	.85	.89	.93	.97	1.01	1.05	1.09	1.13	1.17	1.21	1.25	1.30	1.34	1.38	1.42	1.46	1.50	1.55

Temperature	Barometer reading, millibars, inches or millimeters of mercury																			
	200	205	210	215	220	225	230	235	240	245	250	255	260	265	270	275	280	285	290	295
° C	0.00	0.00	0.00	0.00	0.00	0.00	0.00	0.00	0.00	0.00	0.00	0.00	0.00	0.00	0.00	0.00	0.00	0.00	0.00	
0	.16	.17	.17	.18	.18	.18	.19	.19	.20	.20	.20	.21	.21	.22	.22	.22	.23	.23	.24	.24
5	.33	.33	.34	.35	.36	.37	.38	.38	.39	.40	.41	.42	.42	.43	.44	.45	.46	.46	.47	.48
11	.36	.37	.38	.39	.39	.40	.41	.42	.43	.44	.45	.46	.47	.48	.48	.49	.50	.51	.52	.53
12	.39	.40	.41	.42	.43	.44	.45	.46	.47	.48	.49	.50	.51	.52	.53	.54	.55	.56	.57	.58
13	.42	.43	.45	.46	.47	.48	.49	.50	.51	.52	.53	.54	.55	.56	.57	.58	.59	.60	.61	.63
14	.46	.47	.48	.49	.50	.51	.52	.54	.55	.56	.57	.58	.59	.60	.62	.63	.64	.65	.66	.67
15	.49	.50	.51	.53	.54	.55	.56	.57	.59	.60	.61	.62	.64	.65	.66	.67	.68	.70	.71	.72
16	.52	.53	.55	.56	.57	.59	.60	.61	.63	.64	.65	.66	.68	.69	.70	.72	.73	.74	.76	.77
17	.55	.57	.58	.60	.61	.62	.64	.65	.66	.68	.69	.71	.72	.73	.75	.76	.78	.79	.80	.82
18	.59	.60	.62	.63	.64	.66	.67	.69	.70	.72	.73	.75	.76	.78	.79	.81	.82	.84	.85	.86
19	.62	.63	.65	.67	.68	.70	.71	.73	.74	.76	.77	.79	.80	.82	.84	.85	.87	.88	.90	.91
20	.65	.67	.68	.70	.72	.73	.75	.77	.78	.80	.81	.83	.85	.86	.88	.90	.91	.93	.94	.96
21	.68	.70	.72	.73	.75	.77	.79	.80	.82	.84	.85	.87	.89	.91	.92	.94	.96	.97	.99	1.01
22	.72	.73	.75	.77	.79	.81	.82	.84	.86	.88	.90	.91	.93	.95	.97	.98	1.00	1.02	1.04	1.06
23	.75	.77	.79	.80	.82	.84	.86	.88	.90	.92	.94	.95	.97	.99	1.01	1.03	1.05	1.07	1.09	1.10
24	.78	.80	.82	.84	.86	.88	.90	.92	.94	.96	.98	1.00	1.02	1.03	1.05	1.07	1.09	1.11	1.13	1.15
25	.81	.83	.85	.87	.89	.91	.94	.96	.98	1.00	1.02	1.04	1.06	1.08	1.10	1.12	1.14	1.16	1.18	1.20
26	.85	.87	.89	.91	.93	.95	.97	.99	1.01	1.04	1.06	1.08	1.10	1.12	1.14	1.16	1.18	1.21	1.23	1.25
27	.88	.90	.92	.94	.97	.99	1.01	1.03	1.05	1.08	1.10	1.12	1.14	1.16	1.19	1.21	1.23	1.25	1.27	1.30
28	.91	.93	.96	.98	1.00	1.02	1.05	1.07	1.09	1.12	1.14	1.16	1.18	1.21	1.23	1.25	1.27	1.30	1.32	1.34
29	.94	.97	.99	1.01	1.04	1.06	1.08	1.11	1.13	1.15	1.18	1.20	1.23	1.25	1.27	1.30	1.32	1.34	1.37	1.39
30	.98	1.00	1.02	1.05	1.07	1.10	1.12	1.15	1.17	1.19	1.22	1.24	1.27	1.29	1.32	1.34	1.37	1.39	1.41	1.44

TABLE 6. *Temperature corrections for Fortin barometer with brass scales—Continued*

All corrections are to be subtracted from the reading.

Temperature ° C	Barometer reading, millibars, inches or millimeters of mercury																			
	200	205	210	215	220	225	230	235	240	245	250	255	260	265	270	275	280	285	290	295
31	1.01	1.03	1.06	1.08	1.11	1.13	1.16	1.18	1.21	1.23	1.26	1.28	1.31	1.33	1.36	1.39	1.41	1.44	1.46	1.49
32	1.04	1.07	1.09	1.12	1.14	1.17	1.20	1.22	1.25	1.27	1.30	1.33	1.35	1.38	1.40	1.43	1.46	1.48	1.51	1.53
33	1.07	1.10	1.13	1.15	1.18	1.21	1.23	1.26	1.29	1.31	1.34	1.37	1.39	1.42	1.45	1.47	1.50	1.53	1.55	1.58
34	1.10	1.13	1.16	1.19	1.21	1.24	1.27	1.30	1.33	1.35	1.38	1.41	1.44	1.46	1.49	1.52	1.55	1.57	1.60	1.63
35	1.14	1.16	1.19	1.22	1.25	1.28	1.31	1.34	1.36	1.39	1.42	1.45	1.48	1.51	1.53	1.56	1.59	1.62	1.65	1.68
36	1.17	1.20	1.23	1.26	1.29	1.31	1.34	1.37	1.40	1.43	1.46	1.49	1.52	1.55	1.58	1.61	1.64	1.67	1.69	1.72
37	1.20	1.23	1.26	1.29	1.32	1.35	1.38	1.41	1.44	1.47	1.50	1.53	1.56	1.59	1.62	1.65	1.68	1.71	1.74	1.77
38	1.23	1.26	1.29	1.33	1.36	1.39	1.42	1.45	1.48	1.51	1.54	1.57	1.60	1.63	1.66	1.70	1.73	1.76	1.79	1.82
39	1.27	1.30	1.33	1.36	1.39	1.42	1.46	1.49	1.52	1.55	1.58	1.61	1.65	1.68	1.71	1.74	1.77	1.80	1.84	1.87
40	1.30	1.33	1.36	1.40	1.43	1.46	1.49	1.52	1.56	1.59	1.62	1.65	1.69	1.72	1.75	1.78	1.82	1.85	1.88	1.91
41	1.33	1.36	1.40	1.43	1.46	1.50	1.53	1.56	1.60	1.63	1.66	1.70	1.73	1.76	1.80	1.83	1.86	1.90	1.93	1.96
42	1.36	1.40	1.43	1.46	1.50	1.53	1.57	1.60	1.63	1.67	1.70	1.74	1.77	1.80	1.84	1.87	1.91	1.94	1.98	2.01
43	1.39	1.43	1.46	1.50	1.53	1.57	1.60	1.64	1.67	1.71	1.74	1.78	1.81	1.85	1.88	1.92	1.95	1.99	2.02	2.06
44	1.43	1.46	1.50	1.53	1.57	1.60	1.64	1.68	1.71	1.75	1.78	1.82	1.85	1.89	1.93	1.96	2.00	2.03	2.07	2.10
45	1.46	1.50	1.53	1.57	1.60	1.64	1.68	1.71	1.75	1.79	1.82	1.86	1.90	1.93	1.97	2.01	2.04	2.08	2.12	2.15
46	1.49	1.53	1.57	1.60	1.64	1.68	1.71	1.75	1.79	1.83	1.86	1.90	1.94	1.98	2.01	2.05	2.09	2.12	2.16	2.20
47	1.52	1.56	1.60	1.64	1.68	1.71	1.75	1.79	1.83	1.87	1.90	1.94	1.98	2.02	2.06	2.09	2.13	2.17	2.21	2.25
48	1.56	1.59	1.63	1.67	1.71	1.75	1.79	1.83	1.87	1.90	1.94	1.98	2.02	2.06	2.10	2.14	2.18	2.22	2.25	2.29
49	1.59	1.63	1.67	1.71	1.75	1.79	1.83	1.86	1.90	1.94	1.98	2.02	2.06	2.10	2.14	2.18	2.22	2.26	2.30	2.34
50	1.62	1.66	1.70	1.74	1.78	1.82	1.86	1.90	1.94	1.98	2.02	2.06	2.11	2.15	2.19	2.23	2.27	2.31	2.35	2.39

Temperature ° C	Barometer reading, millibars, inches or millimeters of mercury																			
	300	305	310	315	320	325	330	335	340	345	350	355	360	365	370	375	380	385	390	395
0	0.00	0.00	0.00	0.00	0.00	0.00	0.00	0.00	0.00	0.00	0.00	0.00	0.00	0.00	0.00	0.00	0.00	0.00	0.00	0.00
5	.24	.25	.25	.26	.26	.27	.27	.27	.28	.28	.29	.29	.29	.30	.30	.31	.31	.31	.32	.32
10	.49	.50	.51	.51	.52	.53	.54	.55	.55	.56	.57	.58	.59	.60	.60	.61	.62	.63	.64	.64
11	.54	.55	.56	.57	.57	.58	.59	.60	.61	.62	.63	.64	.65	.65	.66	.67	.68	.69	.70	.71
12	.59	.60	.61	.62	.63	.64	.65	.66	.67	.67	.68	.69	.70	.71	.72	.73	.74	.75	.76	.77
13	.64	.65	.66	.67	.68	.69	.70	.71	.72	.73	.74	.75	.76	.77	.78	.79	.81	.82	.83	.84
14	.68	.69	.71	.72	.73	.74	.75	.76	.78	.79	.80	.81	.82	.83	.84	.86	.87	.88	.89	.90
15	.73	.75	.76	.77	.78	.79	.81	.82	.83	.84	.86	.87	.88	.89	.90	.92	.93	.94	.95	.97
16	.78	.80	.81	.82	.83	.85	.86	.87	.89	.90	.91	.93	.94	.95	.96	.98	.99	1.00	1.02	1.03
17	.83	.84	.86	.87	.89	.90	.91	.93	.94	.96	.97	.98	1.00	1.01	1.02	1.04	1.05	1.07	1.08	1.09
18	.88	.89	.91	.92	.94	.95	.97	.98	1.00	1.01	1.03	1.04	1.06	1.07	1.08	1.10	1.11	1.13	1.14	1.16
19	.93	.94	.96	.97	.99	1.01	1.02	1.04	1.05	1.07	1.08	1.10	1.11	1.13	1.14	1.16	1.18	1.19	1.21	1.22
20	.98	.99	1.01	1.03	1.04	1.06	1.07	1.09	1.11	1.12	1.14	1.16	1.17	1.19	1.20	1.22	1.24	1.25	1.27	1.29
21	1.03	1.04	1.06	1.08	1.09	1.11	1.13	1.15	1.16	1.18	1.20	1.21	1.23	1.25	1.26	1.28	1.30	1.32	1.33	1.35
22	1.07	1.09	1.11	1.13	1.15	1.16	1.18	1.20	1.22	1.24	1.25	1.27	1.29	1.31	1.32	1.34	1.36	1.38	1.40	1.41
23	1.12	1.14	1.16	1.18	1.20	1.22	1.24	1.25	1.27	1.29	1.31	1.33	1.35	1.37	1.38	1.40	1.42	1.44	1.46	1.48
24	1.17	1.19	1.21	1.23	1.25	1.27	1.29	1.31	1.33	1.35	1.37	1.39	1.41	1.43	1.44	1.46	1.48	1.50	1.52	1.54
25	1.22	1.24	1.26	1.28	1.30	1.32	1.34	1.36	1.38	1.40	1.42	1.44	1.46	1.48	1.50	1.52	1.55	1.57	1.59	1.61
26	1.27	1.29	1.31	1.33	1.35	1.37	1.40	1.42	1.44	1.46	1.48	1.50	1.52	1.54	1.56	1.59	1.61	1.63	1.65	1.67
27	1.32	1.34	1.36	1.38	1.40	1.43	1.45	1.47	1.49	1.51	1.54	1.56	1.58	1.60	1.62	1.65	1.67	1.69	1.71	1.73
28	1.37	1.39	1.41	1.43	1.46	1.48	1.50	1.52	1.55	1.57	1.59	1.62	1.64	1.66	1.68	1.71	1.73	1.75	1.78	1.80
29	1.41	1.44	1.46	1.48	1.51	1.53	1.56	1.58	1.60	1.63	1.65	1.67	1.70	1.72	1.74	1.77	1.79	1.81	1.84	1.86
30	1.46	1.49	1.51	1.54	1.56	1.58	1.61	1.63	1.66	1.68	1.71	1.73	1.76	1.78	1.80	1.83	1.85	1.88	1.90	1.93
31	1.51	1.54	1.56	1.59	1.61	1.64	1.66	1.69	1.71	1.74	1.76	1.79	1.81	1.84	1.86	1.89	1.91	1.94	1.96	1.99
32	1.56	1.59	1.61	1.64	1.66	1.69	1.72	1.74	1.77	1.79	1.82	1.85	1.87	1.90	1.92	1.95	1.98	2.00	2.03	2.05
33	1.61	1.63	1.66	1.69	1.72	1.74	1.77	1.80	1.82	1.85	1.88	1.90	1.93	1.96	1.98	2.01	2.04	2.06	2.09	2.12
34	1.66	1.68	1.71	1.74	1.77	1.79	1.82	1.85	1.88	1.90	1.93	1.96	1.99	2.02	2.04	2.07	2.10	2.13	2.15	2.18
35	1.70	1.73	1.76	1.79	1.82	1.85	1.88	1.90	1.93	1.96	1.99	2.02	2.05	2.07	2.10	2.13	2.16	2.19	2.22	2.24
36	1.75	1.78	1.81	1.84	1.87	1.90	1.93	1.96	1.99	2.02	2.05	2.07	2.10	2.13	2.16	2.19	2.22	2.25	2.28	2.31
37	1.80	1.83	1.86	1.89	1.92	1.95	1.98	2.01	2.04	2.07	2.10	2.13	2.16	2.19	2.22	2.25	2.28	2.31	2.34	2.37
38	1.85	1.88	1.91	1.94	1.97	2.00	2.03	2.07	2.10	2.13	2.16	2.19	2.22	2.25	2.28	2.31	2.34	2.37	2.40	2.44
39	1.90	1.93	1.96	1.99	2.02	2.06	2.09	2.12	2.15	2.18	2.21	2.25	2.28	2.30	2.34	2.37	2.40	2.44	2.47	2.50
40	1.95	1.98	2.01	2.04	2.08	2.11	2.14	2.17	2.21	2.24	2.27	2.30	2.34	2.37	2.40	2.43	2.47	2.50	2.53	2.56
41	1.99	2.03	2.06	2.09	2.13	2.16	2.19	2.23	2.26	2.29	2.33	2.36	2.39	2.43	2.46	2.49	2.53	2.56	2.59	2.63
42	2.04	2.08	2.11	2.15	2.18	2.21	2.25	2.28	2.32	2.35	2.38	2.42	2.45	2.49	2.52	2.55	2.59	2.62	2.66	2.69
43	2.09	2.13	2.16	2.20	2.23	2.27	2.30	2.34	2.37	2.41	2.44	2.47	2.51	2.54	2.58	2.61	2.65	2.68	2.72	2.75
44	2.14	2.18	2.21	2.25	2.28	2.32	2.35	2.39	2.43	2.46	2.50	2.53	2.57	2.60	2.64	2.67	2.71	2.75	2.78	2.82
45	2.19	2.22	2.26	2.30	2.33	2.37	2.41	2.44	2.48	2.52	2.55	2.59	2.63	2.66	2.70	2.74	2.77	2.81	2.84	2.88
46	2.24	2.27	2.31	2.35	2.39	2.42	2.46	2.50	2.53	2.57	2.61	2.65	2.68	2.72	2.76	2.80	2.83	2.87	2.91	2.94
47	2.28	2.32	2.36	2.40	2.44	2.47	2.51	2.55	2.59	2.63	2.67	2.70	2.74	2.78	2.82	2.86	2.89	2.93	2.97	3.01
48	2.33	2.37	2.41	2.45	2.49	2.53	2.57	2.60	2.64	2.68	2.72	2.76	2.80	2.84	2.88	2.92	2.95	2.99	3.03	3.07
49	2.38	2.42	2.46	2.50	2.54	2.58	2.62	2.66	2.70	2.74	2.78	2.82	2.86	2.90	2.94	2.98	3.02	3.06	3.10	3.13
50	2.43	2.47	2.51	2.55	2.59	2.63	2.67	2.71	2.75	2.79	2.83	2.87	2.91	2.96	3.00	3.04	3.08	3.12	3.16	3.20

TABLE 6. *Temperature corrections for Fortin barometer with brass scales—Continued*

All corrections are to be subtracted from the reading.

Temperature	Barometer reading, millibars, inches or millimeters of mercury																			
	400	405	410	415	420	425	430	435	440	445	450	455	460	465	470	475	480	485	490	495
° C																				
0	0.00	0.00	0.00	0.00	0.00	0.00	0.00	0.00	0.00	0.00	0.00	0.00	0.00	0.00	0.00	0.00	0.00	0.00	0.00	0.00
5	.33	.33	.33	.34	.34	.35	.35	.36	.36	.37	.37	.38	.38	.38	.39	.39	.39	.40	.40	.40
10	.65	.66	.67	.68	.69	.69	.70	.71	.72	.73	.73	.74	.75	.76	.77	.77	.78	.79	.80	.81
11	.72	.73	.74	.74	.75	.76	.77	.78	.79	.80	.81	.82	.83	.83	.84	.85	.86	.87	.88	.89
12	.78	.79	.80	.81	.82	.83	.84	.85	.86	.87	.88	.89	.90	.91	.92	.93	.94	.95	.96	.97
13	.85	.86	.87	.88	.89	.90	.91	.92	.93	.94	.95	.96	.97	.99	1.00	1.01	1.02	1.03	1.04	1.05
14	.91	.92	.94	.95	.96	.97	.98	.99	1.00	1.02	1.03	1.04	1.05	1.06	1.07	1.08	1.10	1.11	1.12	1.13
15	.98	.99	1.00	1.01	1.03	1.04	1.05	1.06	1.08	1.09	1.10	1.11	1.12	1.14	1.15	1.16	1.17	1.19	1.20	1.21
16	1.04	1.06	1.07	1.08	1.09	1.11	1.12	1.13	1.15	1.16	1.17	1.19	1.20	1.21	1.23	1.24	1.25	1.26	1.28	1.29
17	1.11	1.12	1.14	1.15	1.16	1.18	1.19	1.20	1.22	1.23	1.25	1.26	1.27	1.29	1.30	1.32	1.33	1.34	1.36	1.37
18	1.17	1.19	1.20	1.22	1.23	1.25	1.26	1.28	1.29	1.30	1.32	1.33	1.35	1.36	1.38	1.39	1.41	1.42	1.44	1.45
19	1.24	1.25	1.27	1.28	1.30	1.31	1.33	1.35	1.36	1.38	1.39	1.41	1.42	1.44	1.45	1.47	1.49	1.50	1.52	1.53
20	1.30	1.32	1.34	1.35	1.37	1.38	1.40	1.42	1.43	1.45	1.47	1.48	1.50	1.51	1.53	1.55	1.56	1.58	1.60	1.61
21	1.37	1.38	1.40	1.42	1.44	1.45	1.47	1.49	1.50	1.52	1.54	1.56	1.57	1.59	1.61	1.62	1.64	1.66	1.67	1.69
22	1.43	1.45	1.47	1.49	1.50	1.52	1.54	1.56	1.58	1.59	1.61	1.63	1.65	1.66	1.68	1.70	1.72	1.74	1.75	1.77
23	1.50	1.52	1.53	1.55	1.57	1.59	1.61	1.63	1.65	1.67	1.68	1.70	1.72	1.74	1.76	1.78	1.80	1.82	1.83	1.85
24	1.56	1.58	1.60	1.62	1.64	1.66	1.68	1.70	1.72	1.74	1.76	1.78	1.80	1.82	1.84	1.85	1.87	1.89	1.91	1.93
25	1.63	1.65	1.67	1.69	1.71	1.73	1.75	1.77	1.79	1.81	1.83	1.85	1.87	1.89	1.91	1.93	1.95	1.97	1.99	2.01
26	1.69	1.71	1.73	1.75	1.78	1.80	1.82	1.84	1.86	1.88	1.90	1.92	1.95	1.97	1.99	2.01	2.03	2.05	2.07	2.09
27	1.76	1.78	1.80	1.82	1.84	1.87	1.89	1.91	1.93	1.95	1.98	2.00	2.02	2.04	2.06	2.09	2.11	2.13	2.15	2.17
28	1.82	1.84	1.87	1.89	1.91	1.93	1.96	1.98	2.00	2.03	2.05	2.07	2.09	2.12	2.14	2.16	2.18	2.21	2.23	2.25
29	1.89	1.91	1.93	1.96	1.98	2.00	2.03	2.05	2.07	2.10	2.12	2.14	2.17	2.19	2.22	2.24	2.26	2.29	2.31	2.33
30	1.95	1.97	2.00	2.02	2.05	2.07	2.10	2.12	2.15	2.17	2.19	2.22	2.24	2.27	2.29	2.32	2.34	2.36	2.39	2.41
31	2.01	2.04	2.07	2.09	2.12	2.14	2.17	2.19	2.22	2.24	2.27	2.29	2.32	2.34	2.37	2.39	2.42	2.44	2.47	2.49
32	2.08	2.11	2.13	2.16	2.18	2.21	2.24	2.26	2.29	2.31	2.34	2.37	2.39	2.42	2.44	2.47	2.50	2.52	2.55	2.57
33	2.14	2.17	2.20	2.22	2.25	2.28	2.30	2.33	2.36	2.39	2.41	2.44	2.47	2.49	2.52	2.55	2.57	2.60	2.63	2.65
34	2.21	2.24	2.26	2.29	2.32	2.35	2.37	2.40	2.43	2.46	2.48	2.51	2.54	2.57	2.60	2.62	2.65	2.68	2.71	2.73
35	2.27	2.30	2.33	2.36	2.39	2.42	2.44	2.47	2.50	2.53	2.56	2.59	2.61	2.64	2.67	2.70	2.73	2.76	2.78	2.81
36	2.34	2.37	2.40	2.43	2.45	2.48	2.51	2.54	2.57	2.60	2.63	2.66	2.69	2.72	2.75	2.78	2.81	2.83	2.86	2.89
37	2.40	2.43	2.46	2.49	2.52	2.55	2.58	2.61	2.64	2.67	2.70	2.73	2.76	2.79	2.82	2.85	2.88	2.91	2.94	2.97
38	2.47	2.50	2.53	2.56	2.59	2.62	2.65	2.68	2.71	2.74	2.77	2.81	2.84	2.87	2.90	2.93	2.96	2.99	3.02	3.05
39	2.53	2.56	2.59	2.63	2.66	2.69	2.72	2.75	2.78	2.82	2.85	2.88	2.91	2.94	2.97	3.01	3.04	3.07	3.10	3.13
40	2.60	2.63	2.66	2.69	2.73	2.76	2.79	2.82	2.86	2.89	2.92	2.95	2.98	3.02	3.05	3.08	3.11	3.15	3.18	3.21
41	2.66	2.69	2.73	2.76	2.79	2.83	2.86	2.89	2.93	2.96	2.99	3.03	3.06	3.09	3.13	3.16	3.19	3.23	3.26	3.29
42	2.72	2.76	2.79	2.83	2.86	2.89	2.93	2.96	3.00	3.03	3.06	3.10	3.13	3.17	3.20	3.24	3.27	3.30	3.34	3.37
43	2.79	2.82	2.86	2.89	2.93	2.96	3.00	3.03	3.07	3.10	3.14	3.17	3.21	3.24	3.28	3.31	3.35	3.38	3.42	3.45
44	2.85	2.89	2.92	2.96	3.00	3.03	3.07	3.10	3.14	3.17	3.21	3.25	3.28	3.32	3.35	3.39	3.42	3.46	3.49	3.53
45	2.92	2.95	2.99	3.03	3.06	3.10	3.14	3.17	3.21	3.25	3.28	3.32	3.35	3.39	3.43	3.46	3.50	3.54	3.57	3.61
46	2.98	3.02	3.06	3.09	3.13	3.17	3.21	3.24	3.28	3.32	3.35	3.39	3.43	3.47	3.50	3.54	3.58	3.62	3.65	3.69
47	3.05	3.08	3.12	3.16	3.20	3.24	3.27	3.31	3.35	3.39	3.43	3.46	3.50	3.54	3.58	3.62	3.66	3.69	3.73	3.77
48	3.11	3.15	3.19	3.23	3.27	3.30	3.34	3.38	3.42	3.46	3.50	3.54	3.58	3.62	3.65	3.69	3.73	3.77	3.81	3.85
49	3.17	3.21	3.25	3.29	3.33	3.37	3.41	3.45	3.49	3.53	3.57	3.61	3.65	3.69	3.73	3.77	3.81	3.85	3.89	3.93
50	3.24	3.28	3.32	3.36	3.40	3.44	3.48	3.52	3.56	3.60	3.64	3.68	3.72	3.76	3.81	3.85	3.89	3.93	3.97	4.01

Temperature	Barometer reading, millibars, inches or millimeters of mercury																			
	500	505	510	515	520	525	530	535	540	545	550	555	560	565	570	575	580	585	590	595
° C																				
0	0.00	0.00	0.00	0.00	0.00	0.00	0.00	0.00	0.00	0.00	0.00	0.00	0.00	0.00	0.00	0.00	0.00	0.00	0.00	0.00
5	.41	.41	.42	.42	.42	.43	.43	.44	.44	.44	.45	.45	.46	.46	.47	.47	.47	.48	.48	.49
10	.82	.82	.83	.84	.85	.86	.86	.87	.88	.89	.90	.91	.91	.92	.93	.94	.95	.95	.96	.97
11	.90	.91	.91	.92	.93	.94	.95	.96	.97	.98	.99	1.00	1.00	1.01	1.02	1.03	1.04	1.05	1.06	1.07
12	.98	.99	1.00	1.01	1.02	1.03	1.04	1.05	1.06	1.07	1.08	1.09	1.10	1.11	1.12	1.12	1.13	1.14	1.15	1.16
13	1.06	1.07	1.08	1.09	1.10	1.11	1.12	1.13	1.14	1.15	1.17	1.18	1.19	1.20	1.21	1.22	1.23	1.24	1.25	1.26
14	1.14	1.15	1.16	1.18	1.19	1.20	1.21	1.22	1.23	1.24	1.25	1.27	1.28	1.29	1.30	1.31	1.32	1.33	1.35	1.36
15	1.22	1.23	1.25	1.26	1.27	1.28	1.30	1.31	1.32	1.33	1.34	1.36	1.37	1.38	1.39	1.41	1.42	1.43	1.44	1.45
16	1.30	1.32	1.33	1.34	1.36	1.37	1.38	1.39	1.41	1.42	1.43	1.45	1.46	1.47	1.49	1.50	1.51	1.52	1.54	1.55
17	1.37	1.40	1.41	1.43	1.44	1.45	1.47	1.48	1.50	1.51	1.52	1.54	1.55	1.56	1.58	1.59	1.61	1.62	1.63	1.65
18	1.48	1.48	1.50	1.51	1.52	1.54	1.55	1.57	1.58	1.60	1.61	1.63	1.64	1.66	1.67	1.69	1.70	1.71	1.73	1.74
19	1.55	1.56	1.58	1.59	1.61	1.62	1.64	1.66	1.67	1.69	1.70	1.72	1.73	1.75	1.76	1.78	1.79	1.81	1.83	1.84
20	1.63	1.64	1.66	1.68	1.69	1.71	1.73	1.74	1.76	1.77	1.79	1.81	1.82	1.84	1.86	1.87	1.89	1.90	1.92	1.94
21	1.71	1.73	1.74	1.76	1.78	1.79	1.81	1.83	1.85	1.86	1.88	1.90	1.91	1.93	1.95	1.97	1.98	2.00	2.02	2.03
22	1.79	1.81	1.83	1.84	1.86	1.88	1.90	1.92	1.93	1.95	1.97	1.99	2.01	2.02	2.04	2.06	2.08	2.09	2.11	2.13
23	1.87	1.89	1.91	1.93	1.94	1.96	1.98	2.00	2.02	2.04	2.06	2.08	2.10	2.11	2.13	2.15	2.17	2.19	2.21	2.23
24	1.95	1.97	1.99	2.01	2.03	2.05	2.07	2.09	2.11	2.13	2.15	2.17	2.19	2.21	2.23	2.25	2.26	2.28	2.30	2.32
25	2.03	2.05	2.07	2.09	2.11	2.13	2.16	2.18	2.20	2.22	2.24	2.26	2.28	2.						

TABLE 6. *Temperature corrections for Fortin barometer with brass scales—Continued*

All corrections are to be subtracted from the reading.

Temperature ° C	Barometer reading, millibars, inches or millimeters of mercury																			
	500	505	510	515	520	525	530	535	540	545	550	555	560	565	570	575	580	585	590	595
31	2.52	2.54	2.57	2.59	2.62	2.64	2.67	2.69	2.72	2.75	2.77	2.80	2.82	2.85	2.87	2.90	2.92	2.95	2.97	3.00
32	2.60	2.63	2.65	2.68	2.70	2.73	2.76	2.78	2.81	2.83	2.86	2.89	2.91	2.94	2.96	2.99	3.02	3.04	3.07	3.09
33	2.68	2.71	2.73	2.76	2.79	2.81	2.84	2.87	2.89	2.92	2.95	2.97	3.00	3.03	3.06	3.08	3.11	3.14	3.16	3.19
34	2.76	2.79	2.82	2.84	2.87	2.90	2.93	2.95	2.98	3.01	3.04	3.06	3.09	3.12	3.15	3.17	3.20	3.23	3.26	3.29
35	2.84	2.87	2.90	2.93	2.96	2.98	3.01	3.04	3.07	3.10	3.13	3.15	3.18	3.21	3.24	3.27	3.30	3.32	3.35	3.38
36	2.92	2.95	2.98	3.01	3.04	3.07	3.10	3.13	3.16	3.19	3.21	3.24	3.27	3.30	3.33	3.36	3.39	3.42	3.45	3.48
37	3.00	3.03	3.06	3.09	3.12	3.15	3.18	3.21	3.24	3.27	3.30	3.33	3.36	3.39	3.42	3.45	3.48	3.51	3.54	3.57
38	3.08	3.11	3.14	3.18	3.21	3.24	3.27	3.30	3.33	3.36	3.39	3.42	3.45	3.48	3.51	3.55	3.58	3.61	3.64	3.67
39	3.16	3.20	3.23	3.26	3.29	3.32	3.35	3.39	3.42	3.45	3.48	3.51	3.54	3.58	3.61	3.64	3.67	3.70	3.73	3.76
40	3.24	3.28	3.31	3.34	3.37	3.41	3.44	3.47	3.50	3.54	3.57	3.60	3.63	3.67	3.70	3.73	3.76	3.80	3.83	3.86
41	3.32	3.36	3.39	3.42	3.46	3.49	3.52	3.56	3.59	3.62	3.66	3.69	3.72	3.76	3.79	3.82	3.86	3.89	3.92	3.96
42	3.41	3.44	3.47	3.51	3.54	3.58	3.61	3.64	3.68	3.71	3.75	3.78	3.81	3.85	3.88	3.92	3.95	3.98	4.02	4.05
43	3.49	3.52	3.56	3.59	3.63	3.66	3.70	3.73	3.76	3.80	3.83	3.87	3.90	3.94	3.97	4.01	4.04	4.08	4.11	4.15
44	3.57	3.60	3.64	3.67	3.71	3.74	3.78	3.82	3.85	3.89	3.92	3.96	3.99	4.03	4.07	4.10	4.14	4.17	4.21	4.24
45	3.65	3.68	3.72	3.76	3.79	3.83	3.87	3.90	3.94	3.97	4.01	4.05	4.08	4.12	4.16	4.19	4.23	4.27	4.30	4.34
46	3.73	3.76	3.80	3.84	3.88	3.91	3.95	3.99	4.03	4.06	4.10	4.14	4.17	4.21	4.25	4.29	4.32	4.36	4.40	4.44
47	3.81	3.85	3.88	3.92	3.96	4.00	4.04	4.07	4.11	4.15	4.19	4.23	4.26	4.30	4.34	4.38	4.42	4.45	4.49	4.53
48	3.89	3.93	3.97	4.00	4.04	4.08	4.12	4.16	4.20	4.24	4.28	4.32	4.35	4.39	4.43	4.47	4.51	4.55	4.59	4.63
49	3.97	4.01	4.05	4.09	4.13	4.17	4.21	4.25	4.29	4.33	4.36	4.40	4.44	4.48	4.52	4.56	4.60	4.64	4.68	4.72
50	4.05	4.09	4.13	4.17	4.21	4.25	4.29	4.33	4.37	4.41	4.45	4.49	4.53	4.57	4.61	4.66	4.70	4.74	4.78	4.82

Temperature ° C	Barometer reading, millibars, inches or millimeters of mercury																			
	600	605	610	615	620	625	630	635	640	645	650	655	660	665	670	675	680	685	690	695
0	0.00	0.00	0.00	0.00	0.00	0.00	0.00	0.00	0.00	0.00	0.00	0.00	0.00	0.00	0.00	0.00	0.00	0.00	0.00	0.00
5	.49	.49	.50	.50	.51	.51	.51	.52	.52	.53	.53	.53	.54	.54	.55	.55	.56	.56	.56	.57
10	.98	.99	.99	1.00	1.01	1.02	1.03	1.04	1.04	1.05	1.06	1.07	1.08	1.08	1.09	1.10	1.11	1.12	1.13	1.13
11	1.08	1.09	1.09	1.10	1.11	1.12	1.13	1.14	1.15	1.16	1.17	1.17	1.18	1.19	1.20	1.21	1.22	1.23	1.24	1.25
12	1.17	1.18	1.19	1.20	1.21	1.22	1.23	1.24	1.25	1.26	1.27	1.28	1.29	1.30	1.31	1.32	1.33	1.34	1.35	1.36
13	1.27	1.28	1.29	1.30	1.31	1.32	1.34	1.35	1.36	1.37	1.38	1.39	1.40	1.41	1.42	1.43	1.44	1.45	1.46	1.47
14	1.37	1.38	1.39	1.40	1.41	1.43	1.44	1.45	1.46	1.47	1.48	1.49	1.51	1.52	1.53	1.54	1.55	1.56	1.57	1.59
15	1.47	1.48	1.49	1.50	1.52	1.53	1.54	1.55	1.56	1.58	1.59	1.60	1.61	1.63	1.64	1.65	1.66	1.67	1.69	1.70
16	1.56	1.58	1.59	1.60	1.62	1.63	1.64	1.66	1.67	1.68	1.69	1.71	1.72	1.73	1.75	1.76	1.77	1.79	1.80	1.81
17	1.66	1.68	1.69	1.70	1.72	1.73	1.74	1.76	1.77	1.79	1.80	1.81	1.83	1.84	1.86	1.87	1.88	1.90	1.91	1.92
18	1.76	1.77	1.79	1.80	1.82	1.83	1.85	1.86	1.88	1.89	1.91	1.92	1.93	1.95	1.96	1.98	1.99	2.01	2.02	2.04
19	1.86	1.87	1.89	1.90	1.92	1.93	1.95	1.96	1.98	2.00	2.01	2.03	2.04	2.06	2.07	2.09	2.10	2.12	2.13	2.15
20	1.95	1.97	1.99	2.00	2.02	2.04	2.05	2.07	2.08	2.10	2.12	2.13	2.15	2.17	2.18	2.20	2.21	2.23	2.25	2.26
21	2.05	2.07	2.09	2.10	2.12	2.14	2.15	2.17	2.19	2.20	2.22	2.24	2.26	2.27	2.29	2.31	2.32	2.34	2.36	2.38
22	2.15	2.17	2.18	2.20	2.22	2.24	2.26	2.27	2.29	2.31	2.33	2.35	2.36	2.38	2.40	2.42	2.43	2.45	2.47	2.49
23	2.25	2.26	2.28	2.30	2.32	2.34	2.36	2.38	2.40	2.41	2.43	2.45	2.47	2.49	2.51	2.53	2.54	2.56	2.58	2.60
24	2.34	2.36	2.38	2.40	2.42	2.44	2.46	2.48	2.50	2.52	2.54	2.56	2.58	2.60	2.62	2.64	2.66	2.67	2.69	2.71
25	2.44	2.46	2.48	2.50	2.52	2.54	2.56	2.58	2.60	2.62	2.64	2.66	2.68	2.70	2.72	2.74	2.77	2.79	2.81	2.83
26	2.54	2.56	2.58	2.60	2.62	2.64	2.66	2.69	2.71	2.73	2.75	2.77	2.79	2.81	2.83	2.85	2.88	2.90	2.92	2.94
27	2.63	2.66	2.68	2.70	2.72	2.74	2.77	2.79	2.81	2.83	2.85	2.88	2.90	2.92	2.94	2.96	2.99	3.01	3.03	3.05
28	2.73	2.75	2.78	2.80	2.82	2.85	2.87	2.89	2.91	2.94	2.96	2.98	3.00	3.03	3.05	3.07	3.10	3.12	3.14	3.16
29	2.83	2.85	2.88	2.90	2.92	2.95	2.97	2.99	3.02	3.04	3.06	3.09	3.11	3.13	3.16	3.18	3.21	3.23	3.25	3.28
30	2.93	2.95	2.97	3.00	3.02	3.05	3.07	3.10	3.12	3.14	3.17	3.19	3.22	3.24	3.27	3.29	3.32	3.34	3.36	3.39
31	3.02	3.05	3.07	3.10	3.12	3.15	3.17	3.20	3.22	3.25	3.27	3.30	3.32	3.35	3.37	3.40	3.43	3.45	3.48	3.50
32	3.12	3.15	3.17	3.20	3.22	3.25	3.28	3.30	3.33	3.35	3.38	3.41	3.43	3.46	3.48	3.51	3.54	3.56	3.59	3.61
33	3.22	3.24	3.27	3.30	3.32	3.35	3.38	3.40	3.43	3.46	3.48	3.51	3.54	3.56	3.59	3.62	3.64	3.67	3.70	3.73
34	3.31	3.34	3.37	3.40	3.42	3.45	3.48	3.51	3.53	3.56	3.59	3.62	3.64	3.67	3.70	3.73	3.75	3.78	3.81	3.84
35	3.41	3.44	3.47	3.49	3.52	3.55	3.58	3.61	3.64	3.67	3.69	3.72	3.75	3.78	3.81	3.84	3.86	3.89	3.92	3.95
36	3.51	3.54	3.56	3.59	3.62	3.65	3.68	3.71	3.74	3.77	3.80	3.83	3.86	3.89	3.92	3.94	3.97	4.00	4.03	4.06
37	3.60	3.63	3.66	3.69	3.72	3.75	3.78	3.81	3.84	3.87	3.90	3.93	3.96	3.99	4.02	4.05	4.08	4.11	4.14	4.17
38	3.70	3.73	3.76	3.79	3.82	3.85	3.88	3.92	3.95	3.98	4.01	4.04	4.07	4.10	4.13	4.16	4.19	4.22	4.25	4.29
39	3.80	3.83	3.86	3.89	3.92	3.95	3.99	4.02	4.05	4.08	4.11	4.14	4.18	4.21	4.24	4.27	4.30	4.33	4.37	4.40
40	3.89	3.93	3.96	3.99	4.02	4.06	4.09	4.12	4.15	4.19	4.22	4.25	4.28	4.32	4.35	4.38	4.41	4.44	4.48	4.51
41	3.99	4.02	4.06	4.09	4.12	4.16	4.19	4.22	4.26	4.29	4.32	4.36	4.39	4.42	4.46	4.49	4.52	4.56	4.59	4.62
42	4.09	4.12	4.15	4.19	4.22	4.26	4.29	4.32	4.36	4.39	4.43	4.46	4.50	4.53	4.56	4.60	4.63	4.67	4.70	4.73
43	4.18	4.22	4.25	4.29	4.32	4.36	4.39	4.43	4.46	4.50	4.53	4.57	4.60	4.64	4.67	4.71	4.74	4.78	4.81	4.85
44	4.28	4.32	4.35	4.39	4.42	4.46	4.49	4.53	4.56	4.60	4.64	4.67	4.71	4.74	4.78	4.81	4.85	4.89	4.92	4.96
45	4.38	4.41	4.45	4.49	4.52	4.56	4.59	4.63	4.67	4.70	4.74	4.78	4.81	4.85	4.89	4.92	4.96	5.00	5.03	5.07
46	4.47	4.51	4.55	4.58	4.62	4.66	4.70	4.73	4.77	4.81	4.85	4.88	4.92	4.96	4.99	5.03	5.07	5.11	5.14	5.18
47	4.57	4.61	4.64	4.68	4.72	4.76	4.80	4.84	4.87	4.91	4.95	4.99	5.03	5.06	5.10	5.14	5.18	5.22	5.25	5.29
48	4.67	4.70	4.74	4.78	4.82	4.86	4.90	4.94	4.98	5.02	5.05	5.09	5.13	5.17	5.21	5.25	5.29	5.33	5.36	5.40
49	4.76	4.80	4.84	4.88	4.92	4.96	5.00	5.04	5.08	5.12	5.16	5.20	5.24	5.28						

TABLE 6. *Temperature corrections for Fortin barometer with brass scales—Continued*

All corrections are to be subtracted from the reading.

Temperature	Barometer reading, millibars or millimeters of mercury																			
	700	705	710	715	720	725	730	735	740	745	750	755	760	765	770	775	780	785	790	795
° C																				
0	0.00	0.00	0.00	0.00	0.00	0.00	0.00	0.00	0.00	0.00	0.00	0.00	0.00	0.00	0.00	0.00	0.00	0.00	0.00	0.00
5	.57	.58	.58	.58	.59	.59	.60	.60	.60	.61	.62	.62	.62	.62	.63	.63	.64	.64	.64	.65
10	1.14	1.15	1.16	1.17	1.17	1.18	1.19	1.20	1.21	1.22	1.22	1.23	1.24	1.25	1.26	1.26	1.27	1.28	1.29	1.30
11	1.26	1.26	1.27	1.28	1.29	1.30	1.31	1.32	1.33	1.34	1.35	1.35	1.36	1.37	1.38	1.39	1.40	1.41	1.42	1.43
12	1.37	1.38	1.39	1.40	1.41	1.42	1.43	1.44	1.45	1.46	1.47	1.48	1.49	1.50	1.51	1.52	1.53	1.54	1.55	1.56
13	1.48	1.49	1.50	1.52	1.53	1.54	1.55	1.56	1.57	1.58	1.59	1.60	1.61	1.62	1.63	1.64	1.65	1.66	1.67	1.68
14	1.60	1.61	1.62	1.63	1.64	1.65	1.67	1.68	1.69	1.70	1.71	1.72	1.73	1.75	1.76	1.77	1.78	1.79	1.80	1.81
15	1.71	1.72	1.74	1.75	1.76	1.77	1.78	1.80	1.81	1.82	1.83	1.85	1.86	1.87	1.88	1.89	1.91	1.92	1.93	1.94
16	1.82	1.84	1.85	1.86	1.88	1.89	1.90	1.92	1.93	1.94	1.96	1.97	1.98	1.99	2.01	2.02	2.03	2.05	2.06	2.07
17	1.94	1.95	1.97	1.98	1.99	2.01	2.02	2.04	2.05	2.06	2.08	2.09	2.10	2.12	2.13	2.15	2.16	2.17	2.19	2.20
18	2.05	2.07	2.08	2.10	2.11	2.13	2.14	2.15	2.17	2.18	2.20	2.21	2.23	2.24	2.26	2.27	2.29	2.30	2.32	2.33
19	2.17	2.18	2.20	2.21	2.23	2.24	2.26	2.27	2.29	2.30	2.32	2.34	2.35	2.37	2.38	2.40	2.41	2.43	2.44	2.46
20	2.28	2.30	2.31	2.33	2.34	2.36	2.38	2.39	2.41	2.43	2.44	2.46	2.47	2.49	2.51	2.52	2.54	2.56	2.57	2.59
21	2.39	2.41	2.43	2.44	2.46	2.48	2.50	2.51	2.53	2.55	2.56	2.58	2.60	2.62	2.63	2.65	2.67	2.68	2.70	2.72
22	2.51	2.52	2.54	2.56	2.58	2.60	2.61	2.63	2.65	2.67	2.69	2.70	2.72	2.74	2.76	2.77	2.79	2.81	2.83	2.85
23	2.62	2.64	2.66	2.68	2.69	2.71	2.73	2.75	2.77	2.79	2.81	2.83	2.84	2.86	2.88	2.90	2.92	2.94	2.96	2.98
24	2.73	2.75	2.77	2.79	2.81	2.83	2.85	2.87	2.89	2.91	2.93	2.95	2.97	2.99	3.01	3.03	3.05	3.07	3.08	3.10
25	2.85	2.87	2.89	2.91	2.93	2.95	2.97	2.99	3.01	3.03	3.05	3.07	3.09	3.11	3.13	3.15	3.17	3.19	3.21	3.23
26	2.96	2.98	3.00	3.02	3.04	3.07	3.09	3.11	3.13	3.15	3.17	3.19	3.21	3.23	3.26	3.28	3.30	3.32	3.34	3.36
27	3.07	3.10	3.12	3.14	3.16	3.18	3.20	3.23	3.25	3.27	3.29	3.31	3.34	3.36	3.38	3.40	3.42	3.45	3.47	3.49
28	3.19	3.21	3.23	3.25	3.28	3.30	3.32	3.35	3.37	3.39	3.41	3.44	3.46	3.48	3.51	3.53	3.55	3.57	3.60	3.62
29	3.30	3.32	3.35	3.37	3.39	3.42	3.44	3.46	3.49	3.51	3.54	3.56	3.58	3.61	3.63	3.65	3.68	3.70	3.72	3.75
30	3.41	3.44	3.46	3.49	3.51	3.53	3.56	3.58	3.61	3.63	3.66	3.68	3.71	3.73	3.75	3.78	3.80	3.83	3.85	3.88
31	3.53	3.55	3.58	3.60	3.63	3.65	3.68	3.70	3.73	3.75	3.78	3.80	3.83	3.85	3.88	3.90	3.93	3.95	3.98	4.00
32	3.64	3.66	3.69	3.72	3.74	3.77	3.79	3.82	3.85	3.87	3.90	3.92	3.95	3.98	4.00	4.03	4.05	4.08	4.11	4.13
33	3.75	3.78	3.81	3.83	3.86	3.89	3.91	3.94	3.97	3.99	4.02	4.05	4.07	4.10	4.13	4.15	4.18	4.21	4.23	4.26
34	3.87	3.89	3.92	3.95	3.98	4.00	4.03	4.06	4.09	4.11	4.14	4.17	4.20	4.22	4.25	4.28	4.31	4.33	4.36	4.39
35	3.98	4.01	4.03	4.06	4.09	4.12	4.15	4.18	4.21	4.23	4.26	4.29	4.32	4.35	4.38	4.40	4.43	4.46	4.49	4.52
36	4.09	4.12	4.15	4.18	4.21	4.24	4.27	4.30	4.32	4.35	4.38	4.41	4.44	4.47	4.50	4.53	4.56	4.59	4.62	4.65
37	4.20	4.23	4.26	4.29	4.32	4.35	4.38	4.41	4.44	4.47	4.50	4.53	4.56	4.59	4.62	4.65	4.68	4.71	4.74	4.77
38	4.32	4.35	4.38	4.41	4.44	4.47	4.50	4.53	4.56	4.59	4.62	4.66	4.69	4.72	4.75	4.78	4.81	4.84	4.87	4.90
39	4.43	4.46	4.49	4.52	4.56	4.59	4.62	4.65	4.68	4.71	4.75	4.78	4.81	4.84	4.87	4.90	4.94	4.97	5.00	5.03
40	4.54	4.57	4.61	4.64	4.67	4.70	4.74	4.77	4.80	4.83	4.87	4.90	4.93	4.96	5.00	5.03	5.06	5.09	5.13	5.16
41	4.65	4.69	4.72	4.75	4.79	4.82	4.85	4.89	4.92	4.95	4.99	5.02	5.05	5.09	5.12	5.15	5.19	5.22	5.25	5.29
42	4.77	4.80	4.84	4.87	4.90	4.94	4.97	5.01	5.04	5.07	5.11	5.14	5.18	5.21	5.24	5.28	5.31	5.35	5.38	5.41
43	4.88	4.92	4.95	4.98	5.02	5.05	5.09	5.12	5.16	5.19	5.23	5.26	5.30	5.33	5.37	5.40	5.44	5.47	5.51	5.54
44	4.99	5.03	5.06	5.10	5.14	5.17	5.21	5.24	5.28	5.31	5.35	5.39	5.42	5.46	5.49	5.53	5.56	5.60	5.63	5.67
45	5.11	5.14	5.18	5.21	5.25	5.29	5.32	5.36	5.40	5.43	5.47	5.51	5.54	5.58	5.62	5.65	5.69	5.73	5.76	5.80
46	5.22	5.26	5.29	5.33	5.37	5.40	5.44	5.48	5.52	5.56	5.59	5.63	5.67	5.70	5.74	5.78	5.81	5.85	5.89	5.93
47	5.33	5.37	5.41	5.45	5.48	5.52	5.56	5.60	5.63	5.67	5.71	5.75	5.79	5.83	5.86	5.90	5.94	5.98	6.02	6.05
48	5.44	5.48	5.52	5.56	5.60	5.64	5.68	5.71	5.75	5.79	5.83	5.87	5.91	5.95	5.99	6.03	6.06	6.10	6.14	6.18
49	5.56	5.59	5.63	5.67	5.71	5.75	5.79	5.83	5.87	5.91	5.95	5.99	6.03	6.07	6.11	6.15	6.19	6.23	6.27	6.31
50	5.67	5.71	5.75	5.79	5.83	5.87	5.91	5.95	5.99	6.03	6.07	6.11	6.15	6.19	6.23	6.27	6.32	6.36	6.40	6.44

Temperature	Barometer reading, millibars, inches or millimeters of mercury																			
	800	805	810	815	820	825	830	835	840	845	850	855	860	865	870	875	880	885	890	895
° C																				
0	0.00	0.00	0.00	0.00	0.00	0.00	0.00	0.00	0.00	0.00	0.00	0.00	0.00	0.00	0.00	0.00	0.00	0.00	0.00	0.00
5	.65	.66	.66	.67	.67	.67	.68	.68	.69	.69	.69	.70	.70	.71	.71	.71	.72	.72	.73	.73
10	1.30	1.31	1.32	1.33	1.34	1.35	1.35	1.36	1.37	1.38	1.39	1.39	1.40	1.41	1.42	1.43	1.44	1.44	1.45	1.46
11	1.44	1.44	1.45	1.46	1.47	1.48	1.49	1.50	1.51	1.52	1.52	1.53	1.54	1.55	1.56	1.57	1.58	1.59	1.60	1.61
12	1.57	1.57	1.58	1.59	1.60	1.61	1.62	1.63	1.64	1.65	1.66	1.67	1.68	1.69	1.70	1.71	1.72	1.73	1.74	1.75
13	1.70	1.71	1.72	1.73	1.74	1.75	1.76	1.77	1.78	1.79	1.80	1.81	1.82	1.83	1.84	1.85	1.86	1.88	1.89	1.90
14	1.83	1.84	1.85	1.86	1.87	1.88	1.89	1.91	1.92	1.93	1.94	1.95	1.96	1.97	1.99	2.00	2.01	2.02	2.03	2.04
15	1.96	1.97	1.98	1.99	2.00	2.02	2.03	2.04	2.05	2.07	2.08	2.09	2.10	2.11	2.13	2.14	2.15	2.16	2.18	2.19
16	2.09	2.10	2.11	2.12	2.14	2.15	2.16	2.18	2.19	2.20	2.22	2.23	2.24	2.25	2.27	2.28	2.29	2.31	2.32	2.33
17	2.22	2.23	2.24	2.26	2.27	2.28	2.30	2.31	2.33	2.34	2.35	2.37	2.38	2.40	2.41	2.42	2.44	2.45	2.46	2.48
18	2.35	2.36	2.37	2.39	2.40	2.42	2.43	2.45	2.46	2.48	2.49	2.51	2.52	2.54	2.55	2.57	2.58	2.59	2.61	2.62
19	2.48	2.49	2.51	2.52	2.54	2.55	2.57	2.58	2.60	2.61	2.63	2.65	2.66	2.68	2.69	2.71	2.72	2.74	2.75	2.77
20	2.60	2.62	2.64	2.65	2.67	2.69	2.70	2.72	2.74	2.75	2.77	2.78	2.80	2.82	2.83	2.85	2.87	2.88	2.90	2.91
21	2.73	2.75	2.77	2.79	2.80	2.82	2.84	2.85	2.87	2.89	2.91	2.92	2.94	2.96	2.97	2.99	3.01	3.03	3.04	3.06
22	2.86	2.88	2.90	2.92	2.94	2.95	2.97	2.99	3.01	3.03	3.04	3.06	3.08	3.10	3.12	3.13	3.15	3.17	3.19	3.20
23	2.99	3.01	3.03	3.05	3.07	3.09	3.11	3.13	3.14	3.16	3.18	3.20	3.22	3.24	3.26	3.27	3.29	3.31	3.33	3.35
24	3.12	3.14	3.16	3.18	3.20	3.22	3.24	3.26	3.28	3.										

TABLE 6. *Temperature corrections for Fortin barometer with brass scales—Continued*

All corrections are to be subtracted from the reading.

Temperature ° C	Barometer reading, millibars, inches or millimeter of mercury																			
	800	805	810	815	820	825	830	835	840	845	850	855	860	865	870	875	880	885	890	895
31	4.03	4.05	4.08	4.11	4.13	4.16	4.18	4.21	4.23	4.26	4.28	4.31	4.33	4.36	4.38	4.41	4.43	4.46	4.48	4.51
32	4.16	4.18	4.21	4.24	4.26	4.29	4.31	4.34	4.37	4.39	4.42	4.44	4.47	4.50	4.52	4.55	4.57	4.60	4.63	4.65
33	4.29	4.31	4.34	4.37	4.40	4.42	4.45	4.48	4.50	4.53	4.56	4.58	4.61	4.64	4.66	4.69	4.72	4.74	4.77	4.80
34	4.42	4.44	4.47	4.50	4.53	4.56	4.58	4.61	4.64	4.67	4.69	4.72	4.75	4.78	4.80	4.83	4.86	4.89	4.91	4.94
35	4.55	4.57	4.60	4.63	4.66	4.69	4.72	4.75	4.77	4.80	4.83	4.86	4.89	4.92	4.94	4.97	5.00	5.03	5.06	5.09
36	4.68	4.70	4.73	4.76	4.79	4.82	4.85	4.88	4.91	4.94	4.97	5.00	5.03	5.06	5.08	5.11	5.14	5.17	5.20	5.23
37	4.80	4.83	4.86	4.89	4.92	4.95	4.98	5.01	5.04	5.07	5.10	5.13	5.16	5.19	5.22	5.25	5.28	5.31	5.34	5.37
38	4.93	4.96	4.99	5.03	5.06	5.09	5.12	5.15	5.18	5.21	5.24	5.27	5.30	5.33	5.36	5.40	5.43	5.46	5.49	5.52
39	5.06	5.09	5.13	5.16	5.19	5.22	5.25	5.28	5.32	5.35	5.38	5.41	5.44	5.47	5.51	5.54	5.57	5.60	5.63	5.66
40	5.19	5.22	5.26	5.29	5.32	5.35	5.39	5.42	5.45	5.48	5.52	5.55	5.58	5.61	5.65	5.68	5.71	5.74	5.78	5.81
41	5.32	5.35	5.39	5.42	5.45	5.49	5.52	5.55	5.59	5.62	5.65	5.69	5.72	5.75	5.79	5.82	5.85	5.89	5.92	5.95
42	5.45	5.48	5.52	5.55	5.58	5.62	5.65	5.69	5.72	5.76	5.79	5.82	5.86	5.89	5.93	5.96	6.00	6.03	6.06	6.10
43	5.58	5.61	5.65	5.68	5.72	5.75	5.79	5.82	5.86	5.89	5.93	5.96	6.00	6.03	6.07	6.10	6.14	6.17	6.20	6.24
44	5.71	5.74	5.78	5.81	5.85	5.88	5.92	5.96	5.99	6.03	6.06	6.10	6.13	6.17	6.21	6.24	6.28	6.31	6.35	6.38
45	5.83	5.87	5.91	5.94	5.98	6.02	6.05	6.09	6.13	6.16	6.20	6.24	6.27	6.31	6.35	6.38	6.42	6.45	6.49	6.53
46	5.96	6.00	6.04	6.08	6.11	6.15	6.19	6.22	6.26	6.30	6.34	6.37	6.41	6.45	6.49	6.52	6.56	6.60	6.63	6.67
47	6.09	6.13	6.17	6.21	6.24	6.28	6.32	6.36	6.40	6.43	6.47	6.51	6.55	6.59	6.62	6.66	6.70	6.74	6.78	6.82
48	6.22	6.26	6.30	6.34	6.38	6.41	6.45	6.49	6.53	6.57	6.61	6.65	6.69	6.73	6.76	6.80	6.84	6.88	6.92	6.96
49	6.35	6.39	6.43	6.47	6.51	6.55	6.59	6.63	6.67	6.71	6.75	6.79	6.82	6.86	6.90	6.94	6.98	7.02	7.06	7.10
50	6.48	6.52	6.56	6.60	6.64	6.68	6.72	6.76	6.80	6.84	6.88	6.92	6.96	7.00	7.04	7.08	7.12	7.17	7.21	7.25

Temperature ° C	Barometer reading, millibars, inches or millimeters of mercury																			
	900	905	910	915	920	925	930	935	940	945	950	955	960	965	970	975	980	985	990	995
0	0.00	0.00	0.00	0.00	0.00	0.00	0.00	0.00	0.00	0.00	0.00	0.00	0.00	0.00	0.00	0.00	0.00	0.00	0.00	0.00
5	0.73	0.74	0.74	0.75	0.75	0.75	0.76	0.76	0.77	0.77	0.78	0.78	0.78	0.79	0.80	0.80	0.80	0.81	0.81	0.81
10	1.47	1.48	1.48	1.49	1.50	1.51	1.52	1.53	1.53	1.54	1.55	1.56	1.57	1.57	1.59	1.59	1.60	1.61	1.61	1.62
11	1.61	1.62	1.63	1.64	1.65	1.66	1.67	1.68	1.69	1.70	1.70	1.71	1.72	1.73	1.74	1.75	1.76	1.77	1.78	1.78
12	1.76	1.77	1.78	1.79	1.80	1.81	1.82	1.83	1.84	1.85	1.86	1.87	1.88	1.89	1.90	1.91	1.92	1.93	1.94	1.95
13	1.91	1.92	1.93	1.94	1.95	1.96	1.97	1.98	1.99	2.00	2.01	2.02	2.03	2.05	2.06	2.07	2.08	2.09	2.10	2.11
14	2.05	2.07	2.08	2.09	2.10	2.11	2.12	2.13	2.14	2.16	2.17	2.18	2.19	2.20	2.21	2.22	2.24	2.25	2.26	2.27
15	2.20	2.21	2.22	2.24	2.25	2.26	2.27	2.29	2.30	2.31	2.32	2.33	2.35	2.36	2.37	2.38	2.40	2.41	2.42	2.43
16	2.35	2.36	2.37	2.39	2.40	2.41	2.42	2.44	2.45	2.46	2.48	2.49	2.50	2.52	2.53	2.54	2.55	2.57	2.58	2.59
17	2.49	2.51	2.52	2.53	2.55	2.56	2.58	2.59	2.60	2.62	2.63	2.64	2.66	2.67	2.69	2.70	2.71	2.73	2.74	2.76
18	2.64	2.65	2.67	2.68	2.70	2.71	2.73	2.74	2.76	2.77	2.79	2.80	2.81	2.83	2.84	2.86	2.87	2.89	2.90	2.92
19	2.78	2.80	2.82	2.83	2.85	2.86	2.88	2.89	2.91	2.92	2.94	2.95	2.97	2.99	3.00	3.02	3.03	3.05	3.06	3.08
20	2.93	2.95	2.96	2.98	3.00	3.01	3.03	3.04	3.06	3.08	3.09	3.11	3.13	3.14	3.16	3.17	3.19	3.21	3.22	3.24
21	3.08	3.09	3.11	3.13	3.14	3.16	3.18	3.20	3.21	3.23	3.25	3.26	3.28	3.30	3.32	3.33	3.35	3.37	3.38	3.40
22	3.22	3.24	3.26	3.28	3.29	3.31	3.33	3.35	3.37	3.38	3.40	3.42	3.44	3.46	3.47	3.49	3.51	3.53	3.54	3.56
23	3.37	3.39	3.41	3.42	3.44	3.46	3.48	3.50	3.52	3.54	3.56	3.57	3.59	3.61	3.63	3.65	3.67	3.69	3.71	3.72
24	3.51	3.53	3.55	3.57	3.59	3.61	3.63	3.65	3.67	3.69	3.71	3.73	3.75	3.77	3.79	3.81	3.83	3.85	3.87	3.89
25	3.66	3.68	3.70	3.72	3.74	3.76	3.78	3.80	3.82	3.84	3.86	3.88	3.90	3.92	3.94	3.96	3.99	4.01	4.03	4.05
26	3.81	3.83	3.85	3.87	3.89	3.91	3.93	3.95	3.97	4.00	4.02	4.04	4.06	4.08	4.10	4.12	4.14	4.16	4.19	4.21
27	3.95	3.97	4.00	4.02	4.04	4.06	4.08	4.10	4.13	4.15	4.17	4.19	4.21	4.24	4.26	4.28	4.30	4.32	4.35	4.37
28	4.10	4.12	4.14	4.17	4.19	4.21	4.23	4.26	4.28	4.30	4.32	4.35	4.37	4.39	4.42	4.44	4.46	4.48	4.51	4.53
29	4.24	4.27	4.29	4.31	4.34	4.36	4.38	4.41	4.43	4.45	4.48	4.50	4.53	4.55	4.57	4.60	4.62	4.64	4.67	4.69
30	4.39	4.41	4.44	4.46	4.49	4.51	4.53	4.56	4.58	4.61	4.63	4.66	4.68	4.70	4.73	4.75	4.78	4.80	4.83	4.85
31	4.53	4.56	4.58	4.61	4.63	4.66	4.68	4.71	4.73	4.76	4.79	4.81	4.84	4.86	4.89	4.91	4.94	4.96	4.99	5.01
32	4.68	4.70	4.73	4.76	4.78	4.81	4.83	4.86	4.89	4.91	4.94	4.96	4.99	5.02	5.04	5.07	5.09	5.12	5.15	5.17
33	4.82	4.85	4.88	4.90	4.93	4.96	4.98	5.01	5.04	5.07	5.09	5.12	5.15	5.17	5.20	5.23	5.25	5.28	5.31	5.33
34	4.97	5.00	5.02	5.05	5.08	5.11	5.13	5.16	5.19	5.22	5.25	5.27	5.30	5.33	5.36	5.38	5.41	5.44	5.47	5.49
35	5.11	5.14	5.17	5.20	5.23	5.26	5.29	5.31	5.34	5.37	5.40	5.43	5.46	5.48	5.51	5.54	5.57	5.60	5.63	5.65
36	5.26	5.29	5.32	5.35	5.38	5.41	5.44	5.46	5.49	5.52	5.55	5.58	5.61	5.64	5.67	5.70	5.73	5.76	5.79	5.81
37	5.40	5.43	5.46	5.49	5.52	5.55	5.59	5.62	5.65	5.68	5.71	5.74	5.77	5.80	5.83	5.86	5.89	5.92	5.95	5.98
38	5.55	5.58	5.61	5.64	5.67	5.70	5.73	5.77	5.80	5.83	5.86	5.89	5.92	5.95	5.98	6.01	6.04	6.07	6.10	6.14
39	5.69	5.73	5.76	5.79	5.82	5.85	5.88	5.92	5.95	5.98	6.01	6.04	6.07	6.11	6.14	6.17	6.20	6.23	6.26	6.30
40	5.84	5.87	5.90	5.94	5.97	6.00	6.03	6.07	6.10	6.13	6.16	6.20	6.23	6.26	6.29	6.33	6.36	6.39	6.42	6.46
41	5.98	6.02	6.05	6.08	6.12	6.15	6.18	6.22	6.25	6.28	6.32	6.35	6.38	6.42	6.45	6.48	6.52	6.55	6.58	6.62
42	6.13	6.16	6.20	6.23	6.27	6.30	6.33	6.37	6.40	6.44	6.47	6.50	6.54	6.57	6.61	6.64	6.67	6.71	6.74	6.78
43	6.27	6.31	6.34	6.38	6.41	6.45	6.48	6.52	6.55	6.59	6.62	6.66	6.69	6.73	6.76	6.80	6.83	6.87	6.90	6.94
44	6.42	6.45	6.49	6.53	6.56	6.60	6.63	6.67	6.70	6.74	6.78	6.81	6.85	6.88	6.92	6.95	6.99	7.03	7.06	7.10
45	6.56	6.60	6.64	6.67	6.71	6.75	6.78	6.82	6.86	6.89	6.93	6.97	7.00	7.04	7.07	7.11	7.15	7.18	7.22	7.26
46	6.71	6.75	6.78	6.82	6.86	6.90	6.93	6.97	7.01	7.04	7.08	7.12	7.16	7.19	7.23	7.27	7.31	7.34	7.38	7.42
47	6.85	6.89	6.93	6.97	7.01	7.04	7.08	7.12	7.16	7.20	7.23	7.27	7.31	7.35	7.39	7.42	7.46	7.50	7.54	7.58
48	7.00	7.04	7.08	7.11	7.15	7.19	7.23	7.27	7.31	7.35	7.39	7.43	7.46	7.50	7.54	7.58	7.62	7.66	7.70	7.74
49	7.14	7.18	7.22	7.26	7															

TABLE 6. *Temperature corrections for Fortin barometer with brass scales—Continued*

All corrections are to be subtracted from the reading.

Temperature	Barometer reading, millibars, inches or millimeters of mercury																			
	1,000	1,005	1,010	1,015	1,020	1,025	1,030	1,035	1,040	1,045	1,050	1,055	1,060	1,065	1,070	1,075	1,080	1,085	1,090	1,095
°C																				
0	0.00	0.00	0.00	0.00	0.00	0.00	0.00	0.00	0.00	0.00	0.00	0.00	0.00	0.00	0.00	0.00	0.00	0.00	0.00	0.00
5	.82	.82	.82	.83	.83	.84	.84	.84	.85	.85	.86	.86	.86	.87	.87	.88	.88	.89	.89	.89
10	1.63	1.64	1.65	1.66	1.66	1.67	1.68	1.69	1.70	1.70	1.71	1.72	1.73	1.74	1.75	1.75	1.76	1.77	1.78	1.79
11	1.79	1.80	1.81	1.82	1.83	1.84	1.85	1.86	1.87	1.87	1.88	1.89	1.90	1.91	1.92	1.93	1.94	1.95	1.96	1.96
12	1.96	1.97	1.98	1.99	2.00	2.01	2.02	2.03	2.03	2.04	2.05	2.06	2.07	2.08	2.09	2.10	2.11	2.12	2.13	2.14
13	2.12	2.13	2.14	2.15	2.16	2.17	2.18	2.19	2.20	2.21	2.23	2.24	2.25	2.26	2.27	2.28	2.29	2.30	2.31	2.32
14	2.28	2.29	2.30	2.32	2.33	2.34	2.35	2.36	2.37	2.38	2.40	2.41	2.42	2.43	2.44	2.45	2.46	2.48	2.49	2.50
15	2.44	2.46	2.47	2.48	2.49	2.51	2.52	2.53	2.54	2.55	2.57	2.58	2.59	2.60	2.62	2.63	2.64	2.65	2.66	2.68
16	2.61	2.62	2.63	2.65	2.66	2.67	2.69	2.70	2.71	2.72	2.74	2.75	2.76	2.78	2.79	2.80	2.82	2.83	2.84	2.85
17	2.77	2.78	2.80	2.81	2.82	2.84	2.85	2.87	2.88	2.89	2.91	2.92	2.94	2.95	2.96	2.98	2.99	3.00	3.02	3.03
18	2.93	2.95	2.96	2.98	2.99	3.00	3.02	3.03	3.05	3.06	3.08	3.09	3.11	3.12	3.14	3.15	3.17	3.18	3.20	3.21
19	3.69	3.11	3.12	3.14	3.16	3.17	3.19	3.20	3.22	3.23	3.25	3.26	3.28	3.30	3.31	3.33	3.34	3.36	3.37	3.39
20	3.26	3.27	3.29	3.31	3.32	3.34	3.35	3.37	3.39	3.40	3.42	3.44	3.45	3.47	3.48	3.50	3.52	3.53	3.55	3.57
21	3.42	3.44	3.45	3.47	3.49	3.50	3.52	3.54	3.56	3.57	3.59	3.61	3.62	3.64	3.66	3.67	3.69	3.71	3.73	3.74
22	3.58	3.60	3.62	3.63	3.65	3.67	3.69	3.71	3.72	3.74	3.76	3.78	3.80	3.81	3.83	3.85	3.87	3.88	3.90	3.92
23	3.74	3.76	3.78	3.80	3.82	3.84	3.85	3.87	3.89	3.91	3.93	3.95	3.97	3.99	4.00	4.02	4.04	4.06	4.08	4.10
24	3.90	3.92	3.94	3.96	3.98	4.00	4.02	4.04	4.06	4.08	4.10	4.12	4.14	4.16	4.18	4.20	4.22	4.24	4.26	4.28
25	4.07	4.09	4.11	4.13	4.15	4.17	4.19	4.21	4.23	4.25	4.27	4.29	4.31	4.33	4.35	4.37	4.39	4.41	4.43	4.45
26	4.23	4.25	4.27	4.29	4.31	4.33	4.36	4.38	4.40	4.42	4.44	4.46	4.48	4.50	4.52	4.55	4.57	4.59	4.61	4.63
27	4.39	4.41	4.43	4.46	4.48	4.50	4.52	4.54	4.57	4.59	4.61	4.63	4.65	4.68	4.70	4.72	4.74	4.76	4.79	4.81
28	4.55	4.57	4.60	4.62	4.64	4.67	4.69	4.71	4.73	4.76	4.78	4.80	4.83	4.85	4.87	4.89	4.92	4.94	4.96	4.98
29	4.71	4.74	4.76	4.78	4.81	4.83	4.86	4.88	4.90	4.93	4.95	4.97	5.00	5.02	5.04	5.07	5.09	5.11	5.14	5.16
30	4.88	4.90	4.92	4.95	4.97	5.00	5.02	5.05	5.07	5.09	5.12	5.14	5.17	5.19	5.22	5.24	5.27	5.29	5.31	5.34
31	5.04	5.06	5.09	5.11	5.14	5.16	5.19	5.21	5.24	5.26	5.29	5.31	5.34	5.36	5.39	5.41	5.44	5.47	5.49	5.52
32	5.20	5.22	5.25	5.28	5.30	5.33	5.35	5.38	5.41	5.43	5.46	5.48	5.51	5.54	5.56	5.59	5.61	5.64	5.67	5.69
33	5.36	5.39	5.41	5.44	5.47	5.49	5.52	5.55	5.57	5.60	5.63	5.65	5.68	5.71	5.74	5.76	5.79	5.82	5.84	5.87
34	5.52	5.55	5.58	5.60	5.63	5.66	5.69	5.71	5.74	5.77	5.80	5.83	5.85	5.88	5.91	5.94	5.96	5.99	6.02	6.05
35	5.68	5.71	5.74	5.77	5.80	5.82	5.85	5.88	5.91	5.94	5.97	6.00	6.02	6.05	6.08	6.11	6.14	6.17	6.19	6.22
36	5.84	5.87	5.90	5.93	5.96	5.99	6.02	6.05	6.08	6.11	6.14	6.17	6.19	6.22	6.25	6.28	6.31	6.34	6.37	6.40
37	6.01	6.04	6.07	6.10	6.13	6.16	6.19	6.22	6.25	6.28	6.31	6.34	6.37	6.40	6.43	6.46	6.49	6.52	6.55	6.58
38	6.17	6.20	6.23	6.26	6.29	6.32	6.35	6.38	6.41	6.44	6.47	6.51	6.54	6.57	6.60	6.63	6.66	6.69	6.72	6.75
39	6.33	6.36	6.39	6.42	6.45	6.49	6.52	6.55	6.58	6.61	6.64	6.68	6.71	6.74	6.77	6.80	6.83	6.87	6.90	6.93
40	6.49	6.52	6.55	6.59	6.62	6.65	6.68	6.72	6.75	6.78	6.81	6.85	6.88	6.91	6.94	6.98	7.01	7.04	7.07	7.11
41	6.65	6.68	6.72	6.75	6.78	6.82	6.85	6.88	6.92	6.95	6.98	7.02	7.05	7.08	7.12	7.15	7.18	7.22	7.25	7.28
42	6.81	6.84	6.88	6.91	6.95	6.98	7.02	7.05	7.08	7.12	7.15	7.19	7.22	7.25	7.29	7.32	7.36	7.39	7.42	7.46
43	6.97	7.01	7.04	7.08	7.11	7.15	7.18	7.22	7.25	7.29	7.32	7.36	7.39	7.42	7.46	7.49	7.53	7.56	7.60	7.63
44	7.13	7.17	7.20	7.24	7.28	7.31	7.35	7.38	7.42	7.45	7.49	7.52	7.56	7.60	7.63	7.67	7.70	7.74	7.77	7.81
45	7.29	7.33	7.37	7.40	7.44	7.48	7.51	7.55	7.59	7.62	7.66	7.69	7.73	7.77	7.80	7.84	7.88	7.91	7.95	7.99
46	7.45	7.49	7.53	7.57	7.60	7.64	7.68	7.71	7.75	7.79	7.83	7.86	7.90	7.94	7.98	8.01	8.05	8.09	8.12	8.16
47	7.61	7.65	7.69	7.73	7.77	7.81	7.84	7.88	7.92	7.96	8.00	8.03	8.07	8.11	8.15	8.19	8.22	8.26	8.30	8.34
48	7.78	7.81	7.85	7.89	7.93	7.97	8.01	8.05	8.09	8.13	8.16	8.20	8.24	8.28	8.32	8.36	8.40	8.44	8.48	8.51
49	7.94	7.98	8.02	8.05	8.09	8.13	8.17	8.21	8.25	8.29	8.33	8.37	8.41	8.45	8.49	8.53	8.57	8.61	8.65	8.69
50	8.10	8.14	8.18	8.22	8.26	8.30	8.34	8.38	8.42	8.46	8.50	8.54	8.58	8.62	8.66	8.70	8.74	8.78	8.83	8.87

Temperature	Barometer reading, millibars, inches or millimeters of mercury																			
	1,100	1,105	1,110	1,115	1,120	1,125	1,130	1,135	1,140	1,145	1,150	1,155	1,160	1,165	1,170	1,175	1,180	1,185	1,190	1,195
°C																				
0	0.00	0.00	0.00	0.00	0.00	0.00	0.00	0.00	0.00	0.00	0.00	0.00	0.00	0.00	0.00	0.00	0.00	0.00	0.00	0.00
5	.90	.90	.91	.91	.91	.92	.92	.93	.93	.93	.94	.94	.95	.95	.95	.96	.96	.97	.97	.98
10	1.79	1.80	1.81	1.82	1.83	1.84	1.84	1.85	1.86	1.87	1.88	1.88	1.89	1.90	1.91	1.92	1.92	1.93	1.94	1.95
11	1.97	1.98	1.99	2.00	2.01	2.02	2.03	2.04	2.04	2.05	2.06	2.07	2.08	2.09	2.10	2.11	2.12	2.13	2.13	2.14
12	2.15	2.16	2.17	2.18	2.19	2.20	2.21	2.22	2.23	2.24	2.25	2.26	2.27	2.28	2.29	2.30	2.31	2.32	2.33	2.34
13	2.33	2.34	2.35	2.36	2.37	2.38	2.39	2.41	2.42	2.43	2.44	2.45	2.46	2.47	2.48	2.49	2.50	2.51	2.52	2.53
14	2.51	2.52	2.53	2.54	2.56	2.57	2.58	2.59	2.60	2.61	2.62	2.64	2.65	2.66	2.67	2.68	2.69	2.70	2.72	2.73
15	2.69	2.70	2.71	2.73	2.74	2.75	2.76	2.77	2.79	2.80	2.81	2.82	2.84	2.85	2.86	2.87	2.88	2.90	2.91	2.92
16	2.87	2.88	2.89	2.91	2.92	2.93	2.95	2.96	2.97	2.98	3.00	3.01	3.02	3.04	3.05	3.06	3.08	3.09	3.10	3.12
17	3.05	3.06	3.07	3.09	3.10	3.12	3.13	3.14	3.16	3.17	3.18	3.20	3.21	3.23	3.24	3.25	3.27	3.28	3.30	3.31
18	3.22	3.24	3.25	3.27	3.18	3.30	3.31	3.33	3.34	3.36	3.37	3.39	3.40	3.42	3.43	3.44	3.46	3.47	3.49	3.50
19	3.40	3.42	3.43	3.45	3.47	3.48	3.50	3.51	3.53	3.54	3.56	3.57	3.59	3.60	3.62	3.64	3.65	3.67	3.68	3.70
20	3.58	3.60	3.61	3.63	3.65	3.66	3.68	3.70	3.71	3.73	3.74	3.76	3.78	3.79	3.81	3.83	3.84	3.86	3.87	3.89
21	3.76	3.78	3.79	3.81	3.83	3.85	3.86	3.88	3.90	3.91	3.93	3.95	3.97	3.98	4.00	4.02	4.03	4.05	4.07	4.08
22	3.94	3.96	3.97	3.99	4.01	4.03	4.05	4.06	4.08	4.10	4.12	4.14	4.15	4.17	4.19	4.21	4.22	4.24	4.26	4.28
23	4.12	4.14	4.15	4.17	4.19	4.21	4.23	4.25	4.27	4.29	4.30	4.32	4.34	4.36	4.38	4.40	4.42	4.43	4.45	4.47
24	4																			

TABLE 6. *Temperature corrections for Fortin barometer with brass scales—Continued*

All corrections are to be subtracted from the reading.

Temperature	Barometer reading, millibars, inches or millimeters of mercury																			
	1,100	1,105	1,110	1,115	1,120	1,125	1,130	1,135	1,140	1,145	1,150	1,155	1,160	1,165	1,170	1,175	1,180	1,185	1,190	1,195
36	6.43	6.46	6.49	6.52	6.55	6.57	6.60	6.63	6.66	6.69	6.72	6.75	6.78	6.81	6.84	6.87	6.90	6.93	6.95	6.98
37	6.61	6.64	6.67	6.70	6.73	6.76	6.79	6.82	6.85	6.88	6.91	6.94	6.97	7.00	7.03	7.06	7.09	7.12	7.15	7.18
38	6.78	6.81	6.84	6.88	6.91	6.94	6.97	7.00	7.03	7.06	7.09	7.12	7.15	7.18	7.21	7.25	7.28	7.31	7.34	7.37
39	6.96	6.99	7.02	7.06	7.09	7.12	7.15	7.18	7.21	7.25	7.28	7.31	7.34	7.37	7.40	7.44	7.47	7.50	7.53	7.56
40	7.14	7.17	7.20	7.24	7.27	7.30	7.33	7.36	7.40	7.43	7.46	7.49	7.53	7.56	7.59	7.62	7.66	7.69	7.72	7.75
41	7.31	7.35	7.38	7.41	7.45	7.48	7.51	7.55	7.58	7.61	7.65	7.68	7.71	7.75	7.78	7.81	7.85	7.88	7.91	7.95
42	7.49	7.53	7.56	7.59	7.63	7.66	7.70	7.73	7.76	7.80	7.83	7.87	7.90	7.93	7.97	8.00	8.04	8.07	8.10	8.14
43	7.67	7.70	7.74	7.77	7.81	7.84	7.88	7.91	7.95	7.98	8.02	8.05	8.09	8.12	8.16	8.19	8.23	8.26	8.30	8.33
44	7.85	7.88	7.92	7.95	8.99	8.02	8.06	8.10	8.13	8.17	8.20	8.24	8.27	8.31	8.35	8.38	8.42	8.45	8.49	8.52
45	8.02	8.06	8.10	8.13	8.17	8.20	8.24	8.28	8.31	8.35	8.39	8.42	8.46	8.50	8.53	8.57	8.61	8.64	8.68	8.72
46	8.20	8.24	8.27	8.31	8.35	8.39	8.42	8.46	8.50	8.53	8.57	8.61	8.65	8.68	8.72	8.76	8.80	8.83	8.87	8.91
47	8.38	8.41	8.45	8.49	8.53	8.57	8.60	8.64	8.68	8.72	8.76	8.79	8.83	8.87	8.91	8.95	8.99	9.02	9.06	9.10
48	8.55	8.59	8.63	8.67	8.71	8.75	8.79	8.83	8.86	8.90	8.94	8.98	9.02	9.06	9.10	9.14	9.17	9.21	9.25	9.29
49	8.73	8.77	8.81	8.85	8.89	8.93	8.97	9.01	9.05	9.09	9.13	9.17	9.21	9.25	9.29	9.32	9.36	9.40	9.44	9.48
50	8.91	8.95	8.99	9.03	9.07	9.11	9.15	9.19	9.23	9.27	9.31	9.35	9.39	9.43	9.47	9.51	9.55	9.59	9.63	9.68

TABLE 7. *Temperature Correction factor*

Numbers under scale material are values of expansion coefficient *s*, all of which must be multiplied by 10⁻²

$$F = \frac{(s-m)t}{1+mt}$$

Temperature		Factor <i>F</i> (minus sign omitted) in percent					
° C	° F	Aluminum 24.5	Brass 18.4	Stainless steel 17	Steel 11.5	Pyrex 3.0	Invar 0
0	32.0	0	0	0	0	0	0
2	35.6	0.0314	0.03267	0.0329	0.0340	0.0357	0.03635
4	39.2	.0629	.06531	.0659	.0681	.0715	.07267
6	42.8	.0943	.09793	.0988	.1021	.1072	.10896
8	46.4	.1257	.13053	.1316	.1360	.1428	.14523
10	50.0	.1570	.16310	.1645	.1700	.1785	.18147
12	53.6	.1883	.19565	.1973	.2039	.2141	.21768
14	57.2	.2197	.22818	.2301	.2378	.2497	.25387
16	60.8	.2510	.26068	.2629	.2717	.2853	.29004
18	64.4	.2822	.29316	.2955	.3055	.3208	.32617
20	68.0	.3135	.32562	.3284	.3394	.3563	.36228
22	71.6	.3447	.35805	.3611	.3732	.3918	.39837
24	75.2	.3759	.39046	.3938	.4069	.4273	.43442
26	78.8	.4071	.42284	.4265	.4407	.4627	.47046
28	82.4	.4382	.45520	.4591	.4744	.4981	.50646
30	86.0	.4693	.48754	.4917	.5081	.5335	.54244
32	89.6	.5004	.51986	.5243	.5418	.5689	.57840
34	93.2	.5315	.55215	.5569	.5755	.6042	.61432
36	96.8	.5626	.58442	.5894	.6091	.6395	.65022
38	100.4	.5936	.61666	.6219	.6427	.6748	.68610
40	104.0	.6247	.64888	.6544	.6763	.7100	.72195
42	107.6	.6557	.68108	.6869	.7098	.7453	.75778
44	111.2	.6866	.71325	.7194	.7434	.7805	.79357
46	114.8	.7176	.74541	.7518	.7769	.8157	.82934
48	118.4	.7485	.77744	.7842	.8104	.8508	.86509
50	112.0	.7794	.80964	.8166	.8438	.8859	.90081

TABLE 8. Gravity correction

$$C_g = \frac{(g-g_s)R_t}{g_s} = F_g R_t \text{ or } F_g R_s$$

Correction for height of mercury column R_s or R_t in any unit of pressure

Gravity	Correction factor F_g	100	200	300	400	500	600	700	800	900	1,000	1,100	1,200	1,300
cm/sec ²	%													
978.0	-0.27175	-0.272	-0.544	-0.815	-1.087	-1.359	-1.631	-1.902	-2.174	-2.446	-2.718	-2.989	-3.261	-3.533
.1	.26156	-.262	-.523	-.785	-1.046	-1.308	-1.569	-1.831	-2.092	-2.354	-2.616	-2.877	-3.139	-3.400
.2	.25136	-.251	-.503	-.754	-1.005	-1.257	-1.508	-1.760	-2.011	-2.262	-2.514	-2.765	-3.016	-3.268
.3	.24116	-.241	-.482	-.724	-0.965	-1.206	-1.447	-1.688	-1.929	-2.170	-2.412	-2.653	-2.894	-3.135
.4	.23097	-.231	-.462	-.693	-.924	-1.155	-1.386	-1.617	-1.848	-2.079	-2.310	-2.541	-2.772	-3.003
.5	.22077	-.221	-.442	-.662	-.883	-1.104	-1.325	-1.545	-1.766	-1.987	-2.208	-2.428	-2.649	-2.870
.6	.21057	-.211	-.421	-.632	-.842	-1.053	-1.263	-1.474	-1.685	-1.895	-2.106	-2.316	-2.527	-2.737
.7	.20037	-.200	-.401	-.601	-.801	-1.002	-1.202	-1.403	-1.603	-1.803	-2.004	-2.204	-2.404	-2.605
.8	.19018	-.190	-.380	-.571	-.761	-0.951	-1.141	-1.331	-1.521	-1.712	-1.902	-2.092	-2.282	-2.472
.9	.17998	-.180	-.360	-.540	-.720	-.900	-1.080	-1.260	-1.440	-1.620	-1.800	-1.980	-2.160	-2.340
979.0	.16978	-.170	-.340	-.509	-.679	-.849	-1.019	-1.188	-1.358	-1.528	-1.698	-1.868	-2.037	-2.207
.1	.15959	-.160	-.319	-.479	-.638	-.798	-0.958	-1.117	-1.277	-1.436	-1.596	-1.755	-1.915	-2.075
.2	.14939	-.149	-.299	-.448	-.598	-.747	-.896	-1.046	-1.195	-1.345	-1.494	-1.643	-1.793	-1.942
.3	.13919	-.139	-.278	-.418	-.557	-.696	-.835	-0.974	-1.114	-1.253	-1.392	-1.531	-1.670	-1.809
.4	.12899	-.129	-.258	-.387	-.516	-.645	-.774	-.903	-1.032	-1.161	-1.290	-1.419	-1.548	-1.677
.5	.11880	-.119	-.238	-.356	-.475	-.594	-.713	-.832	-0.950	-1.069	-1.188	-1.307	-1.426	-1.544
.6	.10860	-.109	-.217	-.326	-.434	-.543	-.652	-.760	-.869	-0.977	-1.086	-1.195	-1.303	-1.412
.7	.09840	-.098	-.197	-.295	-.394	-.492	-.590	-.689	-.787	-.886	-0.984	-1.082	-1.181	-1.279
.8	.08821	-.088	-.176	-.265	-.353	-.441	-.529	-.617	-.706	-.794	-.882	-0.970	-1.059	-1.147
.9	.07801	-.078	-.156	-.234	-.312	-.390	-.468	-.546	-.624	-.702	-.780	-.858	-0.936	-1.014
980.0	.06781	-.068	-.136	-.203	-.271	-.339	-.407	-.475	-.542	-.610	-.678	-.746	-.814	-.882
.1	.05761	-.058	-.115	-.173	-.230	-.288	-.346	-.403	-.461	-.518	-.576	-.634	-.691	-.749
.2	.04742	-.047	-.095	-.142	-.190	-.237	-.285	-.332	-.379	-.427	-.474	-.522	-.569	-.616
.3	.03722	-.037	-.074	-.112	-.149	-.186	-.223	-.261	-.298	-.335	-.372	-.409	-.447	-.484
.4	.02702	-.027	-.054	-.081	-.108	-.135	-.162	-.189	-.216	-.243	-.270	-.297	-.324	-.351
.5	.01682	-.017	-.034	-.050	-.067	-.084	-.101	-.118	-.135	-.151	-.168	-.185	-.202	-.219
.6	.00663	-.007	-.013	-.020	-.027	-.033	-.040	-.046	-.053	-.060	-.066	-.073	-.080	-.086
.665	0	0	0	0	0	0	0	0	0	0	0	0	0	0
.7	+.00357	+.004	+.007	+.011	+.014	+.018	+.021	+.025	+.029	+.032	+.036	+.039	+.043	+.046
.8	.01377	+.014	+.028	+.041	+.055	+.069	+.083	+.096	+.110	+.124	+.138	+.151	+.165	+.179
.9	.02396	+.024	+.048	+.072	+.096	+.120	+.144	+.168	+.192	+.216	+.240	+.264	+.288	+.311
981.0	.03416	+.034	+.068	+.102	+.137	+.171	+.205	+.239	+.273	+.307	+.342	+.376	+.410	+.444
.1	.04436	+.044	+.089	+.133	+.177	+.222	+.266	+.311	+.355	+.399	+.444	+.488	+.532	+.577
.2	.05455	+.055	+.109	+.164	+.218	+.273	+.327	+.382	+.436	+.491	+.546	+.600	+.655	+.709
.3	.06475	+.065	+.130	+.194	+.259	+.324	+.389	+.453	+.518	+.583	+.648	+.712	+.777	+.842
.4	.07495	+.075	+.150	+.225	+.300	+.375	+.450	+.525	+.600	+.675	+.749	+.824	+.899	+.974
.5	.08515	+.085	+.170	+.255	+.341	+.426	+.511	+.596	+.681	+.766	+.851	+.937	+1.022	+1.107
.6	.09534	+.095	+.191	+.286	+.381	+.477	+.572	+.667	+.763	+.858	+.953	+1.049	+1.144	+1.239
.7	.10554	+.106	+.211	+.317	+.422	+.528	+.633	+.739	+.844	+.950	+1.055	+1.161	+1.266	+1.372
.8	.11574	+.116	+.231	+.347	+.463	+.579	+.694	+.810	+.926	+1.042	+1.157	+1.273	+1.389	+1.505
.9	.12593	+.126	+.252	+.378	+.504	+.630	+.756	+.882	+1.007	+1.133	+1.259	+1.385	+1.511	+1.637
982.0	.13613	+.136	+.272	+.408	+.545	+.681	+.817	+.953	+1.089	+1.225	+1.361	+1.497	+1.634	+1.770
.1	.14633	+.146	+.293	+.439	+.585	+.732	+.878	+1.024	+1.171	+1.317	+1.463	+1.610	+1.756	+1.902
.2	.15653	+.157	+.313	+.470	+.626	+.783	+.939	+1.096	+1.252	+1.409	+1.565	+1.722	+1.878	+2.035
.3	.16672	+.167	+.333	+.500	+.667	+.834	+1.000	+1.167	+1.334	+1.500	+1.667	+1.834	+2.001	+2.167
.4	.17692	+.177	+.354	+.531	+.708	+.885	+1.062	+1.238	+1.415	+1.592	+1.769	+1.946	+2.123	+2.300
.5	.18712	+.187	+.374	+.561	+.748	+.936	+1.123	+1.310	+1.497	+1.684	+1.871	+2.058	+2.245	+2.433
.6	.19732	+.197	+.395	+.592	+.789	+.987	+1.184	+1.381	+1.579	+1.776	+1.973	+2.171	+2.368	+2.565
.7	.20751	+.208	+.415	+.623	+.830	+1.038	+1.245	+1.453	+1.660	+1.868	+2.075	+2.283	+2.490	+2.698
.8	.21771	+.218	+.435	+.653	+.871	+1.089	+1.306	+1.524	+1.742	+1.959	+2.177	+2.395	+2.613	+2.830
.9	.22791	+.228	+.456	+.684	+.912	+1.140	+1.367	+1.595	+1.823	+2.051	+2.279	+2.507	+2.735	+2.963
983.0	.23810	+.238	+.476	+.714	+.952	+1.191	+1.429	+1.667	+1.905	+2.143	+2.381	+2.619	+2.857	+3.095
.1	.24830	+.248	+.497	+.745	+.993	+1.242	+1.490	+1.738	+1.986	+2.235	+2.483	+2.731	+2.980	+3.228
.2	.25850	+.258	+.517	+.775	+1.034	+1.292	+1.551	+1.809	+2.068	+2.326	+2.585	+2.843	+3.102	+3.360
.3	.26870	+.269	+.537	+.806	+1.075	+1.343	+1.612	+1.881	+2.150	+2.418	+2.687	+2.956	+3.224	+3.493
.4	.27889	+.279	+.558	+.837	+1.116	+1.394	+1.673	+1.952	+2.231	+2.510	+2.789	+3.068	+3.347	+3.626
.5	.28909	+.289	+.578	+.867	+1.156	+1.445	+1.735	+2.024	+2.313	+2.602	+2.891	+3.180	+3.469	+3.758

TABLE 9. Gravity corrections at various latitudes at sea level

$$\text{Correction} = \frac{g-g_s}{g_s} R_s = F_2 R_s \text{ or } F_1 R_s$$

Correction for height of mercury column R_s or R_1 in any unit of pressure measurement

Latitude	Gravity	Correction factor F_2	100	200	300	400	500	600	700	800	900	1,000	1,100	1,200	1,300
<i>deg</i>	<i>cm/sec²</i>	<i>%</i>													
0	978.036	-0.28808	-0.268	-0.536	-0.804	-1.072	-1.340	-1.608	-1.877	-2.145	-2.413	-2.681	-2.949	-3.217	-3.485
2	978.042	.26747	-.267	-.535	-.802	-1.070	-1.337	-1.605	-1.872	-2.140	-2.407	-2.675	-2.942	-3.210	-3.477
4	978.061	.26553	-.266	-.531	-.797	-1.062	-1.328	-1.593	-1.859	-2.124	-2.390	-2.655	-2.921	-3.186	-3.452
6	978.092	.26237	-.262	-.525	-.787	-1.049	-1.312	-1.574	-1.837	-2.099	-2.361	-2.624	-2.886	-3.148	-3.411
8	978.135	.25799	-.258	-.516	-.774	-1.032	-1.290	-1.548	-1.806	-2.064	-2.322	-2.580	-2.838	-3.096	-3.354
10	978.191	.25228	-.252	-.505	-.757	-1.009	-1.261	-1.514	-1.766	-2.018	-2.271	-2.523	-2.775	-3.027	-3.280
12	978.258	.24545	-.245	-.491	-.736	-0.982	-1.227	-1.473	-1.718	-1.964	-2.209	-2.454	-2.700	-2.945	-3.191
14	978.337	.23739	-.237	-.475	-.712	-.950	-1.187	-1.424	-1.662	-1.899	-2.137	-2.374	-2.611	-2.849	-3.086
16	978.427	.22821	-.238	-.456	-.685	-.913	-1.141	-1.369	-1.597	-1.826	-2.054	-2.282	-2.510	-2.739	-2.967
18	978.528	.21791	-.218	-.436	-.654	-.872	-1.090	-1.307	-1.525	-1.743	-1.961	-2.179	-2.397	-2.615	-2.833
20	978.638	.20670	-.207	-.413	-.620	-.827	-1.033	-1.240	-1.447	-1.654	-1.860	-2.067	-2.274	-2.480	-2.687
22	978.759	.19436	-.194	-.389	-.583	-.777	-0.972	-1.166	-1.361	-1.555	-1.749	-1.944	-2.138	-2.332	-2.527
24	978.888	.18120	-.181	-.362	-.544	-.725	-.906	-1.087	-1.268	-1.450	-1.631	-1.812	-1.993	-2.174	-2.356
26	979.026	.16713	-.167	-.334	-.501	-.669	-.836	-1.003	-1.170	-1.337	-1.504	-1.671	-1.838	-2.006	-2.173
28	979.172	.15224	-.152	-.304	-.457	-.609	-.761	-.913	-1.066	-1.218	-1.370	-1.522	-1.675	-1.827	-1.979
30	979.324	.13674	-.137	-.273	-.410	-.547	-.684	-.820	-.957	-1.094	-1.231	-1.367	-1.504	-1.641	-1.778
32	979.483	.12053	-.121	-.241	-.362	-.482	-.603	-.723	-.844	-.964	-1.085	-1.205	-1.326	-1.446	-1.567
34	979.648	.10371	-.104	-.207	-.311	-.415	-.519	-.622	-.726	-.830	-0.933	-1.037	-1.141	-1.244	-1.347
36	979.817	.08647	-.086	-.173	-.259	-.346	-.432	-.519	-.605	-.692	-.778	-.865	-.951	-1.038	-1.124
38	979.991	.06873	-.069	-.137	-.206	-.275	-.344	-.412	-.481	-.550	-.619	-.687	-.756	-.825	-.893
40	980.167	.05078	-.051	-.102	-.152	-.203	-.254	-.305	-.355	-.406	-.457	-.508	-.559	-.609	-.660
42	980.346	.03253	-.033	-.065	-.098	-.130	-.163	-.195	-.228	-.260	-.293	-.325	-.358	-.390	-.423
44	980.526	.01417	-.014	-.028	-.043	-.057	-.071	-.085	-.099	-.113	-.128	-.142	-.156	-.170	-.184
45	980.616	.00500	-.005	-.010	-.015	-.020	-.025	-.030	-.035	-.040	-.045	-.050	-.055	-.060	-.065
	980.665	0	0	0	0	0	0	0	0	0	0	0	0	0	0
46	980.706	+ .00418	+ .004	+ .008	+ .013	+ .017	+ .021	+ .025	+ .029	+ .033	+ .038	+ .042	+ .046	+ .050	+ .054
48	980.886	.02254	+ .023	+ .045	+ .068	+ .090	+ .113	+ .135	+ .158	+ .180	+ .203	+ .225	+ .248	+ .270	+ .293
50	981.065	.04079	+ .041	+ .082	+ .122	+ .163	+ .204	+ .245	+ .286	+ .326	+ .367	+ .408	+ .449	+ .489	+ .530
52	981.242	.05884	+ .059	+ .118	+ .177	+ .235	+ .294	+ .353	+ .412	+ .471	+ .530	+ .588	+ .647	+ .706	+ .765
54	981.416	.06658	+ .077	+ .153	+ .230	+ .306	+ .383	+ .459	+ .536	+ .613	+ .689	+ .766	+ .842	+ .919	+ .996
56	981.586	.09392	+ .094	+ .188	+ .282	+ .376	+ .470	+ .564	+ .657	+ .751	+ .845	+ .939	+ .1.033	+ .1.127	+ .1.221
58	981.751	.11074	+ .111	+ .221	+ .332	+ .443	+ .544	+ .644	+ .743	+ .842	+ .941	+ .1.039	+ .1.138	+ .1.237	+ .1.336
60	981.911	.12706	+ .127	+ .254	+ .381	+ .508	+ .635	+ .762	+ .889	+ .1.016	+ .1.144	+ .1.271	+ .1.398	+ .1.525	+ .1.652
62	982.064	.14266	+ .143	+ .285	+ .428	+ .571	+ .713	+ .856	+ .999	+ .1.141	+ .1.284	+ .1.427	+ .1.569	+ .1.712	+ .1.855
64	982.210	.15755	+ .158	+ .315	+ .473	+ .630	+ .788	+ .945	+ .1.103	+ .1.260	+ .1.418	+ .1.575	+ .1.733	+ .1.891	+ .2.048
66	982.349	.17172	+ .172	+ .343	+ .515	+ .687	+ .859	+ .1.030	+ .1.202	+ .1.374	+ .1.545	+ .1.717	+ .1.889	+ .2.061	+ .2.232
68	982.479	.18498	+ .185	+ .370	+ .555	+ .740	+ .925	+ .1.110	+ .1.295	+ .1.480	+ .1.665	+ .1.850	+ .2.035	+ .2.220	+ .2.405
70	982.601	.19742	+ .197	+ .395	+ .592	+ .790	+ .987	+ .1.185	+ .1.382	+ .1.579	+ .1.777	+ .1.974	+ .2.172	+ .2.369	+ .2.566
72	982.712	.20874	+ .209	+ .417	+ .626	+ .835	+ .1.044	+ .1.252	+ .1.461	+ .1.670	+ .1.879	+ .2.087	+ .2.296	+ .2.505	+ .2.714
74	982.813	.21904	+ .219	+ .438	+ .657	+ .876	+ .1.095	+ .1.314	+ .1.533	+ .1.752	+ .1.971	+ .2.190	+ .2.409	+ .2.628	+ .2.848
76	982.904	.22831	+ .228	+ .457	+ .685	+ .913	+ .1.142	+ .1.370	+ .1.598	+ .1.826	+ .2.055	+ .2.283	+ .2.511	+ .2.740	+ .2.968
78	982.983	.23637	+ .236	+ .473	+ .709	+ .945	+ .1.182	+ .1.418	+ .1.655	+ .1.891	+ .2.127	+ .2.364	+ .2.600	+ .2.836	+ .3.073
80	983.051	.24330	+ .243	+ .487	+ .730	+ .973	+ .1.217	+ .1.460	+ .1.703	+ .1.946	+ .2.190	+ .2.433	+ .2.676	+ .2.920	+ .3.163
82	983.107	.24901	+ .249	+ .498	+ .747	+ .996	+ .1.245	+ .1.494	+ .1.743	+ .1.992	+ .2.241	+ .2.490	+ .2.739	+ .2.988	+ .3.237
84	983.151	.25350	+ .254	+ .507	+ .761	+ .1.014	+ .1.263	+ .1.521	+ .1.775	+ .2.028	+ .2.282	+ .2.535	+ .2.789	+ .3.042	+ .3.296
86	983.183	.25676	+ .257	+ .514	+ .770	+ .1.027	+ .1.284	+ .1.541	+ .1.797	+ .2.054	+ .2.311	+ .2.568	+ .2.824	+ .3.081	+ .3.338
88	983.202	.25870	+ .259	+ .517	+ .776	+ .1.035	+ .1.294	+ .1.552	+ .1.811	+ .2.070	+ .2.328	+ .2.587	+ .2.846	+ .3.104	+ .3.363
90	983.208	.25931	+ .259	+ .519	+ .778	+ .1.037	+ .1.297	+ .1.556	+ .1.815	+ .2.074	+ .2.334	+ .2.593	+ .2.852	+ .3.112	+ .3.371

TABLE 10. Capillary depression of mercury column

Millimeters of mercury at 20°C and under standard gravity.

Bore of tube mm	Meniscus height in mm																			
	0.1	0.2	0.3	0.4	0.5	0.6	0.7	0.8	0.9	1.0	1.1	1.2	1.3	1.4	1.5	1.6	1.7	1.8	1.9	2.0
	Surface tension, 400 dynes/cm																			
8	0.054	0.108	0.162	0.214	0.265	0.315	0.363	0.409	0.453	0.494	0.533	0.569	0.603	0.633	0.660	0.684	0.705	0.723	0.737	0.749
10	.029	.058	.087	.115	.143	.170	.196	.222	.247	.270	.292	.314	.333	.352	.369	.384	.398	.410	.421	.430
16	.006	.011	.016	.022	.027	.032	.037	.042	.047	.052	.056	.060	.065	.068	.072	.076	.079	.082	.084	.086
22	.001	.002	.003	.004	.005	.006	.008	.009	.010	.010	.011	.012	.013	.014	.014	.015	.016	.016	.017	.018
	Surface tension, 450 dynes/cm																			
6	0.128	0.254	0.379	0.500	0.617	0.729	0.836	0.937	1.03	1.12	1.20	1.27	1.33	1.38	1.43	1.47	1.50	1.51	1.51	1.51
7	.088	.176	.263	.348	.430	.510	.587	.661	.730	.794	.855	.910	.961	1.01	1.05	1.08	1.11	1.14	1.16	1.18
8	.063	.126	.189	.250	.310	.368	.424	.478	.530	.579	.625	.668	.708	0.744	0.777	0.807	0.833	0.855	0.874	0.890
9	.046	.093	.138	.183	.228	.271	.313	.353	.392	.429	.464	.498	.529	.557	.584	.608	.630	.649	.665	.679
10	.035	.069	.103	.137	.170	.202	.234	.264	.294	.322	.349	.375	.399	.422	.443	.462	.480	.495	.509	.522
11	.026	.052	.078	.104	.128	.153	.177	.200	.223	.245	.265	.285	.304	.322	.338	.354	.368	.380	.392	.402
12	.020	.040	.059	.079	.098	.117	.135	.153	.170	.187	.203	.218	.233	.247	.260	.272	.283	.293	.303	.311
13	.015	.030	.045	.060	.075	.089	.104	.117	.131	.144	.156	.168	.180	.190	.200	.210	.219	.227	.234	.241
14	.012	.023	.035	.046	.058	.069	.080	.090	.101	.111	.120	.130	.139	.147	.155	.163	.170	.176	.182	.187
15	.009	.018	.027	.036	.045	.053	.062	.070	.078	.086	.093	.101	.108	.114	.120	.126	.132	.137	.141	.146
16	.007	.014	.021	.028	.035	.041	.048	.054	.060	.067	.072	.078	.083	.089	.093	.098	.102	.106	.110	.113
17	.006	.011	.016	.022	.027	.032	.037	.042	.047	.052	.056	.061	.065	.069	.073	.076	.080	.083	.086	.088
18	.004	.008	.013	.017	.021	.025	.029	.033	.036	.040	.044	.047	.050	.054	.057	.059	.062	.064	.067	.069
19	.003	.006	.010	.013	.016	.019	.022	.026	.028	.031	.034	.037	.039	.042	.044	.046	.048	.050	.052	.054
20	.003	.005	.008	.010	.013	.015	.017	.020	.022	.024	.026	.029	.030	.032	.034	.036	.037	.039	.040	.042
21	.002	.004	.006	.008	.010	.012	.014	.015	.017	.019	.020	.022	.024	.025	.027	.028	.029	.030	.031	.032
22	.002	.003	.005	.006	.008	.009	.011	.012	.013	.015	.016	.017	.018	.020	.021	.022	.023	.024	.024	.025
	Surface tension, 500 dynes/cm ²																			
8	0.072	0.143	0.215	0.286	0.354	0.421	0.485	0.547	0.607	0.663	0.716	0.766	0.813	0.855	0.894	0.929	0.961	0.989	1.01	1.03
10	.040	.080	.120	.159	.197	.235	.272	.308	.342	.375	.407	.436	.464	.491	.517	.542	.563	.582	.600	.615
16	.009	.017	.026	.034	.043	.051	.059	.067	.075	.082	.090	.097	.104	.110	.116	.122	.128	.133	.138	.142
22	.002	.004	.006	.008	.010	.012	.014	.016	.018	.020	.021	.023	.025	.026	.028	.029	.031	.032	.033	.034

TABLE 11. Rate of change of absolute pressure with height of a gas column of any composition at various densities

The rate of pressure change is negative; the absolute pressure increases for levels below, and decreases for levels above, the reference density

Density g/cm ³ × 10 ⁶	Absolute air pressure			Rate of change of absolute pressure, dP/dh				
	20°C mm Hg	25°C mm Hg	30°C mm Hg	mb/ft	mm Hg/ft	in. Hg/ft	psi/ft	mb/m
500	315.6	321.0	326.4	0.01490	0.01118	0.0004400	0.0002012	0.04903
600	378.7	385.2	391.6	.01788	.01341	.0005280	.0002415	.05884
700	441.9	449.4	457.0	.02086	.01565	.0006160	.0002817	.06865
800	505.0	513.6	522.2	.02384	.01788	.0007040	.0003219	.07845
900	568.1	577.8	587.5	.02682	.02012	.0007920	.0003622	.08826
1000	631.2	642.0	652.7	.02980	.02235	.0008800	.0004024	.09807
1100	694.4	706.2	718.1	.03278	.02459	.0009680	.0004427	.1079
1200	757.5	770.4	783.4	.03576	.02682	.001056	.0004829	.1177
1300	820.6	834.6	848.6	.03874	.02906	.001144	.0005231	.1275
1400	883.7	898.8	913.9	.04172	.03129	.001232	.0005634	.1373
1500	946.8	963.0	979.1	.04470	.03353	.001320	.0006036	.1471
1600	1010.0	1027.2	1044.5	.04768	.03576	.001408	.0006439	.1569
1700	1073.1	1091.4	1109.7	.05066	.03800	.001496	.0006841	.1667
1800	1136.2	1155.6	1175.0	.05364	.04023	.001584	.0007243	.1765
1900	1199.3	1219.8	1240.2	.05662	.04247	.001672	.0007646	.1863
2000	1262.5	1284.0	1305.6	.05960	.04470	.001760	.0008048	.1961
2500	1578.1	1605.0	1632.0	.07450	.05588	.002200	.001006	.2452
3000	1893.7	1926.0	1958.3	.08940	.06708	.002640	.001207	.2942
3500	2209.3	2247.0	2284.7	.1043	.07823	.003080	.001408	.3432
4000	2524.9	2568.0	2611.1	.1192	.08941	.003520	.001610	.3923
4500	2840.5	2889.0	2937.5	.1341	.1006	.003960	.001811	.4413
5000	3156.2	3210.1	3263.9	.1490	.1118	.004400	.002012	.4903
5500	3471.8	3531.0	3590.3	.1639	.1229	.004840	.002213	.5394
6000	3787.4	3852.0	3916.7	.1788	.1341	.005280	.002415	.5884

TABLE 12. Air density at various absolute pressures and temperatures based on air density at 760 mm of Hg and 0° C of 0.001293 g/cm³

Absolute pressure				Air density, g/cm ³ ×10 ⁶					
<i>mm Hg</i>	<i>in. Hg</i>	<i>mb</i>	<i>psi</i>	20° C	22° C	24° C	26° C	28° C	30° C
300	11.81	400.0	5.801	475.5	472.3	469.1	465.9	462.8	459.8
350	13.78	466.6	6.768	554.8	551.0	547.2	543.6	540.0	536.4
400	15.75	533.3	7.735	634.0	629.7	625.4	621.3	617.1	613.1
450	17.72	599.9	8.702	713.2	708.4	703.6	698.9	694.2	689.7
500	19.68	666.6	9.668	792.5	787.1	781.8	776.6	771.4	766.3
550	21.65	733.3	10.64	871.8	865.8	860.0	854.2	848.5	842.9
600	23.62	799.9	11.60	951.0	944.5	938.1	931.9	925.7	919.6
650	25.59	866.6	12.57	1030	1023	1016	1010	1003	996.2
700	27.56	933.3	13.54	1110	1102	1094	1087	1080	1073
750	29.53	999.9	14.50	1189	1181	1173	1165	1157	1149
760	29.9213	1013.25	14.696	1204.6	1196.4	1188.3	1180.4	1172.5	1164.8
800	31.50	1067	15.47	1268	1259	1251	1243	1234	1226
850	33.46	1133	16.44	1347	1338	1329	1320	1311	1303
900	35.43	1200	17.40	1426	1417	1407	1398	1388	1379
950	37.40	1267	18.37	1506	1495	1485	1476	1466	1456
1000	39.37	1333	19.34	1585	1574	1564	1553	1543	1533
1050	41.34	1400	20.30	1664	1653	1642	1631	1620	1609
1100	43.31	1467	21.27	1744	1732	1720	1708	1697	1686
1150	45.28	1533	22.24	1823	1810	1798	1786	1774	1763
1200	47.24	1600	23.20	1902	1889	1876	1864	1851	1839
1250	49.21	1667	24.17	1981	1968	1954	1941	1928	1916
1300	51.18	1733	25.14	2060	2046	2033	2019	2006	1992
1350	53.15	1800	26.10	2140	2125	2111	2097	2083	2069
1400	55.12	1866	27.07	2219	2204	2189	2174	2160	2146
1450	57.09	1933	28.04	2298	2283	2267	2252	2237	2222
1500	59.06	2000	29.01	2378	2361	2345	2330	2314	2299
1600	62.99	2133	30.94	2536	2519	2502	2485	2468	2452
1700	66.93	2266	32.87	2694	2676	2658	2640	2623	2605
1800	70.87	2400	34.81	2853	2834	2814	2796	2777	2759
1900	74.80	2533	36.74	3012	2991	2971	2951	2931	2912
2000	78.72	2666	38.67	3170	3148	3127	3106	3086	3065
2100	82.68	2800	40.61	3328	3306	3283	3262	3240	3219
2200	86.60	2933	42.54	3487	3463	3440	3417	3394	3372
2300	90.55	3066	44.48	3646	3621	3596	3572	3548	3525
2400	94.49	3200	46.41	3804	3778	3753	3728	3703	3678
2500	98.42	3333	48.34	3962	3936	3909	3883	3857	3832
2600	102.4	3466	50.28	4121	4093	4065	4038	4011	3985
2700	106.3	3600	52.21	4280	4250	4222	4194	4165	4138
2800	110.2	3733	54.14	4438	4408	4378	4349	4320	4291
2900	114.2	3866	56.08	4596	4565	4534	4504	4474	4445
3000	118.1	4000	58.01	4755	4723	4691	4659	4628	4598
3100	122.0	4133	59.94	4914	4880	4847	4815	4783	4751
3200	126.0	4266	61.88	5072	5037	5003	4970	4937	4904
3300	129.9	4400	63.81	5230	5195	5160	5125	5091	5058
3400	133.9	4533	65.75	5389	5352	5316	5281	5245	5211
3500	137.8	4666	67.68	5548	5510	5472	5436	5400	5364

WASHINGTON, D. C., April 2, 1959.

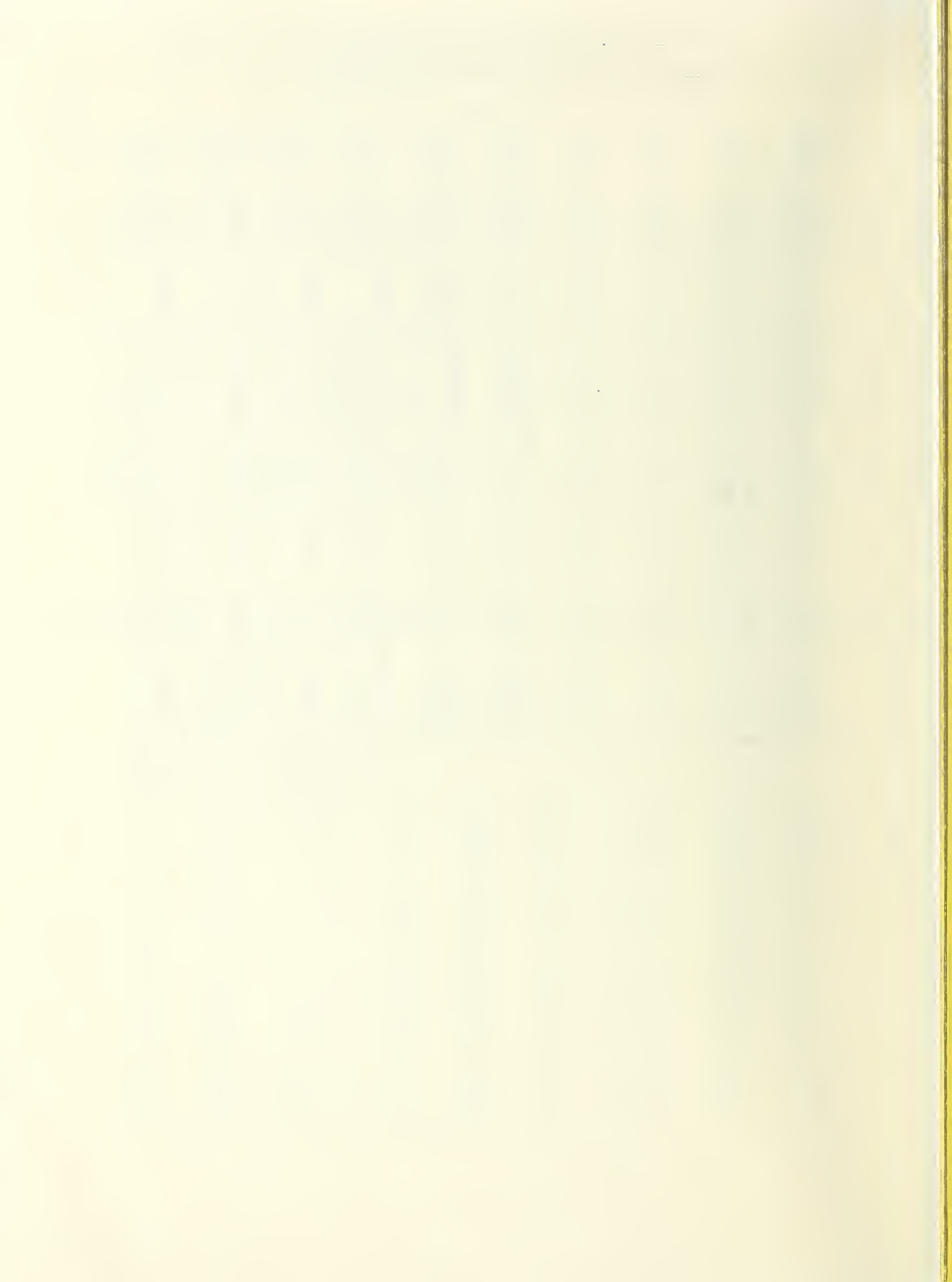

THE NATIONAL BUREAU OF STANDARDS

The scope of activities of the National Bureau of Standards at its major laboratories in Washington, D.C., and Boulder, Colorado, is suggested in the following listing of the divisions and sections engaged in technical work. In general, each section carries out specialized research, development, and engineering in the field indicated by its title. A brief description of the activities, and of the resultant publications, appears on the inside of the front cover.

WASHINGTON, D.C.

Electricity and Electronics. Resistance and Reactance. Electron Devices. Electrical Instruments. Magnetic Measurements. Dielectrics. Engineering Electronics. Electronic Instrumentation. Electrochemistry.

Optics and Metrology. Photometry and Colorimetry. Optical Instruments. Photographic Technology. Length. Engineering Metrology.

Heat. Temperature Physics. Thermodynamics. Cryogenic Physics. Rheology. Molecular Kinetics. Free Radicals Research.

Atomic Physics. Spectroscopy. Radiometry. Mass Spectrometry. Solid State Physics. Electron Physics. Atomic Physics.

Radiation Physics. Neutron Physics. Radiation Theory. Radioactivity. X-ray. High Energy Radiation. Nucleonic Instrumentation. Radiological Equipment.

Chemistry. Organic Coatings. Surface Chemistry. Organic Chemistry. Analytical Chemistry. Inorganic Chemistry. Electrodeposition. Molecular Structure and Properties of Gases. Physical Chemistry. Thermochemistry. Spectrochemistry. Pure Substances.

Mechanics. Sound. Mechanical Instruments. Fluid Mechanics. Engineering Mechanics. Mass and Scale. Capacity, Density, and Fluid Meters. Combustion Controls.

Organic and Fibrous Materials. Rubber. Textiles. Paper. Leather. Testing and Specifications. Polymer Structure. Plastics. Dental Research.

Metallurgy. Thermal Metallurgy. Chemical Metallurgy. Mechanical Metallurgy. Corrosion. Metal Physics.

Mineral Products. Engineering Ceramics. Glass. Refractories. Enameled Metals. Constitution and Microstructure.

Building Technology. Structural Engineering. Fire Protection. Air Conditioning, Heating, and Refrigeration. Floor, Roof, and Wall Coverings. Codes and Safety Standards. Heat Transfer. Concreting Materials.

Applied Mathematics. Numerical Analysis. Computation. Statistical Engineering. Mathematical Physics.

Data Processing Systems. SEAC Engineering Group. Components and Techniques. Digital Circuitry. Digital Systems. Analog Systems. Applications Engineering.

• Office of Basic Instrumentation.

• Office of Weights and Measures

BOULDER, COLORADO

Cryogenic Engineering. Cryogenic Equipment. Cryogenic Processes. Properties of Materials. Gas Liquefaction.

Radio Propagation Physics. Upper Atmosphere Research. Ionosphere Research. Regular Prediction Services. Sun-Earth Relationships. VHF Research. Radio Warning Services. Airglow and Aurora. Radio Astronomy and Arctic Propagation.

Radio Propagation Engineering. Data Reduction Instrumentation. Radio Noise. Tropospheric Measurements. Tropospheric Analysis. Propagation-Terrain Effects. Radio-Meteorology. Lower Atmosphere Physics.

Radio Standards. High-Frequency Electrical Standards. Radio Broadcast Service. Radio and Microwave Materials. Atomic Frequency and Time Standards. Electronic Calibration Center. Microwave Circuit Standards.

Radio Communication and Systems. Low Frequency and Very Low Frequency Research. High Frequency and Very High Frequency Research. Modulation Systems. Antenna Research. Navigation Systems. Systems Analysis. Field Operations.

