

# MERITOR WABCO

## Workbook

### Meritor WABCO Air Brake Systems

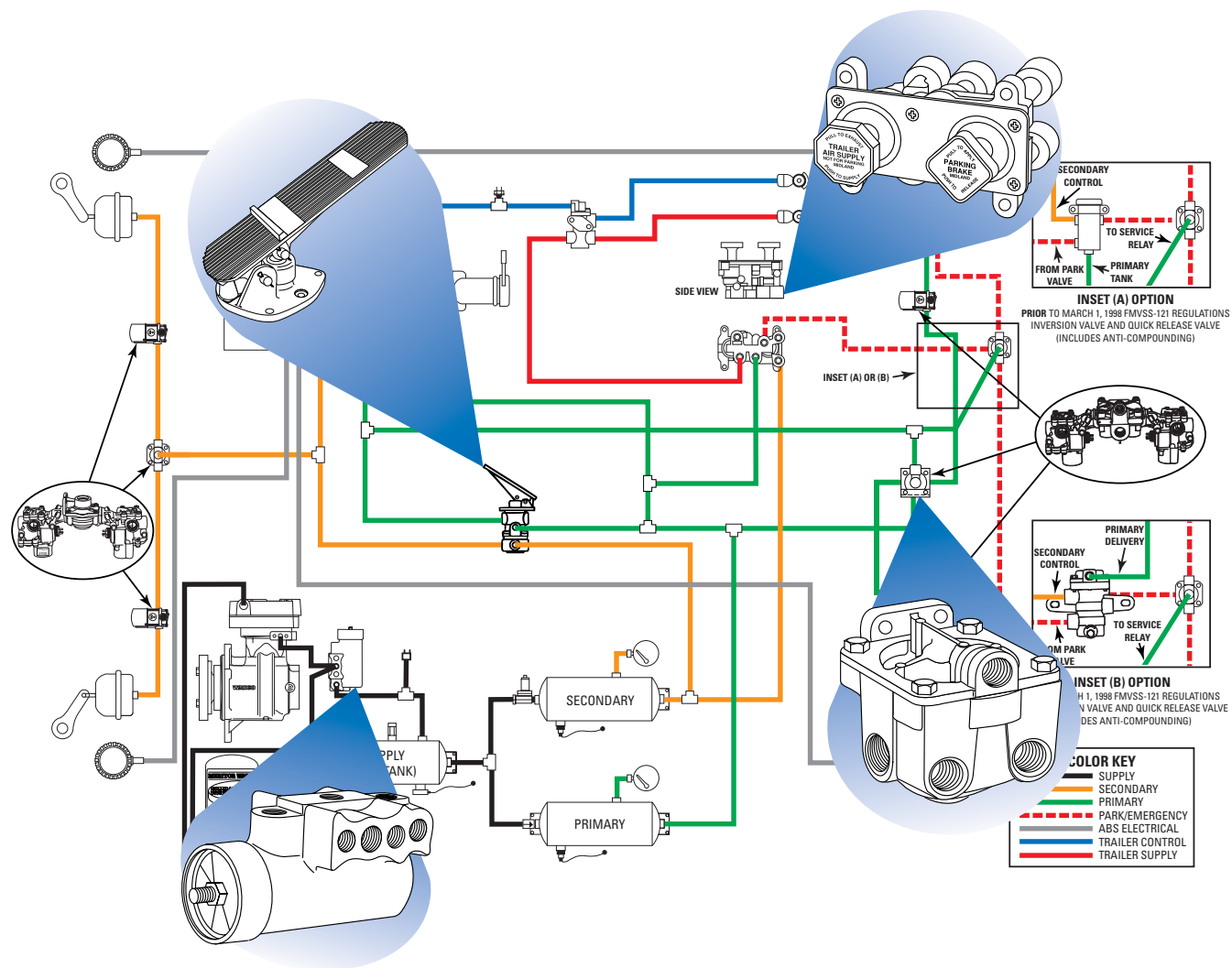

# Introduction

The purpose of an air brake system on heavy duty vehicles is to convert air pressure to mechanical energy to activate the foundation brakes. Federal Motor Vehicle Safety Standard 121 dictates how this is to be done for over-the-road vehicles.

The purpose of this book is to help you construct Meritor WABCO Truck and Tractor air systems. It will also help you identify air system components and understand how they relate to FMVSS-121.

**NOTE:** The systems described in this workbook are generic air brake systems.

Included in this book are:

## Truck Systems







- Air Supply
- Secondary Service
- Primary Service
- Parking
- Anti-Compounding
- Emergency (Prior to 3/1/98)
- Emergency (After 3/1/98)

## Tractor/Trailer Systems

- Tractor Parking & Trailer Air Supply
- Trailer Control

For additional information, call ArvinMeritor's Customer Service Center at 800-535-5560.

## Air Brake System Color Key

COLOR KEY	
	SUPPLY
	SECONDARY
	PRIMARY
	PARK/EMERGENCY
	ABS ELECTRICAL
	TRAILER CONTROL
	TRAILER SUPPLY

# Truck Air Supply System

**MERITOR WABCO**

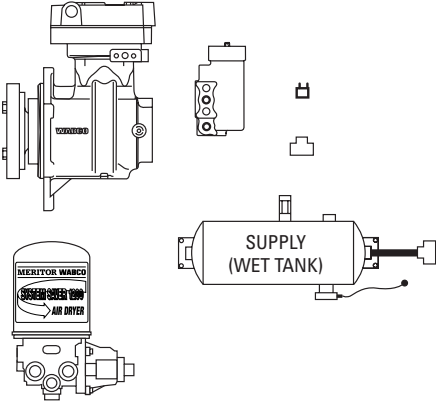

# Truck Air Supply System

**MERITOR WABCO**

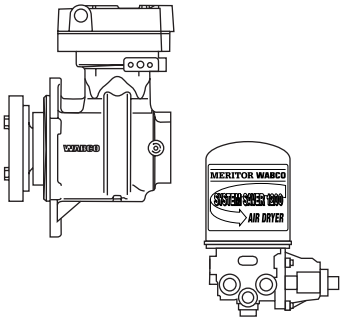

**Compressor** \_\_\_\_\_

**Air Dryer** \_\_\_\_\_

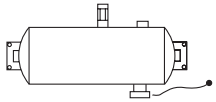

**Supply Tank** \_\_\_\_\_

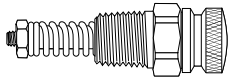

**Pressure Relief Valve** \_\_\_\_\_

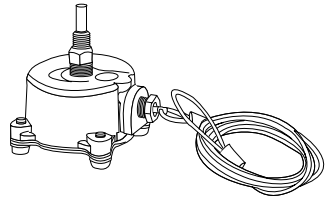

**Automatic/Manual Drain Valve** \_\_\_\_\_

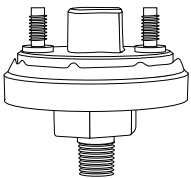

**Low Pressure Switch** \_\_\_\_\_

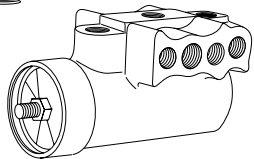

**Governor** \_\_\_\_\_

# Truck Secondary Service System

**MERITOR WABCO**

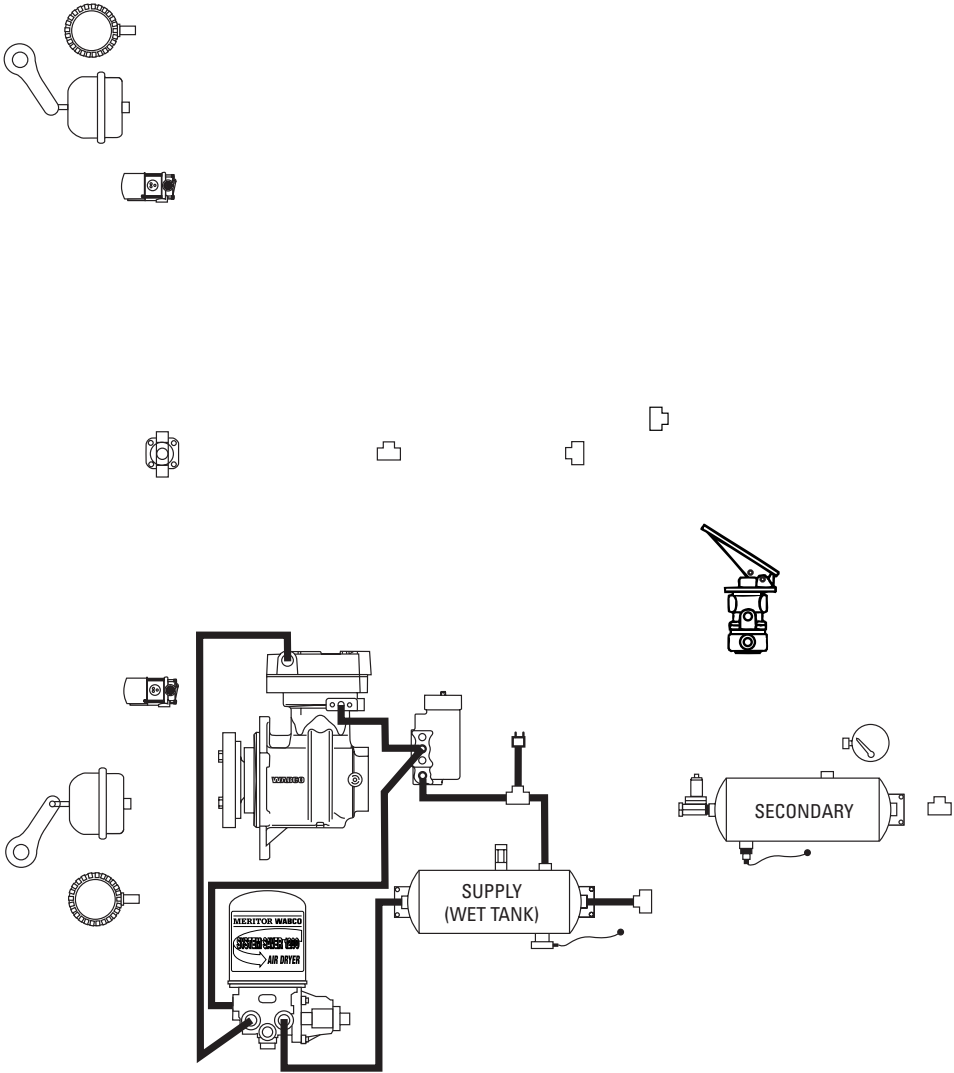

# Truck Secondary Service System

**MERITOR WABCO**

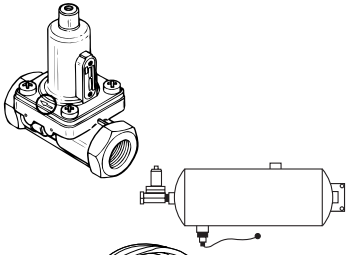

Pressure Control Check Valve \_\_\_\_\_

Secondary Service Tank \_\_\_\_\_

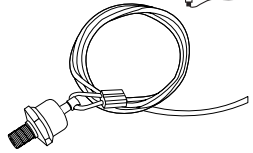

Manual Drain Valve \_\_\_\_\_



Air Gauge \_\_\_\_\_

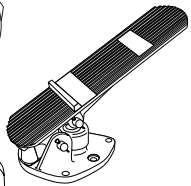

Dual Foot Control Valve \_\_\_\_\_

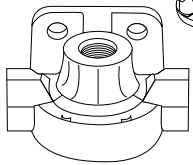

Quick Release Valve \_\_\_\_\_

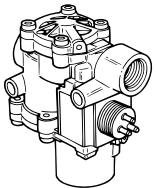

ABS Modulator Valve \_\_\_\_\_

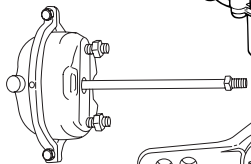

Service Chambers \_\_\_\_\_

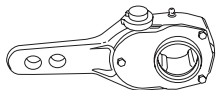

Manual Slack Adjusters \_\_\_\_\_

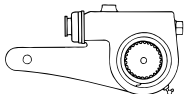

Automatic Slack Adjusters \_\_\_\_\_

# Truck Primary Service System

**MERITOR WABCO**

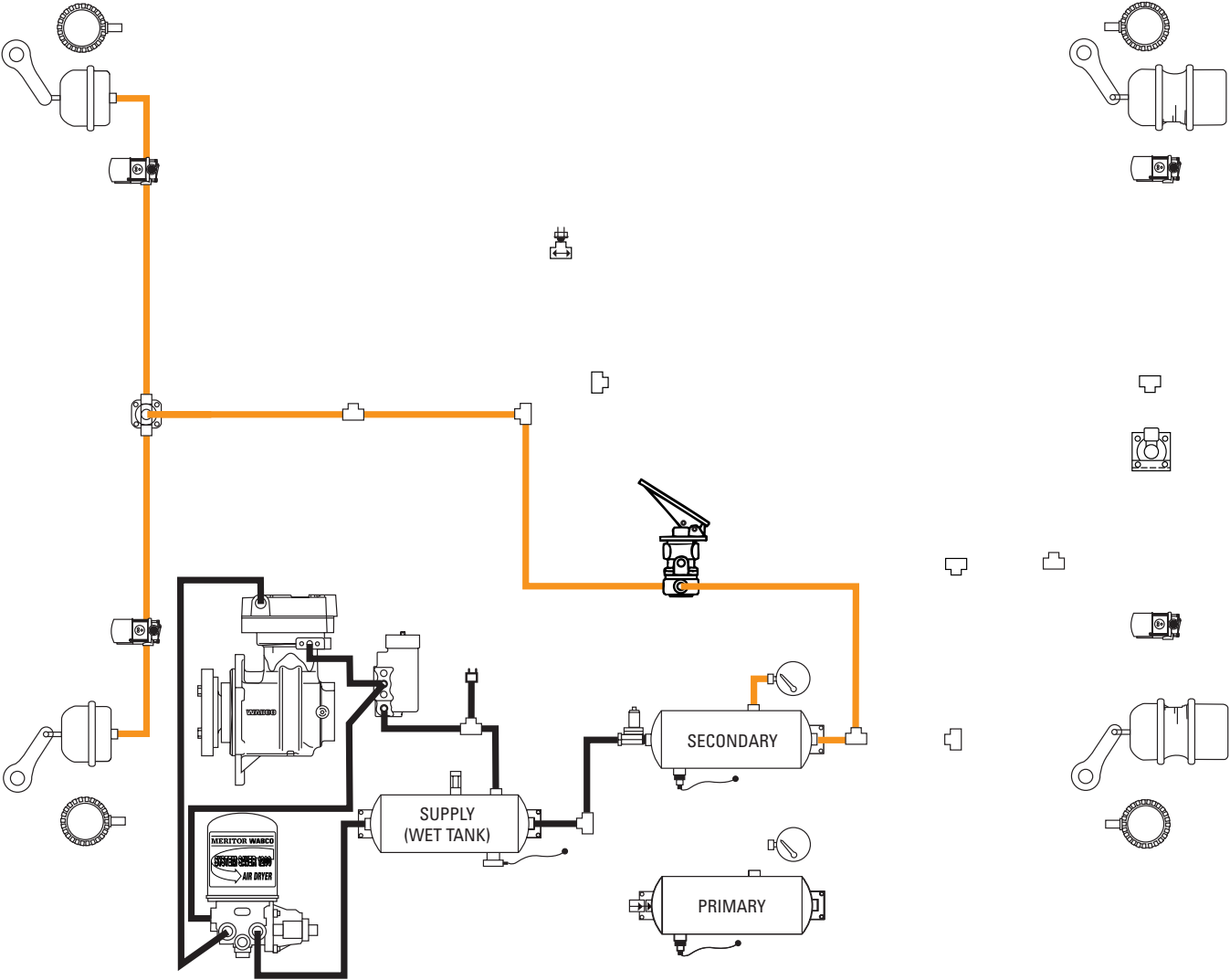

# Truck Primary Service System

**MERITOR WABCO**

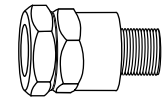

**One-Way Check Valve** \_\_\_\_\_

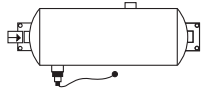

**Primary Service Tank** \_\_\_\_\_

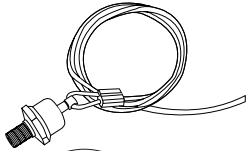

**Manual Drain Valve** \_\_\_\_\_



**Air Gauge** \_\_\_\_\_

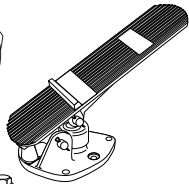

**Dual Foot Control Valve** \_\_\_\_\_

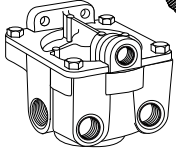

**Service Relay Valve** \_\_\_\_\_

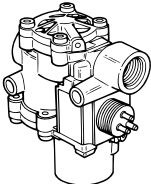

**ABS Modulator Valve** \_\_\_\_\_

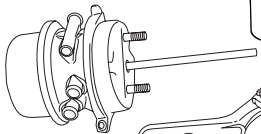

**Spring Brakes** \_\_\_\_\_

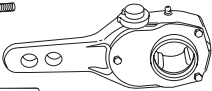

**Manual Slack Adjusters** \_\_\_\_\_



**Automatic Slack Adjusters** \_\_\_\_\_

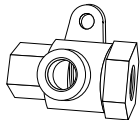

**Two-Way Check Valve** \_\_\_\_\_

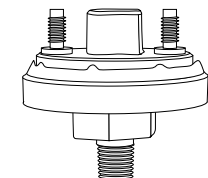

**Stoplight Switch** \_\_\_\_\_



# Truck Parking System

**MERITOR WABCO**

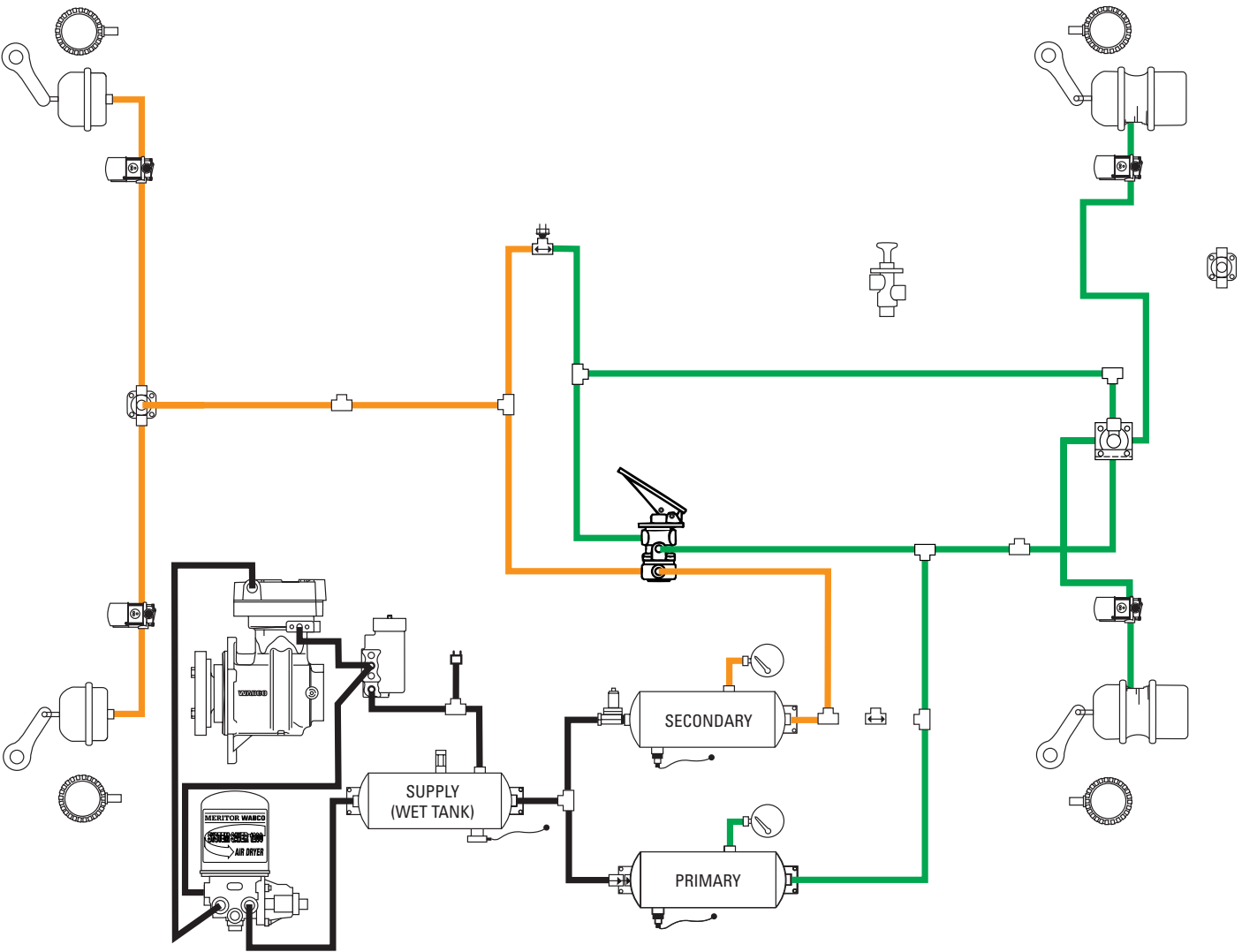

# Truck Parking System

**MERITOR WABCO**

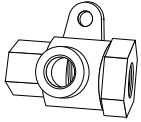

**Two-Way Check Valve** \_\_\_\_\_  
\_\_\_\_\_  
\_\_\_\_\_



**Dash Valve (Yellow Diamond Knob)** \_\_\_\_\_  
\_\_\_\_\_  
\_\_\_\_\_  
\_\_\_\_\_  
\_\_\_\_\_  
\_\_\_\_\_  
\_\_\_\_\_  
\_\_\_\_\_  
\_\_\_\_\_  
\_\_\_\_\_  
\_\_\_\_\_

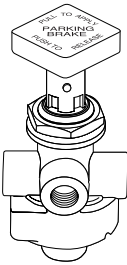

**Quick Release Valve** \_\_\_\_\_  
\_\_\_\_\_  
\_\_\_\_\_

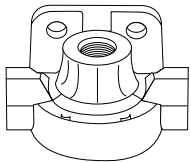

**Spring Brakes** \_\_\_\_\_  
\_\_\_\_\_  
\_\_\_\_\_

# Truck Anti-Compounding System

**MERITOR WABCO**

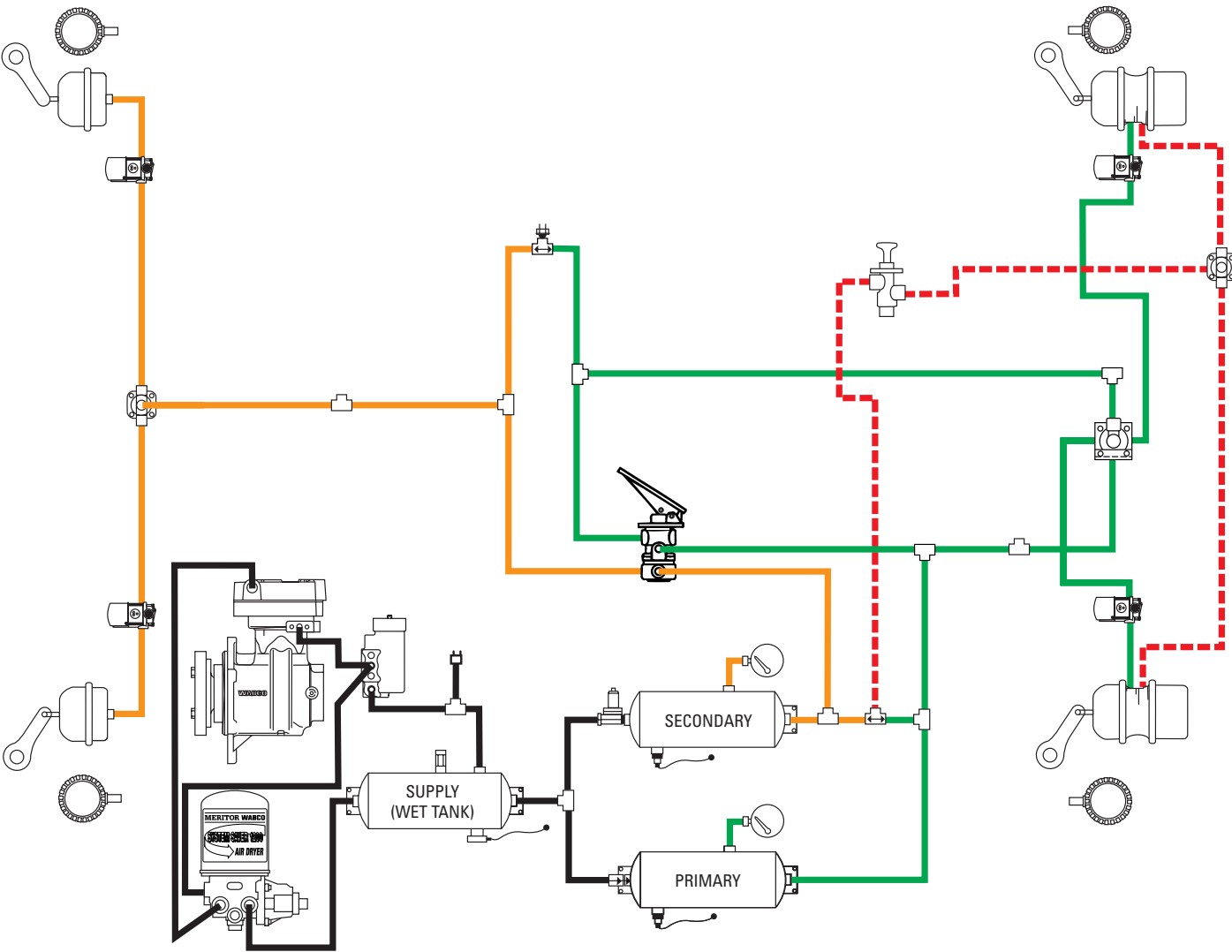

# Truck Anti-Compounding System

**MERITOR WABCO**

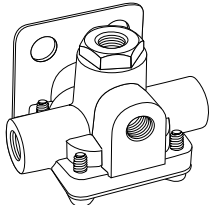

Quick Release With Two-Way Check Valve \_\_\_\_\_

\_\_\_\_\_

\_\_\_\_\_

\_\_\_\_\_

\_\_\_\_\_

\_\_\_\_\_

\_\_\_\_\_

\_\_\_\_\_

\_\_\_\_\_

\_\_\_\_\_

\_\_\_\_\_

\_\_\_\_\_

\_\_\_\_\_

\_\_\_\_\_

\_\_\_\_\_

\_\_\_\_\_

\_\_\_\_\_

\_\_\_\_\_

\_\_\_\_\_

\_\_\_\_\_

\_\_\_\_\_

\_\_\_\_\_

\_\_\_\_\_

\_\_\_\_\_

\_\_\_\_\_

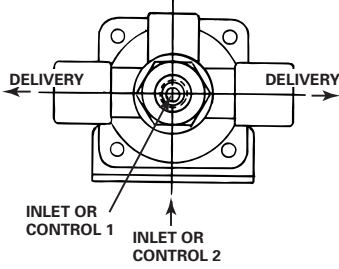
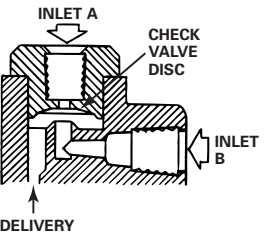

# Truck Emergency System (Prior to March 1, 1998)

**MERITOR WABCO**

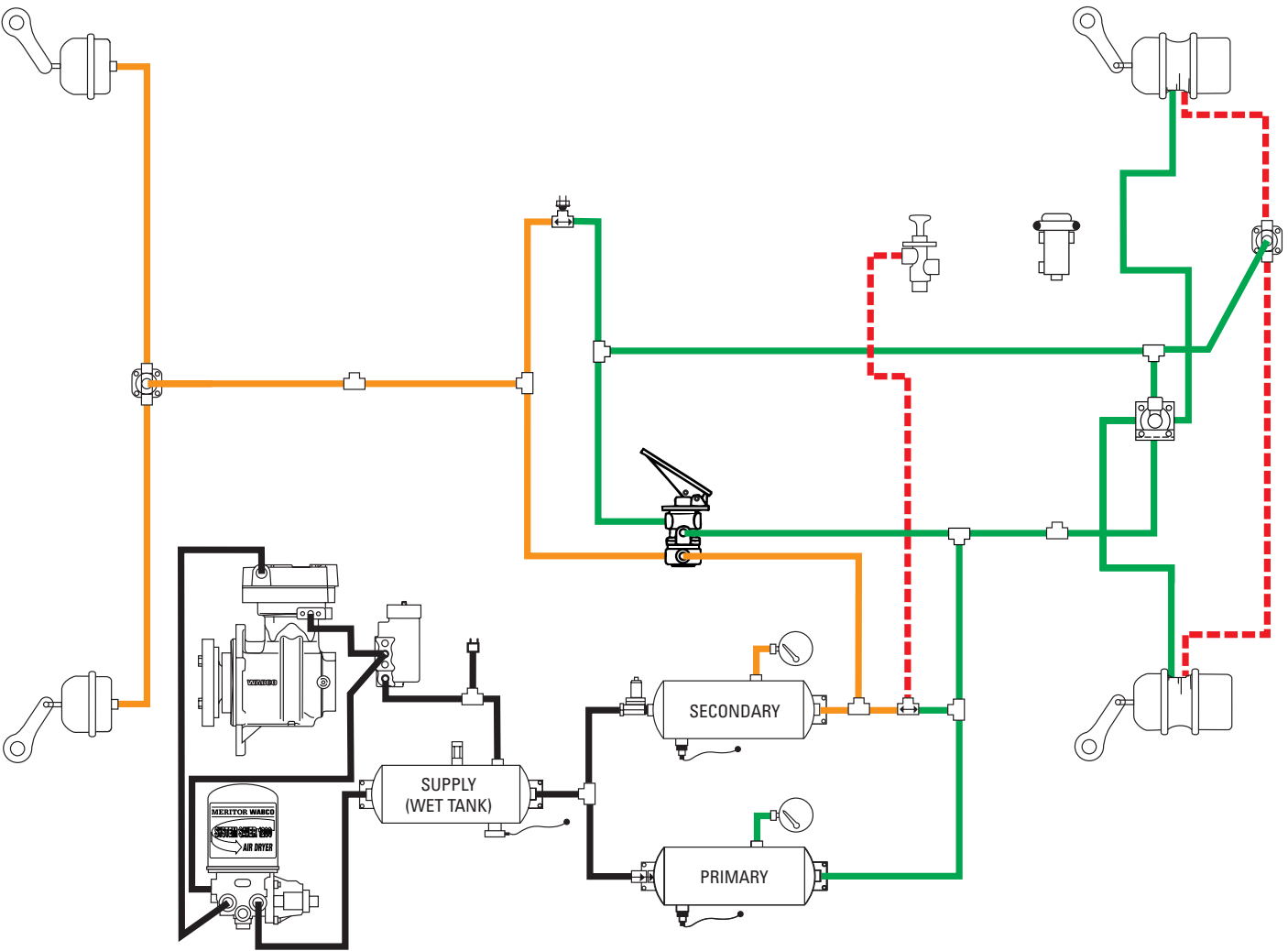

# Truck Emergency System

**MERITOR WABCO**

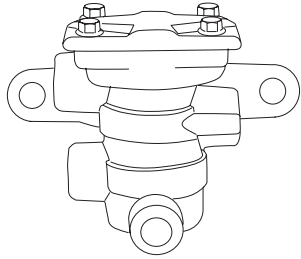

**Inversion Valve (Prior to March 1, 1998)**  
**Meritor WABCO Production Part Number 9718990010**  
**Meritor WABCO Service Part Number RKN28030**

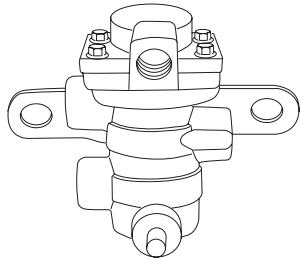
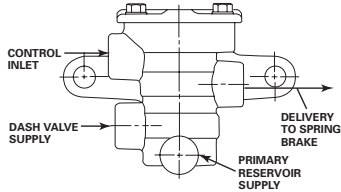

**New Inversion Valve (Used After March 1, 1998)**  
**Meritor WABCO Production Part Number 9718990020**  
**Meritor WABCO Service Part Number RKN28032**

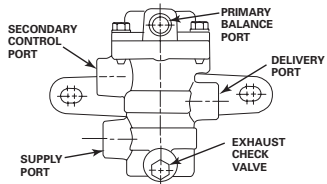

# Truck Emergency System Complete (Prior to March 1, 1998)

**MERITOR WABCO**

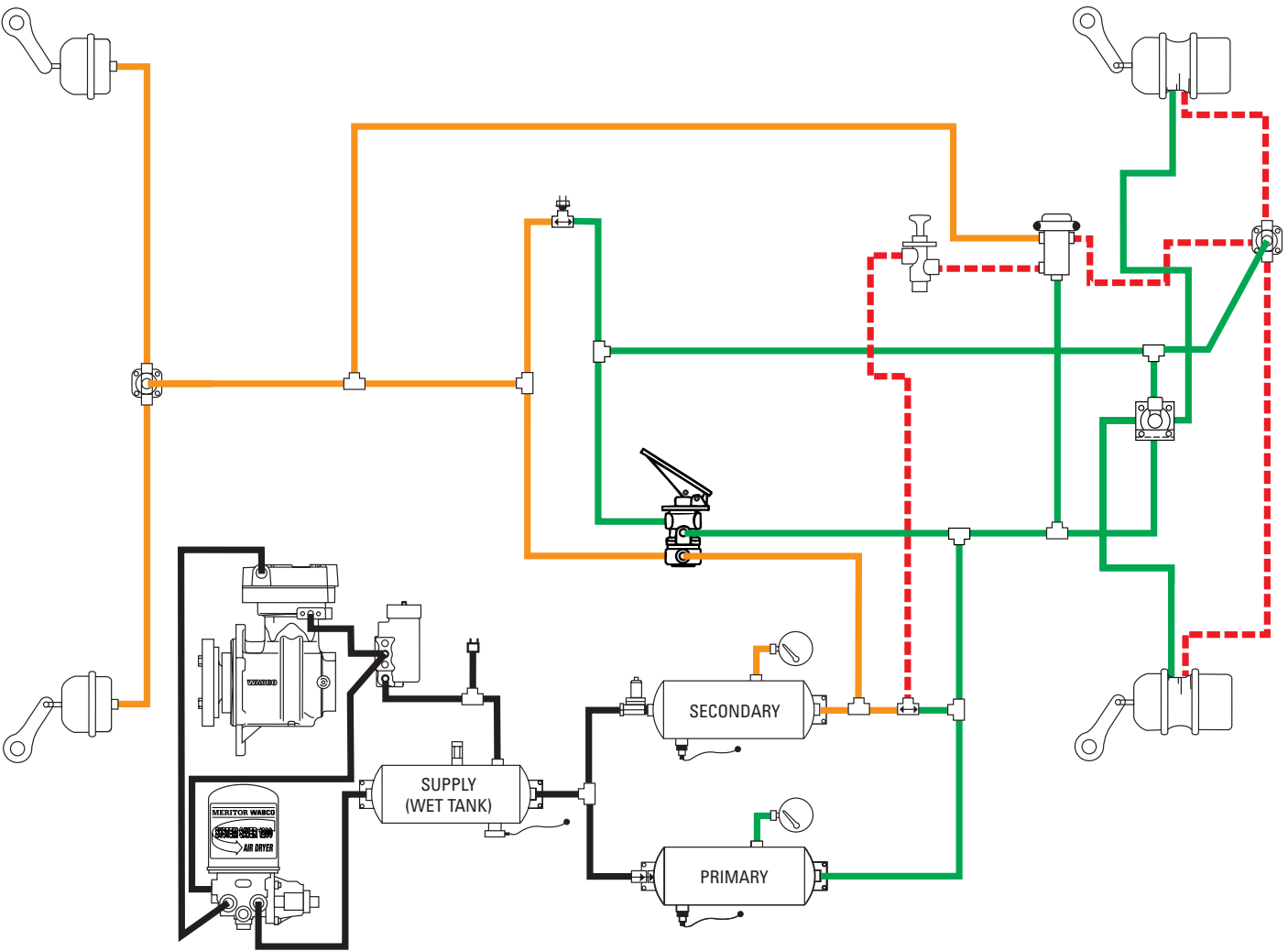

# Truck Emergency System (After March 1, 1998)

**MERITOR WABCO**

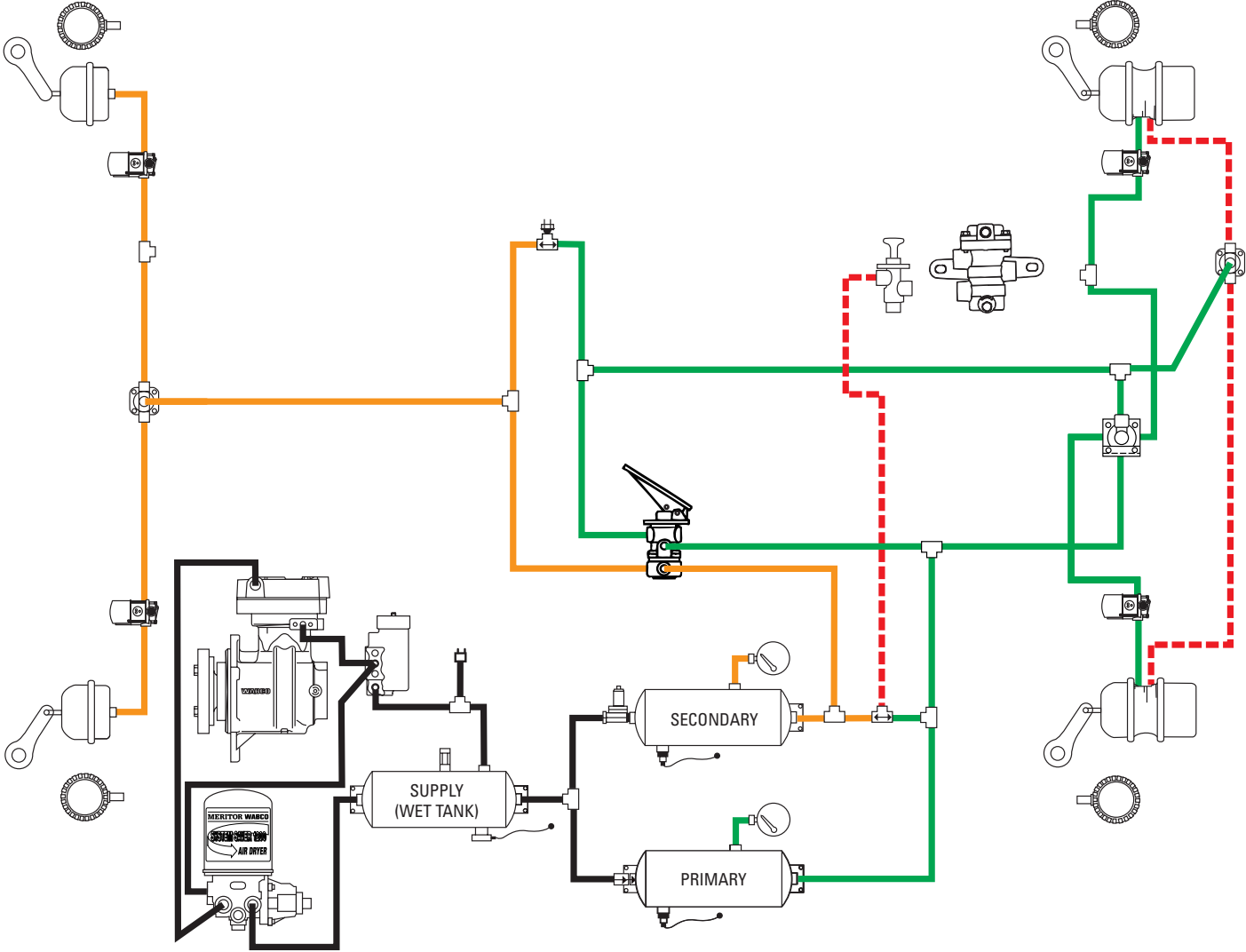



# Truck Emergency System Complete (After March 1, 1998)

**MERITOR WABCO**

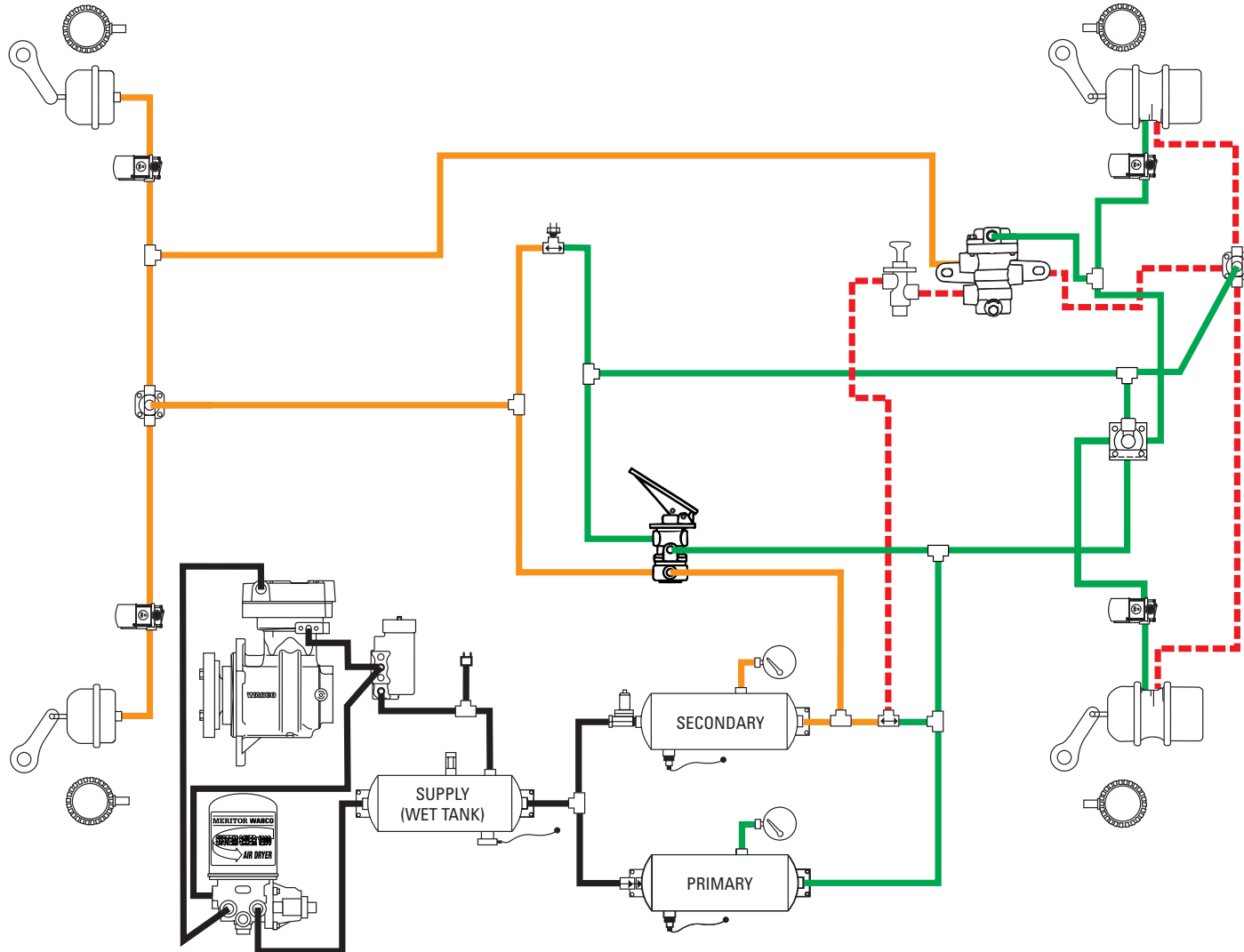

# Truck Self Test (Prior to March 1, 1998)

**MERITOR WABCO**

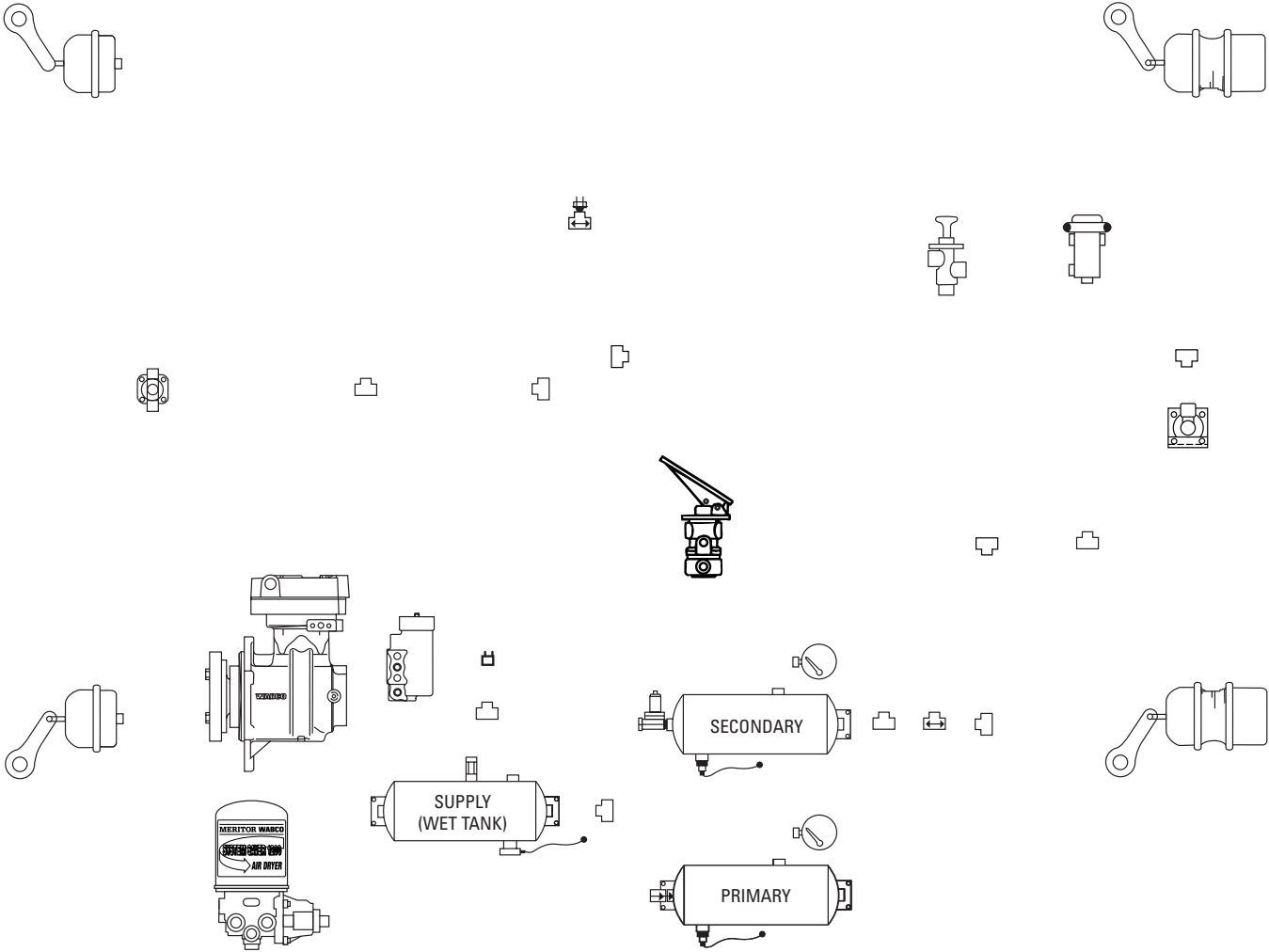

# Truck Self Test (After March 1, 1998)

**MERITOR WABCO**

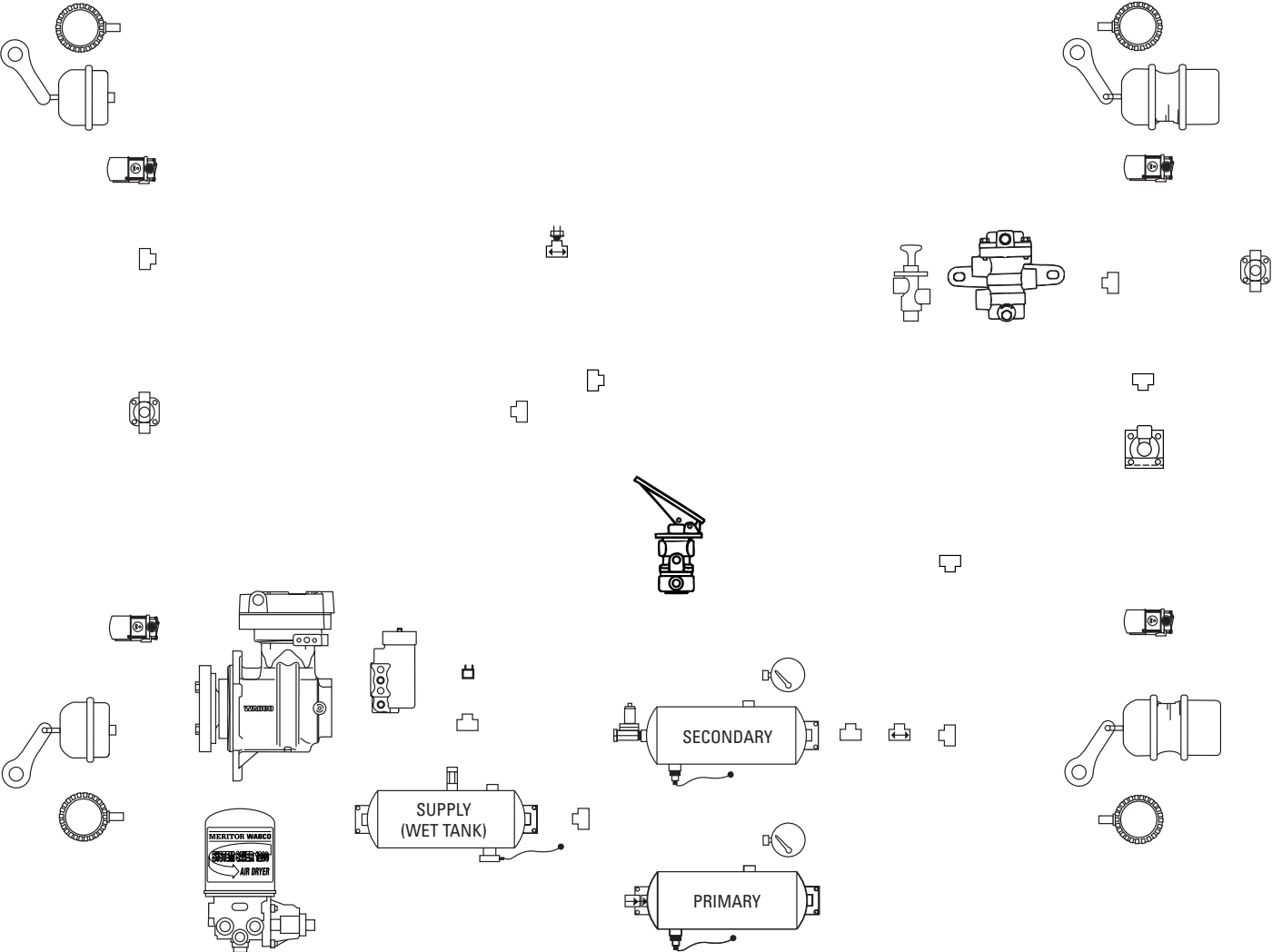

# Truck Anti-Compounding/Emergency System

**MERITOR WABCO**

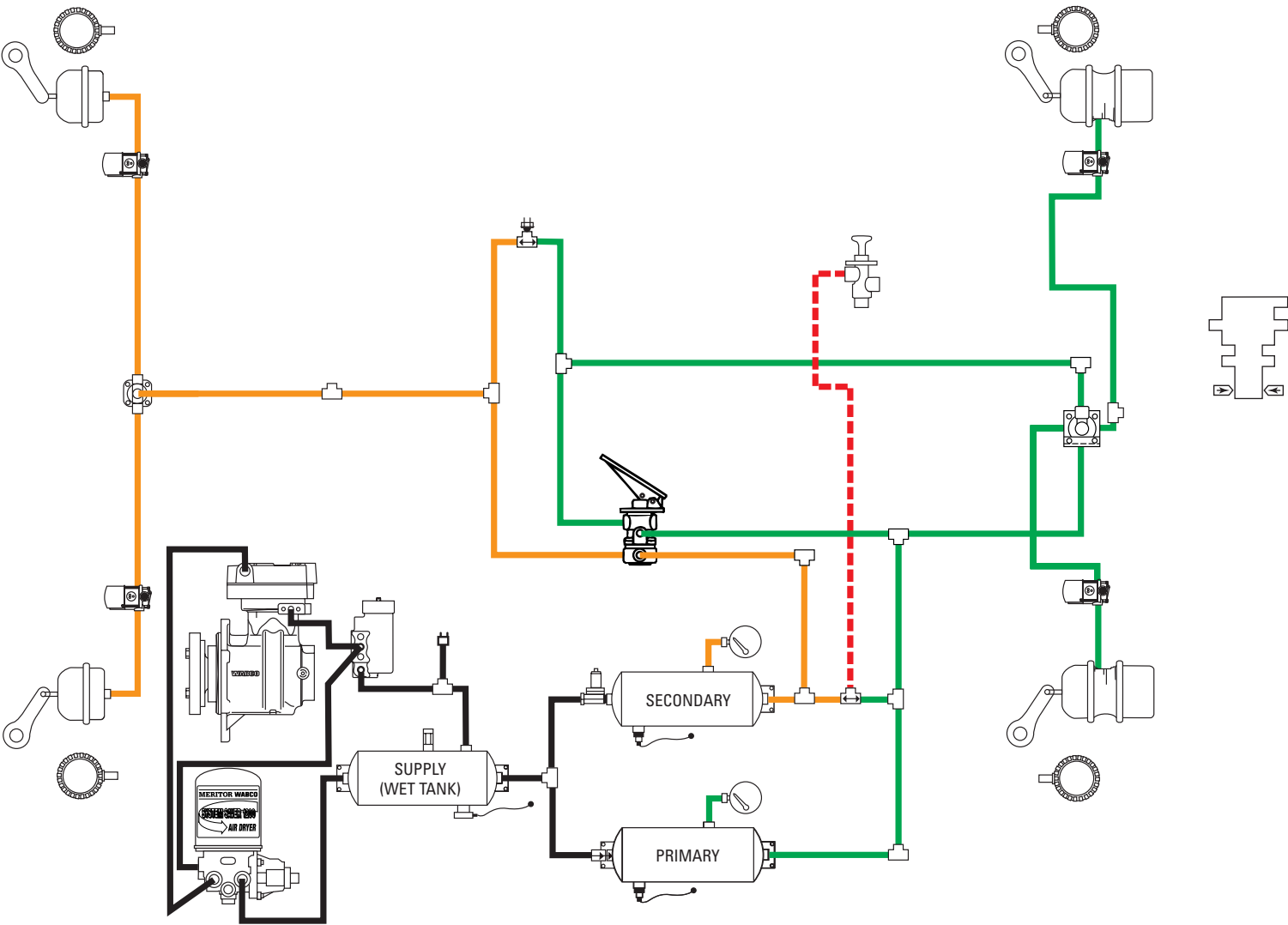

**Truck  
Anti-Compounding/Emergency System**

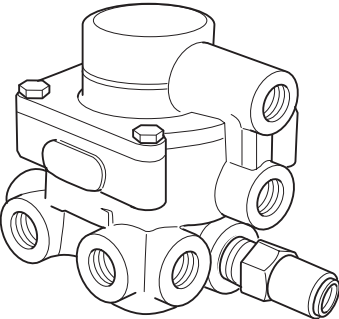

**Inversion Relay Valve With Anti-Compounding** \_\_\_\_\_

\_\_\_\_\_  
\_\_\_\_\_  
\_\_\_\_\_  
\_\_\_\_\_  
\_\_\_\_\_  
\_\_\_\_\_  
\_\_\_\_\_  
\_\_\_\_\_  
\_\_\_\_\_  
\_\_\_\_\_  
\_\_\_\_\_

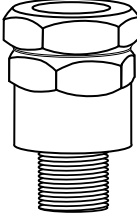

**One-Way Check Valve** \_\_\_\_\_

\_\_\_\_\_  
\_\_\_\_\_  
\_\_\_\_\_  
\_\_\_\_\_  
\_\_\_\_\_  
\_\_\_\_\_  
\_\_\_\_\_  
\_\_\_\_\_  
\_\_\_\_\_  
\_\_\_\_\_  
\_\_\_\_\_  
\_\_\_\_\_  
\_\_\_\_\_  
\_\_\_\_\_

# Truck Anti-Compounding/Emergency System

**MERITOR WABCO**

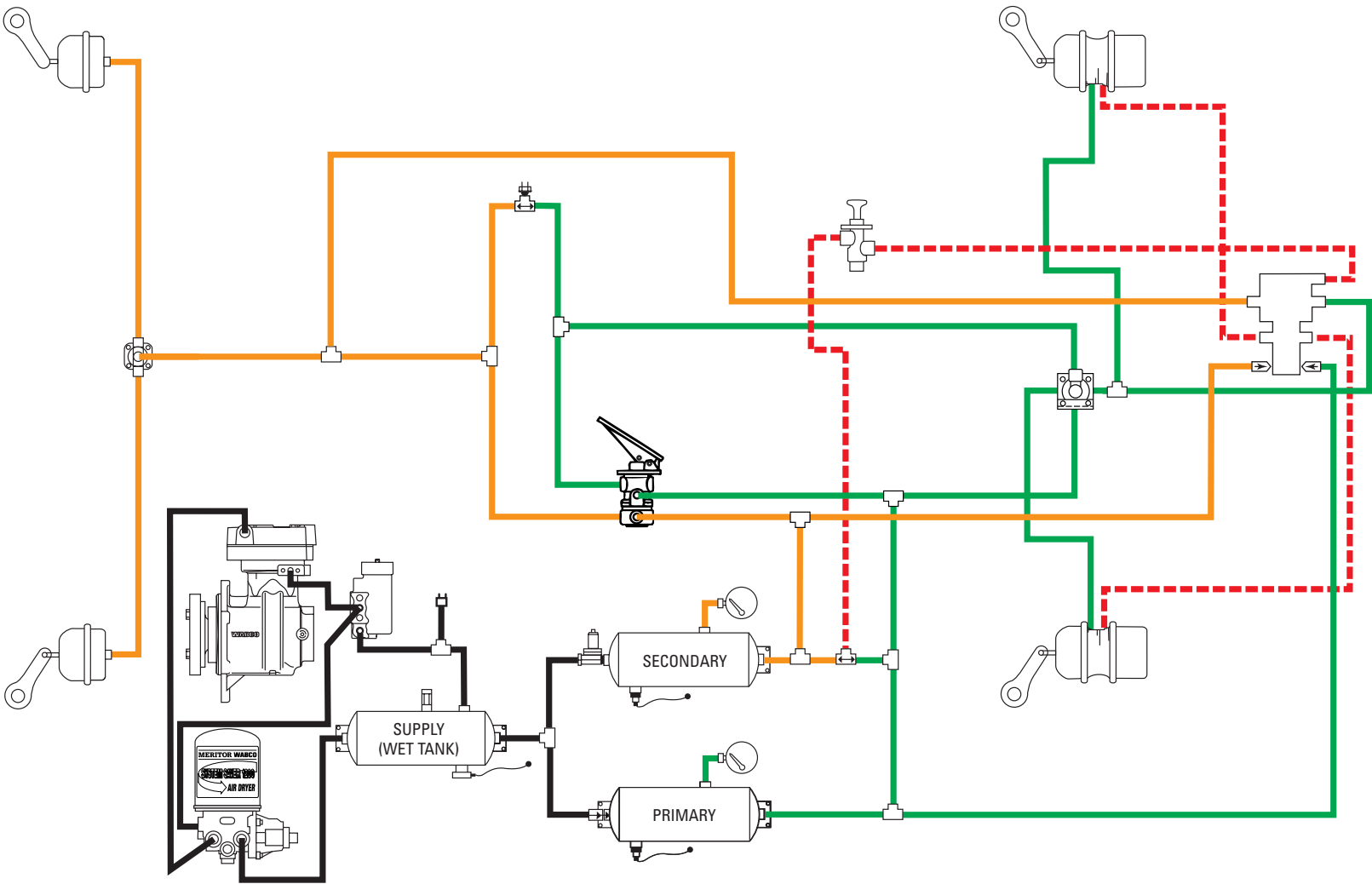

# Truck Anti-Compounding/Emergency System Test

**MERITOR WABCO**

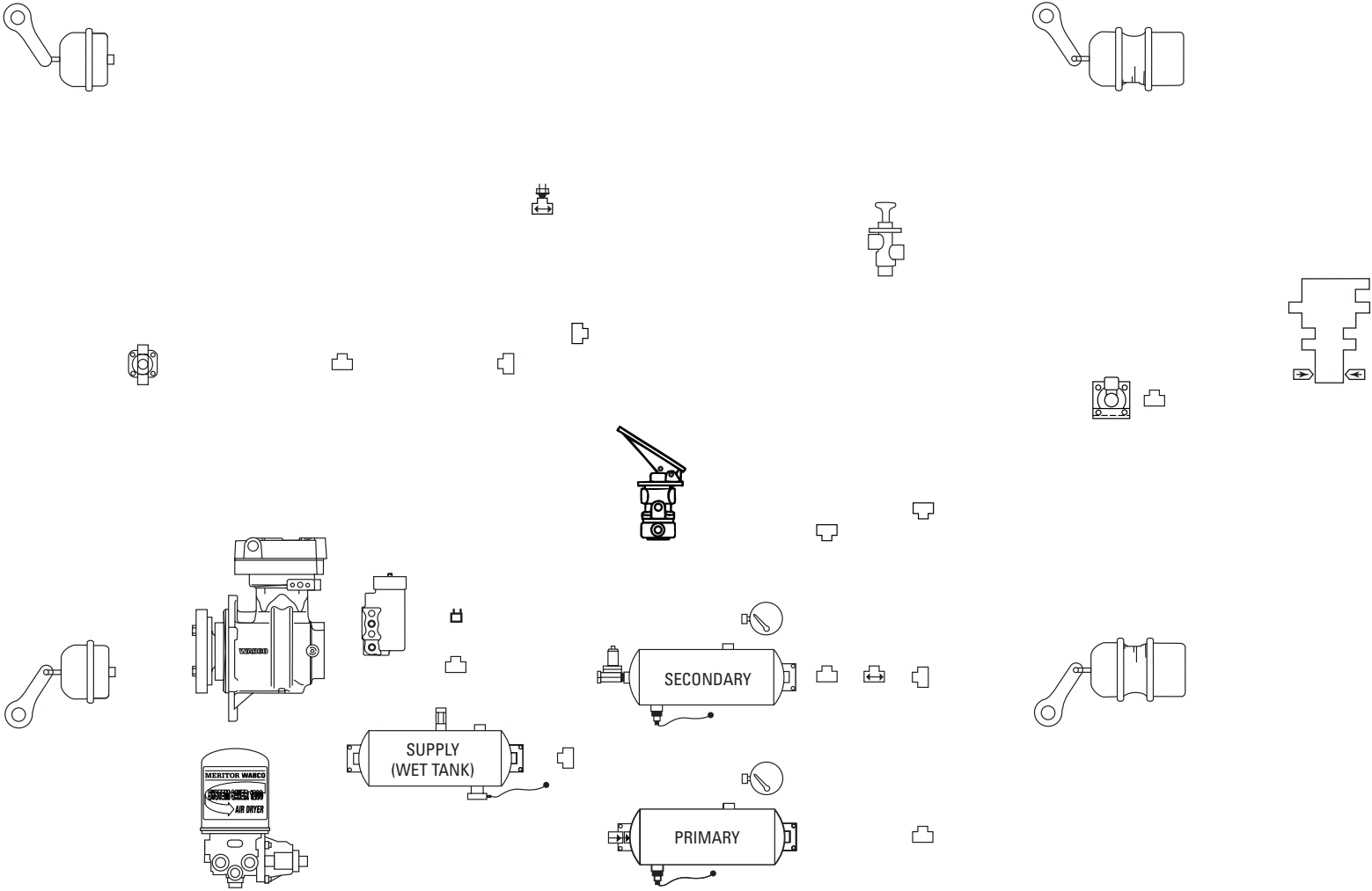

# Tractor Parking and Trailer Air Supply System

**MERITOR WABCO**

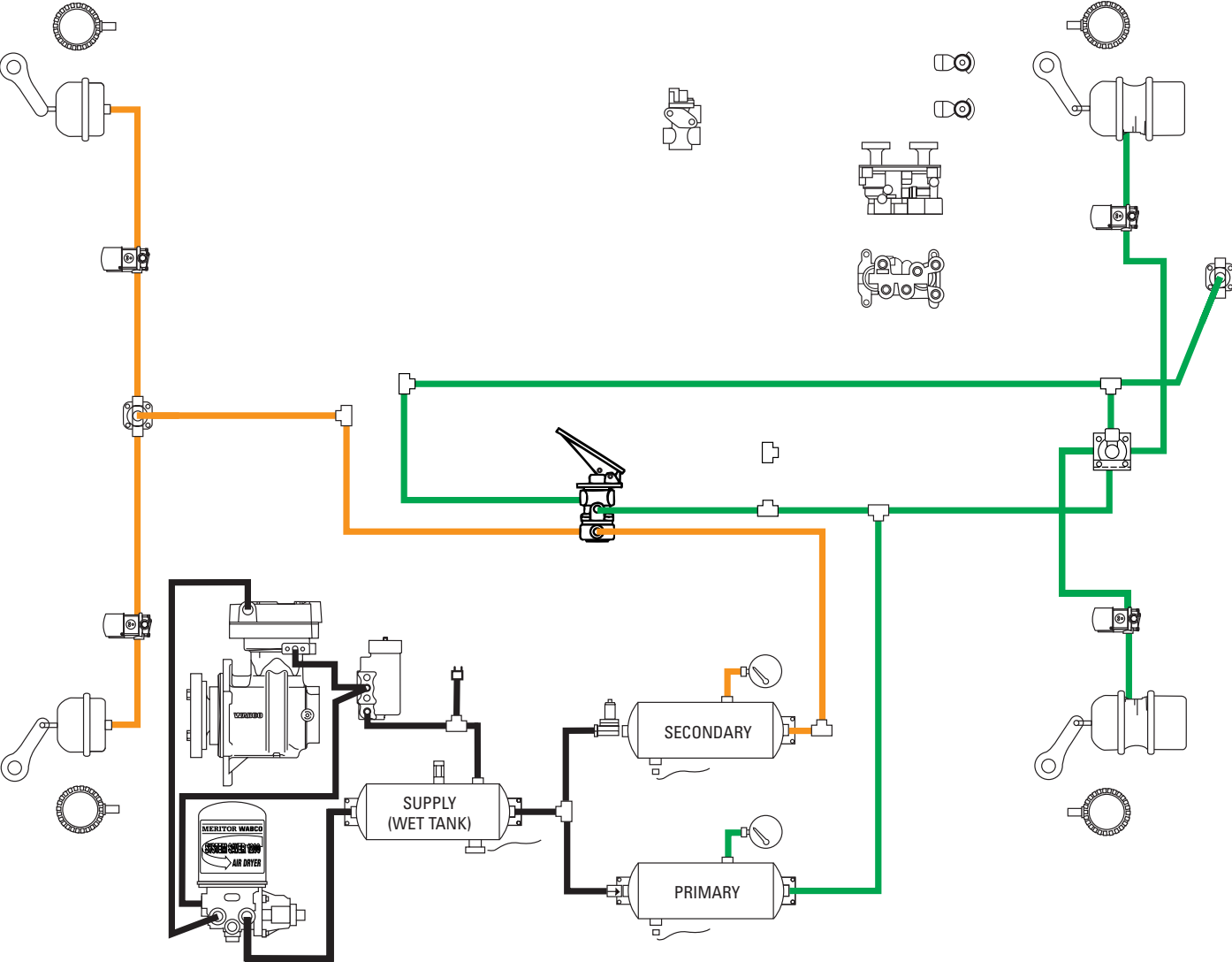



# Tractor Parking and Trailer Air Supply System

**MERITOR WABCO**

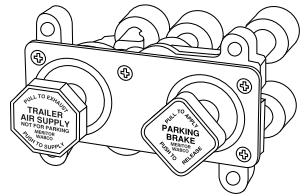

Module Dash Control (Yellow Diamond Knob & Red Octagon Knob) \_\_\_\_\_

---

---

---

---

---

---

---

---

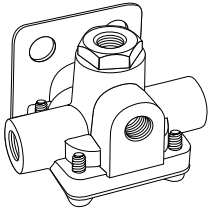

Quick Release With Two-Way Check Valve \_\_\_\_\_

---

---

---

---

---

---

---

---

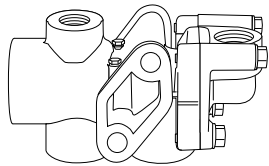

(2 Line) Tractor Protection Valve \_\_\_\_\_

---

---

---

---

---

---

---

---

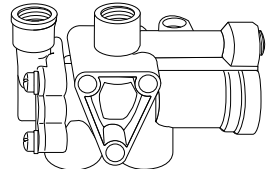

(3 Line) Tractor Protection Valve \_\_\_\_\_

---

---

---

---

---

---

---

---

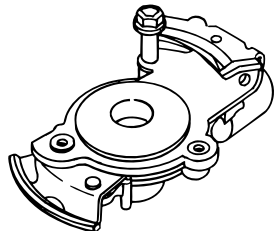

(Trailer Supply) Gladhand \_\_\_\_\_

---

---

---

---

---

---

---

---

# Tractor Trailer Control System

**MERITOR WABCO**

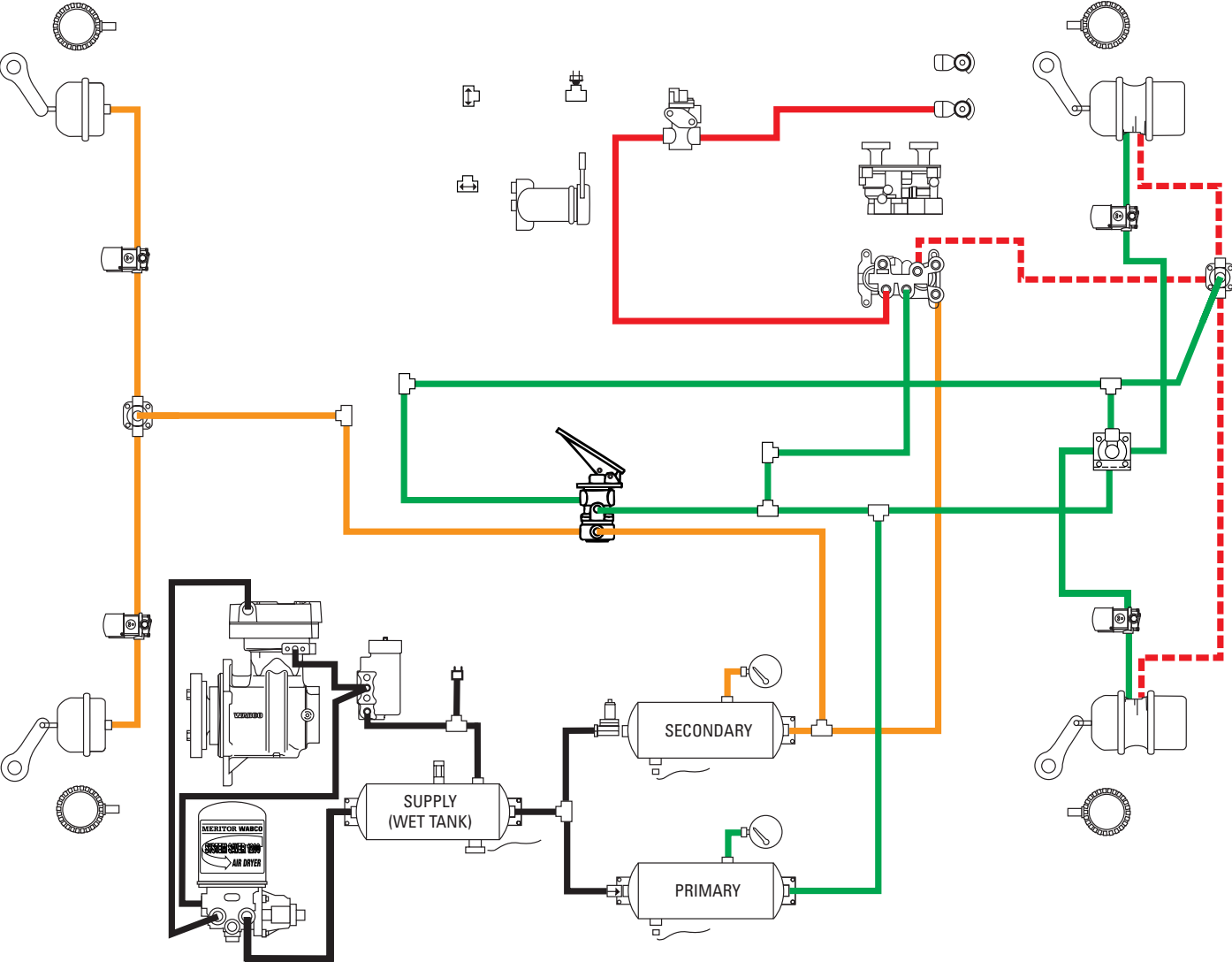

# Tractor Trailer Control System

**MERITOR WABCO**

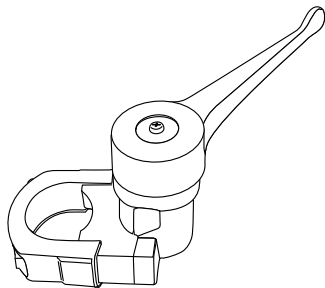

**Hand Control Valve** \_\_\_\_\_

---

---

---

---

---

---

---

---

---

---

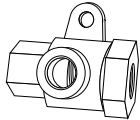

**(2) Two-Way Check Valves** \_\_\_\_\_

---

---

---

---

---

---

---

---

---

---

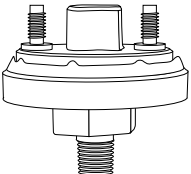

**Stoplight Switch** \_\_\_\_\_

---

---

---

---

---

---

---

---

---

---

# Tractor Air System Complete

**MERITOR WABCO**

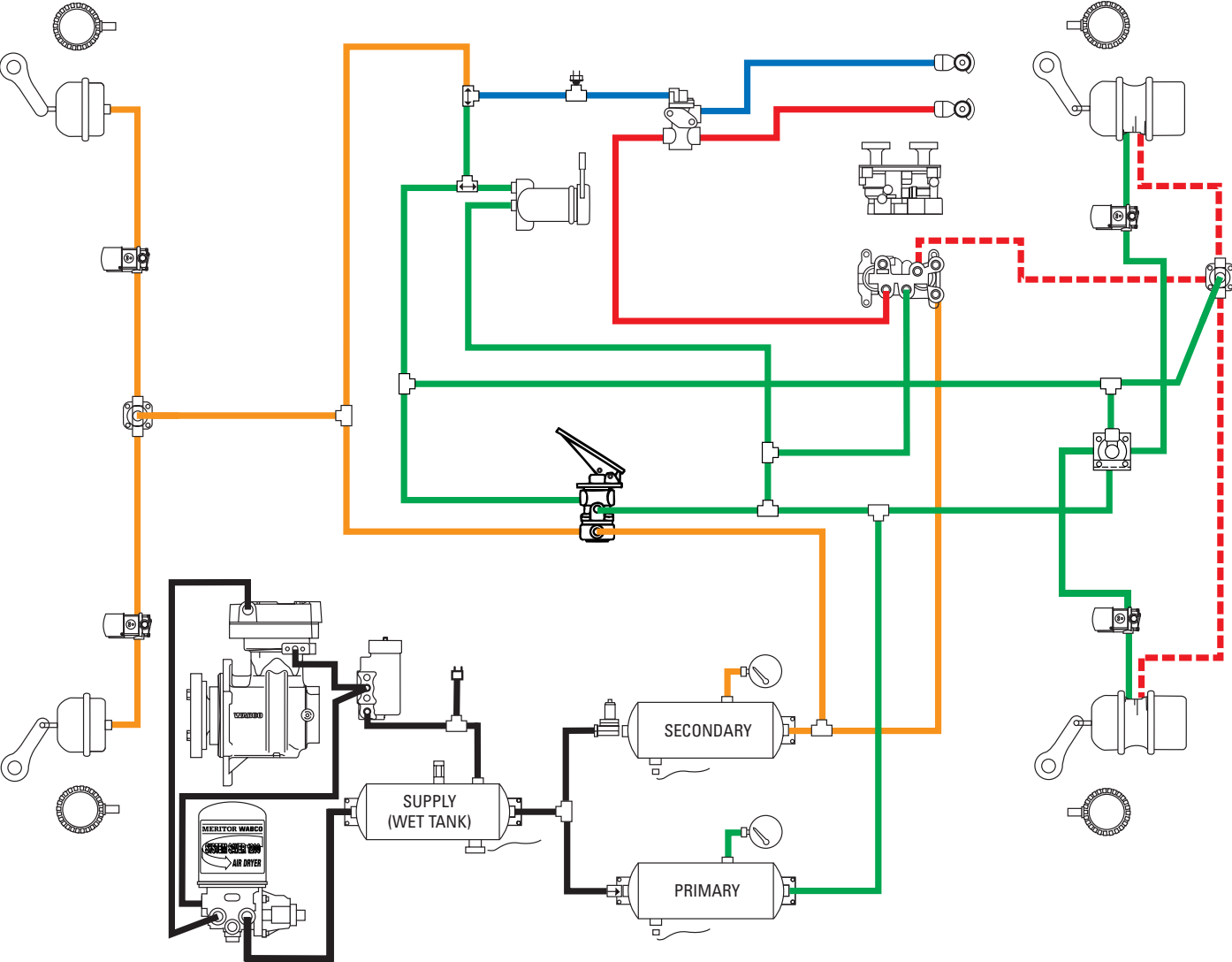

# Tractor Self Test

**MERITOR WABCO**

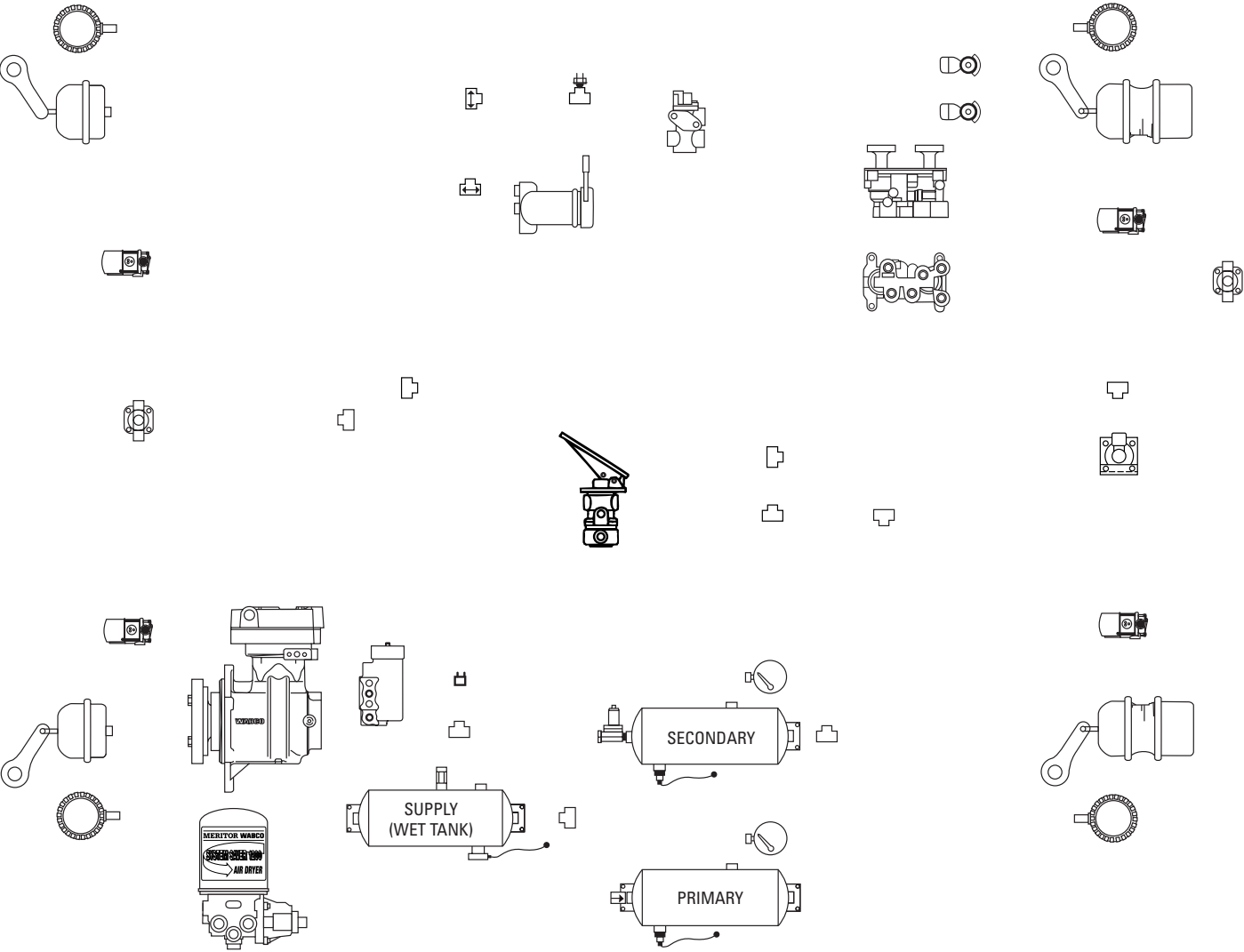

**ArvinMeritor**<sup>™</sup>  
Commercial Vehicle Systems

**Meritor WABCO**  
Vehicle Control Systems  
3331 West Big Beaver Road, Suite 300  
Troy, MI 48084 USA  
800-535-5560  
meritorwabco.com



Information contained in this publication was in effect at the time the publication was approved for printing and is subject to change without notice or liability. ArvinMeritor Commercial Vehicle Systems reserves the right to revise the information presented or discontinue the production of parts described at any time.

Copyright 2004  
ArvinMeritor, Inc.  
All Rights Reserved

Printed in the USA

TP-20141  
Revised 01-04  
16579/24240