

Metal Hydride Compression

PI: Terry Johnson (*Sandia National Laboratories*)

Team: Anne Mallow (*Sandia National Laboratories*)

Robert Bowman, Barton Smith, Lawrence Anovitz
(*Oak Ridge National Laboratory*)

Craig Jensen (*Hawaii Hydrogen Carriers, LLC*)

March 28, 2018

Project ID PD138

This presentation does not contain any proprietary, confidential, or otherwise restricted information

Overview

Timeline

- Project Start Date: 10/01/16
- Project End Date: 09/30/19

Budget

- Total Project Budget: \$1.8M
 - Total Recipient Share: \$180K
 - Total Federal Share: \$1.62M
 - Total DOE Funds Spent*: \$805K

* As of 3/31/18

Barriers – Hydrogen Delivery

B. Reliability and Costs of Gaseous Hydrogen Compression

Partners

- Lead: Sandia National Laboratories
- Hawaii Hydrogen Carriers, LLC
- Oak Ridge National Laboratory

Relevance: H₂ compressors dominate station costs and downtime

Compressors represent 48% of total station cost

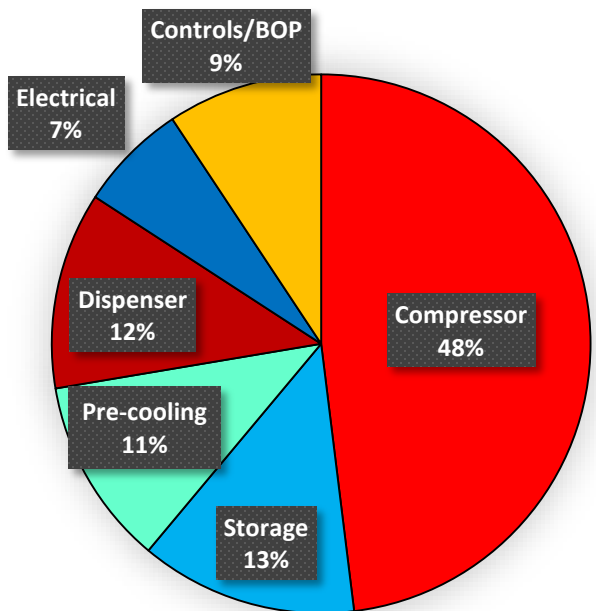

Compressors are 2nd largest contributors to maintenance hours

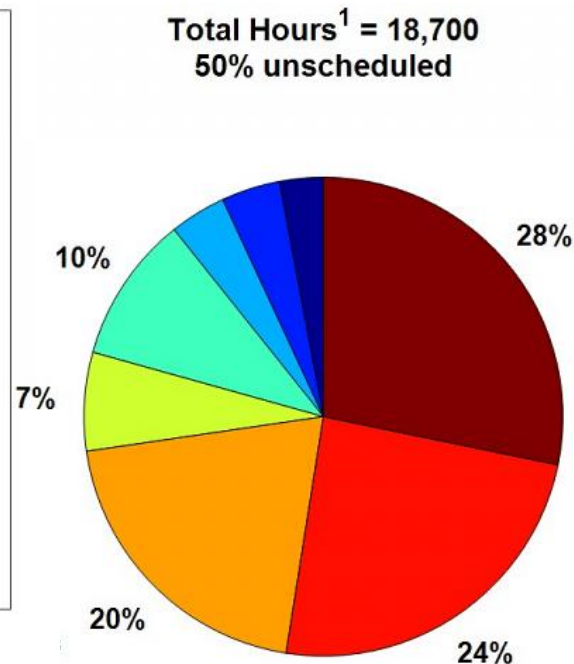
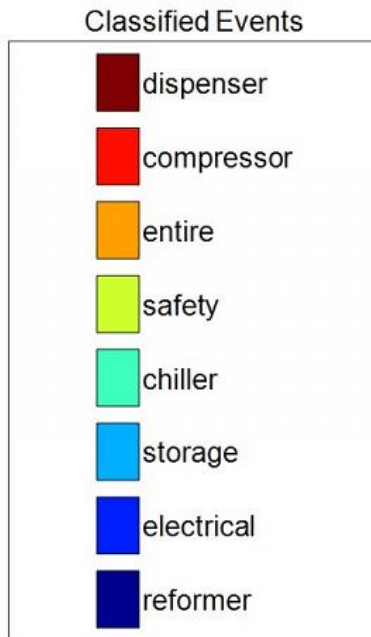

700 bar station cost distribution

Assuming gaseous tube trailer delivery

Source: HDSAM <https://hdsam.es.anl.gov/index.php?content=h>

Source:

NREL Composite Data Products, 2017

<https://www.nrel.gov/hydrogen/assets/images/cdp-infr-21.jpg>

Relevance: Metal hydride compression can improve reliability of 700 bar refueling

Main Objective – *Demonstrate a two-stage metal hydride compressor with a feed pressure of 50-100 bar delivering high purity H₂ gas at 1 kg H₂/hr at an outlet pressure of 875 bar.*

- Demonstrate an increase in the TRL of this technology from 2 to 5
- Enable the development of a comprehensive cost analysis for a production system scaled to 100 kg H₂/hr
- Objectives (4/17 to 4/18):
 - Down select to one metal hydride alloy for each stage that meet system level requirements based on laboratory characterization
 - Complete detailed design of prototype compressor beds for both stages based on trade studies
 - Demonstrate a compressor design that can achieve an energy consumption of < 4.0 kWh/kg-H₂ under 100-875 bar operation using a system-level compressor model

Approach: Two-stage Metal Hydride Compressor

- Two-stage metal hydride compressor
 - Feed pressure 50-100 bar
 - Outlet pressure ≥ 875 bar
 - High purity H₂ gas
- Optimized material for each stage
 - 2-3 candidates per stage will be characterized (thermodynamics, kinetics, and hydrogen capacities) to determine optimum design
- Each stage consists of multiple (2-3) hydride beds
 - synchronized hydrogenation & dehydrogenation cycles
 - size and number of beds will be optimized for continuous pumping at desired pressure with minimal heat input

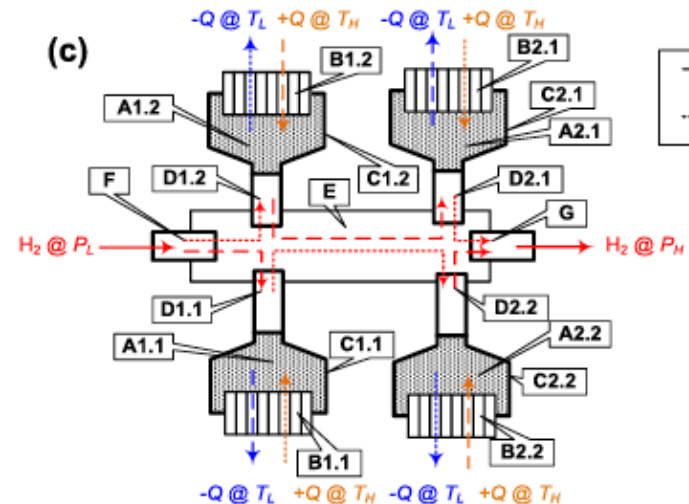
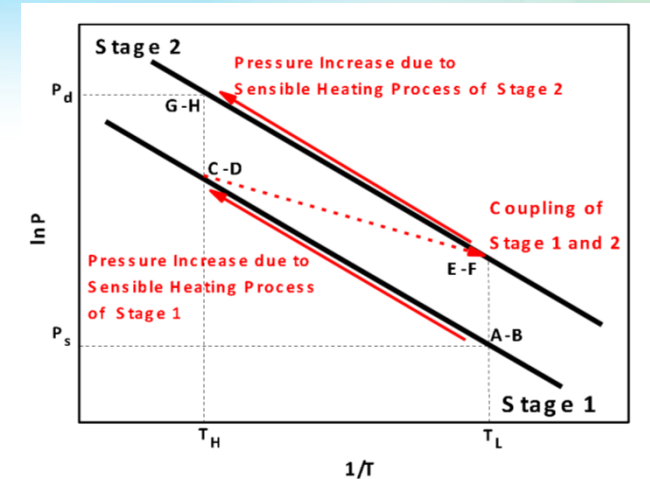

Approach: Experimentally demonstrate a scalable system with path to DOE targets

	Inlet pressure (Pipeline)	Outlet Pressure	Flow rate (peak)	Uninstalled Capital Cost	Maintenance Costs (Annual)	Lifetime
FY 2020 Targets	100 bar	950 bar	100 kgH ₂ /hr	\$275K	4% of installed cost	10 years

Path to Targets

- **Pressure:** Literature research to choose candidate alloys; Characterization to verify PCT relationships; Prototype operation to demonstrate synchronized desorption/absorption cycles
- **Flow rate:** Literature research and characterization to provide cycling kinetics; modeling to predict expected flow rate; prototype operation to validate model prediction
- **Costs:** Capital cost estimate from techno-economic analysis based on prototype scaled to 100 kgH₂/hr; maintenance costs based on extrapolation of prototype operation
- **Lifetime:** Based on alloy degradation assessments

Approach: Develop an innovative bed design to maximize performance/energy efficiency, minimize cost

- Performance (pressure lift and flow rate):
 - Design for temperature uniformity during exothermic/endothermic conditions
 - Optimization of bed geometry/heat exchanger and heat transfer enhancements
 - Minimize pressure gradients within the bed through engineered flow paths, packing density and vessel aspect ratio
 - Use modeling to demonstrate effect on performance
- Energy efficiency (kWh/kg H₂):
 - Minimize heating/cooling required per kg H₂ through low ΔH materials, minimal heat loss to vessel and surroundings
 - Achieve a balance between heat transfer and pressure drop for liquid cooling/heating
- Cost
 - Minimize mass of hydride through high utilization of high capacity material
 - Minimize structural materials through material choice and vessel/manifold design
 - Design to maximize ease of fabrication and assembly
 - Limit BOP components through simple system design

Approach: Leverage/collaborate with related projects

- PD137 Hybrid Electrochemical-Metal Hydride Compression (Greenway Energy)
 - Both projects include a high pressure metal hydride stage
 - Collaboration topics: Material selection, high pressure instrument design, characterization techniques
 - Shared materials lists and intend to share materials and instruments if necessary/beneficial
 - Several meetings and e-mail contact over the last year.

- PD171 (SBIR/STTR Phase 1): Metal Hydride Material Development for High Efficiency and Low Cost Hydrogen Compressors
 - Performed cost analysis based on DOE target system requirements (100-875 bar, 100 kg/h)
 - Found net present value comparable when electricity costs are included
 - Assumed waste heat available

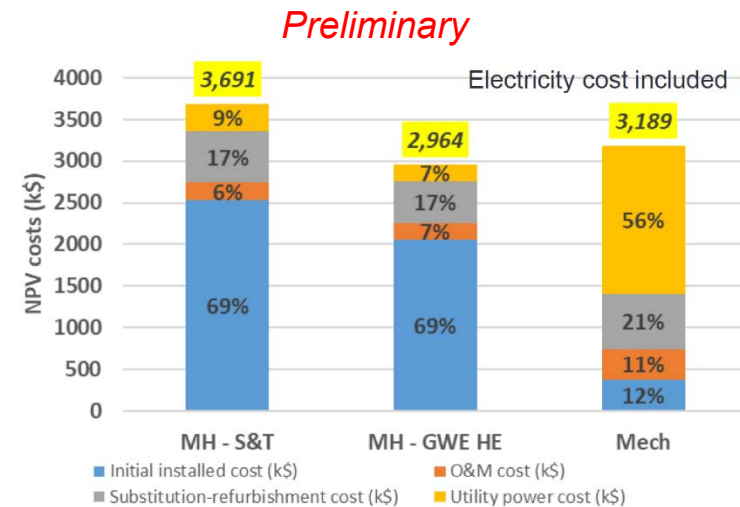

Approach: Status of Milestones

Type	Milestone Number	Milestone Description	Scheduled Date	Status
Milestone	2.1	At least two candidate alloys identified for both LP and HP	12/16	100%
Milestone	2.2	At least two LP and HP materials fully characterized	12/17 (revised)	75%
Milestone	3.2.1	Desired effective thermal conductivity determined along with additive type and amount.	7/17	100%
Go/No-Go Decision Point	Go/No-Go #1	Laboratory characterization demonstrates the ability of two metal hydride alloys to compress hydrogen from 100 bar to 875 bar, and engineering simulations using the system-level compressor model reasonably predict that the compressor can achieve an energy consumption of < 4.0 kWh/kg-H ₂ under 100-875 bar operation relying on innovative heat pump cycle.	2/18 (revised)	100%
Milestone	6.1	Detailed design complete	1/18	100%
Milestone	7.1	Receipt of complete lots of both the LP and HP alloys by 17th month to allow time for processing into powders and confirmation of hydrogen absorption/desorption parameters while the bed assemblies are being fabricated.	3/18	50%
Milestone	7.2	Completed assembly of 2-stage compressor with at least two each LP and HP compressor beds	7/18	0%
Go/No-Go Decision Point	Go/No-Go #2	One LP and one HP hydride must show degradation less than 20% of initial capacity over ~1000 cycles or regeneration potential.	8/18	0%

Accomplishments: Hydralloy C5 selected for LP stage based on performance and availability

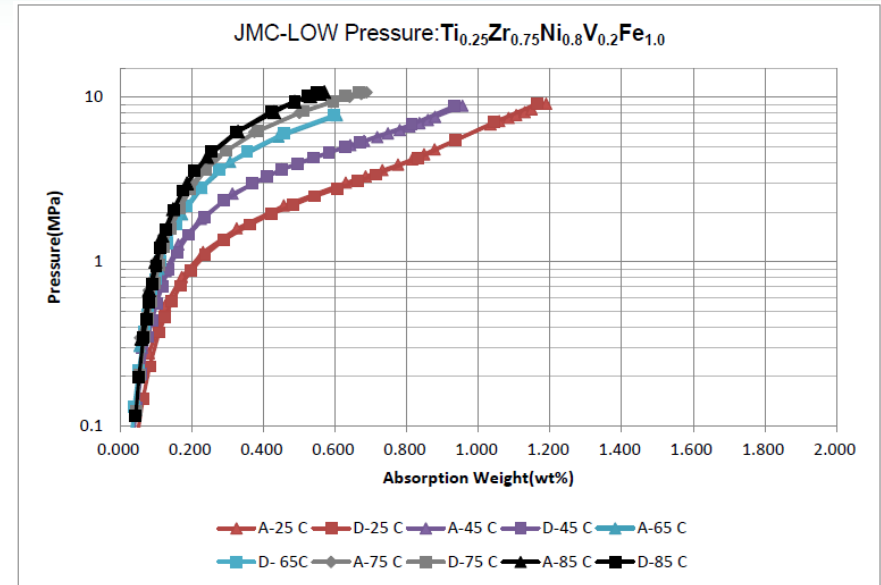
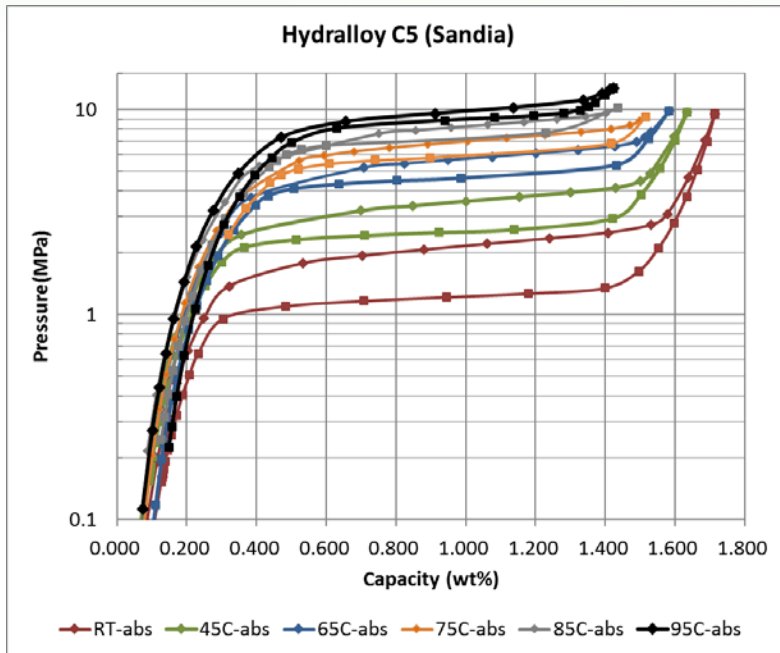

- Isotherms measured at HHC of Hydralloy C5 show promise for low pressure stage
- Sandia has ~100kg in inventory

- Second LP candidate produced by JMC
- Highly sloping isotherms
- Potentially due to lack of annealing

Accomplishments: First HP candidate measured with ORNL system; second alloy in progress

- Custom apparatus capable of measurements up to 1000 bar and >150 °C
- Absorption isotherm shows that this alloy would easily be filled by our low pressure stage
- Desorption pressure from the alloy was measured up to 180 °C displaying desorption pressures in excess of 875 bar

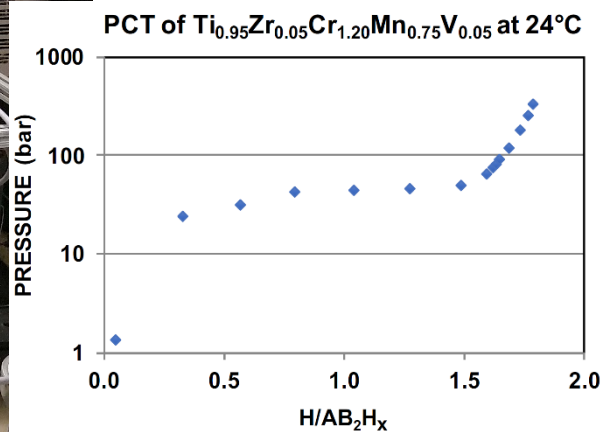
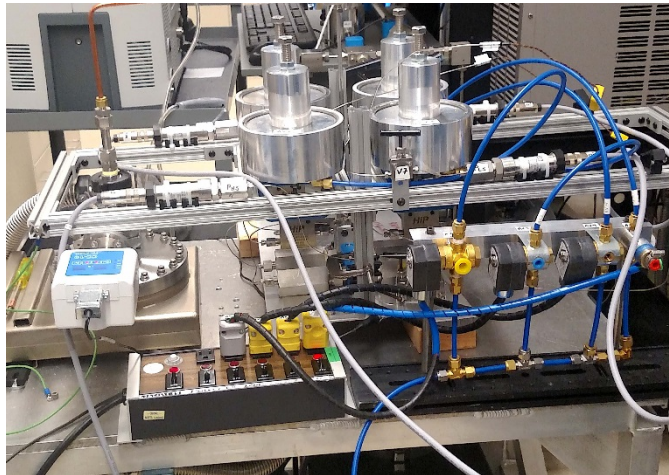

Absorption isotherm at 24 °C

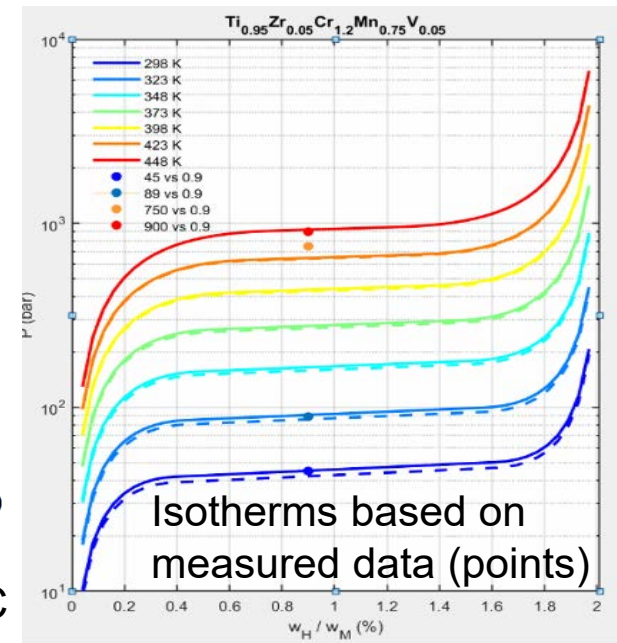

Accomplishments: Trade study identifies design with best efficiency, manufacturability, and heat transfer

	External HX	Internal HX			
	Shell and Tube	Carbon Fiber Composite	External Manifold	Internal Manifold	Helical Coil
Energy Efficiency	Red	Yellow	Yellow	Yellow	Green
Manufacturability	Yellow	Red	Yellow	Yellow	Green
Hydride Loading	Green	Red	Yellow	Yellow	Yellow
Thermal Design	Green	Yellow	Yellow	Yellow	Green
HTF Pressure Drop	Green	Green	Green	Green	Red
Low Cost	Green	Red	Yellow	Red	Yellow

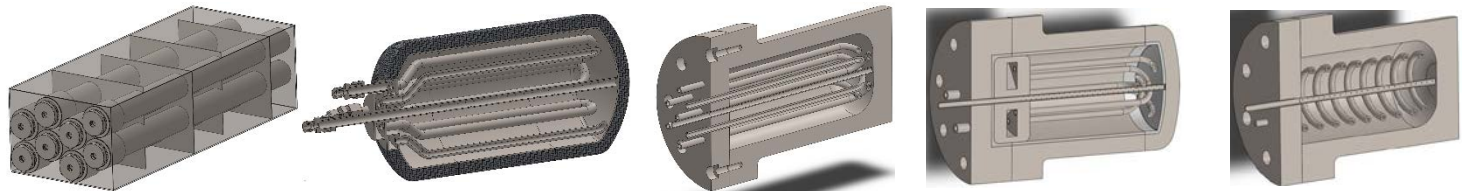

Accomplishments: Bed design based on helical tube heat exchanger maximizes performance and energy efficiency

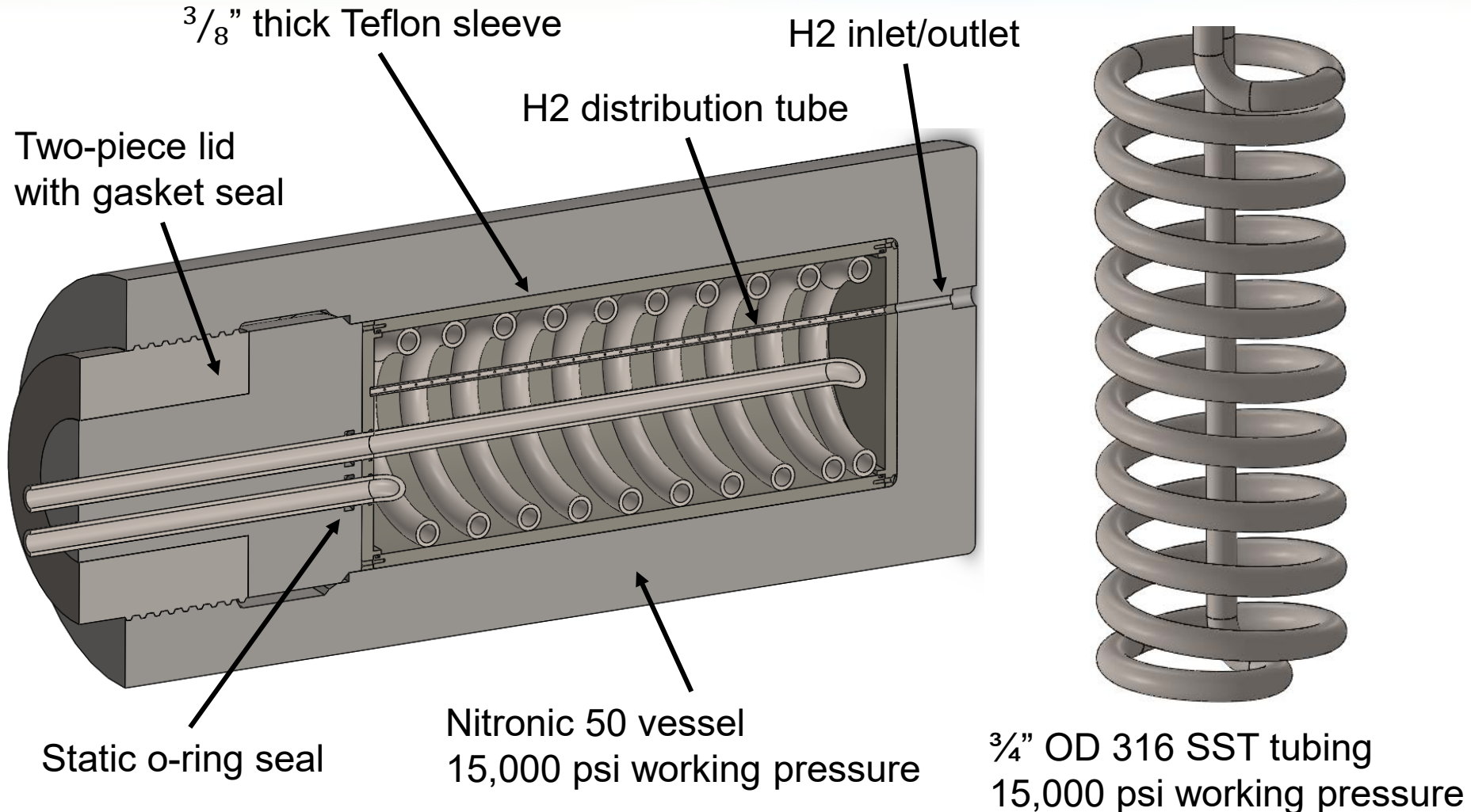

Accomplishments: Thermal management achieved through compacted metal hydride - graphite mixture

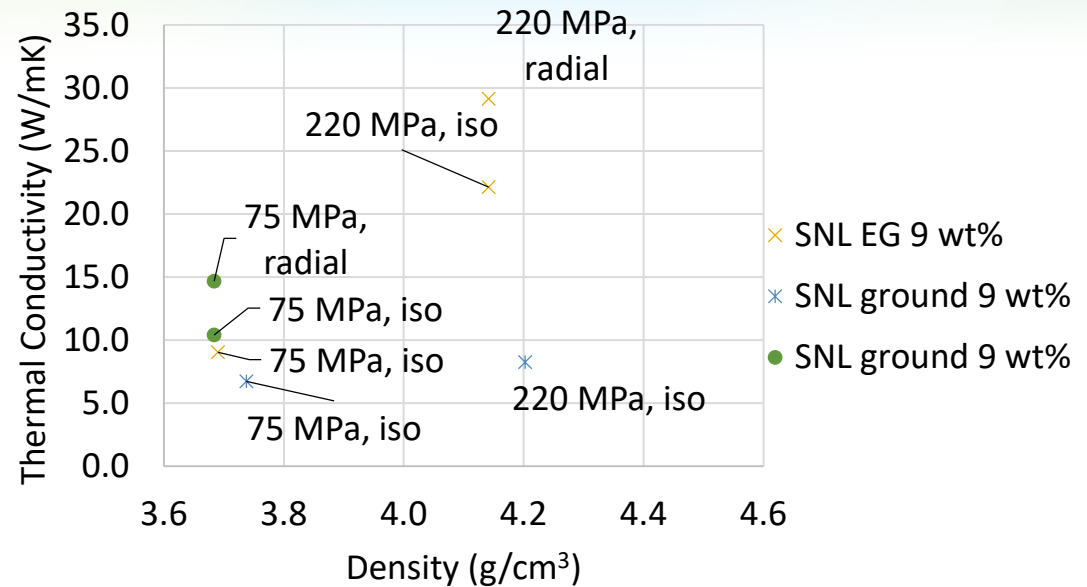

- ENG and graphite flake mixed with Hydralloy C5 at 9 wt%
- Compacted at 75 and 220 MPa
- Thermal conductivity measured using hot disk method
- Based on work by Pohlmann, et al (Dresden University, DLR)

Accomplishments: Designed bed loading procedure with compacted metal hydride/graphite composites

Two custom die sets produce pellets that conform to internal geometry

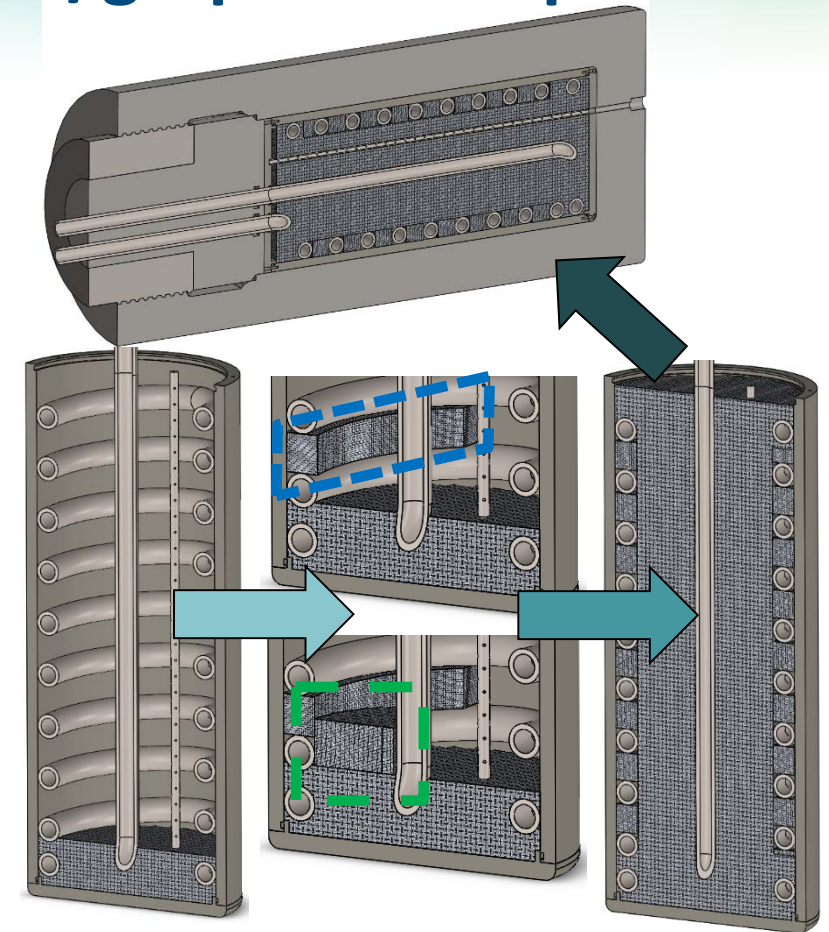
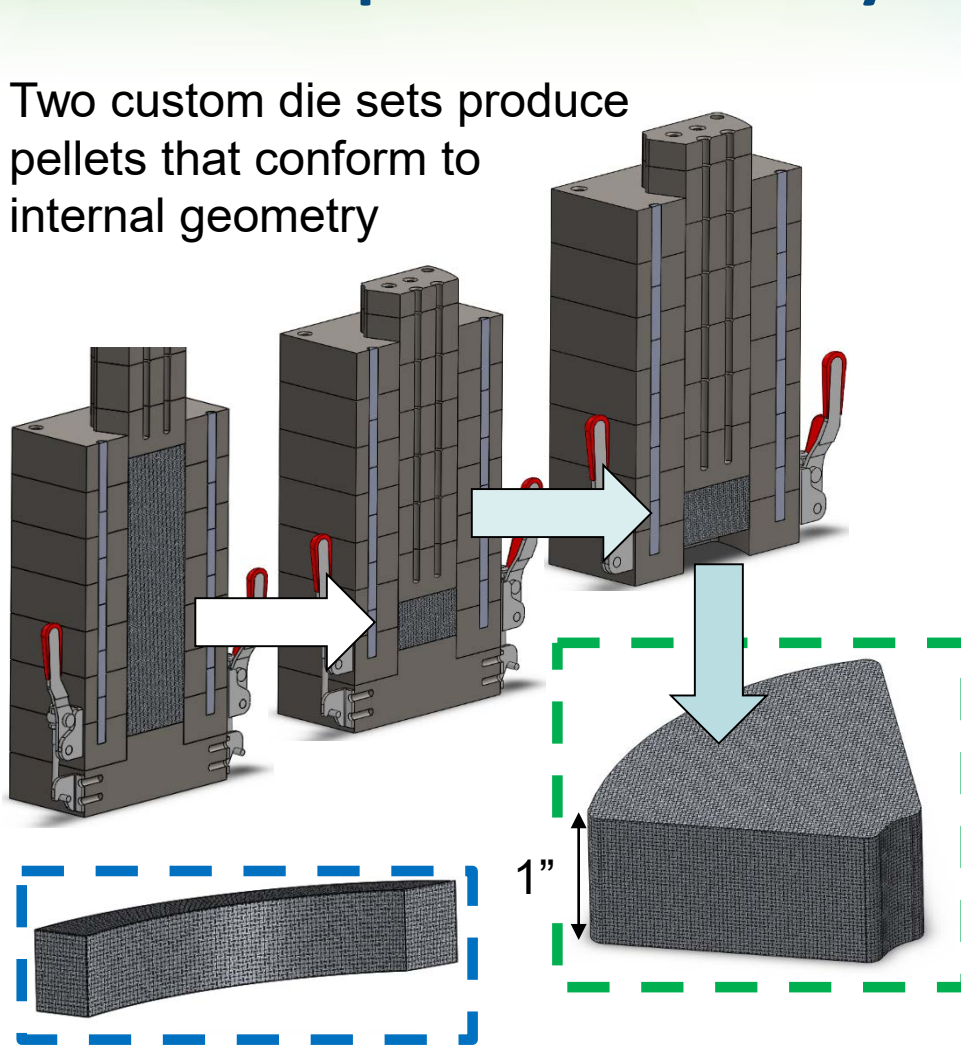

Loading consists of manual compaction and insertion of pre-compressed pellets within insulating liner

Accomplishments: High pressure manifold designed for closed loop hydrogen recirculation

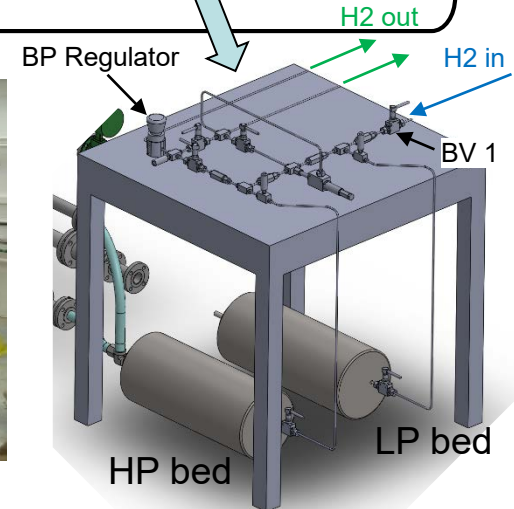
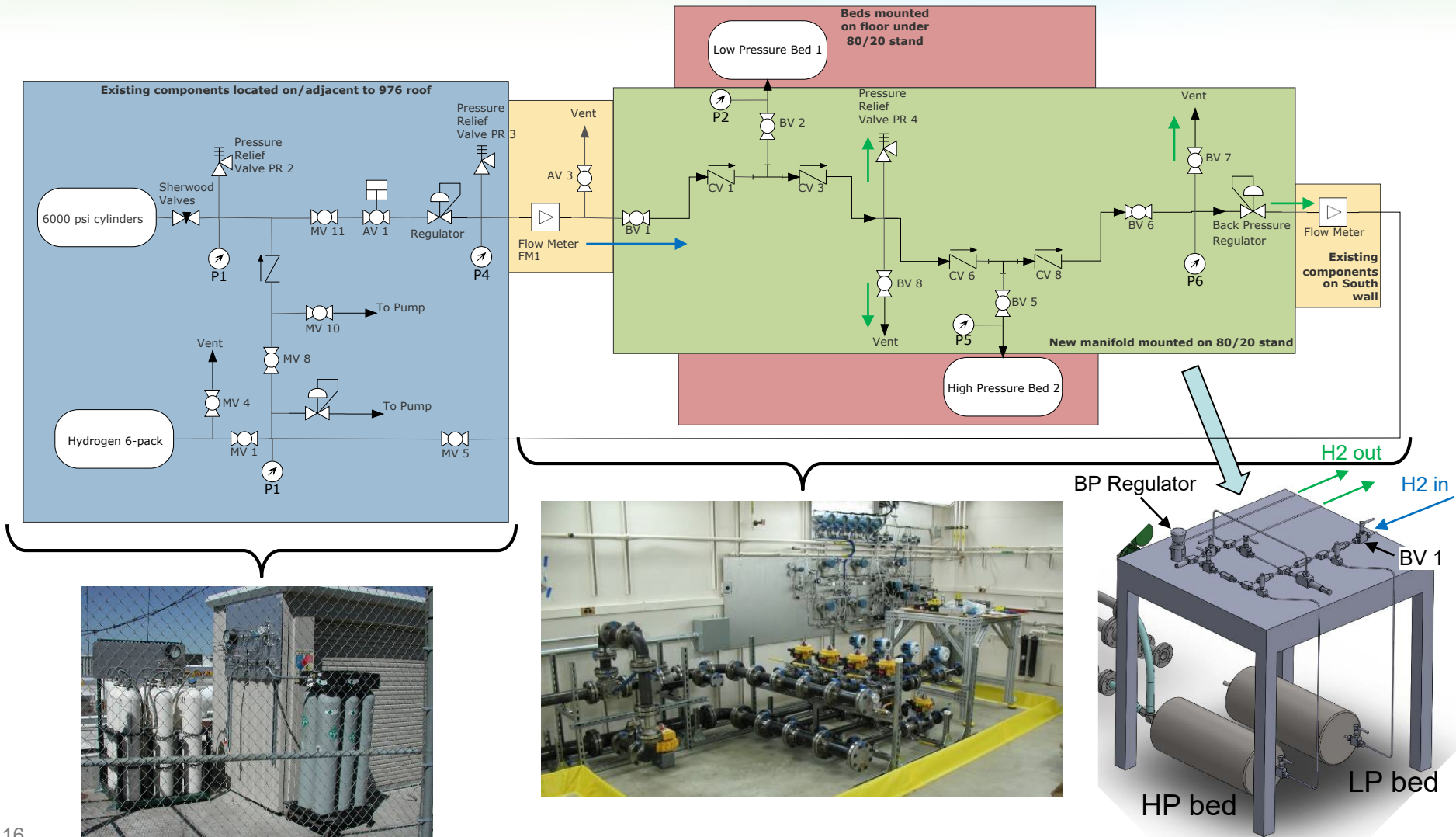

Accomplishments: Completed design for temperature control system

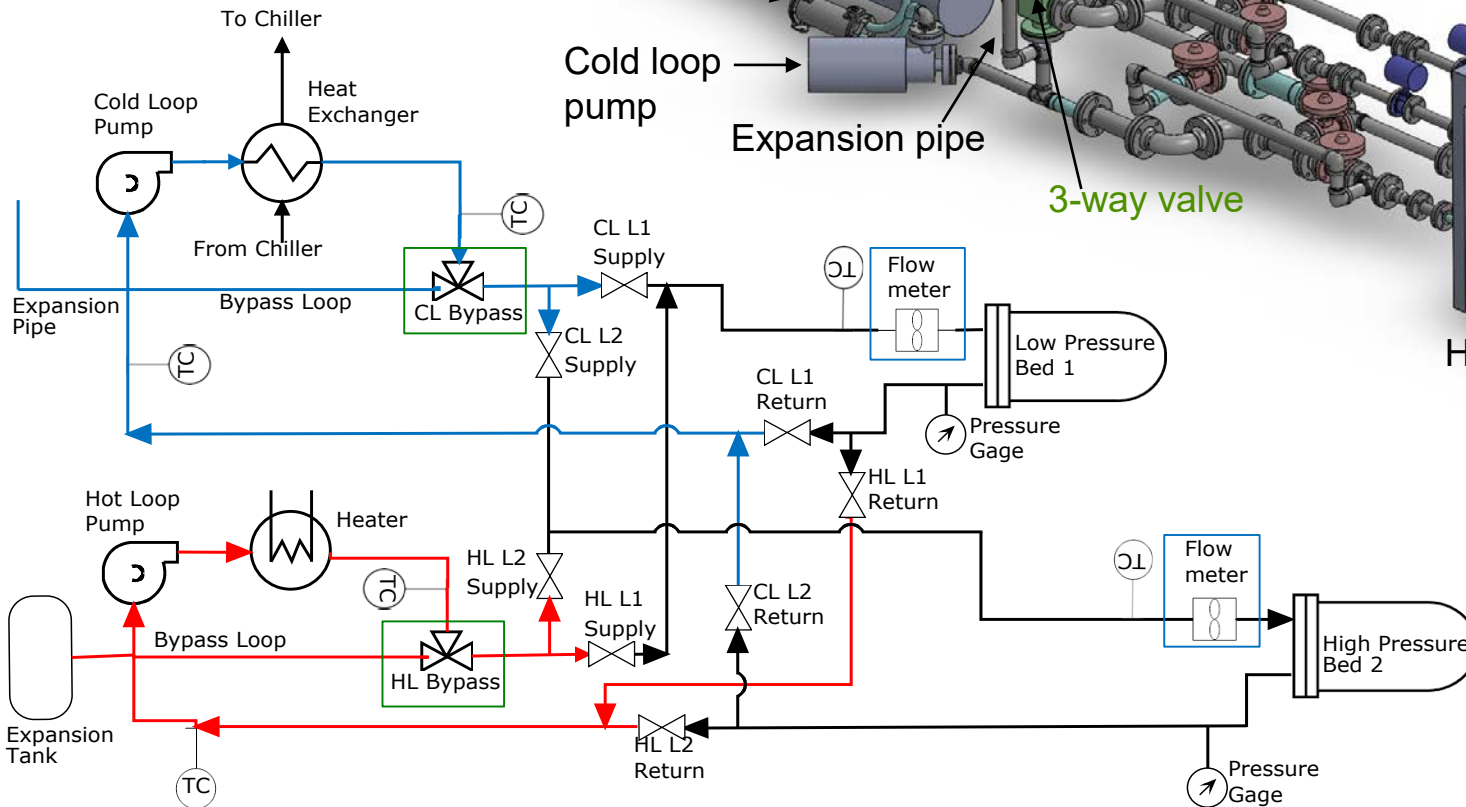
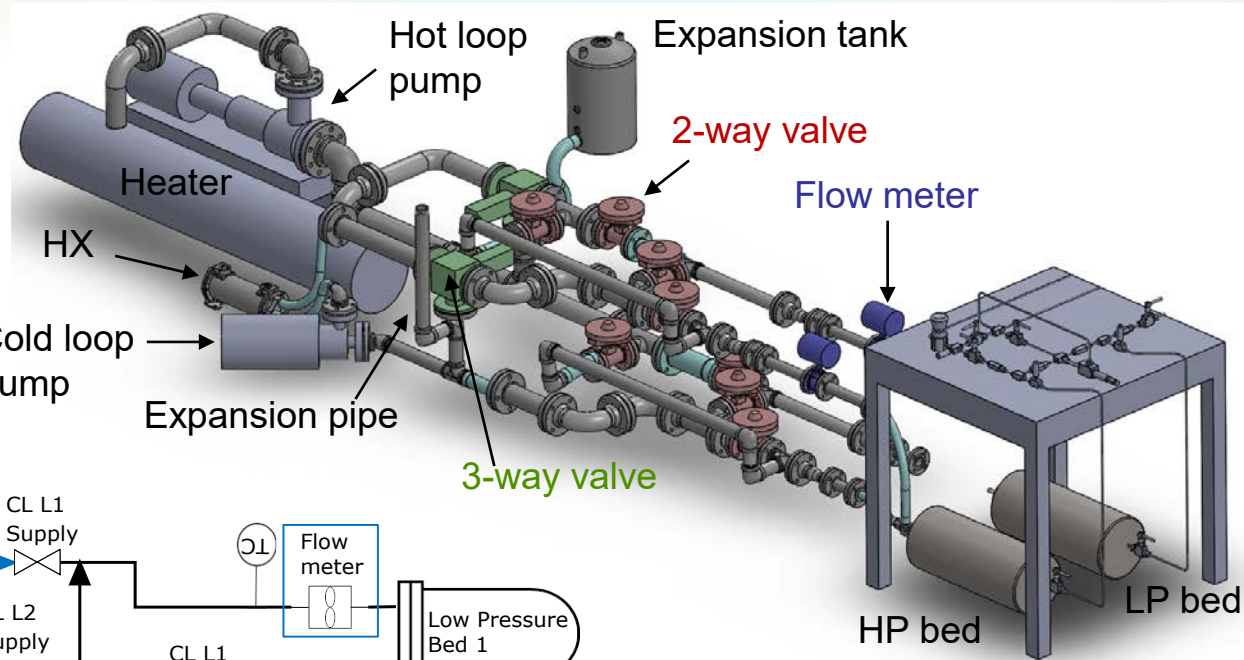

Accomplishments: Dynamic system model predicts performance using measured alloy properties

Configuration:

- 25 kg of LP hydride (Hydralloy C5)
- 21.7 kg of HP hydride (Ti_{0.95}Zr_{0.05}Cr_{1.20}Mn_{0.75}V_{0.05})
- 15-20 minute half cycles
- 100 to 875 bar compression
- Heating/cooling of beds with heat transfer fluid
 - Cold loop temperature set to 60 °C
 - Hot loop temperature set to 190 °C

Results:

- Utilization = 61% for all beds
 - $Utilization = \frac{Hydrogen\ delivered}{Storage\ capacity}$ 
- 0.87 kg/hr average flow rate
- Energy usage for heating 10.7 kWh/kg H₂

Bed thermal response calibrated to detailed Comsol model

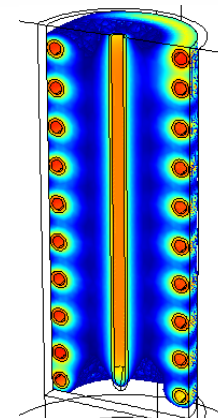
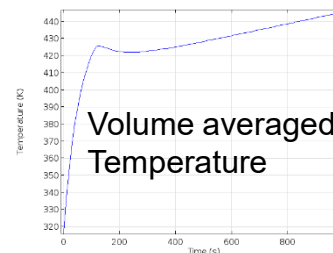

H₂ Delivery at 875 bar

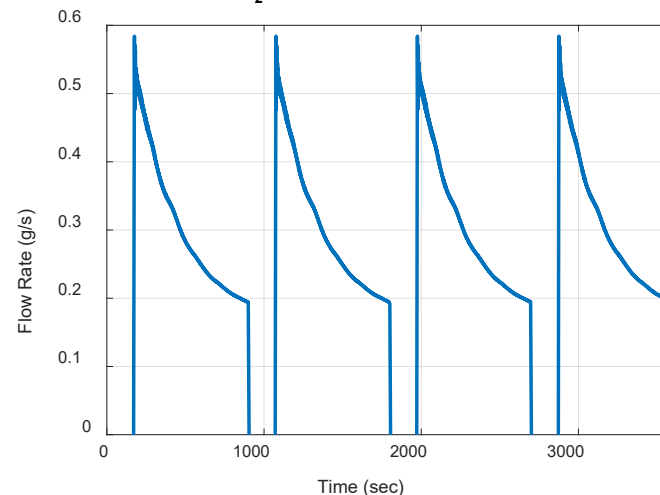

Accomplishments: Identified path to energy efficiency using high temperature heat pump (HTHP)/refrigerant

- Heat pump coefficient of performance
COP = Heat/Electrical Work
- COP of 2.7 needed to reduce energy consumption to 4.0 kWh/kg
- Many commercially available HTHPs supply temperatures up to 130 °C, some to 160 °C, for industrial process heat
- New refrigerants for HTHPs with very low global warming potential
 - e.g. Dupont’s R1336mzz-Z (T_c > 170 °C)
- Cascade heat pump system could reach target COP with 100 °C temperature lift
 - Kobelco HTHP operates from 35 °C to 90 °C with a COP of 5.8
 - HTHP operating from 85 to 135 °C with a COP of 4.1 gives net COP of 2.7

COP vs. temperature lift for commercial HTHPs

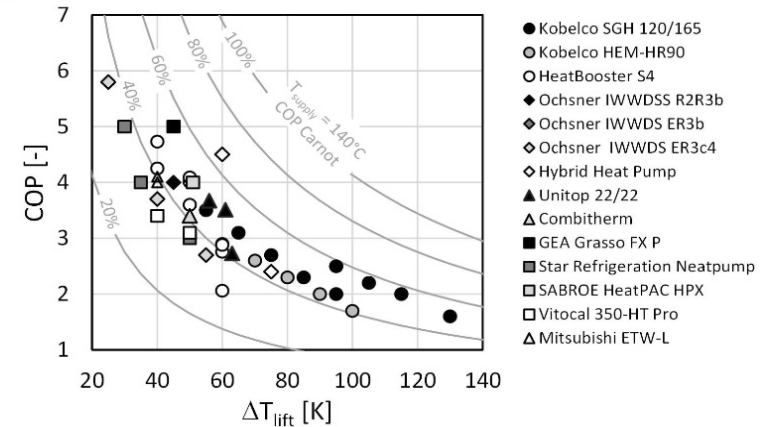

C. Arpagaus, et al, “Review on High Temperature Heat Pumps.” *Proceedings of the European Heat Pump Summit, Oct. 2017, Nuremberg, Germany.*

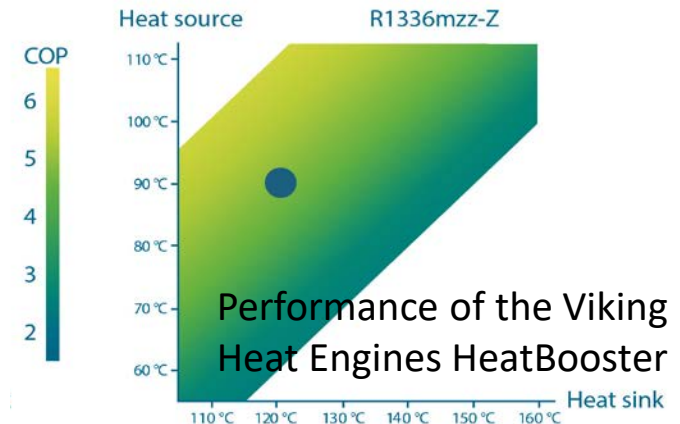

<http://www.vikingheatengines.com/heatbooster>

Accomplishments: Responses to Previous Year Reviewer's Comments

“The project’s efforts related to system modeling and cost analyses should be leveraging the extensive and thorough outputs of the Hydrogen Storage Engineering Center of Excellence (HSECoE), now available on the web. It seems that the project is attempting to reinvent the models.”

Zero models have been reinvented. HSECoE models were developed for on-board vehicle storage, not compressors. They were reviewed and referenced where deemed useful. Other models were leveraged (SNL and Purdue) for the system level compressor model.

“A detailed cost analysis is needed ... A solid cost estimate is needed before it even makes sense to consider taking this approach further. “

A detailed cost analysis is part of our FY19 project plan. In addition, results from the GreenWay Energy SBIR are directly applicable to this project.

“The project lacks a solid and persuasive argument about why this technology is an improvement over the metal hydride compressor systems that have been proposed and developed over the last several decades.”

Of all prior efforts, only a few hydride compressors have been able to generate pressure of 700+ bar, and these systems have been small scale benchtop systems. None have addressed barriers related to thermal management, continuous flow rate, scalability, or energy efficiency.

Collaborations: Experienced team well-suited for executing this project plan

- Sandia National Laboratories
 - Project lead/project management
 - Lead compressor bed and system design (system model, pressure vessel design, heat transfer enhancement)
 - Low pressure hydride degradation assessment
 - Experimental evaluation of the prototype compressor
- Oak Ridge National Laboratory
 - Hydride identification
 - High pressure hydride characterization and degradation assessment
 - Support SNL in developing compressor bed and system designs
- Hawaii Hydrogen Carriers, LLC
 - Low pressure hydride characterization
 - Hydride sourcing and procurement
 - Fabrication of the prototype 2-stage compressor
 - Cost analysis of the commercial system concept.

Remaining Challenges and Barriers

- Challenge: Achieve an energy consumption of < 4.0 kWh/kgH₂ with metal hydride compression from 100 to 875 bar
 - Metal hydride thermodynamics require 6-7 kWh/kgH₂ minimum for a two-stage compressor; sensible heating requirements and losses push this to ~ 10 kWh/kgH₂
 - Methods to reduce energy consumption (recuperator, waste heat, heat pump) or lower energy cost (cheap heat) are needed to meet DOE requirements
- Challenge: Identifying HP metal hydride alloy to compress hydrogen to 875 bar within reasonable operating temperatures with degradation less than 20% of initial capacity over ~ 1000 cycles or regeneration potential
- Challenge: Demonstrating a prototype design that can be scaled to 100 kg/hr and meet DOE cost targets

Proposed Future Work

Remainder of FY18

- Procure HP hydride alloy, compressor beds, and BOP components
- Process hydrides, mix with ENG and make compacts
- Load compressor beds, perform leak and pressure tests
- Configure test facility
 - Assemble, leak check, fill, and test operation of temperature control system
 - Assemble and leak check hydrogen manifold

FY19

- Integrate prototype compressor into test facility
- Activate hydrides and perform initial cycling to assess individual performance
- Test performance of prototype compressor over range of process conditions
- Perform cost analysis for a 100 kg H₂/hr system
- Final report detailing performance of compressor

Any proposed future work is subject to change based on funding levels

Technology Transfer Activities

Potential Follow-on Prototype Demonstration

- Discussions with HCATT/BESI on integration of the prototype system into BESI waste-to-energy system in Peal Harbor, HI or University Park, IL

Tech-to-Market Plan

- Two-year developmental phase
 - HHC will team with an electrolyzer, fueling station supplier, or reformer company to produce a scaled-up, commercial version of the compressor
 - Units will be marketed as upgrades for current hydrogen generation systems, or for localized H₂ production via renewable sources such as solar or wind for residential, businesses or small utility fleets.
- Final two-year phase
 - Further scale-up effort for the development and marketing of larger hydride compressors with output of 10 kg H₂/hr to 100 kg H₂/hr for hydrogen fueling stations

Summary

- A metal hydride compressor has potentially significant advantages over current technology
 - Greatly reduced operating costs
 - Requires little or no maintenance
 - Can be powered by waste heat rather than electricity
 - More Reliable: Simple design and operation with no moving parts
 - High purity H₂ delivery: Oil free operation
- Candidate alloys for low and high pressure stages have been characterized and show potential for 875 bar compression
- Detailed trade study used to select energy efficient bed design
- System-level analysis using final bed design and measured hydride properties demonstrates 875 bar H₂ delivery at reasonably achievable temperatures

TECHNICAL BACK-UP SLIDES

Two additional high pressure alloys to be measured at ORNL

Ti_{0.8}Zr_{0.2}Fe_{1.6}V_{0.4} (Ames)

- Low hysteresis, moderate slopes
- Installed in reactor 2/22/18
- Calculate that P_{des} = 60.3 MPa @ 90 °C

T.A. Zotov et al., Journal Alloys Compounds **509S** (2011) S839– S843

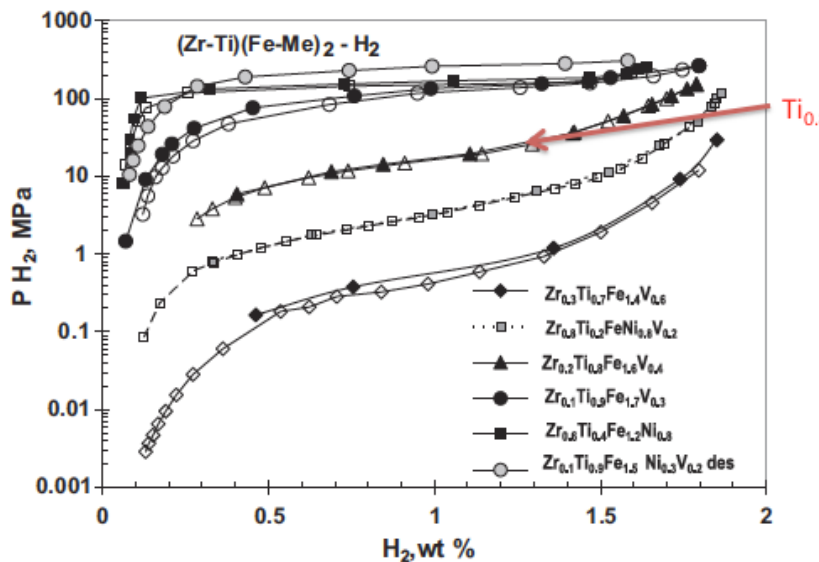

TiCrMn_{0.7}Fe_{0.2}V_{0.1} (JMC)

- Intermediate hysteresis, literature isotherms at < 20 °C
- HHC measurement showed high slopes and low capacity
- Ordered a new annealed sample from Ames Lab

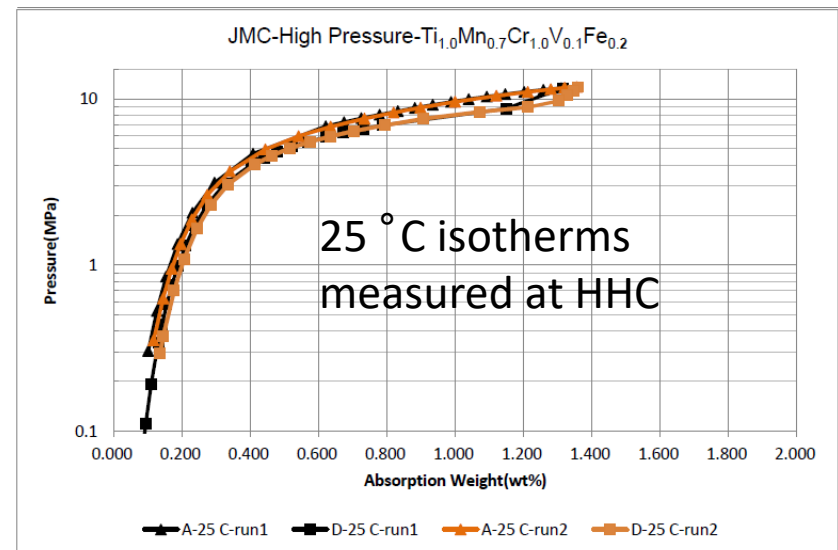

Several approaches identified to achieve energy efficiency/cost targets

- Heat recuperator design could reduce the sensible heat requirement of the system by ~40% bringing required heat down to ~10 kWh/kg
- Waste heat utilization:
 - Coupling to an SMR system is possible (heat available at appropriate temperature), but not likely in forecourt
 - Waste-to-energy systems identified with available, high quality heat
 - BESI system at HCATT has 190 kW of steam at ~180 °C and cooling water
- Low cost heat:
 - Natural gas burner can provide 10 kWh/kg of heat for about \$.25/kg
- Heat pump options:
 - VCC operating between 25 °C and 125 °C
 - Using R21 gives COP = 2.7 resulting in 3.7 kWh/kg
 - Using methanol gives a COP of 3.2 resulting in 3.1 kWh/kg
 - A natural gas-fired AHP system might produce a COP of ~1.4 with these temperatures requiring 7.1 kWh/kg of heat or \$.18/kg

Approach: Modeling used to assess performance as function of bed and system design parameters

• Desorption Simulation of LP Bed

- $T_{\text{fluid}} = 177^{\circ}\text{C}$ (heating), $T_{\text{fluid}} = 10^{\circ}\text{C}$ (cooling)
- $h_{c,\text{heating}} = 5000$ to 7500 $\text{W/m}^2\text{K}$
- $h_{c,\text{cooling}} = 1000$ to 3000 $\text{W/m}^2\text{K}$
- $k_{\text{eff, radial}} = 7.5$ to 15 W/mK

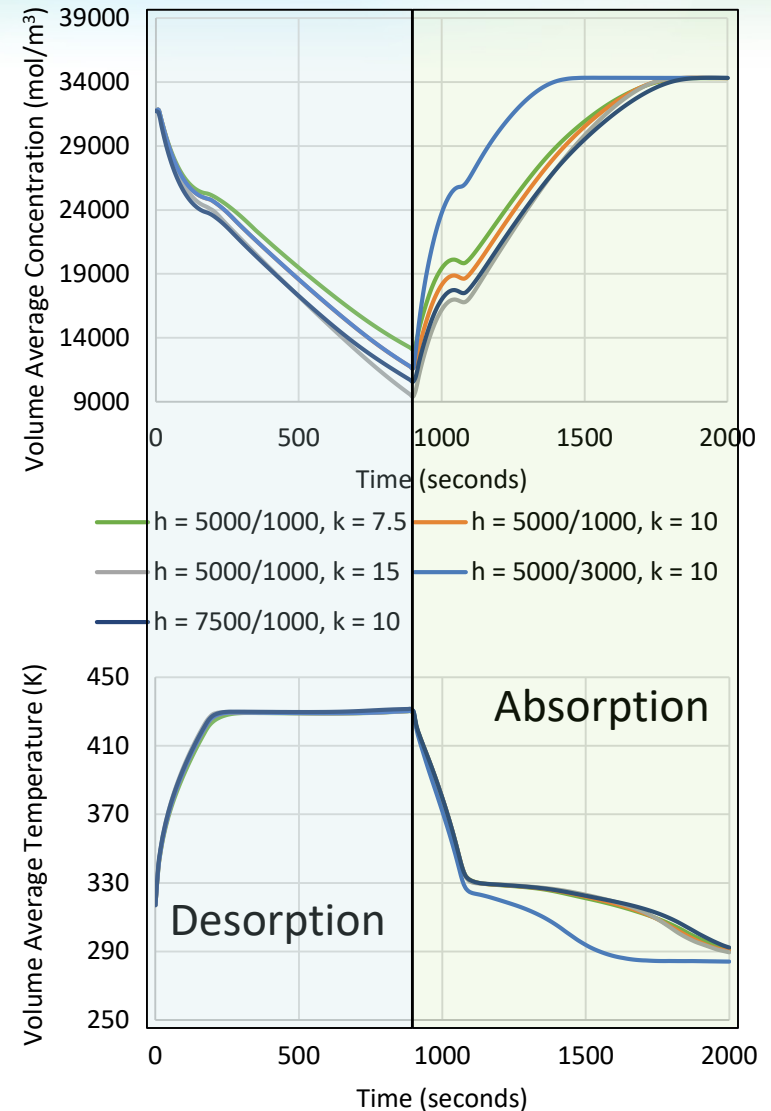
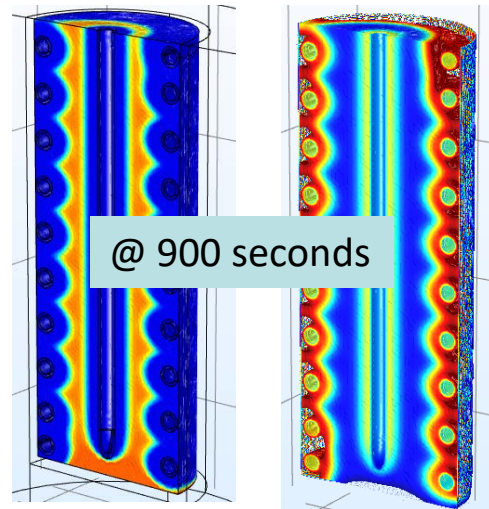
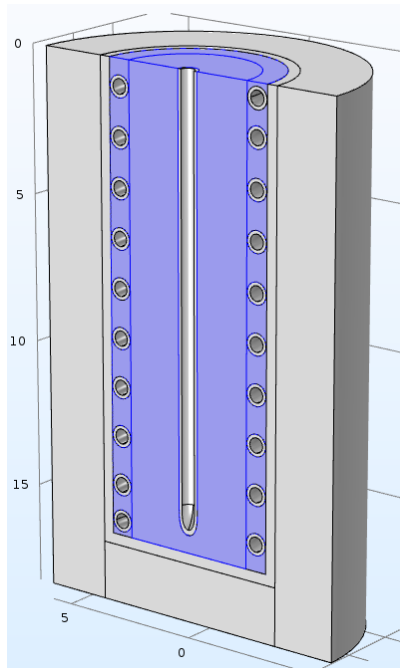

Approach: Dynamic system-level model used for feasibility and design trade studies

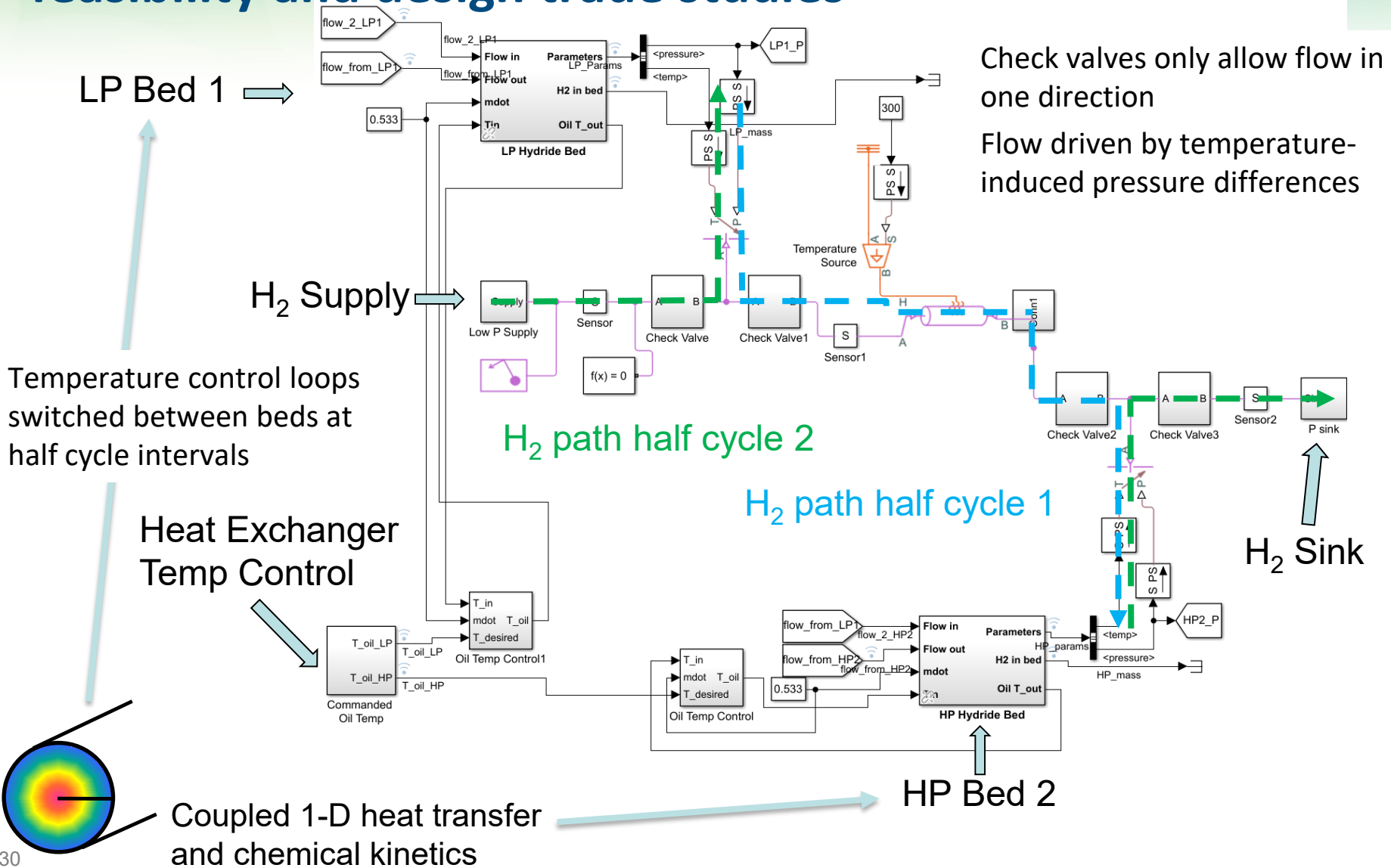

Heat pump could significantly improve energy efficiency

- Given condenser and evaporator temperatures and a candidate refrigerant, thermodynamic analysis gives heat pump COP
- COP is calculated as $(h_2 - h_3) / (h_2 - h_1)$
- VCC with methanol has potentially attractive thermodynamics
- Evaporator at 60 °C and 12 psia; condenser at 190 °C and 482 psia
- For methanol at these conditions, the COP is 2.63 for idealized system
- Energy consumption for the overall system is 4.06 kWh/kg
- However, actual COP may be closer to 2.0 given realistic compressor efficiency

Theoretical MeOH heat pump cycle

