



METALS, INC.

MANUFACTURED STEEL SINCE 1978

SHEET • STRUCTURAL • GRATINGS • WIRE • FIBERGLASS

Visit our website: www.metals-inc.com or call: 440.439.4799

Toll Free: 1.800.492.7304 • www.metals-inc.com • sales@metals-inc.com

185 Oakleaf Oval • Oakwood Village, Ohio 44146

PRODUCT CATALOG

EXPANDED



STAIR TREADS



PERF-O-GRIP



PERFORATED

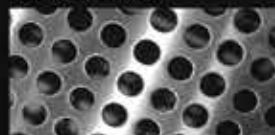

FIBERGLASS GRATING

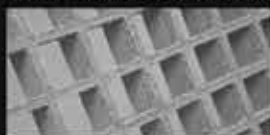

ROOFTOP SYSTEMS



BAR GRATING



GRIP STRUT GRATING



TRACTION TREAD FLOORING

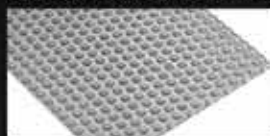

GRATE LOCK

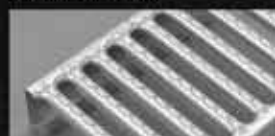

WIRE CLOTH

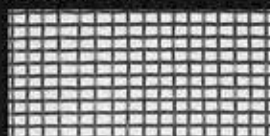

STRUCTURAL STEEL





Metals, Inc. is a service oriented organization specializing in the highest quality products at the most competitive prices. We provide immediate nationwide, as well as international, delivery from our extensive warehousing system.

Your inquiries are invited, please call!

Metals, Inc. will be happy to be of service to you now and in the future.



John Reuter
President

TABLE OF CONTENTS

Perforated Metals	2-6
Ordering Information	4
Expanded Metal	7-10
Carbon Flattened	7
Carbon Standard	8
Stainless & Aluminum	9
Expanded Grating Data	10
Bar Gratings	11-18
Glossary and Ordering/Specification Information	11
Welded Grating	12-13
Aluminum Grating	14
Heavy Duty Grating	15-16
Clearance/Anchoring Devices	17
Grating Stair Treads	18
Hex Metal Refractory Lining Specifications	19
Grip Strut Safety Gratings	20-22
Grip Strut Stair Treads	21
Heavy Duty Grip Strut	22
Perf-O-Grip™	23
Grate-Lock Grating	24
Traction Tread Flooring™	25
Woven & Welded Wire Cloth	26-33
Square Mesh Wire Cloth	27-30
Square Opening Wire Cloth	30-31
Vibrator Screens	32
Glossary of Terms/Ordering Information	33
Fiberglass-Reinforced-Plastic Gratings	34-36
Plastic Gratings	35-36
Hot Rolled Sheet	37
Carbon Steel Plate	38-39
Diamond Floor Plate	40
Pipe	41
Tubing	42-44
Square Tubing	42
Rectangular Tubing	43-44
Structural Channel and Ship & Car Channel	45
Standard I-Beam	46
Cold Rolled Bar	47-49
Cold Finished Flats	47-48
Cold Finished Rounds-1018	49
Cold Finished Squares	49
Hot Rolled Bar	50-51
Angle Iron	52-53
Rooftop Walkway Systems	54
Composite Floor Blocks	55
EasyStep Stair Systems	56

PERFORATED METALS

STANDARD PERFORATIONS

The flexibility of round, square, slot and other special perforations make it impractical to list every combination. For complete information, call Metals, Inc.

ROUND HOLES

Perforations	Centers	Holes per Sq. In.	Open Area	Line
.020"	—	625	20%	Staggered
.023"	—	576	24%	Straight
.027"	—	400	23%	Straight
.032"	—	324	26%	Straight
.040"	—	225	30%	Straight
.045"	—	225	37%	Straight
1/16"	1/8"	—	23%	Staggered
5/64"	7/64"	—	41%	Staggered
5/64"	1/8"	—	36%	Staggered
3/32"	5/32"	—	32%	Staggered
3/32"	3/16"	—	23%	Staggered
3/32"	1/4"	—	12%	Staggered
1/10"	5/32"	—	36%	Staggered
1/8"	3/16"	—	35%	Staggered
1/8"	7/32"	—	29%	Staggered
1/8"	1/4"	—	23%	Staggered
5/32"	7/32"	—	46%	Staggered
5/32"	1/4"	—	36%	Staggered
3/16"	1/4"	—	51%	Staggered
3/16"	5/16"	—	33%	Staggered
1/4"	5/16"	—	58%	Staggered
1/4"	3/8"	—	40%	Staggered
1/4"	7/16"	—	30%	Staggered
1/4"	1/2"	—	23%	Staggered
3/8"	1/2"	—	51%	Staggered
3/8"	9/16"	—	40%	Staggered
3/8"	5/8"	—	33%	Staggered
7/16"	5/8"	—	45%	Staggered
1/2"	11/16"	—	47%	Staggered
9/16"	3/4"	—	51%	Staggered
5/8"	13/16"	—	53%	Staggered
3/4"	1"	—	51%	Staggered

SQUARES

2/10"	1/4"	—	64%	Straight
1/4"	3/8"	—	—	—
3/8"	1/2"	—	56%	Straight
1/2"	11/16"	—	53%	Straight
3/4"	1"	—	56%	Straight
1"	1 1/4"	—	—	Straight
1"	1 3/8"	—	—	Straight

SLOTS

1/8" x 3/4"	41%	Side Staggered
1/8" x 1"	43%	Side Staggered

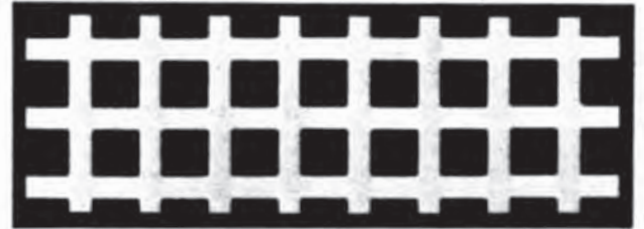
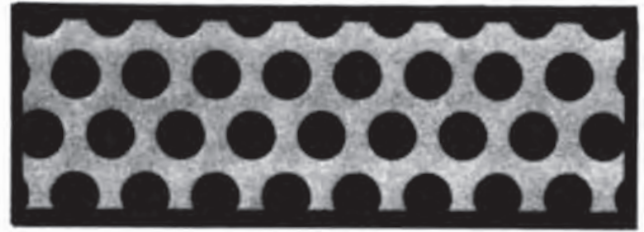

PURPOSE AND SCOPE

The standards published in this catalog are intended as a guide to designers, engineers and buyers of perforated metal.

The tolerances shown are not the ultimate and where closer tolerances are required, contact Metals, Inc. to discuss your specific design needs.

SHEET AND PLATE SIZE SPECIFICATION

Standard Stock Size Sheets and Plates — The width and length will be **standard mill shearing** plus any stretch of the material by perforating, unless otherwise specified. For carbon steel sheets or plates, tolerances as set by the American Iron and Steel Institute.

Sheets and Plates Resheared After Perforating —

Tolerances of the width and length will be:

For thickness lighter than 1/8" ± 1/32"

For thickness 1/8" to 3/16" incl. ± 1/16"

For thickness heavier than 3/16" to 1/2"

For thickness heavier than 1/2"—check with us.

If special re-square tolerances are required, call us.

Coiled Stock — Please submit specifications.

THICKNESS OF METALS

Steel — Use Manufacturers' Standard Gage for Steel Sheets (See Misc.)

Stainless Steel — Use the U.S. Standard Gage Table (See Misc.)

Monel — Use the U.S. Standard Gage Table (See Misc.)
Copper, Brass or Muntz — Use the B&S Gage Table. (See Misc.)

Aluminum — Use the B&S Gage Table. (See Misc.)



We accept
 Visa/MasterCard/American Express.

PERFORATIONS

Round Perforations — Staggered (60 degree pattern) is standard. Variations include 45 degree staggered, and Straight Line Pattern.

Square Perforations — Staggered Pattern or Straight Line Pattern.

Slotted Perforations — Side Staggered, End Staggered, or Straight Lines. Slotted Perforations will be round end slots; specify if square end slots are required.

Other Perforations — Please call us.

TYPES OF PERFORATIONS AVAILABLE

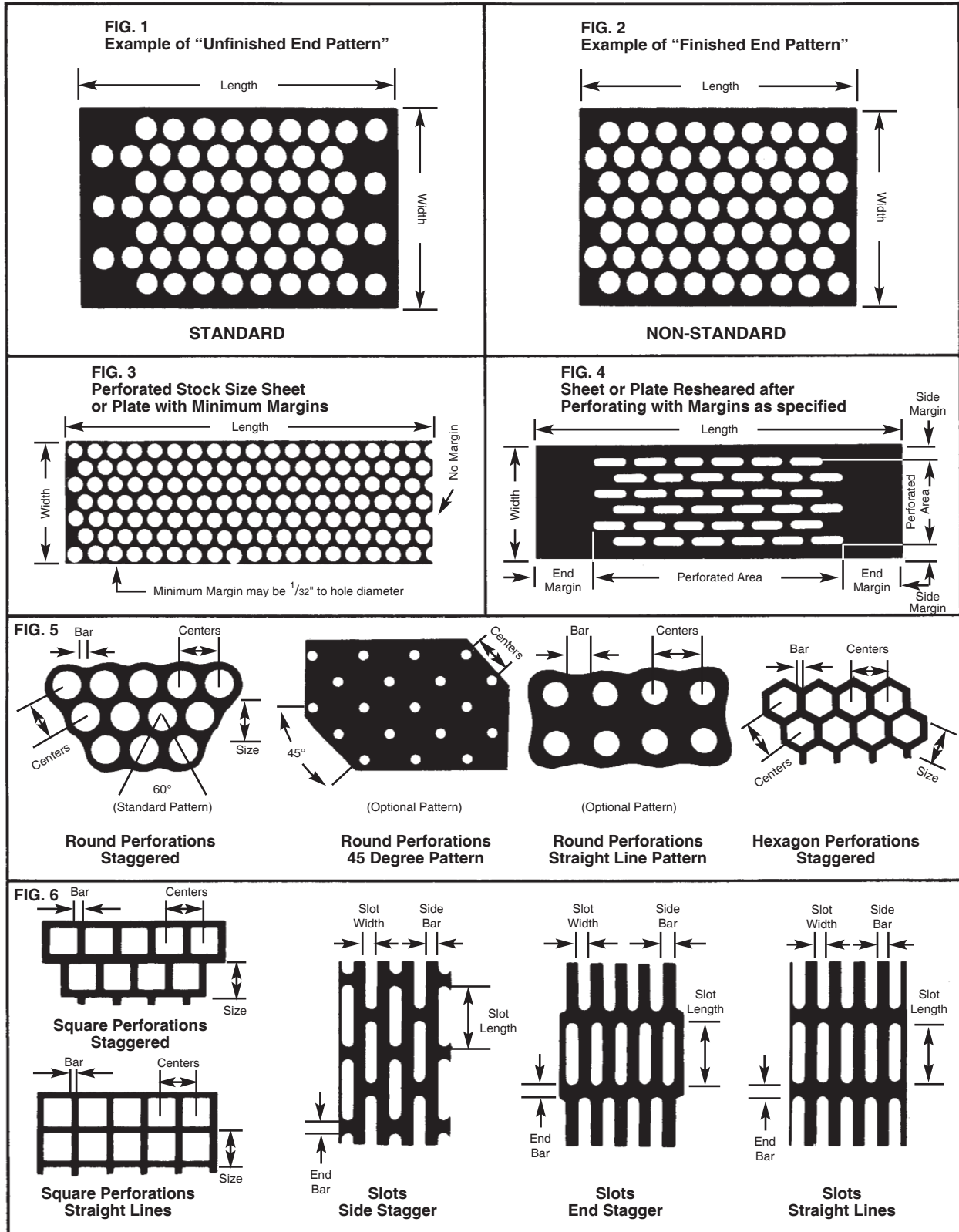

SPACING OF PERFORATIONS

Spacing for larger perforations will be designated by either **Centers** of perforations, or by the **Open Area** required. Spacing for small perforations will be designated by either **Centers**, or **Open Area**, or if more practical, by the **Number of Perforations to the Square Inch**.

PATTERN OF PERFORATIONS

Unfinished End Pattern — The condition which occurs with some specifications of staggered pattern perforations as a result of tool design. On one end of the plate, the pattern will appear to be incomplete due to unperforated holes in the even-numbered rows while on the other end of the same plate, the pattern will appear to be incomplete due to unperforated holes in the odd-numbered rows.

Finished End Pattern — The condition which occurs with some specifications of staggered pattern perforations as a result of tool design, where the pattern is completed on both ends of the plate.

Staggered Perforations, both Round and Square — Direction of the stagger will normally be the short dimension of the sheet, as illustrated in Fig. No. 3. Straight row of hole is normally parallel to long dimension of sheet.

Slotted Perforations — The long dimension of the slots can

be furnished parallel with either the width or length of the sheet in most cases. Check with us.

MARGINS

Perforated Stock Size Sheets and Plates — The long sides of the sheet will be supplied with minimum margins. The short sides of the sheet will have either minimum margins or no margins. (See Fig. 1)

Sheets and Plates Resheared after Perforating — Special margins are available to specifications but they must carry a tolerance within the limits of the perforating tool. (See Fig. 4) Unfinished end pattern is standard in the industry. (See Fig. 2 — Finished End Pattern, and Fig. 1 — Unfinished End Pattern.)

PERFORATING AND PROCESSING ONLY

If you are supplying the material, use the terminology "Perforating and Processing Only." All material so furnished must be of perforating quality.

Note — The **weight** of material furnished by the customer refers to the weight before perforating.

OTHER INFORMATION

If other work is required in addition to perforating, submit complete details including sketches.

ORDERING INFORMATION

FOR PERFORATED METALS

FLATNESS TOLERANCE OF SHEETS

(from AISI Steel Products Manual 5/70)

Hot Rolled Sheets — For Sheets Not Specified to Stretcher Leveled Standard of Flatness, including Pickled Sheets.

Cold Rolled Sheets — For Sheets over 12" in width not specified to Stretcher Leveled Standard of Flatness.

Thickness of Steel	Widths	Flatness Tolerance (Max. Deviation from a Horizontal Flat Surface)
16 ga. & heavier	To 60" incl.	1/2"
	Over 60" to 72" incl.	3/4"
	Over 72"	1"
17 ga. & lighter	To 36" incl.	1/2"
	Over 36" to 60" incl.	3/4"
	Over 60" width	1"

FLATNESS TOLERANCE OF PLATES

Thickness of Steel	Flatness Tolerance for Specified Widths				
	To 36" excl.	36" to 48" excl.	48" to 60" excl.	60" to 72" excl.	72" to 84" excl.
To 1/4"	9/16"	3/4"	15/16"	1 1/4"	1 3/8"
1/4" to 5/16" excl.	1/2"	5/8"	3/4"	7/8"	1 1/8"
5/16" to 3/8" excl.	1/2"	9/16"	5/8"	3/4"	7/8"
3/8" to 1/2" excl.	7/16"	1/2"	9/16"	5/8"	3/4"

The sizes and gages shown are those which are most commonly used.

- Specify number and dimensions of sheets, also indicate if we are to supply the material.

Unless otherwise specified the "length" will be the long dimension of the sheet.

For vibrating screens, the "width" is the dimension at right angles to the flow of material. The "length" is the dimension of the perforated screen plate that is parallel to the flow of material being screened. (See Figs. 1 & 2 on page 14)

If it is a cylindrical screen, state O.D. (outside diameter) or I.D. (inside diameter) and whether we are to roll to a butt or lap joint. If it is a section of cylindrical screen, state which dimension is to be the straight part of the screen. Specify number of segments to each section. (See Fig. 3 on page 14)

NOTE: We cannot accept the hazard on customer's material, especially stainless steel.

- State gauge and kind of material. If in doubt specify thickness in decimals. (For stainless steel and monels, use the U.S. Std. Ga. Table in the Miscellaneous section. For brass, copper, muntz metal and aluminum, use the B & S Ga. Table in the Miscellaneous section.)
- Size, shape, arrangement and center of holes. If slotted holes are selected, state whether they are to run lengthwise or crosswise of the sheets, Normal hole tolerances are +.000 - 10% of material thickness.
- Width of all margins and bars (the metal between perforations). (Keep margins to a minimum as they generally increase the cost, avoid all wide margins if possible.)
- If drawing is included with order and shows a fabricated unit, state if we are to fabricate all or any part as shown on the drawing.
- If a screenplate is to be "crowned", state the amount of the crown measured at the center line. Unless otherwise specified, the standard crown for screens 3/16" thick and heavier will be furnished as follows:
For 3' or 4' wide vibrating screens — 1/2" crown
For 5' wide vibrating screens — 3/4" crown
For 6' wide vibrating screens and wider — 1" crown
- Methods of attaching perforated screen plate to vibrating screens:
Hook Flanges — For standard "tension-type" vibrating screens specify "Hook Flanges."
Bolted to Frame of Vibrating Screen — If the Perforated Screen Plate is to be bolted, submit sketch showing locations, size and type of the bolt holes. Also specify the width of blank margins on the sides and the ends of the Perforated Screen Plate.
- Methods of assembling perforated screen plate segments to make sections and/or cylinders:
Butt joints: Not fastened
Standard clips
Standard straps
Lap joints: the standard lap joint is 1 1/2" to 2" (minimum lap 1 1/2")
- If bolt holes are required state size of holes, centers and locations.
- If in doubt, send a rough sketch or a sample.
- If used in screening purposes, state the direction of flow of the material.

PERFORATED METALS

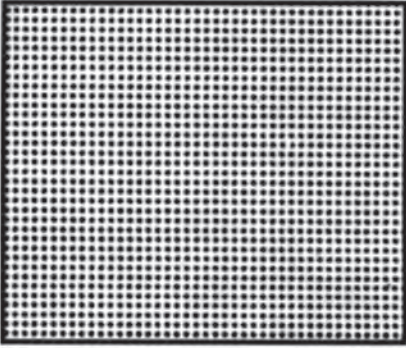

.027" diameter. Straight line centers.
400 holes per sq. inch.
23% open area.

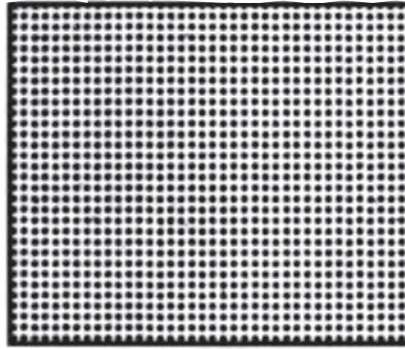

.033" diameter. Straight line centers.
324 holes per sq. inch.
28% open area.

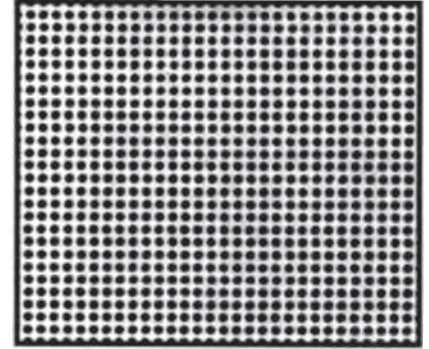

.045" diameter. Straight line centers.
225 holes per sq. inch.
36% open area.

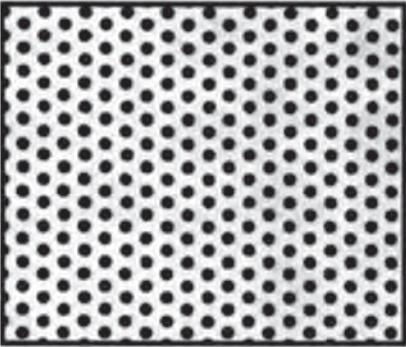

$\frac{1}{16}$ " diameter. $\frac{1}{8}$ " staggered centers.
75 holes per sq. inch.
23% open area.

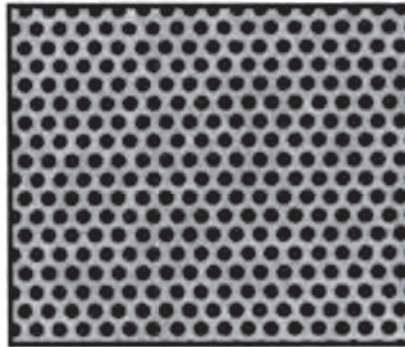

$\frac{5}{64}$ " diameter. $\frac{1}{8}$ " staggered centers.
75 holes per sq. inch.
36% open area.

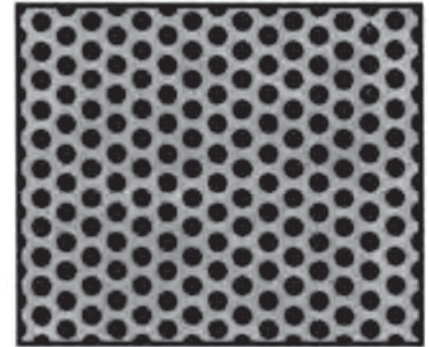

$\frac{3}{32}$ " diameter. $\frac{5}{32}$ " staggered centers.
47 holes per sq. inch.
33% open area.

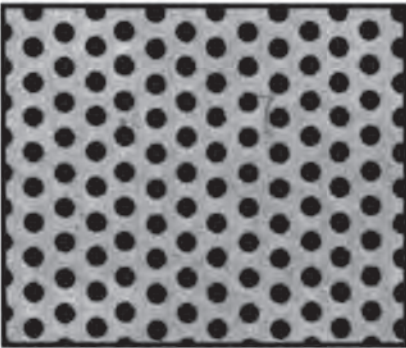

$\frac{3}{32}$ " diameter. $\frac{3}{16}$ " staggered centers.
32 holes per sq. inch.
25% open area.

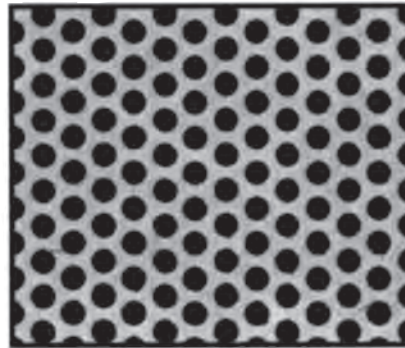

$\frac{1}{8}$ " diameter. $\frac{3}{16}$ " staggered centers.
33 holes per sq. inch.
40% open area.

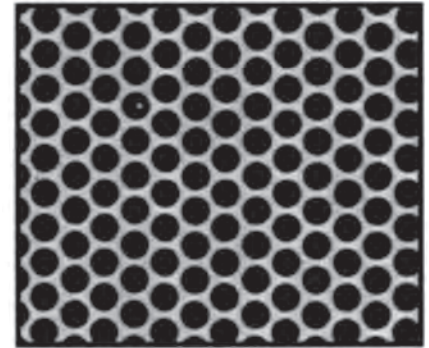

$\frac{5}{32}$ " diameter. $\frac{3}{16}$ " staggered centers.
33 holes per sq. inch.
63% open area.

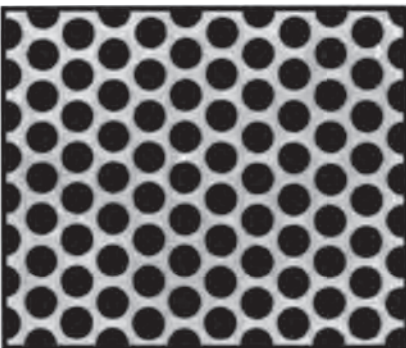

$\frac{5}{32}$ " diameter. $\frac{7}{32}$ " staggered centers.
24 holes per sq. inch.
46% open area.

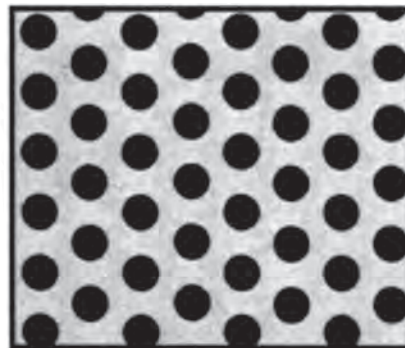

$\frac{3}{16}$ " diameter. $\frac{1}{4}$ " staggered centers.
18 holes per sq. inch.
50% open area.

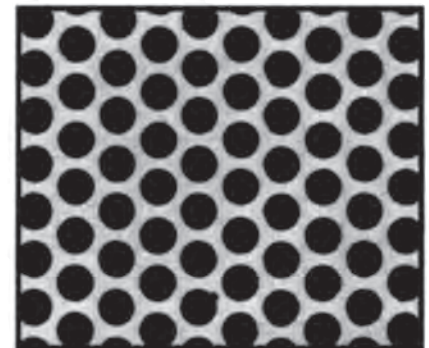

$\frac{3}{16}$ " diameter. $\frac{5}{16}$ " staggered centers.
12 holes per sq. inch.
32% open area.

PERFORATED METALS

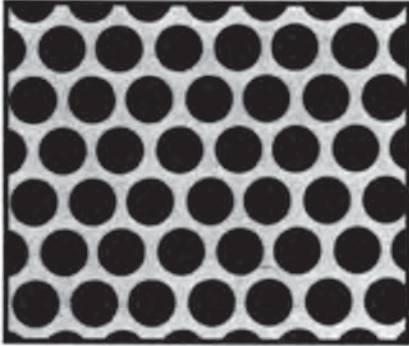

1/4" diameter. 3/16" staggered centers.
12 holes per sq. inch.
58% open area.

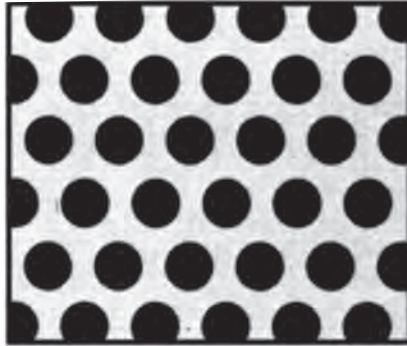

1/4" diameter. 3/8" staggered centers.
8.5 holes per sq. inch.
42% open area.



1/4" diameter. 7/16" staggered centers.
6.5 holes per sq. inch.
32% open area.

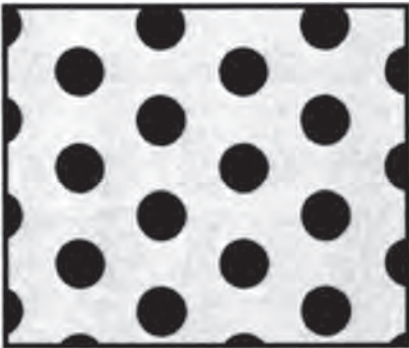

1/4" diameter. 1/2" staggered centers.
5 holes per sq. inch.
23% open area.



3/8" diameter. 1/2" staggered centers.
5 holes per sq. inch.
52% open area.



3/8" diameter. 5/8" staggered centers.
4 holes per sq. inch.
40% open area.



1/2" diameter. 1/4" staggered centers.
2.5 holes per sq. inch.
48% open area.



3/4" diameter. 1" staggered centers.
1.1 holes per sq. inch.
51% open area.



1" diameter. 1 1/4" staggered centers.
.74 holes per sq. inch
58% open area.

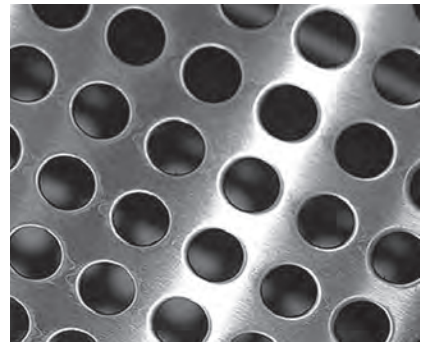
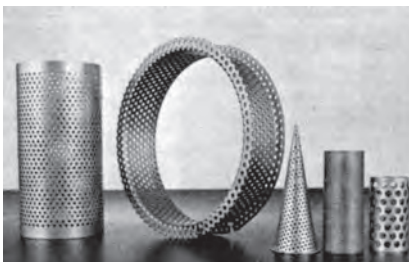

EXPANDED METAL

CARBON FLATTENED

Style	Lbs. Per 100 sq. Ft.		Standard Sheet Size (Feet)		Diamond Design Size (Inches)		Diamond Opening Size (Inches)		Strand Size (Inches)		Over-all Thickness	No. of Designs Per Sq. Ft.		% Open Area
	Black	(1) Galv	Width SWD	Length LWD	SWD	LWD	SWO	LWO	Width	Thickness Gauge		SWD	LWD	
1/4"-#20	82	103	4	8	.250	1.05	.110	.715	.079	.030	.030	48	11.6	35
1/4"-#18	108	135	3&4	8	.250	1.05	.118	.715	.080	.040	.040	48	11.6	35
1/2"-#40 (18ga)	38	NA	4	8	.500	1.25	.380	1.000	.056	.040	.040	24	9.5	77
1/2"-#20	40	51	3&4	8	.500	1.25	.375	1.000	.079	.029	.029	24	9.5	65
1/2"-#18	66	83	3&4 4	8 10	.500	1.25	.312	1.000	.097	.039	.039	24	9.5	60
1/2"-#16	82	98	3&4 3&4	8 10	.500	1.25	.312	1.000	.096	.050	.050	24	9.5	63
1/2"-#13	140	161	3&4 3&4	8 10	.500	1.25	.265	1.000	.107	.078	.078	24	9.5	52
3/4"-#16	51	57	3&4 3&4	8 10	.923	2.10	.750	1.750	.111	.048	.048	13	5.7	74
3/4"-#14	63	74	3&4 3&4	8 10	.923	2.10	.688	1.813	.105	.061	.061	13	5.7	74
3/4"-#13	75	88	3&4 3&4	8 10	.923	2.10	.688	1.781	.106	.078	.078	13	5.7	74
3/4"-#10 (13ga)	114	128	.	.	.923	2.10	.637	1.755	.160	.078	.078	13	5.7	68
3/4"-#9 (10ga)	171	188	3&4 3&4 8 4 10 12	8	.923	2.10	.563	1.688	.165	.120	.120	13	5.7	63
1"-#16	41	50	4	8	1.00	2.50	.813	2.250	.098	.050	.050	12	4.68	78
1-1/2"-#16 (L)	29	NA	4	8	1.33	3.20	1.175	2.620	.093	.050	.050	9	3.75	83
1-1/2"-#16	38	46	3&4	8	1.33	3.20	1.062	2.750	.119	.048	.048	9	3.75	83
1-1/2"-#14	46	54	3&4	8	1.33	3.20	1.062	2.750	.116	.060	.060	9	3.75	80
1-1/2"-#13	57	66	4 3&4	8 10	1.33	3.20	1.062	2.750	.116	.078	.078	9	3.75	80
1-1/2"-#9 (10ga)	114	125	3&4 3&4	8 10	1.33	3.20	1.000	2.563	.158	.110	.110	9	3.75	75
2"-#9 (10ga)	80	88	.	.	1.825	4.355	1.445	3.700	.170	.110	.110	6.5	3.75	83

#401	1" U-EDGING	10 FT. LENGTHS	.35#/FT.
#402	1" U-EDGING	10 FT. LENGTHS	.34#/FT.
#403	1" U-EDGING	10 FT. LENGTHS	.34#/FT.

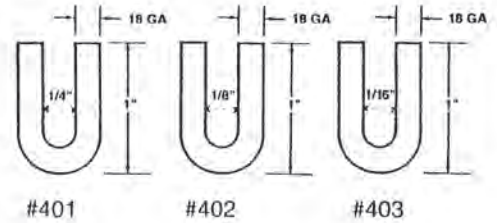

The above material is produced in accordance with military specification MIL-M-17194D Type II Class 1 and ASTM 1267 Type II Class 1.

Weights, gauges and dimensions are subject to standard mill tolerances.

* Denotes special order only.

SMALL DIAMOND DESIGNS 3/32" - 5/16"

STYLE	Lbs. Per 100 Sq. Ft.	Design Sizes (Inches)		Opening Sizes (Inches)		Strand Size (Inches)		Overall Thickness (Inches)	No. of Designs Per Ft.		(% Open Area)
		SWD	LWD	SWO	LWO	Width	Thickness		SWD	LWD	
CARBON											
3/32" - #24 - .040	57	.140	.240	.062	.135	.040	.024	.065	86	50	40
1/8" - #24 - .040	53	.150	.300	.070	.155	.040	.024	.060	80	40	44
3/16" - #26 - .034	27	.190	.500	.165	.375	.034	.018	.090	63	24	70
3/16" - #26 - .050	38	.200	.500	.130	.325	.050	.018	.080	60	24	60
3/16" - #26 - .060	43	.210	.500	.100	.295	.060	.018	.085	57	24	55
3/16" - #24 - .034	36	.190	.500	.160	.360	.034	.024	.070	63	24	66
3/16" - #24 - .050	50	.200	.500	.115	.325	.050	.024	.085	60	24	57
3/16" - #24 - .060	57	.210	.500	.125	.337	.060	.024	.090	57	24	51
3/16" - #22 - .034	45	.190	.500	.140	.345	.034	.031	.070	63	24	61
3/16" - #22 - .050	63	.200	.500	.104	.300	.050	.031	.040	60	24	53
3/16" - #22 - .060	71	.210	.500	.110	.308	.060	.031	.095	57	24	45
3/16" - #24 (.400 LWD)	50	.200	.400	.110	.282	.050	.024	.090	63	30	48
1/4" - #22 (.670 LWD)	52	.250	.670	.167	.473	.050	.031	.100	48	18	62
ALUMINUM 5005 H-34											
3/32" - .020 - .025	11	.140	.240	.081	.148	.025	.020	.040	86	50	45
1/8" - .020 - .040	17	.150	.300	.075	.183	.040	.020	.060	80	40	40
3/16" - .032 - .034	16	.190	.500	.160	.360	.034	.032	.070	63	24	66
3/16" - .032 (.400 LWD)	18	.200	.400	.123	.270	.040	.032	.075	60	30	64
1/4" - .040 (.670 LWD)	27	.250	.670	.175	.473	.060	.040	.100	48	18	60

Weights, Gauges, Dimensions and Sizes listed above are subject to mill tolerances. Above meshes available on special order only. Consult mill for maximum sizes and minimum quantities.

FAX YOUR ORDER: METALS, INC. 440-439-0577 • sales@metals-inc.com

EXPANDED METAL

CARBON STANDARD

Style	Lbs. Per 100 sq. Ft.		Standard Sheet Size (Feet)		Diamond Design Size (Inches)		Diamond Opening Size (Inches)		Strand Size (Inches)		Over-all Thickness	No. of Designs Per Sq. Ft.		% Open Area
	Black	(1) Galv	Width SWD	Length LWD	SWD	LWD	SWO	LWO	Width	Thickness Gauge		SWD	LWD	
1/4"-#20	86	108	4	8	.250	1.00	.125	.718	.072	.036	.135	48	12	45
1/4"-#18	114	143	4	8	.250	1.00	.110	.718	.072	.048	.147	48	12	43
1/2"-#40 (18ga)	40	NA	*	*	.500	1.20	.440	.938	.051	.048	.110	24	10	82
1/2"-#20	43	54	4	8	.500	1.20	.438	.938	.072	.036	.140	24	10	80
1/2"-#18	70	88	4&6	8	.500	1.20	.438	.938	.088	.048	.172	24	10	72
1/2"-#16	86	104	4 6	8&10 10	.500	1.20	.375	.938	.087	.060	.175	24	10	65
1/2"-#13	147	174	4 6	8&10 8&10	.500	1.20	.312	.938	.096	.090	.204	24	10	57
3/4"-#16	54	61	4&6	8	.923	2.00	.813	1.750	.101	.060	.210	13	6	78
3/4"-#13	80	94	4 6	8&10 8&10	.923	2.00	.750	1.688	.096	.090	.205	13	6	76
3/4"-#10 (13ga)	120	134	4 6	8 8&10	.923	2.00	.750	1.625	.144	.090	.290	13	6	72
3/4"-#9 (10ga)	180	198	4 6	8&10 8&10	.923	2.00	.688	1.562	.150	.134	.312	13	6	68
1"-#16	44	51	4	8	1.000	2.40	.938	2.062	.087	.060	.192	12	5	82
1-1/2"-#18	20	NA	4	8	1.330	3.00	1.313	2.625	.068	.048	.140	9	4	90
1-1/2"-#16	40	48	4	8	1.330	3.00	1.250	2.625	.108	.060	.230	9	4	85
1-1/2"-#13	60	68	4 6	8 8&10	1.330	3.00	1.188	2.500	.105	.090	.242	9	4	85
1-1/2"-#10 (13ga)	79	90	4 6	8&10 8&10	1.330	3.00	1.188	2.500	.138	.090	.284	9	4	80
1-1/2"-#9 (10ga)	120	131	4 6	8&10 8&10	1.330	3.00	1.125	2.375	.144	.134	.312	9	4	76
1-1/2"-#6	250	275	4 6	8 10&12	1.330	3.00	1.110	2.313	.203	.194	.433	9	4	69
2"-#10 (13ga)	68	77	*	*	1.850	4.00	1.630	3.438	.164	.092	.327	6.5	3	83
2"-#9 (10ga)	90	99	4	8	1.850	4.00	1.563	3.375	.149	.134	.312	6.5	3	84

This material is produced in accordance with military specification MIL-M-17194D Type I Class 1 and ASTM 1267 Type I Class 1.

Weights, gauges and dimensions are subject to standard mill tolerances.

* Denotes special order only.

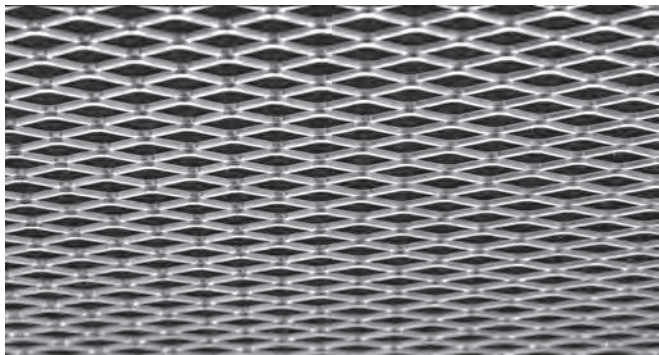

Standard Expanded Metal

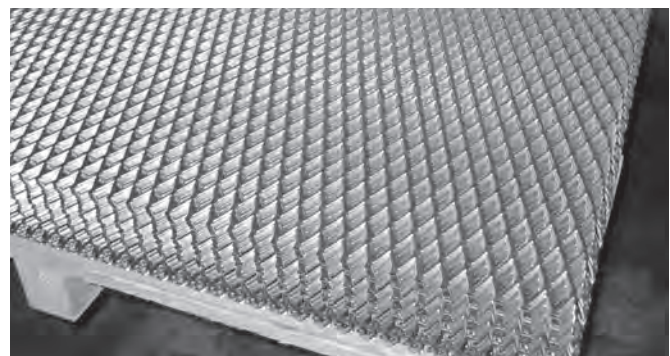
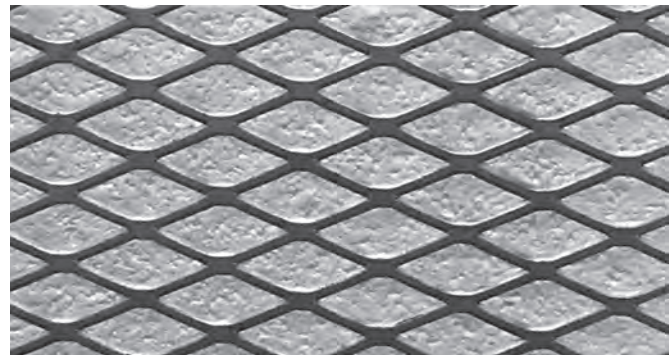

EXPANDED METAL

STAINLESS & ALUMINUM

TYPE 304 & 316 STAINLESS

STANDARD

Style	Lbs. Per 100 sq. Ft.	Standard Sheet Size (Feet)		Diamond Design Size (Inches)		Diamond Opening Size (Inches)		Strand Size (Inches)		Over-all Thickness	No. of Designs Per Sq. Ft.		% Open Area
		Width SWD	Length LWD	SWD	LWD	SWO	LWO	Width	Thickness Gauge		SWD	LWD	
1/4" - #18	146	4	8	.250	1.00	.120	.620	.087	.050	.150	48	12	30
1/2" - #18	73	3&4	8	.500	1.20	.437	.937	.087	.050	.164	24	10	70
1/2" - #16	91	3&4	8	.500	1.20	.437	.937	.087	.062	.164	24	10	70
1/2" - #13	187	3&4	8	.500	1.20	.325	.875	.119	.093	.225	24	10	52
3/4" - #18	48	3&4	8	.923	2.00	.812	1.750	.106	.050	.202	13	6	85
3/4" - #16	60	3&4	8	.923	2.00	.812	1.750	.106	.062	.202	13	6	83
3/4" - #13	91	3&4	8	.923	2.00	.750	1.687	.107	.093	.202	13	6	80
3/4" - #9 (10g)	205	3&4	8	.923	2.00	.687	1.562	.160	.140	.300	13	6	67
1-1/2" - #16	45	3&4	8	1.33	3.00	1.250	2.750	.115	.062	.222	9	4	85
1-1/2" - #13	68	3&4	8	1.33	3.00	1.250	2.625	.115	.093	.222	9	4	83
1-1/2" - #9 (10g)	137	3&4	8	1.33	3.00	1.125	2.500	.155	.140	.280	9	4	77

This material is produced in accordance with military specification MIL-M-17194D Type I Class 3 and ASTM 1267 Type I Class 3.

Weights, gauges and dimensions are subject to standard mill tolerances.

Stainless T-316 available in 4x8 sheets only.

FLATTENED

Style	Lbs. Per 100 sq. Ft.	Standard Sheet Size (Feet)		Diamond Design Size (Inches)		Diamond Opening Size (Inches)		Strand Size (Inches)		Over-all Thickness	No. of Designs Per Sq. Ft.		% Open Area
		Width SWD	Length LWD	SWD	LWD	SWO	LWO	Width	Thickness Gauge		SWD	LWD	
1/4" - #18	143	4	8	.250	1.20	.080	.660	.090	.047	.047	48	11.6	28
1/2" - #18	69	3&4	8	.500	1.26	.312	1.00	.098	.040	.040	24	9.5	60
1/2" - #16	86	3&4	8	.500	1.26	.312	1.00	.099	.050	.050	24	9.5	60
1/2" - #13	178	3&4	8	.500	1.26	.240	.915	.132	.080	.080	24	9.5	45
3/4" - #18	46	3&4	8	.923	2.10	.750	1.812	.118	.040	.040	13	5.7	75
3/4" - #16	57	3&4	8	.923	2.10	.750	1.812	.118	.050	.050	13	5.7	75
3/4" - #13	86	3&4	8	.923	2.10	.625	1.750	.120	.080	.080	13	5.7	75
3/4" - #9 (10g)	195	3&4	8	.923	2.10	.562	1.697	.165	.119	.119	13	5.7	61
1-1/2" - #16	43	3&4	8	1.33	3.15	1.062	2.750	.128	.050	.050	9	3.8	80
1-1/2" - #13	55	3&4	8	1.33	3.15	1.000	2.625	.130	.080	.080	9	3.8	80
1-1/2" - #9 (10g)	137	3&4	8	1.33	3.15	.937	2.625	.165	.119	.119	9	3.8	75

This material is produced in accordance with military specification MIL-M-17194D Type II Class 3 and ASTM 1267 Type II Class 3.

Weights, gauges and dimensions are subject to standard mill tolerances.

Stainless T-316 available in 4x8 sheets only.

ALUMINUM TYPE 3003H14

STANDARD

Style	Lbs. Per 100 sq. Ft.	Standard Sheet Size (Feet)		Diamond Design Size (Inches)		Diamond Opening Size (Inches)		Strand Size (Inches)		Over-all Thickness	No. of Designs Per Sq. Ft.		% Open Area
		Width SWD	Length LWD	SWD	LWD	SWO	LWO	Width	Thickness Gauge		SWD	LWD	
1/2" - .051	27	3&4	8	.500	1.20	.375	.937	.093	.051	.158	24	10	65
1/2" - .081	44	3&4	8	.500	1.20	.375	.937	.096	.081	.186	24	10	60
3/4" - .051	17	3&4	8	.923	2.00	.812	1.750	.109	.051	.200	13	6	78
3/4" - .081 L	32	3&4	8	.923	2.00	.750	1.680	.129	.081	.220	13	6	76
3/4" - .081	41	3&4	8	.923	2.00	.750	1.680	.165	.081	.300	13	6	69
3/4" - .125	65	3&4	8	.923	2.00	.687	1.680	.169	.125	.305	13	6	68
1-1/2" - .081	22	3&4	8	1.330	3.00	1.187	2.500	.128	.081	.240	9	4	85
1-1/2" - .125	43	3&4	8	1.330	3.00	1.187	2.500	.162	.125	.300	9	4	79

FLATTENED

Style	Lbs. Per 100 sq. Ft.	Standard Sheet Size (Feet)		Diamond Design Size (Inches)		Diamond Opening Size (Inches)		Strand Size (Inches)		Over-all Thickness	No. of Designs Per Sq. Ft.		% Open Area
		Width SWD	Length LWD	SWD	LWD	SWO	LWO	Width	Thickness Gauge		SWD	LWD	
1/2" - .051	27	3&4	8	.500	1.27	.312	1.000	.104	.040	.040	24	9.5	61
1/2" - .081	42	3&4	8	.500	1.27	.312	1.000	.105	.060	.060	24	9.5	58
3/4" - .051	16	3&4	8	.923	2.125	.750	1.812	.122	.040	.040	13	5.66	72
3/4" - .081 L	30	3&4	8	.923	2.125	.687	1.750	.143	.070	.070	13	5.66	70
3/4" - .081	39	3&4	8	.923	2.125	.687	1.750	.181	.070	.070	13	5.66	63
3/4" - .125	62	3&4	8	.923	2.125	.625	1.175	.187	.095	.095	13	5.66	62
1-1/2" - .081	21	3&4	8	1.330	3.150	1.062	2.750	.143	.060	.060	9	3.8	77
1-1/2" - .125	43	3&4	8	1.330	3.150	1.000	2.750	.181	.080	.080	9	3.8	70

Weights, gauges and dimensions are subject to standard mill tolerances.

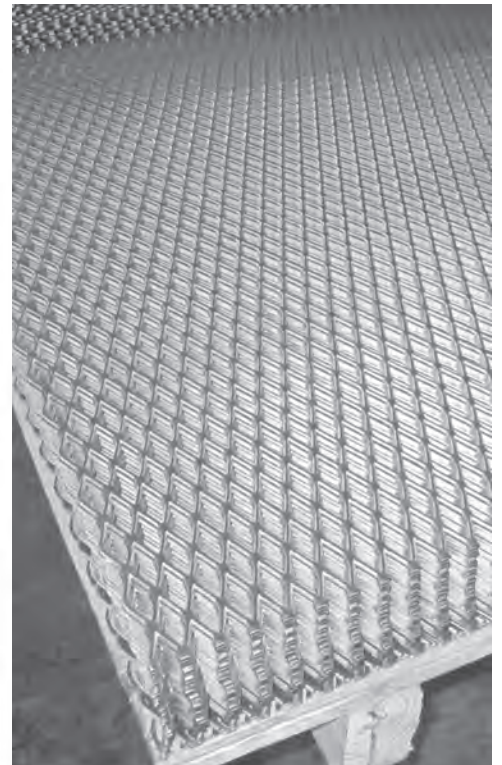

EXPANDED METAL

EXPANDED GRATING DATA

CARBON STEEL GRATING

Style	Lbs. Per 100 sq. Ft.		Standard Sheet Size (Feet)		Design Size (Inches)		Opening Size (Inches)		Strand Size (Inches)		Over-all Thickness	No. of Designs Per Sq. Ft.		% Open Area
	Plain	(1) Galv. Wt.	Width SWD	Length LWD	SWD	LWD	SWO	LWO	Width	Thickness Gauge		SWD	LWD	
2.0 lbs.	2.0	2.10	*	*	1.25	5.33	1.000	3.60	.230	.135	.460	10	2.25	77
3.0 lbs.	3.0	3.15	4, 6	8, 10, 12	1.33	5.33	.940	3.44	.264	.183	.540	9	2.25	60
3.14 lbs.	3.14	3.30	4, 6	8, 10	2.00	6.00	1.625	4.88	.312	.250	.656	6	2	69
4.0 lbs.	4.0	4.18	4, 5, 6	8, 10	1.33	5.33	.940	3.44	.300	.215	.618	9	2.25	55
4.27 lbs.	4.27	4.46	4, 6	8, 10	1.41	4.00	1.000	2.88	.300	.250	.625	8.5	3	58
5.0 lbs.	5.0	5.20	4, 5, 6	8, 10	1.33	5.33	.813	3.38	.331	.250	.655	9	2.25	50
6.25 lbs.	6.25	6.47	4, 6	8, 12	1.41	5.33	.813	3.38	.350	.312	.715	8.5	2.25	50
7.0 lbs.	7.0	7.25	4	8	1.41	5.33	.813	3.38	.391	.312	.740	8.5	2.25	45

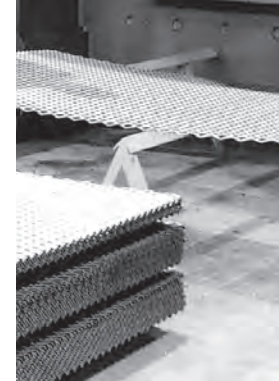

CARBON STEEL CATWALK

Style	Lbs. Per 100 sq. Ft.		Standard Sheet Size (Feet)		Design Size (Inches)		Opening Size (Inches)		Strand Size (Inches)		Over-all Thickness	No. of Designs Per Sq. Ft.		% Open Area
	Plain	Galv. Wt.	Width SWD	Length LWD	SWD	LWD	SWO	LWO	Width	Thickness Gauge		SWD	LWD	
2.0 lbs.	2.0	2.10	*	*	1.25	5.33	1.000	3.60	.230	.135	.460	10	2.25	77
3.0 lbs.	3.0	3.15	10	**	1.33	5.33	.940	3.44	.264	.183	.540	9	2.25	60
3.14 lbs.	3.14	3.30	10	**	2.00	6.00	1.625	4.88	.312	.250	.656	6	2	69
4.0 lbs.	4.0	4.18	10	**	1.33	5.33	.940	3.44	.300	.215	.618	9	2.25	55
4.27 lbs.	4.27	4.46	10	**	1.41	4.00	1.000	2.88	.300	.250	.625	8.5	3	58
5.0 lbs.	5.0	5.20	10	**	1.33	5.33	.813	3.38	.331	.250	.655	9	2.25	50

** Catwalk LWD stock in 2', 2.5', 3', 6', 7.5', 8' Lengths.

Carbon Steel Catwalk and Structural Gratings meet all requirements of military specifications MIL-M-17194D (Metals, Expanded, Steel) and MIL-G-18015 (Ships) (Grating, Metal, other than Bar Type) and the deflection requirements of Federal Specification RR-G-661B.

* Denotes special order only.

(1) Hot dip galvanizing does not always produce a smooth and even coating.

STAINLESS 304

ALUMINUM 5052 H-32

Style	Lbs. Per 100 sq. Ft.		Standard Sheet Size (Feet)		Design Size (Inches)		Opening Size (Inches)		Strand Size (Inches)		Over-all Thickness	No. of Designs Per Sq. Ft.		% Open Area
	Plain		Width SWD	Length LWD	SWD	LWD	SWO	LWO	Width	Thickness Gauge		SWD	LWD	
3.3 lbs.	3.3		4	10	2.00	6.0	1.625	4.88	.312	.250	.656	6	2	69
4.5 lbs.	4.5		4	10	1.41	4.0	1.000	2.88	.300	.250	.625	8.5	3	58
2.0 lbs.	2.0		4	8	1.33	5.33	.940	3.44	.387	.250	.730	9	2.25	48
			5	10 & 12										

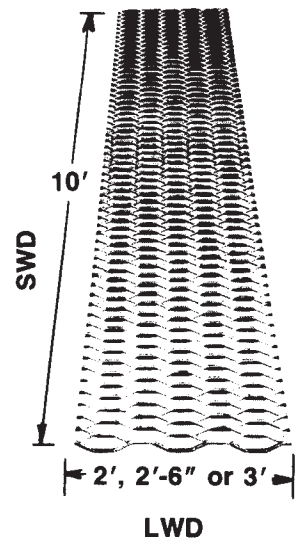

All weights, gauges and dimensions are approximate.

Catwalk Grating Selection Chart

CONCENTRATED LOAD (Lb. Per Foot of Length of Catwalk or Platform)	CLEAR SPAN (Distance between supports measured from the inside edge of one support to the inside edge of the next support)						
	23'	30'	35'	42'	47'	54'	60'
50 lbs. Light or Occasional Pedestrian Traffic	3.0 3.14	3.0 3.14	3.0 3.14	3.0 3.14	3.0 3.14	4.0 4.27	5.0 6.25
100 lbs. Normal or Frequent Pedestrian Traffic	3.0 3.14	3.0 3.14	3.0 3.14	4.0 4.27	5.0 6.25	7.0 7.0	
150 lbs. Heavy or Constant Pedestrian Traffic	3.0 3.14	4.0 4.27	4.0 4.27	5.0 6.25	6.25 6.25	7.0 7.0	
200 lbs. Pedestrian Traffic with Light Equipment	3.0 3.14	4.0 4.27	4.27 5.0	6.25 5.0	7.0 7.0		
250 lbs.	4.0 4.27	5.0 6.25	5.0 6.25	7.0			
300 lbs.	4.0 4.27	5.0 6.25	6.25				
350 lbs.	4.0 4.27	6.25	7.0				

The concentrated load deflections for the above selection chart do not exceed the 1/4" maximum deflection, and the generally accepted recommendation for normal pedestrian comfort.

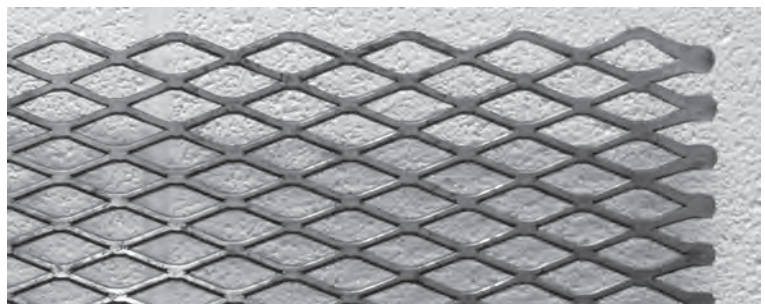

Expanded Bond Sheared

BAR GRATING

WELDED GRATING GLOSSARY

BANDING BAR — A flat bar welded to the end of a panel of grating. The bar is usually the same thickness and depth as the bearing bar.

BEARING BAR — The main load carrying bar which runs the same direction as the span.

CIRCULAR CUT-BAND — The circular cutting and banding of a panel to conform to a specific layout. Ex. grating going around a tank or pipe.

CROSS BARS — The connecting bars made from steel strip or rolled bars which extend across the bearing bars, usually perpendicular to them. They are welded, forged or mechanically locked.

NOSING — An L-shaped section, usually made of checker plate or cast iron and cast aluminum abrasive material.

SERRATED GRATING — Grating which has the top surfaces of the bearing bar notched, which provides non skid footing.

SPAN — The distance between points of grating support. Mostly direction of bearing bar.

STRAIGHT CUT — The cutting of grating along a straight edge. Mostly figured when cutting around columns or posts.

TOE PLATE — A flat bar attached flat against the outer edge of grating and projecting above the top surface of grating to form lip or curve.



ORDER/SPECIFICATION INFORMATION

GRATING

1. Specify type of grating (steel, aluminum, stainless)
2. Bearing bar size and center to center of spacing
3. Span (Bearing Bar Direction)
4. Drawing: Area to be covered, including all cutouts and critical dimensions
5. Type of anchorage (welded, saddle clip, friction clip, others)
6. Mill finish (unpainted), Painted black, or Galvanized
7. Standard panel dimensions: 2'x20', 2'x24', 3'x20', 3'x24'

STAIR TREADS

1. Type of grating and bearing bar size
2. Nosing: Checkerplate or abrasive
3. Mill finish (unpainted), Painted black, or Galvanized
4. Refer to page 18 for more details

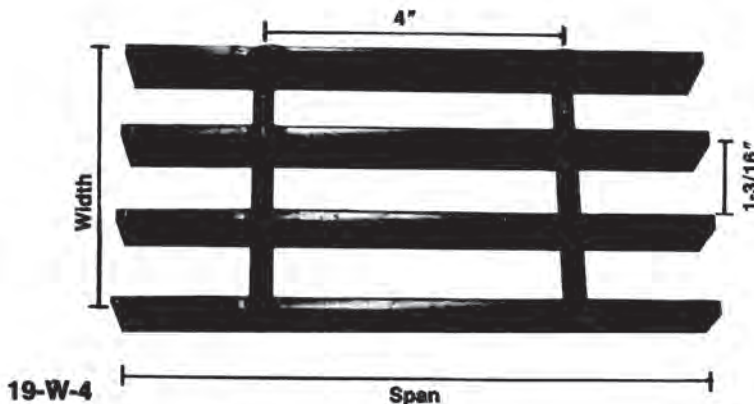

TRENCH GRATING DETAIL DESIGNATING BEARING BAR DIRECTION

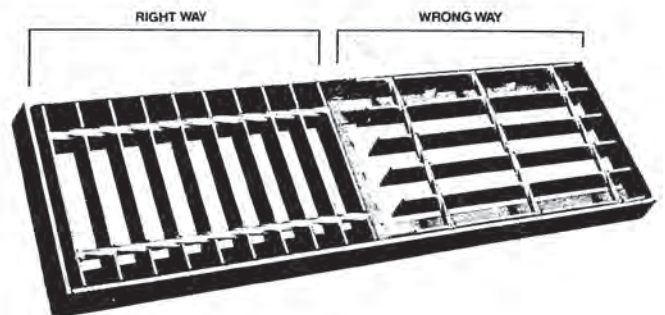

WELDED GRATING

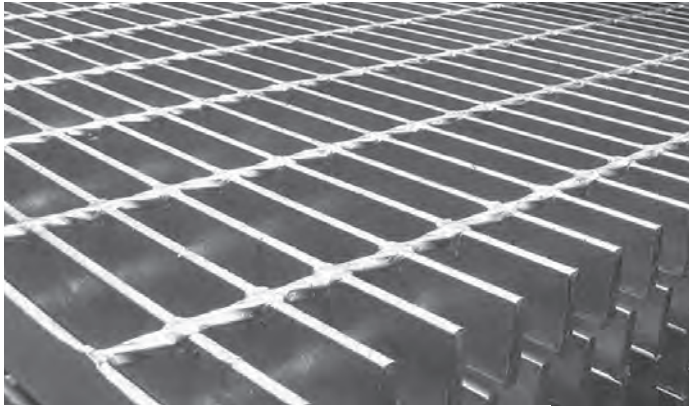

Smooth

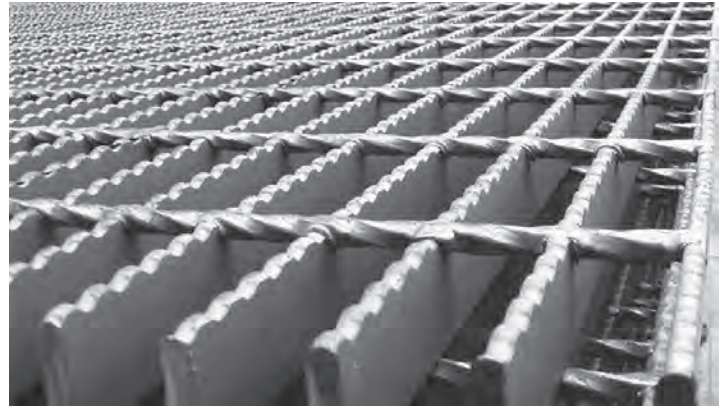

Serrated

TYPES AND WEIGHTS

Bearing Bar Size In.	19-W-4 Wt. Lbs. Sq. Ft.	15-W-4 Wt. Lbs. Sq. Ft.	19-W-2 Wt. Lbs. Sq. Ft.	15-W-2 Wt. Lbs. Sq. Ft.	11-W-4 Wt. Lbs. Sq. Ft.
3/4 x 3/16	5.46	7.02	6.10	7.66	9.28
1 x 1/8	5.00	6.30	5.64	7.72	8.29
1 x 3/16	6.62	8.36	7.26	10.56	12.16
1 1/4 x 1/8	6.14	7.76	6.78	8.40	10.18
1 1/4 x 3/16	8.15	10.31	8.79	10.95	15.04
1 1/2 x 1/8	7.24	9.13	7.88	10.56	12.16
1 1/2 x 3/16	9.98	12.55	10.84	13.41	18.28
1 3/4 x 3/16	11.47	14.45	12.33	15.31	21.16
2 x 3/16	12.95	16.36	13.81	17.23	24.04
2 1/4 x 3/16	14.43	18.28	15.30	19.15	26.74
2 1/2 x 3/16	15.97	20.25	16.84	21.12	29.62

PANEL WIDTH CHART IN INCHES

DIMENSIONS SHOWN ARE OUT TO OUT OF BEARING BARS

No. of Bars	2	3	4	5	6	7	8	9	10	11	12	13	14	15	16	17	18	19	20	21			
19W4 or 19W2	1/8 Bar	15 ¹ / ₁₆	2 ¹ / ₂	3 ¹¹ / ₁₆	4 ⁷ / ₈	6 ¹ / ₁₆	7 ¹ / ₄	8 ⁷ / ₁₆	9 ⁵ / ₈	10 ¹³ / ₁₆	12	13 ⁹ / ₁₆	14 ³ / ₈	15 ⁹ / ₁₆	16 ³ / ₄	17 ¹⁵ / ₁₆							
	3/16 Bar	1 ³ / ₈	2 ⁹ / ₁₆	3 ³ / ₄	4 ¹⁵ / ₁₆	6 ¹ / ₈	7 ⁵ / ₁₆	8 ¹ / ₂	9 ¹ / ₁₆	10 ⁷ / ₈	12 ¹ / ₁₆	13 ¹ / ₄	14 ⁷ / ₁₆	15 ⁵ / ₈	16 ¹³ / ₁₆	18							
No. of Bars	17	18	19	20	21	22	23	24	25	26	27	28	29	30	31	32	33	34	35	36	37	38	39
19W4 or 19W2	1/8 Bar	19 ¹ / ₈	20 ⁵ / ₁₆	21 ¹ / ₂	22 ¹¹ / ₁₆	23 ⁷ / ₈	25 ¹ / ₁₆	26 ¹ / ₄	27 ⁷ / ₁₆	28 ⁵ / ₈	29 ¹³ / ₁₆	31	32 ³ / ₁₆	33 ³ / ₈	34 ⁹ / ₁₆	35 ³ / ₄							
	3/16 Bar	19 ³ / ₁₆	20 ³ / ₈	21 ⁹ / ₁₆	22 ³ / ₄	23 ¹⁵ / ₁₆	25 ¹ / ₈	26 ⁵ / ₁₆	27 ¹ / ₂	28 ¹¹ / ₁₆	29 ⁷ / ₈	31 ¹ / ₁₆	32 ¹ / ₄	33 ⁷ / ₁₆	34 ⁵ / ₈	35 ¹³ / ₁₆							
No. of Bars	2	3	4	5	6	7	8	9	10	11	12	13	14	15	16	17	18	19	20	21			
15W4 or 15W2	1/8 Bar	1 ¹ / ₁₆	2	2 ¹ / ₁₆	3 ⁷ / ₁₆	4 ¹ / ₁₆	5 ³ / ₄	6 ¹ / ₁₆	7 ⁵ / ₁₆	8 ⁹ / ₁₆	9 ¹ / ₂	10 ⁷ / ₁₆	11 ³ / ₈	12 ⁵ / ₁₆	13 ¹ / ₄	14 ⁹ / ₁₆	15 ¹ / ₈	16 ¹ / ₁₆	17	17 ¹⁵ / ₁₆	18 ⁷ / ₈		
	3/16 Bar	1 ¹ / ₈	2 ¹ / ₁₆	3	3 ¹⁵ / ₁₆	4 ⁷ / ₁₆	5 ¹ / ₁₆	6 ³ / ₄	7 ¹ / ₁₆	8 ⁵ / ₁₆	9 ⁹ / ₁₆	10 ¹ / ₂	11 ⁷ / ₁₆	12 ³ / ₈	13 ⁵ / ₁₆	14 ¹ / ₄	15 ³ / ₁₆	16 ¹ / ₈	17 ¹ / ₁₆	18	18 ¹⁵ / ₁₆		
No. of Bars	22	23	24	25	26	27	28	29	30	31	32	33	34	35	36	37	38	39					
15W4 or 15W2	1/8 Bar	19 ¹³ / ₁₆	20 ³ / ₄	21 ¹ / ₁₆	22 ⁵ / ₁₆	23 ⁹ / ₁₆	24 ¹ / ₂	25 ⁷ / ₁₆	26 ³ / ₈	27 ⁵ / ₁₆	28 ¹ / ₄	29 ⁹ / ₁₆	30 ¹ / ₈	31 ¹ / ₁₆	32	32 ¹⁵ / ₁₆	33 ⁷ / ₈	34 ¹ / ₁₆	35 ³ / ₄				
	3/16 Bar	19 ⁷ / ₁₆	20 ¹³ / ₁₆	21 ³ / ₄	22 ¹¹ / ₁₆	23 ⁵ / ₁₆	24 ⁹ / ₁₆	25 ¹ / ₂	26 ⁷ / ₁₆	27 ³ / ₈	28 ⁵ / ₁₆	29 ¹ / ₄	30 ⁹ / ₁₆	31 ³ / ₈	32 ¹ / ₁₆	33	33 ¹⁵ / ₁₆	34 ⁷ / ₈	35 ¹³ / ₁₆				

Call Us With Your Visa/MasterCard/American Express



WELDED GRATING

19-W-4 LOAD TABLE

(1 3/16" c.c. of Bearing Bars and 4" c.c. of Cross Bars)

15-W-4 (15/16" c.c. of Bearing Bars) - Multiply by 1.28 • 11-W-4 (11/16" c.c. of Bearing Bars) - Multiply by 1.71

Main Bar Size Inches	Wt. Lbs. Sq. Ft.	CLEAR SPAN														
		1'0"	1'6"	2'0"	2'6"	3'0"	3'6"	4'0"	4'6"	5'0"	5'6"	6'0"	6'6"	7'0"	8'0"	
3/4 x 3/16	5.46	U	2323	1033	581	372	258	190	145	115	U = Safe uniform load in lbs./sq. ft. C = Safe concentrated load in lbs. per ft. of grating width D = Deflection in inches Loads and deflection given are theoretical and are based on a unit stress of 18,000 psi.					
		D	.025	.056	.099	.155	.223	.303	.396	.504						
		C	1162	774	581	465	387	332	290	258						
		D	.019	.044	.079	.124	.178	.243	.317	.402						
1 x 1/8	5.00	U	2746	1220	686	439	305	224	172	136	110	91	76			
		D	.019	.044	.074	.116	.168	.228	.298	.377	.466	.563	.670			
		C	1373	915	686	549	458	392	343	305	275	250	229			
		D	.014	.033	.059	.093	.134	.182	.238	.301	.372	.450	.536			
1 x 3/16	6.62	U	4132	1836	1033	661	459	337	258	204	165	137	115			
		D	.019	.042	.074	.117	.168	.229	.299	.378	.467	.565	.672			
		C	2066	1377	1033	826	689	590	516	459	413	376	344			
		D	.014	.033	.059	.093	.134	.183	.239	.302	.373	.452	.537			
1 1/4 x 1/8	6.14	U	4304	1913	1076	689	478	351	269	213	172	142	120	102	88	
		D	.015	.034	.060	.093	.135	.183	.239	.303	.374	.452	.538	.632	.733	
		C	2152	1434	1076	861	717	615	538	478	430	391	359	331	307	
		D	.011	.026	.047	.074	.107	.146	.191	.242	.299	.361	.430	.505	.586	
1 1/4 x 3/16	8.15	U	6442	2863	1610	1031	716	526	403	318	258	213	179	152	131	
		D	.015	.034	.060	.093	.134	.182	.238	.302	.372	.450	.536	.629	.730	
		C	3221	2147	1610	1288	1073	920	805	716	644	586	537	495	460	
		D	.012	.026	.047	.074	.107	.145	.190	.241	.297	.360	.429	.503	.583	
1 1/2 x 1/8	7.24	U	6191	2751	1548	991	688	505	387	306	248	205	172	147	126	96
		D	.012	.028	.050	.077	.112	.152	.198	.251	.310	.375	.447	.524	.608	.794
		C	3095	2064	1548	1238	1032	884	774	688	619	563	516	476	442	387
		D	.009	.022	.039	.062	.089	.121	.158	.200	.248	.300	.357	.419	.486	.635
1 1/2 x 3/16	9.98	U	9280	4124	2320	1485	1031	758	580	458	371	307	258	220	189	145
		D	.012	.028	.050	.078	.112	.152	.199	.251	.310	.376	.447	.524	.608	.794
		C	4640	3093	2320	1856	1547	1326	1160	1031	927	843	773	714	663	580
		D	.010	.022	.039	.062	.089	.121	.159	.201	.248	.300	.357	.419	.486	.635
1 3/4 x 3/16	11.47	U	12632	5614	3158	2021	1404	1031	790	624	505	418	351	299	258	197
		D	.011	.024	.043	.066	.096	.130	.170	.216	.266	.322	.383	.450	.521	.681
		C	6316	4211	3158	2526	2105	1805	1579	1404	1263	1148	1053	972	902	789
		D	.008	.019	.034	.053	.077	.104	.136	.172	.212	.257	.306	.359	.417	.545
2 x 3/16	12.95	U	16500	7333	4125	2640	1833	1347	1031	815	660	545	458	391	337	258
		D	.009	.021	.037	.058	.083	.114	.149	.189	.233	.282	.335	.393	.456	.596
		C	8250	5500	4125	3300	2750	2357	2063	1833	1650	1500	1375	1269	1178	1031
		D	.007	.016	.029	.046	.067	.091	.119	.150	.186	.225	.268	.314	.364	.476
2 1/4 x 3/16	14.43	U	20882	9281	5221	3341	2320	1705	1305	1031	835	690	580	494	426	326
		D	.008	.019	.033	.051	.074	.101	.132	.167	.206	.250	.297	.349	.405	.529
		C	10441	6961	5220	4176	3480	2983	2610	2320	2088	1898	1740	1606	1491	1305
		D	.006	.014	.026	.041	.059	.081	.105	.134	.165	.200	.238	.279	.324	.423
2 1/2 x 3/16	15.97	U	25779	11457	6445	4125	2864	2104	1611	1273	1031	852	716	610	526	403
		D	.007	.017	.029	.046	.067	.091	.119	.151	.186	.225	.268	.314	.365	.476
		C	12890	8593	6445	5155	4296	3683	3222	2864	2578	2343	2148	1983	1841	1611
		D	.005	.013	.023	.037	.053	.073	.095	.120	.148	.180	.214	.251	.292	.381

Based on 10.5 bars/ft of grating width. Bearing bars 1-3/16" c.c.

NOTE: Grating for spans to the left of the heavy line have a deflection less than 1/4" for uniform loads of 100 lbs./sq. ft. This is the maximum deflection to afford pedestrian comfort and can be exceeded for other types of load at the discretion of the engineer.

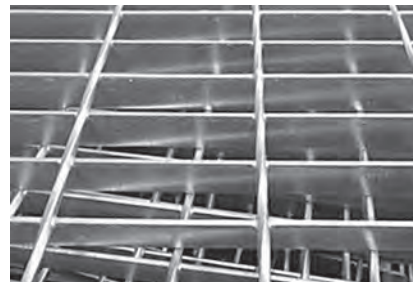
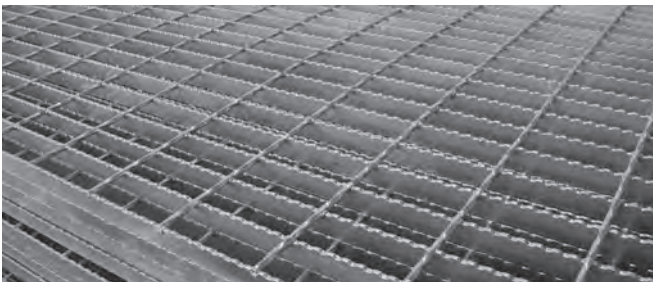

ALUMINUM GRATING

LOAD TABLE 19-SG-4

Main Bar Size Inches	Wt. Lbs. Sq. Ft.	CLEAR SPAN														
		1'0"	1'6"	2'0"	2'6"	3'0"	3'6"	4'0"	4'6"	5'0"	5'6"	6'0"	6'6"	7'0"	8'0"	
1 x 1/8	1.74	U	1832	814	458	293	203	149	114							
		D	.036	.081	.144	.224	.324	.440	.573							
		C	916	610	458	366	305	262	229							
		D	.029	.064	.115	.180	.260	.354	.462							
1 x 3/16	2.49	U	2752	1224	688	441	306	225	172	136						
		D	.036	.081	.144	.224	.324	.440	.573	.731						
		C	1376	918	688	552	459	394	345	306						
		D	.029	.065	.115	.180	.260	.354	.462	.582						
1 1/4 x 1/8	2.13	U	2872	1275	718	459	318	234	180	142	114					
		D	.029	.065	.115	.180	.258	.354	.460	.580	.720					
		C	1436	956	718	575	479	410	359	319	288					
		D	.024	.052	.093	.144	.207	.282	.368	.467	.575					
1 1/4 x 3/16	3.06	U	4300	1909	1075	688	477	351	269	212	172					
		D	.029	.065	.115	.180	.258	.354	.460	.580	.720					
		C	2150	1431	1075	858	714	613	537	477	428					
		D	.024	.051	.093	.144	.207	.282	.368	.467	.574					
1 1/2 x 1/8	2.49	U	4128	1834	1032	662	460	337	258	204	165	136				
		D	.024	.053	.096	.151	.216	.295	.384	.487	.603	.724				
		C	2064	1376	1032	825	687	589	516	458	413	375				
		D	.020	.043	.077	.120	.172	.235	.307	.386	.479	.579				
1 1/2 x 3/16	3.64	U	6200	2750	1550	990	687	505	387	306	248	204	172			
		D	.024	.054	.096	.151	.216	.295	.384	.487	.603	.724	.865			
		C	3100	2062	1550	1238	1032	884	775	688	618	562	516			
		D	.020	.043	.077	.120	.172	.235	.307	.386	.479	.579	.690			
1 3/4 x 3/16	4.21	U	8421	3743	2110	1348	935	687	527	416	337	278	234	200		
		D	.020	.046	.082	.127	.185	.252	.329	.416	.515	.621	.740	.868		
		C	4220	2807	2110	1690	1408	1205	1055	935	842	765	703	648		
		D	.017	.037	.066	.103	.148	.202	.264	.333	.412	.497	.595	.696		
2 x 3/16	4.78	U	11000	4889	2750	1760	1223	898	687	543	440	364	306	260	224	
		D	.018	.040	.072	.113	.161	.222	.289	.366	.451	.547	.650	.760	.881	
		C	5500	3667	2750	2200	1835	1570	1375	1223	1100	1002	917	845	786	
		D	.015	.032	.057	.090	.129	.178	.230	.292	.360	.436	.517	.606	.703	
2 1/4 x 3/16	5.35	U	13721	6187	3482	2230	1549	1138	870	687	557	460	387	330	284	217
		D	.016	.035	.064	.100	.144	.196	.256	.324	.400	.483	.577	.667	.783	1.020
		C	6964	4641	3482	2786	2320	1990	1740	1548	1393	1265	1160	1072	995	.870
		D	.013	.028	.051	.080	.115	.156	.204	.258	.319	.387	.460	.540	.627	.817
2 1/2 x 3/16	5.92	U	17186	7638	4300	2753	1910	1405	1075	850	688	569	477	407	351	269
		D	.015	.032	.057	.090	.130	.177	.230	.292	.360	.435	.515	.605	.704	.919
		C	8593	5729	4300	3437	2864	2445	2150	1910	1720	1562	1432	1322	1228	1075
		D	.012	.026	.046	.072	.103	.141	.184	.234	.288	.345	.416	.485	.562	.735

U—Safe uniform load in pounds/sq. ft.
 C—Safe concentrated load in pounds/ft. of grating width
 D—Deflection in inches

Loads and deflections given in this table are theoretical, and are based on a unit stress of 12,000 psi.

Based on 11 bars/ft of grating width. Bearing bars 1-3/16" c.c.

NOTE: Grating for spans to the left of the heavy line have a deflection less than 1/4" for uniform loads of 100 lbs./sq. ft. This is the maximum deflection to afford pedestrian comfort and can be exceeded for other types of load at the discretion of the engineer.

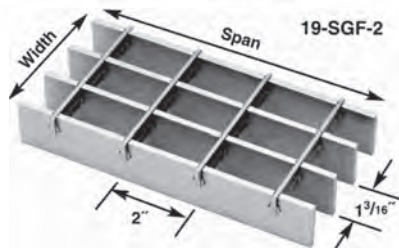

ALUMINUM FLUSH TOP

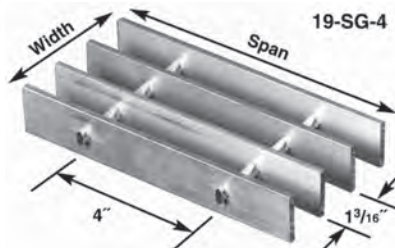

ALUMINUM RECTANGLE BAR

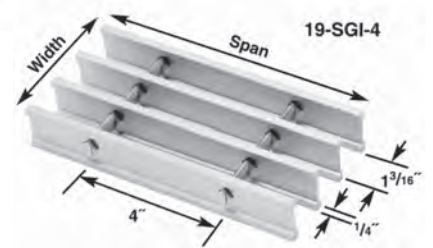

ALUMINUM I-BAR

HEAVY DUTY GRATING

TYPE 22W4 Spacing

BEARING BARS 1 3/8" c/c CROSS BARS 4" c/c

Cross bar spacing 2" c/c also available		Loading Table for Maximum Safe Spans					Weight lbs./sq. ft.
Bearing Bar Sizes	CLEAR SPAN						
	1 Ton	2 Ton	5 Ton	H 10	H 15	H 20	
1 x	1/4"	0'9"	0'7"	0'6"			8.43
	5/16"	0'11"	0'8"	0'7"			10.34
	3/8"	1'2"	0'9"	0'8"	0'11"	0'11"	12.60
1 1/4 x	1/4"	1'2"	0'10"	0'8"	0'11"	0'11"	10.34
	5/16"	1'6"	1'0"	0'10"	1'1"	1'0"	12.72
	3/8"	1'9"	1'2"	0'11"	1'2"	1'2"	15.47
1 1/2 x	1/4"	1'8"	1'1"	0'11"	1'1"	1'1"	12.25
	5/16"	2'1"	1'5"	1'1"	1'4"	1'3"	15.12
	3/8"	2'6"	1'8"	1'3"	1'6"	1'4"	18.34
1 3/4 x	1/4"	2'3"	1'6"	1'2"	1'4"	1'3"	14.17
	5/16"	2'10"	1'10"	1'4"	1'8"	1'5"	17.51
	3/8"	*3'4"	2'5"	1'7"	1'11"	1'8"	21.20
2 x	1/4"	3'0"	1'11"	1'5"	1'8"	1'5"	16.08
	5/16"	3'8"	2'5"	1'9"	2'1"	1'9"	19.90
	3/8"	*4'1"	2'10"	2'0"	2'5"	1'11"	24.07
2 1/4 x	1/4"	3'9"	2'5"	1'9"	2'0"	1'7"	17.99
	5/16"	*4'6"	3'0"	2'1"	2'6"	2'0"	22.30
	3/8"	*4'10"	3'7"	2'6"	2'11"	2'4"	26.94
2 1/2 x	1/4"	4'7"	3'0"	2'1"	2'4"	1'10"	19.90
	5/16"	5'2"	3'8"	2'7"	3'0"	2'4"	24.68
	3/8"	5'7"	4'5"	3'0"	3'6"	2'9"	29.81

TYPE 30W4 Spacing

BEARING BARS 1 7/8" c/c CROSS BARS 4" c/c

Cross bar spacing 2" c/c also available		Loading Table for Maximum Safe Spans					Weight lbs./sq. ft.
Bearing Bar Sizes	CLEAR SPAN						
	1 Ton	2 Ton	5 Ton	H 10	H 15	H 20	
1 x	1/4"	0'8"	0'6"				6.8
	5/16"	0'10"	0'7"				8.5
	3/8"	1'1"	0'8"				10.1
1 1/4 x	1/4"	1'1"	0'9"				8.5
	5/16"	1'4"	0'10"	0'11"	0'11"	0'11"	10.4
	3/8"	1'8"	1'0"	1'0"	1'0"	1'0"	12.2
1 1/2 x	1/4"	1'7"	1'0"	0'9"	1'0"	0'11"	10.1
	5/16"	1'11"	1'3"	0'11"	1'1"	1'1"	12.2
	3/8"	2'5"	1'6"	1'1"	1'3"	1'2"	14.5
1 3/4 x	1/4"	2'2"	1'4"	1'0"	1'2"	1'1"	11.5
	5/16"	2'8"	1'8"	1'2"	1'5"	1'3"	14.1
	3/8"	3'3"	2'0"	1'4"	1'7"	1'5"	16.7
2 x	1/4"	2'10"	1'9"	1'3"	1'5"	1'3"	13.3
	5/16"	3'6"	2'2"	1'6"	1'8"	1'6"	16.2
	3/8"	4'3"	2'7"	1'9"	1'11"	1'8"	19.2
2 1/4 x	1/4"	3'7"	2'3"	1'6"	1'8"	1'5"	14.8
	5/16"	*4'4"	2'9"	1'10"	2'0"	1'8"	18.1
	3/8"	*4'9"	3'3"	2'2"	2'4"	1'11"	21.5
2 1/2 x	1/4"	4'5"	2'8"	1'9"	1'11"	1'8"	16.3
	5/16"	*5'1"	3'4"	2'2"	2'4"	1'11"	20.1
	3/8"	*5'7"	4'1"	2'7"	2'10"	2'3"	23.7

TYPE 38W4 Spacing

BEARING BARS 2 3/8" c/c CROSS BARS 4" c/c

Cross bar spacing 2" c/c also available		Loading Table for Maximum Safe Spans					Weight lbs./sq. ft.
Bearing Bar Sizes	CLEAR SPAN						
	1 Ton	2 Ton	5 Ton	H 10	H 15	H 20	
1 x	1/4"	0'8"					5.5
	5/16"	0'10"					6.6
	3/8"	1'0"					7.7
1 1/4 x	1/4"	1'1"	0'8"				6.6
	5/16"	1'4"	1'0"				7.8
	3/8"	1'7"	1'0"		0'11"	0'11"	9.4
1 1/2 x	1/4"	1'6"	0'11"	0'10"	0'10"	0'10"	7.7
	5/16"	1'11"	1'2"	1'0"	1'0"	1'0"	9.4
	3/8"	2'3"	1'5"	1'2"	1'1"	1'1"	10.6
1 3/4 x	1/4"	2'1"	1'3"	0'10"	1'0"	1'0"	8.8
	5/16"	2'7"	1'7"	1'1"	1'3"	1'2"	10.8
	3/8"	3'1"	1'10"	1'3"	1'5"	1'3"	12.7
2 x	1/4"	2'8"	1'1"	1'3"	1'2"	1'2"	10.2
	5/16"	3'4"	2'0"	1'4"	1'6"	1'4"	12.4
	3/8"	4'1"	2'5"	1'6"	1'8"	1'5"	14.5
2 1/4 x	1/4"	3'5"	2'1"	1'4"	1'5"	1'4"	11.3
	5/16"	4'3"	2'7"	1'7"	1'6"	1'6"	13.8
	3/8"	*4'8"	3'1"	1'11"	2'0"	1'8"	16.4
2 1/2 x	1/4"	4'2"	2'6"	1'7"	1'8"	1'5"	12.4
	5/16"	*5'0"	3'2"	1'11"	2'1"	1'9"	15.2
	3/8"	*5'5"	3'9"	2'4"	2'5"	1'11"	18.0

1 TON, 2 TON AND 5 TON LOADS

- Total load = dead weight of vehicle plus weight of load carried.
- 80% of total load carried on one axle.
- Wheel load = 1/2 of the axle load.
- Impact factor — 30%.
- Method of load distribution:
Each wheel distributed over a width of 1" per ton of total load plus 2 times the distance center to center of bearing bars and over a length of each bar equal to 1" per ton of total load.
- Maximum allowable stress = 20,000 psi.
- Modulus of elasticity = 29,000,000 psi.
- Simple span.
- Maximum deflection = 1/400 span.

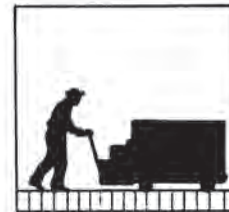

1-TON LOADING

Hand trucks, compact automobiles.



2-TON LOADING

Heavy automobiles, 1-ton fork lifts.

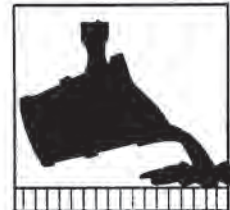

5-TON LOADING

Industrial working areas — painting, casting, forging, assembly, etc., 2-ton fork lifts or 5-ton ladle carrier.

HEAVY DUTY GRATING

AASHTO LOADINGS H-10, H-15 & H-20

- Wheel load—H-10 = 8,000 lbs.
H-15 = 12,000 lbs.
H-20 = 16,000 lbs.
- Impact factor—30%.
- Method of load distribution:
Each wheel distributed over a width of 15" plus 2 times the distance center to center of bearing bars and over a length on each bar equal to 10" for H-10, 15" for H-15, and 20" for H-20.
- Maximum allowable stress in accordance with AASHTO specifications for highway bridges, 1973 edition.
- Modules of elasticity = 29,000,000 psi.
- Simple span.
- Maximum deflection = 1/400 span.



H-10 LOADING

Vehicles such as fork lifts, trucks cranes with pneumatic tires, light trucks, and loaded dollies fall into this category. Use the H15 loading chart for factory and warehouse applications.



H-15 LOADING

Industrial truck cranes with pneumatic tires, heavy fork lifts, dump trucks, and high lifts fall into this category. Use the H15 loading chart where usual highway loading and heavy industrial loads are encountered.



H-20 LOADING

Heavy trucks such as concrete mixers, warehouse trucks and tractor trailers fall into this category. Use the H-20 loading chart where heavy highway loading is encountered.

TYPE 22W4 Spacing

BEARING BARS 1 3/8" c/c CROSS BARS 4" c/c

Cross bar spacing 2" c/c also available Loading Table for Maximum Safe Spans

Bearing Bar Sizes	CLEAR SPAN			Weight lbs./sq. ft.	
	H 10	H 15	H 20		
3 x 3/8"	1/4"	3'2"	2'6"	2'3"	24.86
	5/16"	4'4"	3'1"	2'8"	30.60
	7/16"	4'11"	3'7"	3'1"	36.44
	1/2"				
3 1/2 x 3/8"	1/4"	4'3"	3'2"	2'9"	29.32
	5/16"	5'5"	4'0"	3'4"	36.02
	7/16"	*6'4"	4'8"	3'11"	42.71
	1/2"				
4 x 3/8"	1/4"	5'5"	4'0"	3'4"	33.15
	5/16"	6'10"	5'0"	4'1"	40.80
	7/16"	*7'5"	6'0"	4'10"	48.45
	1/2"				
4 1/2 x 3/8"	1/4"	6'9"	4'10"	4'0"	36.97
	5/16"	7'9"	6'1"	4'11"	45.57
	7/16"	*8'4"	7'0"	5'10"	54.19
	1/2"				

TYPE 30W4 Spacing

BEARING BARS 1 7/8" c/c CROSS BARS 4" c/c

Cross bar spacing 2" c/c also available Loading Table for Maximum Safe Spans

Bearing Bar Sizes	CLEAR SPAN			Weight lbs./sq. ft.	
	H 10	H 15	H 20		
3 x 3/8"	1/4"	2'7"	2'1"	1'11"	18.50
	5/16"	3'3"	2'6"	2'3"	22.60
	7/16"	3'10"	2'11"	2'7"	28.62
	1/2"	4'6"	3'4"	2'10"	31.87
3 1/2 x 3/8"	1/4"	3'4"	2'7"	2'4"	21.92
	5/16"	4'3"	3'2"	2'9"	26.73
	7/16"	5'1"	3'9"	3'2"	31.54
	1/2"	6'0"	4'4"	3'7"	37.71
4 x 3/8"	1/4"	4'3"	3'2"	2'9"	24.65
	5/16"	5'5"	4'0"	3'4"	30.18
	7/16"	6'7"	4'9"	3'11"	35.70
	1/2"	7'3"	5'5"	4'5"	42.52
4 1/2 x 3/8"	1/4"	5'4"	3'11"	3'3"	27.45
	5/16"	6'9"	4'10"	4'0"	33.62
	7/16"	*7'6"	5'10"	4'9"	39.86
	1/2"	*8'1"	6'9"	5'5"	47.33

TYPE 38W4 Spacing

BEARING BARS 2 3/8" c/c CROSS BARS 4" c/c

Cross bar spacing 2" c/c also available Loading Table for Maximum Safe Spans

Bearing Bar Sizes	CLEAR SPAN			Weight lbs./sq. ft.	
	H 10	H 15	H 20		
3 x 3/8"	1/4"	2'3"	1'10"	1'9"	15.31
	5/16"	2'9"	2'2"	2'0"	18.67
	7/16"	3'4"	2'7"	2'3"	22.03
	1/2"	3'10"	2'11"	2'6"	26.30
		4'4"	3'3"	2'10"	29.66
3 1/2 x 3/8"	1/4"	2'11"	2'3"	2'1"	18.92
	5/16"	3'6"	2'9"	2'5"	22.08
	7/16"	4'4"	3'3"	2'10"	25.97
	1/2"	5'1"	3'8"	3'2"	31.19
		5'9"	4'2"	3'6"	35.08
4 x 3/8"	1/4"	3'8"	2'9"	2'5"	20.40
	5/16"	4'7"	3'5"	2'11"	24.86
	7/16"	5'6"	4'1"	3'5"	29.33
	1/2"	6'6"	4'8"	3'10"	35.08
		7'1"	5'3"	4'4"	39.54
4 1/2 x 3/8"	1/4"	4'6"	3'4"	2'10"	22.66
	5/16"	5'9"	4'2"	3'5"	27.65
	7/16"	6'10"	4'11"	4'1"	32.69
	1/2"	7'6"	5'5"	4'8"	38.96
		*7'10"	6'6"	5'3"	44.00

CLEARANCES/ANCHORING DEVICES

STANDARD INSTALLATION CLEARANCES

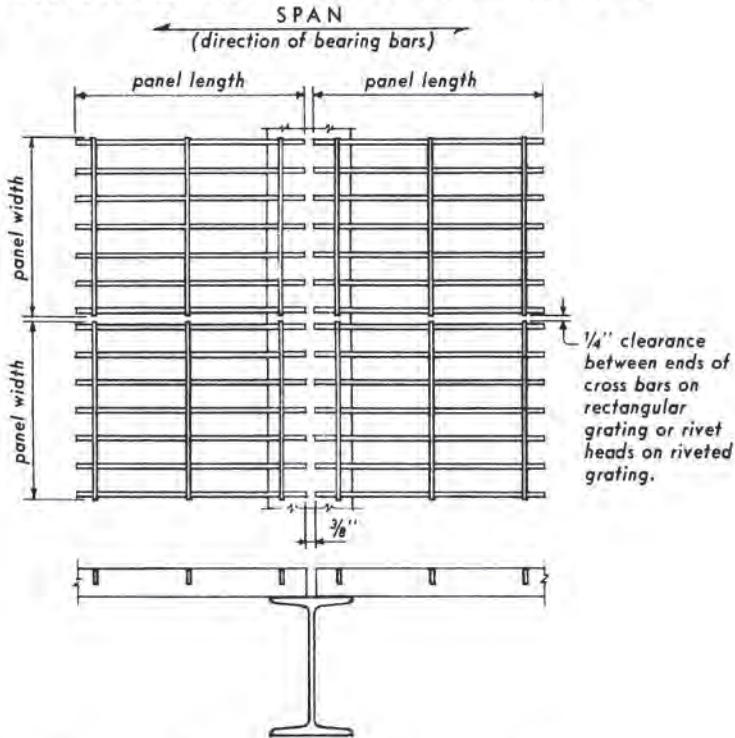

Clearances shown are recommended, but may vary in accordance with dimensional tolerances.

TACK WELD

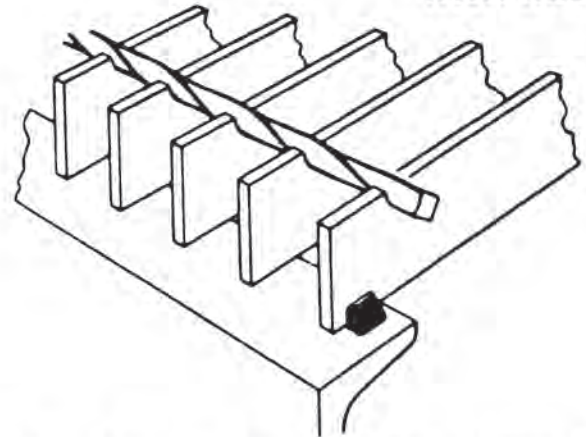

Positive fastening method — grating is welded to supporting steel.

SADDLE CLIP

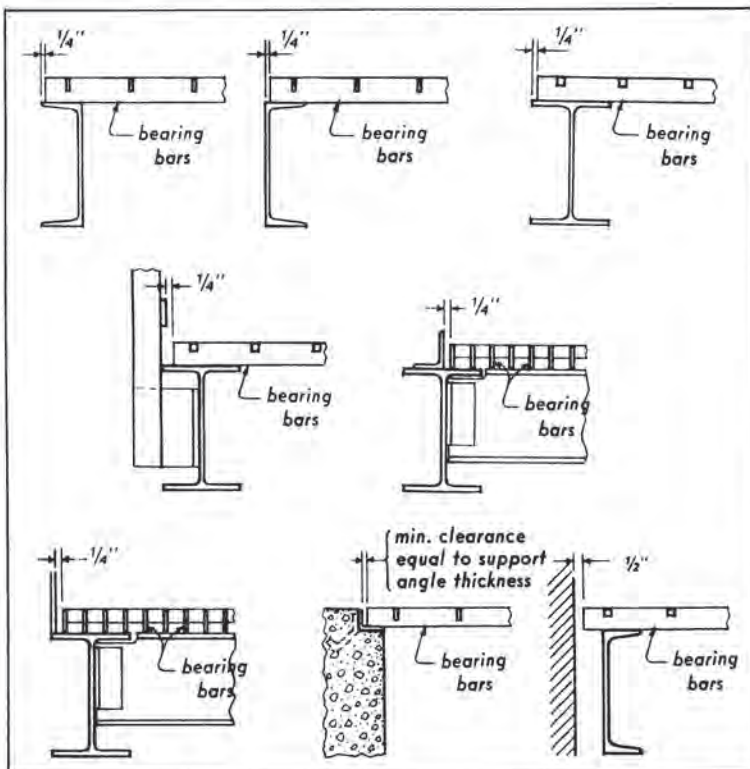
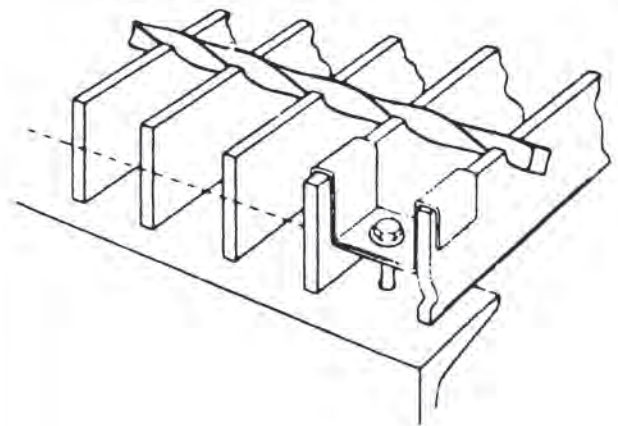

We accept
Visa/MasterCard/American Express.

GRATING STAIR TREADS

STAIR TREAD ABRASIVE NOSING

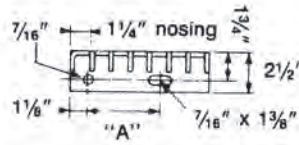
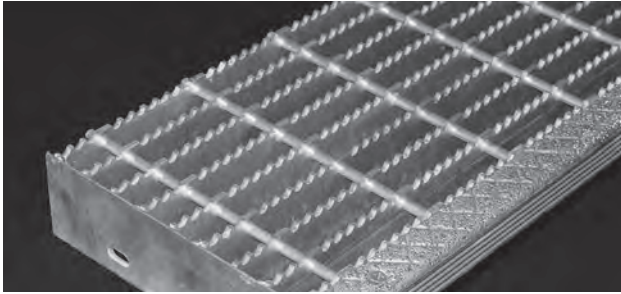

STANDARD

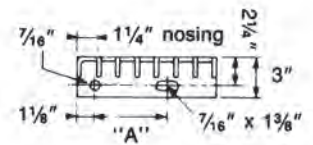

ALSO AVAILABLE
(MUST SPECIFY)

STAIR TREAD CHECKER PLATE NOSING

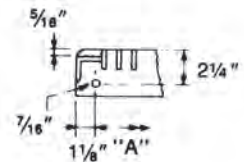
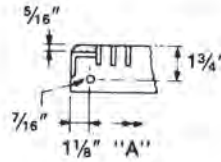
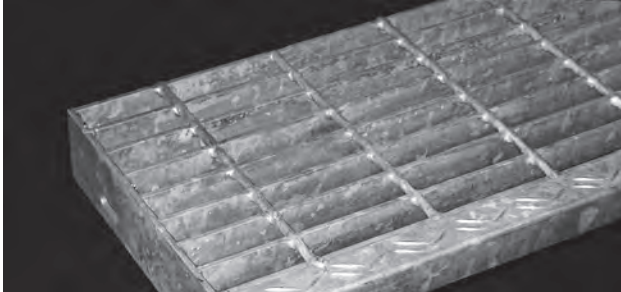

Stair treads can be fabricated in any grating type complete with carrier plates at each end of tread for bolting to stair stringers. Tread nosing makes the leading edge of each step stand out clearly. Serrated treads are recommended to eliminate hazardous footing conditions.

Bearing Bar Spacing

Standard		Close	
Width	"A" Dim.	Width	"A" Dim.
6 ³ / ₁₆	2 ¹ / ₂	6 ¹ / ₈	2 ¹ / ₂
7 ³ / ₈	4 ¹ / ₂	7 ¹ / ₁₆	4 ¹ / ₂
8 ⁹ / ₁₆	4 ¹ / ₂	8	4 ¹ / ₂
9 ³ / ₄	7	8 ¹⁵ / ₁₆	4 ¹ / ₂
10 ¹ / ₈	7	9 ⁷ / ₈	7
12 ¹ / ₈	7	10 ¹³ / ₁₆	7

Note: When using 1/8" thick bearing bar, tread width is 1/16" less.

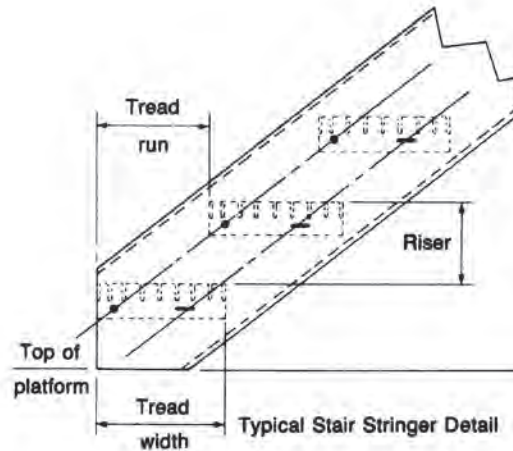

Tread Weights

Tread Width	3/4 x 3/16		1 x 3/16		1 1/4 x 3/16	
	Wgt.	Add for Additional Inch	Wgt.	Add for Additional Inch	Wgt.	Add for Additional Inch
6 ³ / ₁₆	7.83	.34	9.03	.41	10.23	.48
7 ³ / ₈	8.97	.39	10.41	.47	11.85	.55
8 ⁹ / ₁₆	10.11	.43	11.79	.52	13.47	.62
9 ³ / ₄	11.25	.48	13.17	.59	15.09	.69
10 ¹ / ₈	12.39	.53	14.55	.65	16.71	.76
12 ¹ / ₈	13.53	.57	15.93	.71	18.33	.84

Based on standard spacing of bearing bars and base length of tread 1'6" — for 1/8" thick bearing bars deduct 10% from above weights. For close space bearing bars add 20%.

Bearing Bar Guide Table

Bearing Bars	Maximum Length*	
	Plain	Serr
3/4 x 3/16	2'-2"	—
1 x 1/8	2'-4"	2'-0"
1 x 3/16	3'-0"	2'-6"
1 1/4 x 1/8	3'-0"	2'-8"
1 1/4 x 3/16	4'-0"	3'-5"
1 1/2 x 3/16	5'-3"	4'-7"

*Maximum tread length based on 400-lb. concentrated load on nosing and 4 bearing bars at center of tread length. For maximum length under other loadings, consult Metals, Inc.

HEX METAL REFRACTORY LINING SPECS

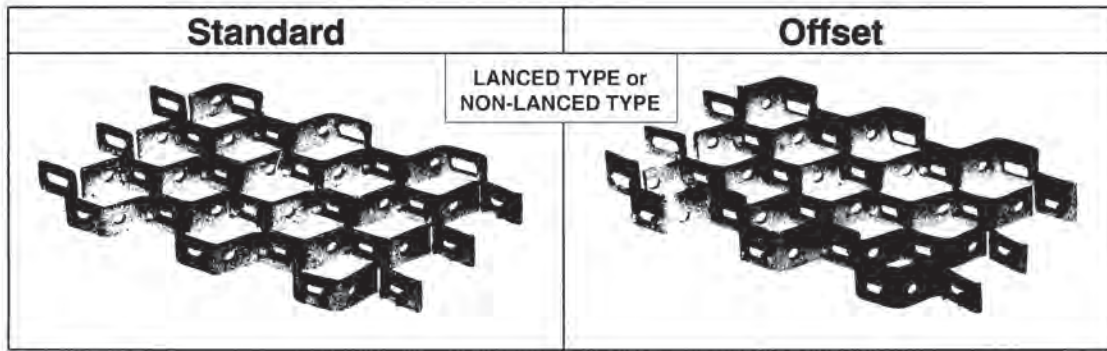

Depth x Ga. Thickness	FORMED MIN. ID		WEIGHT LBS. PER SQ. FT.		
	Stiff Direction	Flexible Direction	Carbon Steel	Stainless Steel	
			1010 Carbon	300 Series	400 Series
3/4 x 14 GA.	1'-0"	4'-0"	2.8	2.88	2.75
3/4 x 12 GA.	1'-0"	4'-11"	3.9	4.01	3.82
1 x 14 GA.	1'-7"	4'-6"	4.3	4.42	4.22
1 x 12 GA.	1'-7"	5'-5"	5.4	5.55	5.30
1-1/4" x 14 GA.	2'-2"	5'-0"	5.0	5.08	4.92
1-1/4" x 12 GA.	2'-2"	5'-11"	6.8	6.91	6.72
3/4 x 14 GA. Offset Every 3rd Bar 1" x 14 GA.	1'-7"	4'-6"	3.34	3.58	3.29
3/4 x 14 GA. Offset Every 4th Bar 1" x 14 GA.	1'-7"	4'-6"	3.24	3.51	3.19
3/4 x 14 GA. Offset Every 5th Bar 1" x 14 GA.	1'-7"	4'-6"	3.21	3.49	3.16
3/4 x 14 GA. Offset Every 6th Bar 1" x 14 GA.	1'-7"	4'-6"	3.15	3.44	3.10

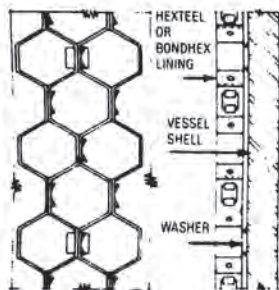

MOUNTED ON WASHERS ON THE VESSEL WALL

Washer spacers let castable refractory material flow under as well as through Hexteel or Bondhex, reducing heat transfer to the vessel wall. Recommended wherever erosion is a problem.

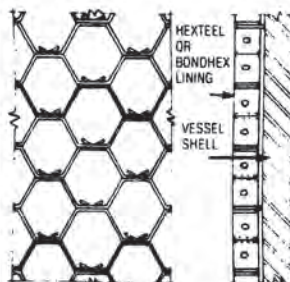

OFFSET HEXTEEL/BONDHEX MOUNTED DIRECTLY TO VESSEL WALL

Spacers aren't needed with offset Hexteel or Bondhex, because every third or sixth bar (as specified in order) is 1/4" deeper than the others, allowing 1/4" layer of refractory behind reinforcement to form a truly monolithic lining.

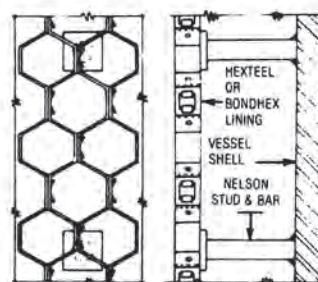

HEXTEEL/BONDHEX MOUNTED ON WELDED STUDS

In double-layer construction, a light castable insulating material is used between the vessel wall and the refractory lining supported by Hexteel or Bondhex. Heat loss is minimized, and lining is both reinforced and armored.

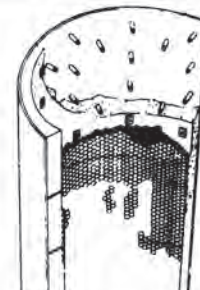

INTERIOR OF A DOUBLE-LAYER VESSEL LINING

Welded-stud spacers determine thickness of insulation layer. Hexteel or Bondhex retains insulation, supports and reinforces dense refractory lining, and retards erosion by hot gases.

GRIP STRUT SAFETY GRATING

Specifications shown are for Galv. Steel.

HRPO, BLACK STEEL, STAINLESS & ALUMINUM are also available.

For Load Tables & additional information, refer to the Grip Strut Safety Grating Catalog.

Plank Width	Gauge	Channel Depth	Weight lb/lin. ft.	Part No.	Max. Span* with 1/4" or less deflection	
2-Diamond Planks 4 3/4" Width	14 GA.	1 1/2	2.3	21514	5'-0	
		2	2.6	22014	6'-0	
		2 1/2	2.8	22514	7'-0	
	12 GA.	1 1/2	3.2	21512	5'-6	
		2	3.6	22012	6'-6	
		2 1/2	4.0	22512	7'-6	
3-Diamond Planks 7" Width	14 GA.	1 1/2	3.0	31514	4'-6	
		2	3.2	32014	5'-6	
		2 1/2	3.5	32514	6'-6	
	12 GA.	1 1/2	4.1	31512	5'-0	
		2	4.5	32012	6'-0	
		2 1/2	4.9	32512	7'-0	
	3	5.2	33012	7'-6		
	14 GA.	1 1/2	3.6	41514	4'-6	
		2	3.8	42014	5'-0	
2 1/2		4.1	42514	6'-0		
4-Diamond Planks 9 1/2" Width	12 GA.	1 1/2	5.0	41512	4'-6	
		2	5.4	42012	5'-6	
		2 1/2	5.7	42512	6'-6	
	3	6.1	43012	7'-0		
		14 GA.	1 1/2	4.2	51514	4'-0
			2	4.4	52014	5'-0
2 1/2	4.7		52514	5'-6		
5-Diamond Planks 11 3/4" Width	12 GA.	1 1/2	5.9	51512	4'-6	
		2	6.2	52012	5'-0	
		2 1/2	6.6	52512	5'-0	
	3	7.0	53012	7'-0		
		14 GA.	1 1/2	6.1	81514	3'-0
			2	6.3	82014	4'-0
2 1/2	6.6		82514	4'-6		
8-Diamond Planks 18 3/4" Width	12 GA.	1 1/2	8.5	81512	3'-6	
		2	8.9	82012	4'-6	
		2 1/2	9.2	82512	5'-0	
	3	9.6	83012	5'-6		
		14 GA.	2	7.4	102014	3'-6
			3	7.9	103014	4'-6
10-Diamond Planks 24" Width	12 GA.	2	10.4	102014	4'-0	
		3	11.1	103014	5'-6	
10-Diamond Walkway 24" Width	14 GA.	4 1/2	8.9	104514-U	5'-6	
	12 GA.	4 1/2	12.5	104512-U	7'-0	

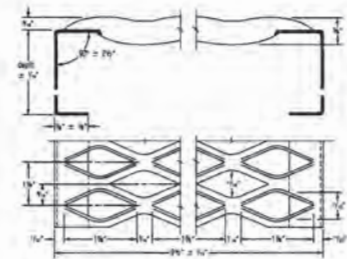

PLANK

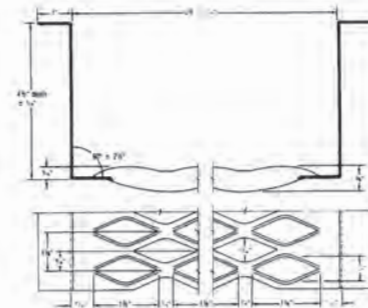

WALKWAY



Call Us With Your MasterCard/Visa/American Express



GRIP STRUT STAIR TREADS

SAFE LOADING

U-Uniform Load (lb./sq. ft.) C-Concentrated Load (lb.)		2-Diamond 4½" depth				3-Diamond 7" depth				4-Diamond 9½" depth				5-Diamond 11½" depth			
Material/ Gauge		STEEL		STEEL		STEEL		STEEL		STEEL		STEEL		STEEL		STEEL	
Gauge		14		12		14		12		14		12		14		12	
Span	Channel Depth—In.	U	C	U	C	U	C	U	C	U	C	U	C	U	C	U	C
2'0"	1½	1191	472	1576	624	761	443	1006	587	549	435	750	595	434	425	575	563
	2	1978	783	2513	995	1262	737	1604	936	911	604	1158	917	721	573	916	897
2'6"	1½	764	378	1011	500	488	356	645	470	353	349	481	476	278	342	369	452
	2	1268	611	1611	797	810	590	1029	750	584	578	742	734	463	566	587	719
3'0"	1½	532	315	703	418	340	300	450	393	245	300	335	398	194	300	258	378
	2	882	524	1121	665	563	492	716	626	407	483	517	614	322	473	409	601
4'0"(1)	2	498	394	633	501	318	372	404	472	230	364	292	463	182	356	232	454

(1) Intermediate stringer is recommended for spans over 4 ft.

Standard Sizes and Recommended Spans⁽¹⁾

STEEL		STANDARD STAIR TREADS			STAIR TREADS WITH ABRASIVE NOSING	
Span in.	Gauge	Channel Depth—In.	Catalog Number	Size in.	Catalog Number	Size in.
Up to 30	14	1½	T-21514	2-Dia.—4¾	T-31514-N	3-Dia.—8½
			T-31514	3-Dia.—7		
			T-41514	4-Dia.—9½		
			T-51514	5-Dia.—11¼		
30 to 36	14	1½	T-21514	2-Dia.—4¾	T-31514-N	3-Dia.—8½
			T-31514	3-Dia.—7		
			T-41514	4-Dia.—9½		
			T-51514	5-Dia.—11¼		
36 to 42	14	1½	T-21514	2-Dia.—4¾	T-31514-N	3-Dia.—8½
			T-31514	3-Dia.—7		
			T-41514	4-Dia.—9½		
			T-51514	5-Dia.—11¼		
42 to 48	14	2	T-22014	2-Dia.—4¾	T-32014-N	3-Dia.—8½
			T-32014	3-Dia.—7		
			T-42014	4-Dia.—9½		
			T-52014	5-Dia.—11¼		

(1) Recommendations are based on approx. min. loads of 300 lb. concentrated; 100 lb. uniform. Specific performance criteria may vary by municipality/building code body and should be locally checked prior to finalizing specifications.

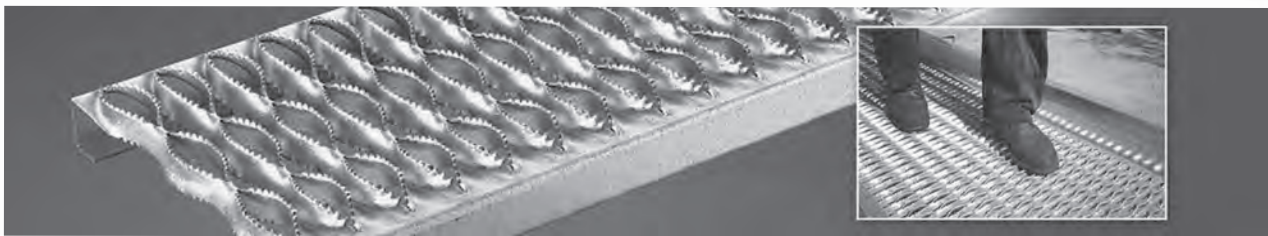

Galv. Steel, Aluminum and Stainless Steel⁽¹⁾

Standard				With Abrasive Nosing			
A	B	C	D	A	B	C	D
4¾" (2-dia.)	1½" 2"	¾" 1"	2½" 2⅝"	—	—	—	—
7" (3-Dia.)	1½" 2"	¾" 1"	3⅝" 3⅞"	8⅝" (3-Dia.)	1½" 2"	¾" 1"	4½" 4⅞"
9½" (4-Dia.)	1½" 2"	¾" 1"	5⅝" 5⅞"	10½" (4-Dia.)	1½" 2"	¾" 1"	6⅝" 6⅞"
11¼" (5-Dia.)	1½" 2"	¾" 1"	8⅝" 8⅞"	—	—	—	—

(1) Stainless steel not available in 2- and 3-Diamond widths.

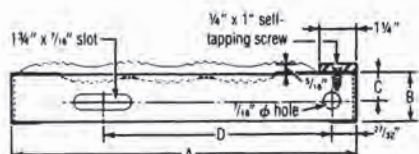
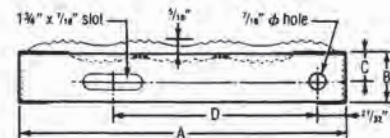

HEAVY DUTY GRIP STRUT

Specifications shown are for Galv. Steel.

For load tables & additional information, refer to the Heavy Duty Grip Strut Catalog.

Plank Width	Gauge	Channel Depth	Weight lb/lin. ft.	Part No.
2-Diamond Plank 9 1/4" Width	10 GA.	2	6.6	H-22011
		2 1/2	7.0	H-22511
		3	7.5	H-23011
		4	8.3	H-24011
3-Diamond Plank 13 3/4" Width	10 GA.	2	8.5	H-32011
		2 1/2	8.9	H-32511
		3	9.3	H-33011
		4	10.1	H-34011
5-Diamond Plank 23 3/4" Width	10 GA.	2	12.7	H-52011
		2 1/2	13.1	H-52511
		3	13.6	H-53011
		4	14.4	H-54011
6-Diamond Plank 27 3/4" Width	10 GA.	2	14.3	H-62011
		2 1/2	14.7	H-62511
		3	15.2	H-63011
		4	16.0	H-64011
8-Diamond Plank 36" Width	10 GA.	2	18.0	H-82011
		2 1/2	18.4	H-82511
		3	18.9	H-83011
		4	19.7	H-84011
5-Diamond Walkway 24" Wide	10 GA.	5	17.5	H-55010-W
6-Diamond Walkway 30" Wide	10 GA.	5	19.9	H-65010-W
8-Diamond Walkway 36" Wide	10 GA.	5	22.7	H-85010-W

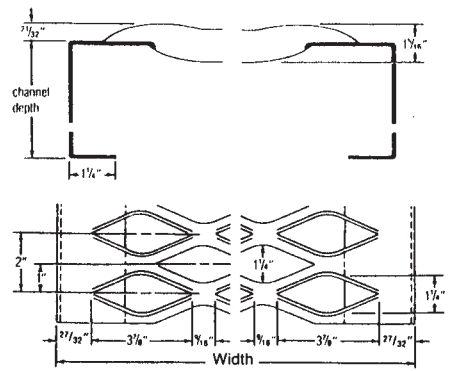

HEAVY DUTY PLANK

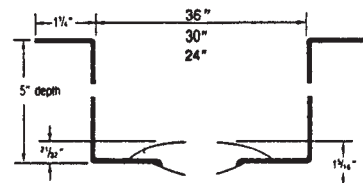

HEAVY DUTY WALKWAY

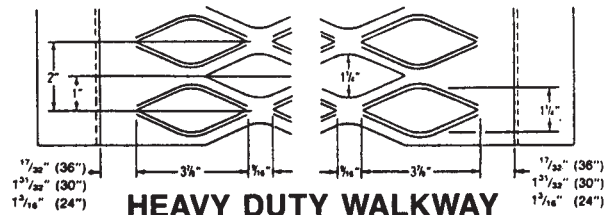

PERF-O-GRIP™

PERF-O GRIP™ WALKWAY

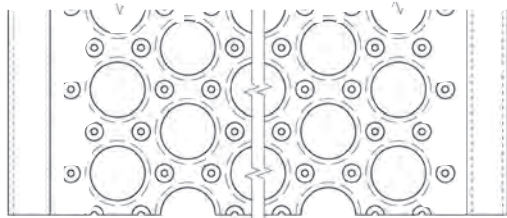

Perf-U-Grip

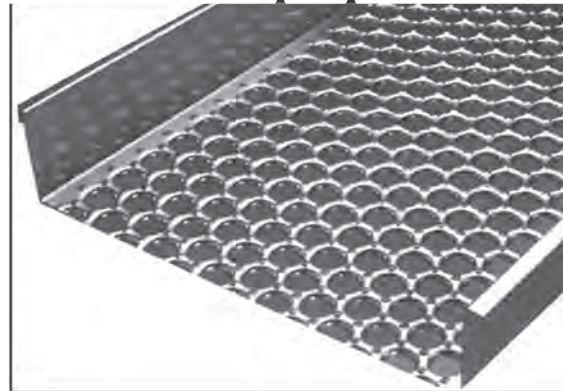

Features:

- large debossed holes provide at least 50% free air opening.
- smooth continuous edge of debossed holes prevents debris from adhering to walking surface.
- walking surface offers slip resistance without excessive abrasive characteristics.
- light weight.
- one-piece metal construction.
- virtually maintenance free.

Specifications:

Safety grating planks shall be manufactured from one-piece material having debossed holes each surrounded by 6 perforated buttons.

Safety grating planks shall have integral side channels and be manufactured from:

- pre-galvanized steel — Z275 (G90)
- aluminum alloy 5052 H32
- stainless steel type 304 or 316 (special make only)

Product Standards:

Materials:

steel — 13 gauge or 11 gauge galvanized (or hot rolled steel).

aluminum — 0.125" thickness, alloy 5052 H32

Stock Lengths:

- 10' or 12'
- special cut sizes available upon request

Other combinations of channel depths and material thicknesses can be manufactured.

*Indicates sizes not normally stocked.
Contact Metals, Inc. for delivery information.

Widths Available	Material Thickness/Channel Depth		
	Galvanized	Hot Rolled Steel	Aluminum
5"	13 ga/1½" 2"	13 ga/1½" 2"	*
7"	13 ga/1½" 2"	13 ga/1½" or 2"	*
	11 ga/1½" 2"		
10"	13 ga/1½" 2"	13 ga/1½" or 11 ga	.125"/2"
	11 ga/1½" 2"		
12"	13 ga/1½" 2"	13 ga/1½" or 11 ga	.125"/2"
	11 ga/1½" 2"		
18"	13 ga/1½" 2"	.125"/2"	N/A
	11 ga/1½" 2"		
24"	13 ga/1½" 2"	.125"/2"	N/A
	11 ga/1½" 2"		

GRATE-LOCK GRATING

For Load Tables & additional information, refer to the Grate-Lock Grating Catalog.

Plank Sections

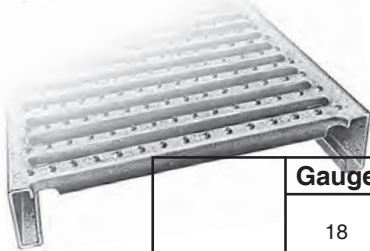
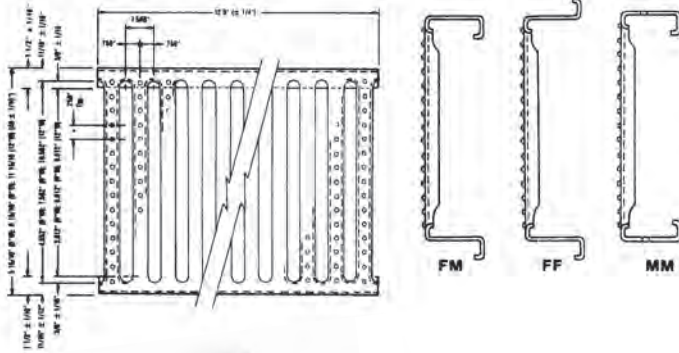

Channel Depth	Gauge	Width	Part No.	
1½"	18	12	MG-121518	
		9	MG-91518	
		6	MG-61518	
2½"	14	12	MG-121514	
		9	MG-91514	
		6	MG-61514	
	18	12	MG-122518	
		9	MG-92518	
		6	MG-62518	
14	12	MG-122514		
	9	MG-92514		
	6	MG-62514		

Stair Treads

Stair treads are available in standard and custom designs. Contact Metals, Inc., for more information.

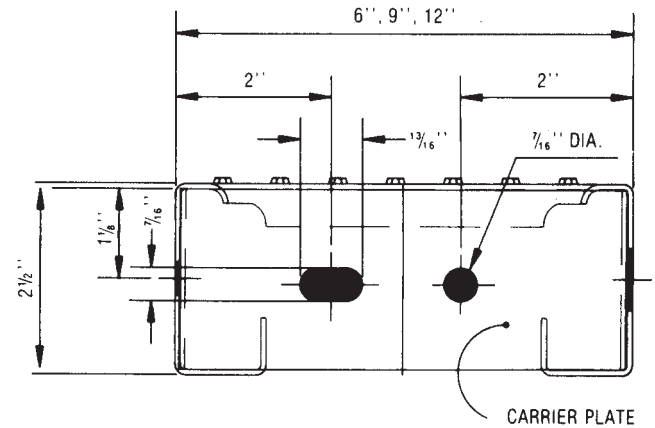

Stairtread Design/Selection Table

U - Uniform Load (Lb/Sq. Ft) C - Concentrated Load (Lb)	CATALOG NUMBER					
	T-MG62514		T-MG92514		T-MB122514	
SPAN	U	C	U	C	U	C
2'0"	3722	1461	2357	974	1276	730
2'6"	2382	1168	1508	974	816	730
3'0"	1654	1241	1050	974	783	730
4'0"*	931	931	593	889	442	730

*Intermediate stringer recommended for spans over 4'.

Metal Fabrication Services

Let Metals, Inc. be your metal fabrication supplier.

We have over 30 years of experience and offer unparalleled quality and support for our customers. Our experienced team can assist you with any of your welding, shearing or cutting needs.

Metals, Inc. has a wide range of fabricating equipment:

- ▶ 10' Long 1/4" Capacity Niagara Shear
- ▶ 10' Long 1/4" Capacity CNC Promecan Hydraulic Press Brake
- ▶ 36" Capacity Record Friction Saw
- ▶ 36" Capacity Trennjaeger Promocut Cold Saw
- ▶ 40 Ton Scotchman and 100 Ton Edwards Iron Workers
- ▶ 36" Capacity CNC Kalamazoo Band Saw
- ▶ Three welding stations, including CNC plasma cutting



TRACTION TREAD

TRACTION TREAD™ SHEETS

Ideal for pedestrian traffic, even high heels

- HRPO steel or aluminum
- anti-slip perforated buttons drain spillage
- work shoes not required

TRACTION TREAD™ Sheets are ideal for manufacturing special and fabricated products or for use as a reconditioning material. May be ordered flat or in formed planks. Flat stock is available in standard 36" x 120" (3' x 10') flat sheets or may be cut to order. Metal options are hot rolled pickled and oiled steel, 12-ga. (4.4 lb./sq. ft.), and 5052-H32 aluminum .125" (1.6 lb./sq. ft.) and 16 gauge.

Material	Thickness	Lbs./Sq. Ft.
HRPO steel	11 gauge	5.0
	13 gauge	3.8
	16 gauge	2.5
Aluminum type 5052-H32	.125"	1.6



Each button opening is designed to provide superior slip resistance in all directions.

TRACTION TREAD LADDER RUNGS

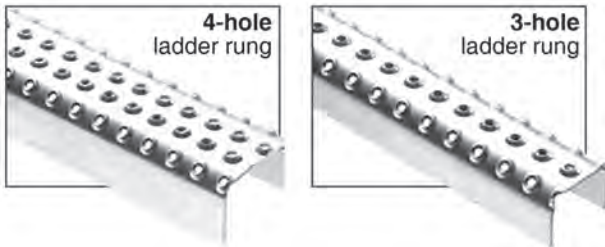

2 hole ladder rungs also available.

TRACTION TREAD PLANK GRATING

Material	Plank Width	Length	Channel Height
• Galvanized			
• HRPO steel:	7", 10", 12"	120"	1½" min.
		144"	2" min.
• .125" aluminum 5052-H32			

Traction Tread™ Flooring feature a surface with hundreds of perforated buttons that provide slip-resistance in all directions making it a practical choice for industrial applications. Traction Tread is also appropriate for commercial applications where pedestrian traffic is a consideration, perfectly suited for ADA compliant requirements.

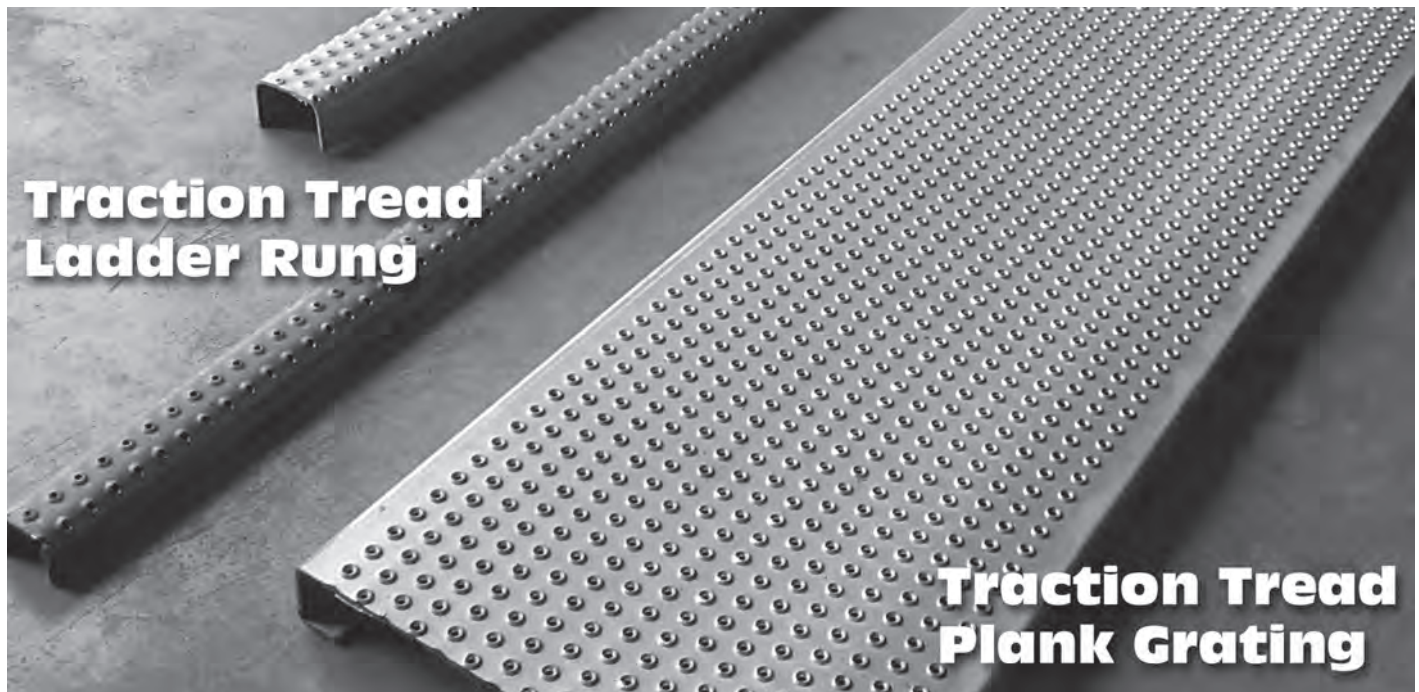

WOVEN & WELDED WIRE CLOTH / MESH

A SAMPLE OF WEAVES AVAILABLE

WEAVES

Square Opening

This is a general purpose weave used for many screening and washing applications.

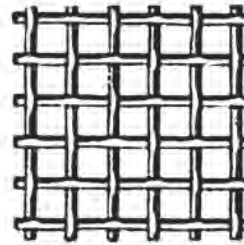

Plain Square Weave

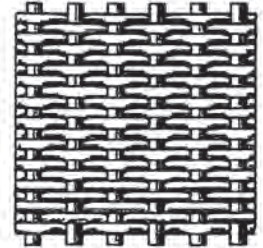

Plain Dutch Weave



Twilled Square Weave



Twilled Dutch Weave

CRIMPS

Conventional Double Crimp

Most popular type. Used where the opening is relatively small in comparison to the wire diameter (3 to 1 or less).



Double Crimp

Lock Crimp

Used in coarse specifications to maintain the accuracy of weave throughout screen life where the opening is large with respect to wire diameter (3 to 1 or greater).

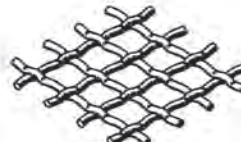

Lock Crimp

Flat Top

Usually starts at 5/8" opening and larger. Provides longest abrasive resistant life since there are no projections on top to wear. Offers least resistance to flow.

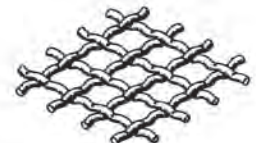

Inter-Crimp

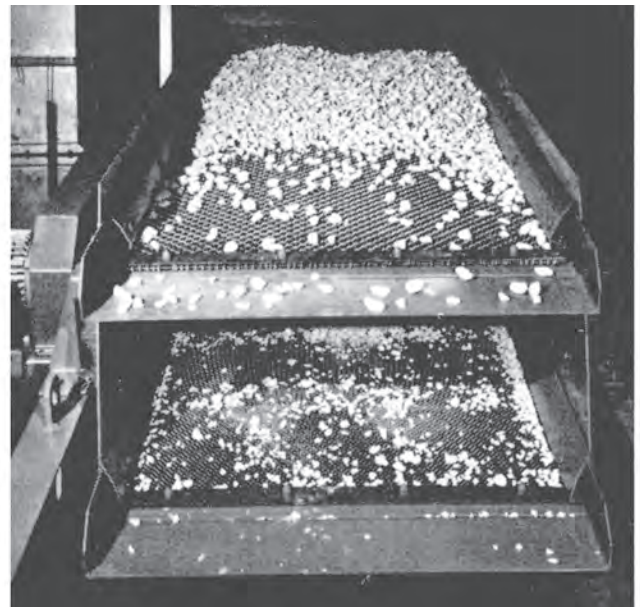

SQUARE MESH WIRE CLOTH

Mesher per Lineal Inch	Diameter of Wire Inches	Width of Opening Inches	Open Area Percent	Weight lbs. per 100 sq. ft. (Steel)	Mesher per Lineal Inch	Diameter of Wire Inches	Width of Opening Inches	Open Area Percent	Weight lbs. per 100 sq. ft. (Steel)	Mesher per Lineal Inch	Diameter of Wire Inches	Width of Opening Inches	Open Area Percent	Weight lbs. per 100 sq. ft. (Steel)
3/4" center to center	.250	.5000	44.4	562.3	1" center to center	.250	.7500	56.3	412.4	2	.250	.2500	25.0	894.6
	.225	.5250	49.0	451.0		.225	.7750	60.1	332.1		.225	.2750	30.3	710.6
	.207	.5430	52.4	379.4		.207	.7930	62.9	280.1		.207	.2930	34.3	593.8
	.192	.5580	55.3	324.8		.192	.8080	65.3	240.3		.192	.3080	37.9	505.5
	.177	.5730	58.3	274.7		.177	.8230	67.7	203.7		.177	.3230	41.7	425.4
	.162	.5880	61.4	229.2		.162	.8380	70.2	170.2		.162	.3380	45.7	353.3
	.148	.6020	64.4	190.5		.148	.8520	72.6	141.7		.148	.3520	49.6	292.4
	.135	.6150	67.2	158.1		.135	.8560	74.8	117.7		.135	.3650	53.3	241.7
	.120	.6300	70.5	124.4		.120	.8800	77.4	92.8		.120	.3800	57.8	189.6
	.105	.6450	73.9	95.0		.105	.8950	80.1	71.0		.105	.3950	62.4	144.2
	.092	.6580	76.9	72.8		.092	.9080	82.4	54.4		.092	.4080	66.6	110.2
	.080	.6700	79.8	54.9		.080	.9200	84.6	41.1		.080	.4200	70.6	83.0
	.072	.6780	81.7	44.5		.072	.9280	86.1	33.3		.072	.4280	73.3	67.1
	.063	.6870	83.9	34.0		.063	.9370	87.8	25.5		.063	.4370	76.4	51.2
	.054	.6960	86.1	24.9							.054	.4460	79.6	37.6
											.047	.4530	82.1	28.4
2 1/2	.225	.1750	19.1	929.3	3	.162	.1713	26.3	560.4	4	.148	.1020	16.6	619.1
	.207	.1930	23.3	772.2		.148	.1853	30.8	460.2		.135	.1150	21.2	503.8
	.192	.2080	27.0	654.4		.135	.1983	35.3	377.6		.120	.1300	27.0	388.6
	.177	.2230	31.1	548.2		.120	.2133	40.8	293.9		.105	.1450	33.6	306.2
	.162	.2380	35.4	453.1		.105	.2283	46.8	222.0		.092	.1580	39.9	231.0
	.148	.2520	39.7	373.7		.092	.2413	52.3	168.7		.080	.1700	46.2	172.1
	.135	.2650	43.9	307.8		.080	.2533	57.6	126.4		.072	.1780	50.7	138.2
	.120	.2800	49.0	240.6		.072	.2613	61.3	101.9		.063	.1870	56.0	104.8
	.105	.2950	54.4	182.4		.063	.2703	65.6	77.6		.054	.1960	61.5	76.4
	.092	.3080	59.3	139.0		.054	.2793	70.1	56.7		.047	.2030	65.9	57.6
	.080	.3200	64.0	104.4		.047	.2863	73.6	42.8		.041	.2090	69.9	43.6
	.072	.3280	67.2	84.3		.041	.2923	76.7	32.5		.035	.2150	74.0	31.7
	.063	.3370	71.0	64.3		.035	.2983	79.9	23.7		.032	.2180	76.0	26.4
	.054	.3460	74.8	47.1		.032	.3013	81.5	19.7		.028	.2220	78.9	20.2
	.047	.3530	77.9	35.6							.025	.2250	81.0	16.1
	.041	.3590	80.6	27.0										
.035	.3650	83.3	19.7											



1 in. mesh
opening .8650 in.
.1350 in. dia. wire



2 mesh
opening .4375 in.
.0625 in. dia. wire



3 mesh
opening .2793 in.
.0540 in. dia. wire

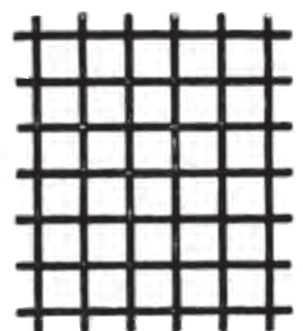

4 mesh
opening .2025 in.
.0475 in. dia. wire

SQUARE MESH WIRE CLOTH

Mesher per Lineal Inch	Diameter of Wire Inches	Width of Opening Inches	Open Area Percent	Weight lbs. per 100 sq. ft. (Steel)	Mesher per Lineal Inch	Diameter of Wire Inches	Width of Opening Inches	Open Area Percent	Weight lbs. per 100 sq. ft. (Steel)	Mesher per Lineal Inch	Diameter of Wire Inches	Width of Opening Inches	Open Area Percent	Weight lbs. per 100 sq. ft. (Steel)
4½	.120	.1022	21.1	447.9	5	.120	.0800	16.0	510.6	6	.092	.0747	20.2	352.8
	.105	.1172	27.7	333.7		.105	.0950	22.6	378.7		.080	.0867	27.2	259.1
	.092	.1302	34.2	263.9		.092	.1080	29.2	283.4		.072	.0947	32.5	216.9
	.080	.1422	40.8	195.9		.080	.1200	36.0	220.6		.063	.1037	38.9	163.0
	.072	.1502	45.6	157.0		.072	.1280	41.0	176.4		.054	.1127	46.0	117.7
	.063	.1592	51.2	118.9		.063	.1370	46.9	133.2		.047	.1197	51.8	88.2
	.054	.1682	57.2	86.4		.054	.1460	53.3	96.7		.041	.1257	57.2	66.5
	.047	.1752	62.0	65.0		.047	.1530	58.5	72.6		.035	.1317	62.7	48.1
	.041	.1812	66.3	49.2		.041	.1590	63.2	54.9		.032	.1347	65.6	40.0
	.035	.1872	70.8	35.7		.035	.1650	68.1	39.8		.028	.1387	69.6	30.5
	.032	.1902	73.1	29.8		.032	.1680	70.6	33.2		.025	.1417	72.6	24.3
	.028	.1942	76.2	22.8		.028	.1720	74.0	25.3		.023	.1437	74.7	20.5
	.025	.1972	78.6	18.1		.025	.1750	76.6	20.2		.020	.1467	77.8	15.5
	.023	.1972	78.6	18.1		.023	.1770	78.3	17.0					
8	.072	.0530	18.0	291.1	9	.072	.0391	12.3	338.2	10	.063	.0370	13.7	285.4
	.063	.0620	24.6	216.3		.063	.0481	18.7	249.8		.054	.0460	21.2	201.5
	.054	.0710	32.3	162.7		.054	.0571	26.3	177.4		.047	.0530	28.1	148.4
	.047	.0780	38.9	120.9		.047	.0641	33.2	138.2		.041	.0590	34.8	116.3
	.041	.0840	45.2	90.6		.041	.0701	39.7	103.2		.035	.0650	42.3	83.1
	.035	.0900	51.8	65.1		.035	.0761	46.8	74.0		.032	.0680	46.2	68.8
	.032	.0930	55.4	54.1		.032	.0791	50.6	61.4		.028	.0720	51.8	52.1
	.028	.0970	60.2	41.1		.028	.0831	55.8	46.6		.025	.0750	56.3	41.2
	.025	.1000	64.0	32.6		.025	.0861	59.9	36.9		.023	.0770	59.3	34.7
	.023	.1020	66.6	27.5		.023	.0881	62.7	31.1		.020	.0800	64.0	26.1
	.020	.1050	70.6	20.7		.020	.0911	67.1	23.4		.018	.0820	67.2	21.1
	.018	.1070	73.3	16.8		.018	.0931	70.1	18.9		.017	.0830	68.9	18.8
	.017	.1080	74.6	14.9		.017	.0941	71.6	16.8		.016	.0840	70.6	16.6
						.016	.0951	73.1	14.9		.015	.0850	72.3	14.6

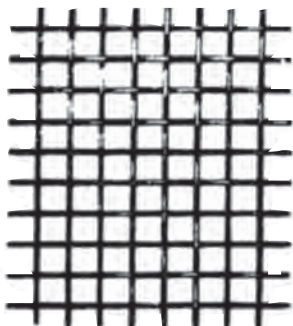

6 mesh
opening .1319 in.
.0348 in. dia. wire

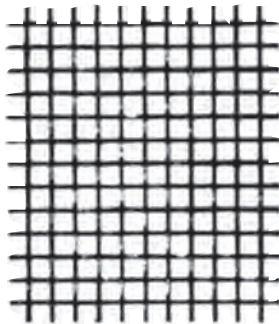

8 mesh
opening .0964 in.
.0286 in. dia. wire

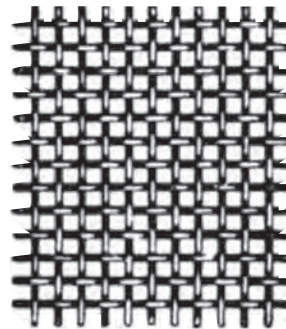

8 mesh
opening .0775 in.
.0475 in. dia. wire

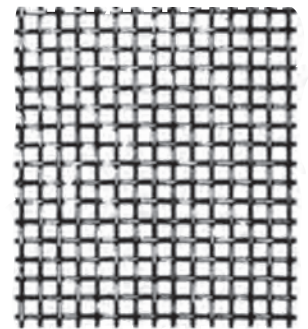

10 mesh
opening .0742 in.
.0258 in. dia. wire

SQUARE MESH WIRE CLOTH

Mesher per Lineal Inch	Diameter of Wire Inches	Width of Opening Inches	Open Area Percent	Weight lbs. per 100 sq. ft. (Steel)	
12	.047	.0363	18.7	185.1	
	.041	.0423	25.4	136.7	
	.035	.0483	33.2	102.1	
	.032	.0513	37.5	84.3	
	.028	.0553	43.6	63.5	
	.025	.0583	48.4	50.1	
	.023	.0603	51.8	42.2	
	.020	.0633	57.2	31.6	
	.018	.0653	60.8	25.5	
	.017	.0663	62.7	22.7	
	.016	.0673	64.5	20.0	
	.015	.0683	66.6	17.6	
	.014	.0693	68.6	15.3	
	20	.020	.0815	23.1	71.3
		.018	.0205	28.4	56.6
		.017	.0215	31.2	52.6
.016		.0225	34.2	46.1	
.015		.0235	37.3	40.2	
.014		.0245	40.6	34.7	
.0135		.0250	42.3	32.1	
.013		.0255	44.0	29.7	
.012		.0265	47.5	25.1	
.011		.0275	51.1	20.9	
.010		.0285	54.9	17.2	
.0095		.0290	56.9	15.5	
.009		.0295	58.8	13.8	
.0085		.0300	60.8	12.3	
.008		.0305	62.9	10.9	
.0075		.0310	65.0	9.5	

Mesher per Lineal Inch	Diameter of Wire Inches	Width of Opening Inches	Open Area Percent	Weight lbs. per 100 sq. ft. (Steel)	
16	.041	.0215	11.8	195.6	
	.035	.0275	19.4	136.6	
	.032	.0305	23.8	111.9	
	.028	.0345	30.5	83.6	
	.025	.0375	36.0	68.9	
	.023	.0395	39.9	57.7	
	.020	.0425	46.2	43.0	
	.018	.0445	50.7	34.5	
	.017	.0455	53.0	30.7	
	.016	.0465	55.4	27.1	
	.015	.0475	57.8	23.7	
	.014	.0485	60.2	20.6	
	.0135	.0490	61.5	19.1	
	.013	.0495	62.7	17.7	
	.012	.0505	65.3	15.0	
	.011	.0515	67.9	12.6	
24	.010	.0525	70.6	10.4	
	.0095	.0530	71.9	9.4	
	24	.025	.0167	16.1	106.4
		.023	.0187	20.1	88.2
		.020	.0217	27.1	64.8
		.018	.0237	32.4	51.5
		.017	.0247	35.1	48.0
		.016	.0257	38.0	42.1
		.015	.0267	41.1	36.7
		.014	.0277	44.2	31.8
		.0135	.0282	45.8	29.4
		.013	.0287	47.4	27.2
		.012	.0297	50.8	23.0
		.011	.0307	54.3	19.2
		.010	.0317	57.9	15.8
		.0095	.0322	59.7	14.2
.009		.0327	61.6	12.7	
.0085		.0332	63.5	11.3	
.008	.0337	65.4	10.0		
.0075	.0342	67.4	8.8		

Mesher per Lineal Inch	Diameter of Wire Inches	Width of Opening Inches	Open Area Percent	Weight lbs. per 100 sq. ft. (Steel)
18	.032	.0180	13.0	147.9
	.028	.0220	19.4	109.3
	.025	.0250	25.0	85.0
	.023	.0270	29.2	70.8
	.020	.0300	36.0	55.2
	.018	.0320	41.0	44.1
	.017	.0330	43.6	39.1
	.016	.0340	46.2	34.4
	.015	.0350	49.0	30.1
	.014	.0360	51.8	26.1
	.0135	.0365	53.3	24.2
	.013	.0370	54.8	22.4
	.012	.0380	57.8	19.0
	.011	.0390	60.8	15.9
	.010	.0400	64.0	13.1
	.0095	.0405	65.6	11.8
.009	.0410	67.2	10.5	
26	.020	.0815	23.1	71.3
	.018	.0205	28.4	56.6
	.017	.0215	31.2	52.6
	.016	.0225	34.2	46.1
	.015	.0235	37.3	40.2
	.014	.0245	40.6	34.7
	.0135	.0250	42.3	32.1
	.013	.0255	44.0	29.7
	.012	.0265	47.5	25.1
	.011	.0275	51.1	20.9
	.010	.0285	54.9	17.2
	.0095	.0290	56.9	15.5
	.009	.0295	58.8	13.8
	.0085	.0300	60.8	12.3
	.008	.0305	62.9	10.9
	.0075	.0310	65.0	9.5

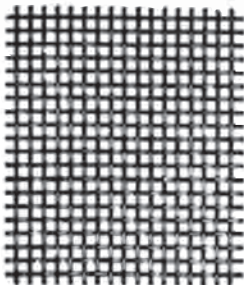

12 mesh
opening .0603 in.
.0230 in. dia. wire



16 mesh
opening .0444 in.
.0181 in. dia. wire

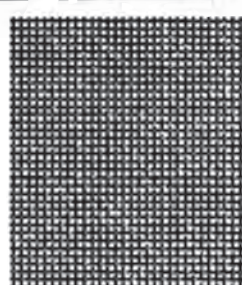

20 mesh
opening .0338 in.
.0162 in. dia. wire

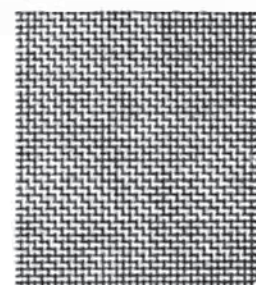

24 mesh
opening .0313 in.
.0104 in. dia. wire

SQUARE MESH WIRE CLOTH

PLAIN WEAVE

Meshes per Lineal Inch	Diameter of Wire Inches	Width of Opening Inches	Open Area Percent	Weight lbs. per 100 sq. ft. (Steel)	Meshes per Lineal Inch	Diameter of Wire Inches	Width of Opening Inches	Open Area Percent	Weight lbs. per 100 sq. ft. (Steel)	Meshes per Lineal Inch	Diameter of Wire Inches	Width of Opening Inches	Open Area Percent	Weight lbs. per 100 sq. ft. (Steel)		
40	.0135	.0115	21.2	53.0	50	.012	.0080	16.0	51.1	100	.0045	.0055	30.3	14.2		
	.013	.0120	23.0	48.8		.011	.0090	20.3	42.0	110	.0040	.0051	31.5	12.4		
	.012	.0130	27.0	40.9		.010	.0100	25.0	34.0	120	.0037	.0046	30.5	10.2		
	.011	.0140	31.4	33.8		.0095	.0105	27.6	32.0	150	.0026	.0041	37.9	7.1		
	.010	.0150	36.0	27.6		.009	.0110	30.3	28.4	160	.0025	.0038	37.0	7.0		
	.0095	.0155	38.4	24.7		.0085	.0115	33.1	25.1	180	.0023	.0033	35.3	6.7		
	.009	.0160	41.0	22.0		.008	.0120	36.0	22.1	200	.0021	.0029	33.6	6.3		
	.0085	.0165	43.6	19.5		.0075	.0125	39.1	19.2	250	.0016	.0024	36.0	4.6		
	.008	.0170	46.2	17.2		80	.0075	.0050	16.0	31.9	TWILLED WEAVE					
	.0075	.0175	49.0	15.0			.007	.0055	19.4	27.4						
	.007	.0180	51.8	13.0			.0065	.0060	23.0	23.2	100	.005	.0045	25.0	17.0	
	60	.011	.0057	11.7			52.9	.006	.0065	27.0	20.4	110	.0045	.0046	25.6	12.4
.010		.0067	16.2	42.6	.0055		.0070	31.4	16.9	120	.0040	.0043	26.6	10.2		
.0095		.0072	18.7	37.9	.005		.0075	36.0	13.8	150	.0030	.0037	30.8	7.1		
.009		.0077	21.3	33.5	250		.0016	.0024	36.0	4.6	160	.0028	.0035	31.4	7.0	
.0085		.0082	24.2	29.6			.0014	.0017	30.5	4.4	180	.0025	.0031	31.1	6.7	
.008		.0087	27.2	27.3			200	.0023	.0027	29.2	6.3	250	.0016	.0024	36.0	4.6
.0075		.0092	30.5	23.7			325	.0014	.0017	30.5	4.4					
.007		.0097	33.9	20.4												
.0065		.0102	37.5	17.4												
.006		.0107	41.2	14.7												

SQUARE OPENING WIRE CLOTH

SQUARE OPENING	WIRE DIAMETER INCHES	% OF OPEN AREA	WEIGHT LBS. PER SQ. FT.	RECOM-MENDED GRADES	SQUARE OPENING	WIRE DIAMETER INCHES	% OF OPEN AREA	WEIGHT LBS. PER SQ. FT.	RECOM-MENDED GRADES	SQUARE OPENING	WIRE DIAMETER INCHES	% OF OPEN AREA	WEIGHT LBS. PER SQ. FT.	RECOM-MENDED GRADES
4"	1.	56.3	16.50	Heavy Medium Heavy Medium Heavy Medium Light	3"	1.	47.9	20.61	Heavy Medium Heavy Medium Light	2 1/4"	1.	64.0	13.06	Heavy Medium Heavy Medium Light
	3/4	64.0	9.79			3/4	70.9	7.68						
	5/8	68.5	7.00			5/8	74.8	5.46						
	1/2	73.5	4.62			1/2	79.0	3.58						
	7/16	76.2	3.59			7/16	81.3	2.77						
	3/8	79.0	2.68			3/8	83.6	2.07						
	5/16	82.0	1.90			5/16	86.0	1.45						
	.283	83.5	1.57			.283	87.2	1.20						
	.263	84.5	1.36			.263	88.0	1.04						
	.250	85.2	1.23			.250	88.6	.94						
	.225	86.5	1.01			.225	82.6	1.31						
	.207	87.5	.86			.207	83.9	1.12						
	.192	88.3	.74			.192	84.9	.97						
	.177	89.2	.63			.177	85.9	.83						
	.162	90.0	.53			.162	87.0	.70						
						.148	88.0	.59						
			.135	89.0	.49									
										2"	1.	44.4	22.49	Heavy Medium Heavy Medium Light
											3/4	52.9	13.57	
											5/8	58.0	9.79	
											1/2	64.0	6.53	
											7/16	67.3	5.11	
											3/8	70.9	3.84	
											5/16	74.8	2.73	
											.283	76.7	2.26	
											.263	78.1	1.97	
											.250	79.0	1.79	
											.225	80.8	1.46	
											.207	82.1	1.25	
											.192	83.2	1.08	
											.177	84.4	.92	
											.162	85.6	.78	
											.148	86.7	.65	
										.135	87.8	.55		
										.120	89.0	.44		

Rectangular openings / Diamond mesh also available.

Call Metals, Inc. for additional information on sizes or alloys not depicted in this catalog.

Toll Free: 1-800-492-7304



SQUARE OPENING WIRE CLOTH

SQUARE OPENING	WIRE DIAMETER INCHES	% OF OPEN AREA	WEIGHT LBS. PER SQ. FT.	RECOMMENDED GRADES
1 3/4"	.207	80.0	1.41	
	.192	81.2	1.22	
	.177	82.5	1.04	
	.162	83.8	.88	
	.148	85.0	.74	
	.135	86.2	.62	
	.120	87.6	.49	
3/4"	5/8	29.7	19.98	
	1/2	36.0	13.79	
	7/16	39.9	11.00	
	3/8	44.4	8.44	Heavy
	5/16	49.8	6.13	
	.283	52.7	5.15	
	.263	54.8	4.52	Medium Heavy
	.250	56.3	4.12	
	.225	59.2	3.41	
	.207	61.4	2.93	Medium
	.192	63.4	2.56	Medium Light
	.177	65.5	2.20	
	.162	67.6	1.87	
	.148	69.8	1.58	
	.135	71.8	1.33	
	.120	74.3	1.07	
	.105	76.9	.83	
.092	79.3	.65		
.080	81.7	.50		
1/4"	.250	25.0	8.95	
	.225	27.7	7.55	
	.207	29.9	6.59	
	.192	32.0	5.82	
	.177	34.3	5.08	
	.162	36.8	4.38	
	.148	39.4	3.76	Heavy
	.135	42.2	3.21	Medium Heavy
	.120	45.6	2.62	Medium
	.105	49.6	2.07	Medium Light
	.092	53.4	1.64	
	.080	57.4	1.28	
	.072	60.3	1.06	
	.063	63.8	.83	
.054	67.6	.62		
.047	70.9	.48		
1/16"	.080	19.5	3.13	
	.072	20.9	2.66	
	.063	24.6	2.15	Heavy
	.054	29.6	1.67	
	.047	33.2	1.40	Medium Heavy
	.041	37.0	1.11	Medium
	.035	42.3	.83	Medium Light

SQUARE OPENING	WIRE DIAMETER INCHES	% OF OPEN AREA	WEIGHT LBS. PER SQ. FT.	RECOMMENDED GRADES
1 1/2"	1.	36.0	27.57	
	3/4	44.4	16.86	
	5/8	49.8	12.27	
	1/2	56.3	8.25	Heavy
	7/16	59.9	6.48	
	3/8	64.0	4.90	Medium Heavy
	5/16	68.5	3.50	Medium
	.283	70.8	2.91	
	.263	72.4	2.54	
	.250	73.4	2.31	Medium Light
1/2"	7/16	28.4	14.42	
	3/8	32.7	11.19	
	5/16	37.9	8.24	
	.283	40.8	6.96	
	.263	42.9	6.14	
	.250	44.4	5.62	
	.225	47.5	4.68	
	.207	49.8	4.04	Heavy
	.192	52.2	3.54	Medium Heavy
	.177	54.5	3.06	Medium
	.162	57.1	2.61	Medium Light
	.148	59.5	2.22	
	.135	62.0	1.88	
	.120	65.0	1.51	
.105	68.3	1.18		
.092	71.3	.93		
.080	74.3	.71		
.072	76.4	.58		
.063	78.9	.45		
3/16"	.192	24.4	6.97	
	.177	26.5	6.12	
	.162	28.8	5.30	
	.148	31.3	4.57	
	.135	33.8	3.92	Heavy
	.120	37.2	3.22	Medium Heavy
	.105	41.1	2.56	
	.092	45.1	2.04	Medium
	.080	49.1	1.60	Medium Light
	.072	52.2	1.33	
.063	56.0	1.05		
.054	60.3	.79		
.047	63.9	.62		
.041	67.3	.48		

SQUARE OPENING	WIRE DIAMETER INCHES	% OF OPEN AREA	WEIGHT LBS. PER SQ. FT.	RECOMMENDED GRADES
1"	3/4	32.6	22.38	
	5/8	37.9	16.49	
	1/2	44.4	11.25	
	7/16	48.4	8.91	
	3/8	52.9	6.79	Heavy
	5/16	58.0	4.90	Medium Heavy
	.283	60.8	4.09	
	.263	62.7	3.58	
	.250	64.0	3.26	Medium
	.225	66.6	2.69	Medium Light
3/8"	5/16	29.7	9.99	
	.283	32.5	8.48	
	.263	34.5	7.51	
	.250	36.0	6.89	
	.225	39.0	5.77	
	.207	41.5	5.00	
	.192	43.8	4.39	
	.177	46.1	3.82	
	.162	48.7	3.27	Heavy
	.148	51.4	2.79	Medium Heavy
.135	54.1	2.37	Medium	
.120	57.4	1.92	Medium Light	
.105	61.0	1.51		
.092	64.5	1.18		
.080	67.9	.91		
.072	70.4	.75		
.063	73.3	.59		
.054	76.4	.44		
1/8"	.120	26.0	4.19	
	.105	29.5	3.37	Heavy
	.092	33.4	2.71	Medium Heavy
	.080	37.2	2.15	
	.072	40.2	1.79	Medium
	.063	44.2	1.43	
	.054	48.7	1.09	Medium Light
	.047	52.8	.85	
	.041	56.7	.67	
	.035	61.0	.50	



We accept Visa/MasterCard/American Express

VIBRATOR SCREENS

ORDERING INFORMATION

SCREENS FOR VIBRATING EQUIPMENT

1. State which edges are to be prepared with hooks or fitted with hook strips. Specify length of hook strips.
2. Give accurate outside dimension of screen. (See illustration below.) Measure old screen from outside of one bend to outside of other bend.

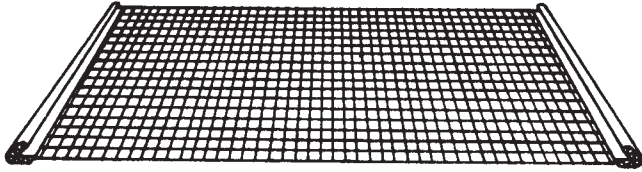

3. Be specific about angle and length of hook as shown in illustration below.

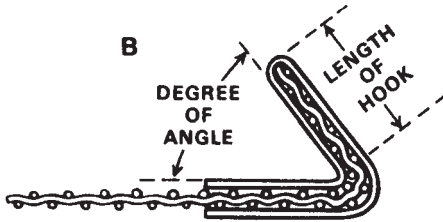

4. When screens are slotted, specify if slots are parallel or perpendicular to hook strips.
5. Specify size and make of vibrator.

TYPICAL APPLICATIONS FOR FARM, INDUSTRY AND HOME

Air Filters	Machinery Guards
Animal Cages	Minnow Pails
Bulb Trays	Partitions, Warehouse/Factory
Cellar Windows	Plaster -- Lath
Chicken Brooders	Rabbit Hutches
Chicken Run Floors	Rat-Proofing
Chimney Spark Guards	Screen Door Guards
Corn Cribs	Silo Linings
Display Shelves	Skylight Guards
Drying Trays	Stucco Mesh
Eave Trough Guards	Tree Guards
Egg Baskets	Truck Cab Rear Windows
Grain Bins and Screens	Turkey/Poultry Floors
Grain Cleaners	Ventilator Covers
Incubator Trays	Window Guards



LONG OPENING SCREENS TO ORDER

Please give complete information:

1. Number of pieces.
2. Length and width of each piece.
3. Type of opening: Rek-Tang, Sta-Tru, Sta-Clear, Ton-Cap, Ty-Rod or other weave.
4. Type of weave: Arch Crimp, Double Crimp, Sta-Smooth, etc.
5. Openings: Give width and length of clear opening. **IMPORTANT:** Specify if long opening is parallel to long or short dimension or roll or piece.
6. Wire Diameter: Expressed in decimals of an inch, if possible. Give wire diameter in both directions.
7. Metal or alloy.
8. Hook Strips: Specify style desired. Give dimension from outside edges of bends.
9. Screens for use in cylinders or cones: Specify lap, if required; give inside or outside diameter.
10. Notching, bolt holes, etc.: Submit drawing or template showing exact location, measurement on center between holes, distance from edge of screen to centers of holes.
11. Bending forming, calendaring, or other special fabrication: Give complete information, and drawings if possible.
12. Special shapes: Furnish prints giving tolerances, or template.



STYLE M-1 — Hooked Edge Without Reinforcing



STYLE M-2 — Regular Hook Strip



STYLE M-3 — Two-Piece Hook Strip



STYLE M-3-C — Two-Piece Hook Strip With Canvas Insert



STYLE M-4 — Bent Plate Welded Insert



STYLE M-5 — Square Type With Inserts



STYLE M-6 — Bent Plate Welded On Edge

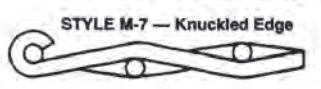

STYLE M-7 — Knuckled Edge

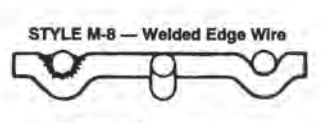

STYLE M-8 — Welded Edge Wire



STYLE M-9 — Welded Square Bar

WIRE MESH GLOSSARY OF TERMS

Calendared Wire Cloth — Wire cloth which has been passed through a pair of heavy rolls to reduce the thickness of the cloth or to flatten the intersections of the wires and provide a smooth surface. Also called “Rolled”.

Count — The number of openings in lineal inch.

Crimp — Corrugations in wires to lock them in place.

Double Crimp — Corrugations in both warp and shute wires to lock wires in position.

Fill Wires — See “Shute Wires”.

Gauge — Measure of wire diameter. The actual wire diameter should always be specified in decimal sizes.

Inter-Crimp — Extra crimps in warp and fill wires between intersections. Most often used in wide mesh to assure accurate openings.

Intermediate Crimp — See “Inter-Crimp”. When extra crimps are in the fill wires only, the term “Single-Intermediate” is used.

Lock Crimp — A weave in which deep crimps in wires at points of intersection lock wires securely in place. usually specified for heavy-duty screening.

Long Slot — A weave in which shute wires are arranged in clusters to provide slotted openings.

Market Grades — The most popular wire cloth specifications selected for general work.

Mesh — When the mesh is specified as a number, it refers to the number of openings in a lineal inch measured from the center of one wire to a point 1" distant.

Oblong Mesh — Wire cloth with rectangular openings, resulting in a different mesh count in the fill than in the warp. Usually called “Off Count” in the case of finer meshes.

Off Count — See “Oblong Mesh”.

Plain Weave — Wire cloth in which each warp wire and each shute wire pass over one and under the next adjacent complementary wire in both directions.

Plain Dutch Weave — The same as “Plain Weave” except that warp wires are usually larger than shute wires, and the shute wires are closely spaced, resulting in a dense weave with tapered or wedge-shaped openings.

Rectangular Mesh -- See “Oblong Mesh”.

Selvage — A finished edge to prevent unravelling of wire cloth.

Shute Wires — Wires running across the width of the cloth as woven. Also called “Fill Wires”.

Smooth Top — A weave in which all crimps are on the underside of the cloth, thus providing a smooth surface.

Space — The clear opening or space between adjacent parallel wires.

Square Mesh — Wire cloth with mesh count the same in both directions.

Stranded Weave — Wire cloth with a twilled weave of multiple wires in both warp and shute.

Twilled Weave — Wire cloth in which each warp wire and each shute wire passes successively over two and under the next adjacent pair of wires.

Twilled Dutch Weave — A combination of “Plain Dutch” and “Twilled”, except that the warp and shute wires are usually the same size.

Twilled Dutch Double Weave — Same as “Twilled Dutch” except the shute wires are smaller and overlap, thus increasing the number of shute wires in a lineal inch to provide greater density.

Warp Wires — Wires running the length of the cloth as woven.

Weft Wires — Same as “Shute Wires”.

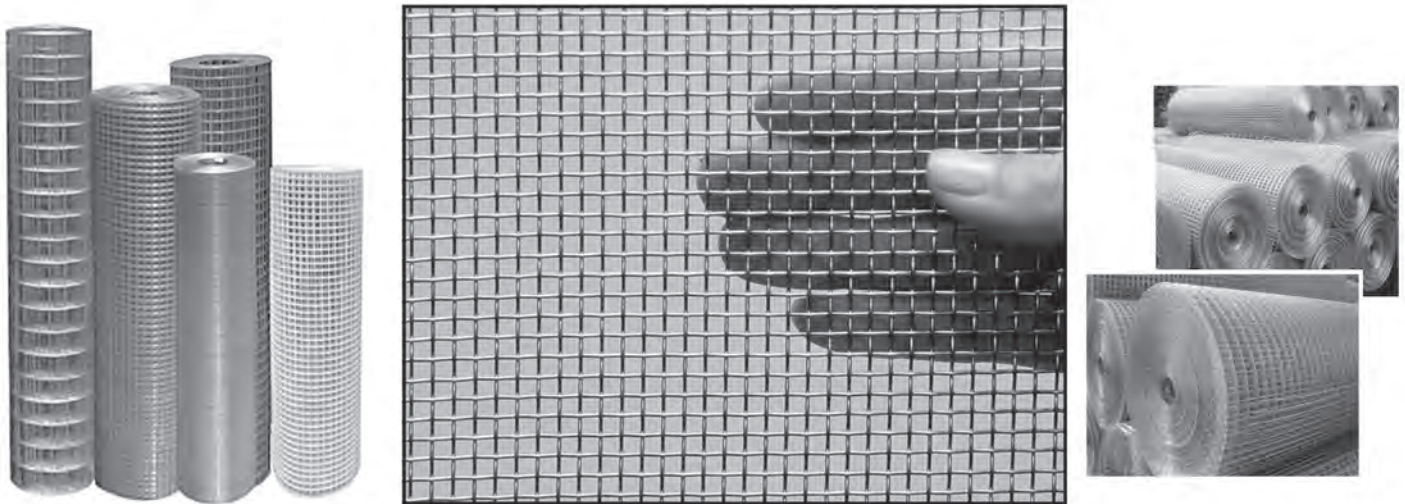

FIBERGLASS-REINFORCED-PLASTIC GRATINGS

Metals, Inc. sells two basic types of fiberglass-reinforced plastic (FRP) gratings: compression-molded (square mesh and rectangular mesh) and pultruded. Each type provides the fundamental advantages that make FRP a better investment than steel for most applications:

- maintenance-free
- lightweight, easy to install
- doesn't fatigue or creep, stays flat for safe walking
- nonconducting and nonsparking (high-conductance, anti-static grating is available).

In addition, pultruded gratings provide a high degree of strength and corrosion-resistance not found in conventional gratings.

This catalog is designed to provide the basic information you will need to select a grating and prepare specifications for a specific application. If you are unsure which grating (compression-molded rectangular or square, or pultruded) will best suit your application's static load, span, or traffic requirements, call our toll-free number: 1-800-492-7304.

The primary considerations that affect grating selection are:

Load/deflection

This is normally the starting point for grating selection. The type of grating (rectangular-mesh or square-mesh) interrelates with the layout of the support structure because of the difference in span directions.

Chemical compatibility

Metals, Inc. gratings offer excellent corrosion resistance within the capability of the specific resin system used. Resin systems, however, have different chemical compatibilities. The resin systems available are: vinylester, isophalic polyester, and general purpose resin.

Fire-retardance

Fire-retardance is a function of the resin system used for the grating.

Compression-Molded FRP Grating, Square Mesh and Rectangular Mesh

Compression molding vs conventional molding

Rectangular compression-molded FRP gratings offer the best available combination of strength, long life, and ease of installation. The patented matched-die molding process uses heat (240° F) and pressure (300 psi) to form high-density grating panels that have higher flexural and impact strength and better chemical and UV resistance than all other molded FRP gratings.

The strength of compression-molded grating results from the unique way that reinforcing glass is used in making the grating. Metals, Inc. compression molded grating is molded with continuous strands of woven glass cording, for consistent strength throughout the grating. Because it is compression molded, more reinforcing glass can be used than is possible with conventional open-molded gratings. Metals, Inc. gratings contain up to twice as much fiberglass as ordinary FRP gratings. As a result,

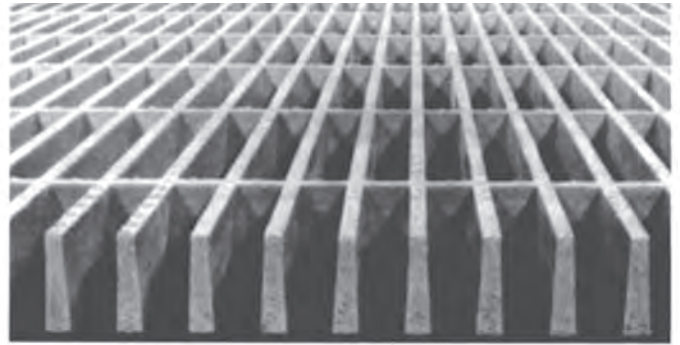

Rectangular-mesh grating spans lengthwise.

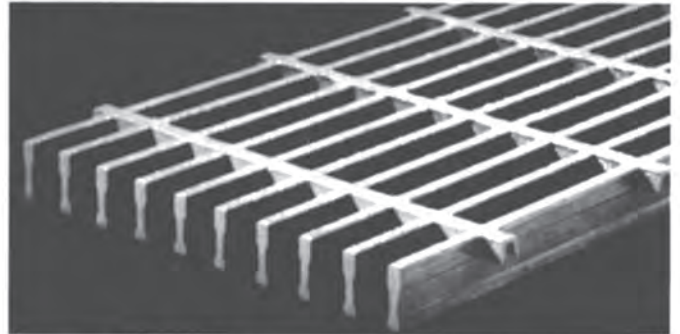

Pultruded grating has minimum deflection for long spans.

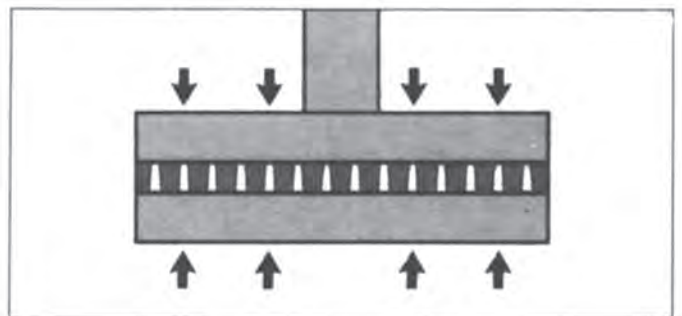

The grating is compression-molded between matched dies at 240° and 300 psi of pressure. This patented process evenly disperses continuous woven strands of glass fiber throughout the grating and fully bonds the glass and resin together.

FIBERGLASS GRATINGS

Compression-Molded FRP Grating, Square Mesh and Rectangular Mesh

Compression molding vs conventional molding

Rectangular compression-molded FRP gratings offer the best available combination of strength, long life, and ease of installation. The patented matched-die molding process uses heat (240° F) and pressure (300 psi) to form high-density grating panels that have higher flexural and impact strength and better chemical and UV resistance than all other molded FRP gratings.

The strength of compression-molded grating results from the unique way that reinforcing glass is used in making the grating. Metals, Inc. compression molded grating is molded with continuous strands of woven glass cording, for consistent strength throughout the grating. Because it is compression molded, more reinforcing glass can be used than is possible with conventional open-molded gratings. Metals, Inc. gratings contain up to twice as much fiberglass as ordinary FRP gratings. As a result, compression-molded gratings are up to twice as strong, as can be verified by comparing load/deflection data. *This*

Square-Mesh Grating

Compression-molded square-mesh grating offers maximum design and installation versatility because bearing bars span in both directions. Square-mesh can be cut and installed in almost any configuration. Square-mesh panels are ideal for raised flooring applications (see pedestals below).

Panel Specifications, Square Mesh

Thickness, inches	1.0	1½
Width, inches	48	48
Length, inches	96	96
Weight per panel, lb	100	160
Weight per ft ² , lb	3.13	5.0

Typical Specifications, Square Mesh

Grating shall be fiberglass grating fabricated by Metals, Inc., Cleveland, Ohio. Grating shall be compression-molded at a minimum pressure of 300 psi to minimize porosity. Cure temperature shall be in excess of 200° F to assure proper adhesion of resin to glass fiber. Grating shall safely support a uniform load of ___ pounds per square foot on a span of ___ inches and deflect not more than ___ inches. (Refer to load/deflection charts starting on page 40.)

Rectangular-Mesh Grating

Rectangular-mesh grating is compression-molded panels and ¾, 1, and 1½-inch thicknesses. The panel size matches most steel gratings, to simplify replacing existing steel grating. Rectangular panels span lengthwise (108 in.).

Panel Specifications, Rectangular Mesh

Thickness, inches	¾	1.0	1½
Width, inches	36½	36½	36½
Length, inches	108	108	108
Weight per panel, lb	60	85	125
Weight per ft ² , lb	2.2	3.15	4.63

higher strength translates into cost savings through use of thinner, lighter grating and/or through use of fewer support members for a given deflection.

Given proper resin selection, all fiberglass gratings provide acceptable corrosion protection compared to steel. But compression-molding gives an extra measure of corrosion resistance that other FRP gratings don't have. The hydraulic pressure of compression-molding forces glass deep into the resin, creating an extra-dense grating that is less porous than conventional gratings, and therefore, less vulnerable to wicking.

Installation

Metals, Inc. compression-molded gratings and pultruded grating are easily and economically installed, because they are lightweight and easy to handle.

Gratings can be cut in the field using saws equipped with ceramic or masonry blades. Simpler cuts may be made with a hand hacksaw. Cut ends must be coated with resin for corrosion resistance.

Factory Fabrication

Metals, Inc. will pre-cut and resin-seal square and rectangular panels to your specification. Along with your order, please pro-

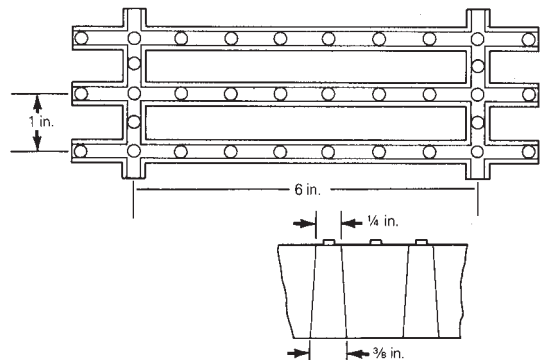
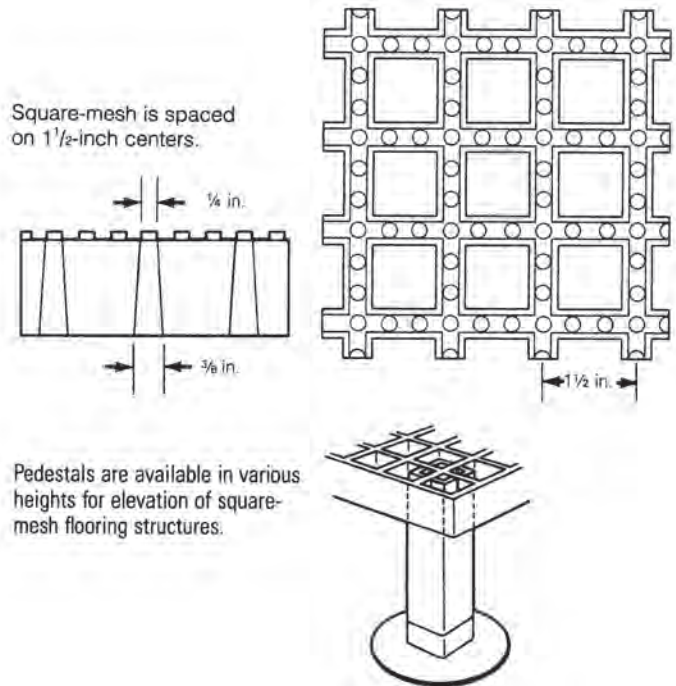

FIBERGLASS GRATINGS

Typical Specifications, Rectangular Mesh

Grating shall be fiberglass grating as fabricated by Metals, Inc., Cleveland, Ohio. Grating shall be compression-molded at a minimum pressure of 300 psi to minimize porosity. Cure temper-

ature shall be in excess of 200 F to assure proper adhesion of resin to glass fiber. Grating shall safely support a uniform load of ___ pounds per square foot on a span of ___ inches and deflect not more than ___ inches.

Pultruded FRP Grating

Metals, Inc. pultruded grating provides maximum stiffness and minimum deflection for long spans. Pultruded grating is not molded as a unit and therefore requires careful design and planning where cut-outs are necessary. The pultrusion process permits production of continuous panels in lengths up to 20 feet (longer on special order).

Patented assembly method forms solid, unitized panels while preserving the strength and stiffness of the bearing bars. Bearing bars and cross bars are mechanically interlocked (see illustration) and bonded securely in place to resist torsion, bending, and other loading. Cross bars flush with the surface of the grating, provide excellent footing and skid resistance.

Pultruded fiberglass grating is available in five premium resin systems. Premium synthetic veils are also standard for maximum ultraviolet and chemical corrosion resistance.

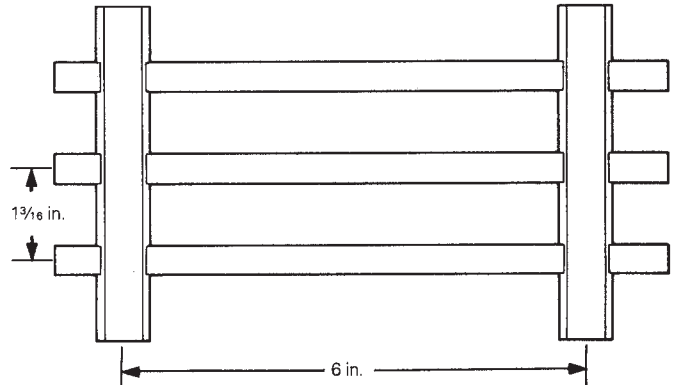

Pultruded grating has bearing bars on 1¹/₁₆-inch centers and cross bars on 6-inch centers. Stock panels are 3-foot x 20-foot. Custom lengths, widths and bar spacings are available.

Mechanically interlocked cross bars maintain the structural integrity of the bearing bars.

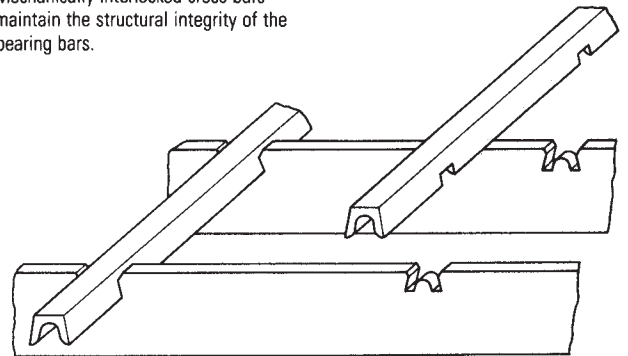

Panel Specifications, Pultruded Grating

Thickness, inches	1	1 1/4	1 1/2	2
Width, inches	36	36	36	36
Length, inches	240	240	240	240
Weight per panel, lb	197	229	260	325
Weight per ft ² , lb	3.27	3.81	4.39	5.41

Typical Specifications, Pultruded FRP Grating

Grating shall be fiberglass grating as fabricated by Metals, Inc., Cleveland, Ohio.

Grating shall be assembled with mechanically interlocked cross bars and bearing bars, maintaining full structural integrity of the bearing bars. Cross bars shall be flush with the top surface of the grating and coated with a non-skid surface.

Grating shall have a minimum glass content of 70% by volume.

Grating Options

Non-skid surface

Wear-resistant, silica-textured surface provides sure-footing and good traction in extremely oily or icy conditions. Metals, Inc. grating meets all OSHA specifications for non-slip, aggregate surface applications. On Metals, Inc. gratings, the non-skid surface is applied to the wider bottom surface and the grating is installed inverted (strength and deflection properties are not adversely affected).

Custom colors

Any available resin system can be pigmented to produce the color of your choice, by special order.

GatorGrate Solid Fiberglass Plate

This is used whenever open-mesh gratings are undesirable. Available in smooth and gritted surfaces.

Stair Treads

Stair treads are made from sturdy 1-1/2 inch compression molded grating. Two styles are available: filled-nose and angle-nose. Non-skid aggregate surfacing is standard on both, in compliance with OSHA Specification 1910.24f. Call toll-free for details and ordering information.



We accept
Visa
MasterCard
American Express.

HOT ROLLED STEEL SHEET

Thickness & Size	Wt. Sq. Ft.	Est. Sheet Wt.	Thickness & Size	Wt. Sq. Ft.	Est. Sheet Wt.
7 Ga.(.1793)	7.50		11 Ga.(.1196)	5.00	
36 x 96		180.0	60 x 144		300.0
36 x 120		225.0	60 x 168		350.0
36 x 144		270.0	60 x 192		400.0
36 x 240		450.0	72 x 120		300.0
48 x 96		240.0	72 x 144		360.0
48 x 120		300.0			
48 x 144		360.0	12 Ga.(.1046)	4.375	
48 x 240		600.0	36 x 96		105.0
60 x 96		300.0	36 x 120		131.3
60 x 120		375.0	36 x 144		157.5
60 x 144		450.0	48 x 96		140.0
60 x 240		750.0	48 x 120		175.0
72 x 96		360.0	48 x 144		210.0
72 x 120		450.0	60 x 96		175.0
72 x 144		540.0	60 x 120		218.8
72 x 240		900.0	60 x 144		262.5
			72 x 96		210.0
10 Ga.(.1345)	5.625		72 x 120		265.5
36 x 96		135.0	72 x 144		315.0
36 x 120		168.8			
36 x 144		202.5	14 Ga.(0747)	3.125	
48 x 96		180.0	36 x 96		75.0
48 x 120		225.0	36 x 120		93.8
48 x 144		270.0	36 x 144		112.5
60 x 96		225.0	48 x 96		100.0
60 x 120		281.3	48 x 120		125.0
60 x 144		337.5	48 x 144		150.0
60 x 168		393.8	60 x 96		125.0
72 x 120		337.5	60 x 120		156.3
72 x 144		405.0	60 x 144		187.5
84 x 120		393.8	72 x 120		187.5
			72 x 144		225.0
11 Ga.(.1196)	5.00				
36 x 96		120.0	16 Ga.(.0598)	2.50	
36 x 120		150.0	36 x 96		60.0
36 x 144		180.0	36 x 120		75.0
48 x 96		160.0	36 x 144		90.0
48 x 120		200.0	48 x 96		80.0
48 x 144		240.0	48 x 120		100.0
60 x 96		200.0	48 x 144		120.0
60 x 120		250.0	60 x 96		100.0
			60 x 120		125.0
			60 x 144		150.0
			72 x 120		150.0
			72 x 144		180.0

Thickness & Size	Wt. Sq. Ft.	Est. Sheet Wt.	Thickness & Size	Wt. Sq. Ft.	Est. Sheet Wt.
18 Ga.(.0478)	2.00		20 Ga.(.0359)	1.50	
36 x 96		48.0	48 x 96		48.0
36 x 120		60.0	48 x 120		60.0
48 x 96		64.0	60 x 96		60.0
48 x 120		80.0	60 x 120		75.0

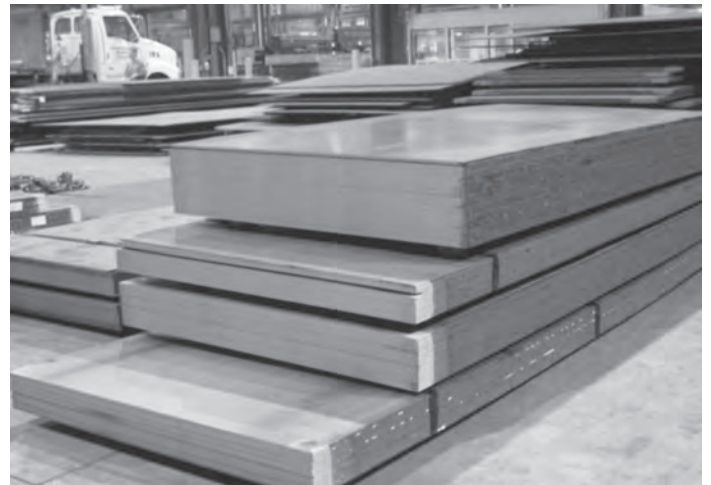

**We accept
 Visa
 MasterCard
 American Express.**

*Also Stock Sheets in Galvanized, Aluminum, and Stainless

CARBON STEEL PLATE

Thickness & Size	Wt. Per Sq. Ft.	Wt. Per Plate	Thickness & Size	Wt. Per Sq. Ft.	Wt. Per Plate	Thickness & Size	Wt. Per Sq. Ft.	Wt. Per Plate	Thickness & Size	Wt. Per Sq. Ft.	Wt. Per Plate
3/16 (.1875)	7.66		3/8 (.375)	15.31		5/8 (.625)	25.52		1	40.84	
48 x 96		245.03	48 x 96		490.08	60 x 120		1276.20	60 x 120		2041.90
48 x 120		306.30	48 x 120		612.60	60 x 240		2552.40	60 x 240		4083.80
48 x 144		367.56	48 x 144		735.12	72 x 120		1531.40	72 x 120		2450.30
60 x 96		306.32	48 x 240		1225.20	72 x 240		3062.80	72 x 240		4900.60
60 x 120		382.90	60 x 120		765.70	84 x 120		1786.70	72 x 288		5880.72
60 x 144		459.48	60 x 144		918.84	84 x 240		3573.40	84 x 120		2858.70
60 x 240		765.80	60 x 240		1531.40	96 x 120		2041.90	84 x 240		5717.40
72 x 120		459.40	72 x 96		735.12	96 x 240		4083.80	96 x 120		3267.10
72 x 144		551.28	72 x 120		918.90	96 x 360		6125.76	96 x 240		6534.20
72 x 240		918.80	72 x 144		1102.68	120 x 120		2552.40	96 x 288		7841.04
84 x 120		536.00	72 x 240		1837.80	120 x 240		5104.80	96 x 360		9801.30
84 x 240		1072.00	72 x 288		2205.36	120 x 360		7657.00	96 x 480		13068.40
96 x 120		612.60	84 x 120		1072.00	3/4 (.750)	30.63		120 x 120		4083.80
96 x 240		1225.20	84 x 240		2144.00	48 x 96		980.16	120 x 240		8167.60
1/4 (.250)	10.21		96 x 120		1225.20	48 x 120		1225.20	120 x 360		12251.40
48 x 96		326.72	96 x 240		2450.40	48 x 240		2450.40	1-1/8	45.94	
48 x 120		408.40	96 x 288		2940.48	60 x 120		1531.40	48 x 120		1837.70
48 x 144		489.60	120 x 120		1531.40	60 x 240		3062.80	60 x 120		2297.16
48 x 240		816.00	120 x 240		3062.80	72 x 120		1837.70	60 x 240		4594.32
60 x 96		408.40	120 x 360		4594.00	72 x 240		3675.40	72 x 120		2756.60
60 x 120		510.50	1/2 (.500)	20.42		84 x 120		2144.00	72 x 240		5513.20
60 x 144		612.60	48 x 96		653.44	84 x 240		4288.00	84 x 120		3216.00
60 x 240		1021.00	48 x 120		816.80	96 x 120		2450.30	84 x 240		6432.00
72 x 96		490.00	48 x 144		980.16	96 x 240		4900.60	96 x 120		3675.50
72 x 120		612.60	48 x 240		1633.60	96 x 360		7350.90	96 x 240		7351.00
72 x 144		735.12	60 x 120		1021.00	120 x 120		3062.90	120 x 120		4594.30
72 x 240		1225.20	60 x 144		1225.20	120 x 240		6125.80	120 x 240		9188.60
84 x 120		714.70	60 x 240		2042.00	120 x 360		9188.70	120 x 360		13782.90
84 x 240		1429.40	72 x 120		1225.20	7/8 (.875)	35.73		1-1/4	51.05	
96 x 120		816.80	72 x 144		1470.24	48 x 96		1143.44	48 x 96		1633.52
96 x 240		1633.60	72 x 240		2450.40	48 x 120		1429.30	48 x 120		2041.90
120 x 120		1020.50	72 x 288		2940.48	60 x 120		1786.68	48 x 240		4083.80
120 x 240		2041.00	84 x 120		1429.30	60 x 240		3573.36	60 x 120		2552.40
120 x 360		3063.00	84 x 240		2858.60	72 x 120		2144.00	60 x 240		5104.80
5/16 (.3125)	12.76		96 x 120		1633.50	72 x 240		4288.00	72 x 120		3062.90
48 x 96		408.40	96 x 240		3267.00	84 x 120		2501.40	72 x 240		6125.80
48 x 120		510.50	120 x 120		2041.90	84 x 240		5002.80	72 x 288		7350.96
48 x 144		612.60	120 x 240		4083.80	96 x 120		2858.70	84 x 120		3573.40
48 x 240		1020.80	120 x 360		6125.70	96 x 240		5717.40	84 x 240		7146.80
60 x 120		638.10	5/8 (.625)	25.52		120 x 120		3573.40	96 x 120		4083.80
60 x 240		1276.20	48 x 96		816.80	120 x 240		7146.80	96 x 240		8167.60
72 x 120		765.70	48 x 120		1021.00	120 x 360		10720.00	96 x 360		12251.40
72 x 240		1531.40	48 x 144		1225.20	1	40.84		96 x 480		16335.20
84 x 120		893.30				48 x 96		1306.80	120 x 120		5104.80
84 x 240		1786.60				48 x 120		1633.50	120 x 240		10209.60
96 x 120		1021.00				48 x 240		3267.00	120 x 360		15314.40
96 x 240		2042.00									
96 x 480		4084.00									

*Also Stock Plate in Galvanized, Aluminum, and Stainless



FAX YOUR ORDER: METALS, INC. 440-439-0577 • sales@metals-inc.com

CARBON STEEL PLATE

Thickness & Size	Wt. Per Sq. Ft.	Wt. Per Plate	Thickness & Size	Wt. Per Sq. Ft.	Wt. Per Plate	Thickness & Size	Wt. Per Sq. Ft.	Wt. Per Plate	Thickness & Size	Wt. Per Sq. Ft.	Wt. Per Plate
1-3/8	56.15		1-3/4	71.47		2-1/4	91.89		3	122.52	
48 x 120		2246.00	84 x 120		5002.70	96 x 120		7350.90	48 x 120		4900.61
48 x 240		4492.00	84 x 240		10005.40	96 x 240		14701.80	48 x 240		9801.22
60 x 120		2807.50	96 x 120		5717.40	120 x 120		9188.64	60 x 120		6125.76
60 x 240		5615.00	96 x 240		11434.80	120 x 240		18377.28	60 x 240		12251.52
72 x 120		3369.20	120 x 120		7146.72	2-3/8	96.99		72 x 120		7350.90
72 x 240		6738.40	120 x 240		14293.44	48 x 120		3879.60	72 x 240		14701.80
84 x 120		3930.70	120 x 288		17152.08	48 x 240		7759.20	84 x 120		8576.10
84 x 240		7861.40	120 x 360		21440.20	60 x 120		4849.50	84 x 240		17152.20
96 x 120		4492.20	1-7/8	76.572		60 x 240		9699.00	96 x 120		9801.20
96 x 240		8984.40	48 x 120		3062.88	72 x 120		5819.40	96 x 240		19602.40
120 x 120		5615.00	48 x 240		6125.76	72 x 240		11638.80			
120 x 240		11230.00	60 x 120		3828.60	84 x 120		6789.30			
1-1/2	61.26		60 x 240		7657.20	84 x 240		13578.60			
48 x 96		1960.24	72 x 120		4594.32	96 x 120		7759.20			
48 x 120		2450.30	72 x 240		9188.64	96 x 240		15518.40			
48 x 240		4900.60	84 x 120		5360.04	120 x 120		9699.00			
60 x 120		3062.90	84 x 240		10720.08	120 x 240		19398.00			
60 x 240		6125.80	96 x 120		6125.76	2-1/2	102.10				
72 x 120		3675.50	96 x 240		12251.52	48 x 120		4083.84			
72 x 240		7351.00	120 x 120		7657.20	48 x 240		8167.68			
84 x 120		4288.00	120 x 240		15314.40	60 x 120		5104.80			
84 x 240		8576.00	2	81.68		60 x 240		10209.60			
96 x 120		4900.60	48 x 120		3267.10	72 x 120		6125.80			
96 x 240		9801.20	48 x 240		6534.20	72 x 240		12251.60			
96 x 360		14701.80	60 x 120		4083.80	84 x 120		7146.70			
120 x 120		6125.80	60 x 240		8167.60	84 x 240		14293.40			
120 x 240		12251.60	72 x 120		4900.60	96 x 120		8167.70			
120 x 360		18377.40	72 x 240		9801.20	96 x 240		16335.40			
1-5/8	66.36		72 x 288		11761.40	120 x 120		10209.60			
48 x 120		2654.40	84 x 120		5717.40	120 x 240		20419.20			
48 x 240		5308.80	84 x 240		11434.80	2-3/4	112.31				
60 x 120		3318.12	96 x 120		6534.10	48 x 120		4492.22			
60 x 240		6636.24	96 x 240		13068.20	48 x 240		8984.44			
72 x 120		3981.74	96 x 360		19602.30	60 x 120		5615.28			
72 x 240		7963.48	120 x 120		8167.70	60 x 240		11230.56			
84 x 120		4645.40	120 x 240		16335.40	72 x 120		6738.34			
84 x 240		9290.80	120 x 288		19602.48	72 x 240		13476.68			
96 x 120		5309.00	120 x 360		24503.00	84 x 120		7861.40			
96 x 240		10618.00	2-1/4	91.89		84 x 240		15722.80			
120 x 120		6636.00	48 x 120		3675.46	96 x 120		8984.40			
120 x 240		13272.00	48 x 240		7350.92	96 x 240		17968.80			
1-3/4	71.47		60 x 120		4594.50	120 x 120		11230.56			
48 x 96		2286.96	60 x 240		9189.00	120 x 240		22461.12			
48 x 120		2858.70	72 x 120		5513.20						
48 x 240		5717.40	72 x 240		11026.40						
60 x 120		3573.36	84 x 120		6432.00						
60 x 240		7146.72	84 x 240		12864.00						
72 x 120		4288.00									
72 x 240		8576.00									

*We also supply Abrasion Resistant Plate in grades 200–250 Brinell and 360–400 Brinell

** Stock available in: **HR Steel, Aluminum, and Stainless**

DIAMOND FLOOR PLATE

Thickness & Size	Wt. Per Sq. Ft.	Wt. Per Plate	Thickness & Size	Wt. Per Sq. Ft.	Wt. Per Plate
14 Ga.	3.75		96 x 120		1104.80
48 x 96		120.00	96 x 240		2209.60
48 x 120		150.00	3/8	16.37	
60 x 120		187.50	48 x 96		523.84
72 x 120		225.00	48 x 120		654.80
84 x 120		262.50	48 x 144		785.76
96 x 120		300.00	48 x 240		1309.60
1/8	6.16		60 x 120		818.50
48 x 96		197.12	60 x 240		1637.00
48 x 120		246.40	72 x 120		982.20
48 x 144		295.68	72 x 240		1964.40
60 x 120		308.00	84 x 120		1145.90
72 x 120		369.60	84 x 240		2291.80
84 x 120		431.20	96 x 120		1309.60
96 x 120		492.80	96 x 240		2619.20
3/16	8.71		1/2	21.47	
48 x 96		278.72	48 x 96		687.04
48 x 120		348.40	48 x 120		858.80
48 x 144		418.08	48 x 240		1717.60
48 x 240		696.08	60 x 120		1073.50
60 x 120		435.50	60 x 240		2147.00
60 x 144		522.60	72 x 120		1288.20
60 x 240		871.00	72 x 240		2576.40
72 x 120		522.60	84 x 120		1502.90
72 x 240		1045.20	84 x 240		3005.80
84 x 120		609.70	96 x 120		1717.60
84 x 240		1219.40	96 x 240		3435.20
96 x 120		696.80	5/8	26.58	
96 x 240		1393.60	48 x 120		1063.20
1/4	11.26		60 x 120		1329.00
48 x 96		360.32	60 x 240		2658.00
48 x 120		450.40	72 x 120		1594.80
48 x 144		540.48	72 x 240		3189.60
48 x 240		900.80	84 x 120		1860.60
60 x 120		563.00	84 x 240		3721.20
60 x 240		1126.00	96 x 120		2126.40
72 x 120		675.60	96 x 240		4252.80
72 x 240		1351.20	3/4	31.68	
84 x 120		788.20	48 x 120		1267.20
84 x 240		1576.40	60 x 120		1584.00
96 x 120		900.80	60 x 240		3168.00
96 x 240		1801.60	72 x 120		1900.80
5/16	13.81		72 x 240		3801.60
48 x 120		552.40	84 x 120		2217.60
48 x 240		1104.80	84 x 240		4435.20
60 x 120		690.50	96 x 120		2534.40
60 x 240		1381.00	96 x 240		5068.80
72 x 120		828.60			
72 x 240		1657.20			
84 x 120		966.70			
84 x 240		1933.40			

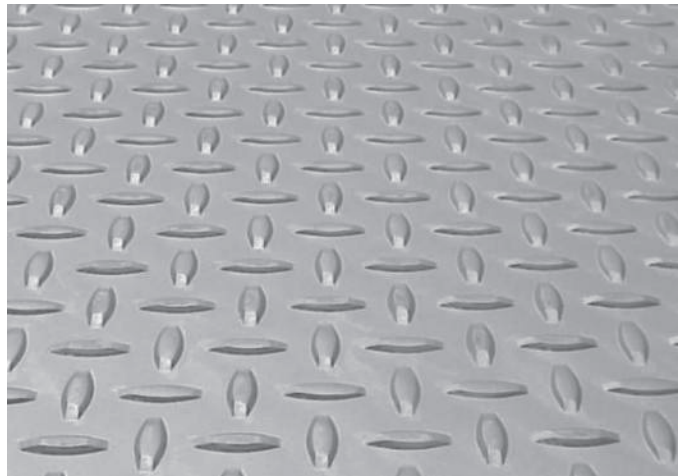

Thickness & Size	Wt. Per Sq. Ft.	Wt. Per Plate	Thickness & Size	Wt. Per Sq. Ft.	Wt. Per Plate
1	41.89		1	41.89	
48 x 120		1675.60	84 x 120		2932.30
60 x 120		2094.50	84 x 240		5864.60
60 x 240		4189.00	96 x 120		3351.20
72 x 120		2513.40	96 x 240		6702.40
72 x 240		5026.80			



**We accept
Visa
MasterCard
American Express.**

* Stock available in: **HR Steel, Aluminum, and Stainless**

PIPE

WELDED-PLAIN ENDS

Nom. Size (in.)	Schedule	Wt. Per Ft.	Wall Thickness	Size O.D.	Size I.D.	Length
1/8	40	.24	.068	.405	.269	21 ft. 24 ft. 42 ft.
1/4	40	.42	.088		.364	
	80	.54	.119	.540	.302	
3/8	40	.57	.091		.493	
	80	.74	.126	.675	.423	
1/2	40	.85	.109		.622	
	80	1.09	.147	.840	.546	
3/4	40	1.13	.113		.824	
	80	1.47	.154	1.050	.742	
1	10	1.41	.109		1.097	
	40	1.68	.133		1.049	
	80	2.17	.179	1.315	.957	
1-1/4	10	1.806	.109		1.442	
	40	2.27	.140		1.380	
	80	3.00	.191	1.660	1.278	
1-1/2	10	2.085	.109		1.682	
	40	2.72	.145		1.610	
	80	3.63	.200	1.900	1.500	
2	40	3.65	.154		2.067	
	80	5.02	.218	2.375	1.939	
2-1/2	40	5.79	.203		2.469	
	80	7.66	.276	2.875	2.323	
3	40	7.58	.216		3.068	
	80	10.25	.300	3.500	2.900	
3-1/2	40	9.11	.226		3.548	
	80	12.51	.318	4.000	3.364	
4	40	10.79	.237		4.026	
	80	14.98	.337	4.500	3.826	
5	40	14.62	.258		5.047	
	80	20.78	.375	5.563	4.813	
6	10	9.29	.134		6.357	
	40	18.97	.280		6.065	
	80	28.57	.432	6.625	5.761	
8	40	28.55	.322		7.981	
	80	43.39	.500	8.625	7.625	
10	40	40.48	.365		10.020	
	80	64.43	.594	10.750	9.562	
12	40	53.52	.406		11.938	
	80	88.63	.688	12.750	11.374	
14	40	63.44	.438		13.124	
	80	106.13	.750	14.000	12.500	
16	Std	62.58	.375		15.250	
	40	82.77	.500		15.000	
	80	136.61	.844	16.000	14.312	

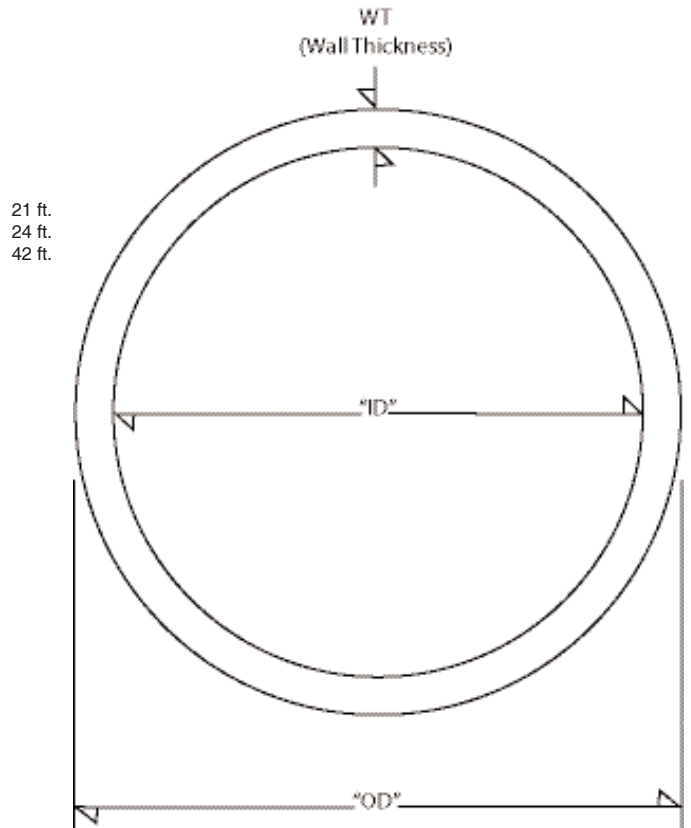
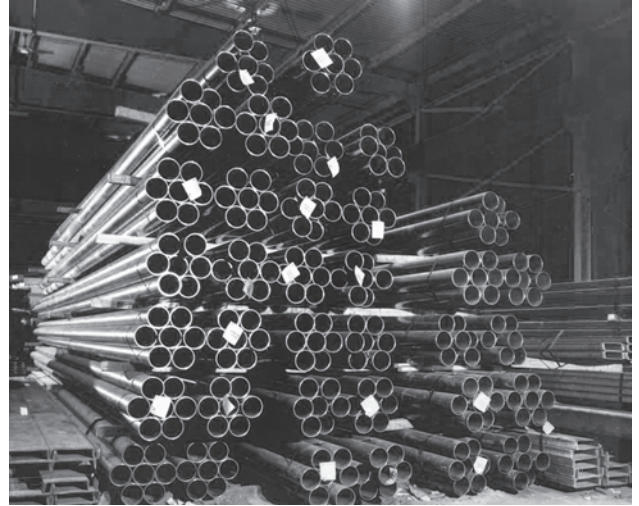

SQUARE TUBING

Size & Wall	Wt. Per Foot	Size & Wall	Wt. Per Foot
1/2 x 1/2 x 16 Ga.	.38	5/16	14.83
3/4 x 3/4 x 16 Ga.	.61	3/8	17.27
	14 Ga.	1/2	21.63
	1/8	1.03	
1 x 1 x 16 Ga.	.83	5 x 5 x 3/16	11.97
	14 Ga.	1/4	15.62
	1/8	5/16	19.08
1-1/4 x 1-1/4 x 16 Ga.	1.05	3/8	22.37
	14 Ga.	1/2	28.43
	1/8	1.84	
1-1/2 x 1-1/2 x 18 Ga.	.97	6 x 6 x 3/16	14.53
	16 Ga.	1/4	19.02
	1/8	5/16	23.34
	3/16	3/8	27.48
1-3/4 x 1-3/4 x 14 Ga.	1.88	1/2	35.24
	1/8	5/8	42.26
2 x 2 x 16 Ga.	1.71	7 x 7 x 3/16	17.08
	14 Ga.	1/4	22.42
	1/8	5/16	27.59
	10 Ga.	3/8	32.58
	8 Ga.	1/2	42.05
	3/16	8 x 8 x 3/16	19.63
	1/4	1/4	25.82
2-1/8 x 2-1/8 x 10 Ga.	3.63	5/16	31.84
2-1/2 x 2-1/2 x 16 Ga.	2.12	3/8	37.69
	14 Ga.	1/2	48.85
	1/8	5/8	59.33
	10 Ga.	10 x 10 x 3/16	24.73
	8 Ga.	1/4	32.63
	3/16	5/16	40.35
	1/4	3/8	47.90
3 x 3 x 14 Ga.	3.23	1/2	62.46
	1/8	5/8	76.33
	3/16	12 x 12 x 3/16	29.84
	1/4	1/4	39.43
	5/16	5/16	48.86
	3/8	3/8	58.10
3-1/2 x 3-1/2 x 1/8	5.61	1/2	76.07
	3/16	5/8	93.25
	1/4	14 x 14 x 5/16	57.36
	5/16	3/8	68.31
	3/8	1/2	89.68
4 x 4 x 14 Ga.	4.42	5/16	12.70
	1/8	3/8	14.71
	3/16	16 x 16 x 3/8	78.52
	1/4	1/2	103.30

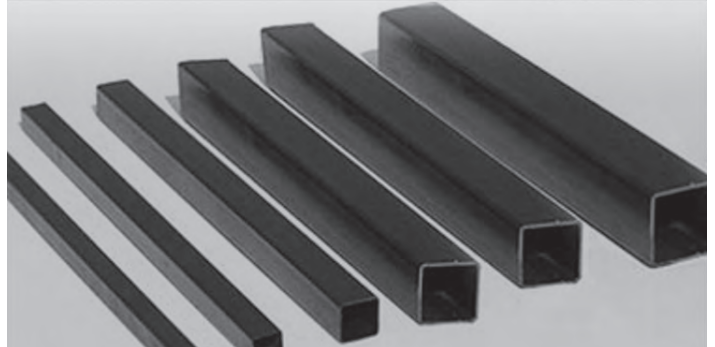
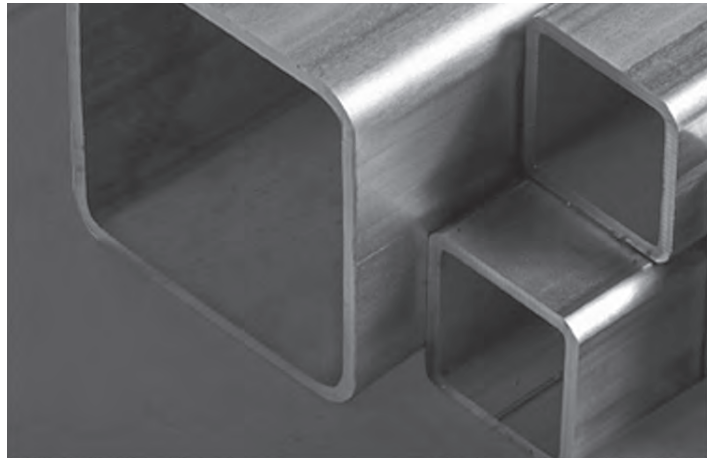

Call and order with your Visa/MasterCard/American Express.

RECTANGULAR TUBING

Size & Wall	Wt. Per Foot	Size & Wall	Wt. Per Foot	Size & Wall	Wt. Per Foot	Size & Wall	Wt. Per Foot
1 x 1/2 x 16 Ga.	.61	3 x 1-1/4x 16 Ga.	1.79	5 x 3 x 1/8	6.46	7 x 5 x 3/16	14.53
14 Ga.	.75	14 Ga.	2.24	3/16	9.42	1/4	19.02
1 x 3/4 x 16 Ga.	.72	1/8	3.26	1/4	12.21	5/16	23.34
14 Ga.	.89	3/16	4.63	5/16	14.83	3/8	27.48
1-1/4x 1 x 16 Ga.	.94	1/4	5.82	3/8	17.27	1/2	35.24
14 Ga.	1.18	3 x 1-1/2 x 16 Ga.	1.90	1/2	21.63	8 x 2 x 3/16	11.97
1/8	1.64	14 Ga.	2.38	5 x 4 x 3/16	10.70	1/4	15.62
1-1/2x 3/4 x 16 Ga.	.94	1/8	3.48	1/4	13.91	5/16	19.08
14 Ga.	1.18	3/16	4.95	5/16	16.96	3/8	22.37
1/8	1.64	1/4	6.25	3/8	19.82	8 x 3 x 3/16	13.25
1-1/2x 1 x 16 Ga.	1.05	3 x 2 x 16 Ga.	2.12	1/4	12.21	1/4	17.32
14 Ga.	1.32	14 Ga.	2.67	3/16	9.42	5/16	21.21
1/8	1.84	1/8	3.90	1/4	12.21	3/8	24.93
1-3/4x 1-1/4x 16 Ga.	1.27	3-1/2x 1-1/2x 16 Ga.	2.12	5/16	14.83	1/2	31.84
14 Ga.	1.60	14 Ga.	2.67	3/8	17.27	8 x 4 x 3/16	14.53
1/8	2.25	1/8	3.90	6 x 3 x 1/8	7.31	1/4	19.02
2 x 1 x 16 Ga.	1.27	3/16	5.59	3/16	10.70	5/16	23.34
14 Ga.	1.60	1/4	7.10	1/4	13.91	3/8	27.48
1/8	2.25	3-1/2x 2-1/2x 14 Ga.	3.23	5/16	16.96	1/2	35.24
2 x 1-1/4x 16 Ga.	1.38	1/8	4.75	3/8	19.82	8 x 6 x 3/16	17.08
14 Ga.	1.74	3/16	6.87	1/2	25.03	1/4	22.42
1/8	2.46	1/4	8.80	6 x 4 x 1/8	8.16	5/16	27.59
2 x 1-1/2x 16 Ga.	1.49	4 x 1-1/2x 1/8	4.48	3/16	11.97	3/8	32.58
14 Ga.	1.88	4 x 2 x 14 Ga.	3.23	1/4	15.62	1/2	42.05
1/8	2.66	1/8	4.75	5/16	19.08	9 x 3 x 3/16	14.53
2-1/2x 1 x 14 Ga.	1.88	3/16	6.87	1/4	15.62	1/4	19.02
1/8	2.66	1/4	8.81	3/8	22.37	5/16	23.34
2-1/2x 1-1/2x 16 Ga.	1.71	4 x 3 x 14 Ga.	3.80	1/2	28.43	3/8	27.48
14 Ga.	2.10	1/8	5.61	6 x 5 x 3/16	13.25	9 x 5 x 3/16	17.08
1/8	3.05	3/16	8.15	1/4	17.32	1/4	22.42
3/16	4.32	1/4	10.51	5/16	21.21	5/16	27.59
1/4	5.40	5 x 2 x 1/8	5.61	3/8	24.93	3/8	32.58
3 x 1 x 16 Ga.	1.71	3/16	8.15	7 x 3 x 3/16	11.97	1/2	42.05
14 Ga.	2.10	1/4	10.51	1/4	15.62	9 x 7 x 3/16	19.63
1/8	3.05	5/16	12.70	5/16	19.08	1/4	25.82
3/16	4.32			3/8	22.37	5/16	31.84
1/4	5.40			7 x 4 x 3/16	13.25	3/8	37.69
				1/4	17.32	1/2	48.85
				5/16	21.21	10 x 2 x 3/16	14.53
				3/8	24.93	1/4	19.02
				1/2	31.84	5/16	23.34
						3/8	27.48

RECTANGULAR TUBING

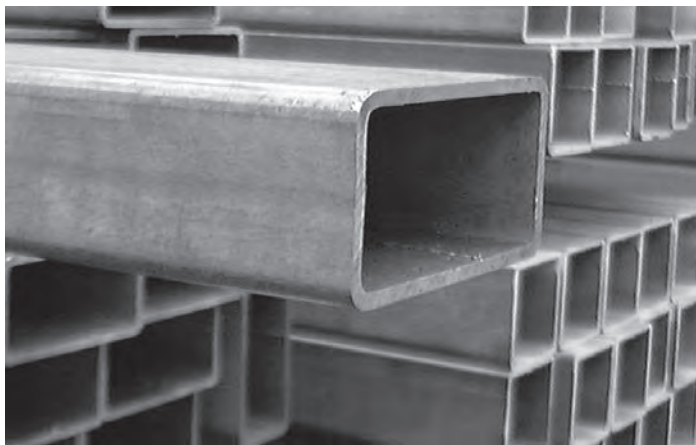

Size & Wall	Wt. Per Foot	Size & Wall	Wt. Per Foot		
10 x 3 x	3/16	12 x 8 x	3/16		
	1/4		1/4		
	5/16		5/16		
10 x 4 x	3/16		3/8		
	1/4		1/2		
	5/16		5/8		
	3/8		14 x 4 x		
1/2	14 x 4 x	1/4	29.23		
10 x 5 x	3/8		5/16	36.10	
10 x 6 x	3/16	14 x 6 x	3/8	42.79	
	1/4		1/2	62.46	
	5/16		3/8	42.79	
	3/8		1/2	62.46	
	1/2		14 x 10 x	5/16	48.86
10 x 8 x	3/16		3/8	58.10	
	1/4		1/2	76.07	
	5/16		16 x 4 x	1/4	32.63
	3/8		5/16	40.35	
1/2	3/8	47.90			
12 x 2 x	3/16	16 x 4 x	1/2	62.46	
	1/4		3/8	47.90	
	3/8		1/2	62.46	
12 x 3 x	1/4	16 x 8 x	5/16	48.86	
	3/16		3/8	58.10	
	1/4		1/2	76.07	
12 x 4 x	3/16	18 x 6 x	5/16	48.86	
	1/4		3/8	58.11	
	5/16		1/2	76.07	
	3/8		20 x 4 x	3/8	58.10
	1/2		1/2	76.07	
12 x 6 x	3/16	20 x 8 x	3/8	68.31	
	1/4		1/2	89.68	
	5/16				
	3/8				
	1/2				
5/8					



We accept Visa/MasterCard/American Express.

STRUCTURAL CHANNEL

"D" Depth of Channel & Wt. Per Ft.	Wt. for 20'	"WT" Thickness Of Web In Inches	"FW" Width Of Flange In Inches
3" x 3.5 lbs.	70	.140	1.360
4.1 lbs.	82	.170	1.410
5.0 lbs.	100	.258	1.498
6.0 lbs.	120	.356	1.596
4" x 4.5 lbs.	90	.145	1.520
5.4 lbs.	108	.180	1.580
6.25 lbs.	125	.247	1.647
7.25 lbs.	145	.320	1.720
5" x 6.7 lbs.	134	.190	1.750
9.0 lbs.	180	.325	1.885
6" x 8.2 lbs.	164	.200	1.920
10.5 lbs.	210	.314	2.034
13.0 lbs.	260	.437	2.157
7" x 9.8 lbs.	196	.210	2.090
12.25 lbs.	245	.314	2.194
14.75 lbs.	295	.419	2.299
8" x 8.5 lbs.	170	.180	1.875
11.5 lbs.	230	.220	2.260
13.75 lbs.	275	.303	2.343
18.75 lbs.	375	.487	2.527
9" x 13.4 lbs.	268	.230	2.430
15.0 lbs.	300	.285	2.485
20.0 lbs.	400	.448	2.648
10" x 15.3 lbs.	306	.240	2.600
20.0 lbs.	400	.379	2.739
25.0 lbs.	500	.526	2.886
30.0 lbs.	600	.673	3.033

"D" Depth of Channel & Wt. Per Ft.	Wt. for 20'	"WT" Thickness Of Web In Inches	"FW" Width Of Flange In Inches
12" x 20.7 lbs.	414	.280	2.940
25.0 lbs.	500	.387	3.047
30.0 lbs.	600	.510	3.170
15" x 33.9 lbs.	678	.400	3.400
40.0 lbs.	800	.520	3.520
50.0 lbs.	1000	.716	3.716

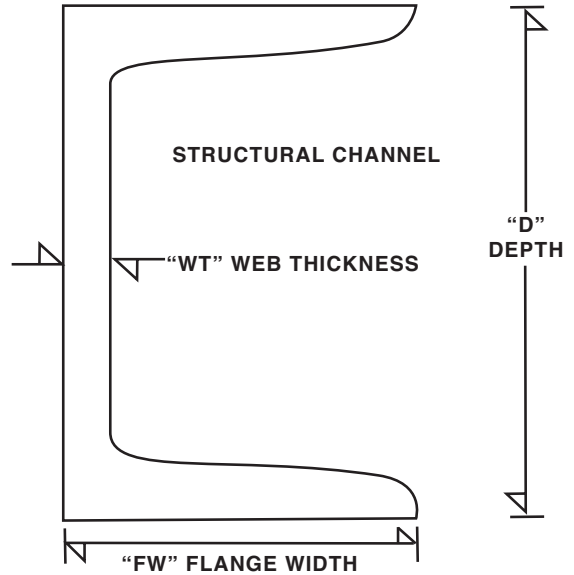

SHIP & CAR CHANNEL

"D" Depth of Channel & Wt. Per Ft.	Wt. for 20'	"WT" Thickness Of Web In Inches	"FW" Width Of Flange In Inches
3" x 7.1 lbs.	142	.313	1.938
4" x 13.8 lbs.	276	.500	2.500
6" x 12.0 lbs.	240	.313	2.500
15.1 lbs.	302	.316	2.941
15.3 lbs.	306	.340	3.500
16.3 lbs.	326	.375	3.000
18.0 lbs.	360	.375	3.500
7" x 17.6 lbs.	352	.375	3.000
19.1 lbs.	382	.350	3.450
22.7 lbs.	454	.500	3.600
8" x 18.7 lbs.	374	.350	2.975
20.0 lbs.	400	.400	3.025
21.4 lbs.	428	.375	3.450
9" x 23.9 lbs.	478	.375	3.500
25.4 lbs.	508	.450	3.500
10" x 22.0 lbs.	440	.290	3.315
25.0 lbs.	500	.375	3.400
28.5 lbs.	570	.425	3.950
12" x 31.0 lbs.	620	.370	3.670
35.0 lbs.	700	.467	3.767
45.0 lbs.	900	.712	4.012
50.0 lbs.	1000	.835	4.135

"D" Depth of Channel & Wt. Per Ft.	Wt. for 20'	"WT" Thickness Of Web In Inches	"FW" Width Of Flange In Inches
13" x 31.8 lbs.	636	.375	4.000
50.0 lbs.	1000	.787	4.412
18" x 42.7 lbs.	854	.450	3.950
45.8 lbs.	916	.500	4.000
58.0 lbs.	1160	.700	4.200

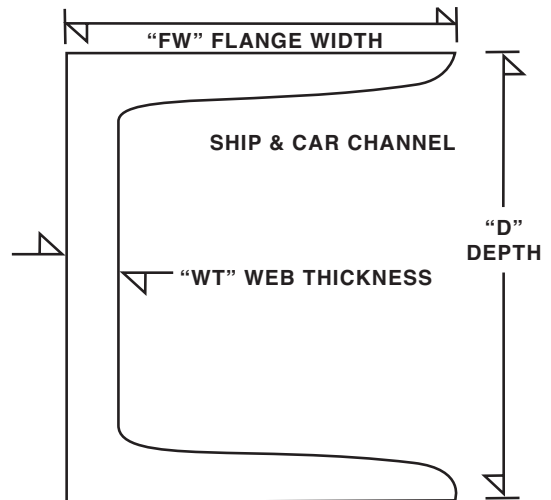

STANDARD I-BEAM

"D" Depth of Channel & Wt. Per Ft.	Wt. for 20'	"WT" Thickness Of Web In Inches	"FW" Width Of Flange In Inches
3" x 5.7 lbs.	114	.170	2.330
7.5 lbs.	150	.349	2.509
4" x 7.7 lbs.	154	.190	2.660
7.7 lbs. (1045)	154	.190	2.660
9.5 lbs.	190	.326	2.796
5" x 10.0 lbs.	200	.210	3.000
14.75 lbs.	295	.494	3.284
6" x 12.5 lbs.	250	.230	3.330
17.25 lbs.	345	.465	3.565
7" x 15.3 lbs.	306	.250	3.660
20.0 lbs.	400	.450	3.860
8" x 18.4 lbs.	368	.270	4.000
23.0 lbs.	460	.441	4.171
10" x 25.4 lbs.	508	.310	4.660
35.0 lbs.	700	.594	4.944
12" x 31.8 lbs.	636	.350	5.000
35.0 lbs.	700	.428	5.078
40.8 lbs.	816	.460	5.250
50.0 lbs.	1000	.687	5.477
15" x 42.9 lbs.	858	.410	5.500
50.0 lbs.	1000	.550	5.640
18" x 54.7 lbs.	1094	.460	6.000
70.0 lbs.	1400	.711	6.251
20" x 66.0 lbs.	1320	.505	6.255
24" x 80.0 lbs.	1600	.500	7.000
100.0 lbs.	2000	.747	7.247
106.0 lbs.	2120	.625	7.875

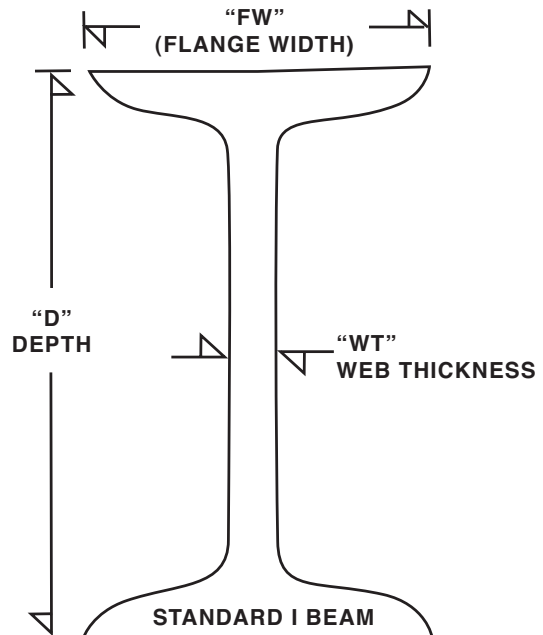

Most Beams Available in Lengths of:
20', 25', 30', 35', 40', 45', 50', 55', 60'



We accept Visa/MasterCard/American Express.

*Wide flange beam information available upon request

FAX YOUR ORDER: METALS, INC. 440-439-0577 • sales@metals-inc.com

COLD ROLLED BAR

Cold Finished Flats

Size	Wt. Per Ft. Lbs.	Wt. For 12' Bar	Size	Wt. Per Ft. Lbs.	Wt. For 12' Bar	Size	Wt. Per Ft. Lbs.	Wt. For 12' Bar	Size	Wt. Per Ft. Lbs.	Wt. For 12' Bar
3/4 x 4	10.20	122.40	1 x 7	23.80	285.60	1-1/2 x3	15.30	183.60	2 x 4	27.20	326.40
4-1/2	11.48	137.70	8	27.20	326.40	3-1/4	16.58	198.96	4-1/2	30.60	367.20
5	12.75	153.00	9	30.60	367.20	3-1/2	17.85	214.20	5	34.00	408.00
5-1/2	14.03	168.30	10	34.00	408.00	4	20.40	244.80	6	40.80	489.60
6	15.30	183.60	11	37.40	448.80	4-1/2	22.95	275.40	8	54.40	652.80
6-1/2	16.58	198.96	12	40.80	489.60	5	25.90	306.00	10	68.00	816.00
7	17.85	214.20	1-1/8 x1-1/4	4.78	57.37	5-1/2	28.05	336.60	12	81.60	979.20
8	20.40	244.80	1-3/8	5.26	63.11	6	30.60	367.20	2-1/4 x2-1/2	19.13	229.50
9	22.95	275.40	1-1/2	5.74	68.86	8	40.80	489.60	3	22.95	275.40
10	25.50	306.00	1-5/8	6.22	74.59	10	51.00	612.00	3-1/4	24.86	298.36
11	28.05	336.60	1-3/4	6.69	80.33	12	61.20	734.40	3-1/2	26.78	321.30
12	30.60	367.20	2	7.65	91.80	1-5/8 x2	11.05	132.60	4	30.60	367.20
7/8 x 1	2.98	35.70	2-1/4	8.61	103.27	2-1/2	13.81	165.72	4-1/2	34.43	413.10
1-1/8	3.35	40.16	2-1/2	9.56	114.76	3	16.58	198.90	5	38.25	459.00
1-1/4	3.72	44.63	3	11.48	137.70	4	22.10	265.20	6	45.90	550.80
1-3/8	4.09	49.09	4	15.30	183.60	1-3/4 x2	11.90	142.80	2-1/2 x2-3/4	23.38	280.56
1-1/2	4.46	53.56	1-1/4 x1-3/8	5.84	70.13	2-1/4	13.39	106.66	3	25.50	306.00
1-3/4	5.21	62.47	1-1/2	6.38	76.50	2-1/2	14.88	178.50	3-1/2	29.76	357.00
2	5.95	71.40	1-5/8	6.91	82.87	2-3/4	16.36	196.36	4	34.00	408.00
2-1/4	6.69	80.33	1-3/4	7.44	89.26	3	17.85	214.20	4-1/2	38.25	459.00
2-1/2	7.44	89.26	1-7/8	7.97	95.63	3-1/2	20.83	249.90	5	42.50	510.00
2-3/4	8.18	98.17	2	8.50	102.00	3-3/4	22.31	267.12	6	51.00	612.00
3	8.93	107.10	2-1/4	9.56	114.76	4	23.80	285.60	8	68.00	816.00
3-1/2	10.41	124.96	2-1/2	10.63	127.50	4-1/2	26.78	321.30	10	85.00	1020.00
4	11.90	142.80	2-3/4	11.69	140.26	5	29.75	357.00	3 x 3-1/2	35.70	428.40
4-1/2	13.39	160.66	3	12.75	153.00	5-1/2	32.73	392.76	4	40.80	489.60
5	14.88	178.50	3-1/4	13.81	165.72	6	35.70	428.40	5	51.00	612.00
5-1/2	16.36	196.32	3-1/2	14.88	178.50	2 x 2-1/4	15.30	183.60	6	61.20	734.40
6	17.85	214.20	3-3/4	15.94	191.28	2-1/2	17.00	204.00	8	81.60	979.20
8	23.80	285.10	4	17.00	204.00	2-3/4	18.70	224.40	10	102.00	1224.00
10	29.75	357.00	4-1/2	19.13	229.56	3	20.40	244.80	12	122.40	1468.80
12	35.70	428.40	5	21.25	255.00	3-1/2	23.80	285.60			
1 x 1-1/8	3.38	45.90	5-1/2	23.38	280.50						
1-1/4	4.25	51.00	6	25.50	306.00						
1-3/8	4.68	56.10	8	34.00	408.00						
1-1/2	5.10	61.20	10	42.50	510.00						
1-3/4	5.95	71.40	12	51.00	612.00						
2	6.80	81.60	1-3/8 x1-1/2	7.01	84.16						
2-1/4	7.65	91.80	2	9.35	112.20						
2-1/2	8.50	102.00	3	14.03	168.30						
2-3/4	9.35	112.20	1-1/2 x1-5/8	8.29	99.46						
3	10.20	122.40	1-3/4	8.93	107.10						
3-1/4	11.05	132.60	1-7/8	9.56	114.76						
3-1/2	11.90	142.80	2	10.20	122.40						
4	13.60	163.20	2-1/4	11.48	137.70						
4-1/2	15.30	183.60	2-1/2	12.75	153.00						
5	17.00	204.00	2-3/4	14.03	168.30						
5-1/2	18.70	224.40									
6	20.40	244.80									



*Can also supply in Aluminum and Stainless

COLD ROLLED BAR

Cold Finished Rounds – 1018

Size	Wt. Per Ft. Lbs.	Wt. For 12' Bar	Size	Wt. Per Ft. Lbs.	Wt. For 12' Bar
1/8	.042	.504	1-3/4	8.178	98.14
5/32	.065	.780	1-13/16	8.773	105.28
3/16	.094	1.13	1-7/8	9.388	112.66
7/32	.128	1.54	1-15/16	10.024	120.29
1/4	.167	2.00	2	10.68	128.16
17/64	.188	2.26	2-1/16	11.36	136.32
9/32	.211	2.53	2-1/8	12.06	144.72
5/16	.261	3.13	2-3/16	12.78	153.36
21/64	.288	3.46	2-1/4	13.52	162.24
11/32	.316	3.79	2-5/16	14.28	171.36
3/8	.376	4.51	2-3/8	15.06	180.72
25/64	.408	4.90	2-7/16	15.87	190.44
13/32	.441	5.29	2-1/2	16.69	200.28
7/16	.511	6.13	2-9/16	17.53	210.36
15/32	.587	7.04	2-5/8	18.40	220.80
1/2	.668	8.02	2-11/16	19.29	231.48
33/64	.710	8.52	2-3/4	20.19	242.28
17/32	.754	9.05	2-13/16	21.12	253.44
9/16	.845	10.14	2-7/8	22.07	264.84
19/32	.941	11.29	2-15/16	23.04	276.48
5/8	1.043	12.52	3	24.03	288.36
41/64	1.096	13.15	3-1/16	25.05	300.60
11/16	1.262	15.14	3-1/8	26.08	312.96
23/32	1.380	16.56	3-3/16	27.13	325.56
3/4	1.502	18.02	3-1/4	28.21	338.52
49/64	1.565	18.78	3-5/16	29.30	351.60
25/32	1.630	19.56	3-3/8	30.42	365.04
13/16	1.763	21.16	3-7/16	31.55	378.60
27/32	1.901	22.81	3-1/2	32.71	392.52
7/8	2.045	24.54	3-9/16	33.89	406.68
57/64	2.118	25.42	3-5/8	35.09	421.08
29/32	2.193	26.32	3-11/16	36.31	435.72
15/16	2.347	28.16	3-3/4	37.55	450.60
1	2.670	32.04	3-7/8	40.10	481.20
1-1/16	3.015	36.18	3-15/16	41.40	496.80
1-1/8	3.380	40.56	4	42.73	512.76
1-3/16	3.766	45.19	4-1/8	45.44	545.28
1-1/4	4.172	50.06	4-3/16	46.83	561.96
1-5/16	4.600	55.20	4-1/4	48.23	578.76
1-3/8	5.049	60.59	4-3/8	51.11	613.32
1-7/16	5.518	66.22	4-7/16	52.58	630.96
1-1/2	6.008	72.10	4-1/2	54.08	648.96
1-9/16	6.519	78.23	4-9/16	55.59	667.08
1-5/8	7.051	84.61	4-5/8	57.12	685.44
1-11/16	7.604	91.25	4-3/4	60.25	723.00

Cold Finished Rounds – 1018

Size	Wt. Per Ft. Lbs.	Wt. For 12' Bar	Size	Wt. Per Ft. Lbs.	Wt. For 12' Bar
4-7/8	63.46	761.52	6	96.13	1153.56
4-15/16	65.10	781.20	6-1/8	100.18	1202.16
5	66.76	801.12	6-1/4	104.31	1251.72
5-1/8	70.14	841.68	6-1/2	112.82	1353.84
5-1/4	73.60	883.20	6-3/4	121.67	1460.04
5-3/8	77.15	925.80	7	130.85	1570.20
5-7/16	78.95	947.40	7-1/4	140.36	1684.32
5-1/2	80.78	969.36	7-1/2	150.21	1802.52
5-5/8	84.49	1013.88	8	170.90	2050.80
5-3/4	88.29	1059.48	8-1/2	192.93	2315.16
5-7/8	92.17	1106.04	9	216.30	2595.60
5-15/16	94.14	1129.68	10	267.00	3204.00
			12	384.53	4614.36

Cold Finished Squares

Size	Wt. Per Ft. Lbs.	Wt. For 12' Bar	Size	Wt. Per Ft. Lbs.	Wt. For 12' Bar
1/8	.053	.636	9/32	.269	3.23
5/32	.083	1.0	5/16	.332	3.98
3/16	.120	1.44	11/32	.402	4.82
7/32	.163	1.96	3/8	.478	5.74
1/4	.213	2.56	7/16	.651	7.81
1/2	.850	10.20	1-3/4	10.419	125.03
9/16	1.076	12.91	1-7/8	11.95	143.40
5/8	1.329	15.95	2	13.60	163.20
11/16	1.608	19.30	2-1/8	15.35	184.20
3/4	1.914	22.97	2-1/4	17.22	206.64
13/16	2.246	26.95	2-3/8	19.18	230.16
7/8	2.605	31.26	2-1/2	21.26	255.12
15/16	2.990	35.88	2-5/8	23.43	281.16
1	3.402	40.82	2-3/4	25.73	308.76
1-1/16	3.841	46.09	2-7/8	28.10	337.20
1-1/8	4.306	51.67	3	30.60	367.20
1-1/16	4.798	57.58	3-1/4	35.91	430.92
1-1/4	5.316	63.79	3-1/2	41.65	499.80
1-5/16	5.861	70.33	3-3/4	47.81	573.72
1-3/8	6.432	77.18	4	54.40	625.80
1-7/16	7.030	84.36	4-1/2	68.85	826.20
1-1/2	7.655	91.86	5	85.00	1020.00
1-9/16	8.306	99.67	5-1/2	102.85	1234.20
1-5/8	8.984	107.81	6	122.40	1468.80

*Can also supply in Aluminum and Stainless

HOT ROLLED BAR

Hot Rolled Rounds

Size	Wt. Per Ft.	Wt. For 20' Length	Size	Wt. Per Ft.	Wt. For 20' Length
3/16	.094	1.88	4	42.73	854.60
1/4	.167	3.34	4-1/4	48.23	964.60
5/16	.261	5.22	4-1/2	54.08	1081.60
3/8	.376	7.52	4-5/8	57.12	1142.40
1/2	.668	13.36	4-3/4	60.25	1205.00
5/8	1.04	20.80	5	66.76	1335.20
3/4	1.50	30.00	5-1/4	73.60	1472.00
7/8	2.04	40.80	5-1/2	80.78	1615.60
1	2.67	53.40	5-3/4	88.29	1765.80
1-1/8	3.38	67.60	6	96.13	1922.60
1-1/4	4.17	83.40	6-1/4	104.3	2086.00
1-3/8	5.05	101.00	6-1/2	112.8	2256.00
1-1/2	6.01	120.20	6-3/4	121.7	2434.00
1-5/8	7.05	141.00	7	130.9	2618.00
1-3/4	8.18	163.60	7-1/4	140.4	2808.00
1-7/8	9.39	187.80	7-1/2	150.2	3004.00
2	10.68	213.60	7-3/4	160.4	3208.00
2-1/4	13.52	270.40	8	170.9	3418.00
2-3/8	15.06	301.20	8-1/4	181.8	3636.00
2-1/2	16.69	333.80	8-1/2	192.9	3858.00
2-5/8	18.40	368.00	8-3/4	204.5	4090.00
2-3/4	20.19	403.80	9	216.3	4326.00
3	24.03	480.60	9-1/4	228.5	4570.00
3-1/4	28.21	564.20	9-1/2	241.0	4820.00
3-1/2	32.71	654.20	10	267.0	5340.00
3-3/4	37.55	751.00	10-1/2	294.4	5888.00
			11	323.1	6462.00
			12	384.5	7690.00

Hot Rolled Squares

Size	Wt. Per Ft.	Wt. For 20' Length	Size	Wt. Per Ft.	Wt. For 20' Length
1/4	.213	4.26	2	13.60	272.00
3/8	.478	9.56	2-1/4	17.21	344.20
7/16	.651	13.02	2-1/2	21.25	425.00
1/2	.850	17.00	2-3/4	25.71	514.20
9/16	1.08	21.60	3	30.60	612.00
5/8	1.33	26.60	3-1/4	35.91	718.20
11/16	1.61	32.20	3-1/2	41.65	833.00
3/4	1.91	38.20	3-3/4	47.81	956.20
7/8	2.60	52.00	4	54.40	1088.00
1	3.40	68.00	4-1/2	68.85	1377.00
1-1/8	4.30	86.00	5	85.00	1700.00
1-1/4	5.31	106.20	6	122.40	2448.00
1-3/8	6.43	128.60			
1-1/2	7.65	153.00			
1-5/8	8.98	179.60			
1-3/4	10.41	208.20			
1-7/8	11.95	239.00			

Hot Rolled Flats

Size	Wt. Per Ft.	Wt. For 20' Length	Size	Wt. Per Ft.	Wt. For 20' Length
1/4 x 3/8	.319	6.38	1/4 x 3	2.55	51.00
x 1/2	.425	8.50	x 3-1/4	2.76	55.20
x 5/8	.531	10.62	x 3-1/2	2.98	59.60
x 3/4	.638	12.76	x 3-3/4	3.19	63.80
x 7/8	.744	14.88	x 4	3.40	68.00
x 1	.850	17.00	x 4-1/4	3.61	72.20
x 1-1/8	.956	19.12	x 4-1/2	3.83	76.60
x 1-1/4	1.06	21.20	x 5	4.25	85.00
x 1-3/8	1.17	23.40	x 5-1/2	4.68	93.60
x 1-1/2	1.28	25.60	x 6	5.10	102.00
x 1-5/8	1.38	27.60	x 7	5.95	119.00
x 1-3/4	1.49	29.80	x 7-1/2	6.38	127.60
x 2	1.70	34.00	x 8	6.80	136.00
x 2-1/4	1.91	38.20	9UM	7.66	153.20
x 2-1/2	2.13	42.60	10UM	8.51	170.20
x 2-3/4	2.34	46.80	11UM	9.36	187.20
			11-1/2UM	9.78	195.60
			12UM	10.21	204.20



*Can also supply in Aluminum and Stainless

HOT ROLLED BAR

Hot Rolled Flats (Contd)

Size	Wt. Per Ft.	Wt. For 20' Length	Size	Wt. Per Ft.	Wt. For 20' Length	Size	Wt. Per Ft.	Wt. For 20' Length	Size	Wt. Per Ft.	Wt. For 20' Length
5/16x 1/2	.531	10.62	3/8 x 2	2.55	51.00	5/8 x 3/4	1.60	32.00	3/4 x 4	10.21	204.20
x 5/8	.664	13.28	x 2-1/4	2.87	57.40	x 7/8	1.86	37.20	x 4-1/2	11.49	229.80
x 3/4	.797	15.94	x 2-1/2	3.19	63.80	x 1	2.13	42.60	x 5	12.76	255.20
x 7/8	.930	18.60	x 2-3/4	3.51	70.20	x 1-1/4	2.66	53.20	x 5-1/2	14.04	280.80
x 1	1.06	21.20	x 3	3.83	76.60	x 1-3/8	2.92	58.40	x 6	15.31	306.20
x 1-1/8	1.20	24.00	x 3-1/4	4.15	83.00	x 1-1/2	3.19	63.80	x 7	17.87	357.40
x 1-1/4	1.33	26.60	x 3-1/2	4.47	89.40	x 1-5/8	3.46	69.20	x 8	20.42	408.40
x 1-3/8	1.46	29.20	x 4	5.10	102.00	x 1-3/4	3.72	74.40	9UM	22.97	459.40
x 1-1/2	1.59	31.80	x 4-1/2	5.74	114.80	x 2	4.25	85.00	10UM	25.52	510.40
x 1-3/4	1.86	37.20	x 5	6.38	127.60	x 2-1/4	4.79	95.80	12UM	30.63	612.60
x 2	2.13	42.60	x 5-1/2	7.02	140.40	x 2-1/2	5.32	106.40	7/8 x 1	2.98	59.60
x 2-1/4	2.39	47.80	x 6	7.66	153.20	x 2-3/4	5.85	117.00	x 1-1/4	3.72	74.40
x 2-1/2	2.66	53.20	x 7	8.93	178.60	x 3	6.38	127.60	x 1-3/8	4.09	81.80
x 2-3/4	2.92	58.40	x 8	10.21	204.20	x 3-1/4	6.91	138.20	x 1-1/2	4.46	89.20
x 3	3.19	63.80	9UM	11.49	229.80	x 3-1/2	7.44	148.80	x 1-3/4	5.21	104.20
x 3-1/4	3.45	69.00	10UM	12.76	255.20	x 4	8.51	170.20	x 2	5.95	119.00
x 3-1/2	3.72	74.40	12UM	15.31	306.20	x 4-1/2	9.57	191.40	x 2-1/4	6.69	133.80
x 4	4.25	85.00	1/2 x 5/8	1.06	21.20	x 5	10.64	212.80	x 2-1/2	7.44	148.80
x 4-1/2	4.78	95.60	x 3/4	1.28	25.60	x 5-1/2	11.70	234.00	x 3	8.93	178.60
x 5	5.31	106.20	x 7/8	1.49	29.80	x 6	12.76	255.20	x 3-1/2	10.41	208.20
x 5-1/2	5.84	116.80	x 1	1.70	34.00	x 7	14.89	297.80	x 4	11.90	238.00
x 6	6.38	127.60	x 1-1/8	1.91	38.20	x 8	17.02	340.40	x 4-1/2	13.39	267.80
x 7	7.44	148.80	x 1-1/4	2.13	42.60	9UM	19.14	382.80	x 5	14.88	297.60
x 8	8.50	170.00	x 1-3/8	2.34	46.80	10UM	21.27	425.40	x 5-1/2	16.36	327.20
9UM	9.57	191.40	x 1-1/2	2.55	51.00	12UM	25.52	510.40	x 6	17.85	357.00
10UM	10.64	212.80	x 1-5/8	2.77	55.40	3/4 x 7/8	2.23	44.60	x 7	20.83	416.60
12UM	12.76	255.20	x 1-3/4	2.98	59.60	x 1	2.55	51.00	x 8	23.80	476.00
3/8 x 1/2	.638	12.76	x 2	3.40	68.00	x 1-1/8	2.87	57.40	10UM	29.78	595.60
x 5/8	.797	15.94	x 2-1/4	3.83	76.60	x 1-1/4	3.19	63.80	12UM	35.73	714.60
x 3/4	.956	19.12	x 2-1/2	4.25	85.00	x 1-1/2	3.83	76.60	1 x 1-1/4	4.25	85.00
x 7/8	1.12	22.40	x 2-3/4	4.68	93.60	x 1-5/8	4.15	83.00	x 1-1/2	5.10	102.00
x 1	1.28	25.60	x 3	5.10	102.00	x 1-3/4	4.47	89.40	x 1-3/4	5.95	119.00
x 1-1/8	1.44	28.80	x 3-1/4	5.53	110.60	x 2	5.10	102.00	x 2	6.80	136.00
x 1-1/4	1.60	32.00	x 3-1/2	5.96	119.20	x 2-1/4	5.74	114.80	x 2-1/4	7.65	153.00
x 1-3/8	1.75	35.00	x 3-3/4	6.38	127.60	x 2-1/2	6.38	127.60	x 2-1/2	8.50	170.00
x 1-1/2	1.91	38.20	x 4	6.81	136.20	x 2-3/4	7.02	140.40	x 2-3/4	9.35	187.00
x 1-5/8	2.07	41.40	x 4-1/2	7.66	153.20	x 3	7.66	153.20	x 3	10.20	204.00
x 1-3/4	2.23	44.60	x 5	8.51	170.20	x 3-1/4	8.30	166.00	x 3-1/4	11.05	221.00
			x 5-1/2	9.36	187.20	x 3-1/2	8.93	178.60	x 3-1/2	11.90	238.00
			x 6	10.21	204.20				x 4	13.60	272.00
			x 7	11.91	238.20				x 4-1/2	15.30	306.00
			x 8	13.61	272.20						
			9UM	15.31	306.20						
			10UM	17.02	340.40						
			12UM	20.42	408.40						

HOT ROLLED ANGLE IRON

Size In Inches	Wt. Per Ft. In Lbs.	Wt. For 20' Length	Size In Inches	Wt. Per Ft. In Lbs.	Wt. For 20' Length
1/2 x 1/2			2 x 2		
1/8	.38	7.60	1/8	1.65	33.00
3/4 x 3/4			3/16	2.44	48.80
1/8	.59	11.80	1/4	3.19	63.80
1 x 1			5/16	3.92	78.40
1/8	.80	16.00	3/8	4.70	94.00
3/16	1.16	23.20	2-1/4x 1-1/2		
1/4	1.49	29.80	3/16	2.28	45.60
1-1/4x 1-1/4			2-1/2x 1-1/2		
1/8	1.01	20.20	3/16	2.44	48.80
3/16	1.48	29.60	1/4	3.19	63.80
1/4	1.92	38.40	5/16	3.92	78.40
1-1/2x 1-1/4			2-1/2x 2		
3/16	1.64	32.80	3/16	2.75	55.00
1-1/2x 1-1/2			1/4	3.62	72.40
1/8	1.23	24.60	5/16	4.50	90.00
3/16	1.80	36.00	3/8	5.30	106.0
1/4	2.34	46.80	2-1/2x 2-1/2		
1-3/4x 1-1/4			3/16	3.07	61.40
1/8	1.23	24.60	1/4	4.10	82.00
3/16	1.80	36.00	5/16	5.00	100.00
1-3/4x 1-3/4			3/8	5.90	118.00
1/8	1.44	28.80	1/2	7.70	154.00
3/16	2.12	42.40			
1/4	2.77	55.40			
2 x 1-1/4					
3/16	1.96	39.20			
1/4	2.55	51.00			
2 x 1-1/2					
1/8	1.44	28.80			
3/16	2.12	42.40			
1/4	2.77	55.40			

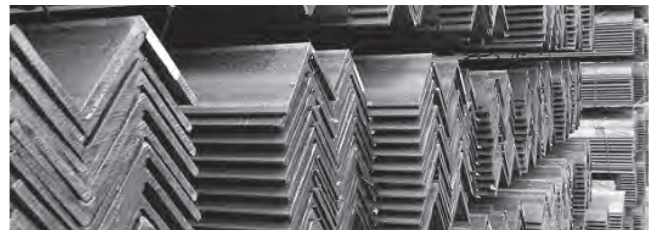
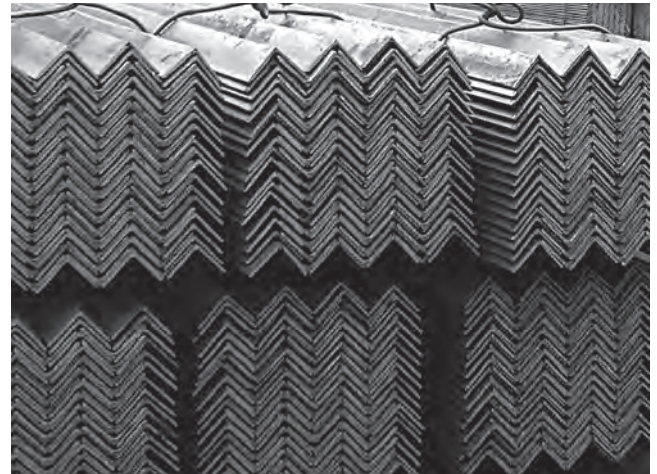
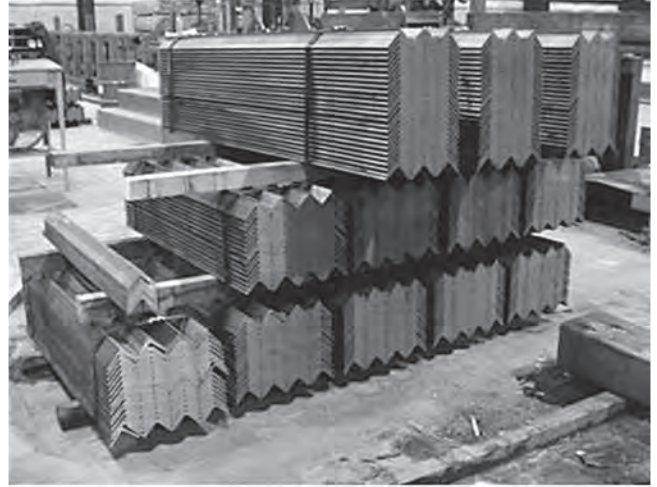

We accept Visa/MasterCard/American Express.

*Can also supply in Aluminum and Stainless

HOT ROLLED ANGLE IRON

Size In Inches	Wt. Per Ft. In Lbs.	Wt. For 20' Length	Size In Inches	Wt. Per Ft. In Lbs.	Wt. For 20' Length	Size In Inches	Wt. Per Ft. In Lbs.	Wt. For 20' Length	Size In Inches	Wt. Per Ft. In Lbs.	Wt. For 20' Length				
3 x 2	3/16	3.07	61.4	4 x 3-1/2	7/16	10.6	212.0	6 x 6	8 x 4	1/2	19.6	392.0			
	1/4	4.1	82.0		1/2	11.9	238.0			3/8	14.9	298.0	5/8	24.2	484.0
	5/16	5.0	100.0		5/8	14.7	294.0			1/2	19.6	392.0	3/4	28.7	574.0
	3/8	5.9	118.0	4 x 4	1/4	6.6	132.0		5/8	24.2	484.0	8 x 6	1/2	23.0	460.0
	1/2	7.7	154.0		5/16	8.2	164.0		3/4	28.7	574.0		5/8	28.5	570.0
3 x 2-1/2	1/4	4.5	90.0	3/8	9.8	196.0	7/8	33.1	662.0	8 x 8	3/4	33.8	676.0		
	5/16	5.6	112.0	7/16	11.3	226.0	1	37.4	748.0		1	44.2	884.0		
	3/8	6.6	132.0	1/2	12.8	256.0	7 x 4	3/8	13.6	272.0	8 x 8	1/2	26.4	528.0	
	1/2	8.5	170.0	5/8	15.7	314.0		7/16	15.8	316.0		5/8	32.7	654.0	
	3 x 3	3/16	3.71	74.2	3/4	18.5		370.0	1/2	17.9		358.0	3/4	38.9	778.0
1/4		4.9	98.0	5 x 3	1/4	6.6	132.0	5/8	22.1	442.0	1	51.0	1020.0		
5/16		6.1	122.0		5/16	8.2	164.0	3/4	26.2	524.0					
3/8		7.2	144.0	3/8	9.8	196.0	5 x 3-1/2	1/2	12.8	256.0					
7/16		8.3	166.0	1/2	12.8	256.0		1/4	7.0	140.0					
3-1/2 x 2-1/2	1/2	9.4	188.0	5/16	8.2	164.0	3/8	10.4	208.0						
	3-1/2 x 3	1/4	4.9	98.0	7/16	12.0	240.0	1/2	13.6	272.0					
		5/16	6.1	122.0	1/2	13.6	272.0	5/8	16.8	336.0					
		3/8	7.2	144.0	3/4	19.8	396.0	5 x 5	5/16	10.3	206.0				
		1/2	9.4	188.0	1/2	16.2	324.0		3/8	12.3	246.0				
3-1/2 x 3		1/4	5.4	108.0	5/8	20.0	400.0	3/4	23.6	472.0					
	5/16	6.6	132.0	6 x 3-1/2	5/16	9.8	196.0	5/16	9.8	196.0					
	3/8	7.9	158.0		3/8	11.7	234.0	3/8	11.7	234.0					
	1/2	10.2	204.0	1/2	15.3	306.0	1/2	15.3	306.0						
	3-1/2 x 3-1/2	1/4	5.8	116.0	6 x 4	5/16	10.3	206.0	5/16	10.3	206.0				
5/16		7.2	144.0	3/8		12.3	246.0	3/8	12.3	246.0					
3/8		8.5	170.0	7/16	14.3	286.0	7/16	14.3	286.0						
7/16		9.8	196.0	1/2	16.2	324.0	1/2	16.2	324.0						
1/2		11.1	222.0	5/8	20.0	400.0	5/8	20.0	400.0						
4 x 3	5/8	13.6	272.0	3/4	23.6	472.0	3/4	23.6	472.0						
	4 x 3-1/2	1/4	6.2	124.0	7/8	27.2	544.0	7/8	27.2	544.0					
		5/16	7.7	154.0											
		3/8	9.1	182.0											

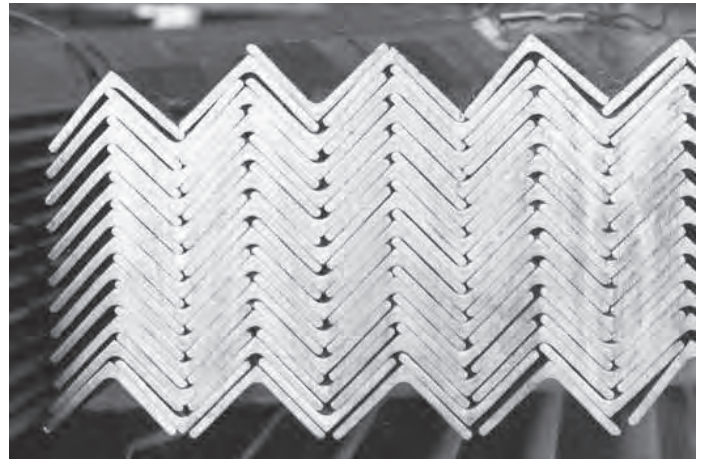

**We accept
Visa/MasterCard/
American Express.**

*Can also supply in Aluminum and Stainless

ROOFTOP WALKWAY SYSTEMS



Metals, Inc. employees were the first to design Rooftop Walkway and ramp systems utilizing galvanized steel U-Bend supports beneath a non-slip plank type grating.

The Metals, Inc. Rooftop Walkway has replaced inferior products such as wood panels, which easily scatter. They also splinter upon slight impact, rot, are easily covered by snow and ice, and are very slippery.

DESIGN INFORMATION:

- All Metals, Inc. Rooftop Walkways are constructed from 12 gauge galvanized steel
- Standard overall heights are 5, 6, and 7 inches
- Non-skid walkway surface is 2 ft. wide x 10 ft. long. Call for other widths & lengths.
- Three Metals, Inc. U-Bend 12 gauge galvanized supports per panel
- Panel is supplied as one piece (welded)
- Panel weight is approximately 155 lbs. to 170 lbs. depending on overall height/width/length
- Bearing load on 4 foot span is 162 lbs. uniform with .31 deflection
- Bearing load on 4 foot span is 325 lbs. concentrated with .2 deflection

This design was utilized after numerous tests which rated:

- Load Factors and deflection
- Height from the rooftop surface to the top of the Metals, Inc. Rooftop panel
- Snow drift build up
- Four way slip resistance under wet and icy conditions
- Overall weight of each complete 10 ft. panel
- Displacement of load by using the Metals, Inc. U-Bend carriage supports, ending roof membrane damage
- Ease of placement (one piece design)
- Defines walkway area which discourages walking directly on the roof surface
- Most of all SAFETY

**Call Metals, Inc. for engineering and pricing information
regarding your rooftop application. 1-800-492-7304**

COMPOSITE FLOOR BLOCKS

Design Information:

- Standard size 2", 2-1/2", or 3" Thick x 4" Wide x 6" Long. Please note that Metals, Inc. can produce the block in different lengths upon request, this creates a cost savings on installation.
- Pallet Sizes: 2" = 1,296 blocks per pallet
2-1/2" = 1080 blocks per pallet
3" = 845 blocks per pallet
- The block is manufactured to size with tolerances of +/- 1/16", which makes them easier to install because of uniformity.
- Provides a denser block, making the block harder, which will result in less grooving and provide longer duration for the product.

Benefits:

- Is less costly than concrete to install and maintain. Concrete is never consistent through the pour, it causes cracking and chipping. When these cracks and chips occur, it is more costly to replace the area concrete than to replace a few blocks.
- Metals, Inc. Composite Floor Block is produced from recycled materials making it environmentally correct from cradle to grave. Each truckload of Metals, Inc. Composite Flooring material prevents 20,000# of plastic from entering landfills as well as saves over 10 mature pine trees.
- Metals, Inc. Composite Floor Blocks replace cresol wood floor blocks and other blocks that are environmentally unfriendly.
- Metals, Inc. Composite Floor Blocks do not absorb water which means minimal or no block expansion or swelling. Other blocks can expand when wet causing mounding which results in unnecessary shutdowns and maintenance.
- Metals, Inc. Composite Floor Blocks are ergonomically better than concrete, softer, and quieter when AGV's or other vehicles ride over them.
- No oil or grease buildup on Metals, Inc. Composite Floor Blocks resulting in lower maintenance costs as compared to concrete.
- Metals, Inc. packages the block in a memory strapping system, eliminating numerous trips carrying single blocks, thus saving time and labor costs.
- Metals, Inc. is able to provide your facility with immediate delivery thus avoiding any unnecessary shutdowns or inconveniences.



EASYSTEP - STAIRWAYS & RAMPS

Roof and General Work Platforms, Ramps and Stairway Crossovers

Quality that lasts: Our platforms and crossovers are engineered for maximum strength, made with a durable steel frame and non-slip tread. All system parts are powder-coated and galvanized to prevent rust. Easy nut and bolt assembly.

Customizable & versatile: Easy-Step platforms and crossovers are available in standard sizes, but can be configured to any size or shape to fit your need. Please call for quote, or email your drawings or specifications to: request@metals-inc.com.



CONVERSION CHARTS

DECIMAL EQUIVALENTS

1/64"	0.0156250	33/64"	0.5156250
1/32"	0.0312500	17/32"	0.5312500
3/64"	0.0468750	35/64"	0.5468750
1/16"	0.0625000	9/16"	0.5625000
5/64"	0.0781250	37/64"	0.5781250
3/32"	0.0937500	19/32"	0.5937500
7/64"	0.1093750	39/64"	0.6093750
1/8"	0.1250000	5/8"	0.6250000
9/64"	0.1406250	41/64"	0.6406250
5/32"	0.1562500	21/32"	0.6562500
11/64"	0.1718750	43/64"	0.6718750
3/16"	0.1875000	11/16"	0.6875000
13/64"	0.2031250	45/64"	0.7031250
7/32"	0.2187500	23/32"	0.7187500
15/64"	0.2343750	47/64"	0.7347500
1/4"	0.2500000	3/4"	0.7500000
7/64"	0.2656250	49/64"	0.7656250
9/32"	0.2812500	25/32"	0.7812500
19/64"	0.2968750	51/64"	0.7968750
5/16"	0.3125000	13/16"	0.8125000
21/64"	0.3281250	53/64"	0.8281250
11/32"	0.3437500	27/32"	0.8437500
23/64"	0.3750000	7/8"	0.8750000
25/64"	0.3906250	57/64"	0.8906250
13/32"	0.4062500	29/32"	0.9062500
27/64"	0.4218750	59/64"	0.9218750
7/16"	0.4375000	15/16"	0.9375000
29/64"	0.4531250	61/64"	0.9531250
15/32"	0.4687500	31/32"	0.9687500
31/64"	0.4843750	63/64"	0.9843750
1/2"	0.5000000	1"	1.0000000

TABLE OF MILLIMETER EQUIVALENTS OF INCHES

Inches		MM	Inches		MM	Inches		MM
1/64"	0.015625	0.397	23/64"	0.359375	9.128	45/64"	0.703125	17.859
1/32"	0.03125	0.794	3/8"	0.375	9.525	23/32"	0.71875	18.256
3/64"	0.046875	1.191	25/64"	0.390625	9.922	47/64"	0.734375	18.653
1/16"	0.0625	1.588	13/32"	0.40625	10.319	3/4"	0.75	19.05
5/64"	0.078125	1.984	27/64"	0.421875	10.716	49/64"	0.765625	19.447
3/32"	0.09375	2.381	7/16"	0.4375	11.113	25/32"	0.78125	19.844
7/64"	0.109375	2.778	29/64"	0.453125	11.509	51/64"	0.796875	20.241
1/8"	0.125	3.175	15/32"	0.46875	11.906	13/16"	0.8125	20.638
9/64"	0.140625	3.572	31/64"	0.484375	12.303	53/64"	0.828125	21.034
5/32"	0.15625	3.969	1/2"	0.5	12.7	27/32"	0.84375	21.431
11/64"	0.171875	4.366	33/64"	0.515625	13.097	55/64"	0.859375	21.828
3/16"	0.1875	4.763	17/32"	0.53125	13.494	7/8"	0.875	22.225
13/64"	0.203125	5.159	35/64"	0.546875	13.891	57/64"	0.890625	22.622
7/32"	0.21875	5.556	9/16"	0.5625	14.288	29/32"	0.90625	23.019
15/64"	0.234375	5.953	37/64"	0.578125	14.684	59/64"	0.921875	23.416
1/4"	0.25	6.35	19/32"	0.59375	15.081	15/16"	0.9375	23.813
17/64"	0.265625	6.747	39/64"	0.609375	15.478	61/64"	0.953125	24.209
9/32"	0.28125	7.144	5/8"	0.625	15.875	31/32"	0.96875	24.606
19/64"	0.296875	7.54	41/64"	0.640625	16.272	63/64"	0.984375	25.003
5/16"	0.3125	7.938	21/32"	0.65625	16.669	1"	1	25.4
21/64"	0.328125	8.334	43/64"	0.671875	17.066			
11/32"	0.34375	8.731	11/16"	0.6875	17.463			

TABLE OF GAUGES AND WEIGHTS

Gauge	Steel		Galv. Steel		Long Term		Stainless			USS Gauge		Monel	
	USS Gauge Rev.		USS Gauge		USS Gauge		lbs. per sq ft			USS Gauge			
	Decimal	lbs. per sq ft	Decimal	lbs. per sq ft	Decimal	lbs. per sq ft	Decimal	Chrome Alloy	Chrome Nickel	Decimal	lbs. per sq ft	Decimal	lbs. per sq ft
32	0.0100		0.0130	0.5630			0.0100	0.4180	0.4270				
31	0.0110		0.0140	0.5940			0.0109	0.4500	0.4590				
30	0.0120	0.5000	0.0157	0.6560	0.0120	0.5180	0.0125	0.5150	0.5250				
29	0.0135	0.5630	0.0172	0.7190	0.0140	0.5810	0.0140	0.5790	0.5910				
28	0.0149	0.6250	0.0187	0.7810	0.0150	0.6430	0.0156	0.6430	0.6560				
27	0.0164	0.6880	0.0202	0.8440	0.0170	0.7060	0.0171	0.7080	0.7210				
26	0.0179	0.7500	0.0217	0.9060	0.0180	0.7680	0.0187	0.7720	0.7870	0.0187	0.8270		
25	0.2090	0.8750	0.0247	1.0310	0.0210	0.8930	0.0218	0.9010	0.9180	0.0218	0.9650		
24	0.0239	1.0000	0.0276	1.1560	0.0240	1.0180	0.0250	1.0300	1.0500	0.0250	1.1480		
23	0.0269	1.1250	0.0306	1.2810	0.0270	1.1430	0.0281	1.1580	1.1810	0.0281	1.2860		
22	0.0299	1.2500	0.0336	1.4060	0.0300	1.2680	0.0312	1.2870	1.3120	0.0312	1.4240		
21	0.0329	1.3750	0.0366	1.5310	0.0330	1.3930	0.0343	1.4160	1.4430	0.0343	1.5620		
20	0.0359	1.5000	0.0396	1.6560	0.0360	1.5180	0.0375	1.5450	1.5750	0.0375	1.7000		
19	0.0418	1.7500	0.0456	1.9060	0.0420	1.7680	0.0437	1.8020	1.8370	0.0437	1.9750		
18	0.0478	2.0000	0.0516	2.1360	0.0480	2.0180	0.0500	2.0600	2.1000	0.0500	2.2970		
17	0.0538	2.2500	0.0575	2.4060	0.0540	2.2680	0.0562	2.3170	2.3620	0.0562	2.5720		
16	0.0598	2.5000	0.0635	2.6560	0.0600	2.5180	0.0625	2.5750	2.6250	0.0625	2.8480		
15	0.0673	2.8120	0.0710	2.9690	0.0680	2.8310	0.0703	2.8960	2.9530	0.0703	3.2160		
14	0.0747	3.1250	0.0785	3.2810	0.0750	3.1430	0.0781	3.2180	3.2810	0.0781	3.5830		
13	0.0897	3.7500	0.0934	3.9060	0.0900	3.7680	0.0937	3.8620	3.9370	0.0937	4.2720		
12	0.1046	4.3750	0.1084	4.5310	0.1050	4.3930	0.1093	4.5060	4.5930	0.1093	5.0070		
11	0.1196	5.0000	0.1233	5.1560	0.1200	5.0180	0.1250	5.1500	5.2500	0.1250	5.7420		
10	0.1345	5.6250	0.1382	5.7810	0.1350	5.6430	0.1406	5.7930	5.9060	0.1406	6.4310		
9	0.1494	6.2500	0.1532	6.4060			0.1562	6.4370	6.5620	0.1562	7.1660		
8	0.1644	6.8750	0.1681	7.0310			0.1718	7.0810	7.2180	0.1718	7.8550		
7	0.1793	7.5000					0.1875	7.5900	7.7520	0.1875	8.5900		



Manufactured Steel Since 1978

- All types of sheet, structural & specialty
- Bar & plank gratings
- Engineering & fabrication
- Powder coating, galvanizing & finishing

Call today

1-800-492-7304



METALS, INC. CORPORATE HEADQUARTERS, CLEVELAND, OHIO USA