



# Micro I Diagnostic Spirometer

## Operating Manual

Federal (USA) law restricts this device to sale by or on the order of a physician or licensed practitioner.

Micro Direct, Inc.  
803 Webster Street  
Lewiston, ME 04240  
1-800-588-3381  
[www.mdspiro.com](http://www.mdspiro.com)

122-14  
Issue 1.3  
June 2016

## CONTENTS

Introduction .....	1
Package Contents.....	2
Contraindications, Warnings and Cautions .....	3
Intended Use .....	4
Environment.....	4
Getting Started.....	5
Configuration .....	5
Micro I PC Software .....	6
Operation .....	10
Main Menu Overview.....	11
Quick Exam .....	12
Exam with Predicted Values.....	13
Post BD Exam.....	16
NLHEP Mode .....	16
NLHEP Quality Checks .....	17
NLHEP QC Grades .....	18
NLHEP Interpretation .....	19
Switching Off.....	19
Maintenance .....	19
Battery Management.....	19
Battery Replacement.....	20
Calibration Check.....	22
Cleaning Instructions .....	23
Cleaning the Transducer.....	24
Servicing .....	24
Product Lifetime .....	24
Troubleshooting Information .....	25
Safety Designation per IEC 60601-1 .....	25
Electromagnetic Compatibility (EMC) to EN610101-1:2007 .....	27
Symbols .....	32
Specifications of the Micro I .....	33
Accessories .....	34
Customer Contact Information .....	34



## Introduction

The Micro I is a compact, rechargeable battery operated and fully portable diagnostic spirometer. It is accurate to the requirements of the ATS/ERS TASK FORCE: STANDARDIZATION OF LUNG FUNCTION TESTING 2005. Its ergonomic and user-friendly design allows diagnostic spirometry measurements, including predicted values and automatic interpretation, to be made quickly and simply.

The Micro I features include:

- ✓ Measures FEV<sub>1</sub>, FVC(FEV<sub>6</sub>), FEV<sub>1</sub>/FVC, FEV<sub>1</sub>/FEV<sub>6</sub>, PEF, FEF<sub>25</sub>, FEF<sub>75</sub> and FEF<sub>25-75</sub>
- ✓ Fully configurable using software supplied
- ✓ ECCS, Asian, NHANES III or Quanjer-GLI (2012) predicted values
- ✓ Variation from norm as a percentage or Z-score
- ✓ NLHEP, NICE or the ATS/ERS interpretation
- ✓ Spirometry maneuver quality checks
- ✓ Post bronchodilator comparison
- ✓ NLHEP compliant mode
- ✓ Upload of the last patient tested for report generation either to be printed directly or saved as a PDF document and printed or stored in the patient's electronic medical records

The spirometer uses a digital volume transducer, an extremely stable form of volume transducer, which measures expired air directly at B.T.P.S. (Body Temperature and Pressure with Saturated water vapor) thus avoiding the inaccuracies of temperature corrections. This transducer is insensitive to the effects of condensation and temperature and avoids the need for individual calibration prior to performing a test.

Micro Direct can supply spirometers to fulfil all your diagnostic and monitoring spirometry needs.

## Package Contents

The Micro I is packaged in a convenient carrying case and comes complete with the following items:

- 1 Micro I Spirometer
- 2 Digital Volume Transducer
- 3 Universal power supply (PSU1017 5VDC 1.2A)
- 4 Mouthpiece adapter
- 5 USB/charging cable

Two disposable mouthpieces also included.



## Contraindications, Warnings and Cautions

**Contraindications:** As performing spirometry might be physically demanding, it is contraindicated in patients with recent myocardial infarction. Also extensive exhalation might lead to syncope.

The following terms are used as follows in this manual:

**Caution:** Possibility of injury or serious damage

**Warning:** Conditions or practices that could result in personal injury.

**Please Note:** Important information for avoiding damage to the instrument or facilitating operation of the instrument.

**Note:** The device should only be used by trained and qualified personnel.

	<b>CAUTION:</b> Read the manual before use
<b>WARNING:</b> The instrument is not suitable for use in the presence of explosive or flammable gases, flammable anesthetic mixtures or in oxygen rich environments.	
<b>WARNING:</b> With any other use as described in cleaning instructions, the Volume Transducer, Mouthpiece adapter and the pediatric adapter have to be cleaned between patients.	
<b>WARNING:</b> Use of portable phones or other radio frequency (RF) emitting equipment near the system may cause unexpected or adverse operation.	
<b>CAUTION:</b> Mouthpieces are single patient use. If used on more than one patient, there is a risk of cross-infection. Repeat use may degrade materials and lead to an incorrect measurement.	

CAUTION: Pulmonary filters are single patient use. If used on more than one patient, there is a risk of cross-infection. Repeat use may also increase air resistance and lead to an incorrect measurement.	
CAUTION: Do not allow the patient to handle the spirometer when connected to either the power supply for charging or to a PC when configuring the unit.	
WARNING: The user must not touch any voltage-carrying parts and the patient at the same time.	
	PLEASE NOTE: The product you have purchased should not be disposed of as unsorted waste. Please utilize your local recycling facility for the disposal of this product.
PLEASE NOTE: Degree of protection against Ingress of Water is IPX0.	

## Intended Use

The Micro 1 Spirometer is intended to measure the maximal volume and flow of air that can be moved out of a patient's lungs. The system is intended for use with pediatric and adult patients over the age of 3 years in hospitals, physician offices, laboratories and occupational testing environments.

## Environment

Please observe the following precautions:

- ✓ Avoid exposing the Micro I to direct sunlight.
- ✓ Avoid operating the spirometer in dusty conditions or near heating appliances or radiators.
- ✓ Do not keep the spirometer in a damp place or expose it to extreme temperatures.
- ✓ Do not direct the transducer holder towards a strong light source while operating the spirometer.

## Getting Started

It is recommended that the Micro I spirometer be fully charged before use. The power supply is provided with separate UK, USA and European plugs. Connect the required plug to the power supply and plug into an electrical outlet. Connect the Micro I to the power supply using the USB/charging cable and the charging symbol will appear on the screen.

**Fully charge for a minimum of five (5) hours when used for the first time.**

Remove the protective film from the display screen before use.

## Configuration

The configuration has already been completed at the factory. When the unit is first turned on, it may be configured for your region. This will set the language, height and weight units, date format and predicted values set appropriate for your region. It will also configure the indices to be displayed and whether a percentage predicted or Z-score is to be used to show variation from the norm. However, all of these settings may be customized using the PC software supplied.

Turn the unit on by pressing the on/off button located at the top of the device and the following will be displayed:



The screenshot shows a menu with a white background. At the top left, the time '10:54' is displayed. At the top right, there are four small black squares. Below this is a list of regions, each followed by a right-pointing chevron. The 'UK' option is highlighted with a black background and white text. Below the list, there is a small black horizontal line.

10:54	■■■■
UK	>
USA	>
USA (NLHEP)	>
France	>
Deutschland	>
España	>
Portugal	>
Netherland	>



Use the up and down arrow keys to highlight the required country and then press 'Enter' ( ↵ ). This procedure is only required when the unit is first switched on and the selection will be stored for future use.

It is recommended that the PC software be used to adjust these settings, if required. Connect Micro I to the PC using the USB cable supplied. Run the software and turn on the Micro I. The PC software will detect when the Micro I is connected. Follow the onscreen instructions to configure your unit.

## **Micro I PC Software**

This software allows you to customize the settings on your Micro I spirometer and allows full spirometry reports containing patient demographics, indices and flow volume and volume time graphs to be generated and saved as a PDF file or printed. Comprehensive help is available through the Help menu, once the PC software is successfully installed.

### **System Requirements**

Micro I PC Software requires certain hardware and software components in order to run properly.

#### **PC Requirements**

An IBM-compatible PC is required with hardware that meets or exceeds the following minimum requirements.

Processor: 800 MHz or above

RAM: 256 MB

Free Disk Space: 50 MB

Video: 800x600, 256 colors. It is recommended that a resolution of at least 1280x1024 be used to enable the full benefits of the multi-window interface.

At least one free USB port.

## **Operating System Requirements**

Micro I PC software will run on the following operating systems:

Windows XP 32 bit

Windows 7 32 bit

Windows 7 64 bit

## **Installing Micro I PC Software**

Before you begin, please ensure your computer meets the minimum system requirements and the user installing the software has administrative user rights.

Close any other applications that are running.

Insert the installation CD into your CD-Rom drive.

The setup program should launch automatically, displaying the welcome dialog box, click 'Next' to continue. If the setup program does not launch automatically use Windows Explorer to manually select the CD drive, then open the file named Micro I PC Software.exe.

The license agreement will be displayed. Please read the complete document and ensure you understand fully before accepting the terms of the license. Click 'Next' to continue.

The select destination location dialog box will be displayed showing the directory where the Micro I PC Software will be installed. The default location is:

C:\Program Files\CareFusion\Micro I PC Software

To change this location, select 'Browse'.

Click 'Next' to display the Select program manager group dialog box. This will be the location where the Micro I PC Software launch icon will be placed under the Start Menu. Either a new location can be entered or an existing location used.

Click 'Next' to display the installation option dialog box containing the following option:

Add Micro I PC Software icon to the desktop. Click 'Next' to start copying the files to your system.

Once the files have finished copying to your system, you will be advised that the Micro I PC Software has been successfully installed and it would be advisable to restart your PC before using the application. Click 'Finish' to complete the installation process.

## **Running Micro I PC Software**

Connect your Micro I to a USB port on the PC using the cable provided. The Micro I will take power from the USB port on the PC. Please be advised that the Micro I requires a high current USB port and if connected to a lower power USB port the device will turn itself off and fail to respond to any key presses until disconnected. Low power USB ports are commonly found on keyboards and unpowered USB hubs and should not be used. While connected to the PC, the Micro I will display:



**Do not allow the patient to handle the spirometer during this procedure.**

The Micro 1 PC software will automatically be launched when a Micro 1 unit is connected to the PC, the first screen will show:

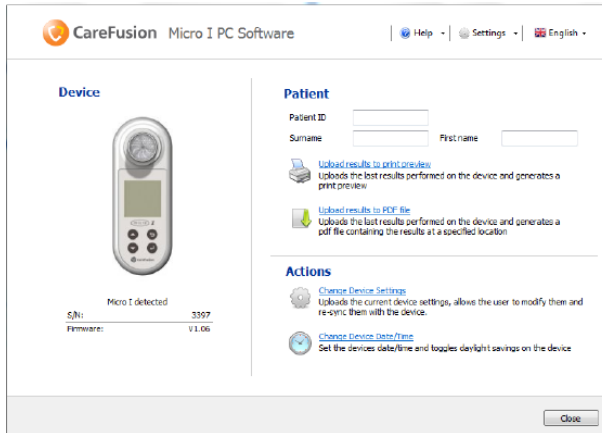

From this screen you can enter an ID and the patient's name to generate a report. The patient options allows the last results to be uploaded from the Micro 1 and print preview of the report can be view in preparation of printing or alternatively a PDF of the report can be generated for saving to a specified location.

Please note: The patient ID can contain a maximum of 20 characters.

Please note: If Quanjer-GLI (2012) predicted values are selected, the number of indices are limited to those of the published set, it is also not possible on the printed report to have a predicted area on the flow volume or volume time graphs if GLI-2012 predicted values have been chosen.

In the Actions section the user has the choice of two options either change the device settings or adjust the Micro 1 internal clock.

When the settings option is used, the display will change to:

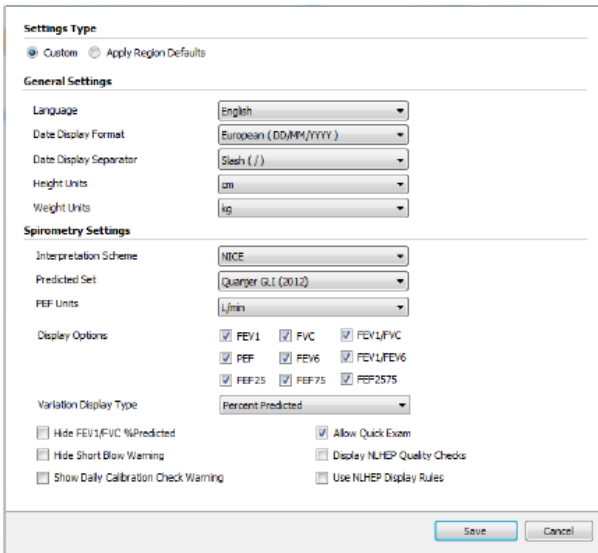

By selecting the 'Custom' option at the top of the screen, all of the Micro I features may be tailored to your specific requirements.

## Operation

The Micro I is designed to suit a range of applications from the very simplest spirometry test where only a few indices are required to be displayed to more complex operation where deviation from the norm, bronchodilator response and interpretation of results are required.

The main menu is displayed after the initial configuration and subsequently when the unit is turned on:

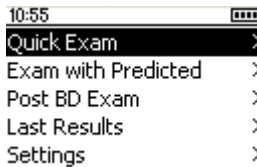

## **Main Menu Overview**

### **Quick Exam**

Use this function to take an immediate spirometry measurement with no predicted values or interpretation.

### **Exam with Predicted**

This function requires the entry of the patient's demographics so that predicted values and interpretation may be calculated and displayed.

### **Post BD Exam**

This function allows the post bronchodilator response to be measured. The response is measured with respect to the previously measured baseline obtained using either the Quick Exam or the Exam with Predicted options. The last recorded baseline examination is automatically stored when the unit is turned off and will be available for a post bronchodilator comparison when the unit is turned on.

### **Last Results**

This option is used to view the results of the last stored examination.

### **Settings**

This option allows the user to adjust various settings including date, time and language and to perform a calibration check.

## Quick Exam

After selecting this option, the display will change to:



The Micro I may be used with a SpiroSafe filter or a MicroCheck disposable cardboard mouthpiece with the adapter supplied. Insert mouthpiece or SpiroSafe filter into the mouthpiece holder of the spirometer.

Instruct the patient to inhale as deeply as possible, seal their lips around the mouthpiece and exhale as hard, as fast and as long as possible until no more air can be exhaled.

The spirometry results for that blow are then displayed together with the maneuver quality check based upon ATS/ERS guidelines:

14:50		000
<b>Current Blow Results</b>		
Base Blow1		%Pred
FEV1	3.85L	-
FVC	4.55L	-
FEV1/FVC	85%	-
PEF	524L/m	-

Good Blow

Further indices, if configured and the best results from a sequence of blows may be displayed by pressing the down key.

Each maneuver is quality checked for a slow start, abrupt end, short blow, poor effort or cough according to ATS/ERS 2005 guidelines.

Please note the percentage of predicted value and the interpretation is not available for the Quick Exam option.

Press 'Enter' ( ↵ ) to display:

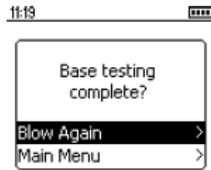

To repeat the test select 'Blow Again' and press 'Enter' ( ↵ ).

## Exam with Predicted Values

When this option is selected, the following is displayed:

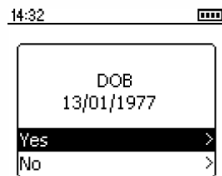

The date of the birth displayed will be the last patient tested (in the case of a new unit, the last test performed was a calibration test), select 'No' to enter the date of the birth of the patient to be tested or 'Yes' to confirm the date of birth is correct.

If 'No' is selected, the screen will change to allow the correct date of birth to be entered. Use the up and down keys to enter the date of birth and press 'Enter' ( ↵ ) key after each correct entry has been made.

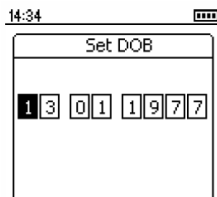

If 'Yes' is selected and the date of birth is correct, the patient details screen will be displayed.



**Enter Patient Details**

DOB 13/01/1977  
 Age 36  
 Gender **Male**  
 Height 175cm  
 Origin Caucasian

The up and down keys should also be used to adjust the patient's age and then press 'Enter' (↵). Repeat for gender, height (will be configured to accept height in inches) and racial origin. If a mistake is made, simply touch the 'Back' (⏪) key to go back to the previous entry.

The racial origin selected applies a percentage drop to the volumetric predicted values to be applied for the patient.

These ethnic corrections for ECCS are as follows:

Population	Percentage drop
Caucasian	0
Non-Specified	0
Polynesian	10
Asian	10
Afro Caribbean	13

Press 'Enter' (↵) when the required correction has been selected.

If NHANES III or Quanjer-GLIL (2012) predicted values are used, the ethnic origin will be used according to the authors' equations.

If a mistake is made then simple touch the back key to go back to the previous entry.

When all the patient data has been entered, the following screen will be displayed and a spirometry test may be performed:



After performing a test, the results are displayed:

14:51		ECCS	
<b>Current Blow Results</b>			
Base Blow1		%Pred	
FEV1	3.85L	106%	
FVC	4.55L	109%	
FEV1/FVC	85%	101%	
PEF	524L/m	113%	
Predicted:		ECCS	
Good Blow			

Each maneuver is quality checked for a slow start, abrupt end, short blow, poor effort or cough according to ATS/ERS 2005 guidelines. An asterisk (\*) at the end of the line denotes a result below the lower limit of normality.

If additional indices were chosen during configuration, press the down key to view these.

When a sequence of blows is recorded, the results and the quality check refer to the current blow but the interpretation is based upon the best result of the sequence.

Use the down arrow to see further indices, if configured, and the best results from a sequence of blows:

10:56		ECCS	
<b>Base Summary</b>			
Best Blow of 2		%Pred	
FEV1	4.15L	96%	
FVC	4.91L	97%	
FEV1/FVC	85%	102%	
PEF	566L/m	96%	
Predicted:		ECCS	

At any time when the results are displayed another spirometer test may be performed by touching the 'Enter' (↵) key. If the enter key is touched accidentally, simply press the back (⏪) key to return to the results screen.

The Micro I may be configured to display the Z score instead of the percentage of predicted values where data from the predicted value sets are available:

14:57		ECCS	
<b>Current Blow Results</b>			
Base Blow1		Zscr	
FEV1	3.85L	0.4	
FVC	4.55L	0.8	
FEV1/FVC	85%	0.1	
PEF	524L/m	1.1	
Predicted:		ECCS	
Good Blow			

The Z score is the number of standard deviations that the results are above (positive Z score) or below (negative Z score) the predicted value.

## Post BD Exam

Once satisfactory baseline tests have been recorded, a post bronchodilator examination may be performed by selecting the Post BD Exam option from the main menu. When these tests are performed, the percentage of predicted value is replaced by the percentage change from the best baseline result for each index:

14:58		ECCS	
<b>Current Blow Results</b>			
Post Blow1		%Chg	
FEV1	3.48L	-10%	
FVC	3.88L	-15%	
FEV1/FVC	90%	6%	
PEF	435L/m	-17%	
Predicted:		ECCS	
Possible Cough			

Using the down key will display the other indices and the best results as with the baseline blows.

## NLHEP Mode

This mode of operation is obtained by selecting the USA (NLHEP) option from the configuration menu when the unit is first turned on or subsequently from the settings option on the main menu.

In this mode the functionality of the Micro I becomes fully compliant with the National Lung Health Education Program requirements.

Only FEV<sub>1</sub>, FEV<sub>6</sub> and FEV<sub>1</sub>/FEV<sub>6</sub> are displayed and stored. Quality checks are applied to every maneuver and a quality grading score for the test session is displayed:

```

14:54 1000
Base Summary
Base Blow2      %Pred
FEV1           3.8L   103%
FEV6           4.6L   104%
FEV1/FEV6     85%    99%
Predicted:     NHANES III
NLHEP QC Grade A
                Good test session
    
```

## NLHEP Quality Checks

In order for the interpretation to be displayed, a maneuver must pass a set of enhanced quality checks. After the patient has performed a poor quality maneuver, one of the three following messages will appear:

Message	Criteria	Recommended action
Don't hesitate	Back-extrapolated volume (BEV) greater than 150 ml	The patient should blast out the air more quickly and evenly and without hesitation at the beginning of the maneuver
Blast out faster	Time until peak flow (PEFT) greater than 120 msec	The patient must exhale more explosively at the beginning of the maneuver
Blow out longer	Expiration time less than 6 seconds or volume accumulation has not dropped below 100 ml per 0.5 seconds	The patient stopped exhaling too early. The patient must exhale until their lungs are completely empty.

Once an acceptable maneuver has been performed, the following consistency checks will also be applied to subsequent maneuvers		
Blast out harder	Peak flow not reproducible. The best previous maneuvers do not match within 1.0 L/sec indicating that the patient is giving an inconsistent effort	The patient must give their maximum effort for each maneuver
Deeper breath	FEV1 or FEV6 not reproducible. Difference with respect to best test greater than 150 ml	The patient must inhale until their lungs are completely full before each maneuver

When two maneuvers fail either of the consistency checks, the best individual results of the two are saved (FEV1, FEV6 and PEF individually).

When any of the above messages appear, instruct the patient on how to improve their maneuver and demonstrate the correct maneuver yourself.

## NLHEP QC Grades

The quality of each session is graded according to the following criteria:

QC Grade	Criteria
A	At least two acceptable maneuvers, with the largest two FEV <sub>1</sub> 's matching better than 100 ml and the largest two FEV <sub>6</sub> 's matching better than 100 ml
B	At least two acceptable maneuvers, with the largest two FEV <sub>1</sub> 's matching better than 150 ml
C	At least two acceptable maneuvers, with the largest two FEV <sub>1</sub> 's matching between 200 ml and 150 ml

QC Grade	Criteria
D	Only one acceptable maneuver or two with the largest two FEV <sub>1</sub> 's matching less than 200 ml
F	No acceptable maneuvers

## NLHEP Interpretation

The interpretation is performed on the best spirometry results and is based upon the predicted values for the force expiratory ratio, FEV<sub>1</sub>/FEV<sub>6</sub>, and FEV<sub>1</sub>. If airways obstruction is detected, the level of severity is reported in accordance with the NLHEP guidelines.

## Switching Off

The unit is switched off by pressing the On/Off button.

The unit can be disconnected from the mains by unplugging the charger from the mains socket or unplugging the USB cable.

## Maintenance

### Battery Management

The Micro I is powered by a rechargeable battery pack.

The battery voltage is monitored and a warning is displayed on the screen when the battery starts to become exhausted.

### Battery Status Icons



Battery nearly exhausted. Recharge as soon as possible to avoid running out of charge.



Battery fully charged.

The battery is not required to hold the internal memory and stored results will be lost when the battery becomes exhausted.

To recharge the battery, connect the Micro I to the charger provided and then plug the charger into a suitable wall socket ensuring that access to the charger is not restricted so that it may easily be removed.

The Micro I will display:

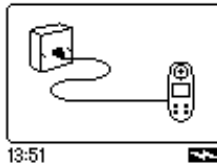

Do not allow the patient to handle the spirometer during this procedure.

The charging icon () will display to indicate that the device is charging.

Once the charging icon has switched off (up to five hours) it will be replaced by the battery fully charged icon (). Remove the power adapter from the wall socket and from the base of the unit. Micro I is now ready for portable use.

Note: Micro I may also be charged from a PC or laptop using the USB cable provided.

## Battery Replacement

The lifetime of all rechargeable batteries is limited and the battery pack will need to be replaced after a few years, depending upon usage. As the battery nears the end of its life, you will notice that fewer test can be be performed between charges.

For access to the battery, the rear of the device requires careful removal.

Clips are molded into the rear cover in the positions indicated and should be carefully pryed undone in the sequence shown.

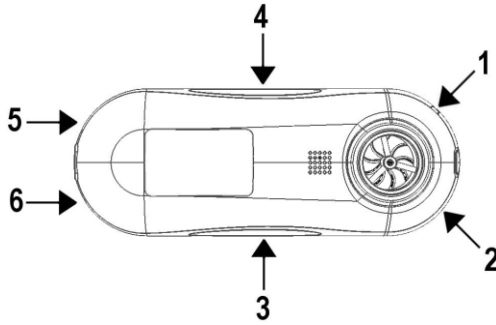

To aid this process, clip 1 has a recess molded into the device body to allow a small flat bladed screw driver to be carefully slid under the clip to release it.

Once released, work the screw driver around to clips 2, 3 and 4. Finally slide the cover off the bottom of the unit which in turn releases clips 5 and 6.

Replace the battery paying particular attention to the orientation of the connector in its socket and of the battery itself in the case. Note the leads coming from the battery should exit from the upper face of the pack when installed.

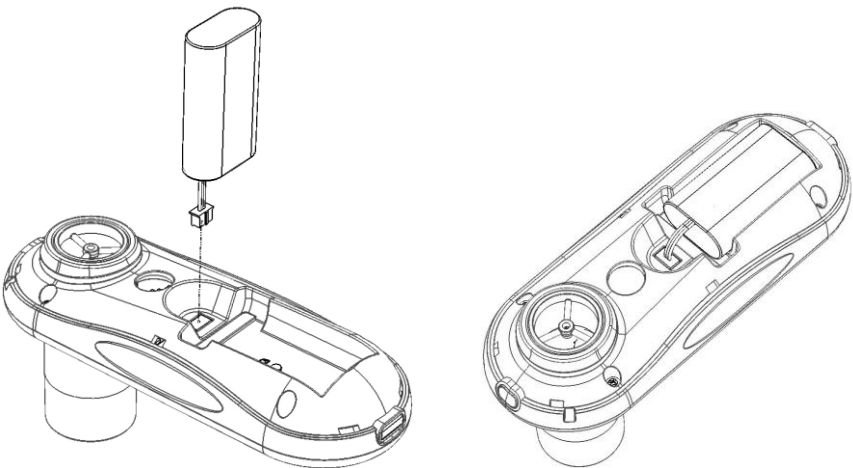



Replace the rear cover by attaching the securing clips in the reverse order.

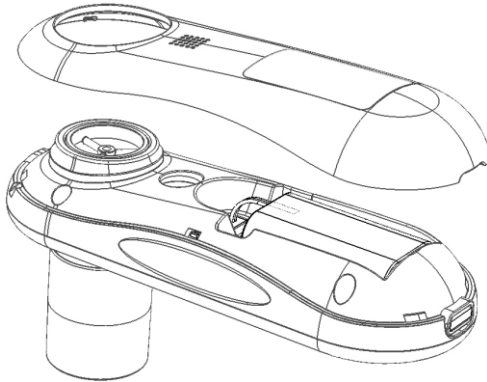

Dispose of the waste battery in line with your local waste management regulations.

### Calibration Check

The Micro I is calibrated to read in liters at body temperature, barometric pressure saturated with water vapor (BTPS).

The calibration should remain stable indefinitely, unless the transducer is physically damaged, and the unit should not require re-calibration. However, to ensure the correct functioning of the unit, we do recommend a calibration check is performed periodically.

To perform a calibration check, select the calibration check option from the setting menu and the display will show:

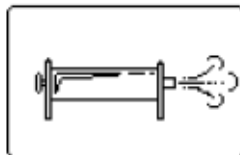

Connect a 3 liter syringe to the Micro I with the minimum of adapters and inject the syringe volume into the transducer evenly without pausing. When complete, the display will show:

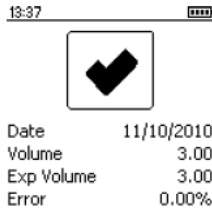

The acceptable calibration accuracy is +/- 3.5%. If the calibration accuracy is outside of this range, the check mark will be replaced by a cross. If this happens, check the syringe and the connections for leaks and repeat the check. If the Micro I is repeatedly outside the calibration range, the unit will have to be returned to Micro Direct for servicing.

## Cleaning Instructions

With the use of a SpiroSafe filter or MicroCheck one-way valve mouthpiece for each patient, cleaning for the components in the patients' gas path is recommended once a month.

When using a pediatric/adult disposable mouthpiece without a filter under the prerequisite that the patient was instructed only to exhale into the Micro 1 device, the following parts have to be cleaned once a day: volume transducer, mouthpiece adapter and pediatric adapter.

**WARNING:** With any other use as described in cleaning instructions, the volume transducer, mouthpiece adapter and pediatric adapter have to be cleaned between patients.

The cleaning of the transducer, mouthpiece adapter and pediatric adapter is equal for all the components in the patient gas path and is described in the below section "Cleaning the Transducer".

## Cleaning the Transducer

The transducer requires no routine maintenance or servicing.

To sterilize or clean the transducer, it may be removed by means of the following procedure:

1. Remove the transducer by gently rotating the transducer counter-clockwise and then pulling from the main body.
2. The transducer may now be immersed in warm soapy water for routine cleaning or immersed in cold sterilizing solutions for a period not exceeding 10 minutes. (Alcohol and chlorine solutions **MUST** be avoided) After cleaning/sterilizing, the transducer should be rinsed in distilled water and air dried.
3. Re-assemble the transducer into the Micro I.

**CAUTION:** Do not attempt to wash or immerse the Micro I or accessories in water or cleaning fluid, as there are electronic components inside that will be permanently damaged.

## Servicing

If your unit requires service or repair, please see page 34 for contact details.

There are no user serviceable parts in the Micro I.

## Product Lifetime

The Micro I meter is designed for a product lifetime of 5 years.

## Troubleshooting Information

Should you encounter problems operating your Micro I spirometer, please consult the table below:

<b>Problem</b>	<b>Possible Cause</b>	<b>Solution</b>
Micro I cannot be switch on	Batteries are flat	Recharge batteries
Every time you switch the instrument on, the time is shown as 00:00	The internal battery is defective	Contact Micro Direct
Micro I is outside of range when conducting the calibration check	There are leaks in the syringe or connection	Check the syringe and connections for leaks

## Safety Designation per IEC 60601-1

<b>Type of protection against electrical shock</b>	Class II
<b>Degree of protection against electrical shock</b>	Type B applied part
<b>Supply connection</b>	100-240 VAC, 50/60Hz
<b>Power Equipment</b>	Adapter and rechargeable internal NiMH battery
<b>Battery Life</b>	Approximately 30 hours with a fully charged new battery
<b>Degree of Electrical connection between equipment and patient</b>	Equipment designed as non-electrical connection to the patient
<b>Degree of mobility</b>	Transportable
<b>Mode of operation</b>	Continuous

**Note:** When you connect other equipment to the unit, always make sure that the whole combination complies with the international safety standard IEC 60601-1 for medical electrical systems. When connecting to a PC with the supplied USB lead then the PC must be EN 60601-1 / ANSI/AAMI ES60601-1:2005 compliant.

**IMPORTANT:** Only use the mains adapter supplied (PSU1017 5V DC 1.2A). The adapter contains a transformer. Do not cut off the adapter to replace it with another plug as this causes a hazardous situation.

- The adapter transforms the mains voltage (100-240 Volts) to a safe voltage (5V DC)
- Make sure the adapter does not get wet
- Do not use a damaged adapter
- Always unplug your Micro 1 before cleaning

**WARNING:** Do not connect devices that are not specified as part of the system.

**WARNING:** No modification of this equipment is allowed.

**NOTE:** If an MPSO (Multiple Portable Socket Outlet) is used with the system, the maximum permitted load should not be exceeded. Do not connect electrical equipment that has not been supplied as part of the system.

## Electromagnetic Compatibility (EMC) to EN60101-1:2007

**WARNING:** use of portable phones or other radio frequency (RF) emitting equipment near the system may cause unexpected or adverse operation

The Micro 1 has been tested to EN60601-1-2:2007 regarding its ability to operate in an environment containing other electrical/electronic equipment (including other medical devices).

The purposes of this testing is to ensure the Micro 1 is not likely to adversely affect the normal operation of other such equipment and that other such equipment is not likely to adversely affect the normal operation of the Micro 1.

Despite the testing of the Micro 1 that has been undertaken, normal operation of the Micro 1 can be affected by other electrical/electronic equipment and portable and mobile RF communications equipment.

As the Micro 1 is medical equipment, special precautions are needed regarding EMC (electromagnetic compatibility).

It is important that the Micro 1 is configured and installed/put into service, in accordance with the instructions/guidance provided herein and is used only in the configuration as supplied.

Changes of modifications to the Micro 1 may result in increased emissions or decreased immunity of the Micro 1 in relation to EMC performance.

The Micro 1 should be used only with the accessories (USB cables, mains adapter and turbine transducer) supplied (which are referenced in the accessories section of this manual). None of the Micro 1 cables should be extended in length by the user.

If any cables are extended by the user or non approved accessories are used, this may result in an increased level of emissions or decreased level of immunity, in relation to the Micro 1 EMC. None of the Micro 1 accessories should be used with other devices, as this may result in a n increased level of emissions or decreased level of immunity in relation to the other devices' EMC.

The Micro 1 has an essential performance – when verified with a 3 liter syringe the readings remain within a tolerance of +/- 3.5% and unit firmware must not cease operating. In the unlikely event of a Fast Transient / ESD event occurring, the device should be reset and located away from the source of interference.

**WARNING:** The Micro 1 should not be used adjacent to or stacked with other equipment. If adjacent or stacked use with other equipment is necessary, the Micro 1 and the other equipment should be observed/monitored, to verify normal operation in the configuration in which it will be used.

Guidance and Manufacturer's Declaration – Electromagnetic Emissions			
The Micro 1 is intended for use in the electromagnetic environment specified below. The customer or the user of the Micro 1 should assure that it is used in such an environment			
Emission Test	Compliance	Electromagnetic Environment - Guidance	
RF emissions CISPR 11	Group 1	The Micro 1 uses RF energy only for its internal function. Therefore, its RF emissions are very low and are not likely to cause any interference in nearby electronic equipment	
RF emissions CISPR 11	Group [B]	The Micro 1 is suitable for use in all establishments, including domestic establishments and those directly connected to the public low-voltage power supply network that supplies buildings used for domestic purposes	
Harmonic emissions IEC61000-3-2	[Not Applicable]		
Voltage fluctuations / flicker emissions IEC61000-3-3	[Not Applicable]		
Guidance and Manufacturer's Declaration – Electromagnetic Immunity			
The Micro 1 is intended for use in the electromagnetic environment specified below. The customer or the user of the Micro 1 should assure that it is used in such an environment.			
Immunity Test	IEC 60601 Test Level	Compliance Level	Electromagnetic Environment - Guidance

Electrostatic discharge (ESD) IEC61000-4-2	+/- 6 kV contact +/- 8 kV air	+/- 6 kV contact +/- 8 kV air	Floors should be wood, concrete or ceramic tile. If floors are covered with synthetic material, the relative humidity should be at least 30%
Electrical fast transient / burst IEC61000-4-4	+/- 2 kV for power supply lines  +/- 1 kV for input / output lines	+/- 2 kV for power supply lines  [Not Applicable]	Mains power quality should be that of a typical commercial or hospital environment
Surge IEC61000-4-5	+/- 1 kV line(s) to line(s) +/- 2 kV line(s) to earth	+/- 1 kV line(s) to line(s)  [Not Applicable]	Mains power quality should be that of a typical commercial or hospital environment
Voltage dips, short interruptions and voltage variations on power supply input lines IEC61000-4-11	< 5% $U_T$ (> 95% dip in $U_T$ ) For 0.5 cycle  40% $U_T$ (60% dip in $U_T$ ) for 5 cycles  70% $U_T$ (30% dip in $U_T$ ) for 25 cycles  <5% $U_T$ (> 95% dip in $U_T$ ) for 5 s	< 5% $U_T$ (> 95% dip in $U_T$ ) For 0.5 cycle  40% $U_T$ (60% dip in $U_T$ ) for 5 cycles  70% $U_T$ (30% dip in $U_T$ ) for 25 cycles  <5% $U_T$ (> 95% dip in $U_T$ ) for 5 s	Mains power quality should be that of a typical commercial or hospital environment. If the user of the Micro 1 requires continued operation during power mains interruptions, it is recommended that the Micro 1 be powered from an uninterruptible power supply or a battery
Power frequency (50/60 Hz) Magnetic field IEC61000-4-8	3 A / m	3 A / m	Power frequency magnetic fields should be at levels characteristics of a typical location in a typical commercial or hospital environment.
NOTE $U_T$ is the a.c. mains voltage prior to application of the test level.			



**Guidance and Manufacturer's Declaration – Electromagnetic Immunity**

The Micro 1 is intended for use in the electromagnetic environment specified below. The customer or the user of the Micro 1 should assure that it is used in such an environment.

Immunity Test	IEC 60601 Test Level	Compliance Level	Electromagnetic Environment - Guidance
Conducted RF IEC61000-4-6	3 Vrms 150 kHz to 80 MHz	3 V	<p>Portable and mobile RF communications equipment should be used no closer to any part of the Micro 1, including cables, than the recommended separation distance calculated from the equation applicable to the frequency of the transmitter.</p> <p><b>Recommended separation distance (d)</b></p> $d = 1.2\sqrt{P}$
Radiated RF IEC61000-4-3	3 V/m 80 Mhz to 2.5 Ghz	3 V/m	$d = 1.2\sqrt{P} \quad 80 \text{ MHz to } 800 \text{ MHz}$ $d = 2.3\sqrt{P} \quad 800 \text{ MHz to } 2.5 \text{ GHz}$ <p>Where P is the maximum output power rating of the transmitter in watts (W) according to the transmitter manufacturer and <b>d</b> is the recommended separation distance in meters (m).</p> <p>Fields strengths from fixed RF transmitters, as determined by an electromagnetic site survey, <sup>a</sup> should be less than the compliance level in each frequency range. <sup>b</sup></p> <p>Interference may occur in the vicinity of equipment marked with the following symbol:</p> 

NOTE 1 At 80 MHz and 800 MHz, the higher frequency range applies.

NOTE 2 These guidelines may not apply in all situations. Electromagnetic propagation is affected by absorption and reflection from structures, objects and people.

<sup>a</sup> Field strengths from fixed transmitters, such as base stations for radio (cellular / cordless) telephones and land mobile radios, amateur radios, AM and FM radio broadcast and TV broadcast cannot be predicted theoretically with accuracy. To assess the electromagnetic environment due to fixed RF transmitters, an electromagnetic site survey should be considered. If the measured field strength in the location in which the Micro 1 is used exceeds the applicable RF compliance level above, the Micro 1 should be observed to verify normal operation. If abnormal performance is observed, additional measures may be necessary, such as re-orientating or relocating the Micro 1

<sup>b</sup> Over the frequency range 150 kHz to 80 MHz, field strengths should be less than 3 V / m

**Recommended separation distances between portable and mobile RF communications equipment and the Micro 1**

The Micro 1 is intended for use in an electromagnetic environment in which radiated RF disturbances are controlled. The customer or the user of the Micro 1 can help prevent electromagnetic interference by maintaining a minimum distance between portable and mobile RF communications equipment (transmitters) and the Micro 1 as recommended below, according to the maximum output power of the communications equipment.

Rated Maximum Output Power of Transmitter in Watts (W)	Separation Distance in Meters (m) according to Frequency of Transmitter		
	150 KHz to 80 MHz	80 MHz to 800 MHz	800 MHz to 2.5 GHz
	$d = 1.2 \sqrt{P}$	$d = 1.2 \sqrt{P}$	$d = 2.3 \sqrt{P}$
0.01	0.12	0.12	0.23
0.1	0.38	0.38	0.73
1	1.2	1.2	2.3
10	3.8	3.8	7.3
100	12	12	23.3

For transmitters rated at a maximum output power not listed above, the recommended separation distance d in meters (m) can be estimated using the equipment applicable to the frequency of the transmitter, where P is the maximum output power rating of the transmitter in watts (W) according to the transmitter manufacturer.

NOTE 1 At 80 MHz and 800 MHz, the separation distance for the higher frequency range applies.

NOTE 2 These guidelines may not apply in all situations. Electromagnetic propagation is affected by absorption and reflection from structures objects and people.

## Symbols



Type B device



0086

In accordance with Directive 93/42/EEC



Disposal in compliance with your local waste management facility



Consult the instructions for use



Manufacturer



Date of Manufacture



Serial Number

Rx only

Federal U.S. law restricts this device to sale by or on the order of a physician (Rx only)

## Specifications of the Micro I

### Measurements:

Forced Expiratory Volume in 1 second (FEV<sub>1</sub>)

Forced Expiratory Volume in 6 seconds (FEV<sub>6</sub>)

Forced Vital Capacity (FVC)

Forced Expiratory Ratio (FEV<sub>1</sub>/FEV<sub>6</sub>)

Forced Expiratory Ratio (FEV<sub>1</sub>/FVC)

Peak Expiratory Flow Rate (PEF)

Mid Expiratory Flow (FEF<sub>25-75</sub>)

Expiratory Flow at 75% of volume remaining (FEF<sub>75</sub>)

Expiratory Flow at 25% of volume remaining (FEF<sub>25</sub>)

Display: 128 x 128 pixel graphic backlit  
monochrome LCD

Transducer type: Uni-directional digital volume

Accuracy: To the requirements of the ATS/ERS  
Task Force: Standardization of Lung  
Function Testing 2005 (Eur Respir J  
2005; 26:319-338 Table 6)

Power supply: 2 x AA size NiMH rechargeable cells

Battery life: Approximately 30 hours with a fully  
charged new battery

Operating current: Less than 90mA

Charging current: Less than 500mA

Dimensions: 6.4" x 2.4" x 1.2"

Weight: 5.4 ounces

Life time: 5 years

Operating temperature: 50 to +95° F

Operating humidity: 20% to 80% RH

Operating pressure: 650 to 1060 hPa

Storage temperature: -4 to +158° F

Storage humidity: 30% to 90% RH

Storage pressure: 650 to 1060 hPa

## Accessories

Catalog #	Description
3314SB	Adult Mouthpieces (Box of 200)
3314B5	Adult Mouthpieces (Box of 500)
3395	MicroCheck, one-way mouthpieces (Box of 200)
3385	SpiroSafe, Viral/Bacterial Filter (Box of 100)
3301	Pediatric Mouthpieces (Bag of 100)
PSA1100	Pediatric Adapter
3304	Nose Clips (Pack of 20)
3325	3-Liter Calibration Syringe
MLD1621	Mouthpiece Adapter
BAT1043	Battery Pack (NiMH AA 2.4V, 1600 mAh)
PSU1017	5V DC 1.2A (GlobTek WR9QA1200USBNR-G2267)
48-70	Protex Disinfectant Wipe (100/canister)

## Customer Contact Information

For all sales order processing for products, training and spare parts, service and technical support inquiries, please contact the following:

Micro Direct, Inc.  
803 Webster Street  
Lewiston, ME 04240

Telephone: 207-786-7808

Toll Free: 800-588-3381

Fax: 207-786-7280

Website: [www.mdspiro.com](http://www.mdspiro.com)

Sales Email: [sales@mdspiro.com](mailto:sales@mdspiro.com)

Service Email: [support@mdspiro.com](mailto:support@mdspiro.com)