

Micro plasma welding

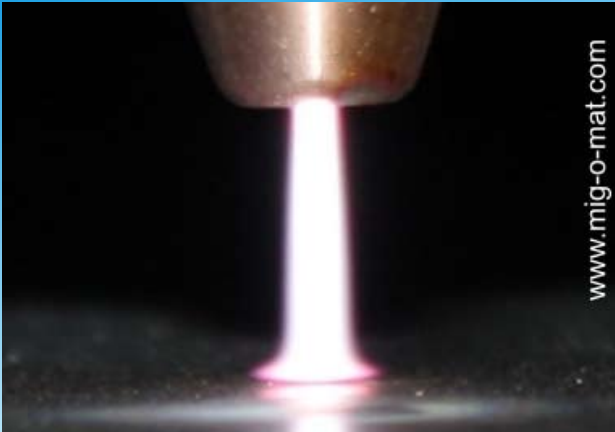

*Micro plasma arc (welding current 0,5A)
with typical column of the arc*



*Circular welding of
compensators
(material thickness 0,15mm)*

Micro plasma welding

- » Welding currents from 0.1A
- » Welding of foils, sieves, thin-walled components <0,5mm
- » manual and automatic welding
- » Repairing of tools (surfacing ion edges)
- » Welding of membranes and bellows (compensators)



*Micro plasma welding
of pressure cells*



*Circular welding system for micro
plasma welding with plasmaJET100SPS*



*Micro plasma welding torch
PJB100superior*



*Micro plasma weldings (f.l.):
membran, glow plug,
magnetic valve, relay*

Plasma short time welding



Welding of Omega-lock at stamping parts for automotive industry

The requirements on crash resistance of automotive components have also increased. In the past, it was usually enough to secure a simple stamped part with an Omega lock. Today a higher standard is applied, and a weld point is demanded as additional safety (e.g. in case of headrests). Here, these parts are mostly coming directly from a press, and are then (mostly very oily) provided with a safety weld point in a subsequent installation.



Glow plugs for diesel-cars

Plasma short time welding

- » Welding times from 0,02 seconds
- » Advantages of plasma in comparison to TIG welding process:
 - Live time of electrode up to 30x longer
 - Less sensitive to impurities at the welded component
 - No interference from HF-ignition
- » Extremely high process safety and quality



Relay manufacturing: welding of copper wire to the connecting socket

Short-time welding (welding time 20ms to 2 seconds) is a strongly increasing area with a host of applications coming from the automotive sector, and in the production of electronic components. Most of all the downsizing of engines and the use of turbochargers resulting from this present challenges to quality and productivity of the procedure. Thus, in comparison with the previously often used TIG welding process, with short-time plasma welding a 30-fold longer duration of wear parts and of considerably higher quality can be achieved.



Parts for turbo chargers in automotive industry

Plasma Keyhole Welding



- » Stainless steel container for industrial fields e.g. chemistry, pharmacy, food, beverages, etc.
- » Tube production (Longitudinal- and Circular seam)
- » Construction of apparatus and plants
- » Stainless steel processing industry
- » Vessel bottom production

Solutions for automated Plasma Keyhole Welding

Automation solutions for plasma keyhole welding will help to increase your productivity significantly.

Scope of plasma welding

The plasma keyhole welding is applied in case of a sheet thickness of 2 to 10mm. Typical applications are the longitudinal and circumferential one pass butt welding processes in case of thick-walled pipes, containers and bottoms. The advantages of the process are distinguished by high productivity and quality.



Plasma Keyhole welding system for plane sheets up to 7 m with max. 15 mm thickness.

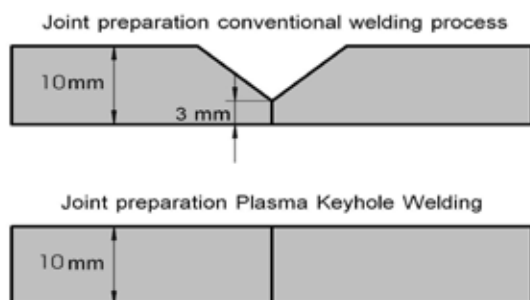

- » Welding of medium-sized sheet thickness of 2-10mm without edge preparation.
- » Root layer welding in case of higher sheet thickness
- » Stainless steel, mild steel, titanium, Duplex-steel
- » Cost saving per meter of weld seam up to 80% in comparison with other methods.
- » high productivity and process reliability

Contrary to other welding processes the plasma keyhole welding is characterised by a low heat input, an outstanding quality and a very low wear- and additional costs (e.g. auxiliary material).

Plasma Keyhole Welding

SIEMENS SIMATIC MULTI PANEL

TOUCH

STOP!		www.mig-o-mat.com	
-3A	welding current	350 A	+5A
-7cm/min	coldwire	175 cm/min	+10cm/min
-0,1l/min	plasmagas	7,5 ltr/min	+0,2 /min
-1cm/min	welding speed	35 cm/min	+1cm/min
-0,1V	welding voltage (must)	29,2 V	+0,2V
	welding voltage (actual)	29,2 V	
ready		go main position	
coldwire forward	test gas on	oscillation on	avc on
			pilot on plasma
column & boom	roller & plano	settings	welding-parameter
			oscillator

The assigned camera system with adjustable brightness serves for the arc observation and for the weld guiding. With a second camera the capping pass can be controlled from the control desk.



Image: welding head with motorized slide for AVC and linear oscillation, 2 camera systems and the welding torch PJB350

With the plasma keyhole technology it depends special apart from the experience particularly on an interaction of the assigned devices, a simple operation and on components co-ordinated for the procedure.

For this MIG·O·MAT offers a control concept which can be served simply. The entire machine is controlled via a central 10" Touchpanel.

The torch is in addition of crucial importance, there to these high requirements to be placed concerning service life and welding quality. Here MIG·O·MAT uses the PJB350, which apart from extremely long service lives an outstanding welding result. Due to the construction of the torch it gets along with only a few wear parts.



Plasma keyhole welding unit
plasmaJET350SPS-K

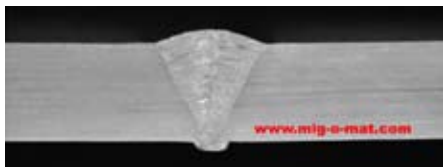

MIG·O·MAT offers turnkey solutions starting from planning, realization, welding support activities up to service and maintenance.

Plasma Keyhole Welding



Transverse seam welder for production of tanks in vertical position

Flexible pipe- and tank welding system with sector-control for circumferential welding of tubes with small diameter.



Individual solutions to automate the container production

In practis, different production methods are established, depending of the customer requirements. Here usually production in vertical position, production in horizontal position or on seamers will be used. Each production method has its advantages and disadvantages. We will advise you in the selection of your individual automation solution.



Circumferential welding at tanks with diameter 5.000mm

Vertikal-Down with seamer for pre-production of tanks in vertical position

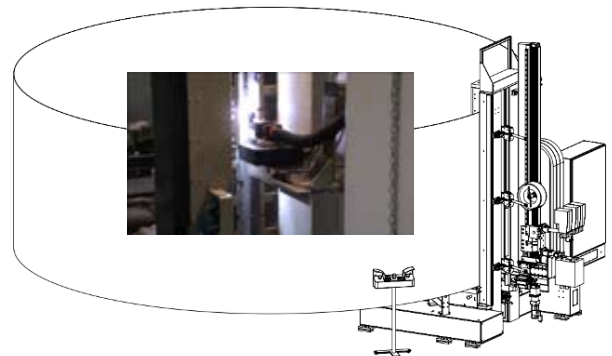

Plasma-arc powder surfacing



Powder-feeder and Plasma powder welding torch 350A

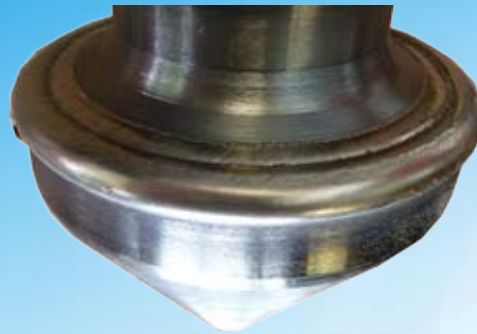

Anti-wear surfacing at tools



Plasma-arc powder surfacing of valves

Plasma-arc powder surfacing

- » Surfacing for anti-wear protection and corrosion resistance
- » Repair-welding of tools
- » Low dilution with base material (<5% possible)
- » Low rework
- » Even and well adjustable layer thickness by separating the supply of energy and filler material
- » Areas of application: Manufacturing of fittings, power plant construction, refineries, knife coating, extruder manufacturing, mining industry, coating of cylinders and screw conveyors, coating of valves of small and large engines



Anti-wear surfacing at steel shaft



Combined Circumferential- and Longitudinal welding system for: TIG-, Plasma-, Plasma keyhole- and Plasma-arc powder surfacing.



Metallographik sample plasma-arc powder surfacing

plasmaJET100SPS · plasmaJET250SPS



- » Automated welding of longitudinal, circumferential and special weld seams
- » Use in automatic and robot welding systems
- » Plasma spot welding
- » Use in fully automated factories
- » Automated short-term welding e.g. in lamp-, glow plug- and turbo charger production
- » individual adaptation to the welding task

Solutions for automated Microplasma- and Plasma Welding

MIG·O·MAT *plasmaJET100SPS/250SPS*

The MIG·O·MAT plasmaJET100SPS and MIG·O·MAT plasmaJET250SPS are specially designed for automatic and robot welding systems. Equipped with a modular based Siemens SPC control device the plasmaJET units offer an easy operation and a high degree of process safety and flexibility, so that huge number of special customer requirements and adaptations can be realized. The integrated high-performance cooling system with monitoring of the coolant flow-rate with is designed for the high demands of the plasma welding process and in particular the plasma welding torch.

The MIG·O·MAT plasmaJET100SPS is especially designed to meet the high demands of the microplasma welding process, where even lowest welding current, a precise adjustability and regulation and an excellent reaction of the plasma-arc are of vital importance.

The universell designed welding program flow provides a huge number of adaptations on different welding applications by the modes of operation e.g. 2-cycle/4-cycle, timing control, plasma spot welding and control voltage*.

The operation is made by a robust touchdisplay with graphic indication of welding flow and is very easy in handling.

For a simple handling, the display can be demounted from the welding unit and it can be integrated into the customers control desk*.

	<i>plasmaJET 100SPS</i>	<i>plasmaJET 250SPS</i>
Mains voltage	1x230V 50/60Hz	3x400V 50/60Hz
Mains fuse	16A träge	16A träge
Welding current	0,1 - 100,0A	3 - 250A
Duty cycle	100A / 100%	250A / 60% 200A / 100%
Pilot current	3 - 15A	3-15A
No-load voltage	85V	85V
Dimensions WxHxD [mm]	455x980x620	455x980x620
Weight	85kg	90kg
Colour	RAL2002	RAL2002

plasmaJET100SPS · plasmaJET250SPS

Features / Technical Equipment

- » Microplasma welding from 0,1 A (MIG·O·MAT plasmaJET 100SPS)
- » 6" colour touch display
- » Integrated high-performance cooling for plasma torch
- » Excellent burning behavior of pilot- and main welding arc due to inverter technology
- » Monitoring of the coolant flow-rate for protection of the plasma welding torch
- » Built-in flowmeter for the precise setting of plasma and shielding gas
- » Modes of operation 2-cycle / 4-cycle / timing control / plasma spot welding / control voltage*
- » Storage of all welding parameters in 60 welding programs
- » Test sequence for the welding program
- » Indication of fault messages in plain text
- » Graphic indication of welding flow
- » Pulsed-mode operation with variable frequency width and basic current up to 500 Hz
- » Modular control system (Siemens S7-1200) with softwarebased program control
- » Simple controlling by touchpanel
- » Software-based adjustment to any welding task
- » Control receptacle according to industrial standard
- » Mobile, swivel rollers with brake
- » Central connection for the welding torch
- » Language German and English (switchable)

Controlling by touchpanel

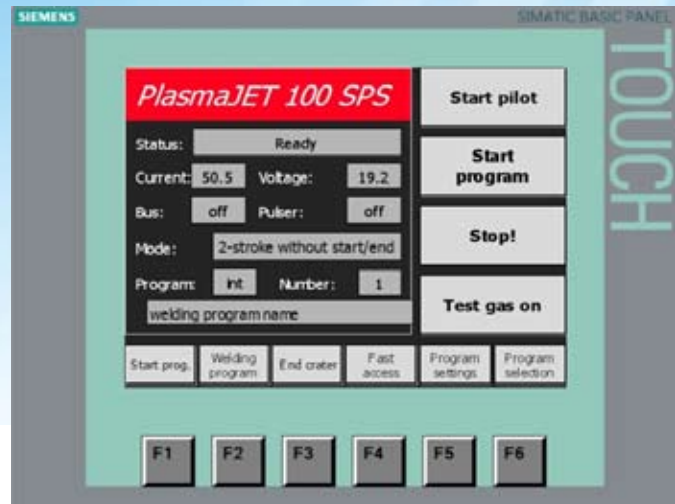

Central image with soft-buttons and status indicator

Item number	Designation
Z.PJ100SPS.009	MIG·O·MAT plasmaJET100SPS
Z.PJ250SPS.009	MIG·O·MAT plasmaJET250SPS
C01.000.009	Workpiece line cpl. 4 m
G10.000.003	Welding regulator for Argon gas for 200 bar bottles
G10.000.002	Welding regulator for Argon/Hydrogene gas for 200 bar bottles
C03.000.002	Gas line 4m for Argon (black)
C03.000.001	Gas line 4m for Argon/Hydrogene (red)
C00.000.012	Foot pedal remote control
C08.400.090	Coolant MCF 15, 5 liter

Connecting plan Control plug X2 plasmaJET 100SPS/250SPS

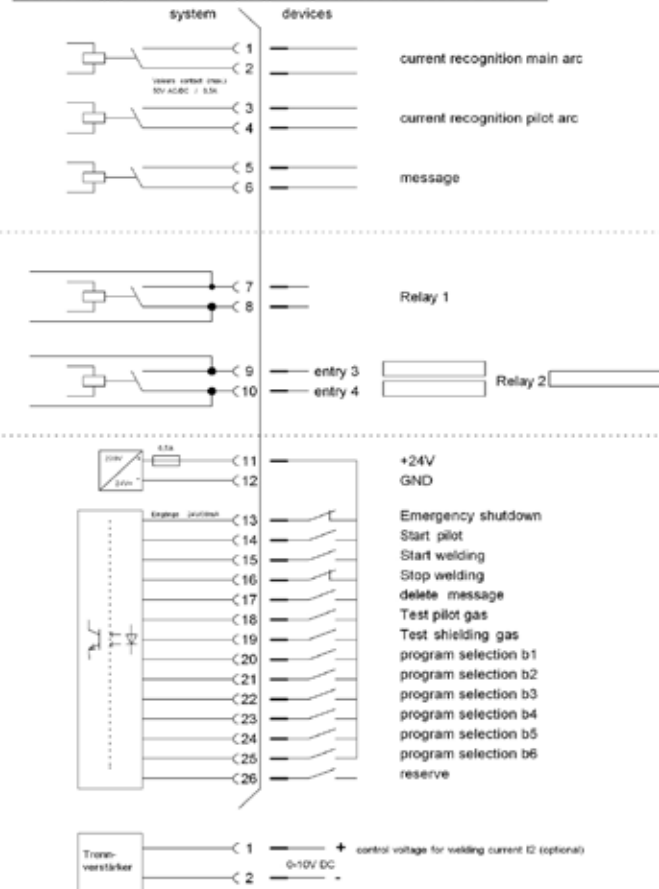

plasmaJET100SPS · plasmaJET250SPS

Extensions / Options

Based on the modular design of plasmaJET welding units and the used control concept the welding unit series MIG-O-MAT plasmaJET100SPS and MIG-O-MAT plasmaJET250SPS can be extended easily to meet the specific requirements of its customers welding applications. The following options are only a sample of recommended extensions. For further options, please feel free to contact us.

Options

Plasmagas control 0,05 – 2,00 liter/min **

Precise control and monitoring of plasma gas with thermal mass stream flow controller. The different nominal values for plasmagas are adjustable via display

Shieldinggas control 0,5 – 20,0 liter/min **

Precise control and monitoring of shielding gas with thermal mass stream flow controller. The nominal value is adjustable via display.

Control voltage for welding current

Control of welding current I2 via control voltage 0 – 10 V or 0-20mA / 4-20mA.
With internal galvanic isolation.

Link with superset process control via Profibus or Profinet

Exchange of welding parameter e.g. welding current and time and control of the welding unit by a superset process control (Master) via Profibus or Profinet

Program: Plasma short-term welding from 20ms

Special plasma short-term welding program for welding times from 0.02 seconds

Connection for secondary cooling circuit

(only plasmaJET100SPS, standard for plasmaJET250SPS)

Connection for external cooling devices or plant cooling systems, which are mostly not suitable to the requirements of plasma welding. With this a longer life of the torch consumables and greater process reliability can be achieved. The integrated cooling circuit remains.

Distance-based control (WPSS), circumferential-welding control system

Welding program with 10 currents and slopes, control via connection of an incremental transmitter (only combined with Option „Touchpanel“)

Option Language

Display on Touchpanel in national language

Option Touchpanel “Comfort”

Coloured 6" Touchpanel, Data-storage of welding parameters on USB stick with export to Microsoft Excel, data storage with receipt management, administration of user accounts

Option Jobselection

Controlling by jobselection. A „Job“ consists of „Currentslope, welding current and a plasma gas value*, which can be chosen by the binary coding from the control plug X2. It's possible, to store up to 60 jobs.

Option high-precision cold wire system with stepper motor

Cold wire system for plasmaJET100SPS and plasmaJET250SPS. The controlling is done via the SPC controller from the plasmaJET. High-precision feeding of the cold wire with stepper motor (resolution 0,05mm). Precise feeding, especially for micro plasma systems to avoid the delay time at the start.

... and much more

pulsation of welding current up to 20kHz, plasma soldering with non-transferred arc, silent cooling system for labs, glare protection for touch panel, protective film for touch panel, straight top of plasmaJET housing, without wheels for fixed applications, remote display for mounting into customers control desk.

Controlling via Profibus or Profinet



plasmaJET100SPS-LuR developed for aerospace industrie



Mikroplasma welding unit, specially designed for aerospace applications, according to DIN65153. Shown here with straight top and glare protection.

Precision cold wire system with stepper motor



** On the basis of technical limitations not all options can be combined.*

*** Other control- and monitoring ranges on request*

plasmaJET100SPS · plasmaJET-

Exposition of a welding program

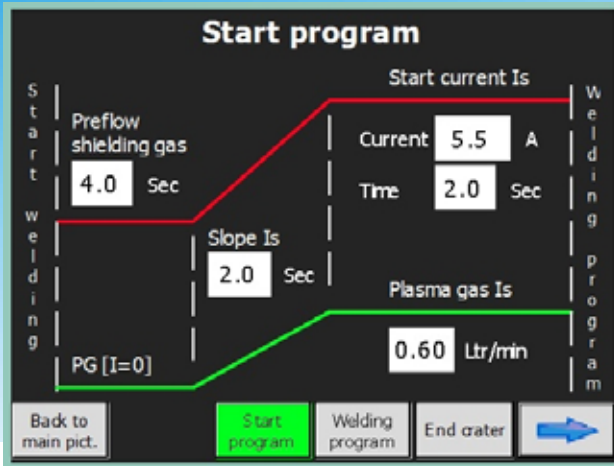

Example: 2-stroke with start- and endcrater program, consists of start program, welding program and endcrater filling program, including the optional plasma gas

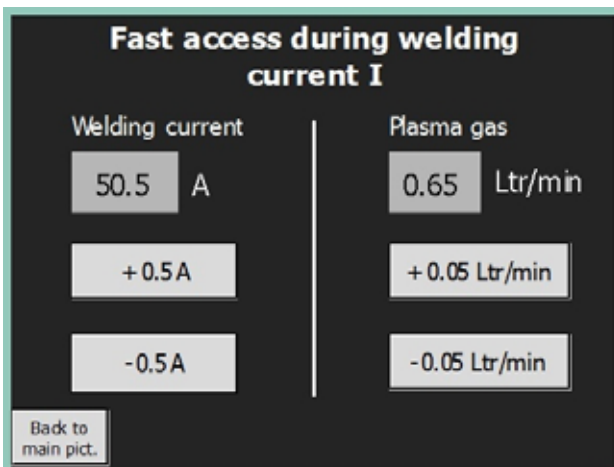
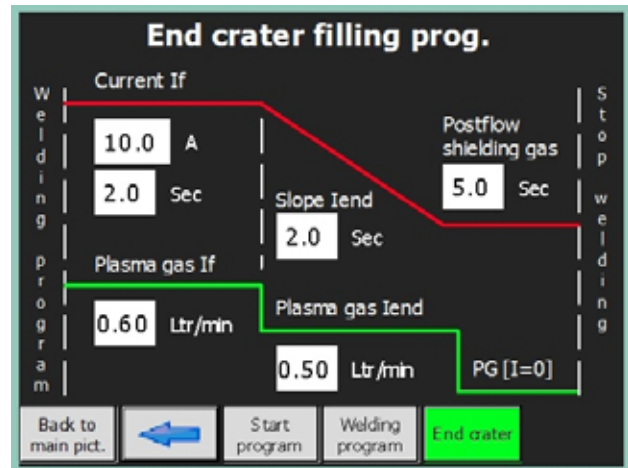
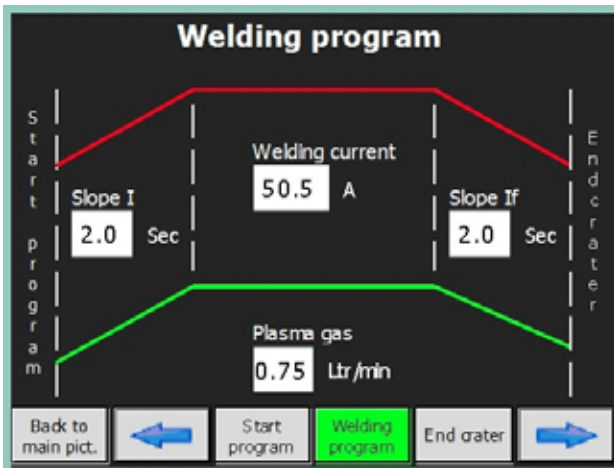

Left side: Fast excess of welding parameters during welding

plasmaJET50 · plasmaJET100



- » Manual welding (hand welding)
- » Microplasma welding of thin materials e.g. foils
- » Plasma spot welding
- » Partly mechanized welding jobs (circumferential seam and longitudinal seam)
- » Welding of metal mesh, thermo-couples, sieves, filter
- » Repair welding of tools
- » Plasma brazing of zinc-plated metal sheets

Solutions for manual and partly mechanized Microplasma and Plasma Welding

MIG·O·MAT *plasmaJET50/100*

The MIG·O·MAT-appliances plasmaJET 50 and plasmaJET 100 are especially designed for microplasma welding. The MIG·O·MAT plasmaJET 50 has a maximum current of 50 A in case of a duty cycle of 100 %. The unit is equipped with an easy, well-arranged micro control device especially suitable for the requirements of a manual welding process. This control device allows the functions welding in 2-cycles and 4-cycles, plasma spot welding, infinitely variable pre-selection of the main and pilot-arc current as well as a pulse-mode operation with adjustable parameters. The control device is equipped with a digital display of the welding current and the pilot-arc current and is prepared for the utilization of a foot control pedal and plasma spot welding control device.

The MIG·O·MAT plasmaJET 100 is dimensioned for a duty cycle of 100 % at 100 amps. Its control system corresponds to the system of the MIG·O·MAT plasmaJET 50. With that the unit provides a wide range of capacity for plasma welding applications and excellent features for microplasma welding.

	<i>plasmaJET50</i>	<i>plasmaJET100</i>
Mains voltage	1x230V 50/60Hz	1x230V 50/60Hz
Mains fuse	16A träge	16A träge
Welding current Microplasma Plasma	0,5 - 25 A 2 - 50 A	0,5 - 25 A 2 - 100 A
Duty cycle	50A / 100%	50A / 100%
Pilot current	3 - 10A	3-10A
No-load voltage	85V	85V
Dimensions WxHxD [mm]	455x980x620	455x980x620
Weight	85kg	85kg
Colour	RAL2002	RAL2002

plasmaJET50 · plasmaJET100

Features / Technical Equipment

“Top 10” of MIG·O·MAT plasmaJET

- » Microplasma welding from 0,5 A
- » Excellent burning behavior of pilot and main welding arc due to inverter technology
- » Integrated high-performance cooling for plasma torch
- » Monitoring of the coolant flow-rate for protection of the plasma welding torch
- » Built-in flowmeter for the precise setting of plasma and shielding gas
- » Modes of operation 2-cycle / 4-cycle / pedal remote control
- » Plasma spot welding combined with a plasma spot welding control device
- » Variable pulsed-mode operation for main current and basic current up to 50 Hz
- » Control interface according to industrial standard
- » Central connection for the plasma welding torch

Clearly arranged user interface for precise and easy adjustment of the welding parameters:

	<i>plasmaJET50 / plasmaJET100</i>	
Menu item	Limit value	Resolution
Pilot current	3 - 10 A	3 - 10 A
Welding current Microplasma	0,5 - 25,0A	0,1 A
Welding current Plasma	plasmaJET50: 2 - 50 A plasmaJET100: 2-100 A	0,5 A 0,5 A
Basic current I2 (%)	0 - 100 %	infinitely variable
Slope	0 - 10 sec.	infinitely variable
Gas post flow	0 - 45 sec.	infinitely variable
Pulse time I1	0,01 - 2,00 sec.	infinitely variable
Pulse time I2	0,01 - 2,00 sec..	infinitely variable

Item number	Designation
Z.PJ50.000	MIG·O·MAT plasmaJET50
Z.PJ100.000	MIG·O·MAT plasmaJET100
C01.000.003	Workpiece line cpl. 4 m
G10.000.003	Welding regulator for Argon gas for 200 bar bottles
G10.000.002	Welding regulator for Argon/Hydrogene gas for 200 bar bottles
C03.000.002	Gas line 4 m for Argon (black)
C03.000.001	Gas line 4m for Argon/Hydrogene (red)
C00.000.011	Foot pedal remote control
C00.000.012	Spot welding control device PJ-P1 Spot welding time 0.2 to 2.1 sec.
C00.000.012	Spot welding pedal control PJ-P2
A00.010.015	Bottle pick up for 2 gas bottles 200bar/50 Liter
C08.400.090	Coolant MCF15, 5 Liter



Equipped with control interface according to industrial standard for partly mechanized welding:

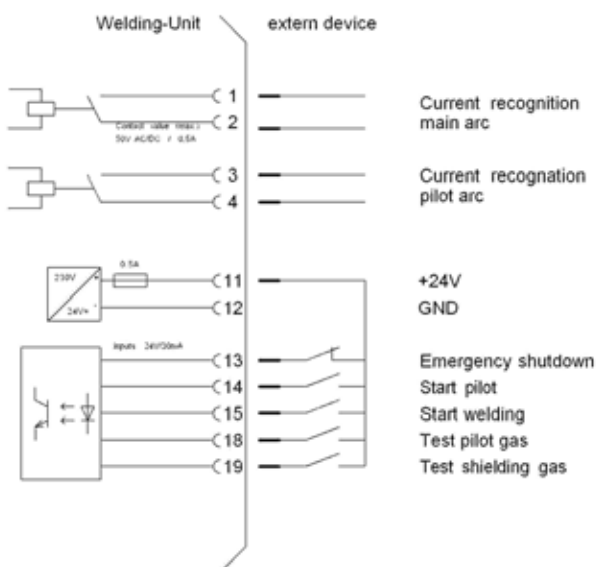

Microplasma and Plasma Welding Torches

Our manufacturing program is completed by a wide range of microplasma and plasma welding torches. The suitability of the torches depends on the special requirements of its welding applications.

For further information, please feel free to contact us.

plasmaJET150 · plasmaJET250



- » Manual welding (hand welding)
- » Plasma spot welding
- » Partly mechanized welding jobs (circumferential seam and longitudinal seam)
- » Welding of metal mesh, thermo-couples, sieves, filter
- » Repair welding of tools
- » Plasma brazing of zinc-plated metal sheets

Solutions for manual and partly mechanized Plasma Welding

MIG·O·MAT plasmaJET150/250

Especially for manual welding in a higher welding current range, particularly for plasma spot welding MIG·O·MAT plasmaJET 150 had been developed with a maximum welding current of 150 A in case of a duty cycle of 50 % as well as MIG·O·MAT plasmaJET 250 with a maximum welding current of 250 A in case of a duty cycle of 60 %.

The control device is almost identical with the control devices of MIG·O·MAT plasmaJET 50 and MIG·O·MAT plasmaJET 100. The MIG·O·MAT plasmaJET 150 and MIG·O·MAT plasmaJET 250 are however not intended for microplasma-arc welding.

	<i>plasmaJET150</i>	<i>plasmaJET250</i>
Mains voltage	1x230V 50/60Hz	3x400V 50/60Hz
Mains fuse	16A time-lag fuse	16A time-lag fuse
Welding current	3 - 150 A	3 - 250 A
Duty cycle	150A / 50% 90A / 100%	250A / 60% 200A / 100%
Pilot current	3 - 15A	3-15A
No-load voltage	85V	85V
Dimensions WxHxD [mm]	455x980x620	455x980x620
Weight	85kg	90kg
Colour	RAL2002	RAL2002

plasmaJET150 · plasmaJET250

Features / Technical Equipment

“Top 10” of MIG·O·MAT plasmaJET

- » Excellent burning behavior of pilot and main welding arc due to inverter technology
- » Integrated high-performance cooling for plasma torch
- » Monitoring of the coolant flow-rate for protection of the plasma welding torch
- » Built-in flowmeter for the precise setting of plasma and shielding gas
- » Modes of operation 2-cycle / 4-cycle / pedal remote control
- » Plasma spot welding combined with a plasma spot welding control device
- » Variable pulsed-mode operation for main current and basic current up to 50 Hz
- » Control interface according to industrial standard
- » Central connection for the plasma welding torch

Clearly arranged user interface for precise and easy adjustment of the welding parameters:

<i>plasmaJET150 / plasmaJET250</i>		
Menu item	Limit value	Resolution
Pilot current	3 - 15 A	3 - 15 A
Welding current Plasma	plasmaJET150: 3-150 A plasmaJET250: 3-250 A	1 A 1 A
Basic current I2 (%)	0 - 100 %	infinitely variable
Slope	0 - 10 sec.	infinitely variable
Gas post flow	0 - 45 sec.	infinitely variable
Pulse time I1	0,01 - 2,00 sec.	infinitely variable
Pulse time I2	0,01 - 2,00 sec.	infinitely variable

Item number	Designation
Z.PJ150.000	MIG·O·MAT plasmaJET150
Z.PJ250.000	MIG·O·MAT plasmaJET250
C01.000.003	Workpiece line cpl. 4 m
G10.000.003	Welding regulator for Argon gas for 200 bar bottles
G10.000.002	Welding regulator for Argon/Hydrogene gas for 200 bar bottles
C03.000.002	Gas line 4 m for Argon (black)
C03.000.001	Gas line 4m for Argon/Hydrogene (red)
C00.000.011	Foot pedal remote control
C00.000.012	Spot welding control device PJ-P1 Spot welding time 0.2 to 2.1 sec.
C00.000.012	Spot welding pedal control PJ-P2
A00.010.015	Bottle pick up for 2 gas bottles 200bar/50 Liter
C08.400.090	Coolant MCF15, 5 Liter



Equipped with control interface according to industrial standard for partly mechanized welding:

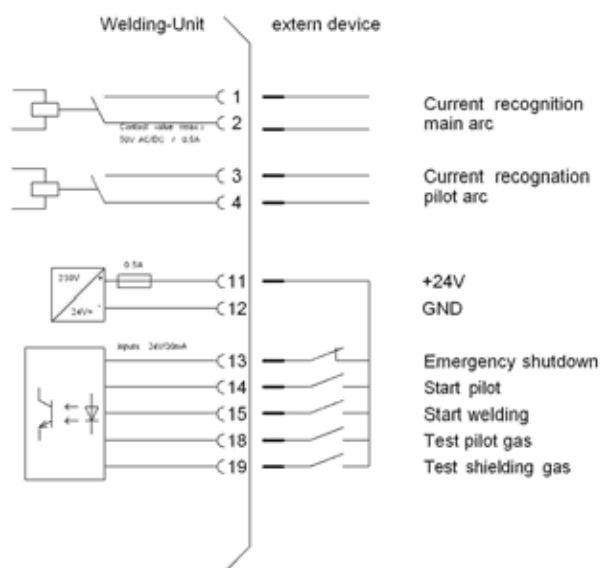

Microplasma and Plasma Welding Torches

Our manufacturing program is completed by a wide range of microplasma and plasma welding torches. The suitability of the torches depends on the special requirements of its welding applications.

For further information, please feel free to contact us.

plasmaBOX



An attractive entry into the range of plasma-arc welding

- » MIG·O·MAT plasmaBOX facilitates in connection with water-cooled TIG-DC-welding appliances an easy and cost-effective design of a welding unit suitable for direct-current plasma arc welding
- » High productivity, low level of warping during welding process and a high weld quality by welding stainless steel.
- » High power density for the welding of copper and copper base alloy
- » The pilot arc guarantees a 100 % ignition certainty (contactless)

Functional characteristics

The plasmaBOX offers the following characteristics:

- » High efficient inverter technology
- » Monitoring of the coolant flow
- » Continuously adjustable pilot current between 3 and 15 A, in accordance with size of electrode
- » Flowmeter for pilot gas, adjustable from 0.15 up to 1.5 litres/min (other ranges on request)
- » Central connection for plasma-arc welding torch
- » Rapid action coupling devices for cooling water connection
- » 7-pole socket to loop through the line for welding torch key

Technical Data	<i>plasmaBOX</i>
Mains voltage	1x230V 50/60Hz
mains fuse	16A träge
max. welding current	250 A
Duty cycle	100%
Pilot current	3 - 15A
No-load voltage	95V
Dimensions WxHxD [mm]	305 x 260 x 400
Weight	12kg
Colour	RAL2002

plasmaBOX

Application of the plasmaBOX

- » The plasmaBOX is connected at the back of the device to the water-cooled TIG-DC-welding unit by a connecting tube set.
- » By a supply of the plasma gas (Ar) through a pressure regulator and the use of a plasma arc-welding torch the plasma welding unit becomes ready for welding.

Provided by the user



Necessary completion for plasma-arc welding

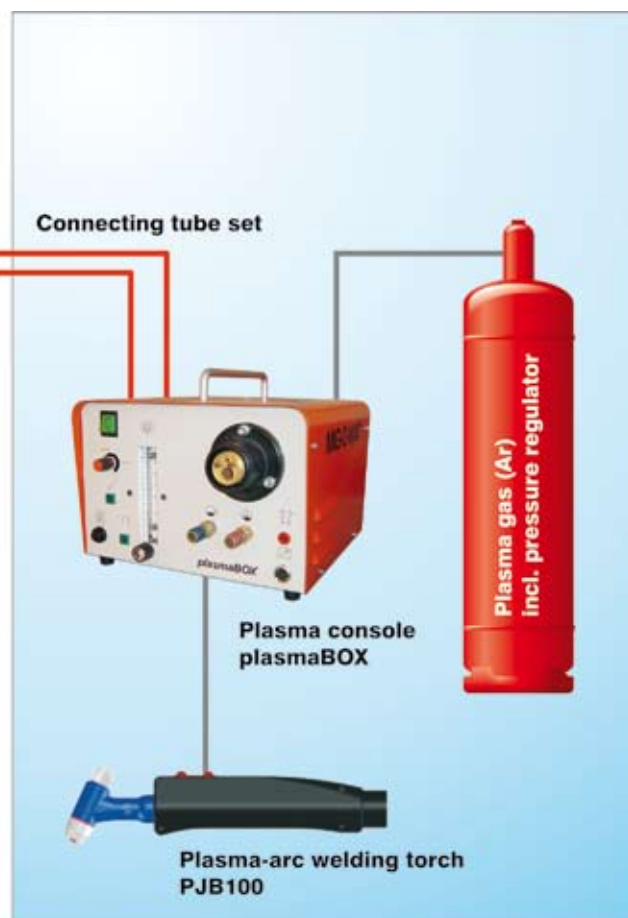

PJB100superior

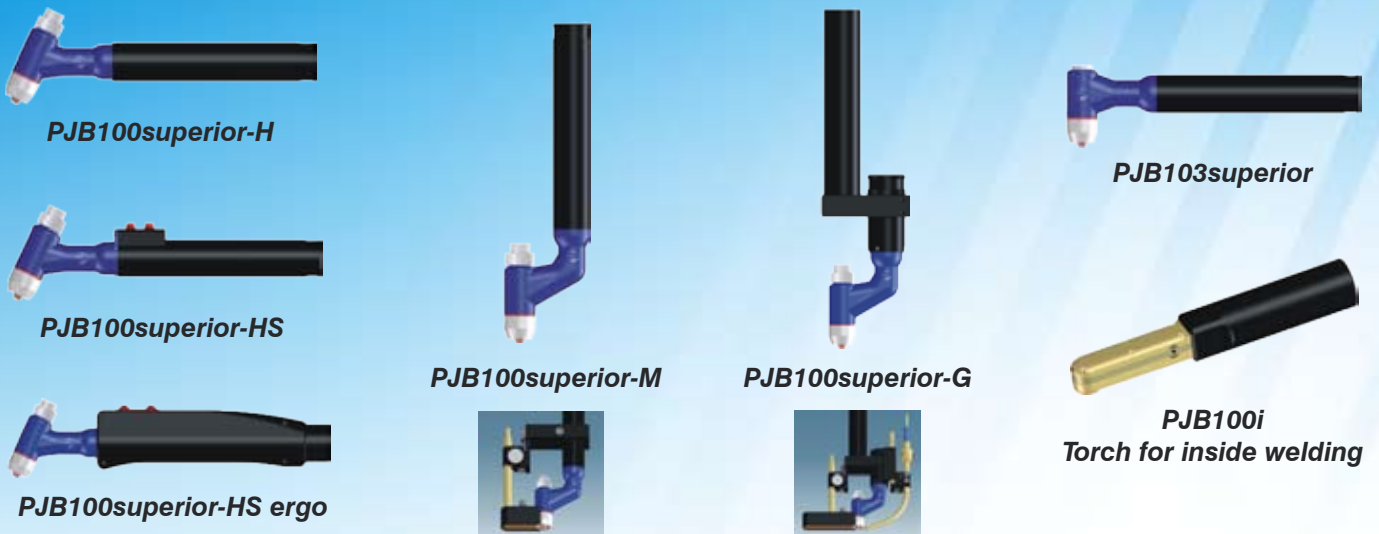

Microplasma- and Plasma welding torch

MIG·O·MAT PJB100superior

By means of systematic miniaturization of the individual components the MIG·O·MAT PJB100superior series provide the best power rate at smallest torch dimensions. Because of the wide-ranging accessories these plasma welding torches are suitable for all standard applications as well as for the most of specialized applications. The torches offer so far a not reached power spectrum, begun from excellently micro plasma characteristics, starting from 0.5 A for welding thinnest foils, up to the plasma-arc welding with 100 A for sheet metals up to 3 mm.

Technical Data	PJB100superior
Electrode cooling	indirect water cooled
Nozzle cooling	indirect water cooled
max. welding current	100 A at 100%
Pilot current	3 - 10A
Elektrode diameter	1,5 mm
Nozzle diameter	0,5 - 3,6 mm
Plasma gas	Argon
Shielding gas	Argon, Argon/Hydrogen, Argon/Helium

Features

- » More than 100 different plasma nozzles
- » Gas nozzles with different lengths and opening crosssections
- » Trail gas nozzles for better gas shielding
- » Cold wire supply for exact guiding of the wire in the arc
- » Transversal Wire Adjustment for easy adjustment of the wire
- » Acoustic electrode setting unit for easy and exact setting of the electrode
- » Angle nozzles for welding in difficulty accessible places
- » Smallest size with at the same time large power density
- » Very stable, highly concentrated arc over the entire current range
- » Simple change and adjustment of the consumables
- » Optimal cooling for long life time of torch and consumables
- » Extensive accessories

The plasma torches are equipped with central connection for MIG·O·MAT power sources plasmaJET and plasmaBOX. Other connections on request.

PJB100superior

Maße

PJB100superiorG

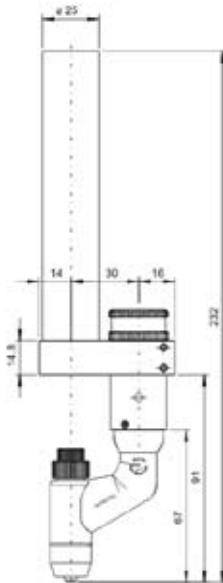

PJB100superiorG
mit Zubehör / with accessories

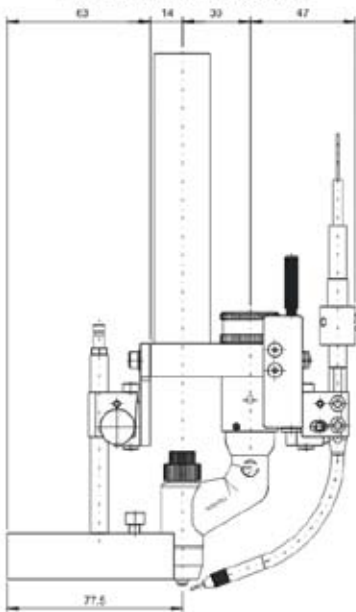

Lange Schleppegasdüse
Long Trail Gas Nozzle

Roboterbrenner und Spezialausführungen ebenfalls lieferbar.
Robotic torches and special models also available.

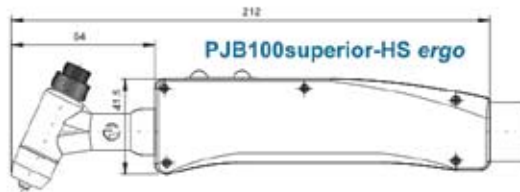
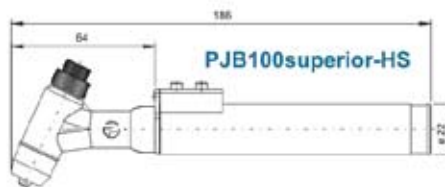
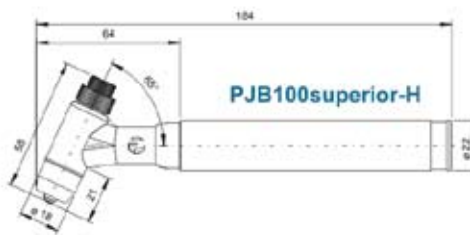
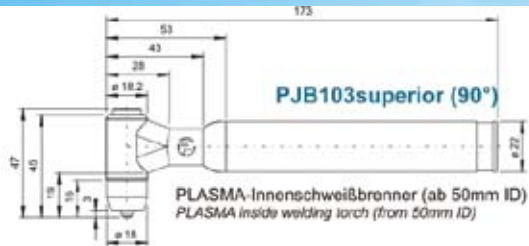

PJB100superiorM

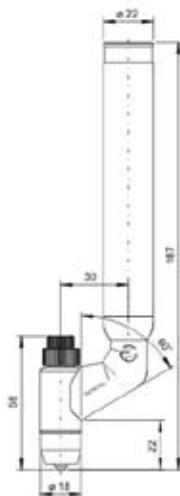

PJB100superiorM
mit Zubehör / with accessories

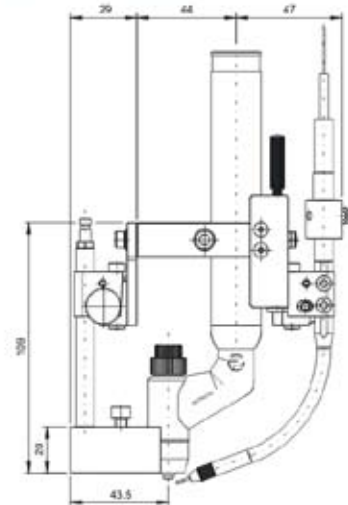
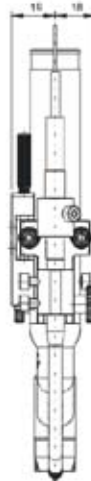

Kurze Schleppegasdüse
Short Trail Gas Nozzle

PJB350



- » Application in automated plasma welding and plasma keyhole welding
- » Apparatus and container construction
- » Welding current of max. 350A at 100% duty cycle
- » Compact structure
- » Minimized wear parts, easiest handling
- » No expensive ceramic inserts
- » Lowest operating costs
- » Extremely long service life of the copper nozzle

Welding torch for automatic plasma- and plasma keyhole welding

MIG-O-MAT PJB350

The MIG-O-MAT plasma welding torch PJB350 was developed thanks to the long years of experience and with the collaboration of users, and it is fundamentally different from other plasma welding torches of this performance class available on the market. The plasma welding torch was systematically optimized with regard to welding characteristics, easy operation, lowest operating costs and compact structure, and a concomitant high power density.



This welding torch is used in automated plasma welding for sheet metal thicknesses of 1 to 3 mm and in plasma keyhole welding for sheet metal thicknesses of 3 to 15 mm. The torch does only consist of a few wear parts and most of all was designed with reference to the vulnerability to failures occurring in comparable torches because of coolant leaks, thus offering a high degree of process reliability.

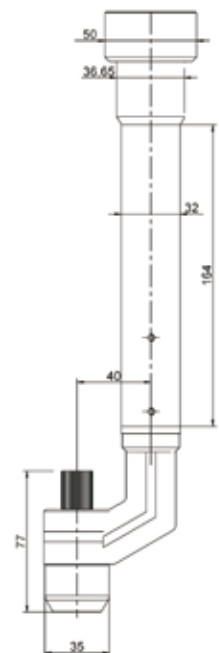

Excerpt from the automation catalog

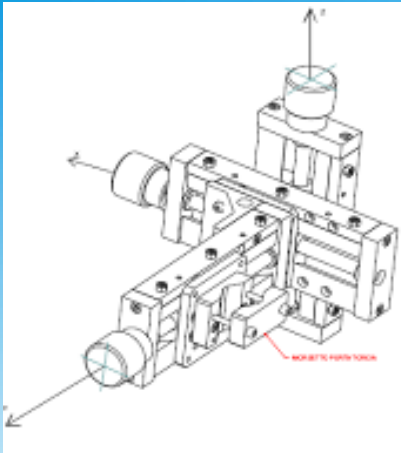

manual slides



Orthogonal axes rotating torch holder

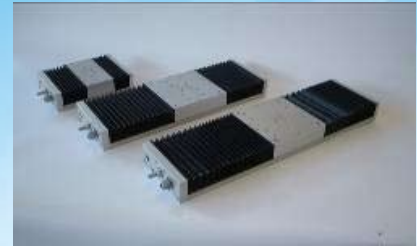

Motorized slides with controlling



Linear oscillators

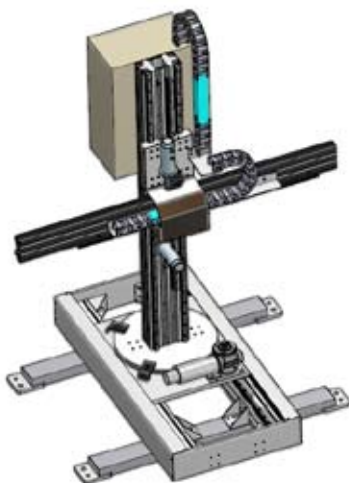

Columns & Booms

and much more, as e.g.

- Cold wire systems
- AVC (Arc voltage control)
- Tactile seam tracker
- Video system



Motorized beams



Roller rotators



Turn tables



Vertical seam welder

Solutions for automation



Automatic welding system for plasma welding of short pipes

- » Fully automatic clamping process
- » Flexibel for pipes with different length and diameters
- » Thickness 2mm
- » Cycle time < 30 sec.
- » Fully penetration start / end

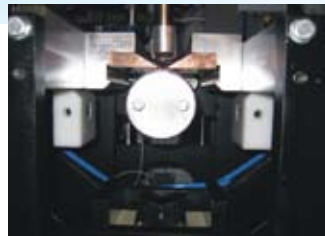

Automatic welding machine for plasma welding in medical sector

Modular plasma circumferential welding system



Circumferential welding system for turbo chargers



Microflame soldering



- » Generating a hydrogen-oxygen gas mixture on the basis of the electrolysis
- » Extremely low operating costs (only current & water)
- » High operating safety
- » Flame temperature up to 2850°C, adapted by various booster fluids to the task.
- » Melting and heat treatment of metals
- » Manual and automated welding, brazing and soldering
- » melting and separation of glasses
- » Flame-polishing of acrylic glas
- » By using different nozzle sizes, the flame can be adjusted to the task.

Micro soldering and welding equipment with proper gas production

MIG•O•MAT Micro-Flame-Welding and welding equipment are units with internal gas generation. By electrolysis of an appropriate electrolyte, from distilled water a hydrogen-oxygen mix (detonating gas) is produced, which is used as fuel gas for a micro-torch. The mixture ratio corresponds precisely to the chemical compound of water H₂O, i.e. two parts of hydrogen and one part of oxygen. During combustion the gas components blend residue-free into volatile aqueous vapour.

The gas generation takes place electrochemically by means of the electrolysis. The distilled water becomes electrically conductive by the electrolyte liquid. The electrolyte is not consumed during the electrolysis and does not require replacement for a long time. For maintaining the function of the equipment, only the correct filling level of the electrolyte has to be

repeatedly balanced by adding distilled water.

The flame temperature and flame output is sufficient for manifold requirements of different fields of application. The fine flame reaches a temperature of up to 2850 °C. By different booster liquids and selecting appropriate nozzles or working pressure, respectively, the flame can be adjusted to the respective welding task.

The applications are melting, welding, soft-solder, hard-solder and heat treatment of metals, glasses and other materials.

For methods using bottled gas there is the problem of precise flame adjustment. Process-determined, the detonating gas flame is always of an absolutely unchanged composition.

The running overheads are quite low, and are unparalleled by any

other procedure. At the same time, such equipment is practically always ready for use. The consumption of distilled water is extremely low. A Lötstar 176 for example with burning flame at maximum gas power during 8 hours would need about 0.8 litres of distilled water.

Such burn time however, is not even reached in case of automates. The consumption is actually much less because gas is only generated when needed.

For manual operation, the light-weight torch of only about 100 g, with micro-nozzles and highly flexible light-weight gas hose, is a real advantage for fatigue-proof, high-precision work.

Microflame soldering

Examples of application

There are extraordinarily manifold micro flame applications, such that only individual examples can be outlined. Besides the conventional soldering use in goldsmith's and flame-polishing in processing of acrylic glass, there are countless industrial applications, such as soldered and welded joints in electric motor construction, joints of electronic components and contacts, as well as separating and melting of glasses in glass processing.



Soldering works in goldsmith's, opticians and dental laboratories

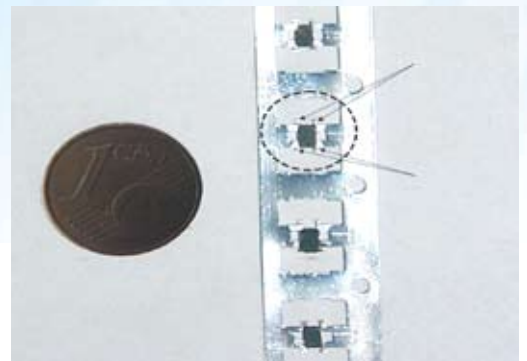

Soft-soldered connections at transformers using a wire diameter of 0.06 mm



Flame-polishing of acrylic glass

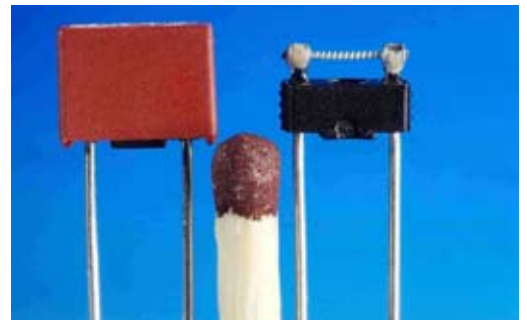

Manufacturing of micro fuses



Transformer and electric motor construction

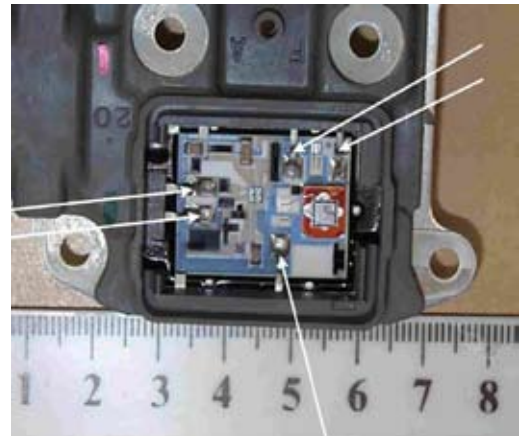

Soft-soldering at starter connectors in the automotive industry

Microflame soldering

Range of equipment for industrial use



- » The equipment meets DIN 32508 for highest safety
- » Simplest operation by microcontroller control system with automatic leak test
- » Designed for industrial application
- » By automated pressure regulation with permanent target-performance comparison consistent flame geometry, also in case of multi-user application.

Type of unit	Lötstar 145	Lötstar 176	Lötstar 245	Lötstar 600
Mains voltage	1x230V 50/60Hz	1x230V 50/60Hz	1x230V 50/60Hz	3x400V 50/60Hz
mains fuse	10A	16A	16A	16A
Max. gas production	120 Ltr/h	160 Ltr/h	200 Ltr/h	600 Ltr/h
Max. size of nozzle	1,1 (G19)	1,2 (G18)	1,5 (G17)	2,4 (>G14)
Workstations	1-2	1-3	1-6	1-20
Dimensions WxDxH [mm]	395x275x445	490x375x515	490x375x515	600x820x925
Weight [kg]	25	48	48	120



Fan nozzle

Options

Carriage with 4 steering rollers

External stainless steel booster with 20-fold volume
for vaporiser fluid to reduce the maintenance effort

External work station booster

for the application of flux solutions and several independently working work stations

Automatic separate refilling unit

for the distilled water, consisting of auxiliary control, dosing pump, filling level sensor for the reactor, and a 5 litres storage container

Work station extension, consisting of:

1 micro torch with regulating valve, cranked version, gas hose 3 m, 1 soldering stand, 1 T-piece and 1 set of nozzles with 10mm nozzles of the size 0.8 / 0.9 / 1.0 / 1.2 and 1.5mm

Fan nozzle 6-fold / 4-fold

Different torches for automation

Remote control RC1 for Lötstar units with connecting cable 5m



Automatic refilling unit



Stainless steel booster with micro torch and industrial torch